

Digitized by the Internet Archive
in 2008 with funding from
Microsoft Corporation







H. BOURNE SCULPT.

THE TEA PARTY

THE TEA PARTY

NEW SERIES.
VOLUME X.

THE
ART-JOURNAL.

HALLIDIE LIBRARY
OF THE
UNIVERSITY

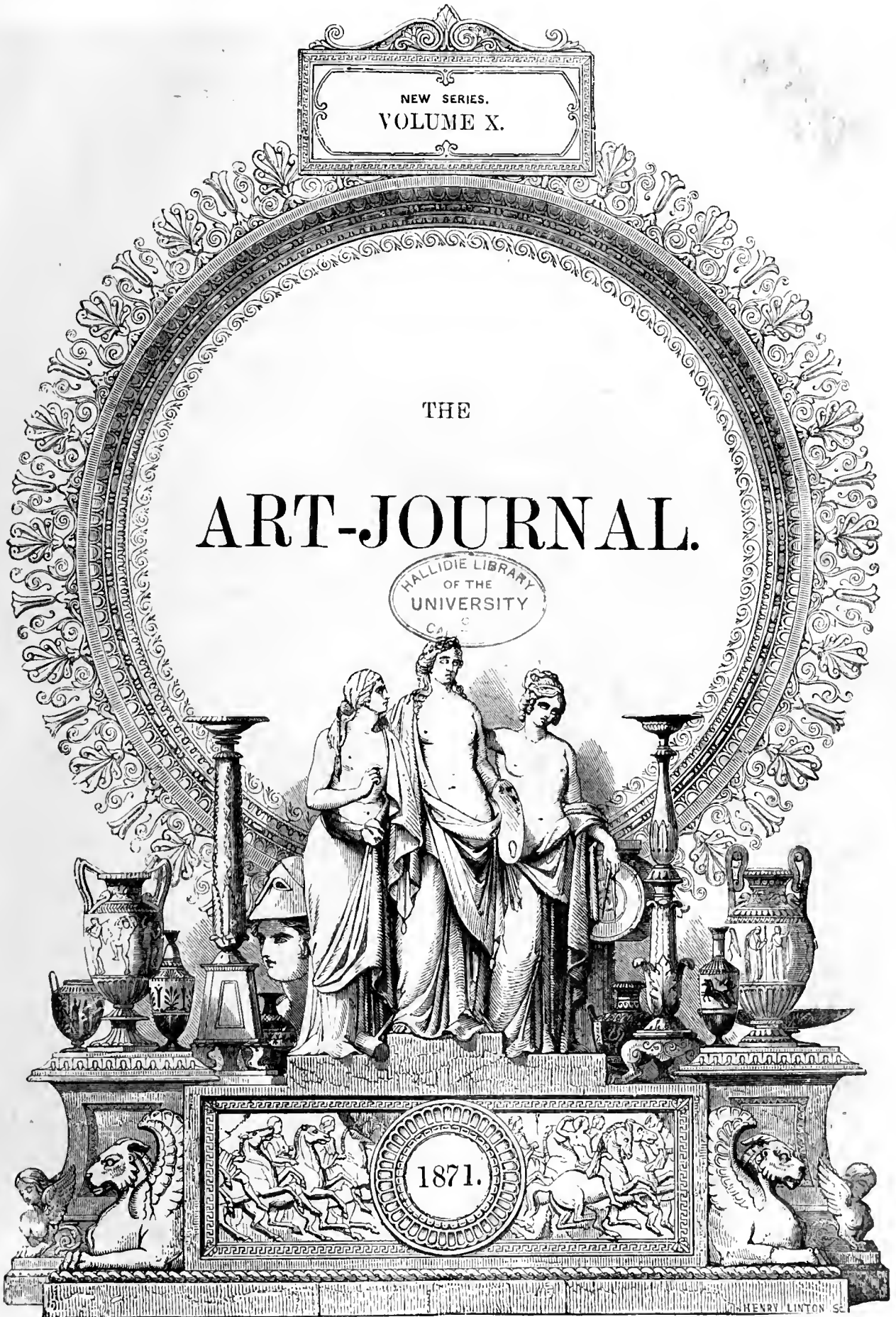

LONDON: VIRTUE & CO.

NI

A7A

v.33

LONDON:
PRINTED BY VIRTUE AND CO.,
CITY ROAD.

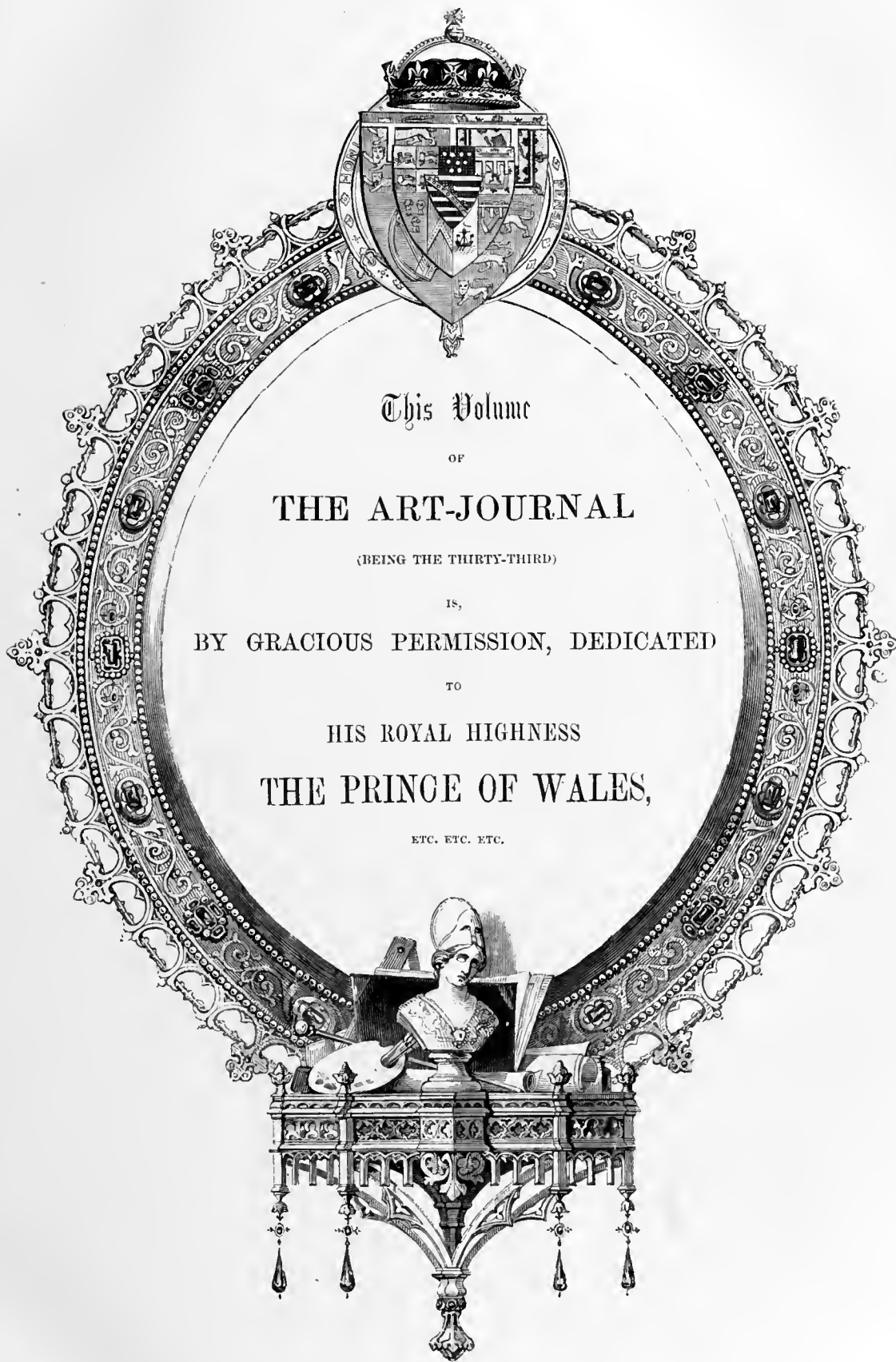

This Volume

OF

THE ART-JOURNAL

(BEING THE THIRTY-THIRD)

IS,

BY GRACIOUS PERMISSION, DEDICATED

TO

HIS ROYAL HIGHNESS

THE PRINCE OF WALES,

ETC. ETC. ETC.



LIST OF ILLUSTRATIONS.

ENGRAVINGS FROM SELECTED PICTURES.

	PAINTERS.	ENGRAVERS.	PAGE
1. THE DUEL INTERRUPTED	M. STONE	<i>H. Bourne</i>	4
2. A VISIT TO THE ARMOURER	G. B. O'NEILL	<i>P. Lightfoot</i>	20
3. OUR PETS	P. J. CASTAN	<i>T. Brown</i>	36
4. BORROWDALE	S. BOUGH, R.S.A.	<i>W. Richardson</i>	56
5. THE DAUGHTER OF ZION	J. F. PORTAELS	<i>W. Greatbach</i>	72
6. THE SPRING OF LIFE	H. CAMPOTOSTO	<i>J. C. Armytage</i>	80
7. DAVID BROUGHT BEFORE SAUL	LOUISA STARR	<i>S. S. Smith</i>	100
8. MEN OF WAR AT SHEERNESS	H. T. DAWSON	<i>A. Willmore</i>	112
9. LE MALADE IMAGINAIRE	A. SOLOMON	<i>H. Bourne</i>	136
10. "A BABY WAS SLEEPING"	F. W. TOPHAM	<i>C. W. Sharpe</i>	140
11. TALBOT AND THE COUNTESS AUVERGNE	W. Q. ORCHARDSON, A.R.A.	<i>C. W. Sharpe</i>	154
12. THE CHILDREN'S OFFERING	GABE	<i>S. S. Smith</i>	164
13. KEPT IN	E. NICOL, A.R.A.	<i>J. Stephenson</i>	180
14. THE WHITE COCKADE	R. A. HILLINGFORD	<i>G. Greatbach</i>	184
15. THE HIGHLAND KEEPER'S DAUGHTER	B. ANSDALL, R.A.	<i>C. Cousen</i>	196
16. THE MARKET BOAT	C. STANFIELD, R.A.	<i>J. C. Armytage</i>	200
17. DANTE	J. L. GEROME	<i>C. H. Feens</i>	216
18. THE REPROOF	J. COOMANS	<i>J. Demannez</i>	220
19. THE HINDOO MAIDEN	H. LE JEUNE, A.R.A.	<i>D. Devachez</i>	236
20. SLEEPING BLOODHOUND	SIR E. LANDSEER, R.A.	<i>C. G. Lewis</i>	244
21. THE FORTUNE-TELLER	J. PHILLIP, R.A.	<i>Professor Knolle</i>	260
22. A BY-PATH TO CHAMOUNI	J. W. INCHBOLD	<i>T. A. Prior</i>	264
23. THE CORONATION OF THE VIRGIN	G. DA UDINE	<i>K. Mayr</i>	272
24. GOING TO THE HAY-FIELD	H. CAMERON, R.S.A.	<i>G. Burton</i>	280
25. THE HAMOAZE, DEVONPORT	H. DAWSON	<i>E. Brandard</i>	288

ENGRAVINGS FROM SCULPTURE.

	SCULPTORS.	ENGRAVERS.	PAGE
1. AMERICA	J. BELL	<i>W. Roffe</i>	28
2. HERO	J. DURHAM, A.R.A.	<i>R. A. Artlett</i>	44
3. AGRICULTURE	W. C. MARSHALL, R.A.	<i>H. C. Balding</i>	88
4. ENGINEERING	J. LAWLOR	<i>G. Stodart</i>	144
5. ASIA	J. A. FOLEY, R.A.	<i>R. A. Artlett</i>	168
6. EUROPE	P. MAC DOWELL, R.A.	<i>W. Roffe</i>	188
7. COMMERCE	T. THORNYCROFT	<i>E. Stodart</i>	208
8. MANUFACTURES	H. WEEKES, R.A.	<i>H. C. Balding</i>	228
9. THE ANGEL OF THE SEPULCHRE	E. D. PALMER	<i>R. A. Artlett</i>	248
10. THE GUARDIAN ANGEL	J. S. WESTMACOTT	<i>W. Roffe</i>	292

CONTENTS.

- "A Baby was Sleeping," 140.
 Agriculture, 88.
 Albert Hall, 24, 61, 93, 126, 138, 147.
 Albert Memorials, 60, 167, 293.
 Album, Miss Wilkie's Rustic, 94.
 Alexandra Park, 24, 62, 120, 125.
 America, 28.
 Angelo and Raffaele, Drawings by, 216.
 Angel of the Sepulchre, 248.
 Angel, The Guardian, 292.
 Arab Art, 94.
 Architectural Exhibition, 62.
 Architects' Institute, 126, 205.
 Architecture, Indian, 65, 292.
 Armourer, Visit to the, 20.
 Art and Manufacture, 8.
 Art, Golden Age of, 277.
 Art in Continental States :—
 Antwerp, 247.
 Berlin, 52, 207.
 Calcutta, 267.
 Chicago, 123.
 Chili, 167.
 Dresden, 207, 267.
 Fano, 167.
 Florence, 52, 133, 167.
 Greece, 88.
 Madras, 88, 167.
 Madrid, 88, 167, 286.
 Mantua, 88.
 Meissen, 207.
 Milan, 88, 247.
 Montreal, 8, 52, 144, 207.
 Moscow, 247.
 New York, 207.
 Nuremberg, 88.
 Paris, 62, 88, 186, 228, 247, 266, 286.
 Pern, 207.
 Pesth, 88.
 Philadelphia, 88.
 Rome, 52, 162, 244.
 St. Petersburg, 33.
 Sydney, 95.
 Tuscarora, 144.
 Vienna, 88, 95, 123, 265.
 Washington, 123.
 Art in England in 1870, Review of, 21.
 Art in Parliament, 247.
 Art in the Provinces :—
 Bath, 246.
 Birmingham, 70, 120, 167, 206, 246.
 Blackburn, 206.
 Bradford, 44.
 Brighton, 206.
 Bristol, 8.
 Burslem, 91, 94.
 Cambridge, 8.
 Chaldon, 70.
 Dublin, 44, 141, 167, 246, 269, 286.
 Edinburgh, 44, 120, 141, 167, 223, 246, 293.
 Exeter, 206.
 Falmouth, 246.
 Glasgow, 44, 89, 206.
 Grindley-on-the-Hill, 141.
 Leicester, 293.
 Lichfield, 167.
 Liverpool, 8, 70, 167, 246.
 Manchester, 246.
 Morpeth, 269.
 Newcastle-on-Tyne, 120.
 Norwich, 167, 223, 247.
 Oxford, 216.
 Plymouth, 206.
 Preston, 247.
 Salford, 120.
 Art in the Provinces :—
 Salisbury, 8, 269.
 Windsor, 247, 293.
 Artisans of France, 274.
 Artist, Assault on an, 247.
 Artist, Home of a Mad, 233.
 Artistic Race, Gennine, 77, 100, 136, 161, 185.
 Artists' and Amateurs' Society, 62, 170.
 Artists' General Benevolent Institution, 122.
 Artists in Florence, 133.
 Artists in Paris, 62.
 Artists' Orphan Fund, 171.
 Art-Literature, Foreign, 265.
 Art, Preservation of works of, 248.
 Art-Unions :—
 Ceramic, 126, 229.
 London, 126, 164, 208, 228.
 Shilling, 28.
 Art-Workmanship Competition, 104.
 Asia, 169.
 BESLEY, Portrait of Alderman, 30, 170.
 Bible for the Princess Louise, 230.
 Bijouterie and Enamel, 30.
 Birmingham Art Museum, 120.
 Birmingham, Picture Gallery for, 167.
 Birmingham Society of Artists, 70, 120, 141, 206, 246.
 Blanchard, Engravings by M., 147.
 Bloodhound, A Sleeping, 244.
 Borrowdale, 56.
 British Archaeological Association, 170.
 British Artists :—
 Archer, J., 97.
 Faed, J., 237.
 Faed, T., 1, 62.
 Foster, B., 157.
 Hillingford, R. A., 213, 275.
 Leader, B. W., 45.
 Ross, R. T., 281.
 British Artists' Society, 26, 141.
 British Museum, 62, 251.
 Burlington Fine Arts' Club, 164, 170, 180.
 Busts :—
 Carlisle, Earl of, 269.
 Cheselden, 147.
 Derby, Earl of, 62.
 Fulford, Bishop, 207.
 Gilbert, J. J., 44.
 Grote, G., 251.
 Mac Dowell, P., 29.
 Mead, Dr., 147.
 Murchison, Sir R., 127.
 Scott, Sir Walter, 211.
 Shakspeare, 44.
 Smart, Capt., 44.
 Tite, Sir W., 246.
 CALLOT'S "Les Misères et les Malheurs de la Guerre," 249.
 Carrier-Belleuse, Works of, 229.
 Catalogue of the Oxford Galleries, 4.
 Chamouni, By-Path to, 264.
 Chevalier's New Zealand Scenery, 171, 211, 229.
 Chevalier's Sketches in the Far East, 207.
 Children's Offering, 164.
 China, Sale of Bristol, 172.
 Christi Triumphus, 210.
 Christmas Cards, 295.
 Churches of Europe, Celebrated :—
 St. Denis Abbey, 15.
 St. Etienne, Vienna, 14.
 St. Mark's, Venice, 270.
 Seville Cathedral, 271.
 Church-Plate, 172.
 Civil List Pensions, 231.
 Clay for Porcelain, &c., 92.
 Commerce, 208.
 Coronation of the Virgin, 272.
 Correspondence :—
 Circles in Perspective, 205.
 Dulwich Gallery, 17.
 Reflections in Water, 183, 184.
 Teaching Drawing, 205.
 Cruikshank, George, 251.
 Crystal Palace :—
 Alhambra Court, 139.
 Amusements, 251.
 Aquarium, 143, 251, 295.
 Chevalier's Pictures, 171.
 Drawings by Walsh, 126.
 Harvest Trophy, 275.
 Picture-Gallery, 139, 210, 295.
 Premiums for Pictures, 92, 190.
 Report, 62.
 DANTE, 216.
 Daughter of Zion, 72.
 David brought before Saul, 100.
 De la Rue's Annals, 63.
 Diamonds in South Africa, 117.
 Dickens's Writing-Folio, 251.
 Doré, Works of P. Gustave, 118.
 D'Orsay, Assumed Sculptures by Count, 171.
 Drapers' Hall, 147.
 Drinking-Fountain in Regent's Park, 211.
 Duel Interrupted, 4.
 Dulwich Gallery, 17.
 Durer, Exhibition of Drawings, &c., by A., 88.
 Durer, Fourth Centenary of A., 207.
 EASTER EGGS, 147.
 Edinburgh, Portrait of the Duke of, 294.
 Enamel and Bijouterie, 30.
 Enamel in England, 127.
 Enamelling, 30.
 Engineering, 144.
 Engravings by T. O. Barlow, 275.
 Engravings from Art-Manufactures, 211.
 Epiphany Offering at St. James's, 42.
 Esterhazy Gallery, 88.
 Etching by S. Haden, 191.
 Europe, 188.
 Exhibition or Bazaar, 245.
 Exhibitions :—
 Agnew's Gallery, 93.
 Baker Street Bazaar, Foreign Pictures, 94.
 Bond Street Gallery, 199.
 Cox's Gallery, 227.
 Dudley Gallery, 85, 285.
 Everard's Gallery, 251, 289.
 Female Artists, 62, 90, 147.
 French Peasantry, In Aid of, 29, 50, 61.
 French Pictures at German Gallery, 30, 43.
 French Pictures in New Bond Street, 187.
 Jerichan's Pictures, Madame, 165.
 Loan, at Institute of Water-Colour Painters, 29, 273.
 McLean's Gallery, 146, 291.
 New British Institution, 20, 119, 292.
 Old Masters at Berners Street, 190.
 Portraits, Braham's Collection of, 138.
 Pritchett's Drawings, 143.
 St. James's Gallery, 123.
 Wallis's Gallery, 145, 291.
 Warren's Summer-Sketches, 60.
 FARRER, T. O., Sketches by, 127.
 Fern-Decorations, 274.
 Foley, J. H., 61, 127, 231.

- Fortune-Teller, The, 260.
 Freemasons' Hall, 127, 190.
 Frescoes by J. R. Herbert, R.A., 29.
 Frescoes in Exeter Cathedral, 206.
 Frith, W. P., 247.
- GAINSBOROUGH'S 'Blue Boy,' 240.
 Gambart, Retirement of Mr., 127.
 Garibaldi, Portrait of, 295.
 Gate of the Sanchi Tope, 65.
 Gelatine, 27.
 Geography, Advantage of Physical, 197.
 Glasgow Institute of the Fine Arts, 89.
 Glass and Pottery, Substitutes for, 103.
 Glass of Murano, 295.
 Goldschmidt, Otto, 147.
 Governors' Benevolent Asylum, 94.
 Graphic Society, 294.
 Greenwich Hospital, 251.
- HAMOAZE, Devonport, 288.
 Hayfield, Going to the, 280.
 Hero, 44.
 Highland Keeper's Daughter, 196.
 Hindoo Maiden, 236.
 Hogarth's Works, 274.
 Holbein Exhibition, 207, 210, 267.
 Home of a Mad Artist, 233.
 Homes of England, Stately:—
 Cassiobury, 253.
 Haddon Hall, 9, 37, 73, 105, 134.
 Hatfield House, 193.
- INCURABLES, Royal Hospital for, 29.
 Industrial Exhibition at Norwich, 223.
 Industrial Exhibition in Dublin, 286.
 International Exhibition of 1871:—
 Anatomy of Oxen, 209.
 Catalogue, *Art-Journal*, 93, 125.
 Catalogue, Official, 93.
 Exhibition or Bazaar? 245.
 French Report, 294.
 Indian Court, 208.
 Jury for Selection of Engravings, 126.
 Jury for Selection of Paintings, 62.
 Opening, 146, 170.
 Pictures, Bavarian, 187.
 Pictures, Belgian, 168, 187.
 Pictures, British, 201.
 Pictures, French, 217.
 Pictures, Various Nations, 241.
 Preparations, 24, 60, 90.
 Prospects, 125.
 Purchases by Princess Louise, 211.
 Queen's Visit, 170.
 Reports, 229, 231.
 Sales, 294.
 Sculptures, 267.
 International Exhibition of 1872, 243.
 International Exhibitions:—
 Madrid, 167.
 Milan, 247.
 Moscow, 247.
 Peru, 207.
 Sydney, 95.
 Vienna, 95, 265.
 International Exhibitions, Past and Future, 272.
 Ironwork by Handyside & Co., 170.
- JAPANESE Art, 77, 100, 136, 161, 185.
 Jerusalem, Model of, 206.
 Jewels, Castellani Collection of, 225.
- KAPHOGRAPHIC Landscapes, 249.
 Kensington Museum:—
 Della Robia Ware, 17, 51.
 Extension, 87.
 Gate of the Sanchi Tope, 65.
 Library, 87.
 New Courts, 231.
 Pottery, Spanish, 51.
 Report, 250.
 Runic Door, 51.
 Schools of Art Prizes, 205, 251.
 Science and Art Department, 17, 251.
 Stone-Carvings, 51.
 Tankards of Ivory, 87.
 Kept In, 180.
- LAMB, Grave of Charles, 191.
 Landseer, George, 147.
 Loom-Pictures, 295.
 Lotteries, Illegal, 80.
 Louvre. How it was Saved, 186.
- MALADE Imaginaire, 136.
 Manufactures, 228.
 Map of France and Germany, 62.
 Map of the New French Frontier, 127.
 Market-Boats, 200.
 Mayo's *Spolia Opima*, Lord, 92.
 Mazzini, Portrait of, 295.
 Medal of Repulse of the Spanish Fleet, 275.
 Medal of the Sultan's Visit to London, 94.
 Men-of-War at Sheerness, 112.
 Merchants of the Middle Ages, 53, 129, 221.
 Millais, Mr. J. E., 294.
 Monuments:—
 Cattermole, G., 94.
 Mc. Callum, H., 44.
 O'Connell, D., 246.
 Morland, Assumed Pictures by G., 94, 144.
 Mosaic Manufactory at St. Petersburg, 33.
 Mosaic Work by Convicts, 94.
 Mosaic Work by Salviati, 127.
 Mulready's Drawings, 95.
 Mural Decorations by H. Marks, 189.
 Museum for East London, 29.
 Museum of Geology Catalogue, 231.
 Museums of England:—
 Bath, 181.
 Cirencester, 261.
 Colchester, 113.
 Exeter, 203.
 Scarborough, 81.
 Shrewsbury, 22.
 Stratford-on-Avon, 57.
- NATION of Shopkeepers, 207.
 National Gallery:—
 Annual Report, 122.
 Closing, 294.
 Enlargement, 210.
 New Pictures, 29.
 Peel Collection, 121, 170.
 Raffaele, Picture by, 294.
 Wallace's Gift, Sir R., 294.
 National Portrait Gallery, 125, 210.
- OBITUARY:—
 Agnew, T., 183.
 Ainmuller, 80.
 Aligny, F. C. T., 165.
 Bennett, W., 139.
 Bott, T., 42.
 De Chavannes, 139.
 Eckersberg, J. F., 101.
 Giraud, V., 103.
 Goodall, F. T., 166.
 Hardwick, P., 41.
 Hayter, Sir G., 79.
 Herford, Miss, 80.
 Hess, P. Von, 209.
 Holl, W., 102.
 Isaac, J. R., 243.
 Johnston, A. K., 209.
 Judkin, Rev. T. J., 251.
 Kendrick, E. E., 183.
 Lanno, F. G. A., 293.
 Lockett, J., 139.
 MacDowell, P., 29, 41.
 Mignot, L. H., 6.
 Minardi, T., 183.
 Moon, Sir, F. G., 274.
 Mozier, J., 6.
 Munro, A., 79.
 Nicol, G., 139.
 Pearson, Mrs., 166.
 Pennethorne, Sir, J., 243.
 Petzl, J., 209.
 Piquer, 286.
 Porcelli, A., 265.
 Regnault, A. G. H., 79.
 Robinson, J. H., 293.
 Robson, T., 293.
 Schendel, P. Van, 41.
 Vogt, A., 139.
 Weber, O., 80.
 Zamacois, E., 88.
- Ornament for Building, Sgraffito, 230.
 Ornament, Incongruous, 230.
 Ornament, Use of Plants and Flowers for, 258.
 Ornaments, Savage, 218.
 Our Pets, 36, 125.
- PAPER from Bamboo, 248.
 Peg Tankards, 71.
 Pennethorne, Sir, J., 29, 243.
 Photo-Crayons, Sarony's, 61.
- Photographs, 51, 147.
 Photographs, Austrian, 123.
 Picture-Frames, 94, 126.
 Picture Sales:—
 Agnew's Collection, 167.
 Bashall's Gallery, 170.
 Brooks's Collection, 166.
 Everard's Collection, 62.
 Gambart's Collection, 140.
 Heritage's Collection, 140.
 Miscellaneous, 112, 140, 189, 190.
 Pyne's Pictures, 112.
 Radley's Collection, 189.
 Wallis's Collection, 140.
 Wheeler's Collection, 226.
 Wilcock's Collection, 189.
- Pictures:—
 Adoration of the Magi, Bramantino's, 170.
 Arctic Scenery, Bradford's, 189.
 Daniel giving Judgment, Herbert's, 29.
 David, Domenichino's, 167.
 Faith and Reason, Sir J. N. Paton's, 141.
 Freemasons' Hall, Rosenthal's, 190.
 La Vierge au Berceau, Raffaele's, 229.
 Madonna del Libro, Raffaele's, 165.
 Marriage of the Princess Louise, O'Connor and Barnes's, 126.
 Morland's in White Cross Street, 144.
 New Zealand Scenery, Chevalier's, 171.
 Presentation of the Freedom of the City to the Prince of Wales, Melville's, 275.
 Romeo and Juliet, &c., Brown's, 210.
 Statute Fair, J. Faed's, 147, 168.
 Vintage in Ancient Rome, Alma Tadema's, 147, 166.
- Pictures brought from Peru, 171.
 Pictures burnt at Holker Hall, 126, 144.
 Pin-Quivers, 94.
 Plants and Flowers for Ornament, Use of, 258.
 Playing-Cards, 275.
 Polytechnic, The, 30.
 Porcelain-Paintings by T. Bott, 127.
 Pottery and Glass, Substitutes for, 103.
 Pottery and Porcelain, Sales of, 172, 191.
 Pottery, Belleek, 63.
 Pottery, British, 275.
 Pottery Works at Burslem, 95.
 Pritchett's "Ink-Pots," 191.
 Proportion, Greek Canon of, 63, 147.
 Pyx, Trial of the, 224.
- REPROOF, The, 220.
 Reviews:—
 Æsthetik als Philosophie, &c., 211.
 Alda Graham and her Brother Philip, 296.
 Alps, Scrambles amongst the, 252.
 Animal World, 96.
 Animals, Odd Stories about, 32.
 Archaeologist, Rambles of an, 212.
 Architecture, Ancient Irish, 96.
 Architecture, Bary's Lectures on, 192.
 Art and Artists, Memoranda of, 252.
 Art and Religion, 275.
 Art-Education, 95.
 Art, Gems of French, 31.
 Art-Paradise, Britain's, 231.
 Art Past and Present, 232.
 Art, Wonders of European, 31.
 Aunt Jenny's American Pets, 296.
 Aunt Louisa's Home-Companion, 32.
 Autobiography of an Architect, 128.
 Back of the North Wind, 96.
 Bewick, Life and Letters of W., 252.
 Boner, Memoirs of Charles, 276.
 British Heroes and Worthies, 276.
 Buds and Flowers, 64.
 Butterflies, History of British, 172.
 Cat's Pilgrimage, 63.
 Chaucer, Riches of, 31.
 Chaucer, Tales from, 31.
 Child's Influence, 296.
 Christian's Armoury, 128.
 Christmas and the New Year in many Lands, 64.
 Church Designs for Congregations, 64.
 Collects of the Church of England, 31.
 Colour, Manual of the Science of, 148.
 Cris Fairlie's Boyhood, 32.
 Drawing and Measuring Instruments, 276.
 Drawing-Book, Vere Foster's, 128.
 Eastern Seas, In the, 64.
 Engraving, Wonders of, 63.
 Faïences Italiennes, 192.
 Feathered Companions, 32.

Reviews:—

Fors Clavigera, 212.
 Gems, Notices of, 192.
 Geschichte der Plastik, 231.
 Going to Work, 276.
 Greek Illustrated Magazine, 171.
 Guide de l'Amateur d'Objets d'Art, 252.
 Handbuck für Kupferstichsammler, 172.
 In Danger—Abandoned, 296.
 Insects, Transformation of, 86.
 Internationale Exhibition Reports, 232.
 Iona, 95.
 Ireland, Fireside Stories of, 32.
 Italy, Sketches and Stories of Life in, 296.
 Japanese Literature and Art, 160.
 Journey to the Centre of the Earth, 296.
 Ceramic Gallery, 212.
 Kunstwerke und Gerathe, 123.
 Land of the Sun, 32.
 Light and Darkness, 63.
 Light of the World, 62.
 Lighthouses and Lightships, 32.
 Literature and Art, Historical View of, 192.
 Maclise, Memoir of D., 172.
 Mad War-Planet, 148.
 Moor Park, 276.
 Mount Edgecumbe, Guide to, 212.
 My School-days in Paris, 232.
 Nature-Pictures, 287.
 Noble Love, 232.
 Northern Lands, Stories from, 64.
 Norway, Court of, 31.
 Oak Staircase, 296.
 Ocean, The Broad, Broad, 32.
 Old Merry's Annual for 1871, 32; 1872, 296.
 Old Merry's Travels on the Continent, 172.
 On the Eve, 96.
 Painters, Handbook for Young, 148.
 Painting in Northern Italy, 199.
 Partridge, Publications of Messrs., 48.
 Pearl Photographic Album, 172.
 Peerage and Baronetage, Debrett's, 96.
 Pictures and Pleadings, 252.
 Pictures from English Literature, 16.
 Pot of Basil, 148.
 Pottery and Porcelain of Derbyshire, 128.
 Punctestown in 1868, 31.
 Raphael and his Father, 295.
 Records of 1870, 96.
 Revue Decorative, 148.
 Rock Light, The, 32.
 Royal Scottish Academy, Early History of, 85.
 Sacristy, The, 128.
 Saracens, Tales of the, 96.
 Schools for the People, 148.
 Sea, Adrift on the, 32.
 Sea and its Wonders, 32.
 Simon's Bay, Table Mountain, &c., 212.
 Sketching from Nature, 211.
 Spanish Pictures, 31.
 Spanish Towns and Spanish Pictures, 63.
 Stone Monuments, Tumuli, &c., 95.
 Strange Dwellings, 96.
 Subtropical Garden, 212.
 Sunday Echoes in Week-day Hours, 96.
 Swiss Pictures, 276.
 Travels on the Continent, Old Merry's, 172.
 University Galleries, Catalogue of, 4.
 Valentine's Day, and Valentines, 96.
 Village-Maiden, 276.
 Walter's Escape, 32.
 Whispers from Fairy-Land, 32.
 Whittington, Story of Sir R., 64.
 Work among the Lost, 31.

Reviews:—

Wyatt's Lectures, 69.
 Young Governors, 296.
 Zigzagging amongst Dolomites, 32.
 River Valleys, 197.
 Rome, Visits to the Studios of, 162.
 Royal Academy:—
 Athlete, Cast of the, 146.
 Banquet, 170.
 Chemistry, Professor of, 229.
 Conversazione, 210.
 Council, &c., Changes in, 29.
 Curator, 29.
 Election of Members, 61, 93, 127, 210.
 Exhibition, 149, 173.
 Hangers, 125.
 Lectures, 29, 93, 192.
 Loan Exhibition, 29, 49.
 Mac Dowell, Bust of, 29.
 Old Masters, Exhibition of, 294.
 Prizes, Distribution of, 29.
 Westmacott, Resignation of R., 61.
 Royal Hibernian Academy, 141, 167.
 Royal Scottish Academy, 36, 84, 85, 94, 109, 293.
 St. PAUL's, Decorations of 226, 251.
 St. Thomas's Hospital, 147.
 Sant, J., 94.
 Schools of Art:—
 Belfast, 269.
 Birkenhead, 269.
 Birmingham, 116.
 Bristol, 17.
 Burslem, 293.
 Calcutta, 288.
 Cambridge, 116.
 Carlisle, 17.
 Cheltenham, 142.
 Chippenham, 17.
 Cirencester, 52.
 Cork, 142.
 Darlington, 116.
 Farnham, 167.
 Female, 17, 138.
 Gloucester, 206.
 Halifax, 88.
 Hanley, 142, 293.
 Islington, 17.
 Lambeth, 88.
 Leeds, 88, 206, 293.
 Lincoln, 88.
 Macclesfield, 116.
 Madras, 88, 167.
 Maidstone, 17.
 Manchester, 52.
 Marylebone, 17.
 Montreal, 144.
 Newcastle-under-Lyne, 88.
 Newington Butts, 88.
 Northampton, 18.
 Nottingham, 116, 293.
 Oxford, 293.
 Rochdale, 269.
 Rochester, 116.
 Ryde, 142.
 Sheffield, 18, 116.
 South Kensington, 52, 294.
 Swansea, 142.
 Yarmouth, 167, 293.
 Scott Centenary, 190, 223, 229.
 Sculpture, American, 6.
 Sideboard, Smith's Mediæval, 171.
 Sketches in the Far East, Chevalier's, 207.
 Smoke-Pictures, 249.

Society for the Encouragement of the Fine Arts, 62, 94, 126, 171.
 Society of Arts, 62, 190.
 Society of Female Artists, 62, 90, 147.
 Sovereign, The New, 83.
 Spring of Life, 80, 125.

Statues:—

Balfe, 211.
 Boadicea, 191.
 Brunel, 295.
 Burgoyne, Sir J., 294.
 Canning, Lord, 294.
 Charles II., 127.
 De la Pole, M., 230.
 Derby, Earl of, 247.
 Drake, Sir F., 206.
 Dundonald, Earl of, 167.
 Frederic William the Third, 207.
 Graham, Professor, 246.
 Guinevere, 294.
 Hagar, 123.
 Hall, R., 293.
 Lincoln, A., 123.
 McNeile, Dr., 8.
 Morse, Professor, 207.
 O'Brien, W. S., 44.
 Outram, Sir J., 170, 210, 230.
 Prince Consort, 191.
 Queen, The, 207.
 Scott, Sir W., 207.
 Stephenson, R., 191.
 Sultan, The, 127.
 Statues at Westminster, 211.
 Statues doing Penance, 210.
 Statues, Our Public, 230.
 Stereoscope for Coloured Photographs, 170.
 Stereoscopic Company, 274.

TALBOT and the Countess of Auvergne, 154.
 Tapestries of Beauvais, &c., 76.
 Tapestries of the Gobelins, 286.
 Terra-Cotta Alto-relievos, 91.
 Thames Embankment, 210, 230, 231.
 Thomas, W. Cave, 171.
 Tiber, A Voice from the, 244.
 Tite, Portrait of Sir W., 294.
 Trollope's Decorative Furniture, 182.

UNIVERSITY College, 171, 190, 229, 269.

VALENTINES, Rimmel's, 95.
 Venetian Silvering, 127.
 Visits to Private Galleries:—
 Quilter, W., 110.
 Rickards, C. H., 256.
 Turner, H. J., 18.

WALL-PAINTINGS at Lichfield, Ancient, 167.
 Water-Colour Painters' Institute, 29, 43, 155.
 Water-Colour Painters' Society, 25, 29, 146, 154, 191, 295.
 Water-Reflections, 5, 183, 184.
 Wedgwood's Pottery Works, 95.
 Wellington Monument, 29, 125, 190, 250.
 Westminster Abbey, 227, 251.
 White Cockade, The, 184.
 Woodcarvers' Society, 200.
 Woodcarvings by A. Rogers, 231.
 Working Men's College, 72, 275.

XILATECHNOGRAPHY, 182.

YVON'S Art-School for Ladies, 94, 147.

ZEALAND, Scenery of New, 171, 211, 229.

THE ART-JOURNAL.



LONDON: JANUARY 1, 1871



BRITISH ARTISTS:
THEIR STYLE AND CHARACTER.
WITH ENGRAVED ILLUSTRATIONS.

No. XCVI. THOMAS FAED, R.A., H.R.S.A.



WE borrow from Mr. Ottley's supplement to the last edition of Bryan's "Dictionary of Painters and Engravers," the following account of the early life of the distinguished artist whose name heads this paper.—"Thomas Faed was born at Burley Mill, in the picturesque stewardry of Kirkcudbright, in Scotland, in the year 1826. His father, who was a man of considerable mental powers, and with a genius for mechanical contrivance which he had no opportunity of developing, there carried on business as an engineer and millwright. The beauty of the surrounding scenery,

and the interesting subjects with which it was peopled, soon caught the attention of the embryo artist, who, in the summer months, when the mill was standing, and there was no grain preparing in the kiln, was in the habit of converting the smoke-begrimed apartment into a studio, where, like a second Rembrandt, with a fair top-light, and a dark background, he painted assiduously from the ragged boys who flitted in the rustic world around him." His father died while the incipient painter was yet in his boyhood; but genius had already marked the family for its own. His elder brother, John, who had achieved eminence as a painter in Edinburgh, recognised the drawing talent of Thomas, and invited him to his house in 1843, where he entertained him for some years, nurturing the gifts which were so apparent in him. Never was family love so happily displayed as in this case, when the Royal Academician of the future might, if he were asked, acknowledge with pride and satisfaction that he owed in great measure his position as an artist to a brother's affectionate solicitude. Our youthful aspirant laboured for some years with assiduity in the Edinburgh School of Design, a very short time under Sir William Allan, but principally under the late Thomas Duncan, and was annually rewarded at the competition for prizes in various departments. The earliest work he ventured to exhibit was a water-colour drawing, 'The Old English Baron,' but he afterwards devoted himself to oil-painting.

Mr. Faed advanced so rapidly in his profession that in 1849, when he had scarcely reached his twenty-third year, he was made an Associate of the Royal Scottish Academy. Among the various works he painted at this period of his life was one that has become widely known by the engraving from it, 'Sir Walter Scott and his Friends at Abbotsford.' He made his appearance in London as an exhibitor in 1851, while he was still residing in Edinburgh, by sending to our Royal Academy three pictures, 'Cottage Piety,' 'My Father urged me sair,' from *Auld Robin Gray*, and 'The First Step.' In 1852 he came to London, where he has since resided. That year he contributed to the Academy-exhibition 'Burns and Highland Mary,' and 'THE PATRON AND PATRONESS'



Drawn by W. J. Allen.]

THE VISIT TO THE VILLAGE-SCHOOL.

[Engraved by Stephen Miller.

VISIT TO THE VILLAGE-SCHOOL,' now the property of Mr. Graham, Skelmorley, near Glasgow, and engraved on this page. As a subject admitting infinite variety of character these village-schools have often been visited—at least mentally—by *genre*-painters both English and foreign. Mr. Faed's version, though

the work of a young artist, will bear favourable comparison with the best.

In 1853 there appeared at the Academy from the pencil of Mr. Faed, 'The Early Lesson' and 'Sophia and Olivia;' the latter very graceful in composition—the heads, draperies, and accessories

all painted with the nicest finish. In the following year he contributed to the same gallery, 'Morning—Reapers going out,' and 'Peggy,' from Allan Ramsay's *Gentle Shepherd*: both these pictures were spoken of in very laudable terms in our review of the exhibition of the year. From that of 1855 may be dated the commencement of the popularity Mr. Faed has ever since held in public opinion; for the year produced 'The Mitherless Bairn,' a composition which the hands of engravers have scattered far and wide over the world (an engraving from the original sketch was published in the *Art-Journal* in 1866, under the title of 'The Orphan': the work was then so fully described as to render any further reference to it now quite unnecessary); and two less important works, 'Children going to Market' and 'From our own Correspondent': the latter represents an old woman seated in her cottage and reading the *Times*. These pictures of single figures are by no means the least valuable of Mr. Faed's impersonations. 'Home and the Homeless,'—a composition of similar import to 'The Mitherless Bairn,'—and 'Highland Mary,' were

hung in the Academy exhibition of 1856. 'The First Break in the Family,' his solitary contribution in 1857, has never faded from our recollection ever since we saw it on the walls of the Academy: its rich and powerful colouring, the various feelings indicated on the countenances of the figures, its general poetic treatment, with the rainbow arching over the landscape and lighting up the cottage-door from which the boy has just departed to seek his fortune in the world, all combine to make us envious of the possessor of this most covetable picture. The year following Mr. Faed exhibited four works: 'The Sunbeams,' 'A Listener never hears gude o' himself,' 'The Welcome,' and 'The Ayrshire Lassie'—each excellent in its kind.

One of the two compositions sent by this artist to the Academy in 1859 has, like many others by him, been brought within the knowledge of thousands by means of engraving: we allude to his 'Sunday in the Backwoods,' a work, as we said of it at the time, "of the rarest excellence in its line of subject, . . . it is the signal production of its author." The other work was 'My ain Fireside.'



Drawn by W. J. Allen.]

HIDE AND SEEK.

[Engraved by Stephen Miller.]

Who does not remember Mr. Faed's semi-nude little urchin seated on a table, waiting the termination of his poor mother's almost interminable task of mending 'His only Pair'—of trowsers, worn by time, and tattered through scrambles amid brake and briars? the only work Mr. Faed exhibited in 1860; but it was quite enough to attract crowds before it, as one of the great features of the gallery.

In 1861 Mr. Faed had conferred upon him an honour which, not unjustly, he might have received two or three years previously; he was elected Associate of the Academy. His sole exhibited picture of the year—and it is a noble one—was 'From Dawn to Sunset.' We could write a page or two about this most instructive picture, one of the very highest class, which has not inappropriately been called "a domestic reading of Shakspeare's Seven Ages of Man. . . . a deep domestic epic, worked out with marvellous skill of Art."

So far as relates to size of canvas his contributions to the Academy in 1862 were on a comparatively small scale; but each one

of the four pictures he exhibited would grace any gallery. They were 'Kate Nickleby,' 'A Flower from Paddy's Land'—both of them single figures—and 'New Wars to an Old Soldier': the last represents a veteran of the army, who is decorated with the medal for Waterloo, half-asleep in a chair, while his daughter reads to him an account of some recent engagement—possibly in the Crimea; a third figure, a little boy, is at play near his grandfather. With these the artist sent the only portrait we ever remember to have seen from his hand—a capital one of the son of Mr. Hepworth Dixon. Three pictures, also small in size, were Mr. Faed's contingent to the Academy in the year following. 'Train up a Child' is the text from which Mr. Faed discoursed pictorially on one of the first duties of humble housewifery: a mother and young daughter are busy with needles and thread on sundry articles of wearing-apparel. 'The Silken Gown,' is a version of the old Scotch song "An ye shall walk in silk attire." 'An Irish Orange-girl' completes the triad of pictures—all admirably painted.

'Our Washing-Day' and 'Baith Father and Mother' were exhi-

bited in 1864: the former some buxom lassies chatting and laughing over their wash-tubs; the latter the interior of a village shoemaker's workshop, whose occupier holds a motherless child on his knees while he prepares her for school by gently putting a pair of gloves on her hands, while her schoolfellows wait the completion of the humble toilet. A touching subject this, and worked out with a refinement of feeling and of artistic quality most commendable. The year did not close without seeing Mr. Faed elected a Royal Academician. He is also an Honorary Member of the Royal Scottish Academy.

'The Last of the Clan,' exhibited in 1865, was referred to in our journal of that date, as the "greatest" work Mr. Faed had put forth since his 'From Dawn to Sunset':—"A touching story is here

told of the last small remnant of a once great and powerful clan. . . . The subject is well-chosen for the display of the painter's specialities; it gives him the opportunity of grouping effectively men stricken in years, aged women bowed in sorrow, maidens melting into tears—characters which dispose into a homely and heartfelt picture of Scottish nationality."

The limited space at our command warns us to rest contented with the mere enumeration of the pictures subsequently exhibited at the Academy by Mr. Faed. They are—his diploma work—'Ere Care begins,' and 'Potluck,' in 1866; 'The Poor, the Poor Man's Friend,' in 1867; 'Worn-out,' 'The Flower o' Dunblane,' and 'The Cradle,' in 1868. In the year following he sent five examples—the largest number he ever exhibited at one time:



Drawn by W. F. Allen.]

JEANNIE DEANS AND THE DUKE OF ARGYLL.

[Engraved by Stephen Miller.

'Homeless,' 'Only Herself,' 'Letting the Cow into the Corn,' 'Faults on both sides,' and 'Donald McTavish:' and last year, 'When the Day is gone' and 'The Highland Mother.' Any one of these works would make the reputation of an artist who had not already reached renown.

'HIDE AND SEEK,' one of the subjects we have engraved, has not, we believe, ever been exhibited. It tells its own tale, and exhibits more of the sunny side of cottage life than the painter usually shows us.

'JEANNIE DEANS AND THE DUKE OF ARGYLL' is a small canvas belonging to Mr. Fox, of Alderley Edge, who has frequently given us access to his well-chosen collection for this and other kindred purposes. The picture is little more than a finished sketch,

masterly in execution, and a gem in colour. Readers of "The Heart of Midlothian" will scarcely fail to recognise the subject. The original work is in the possession of Mr. Campbell, of Blythwood.

We have offered but scanty justice to an artist whose genius and well-deserved popularity merit more ample acknowledgment: yet what can be done within restricted measurement when so many of his works furnish texts for lengthened discourse? As a delineator of Scottish life in its more humble phases, he will always rank with his great countryman, Wilkie; and we think Mr. Faed would acknowledge a higher compliment could scarcely be paid him. In largeness of style and manner, he has, however, the advantage over Wilkie.

JAMES DAFFORNE.

A MODEL CATALOGUE.*

WE have already reviewed the lectures of the Slade Professor of Fine Art, at Oxford, and are glad to find that he has issued a catalogue of the series of examples illustrating those lectures, placed in the University galleries. This collection will consist of three divisions: the standard, of 400 pieces; the educational; and the reference—the two last to be indefinitely extended. At the time of the publication of the catalogue about 200 pieces were placed in the galleries, sufficient for introductory study. Our space will only allow us to make a few quotations from this catalogue. In taking up a work by Mr. Ruskin one naturally looks for expressions of his admiration, and through appreciation of Turner, and in this work we find the same. He gives (2) the 'Junction of the Greta and Tees at Rokeby' as a "faultless example of Turner's work at the time when it is most exemplary. It is an unrivalled example of *chiar-oscuro* of the most subtle kind, obtained by the slightest possible contrast, and by consummate skill in the management of gradation." 'Brigal Banks on the Greta, near Rokeby,' is "among the loveliest of all Turner's local landscapes;" and the engraving shows the peculiar attainments of recent line-engraving in England—namely, the retention of local colour and subdued tones of light. The treatment of the little glen by Turner is "entirely characteristic both of his own temper throughout life, and of the pensiveness of the great school of chiaroscuroists to which he belongs." In another place he tells his pupils to put out of their heads any idea of there being tricks or secrets in Turner's colouring. "Flat wash on white paper, of the shape that it should be, and the colour it should be, that is his secret." Of an early drawing by Turner, when he was fifteen or sixteen, of a Gothic mansion, he says, "Try either the forms of the white clouds in colour, or those of the building in pencil, and you will soon know what to think of the assertion that 'Turner could not draw.'"

The professor considers the *Melancholia* of Albert Dürer, "the best type of the spirit of labour in which the greater number of strong men at the present day have to work. Nevertheless, I must warn you against overrating the depth of feeling in which the grave or terrible designs of the masters of the sixteenth century were executed. . . . Albert Dürer has had the credit for deeper feeling than ever influenced him; he was essentially a Nürnberg craftsman, with much of the instinct for manufacture of toys on which the commercial prosperity of his native town has been partly founded; he is, in fact, almost himself the whole town of Nürnberg, become one personality (only without avarice); sometimes, in the exquisitely skilful, yet dreamily passive way in which he renders all that he saw, great things and small alike, he seems to me himself a kind of automaton, and the most wonderful toy that Nürnberg ever made." He gives Dürer's 'Knight and Death' (9) as an example of perfect delineation by the school of *chiar-oscuro*. The plate has been interpreted as the victory of human patience over death and sin; but Mr. Ruskin thinks later critics are right in supposing it to be the oft-mentioned *Nemesis*, and that the patience and victory are meant to be Death's and the Fiend's. He thinks 'Adam and Eve' (10) his best plate in point of execution, and next to it may be placed the coat of arms with the skull. The latter is placed No. 36 in the educational series, and he considers it the best of all his engravings for any endeavour at imitation. Two woodcuts from Dürer's series of the Apocalypse are given, and these Mr. Ruskin evidently appreciates. That illustrating chaps. xvii. and xviii. he thinks Dürer in his "sympathy with whatever part of the passion of the Reformation was directed against the vices of the Roman Church, but not against its faith," meant to indicate "the contentment of men of the world in a religion which at that time permitted them to retain their pride and their evil pleasures," and the monk introduced to express "the superstition which could

not be disturbed by any evidence of increasing sin in the body of the Church."

Raphael's 'Marriage of the Virgin' (16), in the Brera, at Milan, is described as "one of the most beautiful works of Raphael's early time; but its merit is rather to be considered as the final result of the teaching and practice of former schools than as an achievement of the master himself." We are told of the figure of 'Justice' (18), in the Vatican fresco, that Raphael (unlike Giotto) was not thinking of Justice at all, but only to put a charming figure in a graceful posture:—"The work, however, is one of his finest, as far as merely artistic qualities are concerned, and is in the highest degree learned and skilful, but neither strong nor sincere." His 'Parnassus' (20) "represents the character of the same master's conceptions in his strongest time—full of beauty, but always more or less affected; every figure being cast into an attitude either of academical grace or of exaggeratedly dramatic gesture."

Correggio's peculiarities are well hit off. Speaking of his 'Sketch for the Assumption at Parma' (13), Mr. Ruskin says, "It is splendid, but, like all Correggio's works, affected; and, while his skill remains unrivalled, his affectations have been borrowed by nearly all subsequent painters, who have made it their special endeavour to represent graceful form, as the mannerisms of the religious schools have been imitated by men who had no part in their passion, until it is too commonly thought impossible to express either sentiment or devotion without inclining the heads of the persons represented to one side or the other, in the manner of Correggio or Perugino." In this series (the standard) 31 to 40 illustrate the school of delineation in which the drawing is chiefly wrought with the point of the brush; and 41 to 50 represents the work of the greatest master of painting by whom the brush is used in a broad manner—the latter being masters of portraiture, as Vandyck, Reynolds, Velasquez, and Titian.

Commenting upon the 'Resurrection' of Semele (201), Mr. Ruskin says:—"There is no question that throughout the best periods of Greek mural design, the colours were few and grave, and the merit of the composition almost as strictly dependent on the purity of the terminal lines as in the best vases; neither is there any doubt that the precision of this terminal line is executively the safeguard of noble Art in all ages; and in requesting the student to practise the difficult exercises in drawing with the brush which are placed in the educational series, my purpose is not to relax the accuracy of his use of the pen, but to bring precision and elasticity into his laying in of colour. The manner of execution resulting from the use of the style, or any other incisive or modelling instrument, on wax and clay, and which entirely governs the early system, both of Greek and Italian mural-painting, is to be considered together with the various functions of incised lines on any solid substance, from Egyptian *bas-relief* to finished line-engraving. The pen or any other instrument of pure delineation is always best used when with the lightness of the brush, and the brush always best used when either at its point or edge, it is moving with the precision of the pen. . . . The Semele and Dionysus of this noble period represent the fruitful, as distinct from other powers of the sky and earth; Semele being the sun-heated cloud which dissolves in beneficent rain, distinguished from the wandering and shadowy cloud represented by Hermes."

One more quotation on the change in Greek conception of the Deity, and we have done:—"The gods are at first thought of only as vital embodiments of a given physical force, but afterwards as high personal intelligences capable of every phase of human passion. They are first conceived as in impetuous and ceaseless action; afterwards only in deliberate action or in perfect repose. They are first conceived under grotesque forms, implying in the designer a certain savage earnestness incapable of admitting or even perceiving jest; afterwards they are conceived by deliberately selective imagination, under forms of beauty which imply in the designer a relative perception, and rejection of all that is vulgar and ludicrous."

SELECTED PICTURES.

FROM THE PICTURE IN THE POSSESSION OF THE PUBLISHERS.

THE DUEL INTERRUPTED.

Marcus Stone, Painter. H. Bourne, Engraver.

THIS picture, exhibited at the Royal Academy in 1868, was unquestionably the best work Mr. Stone had painted up to that date: his two subsequent productions, 'The Princess (afterwards Queen) Elizabeth obliged to attend Mass by her Sister Mary,' exhibited in 1869; and 'Henry VIII. and Anne Boleyn observed by Queen Katherine,' his last year's contribution, have, as certainly, largely added to the reputation he acquired by 'The Duel.' These subjects all evince a higher range of thought and motive than any of his antecedent works, with more matured power of delineating character and expression, united to greater vigour of execution and knowledge of the force of colour by simple contrasts and harmonious arrangement. It seems to us that this artist, if he only uses his talents in a manner commensurate with the ability he has shown, is now in a fair way to place himself in the ranks of our best living painters of history, or *quasi*-history.

We have studied 'The Duel Interrupted' to find if we could make a story out of the materials of the composition which might bear some relation to the intention of the painter. Artists, we know, often leave the reading of their works to the judgment or the fancy of those who look at them; and Mr. Stone appears to have done so in this case; for there is nothing on the canvas to lead the spectator to any definite solution of the scene it exhibits. The place where the intended combatants have met is the front of a ruinous and deserted cottage, selected, no doubt, as best suited to screen from observation. We can discover no clue to the position occupied by the principal *dramatis personæ* with respect to each other, nor to the cause which has led to a hostile meeting: the younger belligerent is, however, of the Hotspur type, fiery and impetuous, eager for blood; the other—calm and collected, with a saddened expression of countenance, as if conscious that his superior skill as a swordsman and coolness of temper must give him advantage over his opponent, perhaps to the taking away of his life to ensure his own—awaits the onset with comparative imperturbability. The young lady, who with her confidential servant, the old woman, has followed the duellists to their place of meeting, may possibly be the daughter of the one, and the lover of the other, and also the cause of hostilities between them. She has thrown herself in front of the younger, earnestly beseeching him to desist from the encounter, while her companion, with hands tightly clasped, makes a similar appeal to his opponent. Behind the latter is his second, arguing the point with the old lady; while the old "leech," who has brought to the ground all things necessary for a case of operative surgery, evidently regards the interruption as an interference with his professional duties, and likely to deprive him of a lucrative job. The burly figure on the extreme left of the picture is the younger man's "friend," looking very much as if he felt his position not quite comfortable.

The composition is admirably put together, and each figure has its own individuality forcibly expressed. It shows, moreover, an originality of conception which is not the least of its merits.

* CATALOGUE OF EXAMPLES ARRANGED FOR ELEMENTARY STUDY IN THE UNIVERSITY GALLERIES. By JOHN RUSKIN, M.A. Oxford: Clarendon Press, 1870.



H. BRONKHORST

THEATRE. — THE ACTRESS AND THE MAN.



ON REFLECTIONS IN WATER.

BY LIEUT.-COL. DRAYSON, R.A., F.R.A.S.

IN the *Art-Journal* for 1864 I treated geometrically the subject of reflections in still water. It was attempted in that article to give a few simple rules for the guidance of those artists who either could not, or did not, complete all the details of their sketches on the actual ground. It must be granted as a great desideratum that an artist should represent nature as it really is—to place upon his paper or canvas an accurate portrait of what he sees. Now there are, of course, insurmountable difficulties in the way of deciding whether a tree or a line of hills has been correctly portrayed; but as soon as an artist places a reflection on water, there can be no mistake as regards this item. A geometrician can at once place his finger on a reflection in still water, and can demonstrate that this is either true or false. When then we find that a reflection is represented incorrectly, our faith is at once shaken in the general accuracy of the sketch, and the work, however skilfully executed, is depreciated in value. What faith for example should we have in the accuracy of an artist who gave us a sketch of country, and placed a covey of partridges in a tree?

Some two years ago one of our leading illustrated papers gave a sunset view, representing a fine old ship coming into harbour, and showed the crescent moon turned *dark side to the sun*. Scarcely an exhibition can be visited even now, in which at least half the reflections shown in still water are not geometrical impossibilities; and that which is not the least curious part is, that as a general rule the artists will inform you that this is a subject to which they have devoted special attention.

It has afforded me no little amusement of late years to suggest to various artist friends the remote possibility that they did not understand how to reflect objects in still water. With becoming dignity these friends would reply by selecting some half dozen sketches in which reflections were shown. I can conscientiously say that in at least five cases out of six, and in nearly every case where the problem had not been shirked by making the water wavy, the reflections shown on paper were impossible representations.

Upon mentioning some two years ago to the late Mr. Aaron Penley that few artists seemed to pay much attention to this subject, I was amused by his candid reply—"I have tried to pay attention to it," he said, "but I am very certain I know nothing about it, and still more certain that a large majority of artists know less than I do."

As an exception to this sweeping condemnation, one celebrated student of nature may be mentioned, and he was one who was much given to either still water or water rippling slightly—this was Turner. Upon looking with critical eye over the works of Turner, one can scarcely ever find that he erred in his reflections—they are invariably geometrically true. When we consider this fact it is very remarkable, and speaks volumes for the accuracy of observation of the artist. If, for example, a geometrician measured the three angles of a triangle, he would know that they ought to amount to 180° , and he would probably make little corrections in order to make their sum equal to this amount. If, however, an observer did not know that

they ought to amount to 180° , we should place a high value on the accuracy of his observations, if we found that he always gave results which did amount to this quantity. Thus it is with Turner, he by intuitive perception saw that which the geometrician arrives at by demonstration.

Although photography is not minutely

accurate as regards the details of reflections, yet we can from photographs learn how very curious reflections sometimes come out. There is a large and very beautiful photograph of Raglan Castle, in which the reflections are given in still water. These reflections are so nearly true geometrically, that they may be ac-

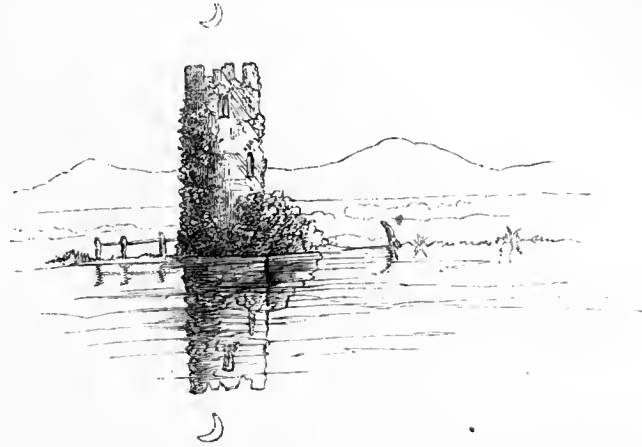

cepted as studies. On the right-hand side of this photograph there is a tower reflected in water; and I have often puzzled artists by slipping a piece of paper over the reflection, and then asking them where they would place the reflection of the top of the tower. It was soon evident that if they attempted to mark the spot, success would be merely the result of luck.

D M

O S

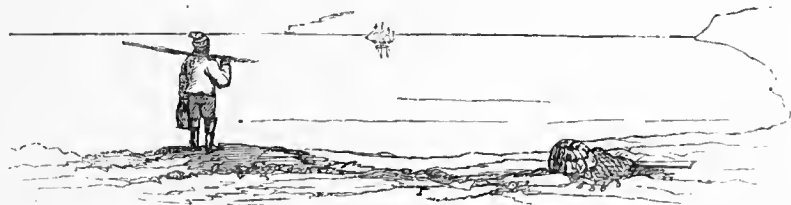

reflection of the sun in his sextant glasses, indicates one of those rigid laws which are unchangeable. But our feelings are very different when we see an otherwise skilful artist dash in all these reflections by guess, or represent them in a manner which is false to the laws we admire. As soon would we look at a skilfully-coloured picture of a farm-yard, in which the horses

were delineated with six legs and cloven feet, and the cows with branching antlers.

Those items with which the greatest mistakes are made, are when distant and near objects are seen one just above or below the other. An artist friend, in order to convince us that he was well acquainted with the law of reflections, showed a sketch of an old tower with the moon just above



it. This tower was reflected in a still darkish pool, and the moon also, the whole subject being something like the first sketch on this page.

Now the reflection of the moon in the sketch is entirely wrong, and is as painful to the eye of a geometrician as a false note to the ear of a musician. The reflection of

the tower is also incorrect, but the moon's position as shown in the water is impossible. Applying the great law which we pointed out in the former article, viz., that the angle of incidence is always equal to the angle of reflection, it would be found that the moon's reflection would not be visible in the water at all, it would be hidden

behind the tower. This is an example of the error arising when we have a distant and a near object to reflect; thus the sun and moon are usually very trying objects to those who sketch only partially out of doors, and fill in at home the various details, or to those who sketch rapidly without noting the exact position of objects.

The last two sketches are given in order that the reader may satisfy himself he is well acquainted with the laws governing reflections in still water. The first is supposed to represent a perfectly calm sea, which would reflect objects as though in a mirror. The sketcher is standing nearly on a level with the sea-line, as will be evident from the relative height of the sea-horizon and the head of the man in the foreground. On the right-hand side we will suppose the sun to be seen at S, and on the left-hand side the moon at M. Now the problem for the reader to solve is, where will be the exact spot where the sun will be reflected in the water, and where the exact spot where the moon will be seen? Again, referring to the same diagram, let us suppose that there is a slight ripple on the sea, the sun's reflection would then become a sparkling line of light: now in what position on the sketch would this line of light be correctly represented? and why should it have only one possible position?

In the next diagram, I represent the bank of a stream, the water being "still." On this bank a post is standing; at some considerable distance there is a windmill; and above the hills there is the crescent moon. The problem for the reader is, to mark exactly where the reflection of the windmill and the moon would appear. Each person will be able to decide for himself whether or not he thoroughly understands the principles on which reflections depend. If he has to guess where the reflections appear, and is uncertain whether he is right, he may be assured that he does not know much about it: if he can *prove* that he is correct after he has given the position of the reflection, of course he will be satisfied that he is not far wrong.

So singularly beautiful are the effects of reflections in still water and so simple the laws connected with them, that we believe every real artist will estimate at its true value a knowledge of this branch of his art. As we before remarked, we cannot state whether a sketch of ground which we do not know is or is not quite accurate; but we can tell whether reflections are correctly represented, and when we find the latter item is wrong, we lose faith in the artist's skill to depict objects as they really are, and consequently his sketches have for us less value than they otherwise would have.

OBITUARY.

JOSEPH MOZIER.

JOSEPH MOZIER, whose death we announced a short time since, was born in Burlington, Vermont, United States, in 1812. His family, one of French origin, was respectable, though not rich. From his earliest youth he had a passion for Art, and ambition to attain distinction. But his means not seconding his wishes, or rather an entire absence of means forbidding his immediately following his desired career, he had determination and energy to enter into commerce, and to persevere in strenuous though ungenial labour, till he

had acquired a small capital, with which to realise his cherished dream of becoming an Art-student. It is a curious fact, that a now celebrated American senator and diplomatist, was the young merchant's partner in his commercial enterprise, and with a similar aim—to obtain the means of pursuing a career of distinction and honour. With his hardly won store, Mr. Mozier proceeded to Rome, where he immediately began working with a degree of energy and enthusiasm which ere long secured for his works the appreciation they deserved. Few sojourners in Rome but knew the pleasant studio in the Via Margutta, wherein the patient labourer was still arduously working after nearly thirty years of devotion to Art, during which period he had never left Rome or paused in study for more than a few weeks at a time. He was not only the hard-working artist, he was the kind helper and encourager of the aspiring, but less fortunate; the firm, reliable friend of all who deserved, or even needed, kindness. He was not only generous to his countrymen, but especially kind to any Englishman who required and asked his sympathy.

Mr. Mozier was a most prolific artist: probably his best statues are a veiled 'Undine' and 'The White Lady of Avenel'; there is great beauty in his 'Queen Esther,' 'Jephtha's Daughter,' 'Pochahontas,' and 'The Wept-of-the-Wishton-Wish.' All his female figures are remarkable for their delicacy and grace.

Just as his genius was matured, Mr. Mozier was cut off: he had been in weak health, had paid a brief visit to his country, and returned to London, intending to proceed immediately to his Roman home; he was, however, obliged to defer his journey for some weeks, through extreme suffering. At length, making a desperate effort, he set off for Rome, conscious of his hopeless state, but passionately longing to see his long familiar home once more, and at least to fall asleep amid the scenes endeared to him by past struggles and late triumphs. "I cannot sleep well, unless I lie under the Roman cypresses," he repeated. After a painful journey, lengthened by the necessity of avoiding the scene of war, he reached Faïdo, and there expired, on the third of October, a few hours after his arrival. He was not to see his adopted land again, but his remains were carried to the resting-place to which his last wishes had so earnestly pointed.

LOUIS HENRY MIGNOT.

This painter, whose decease was also recorded in our columns very recently, was born at Charleston, South Carolina, United States, in 1831. He sprang from a French family, who being strongly attached to the imperial cause, left France and migrated to America, on the restoration of the Bourbons. Mr. Mignot's youth was spent in the home of his wealthy grandfather, near his birth-place. His genius and love for Art sprang up spontaneously: while yet a child he employed a somewhat prodigal supply of pocket-money in the purchase of a beautiful statuette.

At seventeen his career was chosen: despite the opposition of his family, he resolved to be an artist. Having passed through a course of drawing-instruction, he proceeded to Europe, landed in Holland, and assiduously applied himself to the study of landscape-painting, under Schellfaul, at the Hague. This lasted but a brief space: he resolved very quickly to follow no school, to read no books on Art, but to go to

nature, which he did faithfully. After four years' sojourn in Europe, Mr. Mignot returned to America, settled for a time in New York, where his success was immediate and complete. He studied nature in North and South America, as well as in Europe, and was peculiarly happy in reproducing, without the slightest exaggeration, the glowing scenery of the south, and also in painting snow-pieces, from northern scenery.

Mr. Mignot spent several years in England, where he met with great success, realising in a short time considerable sums of money, which was destined to melt away through the channels of a too lavish and indiscriminate generosity.

Mr. Mignot had been some time in Paris, which, in common with many other sufferers in the disastrous war now raging, he was obliged to quit precipitately, abandoning finished pictures, and nearly executed commissions—in fact, everything he possessed of value. Anxiety, fatigue, and we may add privation, brought on an illness, which proved to be small-pox, and to that disease, aggravated by exposure to the air, this meritorious artist fell a victim, at the early age of thirty-nine. He died too soon, for his genius was still developing.

Like all men who have been distinguished in Art, he was a great and an appreciative reader, and a thoroughly accomplished man: his knowledge of literature was extensive, his memory remarkable, and his endowments were such as would have made his reputation in almost any pursuit he might have chosen.

PROGRESS OF AMERICAN SCULPTURE IN EUROPE.

A COMPLETE generation has not yet passed away since a school of sculpture was founded in America. Notwithstanding disadvantages in the way of a practical education, scores of successful sculptors have come forward, although without as yet giving to the world one of great and original power. Any shortcomings in technical training are due to a want of adequate means of academical instruction, rather than to any deficiency of mechanical skill or intellectual invention. But the Museums of Art and Schools of Design now in process of organisation in the principal cities will, in time, give ample means of elementary education. Meanwhile it is pleasant to note the progress making, and the increasing desire of buyers for works of a more original stamp than those hitherto in vogue. There is, of course, the usual call for strictly realistic busts and portrait-statues, in which considerable skill of characterisation is shown. However faulty the torsos, limbs, and postures of American statues of eminent persons, the heads are tolerably sure to be cleverly executed.

But in the very outset of their career the sculptors of America ambitiously attacked the most difficult side of their art, and sought at once to rival the accomplishments of races that had taken centuries to perfect theirs. In view of a beginning, the Greek Slaves, Chanting Cherubs, Ganymedes, and similar efforts of Powers, Greenough, and Crawford were more than respectable, although in comparison with the perfected standard of Classical Art which they challenged, they were decided failures. Every weak reflection of a dead idealism is in itself a mistake. Each race should create its own ideals out of its living present.

The human figure must for ever remain the most complete model and highest possibility of sculpture. But its animating idea should either be of universal application or in direct sympathy with the times. As we find evidence of this truth in the works of our sculptors, so it is a solid proof that they are on the right track of progress.

The sculptors who remain in America are too strongly influenced by the prevailing realistic bias of the popular taste to attempt much of a different character. But on settling in Italy, where the opposite tendency prevails, they are easily led to test their capacities of ideal invention. Their number increases so rapidly that it is not easy to keep all their works in view. We will now limit the notice to such as afford evidence of imaginative power. Some of the most stubborn realists, like Harriett Hosmer, Rogers, and Ball, not to speak of less eminent names, occasionally try flights of invention, but with results that show it is a mistake to force their talents out of their natural course. Story, on account of his æsthetic culture, does better in inventive composition than in positive portraiture, as may be seen on comparing his 'Sybil,' and 'Cleopatra,' with his 'Peabody,' and 'Everett.' Miss Stebbin's 'Columbus' is a prosaic fulfilment of what was meant to be a poetical conception of the uncompromising discoverer steering his own bark in quest of a new world. The group of 'Queen Isabella, Columbus, and the Page,' by Larkin Meade, answers to a stone-cutter's notion of bigness, if not greatness. It is as graphic in decorative detail as a child's picture-book, and about as touching to the adult imagination. All this sort of idealistic commonplace can be classed under the general category of figure-head sculpture, although pardon ought to be asked of some ship's bows for the comparison. There is something effectively broad in the treatment by Jackson of 'Eve lamenting over the dead body of Abel,' which she holds in her lap, after the manner of a sixteenth-century Pietà. The first mother pondering over the mystery of the first murder would afford a profound theme for the greatest genius. Even to hint the querying emotions of the one, and the subtle smile in death that baffles alike human love and curiosity in the other, would be to accomplish much. The choice of the motive demonstrates the right sort of ambition in the artist, and a hearty appreciation of the loftiest possibilities of sculpture.

While few, if any, American women, have won a reputation in painting, several have acquired some distinction in sculpture. This would indicate that a superficial success is more feasible in the latter than even the former, as regards the effect on the common mind, and that it necessitates less preliminary training and manipulative skill. There may be another cause. Modern painting is essentially scientific in its system of instruction. It requires much mental and manual toil, and long and close outdoor observation of nature, to master the elementary conditions of perfect practice in painting either landscape or the human figure. Few women as yet are predisposed to intellectual pursuits which demand wearisome years of preparation and deferred hope. Naturally they turn to those fields of Art which may seem to yield the quickest returns for the least expenditure of mental capital. Having in general a nice feeling for form, quick perceptions and a mobile fancy, with, not unfrequently, a lively imagination, it is not strange that modelling in clay is tempting to their fair fingers. Painting baffles,

mystifies, or cheats not only its disciples, but the critics, unless both possess some definite knowledge as to its means and ends. It asks the spectator to mistake the semblance for the reality; to seem to be what it is not. But sculpture, massed in simple white or dark forms like a ghostly image or conventional symbol, makes no such appeal even to the most superficial eye. Provided the general masses are fairly distributed and rendered, its prominent motive comes home so forcibly to the spectator, with so little of material illusion as to the nature of its means, that he seldom cares, as with paintings, to linger over or examine into the details of the work. The first impression of sculpture goes for more with the public than that of painting, when, indeed, it is really worth less, because its real merits and demerits are less easy of immediate recognition. Nevertheless it takes very much to make a good sculptor, and something more to constitute a clever painter; whereas a good painter can become a fair sculptor and keep something in reserve. Whether this consideration is confessed or not, doubtless it has some weight in the choice between the sister Arts.

Women, by nature, are likewise prompted in the treatment of sculpture to motives of fancy and sentiment, rather than to compete with men in realistic portraiture or absolute creative imagination. But this distinction, like every generalisation, has its exceptions. The works of Harriett Hosmer are all of a robust, masculine character, even in details, as if wrought out by hard head-work and diligent study of models by a mind that had forced itself, as with a manly energy, to achieve a mechanical mastery of a profession for which it has no supreme æsthetic predilection; while those of Story are conspicuous for a certain femininity of aspect, owing to their excess of fancy, accurate taste as to accessories, and prevailing atmosphere of good society and nice culture.

If women fail in portraiture in bronze and marble, as would appear by the few essays they have made in this direction, they are often felicitous in their choice of ideal motives, whatever may be the shortcomings of execution. Miss Stebbin's 'Angel stirring the Waters of Siloam'—a design for a fountain in New York, and her 'Satan descending to tempt Mankind,' are apt instances of her talent in this respect. So also is Miss Anne Whitney's symbolism of 'Africa awakening to take her place among Nations'—a Michel Angelesque conception of an Ethiopian virgin starting from a deep slumber, shading her eyes with one hand, as she slowly rises on her elbow, from the blinding light of a superior world. Another original conception by this lady is that of 'Ecclesiastical Rome,' as the figure of an aged decrepit woman, still showing traces of an imperial form and proud beauty. She sits on a fragment of a Corinthian capital in a half-crouching attitude, with her neck bent forward and scarcely able to support her still massive head. On the fringe of her richly classical robe are worked medallions, enclosing the emblems of Pagan Rome and designs of her most precious works of Art. By her side hangs a grinning, lecherous, sordid mask, of tragical look, sickly, cruel, and repulsive, which she has just pulled off her face. Her eyes glance slightly upwards under heavy eyebrows, peering out as if seeking what she cannot find, while gold coins fall from her left hand as it listlessly reclines on her lap. The motive of this striking allegory is based, as may be

readily seen, on the extreme Protestant view of the wretched condition to which the Papacy has reduced the once haughty mistress of peoples. In Miss Whitney's eyes she is a forlorn beggar among the nations, unmasked in her hypocrisies, bereft of her cunning and her strength, a spectacle at once to warn and repel mankind. One must have a cordial sympathy with the inspiring thought to approve of this startling composition. I refer to it only as a novel idea in Art largely conceived and appropriately carried out, barring a little anatomical crudity in a few points, scarcely to be noted on a general view.

It is worthy of mention that the American Government, in deference to the growing popular opinion of the fitness of women to do whatever men can rightly do, without requiring any more evidence of personal capacity than if it had been only a question of appointment to civil office, not long ago commissioned a girl in her teens to make a full-length statue of the late President Lincoln, entirely overlooking such claims as might have been urged by those artists of her sex who have actually studied Art.

Returning to the men, there is to be chronicled a most ambitious attempt on the part of Frank Pierce Connelly, now in Florence, to model a colossal group of five figures on a scale hitherto unattempted in any school. It represents the warlike virtues of Courage, Perseverance, and Strength, vainly contending with Death, a gaunt figure on horseback, whose career of slaughter is suddenly arrested and himself disarmed by a majestic being, which is called Honour. The application of the allegory is vague and general, but some suppose it to refer to the fate of the South at the close of the late civil war in America.

Thomas Gould, of Boston, but at present established in Florence, is another sculptor who seeks to divert the popular taste into a poetical channel, and to vindicate the rights of Art in the higher field of idealism. In modelling an *alto-relief* of the head of Hamlet's ghost, some may consider that Gould is straining a point in this direction. But it is so effectively done that we may accept this much of a ghost, if it do not provoke some less discriminating sculptor to attempt a whole shadowy figure. His latest work, 'Cleopatra,' makes as substantial an effigy of the seductive queen of Egypt in a physical sense as one can desire. Story's Cleopatra is the beautiful, accomplished, intellectual mistress of pleasure in a meditative pose, the paragon of feminine fascination. But Gould has ventured on the more dubious roll of presenting her at a moment when the strong tide of Oriental voluptuousness courses warmest through her veins. She becomes indeed the most passionate woman of history, whose name is a byword for the force of sensual attraction and dominion over men. Reclining with her head thrown back on an antique chair, in wanton relaxation of posture, decorously draped, but with the contours of her lovely limbs well accentuated, Cleopatra is rapt in a waking dream of ecstatic passion. Her features are sufficiently comely, but more American than Eastern in type. So intense is her feeling, she bends her right foot backwards, forcing a painful strain on the muscles of the instep, to obtain relief. There is a serpent-like elasticity and flexibility in the entire figure; but the outlines of the body and a portion of its anatomical physiognomy are not equal in grace and precision, and indeed voluptuous *abandon*, to the head, which is better modelled in every respect.

'The West Wind' is a more original

motive of a recent date by the same chisel. There is a breezy freshness of posture and airy lightness and flowing swell of gently stirred drapery, with a pleasing animation of features indicative of the balmy qualities of the wholesomest wind of the American continent, which particularly commend this idealisation to the fancy. It is now the property of Hon. Demas Barnes, member of Congress, from Brooklyn.

Florence.

J. JACKSON JARVES.

ART AND MANUFACTURE.

WE earnestly desire English manufacturers to consider the important condition of things that has supervened, to the possible great benefit of this country, as a consequence of the war on the Continent. In the history of the Arts and of Manufactures it is constantly apparent how vast is the influence of extraneous causes on the practice, the development, nay the very existence, of that skill which gives being to the imagery of genius. The rude hand of foreign conquest, the accession of a cultured man to power, political or religious turmoil, the accident of material wealth, have, in turn, crushed or banished Arts and Manufactures from their native countries, fostered them to glory, or brought about a migration of those who practised them; and with these have sometimes migrated the staples of national wealth. War often destroys the seed of what it feeds on. Now, happily, it is ridiculous as well as unnecessary to assume that Art or Manufacture is to be crushed in France or Germany, or alienated from those countries by the present war. But the operations of the disastrous struggle, and its exceptional conditions, place this country in an entirely new relation. In particular, a golden opportunity is afforded to the Art-manufacturers of Great Britain, of which they will, if they are wise, take every advantage. We are great and wealthy consumers; we are mighty producers; our inventive and initiatory power is remarkable; very few can justly impugn the excellent honesty of our work; yet, in respect of many productions, we are pushed even from our own markets by continental goods. The work is often of inferior fabric to ours, its lasting qualities not comparable; but it finds appreciation, and is adopted before ours; and even cheapness shown in the money charged by us does not equalise the contest. The fact is, that culture of public taste has outstripped the producer's progress. A carpet or other production is bought for its pattern or Art-ornament now, more than for its quality of fabric. Ugly, inartistic designs on the best of woven wool or silk, will not sell as beautiful and harmonious Art displayed on slighter or inferior material will. Those articles of French or German manufacture which command the markets here, do so by their artistic quality. That is, in nearly every instance, the essential difference; all the rest is generally within the English manufacturer's power. Any retailer who is brought into experience of the public taste can confirm this. The continental workman has means of technical education in Art, and traditions of Art; the English workman is too frequently only—a workman. At the present time the productiveness of the two principal sources of this competitive supply is paralysed, Paris has been for some time quite isolated, its trade destroyed, and its manufacturing power diverted into strange channels, where it has not been annihilated. The French provinces are in degree disorganised, drained of their workmen, and but little, if anything, is being created in the *ateliers*, or the workshops. The producing power of the North German Confederation, and of its Southern allies, in like manner is almost at a stand-still; for most of the men are drawn to the war; and France commands at sea. This has been the case for several months. Thus, whatever may be the present stock in this country of all those beautiful artistic manufactures we are accustomed to purchase from these continental markets, and whenever peace may

be declared, a time will shortly come when a break in the continuity of the supply will be manifest. A dearth will ensue. Our rivals and competitors will for a time at least be practically removed. The British manufacturers will be expected to step into the gap. This will be their opportunity to regain vantage-ground they have lost, or to occupy positions they have never yet won. It behoves them to prepare earnestly, and on true principles, to reap all the advantage from a conjuncture that may never be presented to them again.

There should be no hesitation in grappling with the difficulty. The desideratum is Art-power, and manufacturers should seek the aid of the best artists; not of pretenders, or of men nurtured on barren trade-expediency, but of the greatest men. No really great artist is above applying his genius to even small objects of ordinary usefulness. Flaxman was not; Cellini could produce the *Perseus*, and work a cup or a spoon till each was radiant with the beauty of his noble power. In the Renaissance a marvellous race of great men arose, great enough to reverence Fine Art so that the most stupendous monuments, wonders of the world, were conceived by the same brain, and wrought by the same hand that designed and executed the smallest decorations, domestic articles, and personal ornaments. Their productions were successful then, as they are valued now. It is a false dictum that such Fine Art is above the market, does not pay. True Art is of commercial value. We do not ask for expensive artistic aspirations at the cost of utility. What is made must be made to sell as the continental goods sell. That is a condition precedent. Producers are not urged to venture on untrodden ground, but to continue achievement. We deny that in order to sell, or to be marketable, it is necessary for any article, elaborate or simple, to pander to bad taste, rather than to enrich and satisfy good taste, and to instruct the bad. People of no refined discrimination at all do not object to beautiful things, as such, if they are equally useful or serviceable. Common plates and jugs of artistic form and decoration sell to-day quite as well as the old hideous patterns on delf, now so seldom seen even in the poorest shops, used to do before 1851. English goods should be made to tempt and lead the public taste, not to lag after it, while foreign rivals supplant them. We have among us practical ornamentists of established artistic eminence and power; and henceforth works of Art-manufacture will most properly be officially recognised on their artistic merits to rank with the proudest triumphs of pictorial or plastic Art. In the approaching series of annual International Exhibitions a carpet or other manufacture, for example, that displays true beauty of design, or exquisite artistic colouring, will be recognised as fitting to win its way to exhibition, as a work of Fine Art, the same as a painting or a statue. The most enlightened manufacturers are already aware of the value of true Art on their productions, and can quote from an untaught experience as to how true a mistress real Fine Art is. An exceptional opportunity now serves that may be used with infinite advantage by all the producers concerned with the practical application of Art to Manufactures in this country. It is obvious that our advice includes the employment of such artists and artisans as the depressed state of the Arts both in Germany and France may bring to our shores.

ART IN THE PROVINCES.

BRISTOL.—We have had shown to us a very elegant casket which, with a suite of valuable jewellery, was recently publicly presented to Mrs. S. P. Hare by—as a local paper expresses it—"The Conservative women of Bristol, as an expression of their high opinion of the unwearied exertions of Mrs. Hare in the cause of 'Church and Queen' during the candidature of her husband, in March and June last, for the representation of the city in the constitutional interest." The casket is the work of Messrs. C. and W. Trapnell, of Bristol, executed from the

design of the former artist, who modelled the principal parts. It is made of oak taken from Redcliff Church, and is enriched with graceful carvings in pear-tree, boxwood, and ebony, the details of which would occupy more space to enumerate than is at our disposal. It must suffice to say that the entire work is most creditable to Messrs. Trapnell, who produced the casket, also containing jewellery, presented some time ago by the inhabitants of Bristol to the Princess of Wales.

CAMBRIDGE.—The vacant niches in the new buildings of Gonville and Caius College are now occupied by life-size statues, of stone. Immediately over the entrance from King's Parade stands that of Dr. Gonville, who founded the college in 1348: on one side of him is the statue of Dr. Bateman, Bishop of Norwich, Gonville's executor, who, in 1353, established the college on the site of the present Gonville court; on the other side of Gonville is the statue of John Caius, M.D., the third founder, as he is called, who, in 1558, obtained the royal charter by which the former foundations were all confirmed, and his own foundation was established. By this charter the college was thenceforth to receive the name of Gonville and Caius College. The two last-mentioned figures are in a more elevated position than the central: all are bracketed out, and surmounted by canopies. Within the court, adjoining the turret-staircase, appears a statue of Dr. Perse, a liberal benefactor to the college.—In the new chapel of St. John's College has been placed a statue of Bishop Stillingfleet. The whole of these figures are by Messrs. Farmer and Brindley, of London.

LIVERPOOL.—When Dr. McNeile was made Dean of Ripon, a large number of his admirers in Liverpool subscribed to erect a statue of him in the town. Mr. G. G. Adams was commissioned to execute the work, and completed it. Very recently the statue was offered to the town council, to be placed in St. George's Hall; but the proposal not meeting with unanimous approval, the offer was withdrawn for a time. At a subsequent meeting of the council it was accepted by a considerable majority of members.

SALISBURY.—The recent exhibition of English porcelain and pottery in the museum of this city was followed by one of drawings by the old masters—a rare and valuable collection of such works having been contributed by collectors residing in the locality.

ART IN CONTINENTAL STATES.

MONTREAL.—A 'Summer View of Mount Orford and Pond, Eastern Townships,' is the subject of an able painting by Allan Edson, an artist who has made considerable progress in his profession within the last few years. The mountain, looming in the distance, is almost enveloped by a mist, its summit only being visible. The pond forms the foreground, and on the left bank are beautifully mirrored the forest glories which adorn its margin. Here is also visible a splendid study of rock with stunted herbage. The sunlight is very effective, and altogether the picture is "nature in her own unexaggerated richness." As Edson is yet only a young painter, we yet hope to hear of him "making his mark" in the Art-world.—Mr. James Inglis, photographer, of Montreal, has on exhibition a large and attractive picture representing the recent meeting, in St. Paul's Church, of the joint committee of the Presbyterian Church in the Provinces of British North America on the subject of Union. The grouping is excellent and also the management of the light. The heads in the foreground are chiefly profiles, and present striking likenesses of several leading Presbyterian ministers of this city.—An excellent picture by W. Raphael, entitled 'Habitants attacked by Wolves,' has been reproduced in chromo-lithograph by a firm in this city.—Mrs. Marshall Wood's statue of the Queen was exhibited to H.R.H. Prince Arthur and suite previous to their departure from Canada; but since then we have neither seen nor heard anything of it. Surely when Canadians subscribe liberally for a work of Art such as this, it ought not to be put out of the way.

THE
STATELY HOMES OF ENGLAND.

(OCCASIONALLY OPEN TO THE PEOPLE.)

"The stately homes of England,
How beautiful they stand!
Amidst their tall ancestral trees,
O'er all the pleasant land."

MRS. HEMANS.

By S. C. HALL, F.S.A.

THE ANTIQUARIAN NOTES AND DETAILS
BY LLEWELLYN JEWITT, F.S.A.

HADDON HALL.



HADDON HALL is, perhaps, the most interesting, and is certainly the most attractive, of all the ancient mansions of England; and none have been so fertile of material to Artists. Situate in one of the most picturesque, if not the most beautiful, of our

English Shires; absolutely perfect as an example of the Baronial Halls of our ancestors, and easily accessible by charming routes from populous towns, it is not surprising that it should be visited annually by tens of thousands: and that in America it is regarded as

one of the places in the "Old Country," which no visitors, even of a week, to the classic land of their History, should neglect to see, examine, and describe.

It is strange that no illustrated Guide-book of this grand dwelling exists; although, as we shall show, it abounds in subjects for the pencil as well as the pen: the only descriptions attainable consist of a few meagre pages; and, no doubt, thousands who have seen old Haddon leave it with regret, that they can take with them no records to assist and refresh memory.

There are, indeed, photographs in abundance; * but some of the most striking "bits" the sun cannot reach to picture: to these it will be our especial duty to direct attention; and we hope, by carefully studying and describing every remarkable portion of the interesting structure, and by collecting and condensing all that can be known of its history, and that of the noble families who have been its possessors from the Conquest, to supply what every visitor needs—a "Companion" that shall be a sufficiently instructive Guide.

HADDON HALL is distant fourteen miles from BUXTON; perhaps the most fashionable, as it certainly is the most cheerful, and, we believe, the most healthful, of all the Baths of England. Its waters are as efficacious, in certain

* We are indebted to Mr. Frith, of Reigate, and to Mr. Keene, of Derby, for the aids we derive from photography. But our principal obligation, and that of our readers, is to Mr. Muckley, the master of the Art-school of Manchester. He placed at our disposal several sketches taken from various parts of the fine old structure: they exhibit the knowledge of the antiquary as well as the skill of the artist. Our debt is even larger to the accomplished authoress, Mrs. Everett Green, who made expressly for our use a number of sketches; which, together with much gathered information, she has generously placed at our disposal.

ailments, as are those of Southern Germany; while the surrounding district is so grand and beautiful, so happily mingling the sublime and the graceful, as to compete, and by no means unfavourably, with the hills and valleys that border the distant Rhine.*

The poet, the novelist, the traveller, the naturalist, the sportsman, and the antiquary have found appropriate themes in Derbyshire, in its massive rocks—"Tors"—and deep dells; its pasture lands on mountain slopes; its rapid, yet never broad, rivers—delights of the angler; its crags and caves; its rugged and ragged or wooded steepes; above all, its relics of the earlier days when Briton, Roman, Saxon, and Norman, held alternate sway over the rich lands and prolific mines of this lavishly endowed county; and of a later time, when shrewd monks planted themselves beside the clear streams and rich meadows, to which they bequeathed magnificent ruins to tell of intellectual and mate-

rial power in the time of their vigorous and prosperous strength.

Unequivocal evidence exists that the Romans knew the curative properties of the Baths at Buxton; and it is almost certain, from the many Celtic barrows and stone circles found in the neighbourhood, that a still earlier race was acquainted with them. Probably, therefore, for more than a thousand years Buxton has been one of the principal "health-resorts" of this island. Yet few remains of antiquity exist in the town. The dwelling—in which was lodged Mary, Queen of Scots, on her several visits, while in custody of the Earl of Shrewsbury, and to which "good Queen Bess," while sojourning at Kenilworth, sent the Earl of Leicester, that he might drink of the healing waters, "twenty days together"—was removed just a century ago: a handsome and very commodious hotel occupies the site: it is still called the "Old Hall;" and immediately behind it

GROUND AND GARDEN PLAN OF HADDON.

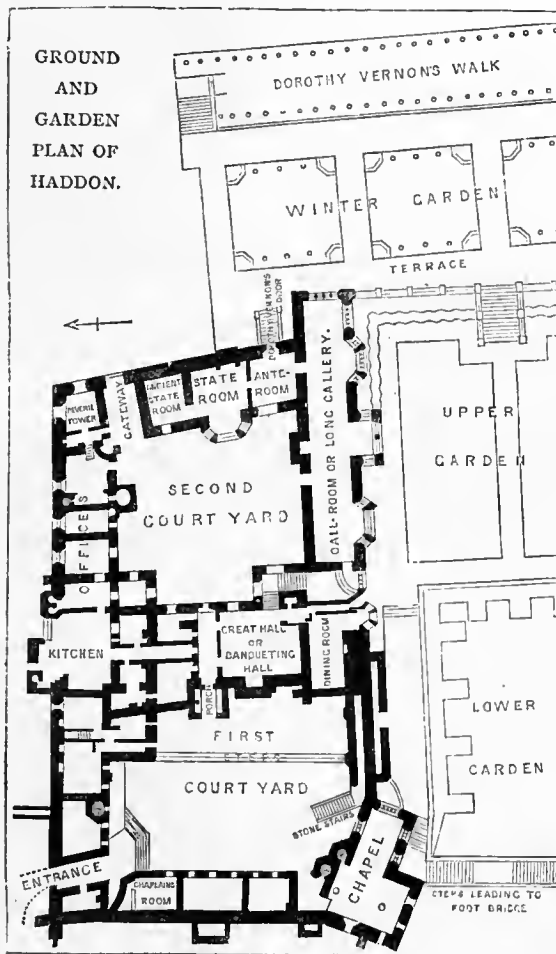

are the two springs—the Saline and the Iron—the Chalybeate and the Tonic. On a window-pane of one of the rooms in this Old Hall, Mary, Queen of Scots, is said to have scratched the following touching and kindly farewell—the pane of glass having been preserved until recent years:—

"Buxtona, quæ calidæ celebrare nomine lymphæ,
Forte mihi posthac non audeunda, vale!"

Cheerfulness is the handmaid of health; and although there are many patients in and about Buxton, they do not seem to suffer much: there are more smiles than moans in the Pump-

room; and rheumatism is not a disease that makes much outer show of anguish.

The public gardens, "laid out by Sir Joseph Paxton," at the cost of the Duke of Devonshire, are made pleasant by music and flowers. The air is genial and gentle, and yet "strong;" for Buxton is one of the most elevated of the towns of England. The baths are well-ordered and well-managed: the water, though it be "mineral," is as clear as crystal; and the draughts are to many as were those of the Pool of Siloam. We have written mainly of Buxton, for we owe it a debt of gratitude; but Haddon is within easy reach of Derby, Macclesfield, Stockport, Manchester, Sheffield, Liverpool, and Leeds. The records of "arrivals" show how numerous are the cities and towns that send invalids to its health-giving waters.*

* Buxton is distant 150 miles from London, 38 from Derby, 22 from Matlock Bath, 26 from Sheffield, 23 from Chesterfield, 20 from Ashbourne, 24 from Manchester, and 12 from Macclesfield.

We are not writing a guide to Buxton, or we might describe a score of objects, curious, interesting, and instructive, within a walk or a short drive of the town; to say nothing of its very comfortable hotels and lodgings, in sufficient abundance—except during “the season,” in the autumn of the year.

It would be difficult to find in any part of the British dominions a drive so grandly beautiful as that between Buxton and Haddon. Within half a mile of its centre is “the Duke’s Drive” (formed in 1795 by the then Duke of Devonshire): it runs through Ashwood Dale, Miller’s Dale, and Monsal Dale, passing “the Lover’s Leap” and “Chee Tor”—stupendous crags—from the crevices of which grow small trees—partially crowned with wood and covered with ivy, ferns, and lichens, groups of varied foliage intervening; with here and there umbrageous woods; and the river Wye—not the “sylvan Wye, thou wanderer through the woods,” of Wordsworth, but its namesake of lesser fame, that has its source a mile or two north of Buxton—journeying all the way, until at Rowsley it joins the Derwent (not the Derwent of the English lakes), from whence the blended waters, running by Matlock, Belper, and Derby, flow into the Trent, and so make their way to the sea.

To give a list of the several objects that delight the eye and mind during this comparatively short drive, would be to fill a page instead of a column. “The lowest part of the town of Buxton is one thousand feet above the level of the sea;” the naturalist, the botanist, and the geologist will find treasure-troves in any of the surrounding hills and valleys: while natural marvels abound, within a few miles, in all directions—such as Poole’s Hole, the Blue-John mine, the Ebbing and Flowing Well, and the Peak Cavern, with its summit crowned by the fine old castle of “Peveril of the Peak.” Majestic Chatsworth—to which, on certain days, the people are admitted, the park being at all times freely open to all comers—is distant about three miles from Haddon, across Manners Wood and intervening hills: in short, there are a hundred places of deep interest within a drive of Buxton, and, if it be a long drive, Dovedale—the loveliest dale in England—is easily reached; so, indeed, is far-famed Alton-Towers.

We pass, on our way to Haddon, through the ancient town of Bakewell, to the venerable parish church of which we shall, in due course, conduct the reader—for it contains the monuments of THE VERNONS—and, winding through a rich and very beautiful valley, we arrive in sight of Haddon Hall.

Before we enter the Old Hall, however, we must ask the reader to glance at another route to Haddon—that which he will probably take if his tour be made direct from London.

No doubt many visitors to Haddon will start from DERBY: and if the road from Buxton is charming, so also is that from the capital of the shire: it is more open; the vales are wider; the views are more extensive; there are the same attractions of hill and dell and rock and river; cottages embosomed in foliage; church steeples seen among richly-clad trees; clean and happy-looking villages; and distant towns, never indicated, except in one case—that of Belper—by the chimneys and sullen shadows of manufactories. For more than twenty miles, is a continuation of scenic loveliness, such as, in its calm and quiet charm, its simple grace, and all the attractions of home nature, can be found nowhere else in the wide world. We stay for a moment at the pleasant Junction of AMBERGATE; thence the railway runs by the picturesque village of Cromford, the creation of one great man, Sir Richard Arkwright; Matlock Bath, with its pretty villa residences peeping from woods that clothe Abraham’s heights; Matlock Bridge, whose hill-side is studded with hydropathic establishments; and Darley Dale, with its interesting old church, and grand old yew tree, the largest in the kingdom, until the train stops at—Rowsley.

“The Peacock” at Rowsley is one of the prettiest and pleasantest Inns in “all England:” neat, well-ordered, clean and comfortable, it

may be accepted as a model: it has ever been in high favour with “brethren of the angle”—long before the neat and graceful railway station stood so near it that the whistle of the train is audible a dozen times a day, and twice or thrice at night. The fine old bridge close at hand throws its arches across the Derwent;

neatly and gracefully trimmed gardens skirt the banks of that clear and bright river, into which flows the Wye about a furlong off; and rivers, meadows, rocks and dells, and hills and valleys “all round about,” exhibit to perfection the peculiarities of the vale, so rich in the beautiful and the picturesque. The Peacock is



HADDON: FROM THE MEADOWS.

the nearest inn to Haddon; and here hundreds of travellers from all parts of the world have found, not only a tranquil resting-place, but a cheerful home.* We have thought it well to picture it, and have placed at its doors one of the waggonettes that drive hither and thither from Buxton, and other places; and the tourist may rest assured that this pretty inn is indeed

a place at which he may “rest, and be thankful.”*

At Rowsley the tourist is but three miles from Chatsworth, and two miles from Haddon. A pleasant walk through the valley brings him in sight of Haddon Hall; and from this road he obtains, perhaps, the best view of it. Partly hidden, as it is, by tall and full-leaved trees, its



HADDON: FROM THE ROWSLEY ROAD.

grandeur is not at once apparent; but the impression deepens as he ascends the steep

pathway and pauses before the nail-studded door that opens into the court-yard.

* A very pretty little book, entitled “The Peacock at Rowsley,” has been published by its author, J. J. Briggs, Esq. As the journal of a naturalist, an angler, and a lover of nature, it is so sweetly written as to place its author, as a worthy associate, side by side with dear “Old Isak” or “White of Selborne.”

* An album, kept at the inn, contains many distinguished names: among them is that of the poet Longfellow; also the (travelling) name of Maximilian, sometime Emperor of Mexico, who spent here the last night of his sleep in England, previous to embarkation on his fatal voyage.

Before we proceed to describe the HALL, however, we shall give some account of its earlier owners—the VERNONS—reserving for an after-part the history of their successors, the illustrious family of MANNERS, from their origin, as knights, to the period of their high elevation, as Earls and Dukes of Rutland, and so down to the present time.

The history of Haddon, unlike that of most of our ancient baronial residences, has always been one of peace and hospitality, not of war and feud and oppression; and however much its owners may, at one period or other, have been mixed up in the stirring events of the ages in which they lived, Haddon itself has taken no part in the turmoils. It has literally been a stronghold: but it has been the stronghold of home and domestic life, not of armed strife.

At the time of taking the Domesday survey, when the manor of Bakewell belonged to, and was held by, the king, Haddon was a berewite of the manor; and there one carucate of land was claimed by Henry de Ferrars.* Over-Haddon, a village two or three miles off, on the hills, was also another berewite of the same manor. To whom Haddon belonged in the Saxon period is not clear; the first owner of which there is any distinct knowledge is this Henry de Ferrars, who held it in 1086, and who, by grant of the Conqueror, had no less than 114 manors in Derbyshire alone; he built Duffield Castle; and founded the Church of the Holy Trinity, near the Castle of Tutbury.

Haddon was at a very early period, held, it is said, by tenure of knight's service,† by William Avenell, who resided there, and was possessed of much land in the neighbourhood. Soon after the foundation of Roche Abbey, in 1147, William de Avenell, Lord of Haddon, gave to that establishment the grange of One-ash and its appurtenances. One of the daughters and co-heiresses of William de Avenell, Elizabeth, married Simon Bassett, of the fine old family of Bassett, owners of much property in this and the neighbouring counties; the other married Richard de Vernon; and thus Haddon passed into that noted family, of which we proceed to give some particulars.

The House of Vernon is of very considerable antiquity, and derives its name, as do many others in the Baronage of England, from its primitive domicile in Normandy—the *Châtellenie* of Vernon, forming one of the territorial sub-divisions of that country: the castle, with its hereditary lords, is recorded in the Anglo-Norman chronicles. According to the present territorial division of France, Vernon is a commune in the *Département de L'Eure* and *Arrondissement d'Évreux*; and as being the *chef-lieu*, gives name to the Canton in which it is situate. From this locality, one of the most picturesque and luxuriant of the vine districts, the family of Vernon takes its origin; and also the ancient family of De Redvers—the two families, indeed, being originally identical, the name of De Redvers having been assumed by a Vernon in the eleventh century, from the place of his residence, Réviere, in Normandy: his family were "Comtes de Révieres and Vernon, and Barons de Néhou;" both families tracing from the d'Ivry stock. Mauriscus d'Ivry (father of Robert d'Ivry), who was father of Alselin Goël—the names of whose sons, Roger Pincerna, surnamed the "stammerer," Lord of the Castle of Grosseuvre; William Lupellus (Lovel), who acquired the castle of Ivry on the death of his elder brother; and Robert Goël—are well known in history; the one as holding the Honour of Ivry in right of his descent from Count Ralph, uterine brother of Richard I., Duke of Normandy; another as the founder of the family of Lovel; and the third as having held his castle of Grosseuvre against King Stephen; he had a son, Baldwin, who took the surname of De Revers from the place of his residence; and two generations later, William, the son of Richard, assumed the name of Vernon, from the *Châtellenie* of that name which he held. His son,

Hugh de Revers, or Vernon, usually called Hugh de Monachus, had a son, William de Vernon, Lord of Vernon, who founded the Abbey of Montebourg. By his wife, Emma, he had issue, two sons, Walter and Richard: the latter of whom, Richard de Redvers (as the name became afterwards spelled), or Vernon, came over at the Conquest, and was created

Baron of Shipbroke in Cheshire. He married Adeliza, daughter of William Peverel of Nottingham, and received with her in frank-marriage—that is, a free gift of an estate given with a wife on her marriage, and descendable to their joint-heirs—the manor of Wolleigh, Buckinghamshire. One of these sons, Baldwin de Redvers, was created Earl of Devon, and from

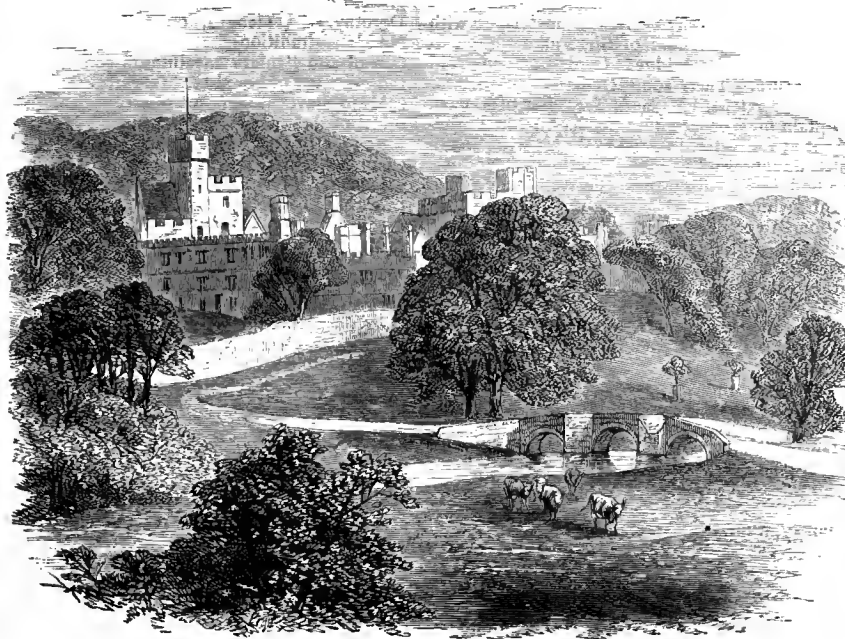

HADDON: FROM THE WYE.

him descended the line of earls of that name; while William de Redvers, who inherited the Norman baronies of Vernon, Révieres, and Néhou, re-assumed the surname of Vernon from those possessions. He had an only son and heir, Hugh de Vernon, Baron of Shipbroke, who married a daughter of Raynold Badgioll, Lord of Erdeswicke and Holgrave. By this

lady he had a numerous issue: the eldest, Warin, continuing the barony of Shipbroke; Matthew, inheriting the lordships of Erdeswicke and Holgrave, who was ancestor of the Vernons of those places; and Richard, already alluded to. This Richard de Vernon married Avice, the daughter and co-heiress of William de Avenell, Lord of Haddon; his



HADDON: THE MAIN ENTRANCE.

other daughter and co-heiress marrying Sir Simon Bassett. By marriage with this lady Richard de Vernon acquired Haddon and other estates, and thus became settled at Haddon Hall. He had issue, an only daughter and heiress, who married Gilbert le Francis; and their son, Richard le Francis, took the name of Vernon, on coming into the property, and

settled at Haddon. He married Mary, daughter of Robert, Baron of Stockport. His descendant, Sir Richard Vernon, Lord of Haddon and of Appleby, &c., married Maud, daughter and co-heiress of William de Camville, by whom he had an only son and heir, William Vernon, who was only ten years of age at his father's death in 1422, when he was found heir

* Berewite, in Domesday, means a small village; and carucate as much land as one plough can till.

† The obligation to serve as a knight in the wars of the feudal superior.

to his grandfather. In 1330 he obtained a grant of free warren, or the exclusive right of killing beasts and birds of warren within prescribed limits in the royal forests, &c., from the king. He married Joan, daughter of Rhee, or Rhis, ap Griffith, and heiress of Richard Stackpole, and had issue by her Sir Richard Vernon, Knt., of Pembrugge (sometimes called Sir Richard de Pembrugge), Lord of Haddon and Tonge, which latter lordship he acquired by his marriage with the sister and heiress of Sir Fulke de Pembrugge, or Pembridge, Lord of Tonge in Shropshire. Their son, Richard Vernon, was father of Richard Vernon, Treasurer of Calais, Captain of Rouen, and Speaker in the Parliament at Leicester, in 1426. By his wife, Benedict, daughter of St. John Ludlow of Hodnet, he had issue, with others, Sir William Vernon, Knt., who, marrying Margaret, daughter of Sir Robert Pype of Spurnore, acquired that manor and lordship. He was buried at Tonge, where a monument was placed to his memory: another being erected at Montebourg.

His son, or grandson, Sir Henry Vernon, was made governor to Prince Arthur, by King Henry VII., with whom he was a great favourite. He married Anne, daughter of John, second Earl of Shrewsbury, by Elizabeth Butler, daughter of James, Earl of Ormond. By this marriage he had issue, Sir Henry Vernon, High Steward of the King's Forest in the Peak by Henry VIII., and who also held many other posts. He had issue, two sons, Sir George Vernon and Sir John Vernon. Sir Henry died in 1515, and was succeeded by his eldest son, Sir George, "the King of the Peak," who succeeded to the Haddon and other estates. The younger son, Sir John Vernon, married Helen, daughter and co-heiress of John Montgomery, of Sudbury, in Derbyshire, with whom he received the Sudbury and other estates, and thus founded the family of Lords Vernon, of which family the present noble peer, Lord Vernon, is the representative. Of this branch of the family we may have occasion to speak hereafter.

We return to the "King of the Peak"—Sir George Vernon—and his heiresses. He succeeded to the estates in 1515, and at the time of his death, in 1567, was possessed of no fewer than thirty manors in Derbyshire alone. He was married twice: first to Margaret, daughter of Sir Gilbert Taylebois, Knt.; and secondly to Maude, daughter of Sir Ralph Langford. He had issue, two daughters, his co-heiresses, Margaret and Dorothy, whose husbands inherited his immense possessions. Margaret Vernon married Sir Thomas Stanley, Knt., of Winwick, in Lancashire, second son of Edward Stanley, third Earl of Derby; and Dorothy Vernon, whose name has become "a household word" in this locality, married Sir John Manners, Knt., second son of Thomas Manners, first Earl of Rutland, and direct ancestor of the present Duke of Rutland. To this branch we shall, in another chapter, have to refer at greater length.

Sir George Vernon lived at Haddon in such a style of princely magnificence and hospitality as to earn for himself the title of "King of the Peak." It is said that he was generous and hospitable, as well as just, and that he lived and died in the "good esteem" of all men. Sir George Vernon was buried in Bakewell Church, where a remarkably fine and well preserved altar-tomb bears the recumbent effigies of himself and his two wives.

Dorothy Vernon, the youngest daughter and co-heiress of Sir George, and over whom such "a halo of romantic interest" rests, is said to have been one of the most beautiful of all beautiful women, and possessed of so sweet a temper, that she was idolised by all who knew her. If it were so, however, the monument at Bakewell does not fairly represent her, for it exhibits her with an expression of countenance far from either amiable or attractive. The story of her life, according to popular belief, is that, while her elder sister, fortunate in an open attachment to Sir Thomas Stanley, the son of the Earl of Derby, and his affianced bride, was petted and "made much of," she, the younger, was kept in the background

having formed a secret attachment to John Manners, son of the Earl of Rutland—an attachment which was opposed by her father, sister, and step-mother; she was, therefore, closely watched and kept almost a prisoner. Her lover is said to have disguised himself as a woodman, or forester, and to have remained in hiding in the woods around Haddon for several weeks, in order to obtain stolen glances of, and occasional brief meetings with, Dorothy. At length, on a festive night at Haddon—tradition states it to have been on one of the "merry meetings," consequent on the marriage of her sister Margaret—Dorothy is said to have stolen away unobserved in the midst of the merriment in the ball-room, and to have quietly passed out of the door of the adjoining ante-room on to the terrace, which she crossed, and having ascended the steps on the other side, her lover's arms received her; horses were in waiting, and they rode off in the moonlight all through the night, and were married in Leicestershire the next morning.

("They'll have swift steeds that follow,
Quoth the young Lochinvar.")

The door through which the heiress eloped is always pointed out to visitors as "Dorothy Vernon's Door."

Thus the Derbyshire estates of Sir George

Vernon passed to John Manners, and thus it was the noble house of Rutland became connected with Haddon and the county of Derby.

John Manners, the husband of Dorothy Vernon, was knighted shortly after his marriage. They had issue three sons: Sir George Manners, who succeeded to the estates; John Manners, who died in 1590, aged 14; and Sir Roger Manners of Whitwell, who died in 1650; also one daughter, Grace, who became the wife of Sir Francis Fortescue. Dorothy died in 1584, and her husband in 1611. They were both buried in Bakewell Church, where their monument will no doubt be looked upon with interest by all visitors to the district.

Haddon continued to be one of the residences of this branch of the Manners family, ennobled in 1641 by the inheritance of the Rutland peerage, until they quitted it in the early part of the last century for Belvoir Castle of which we shall, on a future occasion, take note.

Concerning the family Manners we reserve our remarks for the next chapter, and proceed to a description of Haddon.

The HALL stands on a natural elevation—a platform of limestone—above the eastern bank of the Wye: the river is crossed by a pretty, yet venerable, bridge, passing which, we are at the foot of the rock, immediately



HADDON: THE FIRST COURT-YARD.

fronting the charming cottage which is the lodge of the custodian who keeps the keys. In the garden we make our first acquaintance with the boar's head and the peacock-shaped from growing yew trees—the crests of the families whose dwelling we are about to enter. This cottage adjoins the old stables; their antiquity is denoted by several sturdy buttresses. To the right of the great entrance-door are the steps—placed there long ago—to assist ladies in mounting their steeds, when ladies used to travel sitting on a pillion behind the rider: the custom is altogether gone out; but in our younger days, not only did the farmer's wife thus journey to market, but dames of distinction often availed themselves of that mode of visiting, carrying hood and farthingale, and hoop also, in leathern panniers at their sides, and jewels for adornment in caskets on their laps.

The visitor now stands before the old gateway, with its massive nail-studded door, and will note the noble flight of freestone steps, where time and use have left the marks of frequent footsteps. Indeed, the top step—just opposite the small entrance wicket in the larger door—is actually worn through in the shape of a human foot. He will also notice the extreme beauty and elegance of design of the Gothic architecture of this part of the building, and the

heraldic bearings with which it is decorated. Beneath the entrance archway on the right is the guard-room of the "sturdy porter" of old times: his "peep-hole" is still there, the framework of his bedstead, and the fire-place that gave him comfort when keeping watch and ward.

After mounting the inner steps, the visitor passes into the first court-yard, and will not fail to notice the remarkable character of the splaying and chamfering of the building in the angle over the inner archway.*

We are now in the lower court-yard, and at once perceive that Haddon consists of two court-yards, or quadrangles, with buildings surrounding each. Immediately opposite the gateway are the stone steps that lead to the state apartments; to the right is the chapel, and to the left, the HALL proper, with its minstrels' gallery and other objects of curious—some of unique—interest; all of which we shall treat of, in due course. The general arrangement will be best understood by the ground-plan, which, however, requires some explanation.

On account of the abruptness of the slope on which Haddon is built, it stands so unevenly, that a horizontal line drawn from the ground

* This is partially at least occasioned by the winding of a double spiral stone staircase leading to the tower over the entrance archway.

in the archway under the Peverel Tower would pass over the entrance archway. Consequently, that archway, the porter's lodge, and entrance to the spiral staircase on its right hand, and on the left the two rooms entered from the walk behind the partition wall, and before mounting the steps, form, what may, looking at it in that light, be called a basement story, to which also belongs the cellar, entered by a flight of fourteen steps descending from the buttery. Lysons, in his "Magna Britannia," vol. v., engraves—first, a basement plan, comprising the entrance archway and the low rooms above alluded to; second, a ground plan; third, a plan of the upper floor, including the ball-room and other state rooms; and the numerous bed-rooms and other apartments on the north and west sides. These plans are extremely correct and minute: it transpires from letters in the Lysons' correspondence (Addit. MS. 9423, British Museum), that they were made by the surveyor of the late duke, to illustrate a little privately-printed account of Haddon, written by himself, and were lent to Lysons for his work by D'Ewes Coke, Esq., barrister-at-law, then steward to the duke. The designations given by Lysons to the apartments are therefore probably correct. From his lists, and a curious



THE FONT.

catalogue of the apartments at Haddon, date 1666, we gather the general inference that the rooms on the west side of the lower court were, in the latter days of its occupation, occupied by the officials of the household; those on the entire south side were the state rooms; those on the east side of the upper court were the family apartments—the bed-rooms extending down to the intersection of the lower court; those over the front archway, &c., were the nursery apartments; and the library is believed to have occupied the rooms between these and the entrance tower.

There are second-floor apartments, not planned in Lysons, over the Peverel Tower and its adjoining rooms, and over one half of the north side, from that tower to the junction of the courts. Also solitary second-floor rooms in the Entrance Tower, Central Tower, and over the staircase leading to the ball-room. There is but one third-floor room, it is in the Eagle Tower, and is the highest apartment in the Hall.

The plan we engrave will be found the most useful to visitors. It gives the ground-plan irrespective of levels (which would only be bewildering to the tourist), with the exception of the slightly elevated ball-room and state-rooms in the upper court-yard. In fact, from even these being entered from the terrace, the

whole of the plan we have prepared may, for general purposes, be said to be that of the ground-floor.

On the east side there are but slight differences between the ground-floor and first-floor rooms, excepting those over the kitchen and adjoining offices, and over the central archway. On the south side the differences are material. The ball-room covers six ground-floor cellar-rooms. The drawing-room is over the dining-room; and the earl's bed-chamber and other rooms are over the long narrow ground-floor passages between that and the chapel. On the west side also the arrangement differs considerably.

Some portions of the building are of undoubted Norman origin, and it is not unlikely that even they were grafted on a Saxon erection. Norman remains will be noticed in the chapel, and, therefore, it is certain that that portion of the building, as well as others which could be pointed out, are the same as when the place was owned by the Peverels and Avenells. Before the year 1199, John, Earl of Mortaigne, afterwards King John, by writ directed to his justices, sheriffs, bailiffs, ministers, and all his

lieges, granted a license to Richard de Vernon to fortify his house of Haddon with a wall to the height of twelve feet, without kernel (or *crenelle*, which was an open parapet or battlement with embrasures or loop-holes to shoot through), and forbidding his being disturbed in so doing. This interesting license, now in possession of the Duke of Rutland, is as follows:—"Johannes com. Moret. justic. vicecom. baillivis. ministris, et omnibus fidelibus suis salutem. Sciatis me concessisse et licenciam dedisse Ric. de Vern. firmandi domum suam de Haddon, muro exaltato xij pedibus sine kernello, et idem prohibeo nequis vestrum cum inde disturbet. Test. Rob. de Mara apud Clipeston." It is endorsed "Breve patens Com. Johannis."

The earliest portions of the buildings of Haddon now remaining appear to be a part of the chapel, and lower portions of the walls of the south front, and of the north-east tower. To the next period, from 1300 to about 1380 (according to Duesbury), belong the hall-porch, the magnificent kitchen and adjoining offices, the great, or banqueting, hall, the lower west window of the chapel, part of the north-east



HADDON. THE CHAPEL.

tower, and part of the cellarge under the long gallery. In the third period, from about 1380 to 1470, were added the east, and part of the west end of the chapel, and the remaining buildings on the east side of the upper court-yard. The fourth period, from 1470 to 1530, comprises the fittings and interior finishings of the dining-room, the western range of buildings in the lower court, and the west end of the north range. The fifth period, from about 1530 to 1624, seems to comprise alterations in the upper court-yard, the long gallery, and terrace and gardens; the pulpit, desk, and pews in the chapel; and the barn and bowling-green. The juxtaposition of the kitchen and great hall show that they belong to the same period. The alterations since that period appear mainly to have been necessary repairs.

The principal apartments of Haddon Hall are the Chapel, the Great, or Banqueting, Hall, with the Minstrels' Gallery running round two sides of it; the Dining-room; the Drawing-room; the earl's Bed-room and adjoining suite of rooms; the Ball-room, or Long Gallery; the Ante-room, from which Dorothy Vernon's door

opens on to the terrace; the State Bed-room; the ancient State Room, or Page's Room; the Kitchens; and the Eagle, or Peverel Tower.

The first room usually shown to visitors is the so-called CHAPLAIN'S ROOM, the first door on the right, after mounting the steps into the lower court. In this small room, and in the closet attached to it, several objects of interest are preserved. Among these are a pair of remarkably fine fire-dogs, a warder's horn, gigantic jack-boots, a thick leathern doublet, some matchlocks, and some pewter dishes. In this room, a few years ago, a remarkably curious and interesting washing-tally, engraved and described in the "Reliquary," was found behind the wainscoting. The articles enumerated on this curious relic are "ruffles," "bandes," "cuffs," "handkercher," "eapps," "shirtes," "halfshirts," "boote hose," "topps," "sockes," "sheetes," "pillowberes," "tableclothes," "napkins," and "towells." It is in the possession of the Duke of Rutland.

The description of the remaining rooms, the lawns, and gardens, of HADDON HALL, we reserve for another chapter.

CELEBRATED CHURCHES OF EUROPE.

No. XI.—ST. ETIENNE, VIENNA.



HE march of the legions of ancient Rome prepared the way for the introduction of Christianity into almost every region where they penetrated. The earliest missionaries of the religious faith that supplanted Paganism who reached the banks of the Danube, stopped at the little village of Vindebona, a Roman station, though of comparatively small significance: here the Emperor

Marcus Aurelius died, B.C. 180. On its site now stands the imperial city of Vienna, which has for its principal church the Cathedral of St. Etienne, or St. Stephen's, an edifice described as combining "all that is lofty, imposing, and sublime, in the Gothic style of architecture," and forming a kind of central point from which most of the leading streets of the city radiate.

In the year 784, Austria had become a province governed by a margrave, the first prince being Leopold of Babenberg, whose descendant, the Margrave Henry II., surnamed Jasomirgott, laid the first foundations of the Church of St. Etienne, in 1144: it was consecrated three years afterwards

had frequently yet unsuccessfully, solicited the Roman pontiff to make Vienna the seat of a bishop: this was at length done by Sixtus IV., who appointed St. Etienne to be the cathedral. In 1722, Pope Innocent III. made Vienna an archbishopric.

The cathedral is built in the form of a Latin cross. The principal tower, with its spire, was commenced in 1359, from the designs of an architect, named Wenzel, of Klosterneubourg, but he lived to see only two-thirds of its height completed, in 1404: the work was carried on by Pierre Brachawitz till 1429, when he died. Jean Buchsbaum had the honour of finishing it in 1433, seventy-four years from its foundation. This tower has always been regarded as a *chef-d'œuvre* of Gothic architecture, for its just proportions, lightness, and elegance of design: it diminishes gradually from base to summit in regularly retreating arches and buttresses: the height is 465 feet.

Five doors form the principal entrances to the edifice: the chief of these, namely, the western entrance, is seen in the engraving: it is called "The Giant's Doorway," and shows all the characteristics of the Romano-Byzantine architecture in vogue during the twelfth century. The other doorways are disposed in a manner to break, by their ornate architecture, the long lines of the sides of the building.

The interior of the metropolitan church of Vienna is simple and majestic, though its appearance is somewhat gloomy. The pillars of the choir show this peculiarity: they are arranged to receive six statues. The stained-glass windows are in no degree inferior to those for which Germany has long been famous. All the altars are of marble, and each one is surmounted by some picture from the hand of a master. The pulpit is a beautiful example of ornamental sculpture: on the sides are busts of four distinguished doctors of the Latin church, surrounded by delicate mouldings, foliage, and floriated borders: the base is composed of small columns elaborately ornamented with carved work; twenty small statuettes, elegantly sculptured, are placed in tracery niches. The canopy is of wood, also richly decorated with representations in bas-relief of the Seven Sacraments, and underneath are winged cherubs. Following one of those caprices often seen in works of the Middle Ages, there is carved on one of the steps, or stairs, a figure with a cap on his head, and a compass in his hand: it is supposed to represent the sculptor; but, as a writer observes, history has not preserved his name, in order to punish his vanity. Some have considered it to be a portrait of Jean Buchsbaum; others, that of Anton Palgram, a sculptor and architect employed on the sacred edifice. The same bust appears under the organ. The pulpit was erected in 1430, and from it St. John Capistran is said to have preached a crusade against the Turks in 1451.

The stalls in the choir are worthy of special observation: they are eighty-six in number, and most elaborately carved. The baptismal fonts, of the date of the fifteenth century, are also very fine. We may add, as a concluding remark, that at a considerable elevation in the north-west angle of the lofty tower "is shown the stone bench from which Count Stahremberg, the brave governor of Vienna during the last siege by the Turks, used to reconnoitre their camp; as an inscription placed over the spot bears witness. From this post he first descried, on the morning of Sept. 12, 1683, the Christian banner of John Sobieski unfurled upon the Kahlenberg."

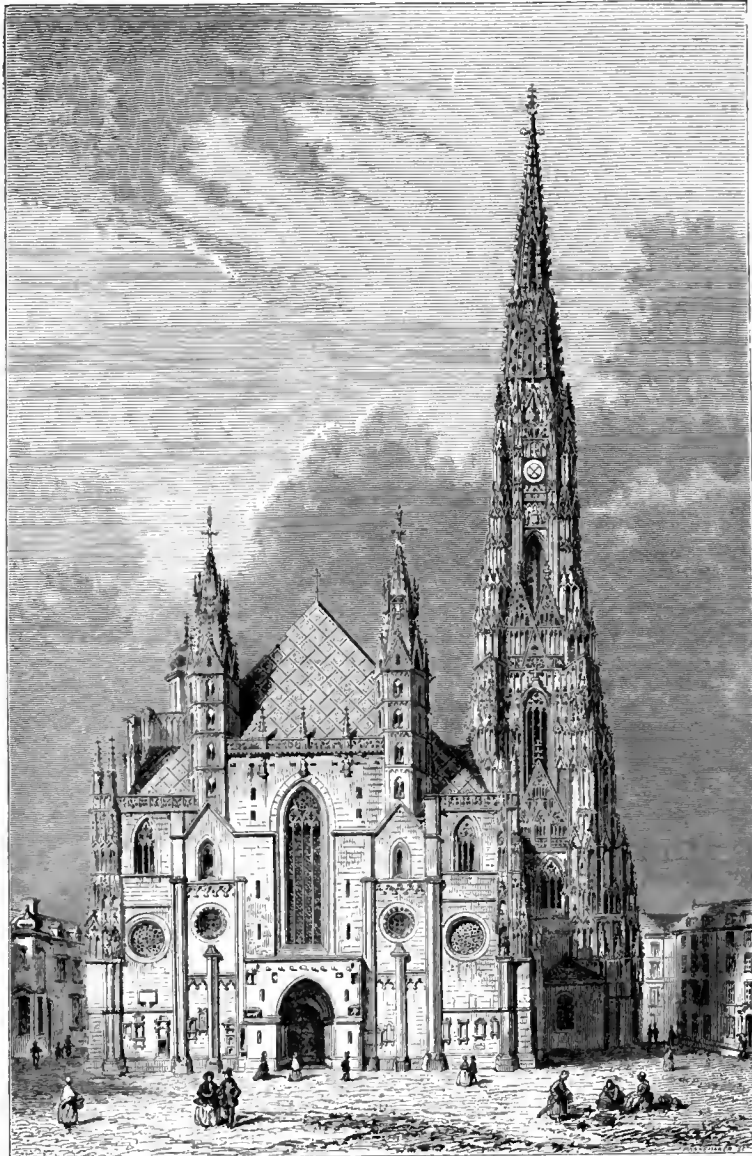

by Reimbert, Bishop of Passau, but was nothing more than a simple parish-church. In 1258, and again in 1265, fires destroyed the edifice, all but the western porch, which remains to testify to the talents of the architect, Octavian Falckner, or Jalkner, of Cracow. About the middle of the thirteenth century Vienna had passed into the hands of Ottocar, son of Wincenlaus, King of Bohemia: this prince exerted himself to repair the injury done to St. Etienne by the conflagration of 1265, and succeeded to a considerable extent; but within a few years Rudolph of Hapsbourg, who had been elected Emperor of Germany, claimed

from Ottocar restitution of Austria and other portions of the adjacent territories. On his declining to deliver them up, Rudolph laid siege, in 1276, to Vienna, which almost immediately surrendered; when the emperor entered the city, and celebrated his triumph with great pomp in the Church of St. Etienne.

Between this date and the middle of the fifteenth century very considerable additions were made to the church; for, although a canonical chapter was attached to the edifice, it was still only a kind of parochial church. Austria had now been elevated to a dukedom, and the dukes of the territory

No. XII.—THE ABBEY CHURCH OF ST. DENIS.

SITUATED about five miles from Paris, is the suburb of St. Denis, which dates its rise from the tomb of the saint and martyr whose name it bears—Denis, or Dionysius, the first bishop of Paris, whose remains, with those of two other Christian ecclesiastics who had also suffered martyrdom, were, according to tradition, buried secretly in the middle of a field, and over them a modest tomb was subsequently placed. Soon a small, but richly-decorated, basilica was erected on the spot: this gave place, in the fifth century, to a temple, of which St. Gregory of Tours praises the magnificence. The glories of these two churches were, however, eclipsed by that built by Dagobert I., in the seventh century, who spent very considerable sums on its decorations. Crowds of pilgrims were accustomed to visit the shrine of the martyrs, and, in course of time, a village rose round the sacred edifice, which gradually increased to a town. Dagobert also founded an abbey, which he richly endowed, and conferred on it great privileges. Upon his death he was buried in the Church of St. Denis; several of his successors were also interred there, so that in time it became the customary burial-place of the kings of France.

Suger, Abbot of St. Denis, in the earlier part of the twelfth century, added to his duties as an ecclesiastic those of the statesman and the warrior: in these two latter characters he rendered good service to King *Louis-le-Gros*, and his successor *Louis-le-Jeune*. His abbey-church, however, had become too small to accommodate the crowds that flocked to it on the days of festival, and he determined to rebuild it, a project long entertained by him. After having himself drawn out the plans for the new edifice, he procured from all parts of the kingdom the most skilful architects, sculptors, painters, wood-carvers, carpenters, and goldsmiths, he could meet with; and even sent to Rome for columns of marble, determined that no effort should be lost, nor any expense spared, to raise a structure worthy of a Christian temple. Not only this, but he improved the possessions of the abbey, founded many priories, which he filled with monks of St. Denis, and rebuilt almost the whole of the church in a more magnificent style than ever. The nave and two aisles were finished in 1140, three years after the foundations were laid. Suger caused this portion of the edifice to be dedicated with great solemnity, nothing being wanted to give importance and dignity to the ceremony, which was performed by the Archbishop of Rouen, assisted by the Bishops of Meaux, Senlis, and Beauvais. In 1144 the whole church was finished, and re-consecrated with even greater pomp than before, the King and Queen of France, the dowager-queen, and a vast concourse of prelates and nobles, both French and others, being present. Only a small portion of Suger's building now remains.

In September, 1219, a thunderbolt destroyed the timber-work of the spire which crowned the northern tower of the front; the nave was also much shaken by the storm, and, about the year 1230 total destruction seemed impending: the apse, too, began to subside. The king, Louis IX., surnamed the Saint, and his queen, Blanche, commissioned the abbot, Endes Clement, to rebuild the church; and they furnished the greater part of the funds necessary for the

purpose. The abbot did not live to complete the work, this was done by Matthieu de Vendôme, who administered the affairs of state during the absence of Louis from his kingdom. Clement restored the apse, and commenced the façade; De Vendôme finished the latter and built the transept. The chapels of the nave were successively added during the fourteenth century.

Under Louis XIV. the grandeur of the rich abbey of St. Denis suffered much diminution: that monarch reduced it to the ordinary rank of a Benedictine monastery, and transferred a large portion of its revenues to the establishment of St. Cyr, an

institution he founded at the desire of hismorganatic wife, Madame de Maintenon, for the education of young ladies of noble birth. It was here Madame passed the close of her life, and was buried.

The revolution that broke out in France at the end of the last century still further prejudicially affected the church. The abbey itself was suppressed in 1792. The following year a decree past the Convention for the destruction of the royal tombs it contained, and also those of such renowned Frenchmen as Bertrand du Guesclin, Turenne, Montesquieu, and others; but it was so far moderated that a commission

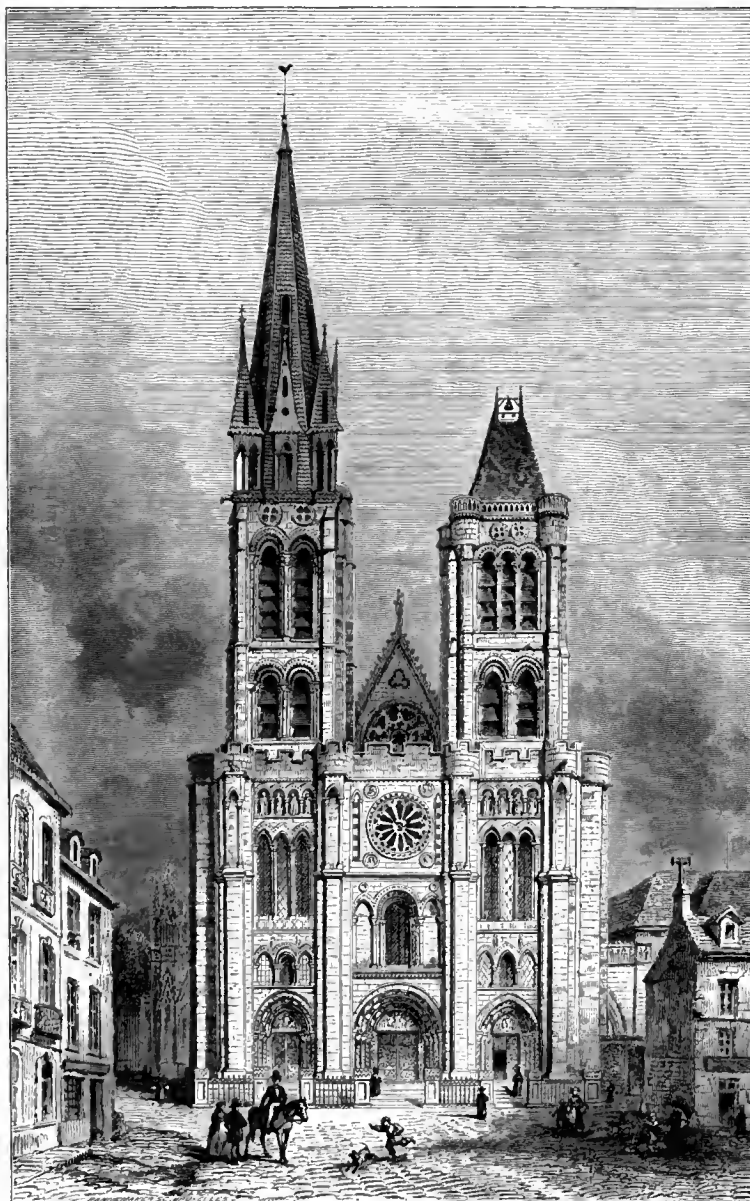

was appointed to preserve such monuments as were considered worthy of the distinction. The tombs of the kings, however, were opened, and the bodies thrown into one common grave. In 1794 it was determined to destroy the church altogether, because of its having been a kind of royal mausoleum, so bigoted and brutal was the fury of the revolutionists; but nothing further was done than to strip off the roof. Two years afterwards it was partly re-covered with tiles; but in 1797 the work was stopped, and the agitation for complete destruction was renewed. In 1799 the stained-

glass windows were removed; but under Napoleon, as consul and emperor, the edifice was restored, as were also some of the regal tombs; a chapter of ten canons was appointed, all of them retired bishops; four chapels were added; other improvements were made; and the church has since been adorned with paintings of historical events associated with it, and with statues of some of the earlier kings of France. In 1806 Napoleon issued a decree that it should be the burial-place of the emperors of his dynasty. How many will lie there?

JAMES DAFFORNE.

PICTURES FROM ENGLISH LITERATURE.*

MODERN Art, unlike that of older days, owes much to literature, which now appears to be in no small degree the mainspring of the painter's action. It is just the same in the great continental schools as with us; and so a class of historical or semi-historical subjects is opened up, almost entirely, or but very little, adopted by the old masters of Art—a class which, when allied with domestic scenes, forms the staple of artistic-work in our exhibition-galleries. The principal advantage derivable from this source is the infinite variety of subject that artists present to us; still, this has its counterbalancing disadvantages in the frequent recurrence of some favourite theme till it becomes almost distasteful.

There is little of our popular literature that has not appeared in a form more or less illus-

trated; yet it yields inexhaustible materials; and it was a good idea, carried out by Dr. Waller in the volume before us, to make a selection of certain passages, or rather scenes, from some of the best-known writers, for illustration by artists whose names are, for the most part, guarantees for the excellency of the works they produce; such, for example, as painters like E. M. Ward, R.A., J. C. Horsley, R.A., F. W. Yeames, A.R.A., Mrs. E. M. Ward, J. Faed, R.S.A., Marcus Stone, John Gilbert, W. C. Thomas, and others. "As one who wanders," writes Dr. Waller, "through a spacious gallery, where the pictures of a nation's artists are exhibited, pauses before some work that especially attracts his attention, and from the plenitude of riches that surrounds him seeks to note some few works as representatives of peculiar genius, of special style, and of different schools of Art—so, in these pages, it is our aim to select from the many masterpieces that enrich our English literature

a few pictures which we believe may fairly be taken as representative works. It is scarcely necessary to say that our selection does not profess to give even one specimen of every distinct style or class of writing; to do this would require a space many times exceeding our limits. . . . Our design, too, is limited by the exclusion of all real characters, being confined to those which are entitled to be considered the creation of the author's intellect, and which possess an individuality sufficiently marked to justify our choosing them for special consideration."

The principal authors upon whom Dr. Waller has levied tribute, are Chaucer, Spenser, Shakspeare, Milton, Goldsmith, Cowper, Burns, Walter Scott, Coleridge, Campbell, Byron, Thackeray, Dickens, Tennyson, &c. Each illustration is accompanied by an admirably written and discriminative criticism, from the pen of the Doctor, of the story, or scene, or



THE VICAR OF WAKEFIELD AND HIS FAMILY.

poem, that has suggested the picture. "It has been our endeavour," he says, "to present in each case an epitome of the tale or subject, at least so far as was needful for the illustration of the character selected." It may safely be predicted that the text of this very beautiful volume will be as highly appreciated as the engravings: it is not a series of dry essays, but rather pleasant and discriminating comments on the original writings.

The illustrations—engravings on wood—are twenty in number: one of them, a scene from Goldsmith's "Vicar of Wakefield," by John Gilbert, the publishers of the book, Messrs. Cassell and Co., afford us the opportunity of introducing here: the composition is marked by the bold and graphic style of this most popular artist. Lydia Languish showing Captain Abso-

lute the portrait of Beverley, from Sheridan's *The Rivals* is the subject of E. M. Ward's picture—one that in style and general arrangement might pass for a work by Meissonier. Chaucer's "Canterbury Tales" was in the hands of Marcus Stone, who has selected the scene, putting it not inappropriately into a kind of mediæval type, where Walter comes to old Janicola in the village to ask his daughter Griselda for his wife. Tennyson's "Dora" has supplied Mrs. E. M. Ward with a charming subject, which she has treated with a beautiful simplicity: it is that where Dora is seated in the field with William Allan's child, to enlist the old farmer's sympathies in its favour. W. F. Yeames shows us Falstaff, with Prince Hal, Poins, and others, in the Boar's Head, Eastcheap: a picture of well-studied character. J. D. Watson's *Una* and the Knight riding in the Forest, from Spenser's "Fairie Queene:" the lady looking down from her palfrey on the lambshe

is leading—is a very effective picture. There is great merit, viewing it as a composition, in W. Small's John Gilpin, but its Pre-Raffaellite manner will not recommend it to many: while, to our taste, W. C. Thomas's rendering of the scene from Coleridge's "Ancient Mariner" is more acceptable: the two figures are somewhat statuesque, but they are of a good classical order—vigorous, yet refined. John Faed's Jeannie Deans, from Scott's "Heart of Midlothian"—she is seated by the wayside on her journey to London—is very striking in its saddened expression and its management of light and shade. Clever is R. Macbeth's representation of the courteous old knight, Sir Roger de Coverley, strongly marked though it be with somewhat exaggerated expression. We must leave the remaining subjects to tell their own tale to those who may possess the book, which is certainly among the very best of its kind this Christmas season has produced.

* PICTURES FROM ENGLISH LITERATURE. By JOHN FRANCIS WALLER, LL.D. With Twenty Illustrations. Published by Cassell, Petter, and Galpin.

CORRESPONDENCE.

To the Editor of "THE ART-JOURNAL."
THE DULWICH GALLERY.

I DO not know, Sir, whether you are aware that if you paid a visit to the pretty little picture-gallery at Dulwich, and took out your pocket sketch-book to make a few jottings, you would be required to desist "by order of the governors." I went there on the 1st October last. I wanted a figure in one of Rubens's oil-sketches. With a small octavo sketch-book and pencil I took my stand before the picture, but had not been engaged five minutes before the porter walked up the empty gallery (there were two other persons in it) and requested me to desist. I naturally hesitated, wondering what harm I was doing, or what inconvenience I was causing, that could justify this dog-in-the-manger-like proceeding; but the poor man begged so hard for his own sake that I shut my book, determining to appeal to the governors. I did so, and after relating the incident, I urged "that a picture-gallery is the artist's library of reference; and if from any cause he is prevented availing himself of it as such, its main usefulness is lost, and the intention with which it has been given is so far departed from." I went on: "I feel sure you will be glad that I have drawn your attention to the matter, so that, in future, no artist or amateur, especially (for the national credit) if he be a foreigner, may be subjected to so unnecessary and annoying a restriction." My letter was sent on the 4th October, on the 9th November the assistant-clerk replied, informing me that "No visitor is permitted to copy, in any way, any picture, but on a regular permission granted in the usual manner." You see, Sir, *five weeks* elapsed before I got a reply to my letter. Suppose an artist or amateur from the country or from abroad, having but a day or two to spare, and wishing to carry away a few memoranda of some of the admirable works in the gallery, the necessity of obtaining the "governors' permission" ere he might venture to make a sketch, even on his thumb-nail, would prove an absolute prohibition to copy at all. Nor is it at all certain that he would obtain the boon even if he could afford to wait four or five weeks; for my friend, Mr. Heaphy—an artist, as you know, of no mean standing—in the early part of the summer requested to be allowed to copy one of the Murillos, and to this day, December 7, he has received no reply, although he has, in the interval, been to Dulwich to inquire for one.

I told the governors that I sought no *particular* favour, but applied to them in the interest of Art; with the same view I put the ease into your hands—thinking you will know better than I how to deal with gentlemen who do not seem to understand the requirements of Art or the nature of their trust.

AN ARTIST.

December 7, 1870.

[This is simply monstrous. It has long been felt by those who take the least interest in Art, a great disadvantage to have what may rightly be called a public picture-gallery placed at such an inconvenient distance from the metropolis as to be comparatively inaccessible. But that an artist who takes the trouble to visit it for the purpose of study, should be prevented from carrying out his object in a legitimate manner is most reprehensible on the part of the authorities who issue orders such as those to which our correspondent refers. The governors of Dulwich College are not in such good odour with the public that they can afford to lose whatever popularity they are credited with; and this red-tapeism of office must not be permitted to pass unchallenged. In the interests of Art and artists we are bound to protest against it. The fittest place for the Dulwich pictures is the National Gallery, to which we hope they may some day be transferred, through the intervention of Parliament. The public, at any rate, has a right to demand that such absurd rules as seem now to regulate the action of the governors should be at once rescinded.]—ED. A.-J.

DEPARTMENT OF SCIENCE
AND ART.

A SPECIMEN of Della Robbia ware has lately arrived, "on approval," at South Kensington, which, judging from its appearance in detached portions, is certainly without rival in the Museum, or, indeed, in the country. It represents the Temptation, and was executed by order of Pope Leo X. Its history is known and authenticated, and its value is very great. We hope that what appears—to those unacquainted with laws too subtle for outside mortals to grasp—as caprice in the selection of objects for purchase will not disappoint the nation in this case. It is very remarkable to how great extent the best objects in the Museum are either gifts, or by far the cheapest of the purchases. In cases of individual offers, where authentication is perfect, execution masterly, and interest and value unquestioned, a close parsimony or an unaccountable neglect has often been attributed to the authorities of the Museum; and, as we think, not altogether without reason. On the other hand, in the purchase of collections, money appears to have been no object at all, and duplicates, triplicates, or even quadruplicates of objects of little intrinsic merit have been bought at enormous prices. Such is the case with regard to the last purchase of Rouen and Nevers ware. For a Museum like that at Kensington it may be right to give almost any price for a single article, when unique, and when illustrating a special manufacture, or special phase of Art. This does not apply to more numerous specimens. The Rouen and Nevers *faïence* is interesting, as forming part of a large ceramic series. It is not in itself very good, or likely to serve as a pattern for our own manufacture, especially as its character depends on that of the clay found in the localities of the potteries: £82 for an ordinary fountain, and £165 for a pair of ewers, are disproportionate prices. Is it possible that a commission is paid on the purchase of collections?

In the Loan Collection at South Kensington we note two fine shields, apparently of beaten iron, enriched with gold. The first of these is circular, containing a representation of St. George and the Dragon in the centre, with an embossed border. It is attributed to the fifteenth century. The other is rather larger, of elliptical form, with a border of trophies; the central part representing, in fairly executed *mezzo-relievo*, some historical scene which we cannot at the moment identify. Of course the Roman costume of the personages represented gives no aid. We should have thought it designed for the visit of the Queen of Sheba to Solomon, but for the circumstance that the dusky and long-robed lady holds two keys in her hand; so that the surrender of some city, or the triumphal entrance of some royal personage, appears to be commemorated. A little angel flies above, carrying a crown for the principal figure. The work is of the sixteenth century. In the same case are a very beautiful dish of Limoges enamel, representing Melchizedek blessing Abraham, which is sent by Mrs. H. S. Hope; a small altar cross, and an incense burner, of very elaborate workmanship. A collection of curious knives accompanies the shields.

SCHOOLS OF ART.

BRISTOL.—The annual meeting for the distribution of prizes took place on the 6th of December, in the room of the Fine Arts Academy: Mr. P. W. S. Miles occupied the chair, and Mr. T. Gambier Parry delivered an appropriate address, and presented the rewards. The chairman remarked that the school had done exceedingly well during the year, for it numbered among the pupils two recipients of Queen's prizes, besides numerous others, while more than twenty works of Art had been retained at Kensington to be put in competition for the gold medal. There was, however, one important point to which he desired to call attention; and that was the debt of about £650 with which the school had for some time been hampered, and their object should be to get it paid off as

speedily as possible. It did seem extraordinary that in a large city like Bristol no assistance should be given by the municipal authorities: in Cardiff, a much smaller town, municipal prizes and municipal subscriptions were given to the local School of Art, while Bristol had to depend solely upon private subscriptions. Such a wail of complaint is nothing new to us, for this wealthy city has never proved itself active in the cause of Art, even when its own interests are more or less immediately concerned.

CARLISLE.—At the last annual meeting of the supporters of this institution, for distributing the prizes and for other business, the report said that "The committee have great satisfaction in stating that the school still continues to maintain a high standard of success; the work of the past year having placed it the sixteenth on the list, there being 107 schools in the United Kingdom." The bishop of the diocese was present, and addressed the meeting in some very sensible and spirited remarks.

CHIPPENHAM.—This school, it is stated, will in all probability be closed, unless the working-classes avail themselves more than they now care to do of the instruction it offers.

FEMALE SCHOOL OF ART.—An exhibition of a selection of works, executed during the present year by the pupils of this institution, was opened on the 2nd and 3rd of December. By Miss Emily Selous, who distinguished herself last year, and gained the Queen's gold medal this season, were a well-modelled statuette of the famous Discobolus, or quoit-player, a most attractive head of our Saviour, and some carefully-executed models of hands and feet. Miss Whiteman Webb and Miss Edith Boyle received each a silver national medal, the latter for a clever design for a screen. Miss Julia Pocock, who, in 1869, won the Queen's medal, and this year gained a national bronze medal, was an exhibitor both of sculpture and painting; her works in the former class being a statuette after the antique, and a Venus; in the latter class, paintings and drawings from the life, and fruit-pieces. The other ladies to whom were awarded national bronze medals are Miss Alice Ellis and Miss Alice Locke, the latter for a beautiful drawing of the *Lilium lancifolium*. Miss Louisa Gann, the able superintendent of this school, keeps it nearly, if not quite, at the head of all similar institutions in the kingdom.

ISLINGTON.—The prize-winners at the last examination of this school received their awards, towards the close of the year just passed, from the hands of Professor Huxley. Since the foundation of the school, in 1862, the pupils have succeeded in carrying off several gold, silver, and bronze medals, in addition to two exhibitions of £50 each, tenable for three years, and six scholarships of the value of £10 each.

MAIDSTONE.—The distribution of prizes to the students of the Maidstone school was made, towards the close of the year, at the Concert Hall, after an exhibition of their drawings in a room of the Corn Exchange. Sir John Lubbock, M.P., gave away the prizes. The report for the past year states, that in reviewing the progress of the "night-classes," it is a great satisfaction to the committee to find that the number of students in attendance continues to be so well sustained, and that the classes are self-supporting. The pupils of all classes have passed their examination most creditably. "The committee," the report goes on to say, would be glad to be able to commence an Art-library, and would be grateful for gifts of books, of that class. Back volumes of the *Art-Journal* and the *Builder* would be most acceptable.

MARYLEBONE.—Sir M. Digby Wyatt presided at the annual meeting, on the 8th of December, for the distribution of prizes; Mr. Stewart, the master, read a report, which showed the institution to be in a most flourishing condition. During the year 1869, 479 students had attended the school, being an excess of 100 over the previous year. The amount received for fees was £100 over the amount so received in 1868. In 1869, 48 prizes had been awarded; the number in 1870 being increased to 112. One student (Mr. James Rowley) had gained a South Kensington scholarship of £50, and six had gained admission to schools of the Society of Arts.

NORTHAMPTON.—A large assembly recently met in the town-hall here, to hear the annual report of the Museum Science and Art classes, and to witness the prizes given away to the successful competitors. The report of the latter states that "The success of the students exceeds that of the two previous years of its existence, and the number of prizes obtained in the second and third grades is greater than that of the two previous years added together. The attendance of the students is highly satisfactory, and maintains an average greater than that of last year."

SHEFFIELD.—The annual meeting of friends and supporters of the school in this town was held in the month of November. The report of the council stated that the school has made steady and satisfactory progress during the year. There had been an increase of forty-four in the number of students, and of £57 3s. 6d. in the amount of fees received. The institution was capable of still further extension, and the council would like to see more artisans and females attending the evening classes.

VISITS TO PRIVATE GALLERIES.

THE COLLECTION OF H. J. TURNER, ESQ.,
HAMILTON TERRACE, ST. JOHN'S WOOD.

The works noticed in the columns that follow constitute an agreeable and very valuable assemblage of pictures and drawings. In testimony of their worth, it might be enough to mention the names of the artists, but that would not suffice to indicate their superior excellence. The principle guiding the selection in this case, seems to be that, when *capri d'opera* are not to be had, we find always the nearest procurable approach to the highest degree. The foreign artists represented are MM. Gérôme, Jalabert, Isabey, Tadema, Fortuny, Bonnat, and Mlle. Rosa Bonheur: those of our own schools are D. Roberts, R.A.; E. M. Ward, R.A.; W. P. Frith, R.A.; J. Phillip, R.A.; J. E. Millais, R.A.; T. Faed, R.A.; E. W. Cooke, R.A.; W. E. Frost, A.R.A.; J. Pettie, A.R.A.; S. Solomon, J. Clark, J. Linnell, F. Tayler, E. Duncan, J. Gilbert, S. Prout, W. Hunt, F. W. Topham, H. B. Willis, and J. Holland, &c. &c.; and of many of these there are several examples.

Of the water-colour drawings covering the walls of the drawing-room, one of the first to catch the eye is that very original production, 'The Prisoner,' by Gérôme. The prisoner is some traitorous bey, or, it may be, pasha, who has been seized, bound, packed in a boat, and is being conveyed either to confinement, or to suffer some one of those prompt forms of execution so well known to Orientals. The rowers are two strong boatmen, who sweep the boat along at a rapid rate. Besides the oarsmen, there are two other persons: one is a presumed necessity, whose presence indicates the gravity of the offence committed; his orders are to shoot the prisoner at once, if he make resistance. The other is a native musician—a guitarist, who is seated in the stern of the boat, and sings in the ear of the doomed man the catalogue of his enormities, and in his own muscular poetry brings out in strong relief the immediate prospect of the bow-string, or some other less merciful manner of execution. This is a story which involves a history. When it is said this is perhaps the most remarkable drawing M. Gérôme has ever produced, it is the highest praise which can be pronounced on it. There is also by the same painter 'The Hour of Prayer,' wherein appears an expanse of desert, through which a numerous caravan is dragging its slow length along, with its ultimate extremity lost in the distant waste. The immediate point of the picture is a good Mussulman at his devotions, for which purpose he has separated himself from the caravan.

'Dante,' also by Gérôme, has been engraved for the *Art-Journal*, and will appear in due course. It is to be observed of all the works of this artist that the great feature of his originality

is his selection of subject, which is generally of a character extremely difficult to render. He shows himself quite independent of all that has been done before him. His progress is that of a solitary who takes no direction wherein he has been preceded. This drawing is based on that anecdote in which Dante is said to have visited the lower regions whenever he pleased, and to have returned safely to earth again. This power was vulgarly attributed to him in Florence, insomuch that mothers pointed him out as a bugbear to their children. He appears here pacing in deep thought a well-mown grassy pleasure on the left bank of the Arno, somewhere below the Ponte Vecchio, at a point whence we see the Duomo, the tower of the Baptistery, and the more distant Fiesole, all just distinguishable in the golden flood of the afternoon sun-glow. The personal peculiarities of Dante, as we know them, are not to be mistaken; and the circumstances of the composition are so appropriately conceived as to point directly to the vulgar renown which attached to him. A woman behind him points him out with outstretched arm to her child; and to a group of pleasure-seekers on the right he is an object of interested observation. The artist has thought fit to represent him as beyond the

"Mezzo del cammin di nostra vita;"

but this is Dante's statement at the commencement of the "Inferno," and the artist could not present him to us so young after the acquisition of his enviable notoriety. The subject is undoubtedly one of extreme difficulty, but had the drawing no title at all, it could point to nothing else than Dante, and to this passage of his life. The impersonation, moreover, is that of Dante and of no other man.

'The Market Cart—Evening,' Birket Foster, presents a party of cottage-children driving a cart in a green lane; or through a line of passage, perhaps more difficult to treat—an open track, richly garnished with herbage and ground shrubbery. This, it will be seen, is precisely the material in the delineation of which Mr. Foster excels. There is, as is frequently the case in his works, a glimpse of distance very sweetly harmonising with the foreground. Mr. Foster has many imitators, but they follow him only *longo intervallo*.

Another highly-wrought drawing by Birket Foster affords a view of a small river with broken banks. The time is evening, and some cattle have been driven thither to drink before quitting their pasture. The components are not grand in their character, but there is very much more sweetness in this scene than is generally found in Mr. Foster's rustic conceptions. 'Gathering Elderberries,' by the same hand, is a work in another vein, presenting simply a party of cottage-children; and these form the pith of the proposition, as on them the very modest accompaniment of landscape throws the entire burden of entertaining the eye. 'The Bird's Nest,' also by B. Foster, is one of those small rustic studies of which he has made so many. It tells of a village-boy who shows his sister a nest he has just taken.

'The Widow,' by F. Willems, pictures a lady in mourning, brooding in sad and silent grief over the portrait of her departed husband. If she were alone the drawing would but reproduce an incident that has formed the subject of numerous pictures and drawings; but she has a companion, which at once removes the conception far away from the circle of that commonplace, beyond which mere ordinary sentiment has never carried the subject. Her companion is a noble deer-hound, crouching at her feet, his head resting on his paws, and his eyes fixed on the picture, a full-length, from before which the curtain has been drawn aside. This is a new and touching feature in the story; and if we question the amount of intelligence which would lead the animal thus to give a new value to this version of an oft-repeated melancholy tale, it may be answered and maintained that it is not beyond his instincts to sympathise with us in affliction, or to recognise our expressions of gladness.

'The Disputed Point,' by Topham, is an importation from a Spanish wine-house, one of those centres of irresponsible indolence where-

in circulate the ragged *far niente* of Spanish cities, who are all addicted to play, and are excited by it even more than by the romantic politics which have coloured their country's history for nearly a hundred years. The gamblers are perhaps muleteers, of whom one has risen from his seat and is angrily remonstrating with, or it may be threatening, his antagonist in regard of some real or supposed act of unfair play. 'Market Day at Segovia,' by the same artist, has also for its scene the entrance to a house of entertainment, where we see a mule caparisoned for travel, and still bearing on its back one of the company of wayfarers. We must receive, as an exact translation of the national spirit, the utterances that reach us from the persons represented in these admirable drawings.

'The Hawking Party,' F. Tayler. By the personal equipments and other appointments here, we learn that this "meet" took place about, or before, the middle of the last century. The prominent figures are a lady and a gentleman on horseback, to whom the artist has given that easy grace which distinguishes those whom he intends to represent as of superior condition. The horses and dogs are very masterly, and the drawing has all the sparkle which marks Mr. Tayler's best works.

By E. Duncan, as contrasting strongly with his wild and stormy seas and skies, we turn to 'Northfleet Creek,' a place of such apparent natural tranquillity that the water looks as if it had never been disturbed by a ripple, nor the sky by any mischievous cloud. There are groups of boats near and far; and, to assist the voiceless quietude of the place, there is a boy with his line in the water most patiently waiting for a bite. With all this quiet profession, Mr. Duncan is the stormy petrel of his time. And in this capacity he places before us 'The Wreck off Culver Cliff,' to which we refer for the sake of contrasting it with the calm of the other picture. Here a noble ship has been capsized and lies hampered with wreck, the sea at the same time breaking over her in irresistible masses. The life-boat is rescuing a portion of the crew, who are leaving the helpless vessel by means of the loose spars. The whole is overshadowed by a sky not made up of ordinary forms of clouds—these being riven by the winds into dark sheets of scud admirably managed to describe the violence of the tempest. There is no horizon: the heaving waters and the flying drift coincide in the formation of a drop-scene, behind which the fancy is left to work out its own imagery. 'After the Wreck' is the painful conclusion of the story. The ship has been driven ashore under the perpendicular chalk cliff which dominates the beach. Nothing is left but a portion of the timbers forming the skeleton of the hull, and these remains are surrounded by parties of men engaged in breaking up and carting away the wreck. Although showing the utmost violence of the sea, there is in these works no exaggeration. This is particularly remarked in another valuable drawing, 'A Capful of Wind,' in which we see a fishing-boat all but overwhelmed by one enormous wave.

'Sunset—Venice,' E. W. Cooke, R.A. This is one of those very telling drawings in which Mr. Cooke paints the sky after sundown over the Venetian waters. The heavens are charged with clouds, but the sentiment is that of repose. In the immediate foresea there is a vessel at anchor, but other general objects are kept out of the picture.

A brilliant drawing, 'The Doorway of Caen Cathedral,' by S. Prout, sets forth the ample enrichments of the entrance. The ragged figures in the side niches and all the ancient Gothic ornamentation are precisely of the character which Prout drew with such taste and force, and to which he gave so much value. There are also two light and elegant works by the late James Holland, which will bear comparison with any of his minor productions. One is a view from the 'Piazzetta, Venice,' looking through the open space between the palace and the library; the other is 'Innsprick.'

We have by John Gilbert, whose descent from tragedy to farce is so easy and pleasant—his famous conception of Falstaff's ragged

regiment. The scene is the court before Justice Shallow's house, and in the arrangement and its spirit are fully maintained the pith and humour of the text. Falstaff lounges heavily, but at his ease, in his seat, and addresses individually by word and gesture his ill-favoured and ungainly levy. We see at once that it is Feeble, the woman's tailor, who is at this moment under examination. Mr. Gilbert has given Falstaff much of the air of a gentleman, notwithstanding the epithets bestowed on him by Prince Henry. We do not remember any other version of this subject. Certain it is that no other artist could embody more successfully the spirit of the scene. By G. Cattermole is a drawing presenting a judicial assembly characterised by all that solemn dignity which this artist could so effectively communicate to his graver creations: it is called 'The Council.'

By David Roberts, R.A., is one of those elaborate studies of church-interiors made for engraving; it exemplifies the ecclesiastical architecture of Spain. The subject is well known from the plate as being rich beyond all the church ornamentation of Northern Europe. It shows a portion of the interior of the Cathedral of Toledo. 'A Pine and Grapes,' W. Hunt, is in colour and finish equal to his most successful works. In 'A Group of Cows,' H. B. Willis, the animals are drawn with a relief and substantial roundness very rarely attained in similar studies.

To complete this notice of the drawings, we must mention a few others which, although for the most part small, are yet distinguished by excellent quality, as 'The Lake of Lucerne' and 'Massa, on the Bay of Naples,' by John Brett; 'Robinson Crusoe,' 'The Evening Walk,' 'The Virtuoso,' and 'The Book-Worm,' by J. D. Watson; and 'Out of the World,' F. Walker.

The works hitherto described are all water-colour drawings distributed in the drawing-room, every available inch of the walls of which is covered, so that many small works of exquisite quality are hung too high for such an examination as would enable us to do them justice.

We now proceed to an examination of the oil-pictures: these are hung in the library and dining-room. The well-remembered canvas by J. Pettie, called by its author 'Pax vobiscum' (? *tecum*), shows us a monk of the jocund type of the Clerk of Copmanhurst. He is ample in person and florid in face. He has just dined, and, good easy man, pleased with himself and satisfied with all the world, he is in the act of bestowing his blessing on a mouse which has ventured forth of its hole to dine also on a crumb that has fallen from his well-furnished table. He addresses the mouse earnestly and heartily, and the little animal by its perfect composure shows that it is in a familiar presence. 'The Dancing-Lesson' is another of Mr. Pettie's happy conceits. The *personae* of the entertainment are a little girl, and her master who is executing a rapid movement on his violin to the inspiring measure of which the child is flying on tiptoe and on all the wings of her gauze draperies, very much to the satisfaction of the professor who is seated, marking the time, and smiling at the perfect success of his pupil, who is evidently in training for a *pirouettiste*. It is one of Mr. Pettie's best essays, and was engraved a year or two ago in the *Art-Journal* as one of the illustrations accompanying a sketch of the life of this artist. The work which, we believe, brought him into notice is, with its pendant, also in this collection. It is 'The Time and the Place'; it introduces us to a person who resembles very much one of the heroes in "Woodstock." He stands with his drawn rapier, waiting impatiently the appearance of his antagonist, whom we see in another picture hastening to keep his engagement, and as ready for the conflict as the other.

Among the other familiar and famous pictures in this collection, we find 'The Sick Child,' by Clark; one of those works which form at once a reputation for their authors. It is so well-known as to render description unnecessary. By Edouard Frère is another domestic subject carried out with infinite taste and delicacy: it is called 'Evening Prayer,' and consists of a group—a mother and her two children, one on her lap and the other by her side. This

little picture has all the simplicity, and many of the best points, of those of the celebrities of the Dutch school. Another, that once seen can never be forgotten, is a picture by Bonnat representing a portion of the façade of the church in Rome, on the steps of which are still found models for hire. For a picture seriously executed, the arrangement of the figures is one of the most daring we have ever seen, and it is the more striking because the whole is carried out with great success. The originality of the work is such as at once to rivet the attention. It is entitled 'Ribera at Rome:' the Spanish artist is on the steps sketching from one of the figures near him. A small life-sized study of an Italian child in *contadina* costume, by Jalobert, has received an interest far beyond the common class of these studies by the moving tenderness of the expression, and the masterly cunning of its mechanical feeling.

'A Street-Scene in Pompeii,' by Tadema, has cost the artist much study and learned inquiry. It is true there are authorities which supply patterns of all the material in the composition, but there is an air of probability about the whole that indicates earnest and profitable study of a kind to which artists do not commonly devote themselves. The place is a flower-market, through which a Pompeian, one of the upper five hundred, is idly strolling, as if to recover from the languor consequent on a prolonged festive indulgence of the night before. To make a subject like this interesting, it is necessary to penetrate, not only the depths of classic lore, but to be highly gifted with the best qualifications of a painter. According to the ideas we gather from well-accredited authorities it is the most truthful modern picture of Pompeian life we have ever seen. Another not less remarkable work 'The Amateur,' by Fortuny, represents simply one of the large and gorgeously decorated rooms of a palace wherein a gentleman is seated examining works of Art brought to him by servants in rich liveries. It is not often we point to execution as a marvel of eloquent expression, but the working of this picture, although it might be called sketchy, and even loose, is rich in fanciful and endless suggestion—far beyond any elaborate classic or renaissance composition—which shows at once its beginning and its end. The only essay from English history is a small picture by E. M. Ward, R.A., the subject being that of his noble work at South Kensington, 'King James the Second receiving the News of the landing of the Prince of Orange.' This, it would seem, is the sketch made preparatorily to the painting of the large picture, of which it has all the point and force. By W. E. Frost, A.R.A., are two small pictures of infinite grace and beauty: one is 'Bather surprised,' a single nude figure; the other, a group of draped figures, 'Nymphs lamenting Narcissus,' is a composition rather darker than he usually paints. 'Pot-Luck,' T. Faed, R.A., shows two cottage-children feeding fowls from a porridge pot. The two are enveloped in one large shawl, and their posing is very sculptural. The picture has all the solidity and firmness which characterise Mr. Faed's works. 'A View on the Amazon,' by Mignot, pronounces at once whence its material is derived.

We now come to the paintings which cover the walls of the dining-room. These are of course, from their size, less numerous than the drawings, which, in the other rooms, individually occupy less space. Here the centre-piece is 'Cleopatra before Cæsar'; it may be safely ranked as M. Gérôme's masterpiece. In the severely classical treatment of this picture, there is as much to study as there would have been to condemn, had the composition been full of vain pretension. The Egyptian queen has just been introduced by an Egyptian chamberlain, who has removed from her the rich drapery that enveloped her; and she now stands before Cæsar uncovered, save by a hanging drapery of gauze-like texture. The contemplation of this figure declares the directions which M. Gérôme's studies in physical ethnology have taken. Again and again we are reminded that in the beauties of the Egyptian queen everything is Egyptian—nothing Greek. Cæsar, who is seated, and has been writing, only raises his head and expresses his admiration. The bust of Cæsar in the

British Museum is a miserable production; yet in the cast of the features there is a resemblance, yet with an expression of character incomparably more firm and decided. The picture bears everywhere a tone of learning and profound study. W. P. Frith's 'Pope and Lady Mary Wortley Montagu,' we need not describe, as it is so well-known. Here it is, with, on the one side, all its laughing mockery—on the other, all its bitter chagrin. It is more mellow than when it first appeared, some eight years ago.

Two works by J. Linnell are rendered very important by the care he has bestowed upon their completion. One is 'Southampton Water,' a landscape of an aspect which he does not often paint, as presenting a piece of rugged ground ascending to the right, crested by brushwood and a weird looking tree or two; beyond this the view opens to the left. In the other, 'Feeding Sheep,' we are told that the season is towards the end of the year, for the flock is fed on turnips. In both, the time of the day is evening: in one, twilight deepening from daylight; in the other twilight fading into night. Frequently Mr. Linnell's landscapes are only bases for skies; but here the landscapes and the skies have most studiously been made to respond to each other.

'Dolores at the Balcony' and 'Love's Labour Lost' are two small head and bust studies by J. Phillip, R.A., very different in character, but each qualified with beauties peculiar to its sentiment. Dolores wears the full national costume of her sex; and, armed with a fan, is gazing anxiously on the street; to what end it may be understood. This is strictly according to Mr. Phillip's Spanish experience; but the other is one of those exalted heroines of Shakspeare who profess the master-passion in its utmost purity. Dolores, notwithstanding her name, is happy in her love; but the other has been disappointed, yet changes only in death. 'Too Truthful,' by Solomon, has about it much of the savour of Pepys's Diary. The situations are as comic as anything suggested in that much-quoted compendium: a gentleman well stricken in years, with his comparatively youthful wife, visits the studio of a painter to whom he has been sitting for his portrait, which has been made so like him, that he is abusing the poor artist in no measured terms, and the lady, by her lofty disdain, endorses all he says. The artist is struck dumb by such a stormy visitation. So well is the anecdote told, that we read not only all which is intended to be set forth on the canvas, but we understand all the circumstances that are not recorded.

'Oxen Ploughing,' Rosa Bonheur, looks like the preparatory study for the large and well-known picture which was exhibited in London some years ago. 'A Scene in the Landes,' also by Mlle. Bonheur, descriptive of a section of that wide and weary desolation seen by the light of the declining sun, shows us a couple of the stilted shepherds of the region bringing home their flock after the day's pasture. They are accompanied by a cart, drawn by oxen, driven by a female aid—wife or sister. The desert-like landscape and the moving life in the picture represent without question exactly what Mlle. Bonheur has seen.

By Isabey is a remarkable sea-side scene called 'The Court of Louis XIV. at Fecamp.' Amid the boats and all the fishing paraphernalia of the inhabitants is a large assemblage of ladies and gentlemen dressed according to the fashion of the time. Teniers, or at least one of the Low Country artists, painted a "season" of his day at Scheveningen, but it was by no means so complete as this work by M. Isabey. A study by J. E. Millais, R.A.—a female head—called 'Keeping the Promise,' reminds us much, in all but complexion, of the wife of Andrea del Sarto. The complexion is unusually sanguine, but not more so than some we have seen in life. 'Out of Employment' is another of J. Pettie's works; by De Haas there is 'Cattle'; and a 'Storm' by E. W. Cooke, R.A. And thus we conclude our notice of a well-selected collection, varied with pictures and drawings in water-colours and oil, foreign and English, of which the principal are the choicest of their respective classes, and are well known to a large circle of lovers of Art.

THE
NEW BRITISH INSTITUTION,
39, OLD BOND STREET.

THIS institution has been opened on principles which, we think, cannot fail to win the confidence of the profession. The committee consists of twenty-four gentlemen, who claim no prescriptive rights beyond the least known of the contributors, and among whom are members of our most eminent Art-societies. The "line of sight" is not privileged to names merely influential. A glance round the walls convinces the visitor at once that he has before him an instance of an innovation, to which, with all his heart, he will wish health and strength—its principle being, the best works in the best places, and to productions of secondary and minor degrees, places according to their respective merits.

The drawings and pictures of H.R.H. the Crown Princess of Prussia and H.R.H. the Princess Louise (already noticed in the *Art-Journal*) are still to be seen in this gallery—a circumstance to which we invite attention, as they will become private property through the instrumentality of an Art-union. To refer immediately to the material of the exhibition, we turn to No. 36, by Carl Haag: it is without a title—a small life-sized profile of a lady, and an elegant study, carried out with the very perfection of working. The colour is rich and mature—a result which must have been wanting in less skilful hands. 'Joan of Arc' (145), J. M. Jopling, is a large drawing, showing wisely only the head and bust of the figure; these are cased in plate-armour, which looks, by the way, like a tilting suit, rather than a field panoply. The work is, however, very successful in drawing. In 'The last March of King Edward I.' (152), W. B. Scott, we see the king borne on a bier, attended by armed knights and attendants, with all the ceremonial pomp of his state and style. The drawing looks like a preparation for a mural painting. 'Zara' (168), H. Tidey, is a sketch of a girl with a water-pitcher, as if waiting at a spring: the figure is well drawn and pretty. By the same artist, 'A Sea-urchin,' is a very attractive sketch presenting a poor fisherman's boy in very scant drapery, now ready for any low-tide enterprise, from sailing a boat with a paper sail to hunting tiny crabs under the sea-weed. In a much loftier strain W. E. Frost, A.R.A., invites attention to a 'Bacchante and Boy' (284) and a 'Nymph and Cupid,' in both of which the artist proves himself animated by a genuine classic *affatus*. Like all Mr. Frost puts forth, they are graceful conceptions, and would help well to illustrate a holiday edition of Ovid's *Epistles*. 'A Study on the Moselle,' W. C. T. Dobson, A.R.A., is a sketch of a girl's head covered with a loose white drapery. The features have all that Teutonic breadth which we so often see in Mr. Dobson's works. This is the first we have ever seen of this painter's water-colour essays. H. B. Willis exhibits 'A Scene near Oban, in the Western Highlands,' which he treats in his own peculiarly bucolical vein, and with great richness and harmony of colour. By A. W. Williams there is a flat tract, requiring very skilful treatment to render it at all interesting: it is called 'On the Marshes at Tenby' (14), and derives much of its interest from the ground, near and distant, being broken by hummocks and pools of water, which reflect the warm evening sky. We seem to be taken back to the golden age by the 'Enjoyment of Plenty' (35), by Lorenz Fröhlich: three nude children with a quantity of fruit. The arrangement, with a little modification, would come out well as a *bas-relief*. 'Moonlight—Loch Fyne, Inverary' (41), F. F. Bannatyne, is a pleasing drawing; as are also 'A Surrey Lane' (62), E. A. Waterlow; and 'A Norfolk Lane' (65), A. J. Stark; in 'Raising the Wind' (67), J. Henderson,—the idea is a boy exerting himself to fill the sail of his tiny boat,—the expression of the idea is very literal. 'A Summer Shower' (104), E. M. Wimperis, is a view from an eminence over a richly-wooded country,

diversified like the most picturesque parts of Surrey, the garden of the home counties: the sky repays the judicious elaboration with which it has been worked. 'Roses' (133), F. Slocombe, shows more than the title suggests, that a lady wearing a head-dress of the fifteenth century: the association is at least original. By E. Gill is a study from nature—'Pont Nedd Vaughn, South Wales' (134): a stream rushing downward over its rocky bed. The works exhibited by this artist are generally compositions, but admirably put together.

'Villa Doria Pamphili, Rome' (135), A. B. Donaldson, is a small drawing, treating rather of the gardens of the palace, than showing the building itself: Italian pines form, of course, a striking feature in the view. 'Embroidering the Raefen—the sacred Standard of the Danes' (136), C. P. Slocombe, refers to the standard taken in the time of Alfred by Odon, Earl of Devon, which is here represented as being worked by the three sisters of Hubba, superintended by Hubba himself: the drawing is very careful throughout. 'At Bay' (148), W. T. Mickleley, shows a man apparently besieged in a house, from the window of which he is firing down on his besiegers: it is worthy of a better title. In the 'Bridge on the Cladick river, Argyshire,' J. J. Bannatyne, is much worthy of commendation. 'The Father's Portrait' (175), Miss Hunter, tells at once its own tale; but, on the other hand, in Mr. Claxton's drawing, 'Waiting,' the figure does not respond to the title. It is a masterly half-length study of a man in a Rubens hat and vest and doublet. W. E. Frost's small drawing (211), representing a woman evidently in terror, and hiding with her child from pursuers, can only bear allusion to 'The Murder of the Innocents.' It reminds the observer of a once popular print from a picture by Delarocche. 'The head of Loch Coruisk, Skye,' H. Macalium, is a drawing of much power: the wildness and gloom of the scene are very impressive: the loch is here narrowed to the width of a small stream beset with enormous masses of rock. The treatment is well adapted to the subject. By J. Hayllar are two drawings, pendants, called respectively 'At Peep o' Day' (257) and 'Five Minutes' Rest' (221): in the former of which a little boy having been presented with a new toy, a drum above all things, is exercising himself with the drumsticks much to his own enjoyment, but to the great disturbance of a peaceably inclined family. In the second he has fallen asleep from sheer fatigue, and the title is accompanied by a sigh of relief which can only be an expiration given forth from real experience. 'Mount Orgueil—Jersey' (227), E. Rieck, is so crowded as to look artificial; yet the execution throughout is perfect, and the aspect proposed successfully made out—indeed, the feeling of the drawing is unexceptionable. We know Mr. Beavis as a painter of horses, and his equine studies are all living and moving; but this is the first time we meet with him in water-colours, and in association with the subjugated and patient ox. The drawing is called 'Resting' (235): a couple of oxen at plough, which are so well and carefully made out that the group would admit of enlargement in oil. There is a marked difference between the land and the sea scenes usually exhibited by E. Duncan. 'Falmouth, from St. Mawes' (242), is a quiet, comfortable locality, with somewhat of a foreign cast about it, and without a passage of ambiguous description. It is difficult to conceive this of the man who deals with the striving winds and waves, not merely as if he were an "old salt," but a very Triton. The interior of the Duomo at Florence finds but few painters with enterprise enough to commit it to canvas or paper, so uninviting is the subject. W. Shoobridge, however, has been bold enough to paint the 'South Transept—Preaching of Savonarola,' which is perhaps a minor essay, to be carried out on a larger scale with impersonations of marked character. On the other hand, the 'Chapel of St. Margaret, in St. Jacques—Dieppe' (247), S. Read, is interesting from the judgment evinced in the choice of the subject, and the manner in which it has been brought forward. In 'Homeward

Bound,' G. S. Walters (243), the title is well supported by a fishing-boat which shows by the mainsail being taken in she is nearing the beach. 'On the Mole, near Betchworth, Surrey,' T. C. Dibdin, is conscientiously followed out according to Hood's lines descriptive of Autumn. A. W. Williams's drawing, 'A Gale' (251), although a dire tumult of waters without allusion to human life, has in it more of exalted feeling than the class of landscape he usually paints.

Among the remaining drawings some are modest in their claim to merit, others possess superior claims to excellence, as 'Lynmouth-Beach and Foreland' (261), A. Macdonald; 'Cadir Idris from Llyn Gwernan' (262), Miss Freeman Kempson; 'Still Pool near Capel Curig' (267), W. L. Kerry; 'Eurydice' (279), W. E. Frost, A.R.A.; 'Primulas' (276), J. Blackham; 'Nina' (278), Georgina Swift; 'Villo Borghese—Rome' (303), A. B. Donaldson; 'Village of Barbison, France—Evening Effect' (289); 'The Miss Kenwidges take their first French Lesson' (295), W. Gale; 'The Ducklings' (296), J. A. Vinter; 'The Pet-Kid' (281), J. Bouvier; 'Study of a Head' (307), Helen Thornycroft; 'The River Mole, near Leatherhead' (327), W. Kämpel; 'Ruth,' E. T. Haynes; 'Windfalls' (328), Marian Chase; 'Palace of the Cardinal Patriarch, Venice' (338), A. B. Donaldson; and others by F. Volck, W. Gale, W. Henry, W. Limbrey, G. Bouvier, L. Fröhlich, T. J. Soper, &c. Many of the contributors stand in the foremost ranks of the profession, and as far as can be seen by the promise of the exhibition they who do not yet enjoy that distinction will be helped forward to reputation by this Institution.

SELECTED PICTURES.

FROM THE PICTURE IN THE COLLECTION OF WILLIAM WEBSTER, ESQ., BLACKHEATH.

A VISIT TO THE ARMOURER.

G. B. O'Neill, Painter. P. Lightfoot, Engraver.

SAVE as a plaything, though a dangerous one, in the hands of boyhood, the crossbow is a thing of the past: in former days it was a deadly weapon when used by our forefathers at Crecy, Poitiers, Agincourt, and elsewhere. In Mr. O'Neill's capital picture, the stalwart armourer, who may himself have done good execution with some such instrument as he holds in his hand, seems to be explaining its uses to the juveniles who have paid a visit to his workshop in the lower regions of the castle, or the "moated hall," which is their paternal residence. He is manifestly eloquent in its praise; the boy listens thoughtfully while he scrutinises the weapon closely; his sister looks wonderingly and half-fearfully into the face of the man, and holds the arm of her brother, as if for protection: by the way, she handles her pretty little pet-dog most uncomfortably; but the excitement of the story may, it is presumed, plead justification for the neglect of her favourite.

The figures of the youthful pair form an elegant contrast with that of the rough and stout armourer, and the trio are most effectively grouped. All the accessories of the picture—the bits of armour under repair, the swords to be re-furbished, the furniture of the smithery, &c.—have their place in the composition, and are so appropriately placed as to carry out and support its leading idea. The lesson learned by the boy in that workshop may be found useful in after-life when he dons casque and breastplate and brassarts, and the rest of the panoply of war, to meet his adversary in tournament or battle-field.



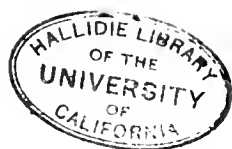

A REVIEW OF
ART IN ENGLAND IN 1870.

THE character of the year 1870, as regards the display of objects of Art, has been rather that of promise and of expectation than of actual performance. Of the exhibitions of paintings and drawings we have spoken, month by month, at length—such length that a mere *résumé* would be in extent sufficient to form an independent article. When it is remembered that there were at one time open in London, last spring, no fewer than twenty separate exhibitions—including those of dealers—and that among them the Royal Academy displayed 1,229 works, it must be confessed that, at all events in the number of productions exhibited, 1870 has shown no falling off. Apart from the regular and the sale exhibitions, the principal novelties of the year have been the exhibition of the loan collection of old masters and deceased English artists at Burlington House; that of selections from the galleries of the Marquis of Westminster and Lord Elcho, at the South Kensington Museum; and that of the original drawings of Raffaele and Michael Angelo, lent by her Majesty and by other fortunate proprietors to the Burlington Fine-Arts Club. A strong impulse is likely to be given to two distinct branches of English Art, namely, landscape-painting and water-colour-drawing, by the noble works exhibited from the case of Mr. Bierstadt, and of the Chevalier Fortuni. Of the progress of that wonderful art in which the pencil of light replaces the pencil of camel's hair, we have spoken so recently, and at such length, that it is only necessary to remind our readers of the beauty of the photographs of American mountain-scenery, sent from San Francisco, and of the more recently displayed triumphs of Mrs. Cameron, of Colonel Stuart Wortley, of Mr. R. Faulkner, and of W. Robinson, of Tunbridge Wells.

In respect to Industrial Art, the sudden outburst of the Franco-German war has put a stop to projected exhibitions at Aix-la-Chapelle and elsewhere. Rome signalled the last year of the temporal power by a feeble parody of national display, which failed to attract attention even from the ordinary residents and visitors of the City. The Russian Industrial Exhibition, of which we have been alone in furnishing an account to the English public, has raised the question as to whether any ancient Russian Art ever had existence, or whether Byzantine tradition on the one hand, and borrowing from Norse or Teutonic sources on the other, does not cover all that is claimed as of Muscovite origin. In the work of the goldsmith and silversmith, and in that of the wood-carver, the chief objects of interest in this exhibition were to be found.

The textile Art of India has been fully and admirably illustrated, by the care of the Indian Government and the industry of Dr. Forbes Watson, in a display at the India Museum in Downing Street; and, later in the year, in the Workmen's International Exhibition. While the presentation to the English manufacturer of samples or patterns of those productions which suit the traditional taste of the inhabitants of our great oriental empire has been the chief motive of the collections in question, the articles in wood-carving and inlaying, ivory-carving, jade, onyx, inlaid metal, and other materials have a wide and striking interest. Untiring patience, involving labour that takes no heed of the brief limit of life, is the most prominent characteristic of Indian, as it is of Chinese, Art. But together with this must be noted a subtle perception of harmony in colour, in which we have much to learn from the dusky artificer. The most brilliant glories of crimson and gold enchant the eye by their harmonious splendour in some of these costly tissues. In others, pale greens and blues and pinks are blended in composition as subtle as that of nature herself. Alike in the splendid and in the subdued, harmony is almost invariably to be found, and the very vagaries of arabesque patterns seem regulated by an instinctive appreciation of the subordination of form to colour. The woven gossamer of Dacca can never be examined

without wonder. The attempt to imitate exactly some of the productions of the Indian looms would be far more advantageous to our manufacturers than any effort to excel them.

At about the time when these exquisite specimens of Oriental Art were on view in Downing Street, the Society of Arts called attention to the native works sent in competition for the prizes they had so liberally offered. We can only hope that all our best workmen have been too fully employed to spare time for any but directly ordered work.

Under the heads most appropriate we have referred to the chief attractions of the Workmen's International Exhibition, the financial non-success of which has proved such a disappointment to many of its excellent supporters. It is evident that those who seek, disinterestedly and benevolently, to arouse the attention and to earn the hearty response of the English workman to their efforts to raise him in the scale of artificers, have as yet been rewarded with but scant success. The Agricultural Hall has only repeated the lesson given in the rooms of the Society of Arts. Individual productions of the highest merit were to be noticed; but adequate response from the working classes of England there was none.

The Art-Union of London, in the thirty-fourth year of its existence, has raised the amount of its subscriptions to £10,700, and has distributed 476 prizes in the year, besides the copy of "Hereward the Wake," given to every subscriber. The success of this valuable institution, and of its respected neighbour, the Ceramic Art-Union, has led to numerous attempts to prey upon the ignorance of the public; and the love of a raffle (which has such charms for so many minds) has caused the establishment of certain shilling Art-Unions, which, if they keep on the windy side of the law, are still in direct contravention of the purpose of legislation. The responsibility of the Government for the *quasi* sanction they have given to those predatory institutions is not light.

The embellishment of the metropolis has advanced in no slight degree during the past year. The opening of the Thames Embankment to public traffic has for the first time convinced many of us of the claims of London to architectural beauty. From the Mansion House towards Blackfriars, from Whitehall Place, and from other points of the inner route from Westminster to the City, broad lines of way are pierced, or are being pierced, to the river. The jolting and noisy pavement has been replaced, in one or two favoured localities, by smooth and silent asphalt. The Dean and Chapter of St. Paul's have come to the public with "the hat," for the decoration of their noble cathedral; and the Corporation of London has filled the west window of the Guildhall with glass, which, but for one very serious fault of design, would be, like most of the windows in this fine old hall, a credit to English window-stainers. As to the glass in St. Paul's, it is rich and full in colour, but as ill designed for the purpose of filling architectural lights as it is possible to conceive.

At Westminster the Chapter-house is all but complete as far as its skeleton is concerned. The reverent hand of Mr. Scott was—till rendered inactive by serious illness, from which we are glad to know he is now recovering—busy with repairs of the exterior of the Abbey. The whirligig of political advancement has clothed with a little brief authority a person who has taken advantage of official position to make a blind and furious attack upon educated men in general; and especially to imperil the harmony of one of our greatest modern buildings by seeking to replace the architect of the Palace of Westminster by persons who have not the disqualification of being educated for architecture or for Art.

For the purposes of Education, Science, and Art, the civil service estimates for the year 1870-71 amounted to £1,689,790, being an increase of £88,916 on the preceding year. Of this sum about £1,300,000 is devoted to public education in elementary and normal schools, in England and Ireland: this sum will, no doubt, be largely increased in the ensuing year. The Science and Art Department demands out of the remainder £218,000; the British Museum,

£90,000; academies, galleries, and learned societies completing the tale. The sum spent on the Schools of Science has been £32,800; that on those of Art, £34,600: the former giving instruction to 24,925 students and the latter to 18,699, in the day, and 7,258 in the night classes. Thus the State extends its aid so far as to give to some 50,000 students tuition in those important branches of study some acquaintance with which, in the better educated Continental states, is made imperative in every young person. A great effort has been made to ensure the general elementary education of the country. Out of nearly 7,000,000 children under fifteen years of age in Great Britain, 1,797,388 alone are borne on the books of schools, and 1,245,027 are estimated to be the average number actually attending. It remains to be seen how far the Government measure will serve the needs of the 5,000,000 children who, according to the parliamentary return which we quote, appear at the present moment to be in the receipt of no definite or ascertainable education. It is much to be feared that the reference of standard, details, and means of securing attendance, to a number of entirely disconnected, unorganised, local boards throughout the country, will sap the utility of a measure which has already had the effect of fanning into great activity the flames of sectarian discord.

The project of the directors of the South Kensington Museum to open a perpetual International Exhibition has been explained to our readers as fully as the information furnished from time to time by the officers of the institution has allowed. The details, however, will come into the *résumé* of the proceedings of 1871.

At the commencement of the year the course of addition to the buildings at South Kensington brought into view the magnificent reproduction, in electrotype, of the famous Old Testament Gate of the Baptistery at Florence, by Ghiberti. Close by this early fifteenth-century work was displayed a similar copy of the quaint work of Bonanno, dating in 1180, called the 'Porta di San Raniero,' in the Baptistery at Pisa. The fine collection of gems bequeathed by the Rev. C. H. Townsend has been catalogued by Professor Tennant. An exhibition of fans has taken place, with the view of promoting the Art-education of women. Mr. Noble's marble statue of Prince Albert, intended for Bombay, has been erected, *pro tempore*, in the North Court. To the loans of Lord Elcho and the Marquis of Westminster we have already referred.

The sale of the Demidoff Gallery was in itself an event of no small importance. It was remarkable for the disproportionately high prices fetched by the works of modern masters. Eighteen pictures, by Greuze, brought the enormous sum of £28,940; 'The Broken Eggs' selling for £5,040. Delaroche's 'Death of Lady Jane Grey' brought £4,400; Scheffer's 'Francesca da Rimini,' £4,000; while 'A Venetian Supper,' by Giorgione, only fetched £2,200, and a portrait by Paul Veronese, £1,208.

On the death of Mr. Brentano, Senator of Frankfurt, the unrivalled collection of engravings inherited by his wife came under the hammer, when 226 engravings of Marc Antonio Raimondi realised the sum of £10,414.

The subject which has, perhaps, had more interest for all who live for, or by, Art of an industrial character than any other, is the project of which the realisation has been unfortunately arrested by the cruel Gallo-German war. In our number for February we gave some account of the international congress summoned by the members of the "Central Union of Arts applied to Industry," and of the appreciation arrived at of the actual state of Art-education, the obstacles which oppose its advance, and the steps proper to take for its promotion. An obstacle more tremendous than any contemplated by these earnest friends of industry has paralysed Art-education and Art-industry over the regions occupied by eighty millions of the most gifted and industrious of contemporary people. Can we hope that the great questions, the discussion of which is so fearfully interrupted in Paris, are receiving due attention among ourselves? Our national welfare depends, in no trifling degree, on the reply to that inquiry.

THE MUSEUMS OF ENGLAND,
WITH
SPECIAL REFERENCE TO OBJECTS
OF ART AND ANTIQUITY.

BY LLEWELLYNN JEWITT, F.S.A., &c., &c.

THE SHREWSBURY MUSEUM.

In close proximity to *Uriconium*, or, as it is now called, Wroxeter, the English Nineveh, and with so many places of historical interest in its neighbourhood, itself rich in remains of antiquity and its history full of stirring incidents, Shrewsbury possesses many features to commend it to the especial notice of the artist, the historian, and the archaeologist. Its castle, where parlia-

ing-place in one of the fine old fourteenth-century mansions on College Hill, under whose timber roof they are seen to great advantage. Here the visitor may spend many a "long hour by Shrewsbury clock," and gain much sound and valuable information from the relics before him.

Of Wroxeter (*Uriconium*), from which most of the objects have been brought, and which is situated about five miles only from Shrewsbury, it will not be necessary to say much. It is mentioned by Ptolemy to have been standing here as early as the beginning of the second century, when it was called *Viroconium*, and it was evidently one of the most important cities

late been carried on upon its site by our friend Thomas Wright, Dr. Johnson, and others, that the marvellous assemblage of relics in the Museum have been procured.

The collection consists of coins, personal ornaments, glass vessels, pottery of various kinds, lamps, tessellated pavements, arms, keys, locks, nails, knives, inscribed stones, sculptured fragments, and other relics. But besides these are large geological and natural history collections, and a number of general objects, including an Egyptian mummy and other remains of that people.

Among the pottery, besides examples of Samian, Upchurch, Durobrivian, and other wares, the collection from Wroxeter contains a fine and highly interesting assemblage of vessels of the Romano-Salopian variety, which espe-



ROMAN CINERARY URNS, AND OTHER VESSELS FROM URICONIUM.

ments have been held and battles taken place; its abbey, founded by the first Norman Earl of Shrewsbury, and his burial-place as well as that of St. Wenefrede; its churches of St. Chad,

in Roman Britain. It was plundered and partially destroyed by fire, &c., by the invasion of the Picts and Scots in the fifth century, and was left a mass of ruins until the middle of the

cially call for notice. This variety of ware is peculiar to the Severn valley, and was made of clay procured at Broseley, the same bed from which pottery has continued to be made from

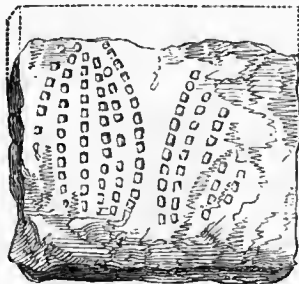

ROMAN TILE IMPRESSED WITH HUMAN FEET.

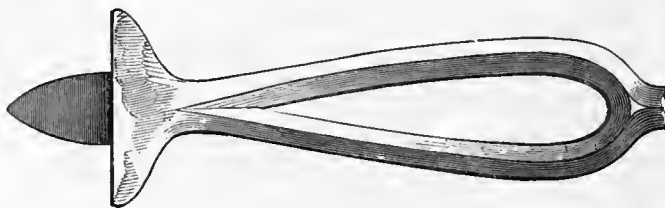

LANCET OF A ROMAN SURGEON.

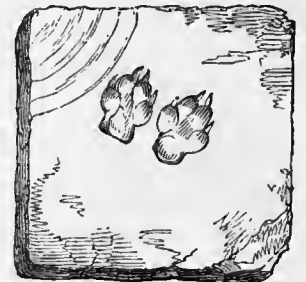

ROMAN TILE IMPRESSED WITH FOOT-PRINTS.

St. Alkmund, St. Mary, and St. Giles,—in the yard of the latter edifice stands the "pest basin," of the time when the plague visited the place; its "arbours" of trade guilds; its timber houses, gates, grammar-school, market-house, and other objects in the town; Haughmond Abbey, Owen Glendwr's Oak, Battle-field, and other historical places in its neighbourhood, render Shrewsbury one of the most interesting of old towns, and one which "all friends round the Wrekin," no matter how far away, ought to visit.

The Museum, however, is not at present commensurate in its extent with the importance and richness of the locality. May it soon become worthy of its location. Its principal feature is the assemblage of remains of Roman Art from the buried city of *Uriconium*; to these, therefore, I first direct attention. The Museum belongs to the Shropshire and North Wales Natural History and Antiquarian Society (established in 1835), and has made good progress since that time. The objects were at first deposited in a house upon Dogpole, but have now found a more suitable rest-

place, when its buildings are supposed to have been pulled to pieces to supply material for the building of Haughmond and Buildwas abbeys, and the churches of Wroxeter, Atcham, and

Roman times down to our own day. Of these wares two sorts will be noticed to be especially abundant: the one white, the other somewhat of a light red colour. The white, which is made of what is usually called "Broseley clay," and is rather coarse in texture, consists chiefly of jugs of different sizes, not inelegant in form, of mortars, and of bowls of different shapes and sizes, which are often painted with stripes of red or yellow. The red variety is also made of one of the clays of the Severn valley, but is of a finer texture, and consists principally of jugs, much the same in form as those in the white ware, except in a different form of mouth, and of bowl-shaped colanders, &c. There is also a considerable number of cinerary urns, which are mostly of the usual globular shape. We give a group of pottery to show some of the forms in the museum.



ROMANO-SALOPIAN WARE, JUGS AND COLANDERS.

other religious houses. The foundations of most of the buildings, however, remained, and it is from the systematic excavations which have of

and elegance, while others are unique. They consist of what are usually called lachrymatories, but were most probably used for holding

unguents or incense, and bowls. Of these a remarkably fine example is exhibited. There are also fragments of window-glass, &c.; and some lamps.

The remains of tessellated pavements are highly interesting; in addition to which the Museum is enriched by careful drawings of other pavements, made from the originals at Wroxeter by Mr. George Mawe, F.S.A. They are of the usual patterns, and are of good, and, in some instances, elaborate, character.

Numerous roofing-flags, flue-tiles, roof-tiles, bonding and drain tiles, &c., will be noticed; and some of them are curious as exhibiting the impressions of the feet of the dog, the sheep, the pig, the horse, and the ox. These animals having evidently walked over the tiles while in a soft clay state. One tile, from the neighbourhood of Shrewsbury, shows the impression of the two nailed shoes of a man, who had stood upon it.

Among the sculptured stones and architectural fragments are several bases, capitals, and shafts of columns; wall-decorations, both tessellated and painted stucco, one of which bears a portion of an inscription; and some carved heads, &c. There are also some very curious inscribed stones.

Two metallic mirrors, or *specula*, made of a white metal (a compound of copper and tin),

forming a sort of guard to the blade, which is triangular and made of steel. It was enclosed in the remains of a wooden case. It probably

belonged to a surgeon of Uriconium, and was with other objects—a needle or bodkin, the

museum at Naples. In connection with this a Roman medicine or oculist's stamp ought to be noticed. It consists of an inscription engraved on a neatly-formed round slab of greenish stone, rather more than an inch in diameter, and is intended for impressing or marking the names of the medicine and its maker on the pot or box or packet containing the "physic." The inscription is—

TIB · CL · M
DIALIBA
AD · OM
NE · VIT
O · EXO

which may be rendered, "Tiberii Claudii Medici dialibanum ad omne vitium oculorum ex ovo" ("The dialibanum of Tiberius Claudius, the physician, for all complaints of the eyes, to be used with egg").

Other highly-curious and unique objects, and especially interesting as connected with Art, are three painter's palettes formed of steatite, or soap-stone; one side carefully smoothed, and the other with bevelled edges, and still bearing remains of the colours which the Roman artist of so many centuries ago was using. On one of these the painter has scratched his name, so that the visitor to the Shrewsbury Museum may actually see a palette with colour remaining upon it, which belonged to the artist Dicinivus, of the ancient city of

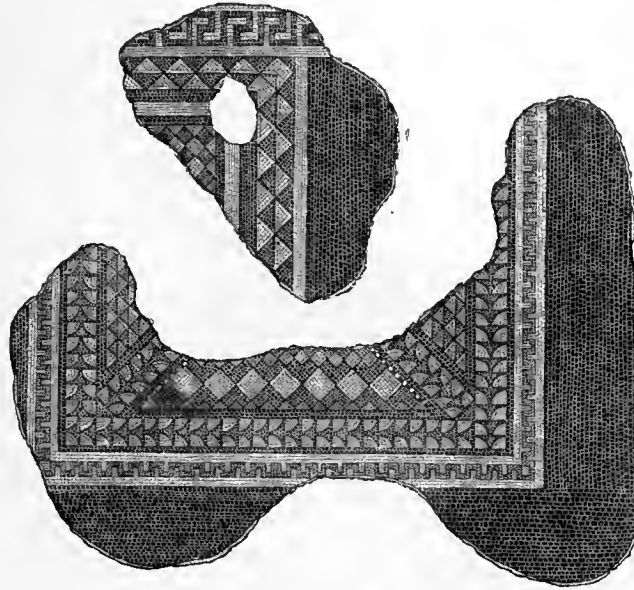

TESSELLATED PAVEMENTS.

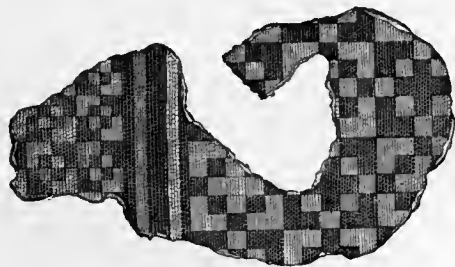

TESSELLATED PAVEMENTS.



CINERARY URN WITH LEADEN CASE.

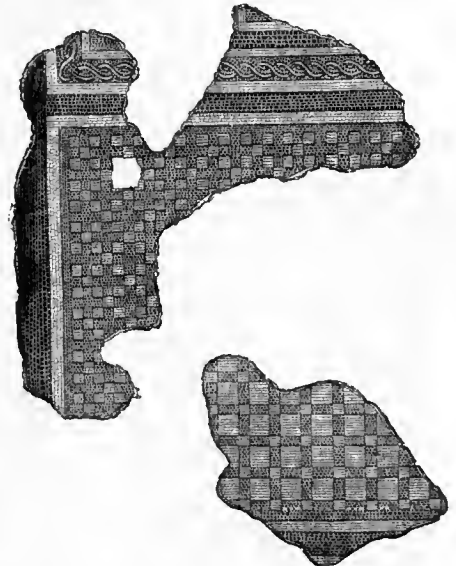

TESSELLATED PAVEMENTS.

from the cemetery at Uriconium, will be noticed; as will also some fibulae, strigils, bracelets and armlets, hair-pins, bodkins or needles, studs or buttons, finger-rings of silver, bronze, wood, amber, and iron—the latter of which is set with a blue stone, bearing the device of a fawn coming out of a nautilus shell—combs, beads, and many other articles of personal use and adornment.

Of bronze figures only one or two examples have been exhumed, but these are of great interest; especially the statuettes of Venus and of Mercury.

One of the most curious objects from the cemetery of Uriconium is the singularly-formed cinerary urn here engraved. It is, as will be seen, of unique form, and is covered by a lid, and has been enclosed in an outer case of lead. I know of no similar example.

Among other unique objects presented in this collection are some which deserve especial notice. One of these is the lancet of a Roman surgeon, which we engrave of its full size. This unique object, so far as this country is concerned, has its handle formed by a lobe or oblong ring of bronze, the knob at the top is broken off. At the bottom is a circular disc,

forming a part of a case of surgical instruments, was found at Pompeii, and is now in the

Uriconium. The inscription appears to be DICINIVMA, which Mr. Wright renders *Dicinivi manu*, "by the hand of Dicinivus." Other relics to be examined are interesting remains from the workshops of an enameller and of a worker in metals. There are also roundels of pot which have evidently been rubbed into form for playing the game we now call "hop-scotch," or some other game known to Roman boys; and some children's toys.

Among the human remains are several skulls, and other portions of skeletons, which have been exhumed in different parts of Uriconium. One great feature of these is the large proportion of deformed skulls—more than one half of the examples being more or less out of natural form. It is conjectured that this deformity is not congenital, but posthumous, and has been brought about by the peculiar acidity in the soil having softened the bone, and rendered it liable to be pressed out of shape by the weight of the superincumbent soil.

The recent acquisition to the Museum of the fine collection of Roman coins formed by Mr. Stubbs, of Wroxeter, is a very important addition, and one that increases not only its value, but its historical interest.

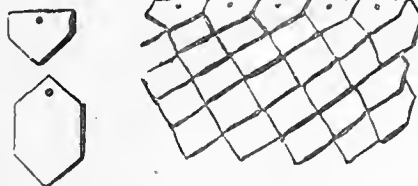
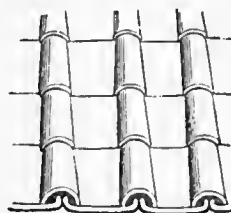

ROOFING-FLAGS AND ROOF-TILES.

PREPARATIONS FOR THE EXHIBITION OF 1871.

CHEERFUL expectation prevails at Kensington as to the promise of the Exhibition of 1871. From the forms prescribed for the English applications it cannot as yet be at all calculated how much space is actually demanded, but no falling-off is anticipated. Assurances of foreign support are more definite, and not less satisfactory. The two gigantic combatants whose struggle arrests the attention of the world, find time and thought to promise a rivalry of a more peaceful kind. Berlin will send an assortment of porcelain from the Royal Manufactory. Dusseldorf will exhibit pictures and statues from the galleries of the Academy. Munich will occupy with Fine Art exhibits all the space she can obtain.

The French deserve no small degree of applause for their pluck and liberality in providing a home for themselves in the International Exhibition. They have taken a piece of land from the Museum authorities on a seven years' lease, and erected a building around three sides of a quadrangle, at their sole expense. The present provisional government of France has confirmed the proceedings of its predecessors, and sent over encouragement and promises by aerial post. The one point in which the French have made, as we cannot doubt, a great error, is in the roofing and lighting of their halls. These rooms are of the same width as the English galleries, we previously described, namely, 30 feet: they are 27 feet high. The ceilings are flat, with a louvre light in the centre, and the result is, that there is a blank, box-like space between the louvre light and the ceiling; while both that surface itself and the whole of the upper part of the gallery is thrown into dense shadow. The object is said to have been to secure ample wall-space for the display of tapestries or painting. At any rate, it is a serious blunder, which contrasts very strongly with the good lighting of the English galleries. We regret this all the more from the spirit and liberality evinced by our French friends, who have shown an amount of moral courage and good faith in the matter which deserves to be fully appreciated.

The northern aisle of the Royal Horticultural Conservatory is to be widened and altered in form, so as to form a rain-proof court immediately adjoining the Albert Hall. The large upper corridor of this building is also being prepared for the display of pictures on the occasions of the International Exhibition. There will thus be a continuous covered walk along the 1,200 feet of gallery, through the circular passage and conservatory, round the corridor of the amphitheatre, and so down to the gallery on the west of the gardens, which is of equal length with that opposite. When it is remembered that these galleries cover two floors, and that the French Court has to be taken in addition, it will evidently be a good day's work only to look through the exhibition.

The French Courts will present the more interest, if filled, as it is proposed, from the distinctly national character of the contents, inasmuch as the general arrangement of the Exhibition will be according to classes, and not according to countries. Another feature which will be novel, and, we trust, instructive, will be the display of architectural drawings. Continental architecture will be fairly represented; and, we trust that the architects of this country will not allow the verdict to go against them, for want of putting in an appearance.

No prizes will be awarded, but certificates will be issued showing that the parties receiving them had the distinction of displaying their products in this Exhibition.

We shall not fail to lay before our readers, from month to month, such information with respect to the Exhibition as may be useful to artists and manufacturers. It is evident that the scheme is not likely to prove a failure from want of energy in the directors. The period for the reception of exhibits extends from Wednesday, February 1, to Tuesday, February 28; but each day has its appointed objects of reception.

ALEXANDRA PARK.

THE extreme importance which, in the opinion of all considerate people, attaches to the preservation of an open park of 400 acres in the centre of a district now so rapidly becoming covered with buildings as is northern London, has been the reason of our calling the attention of our readers to the subject of the Alexandra Park, with an iteration which we should not have thought proper had the case been one of private speculation. With the turn of the year the condition of this great property has undergone a change. The schism among the proprietors has been ended by the efficient method of the majority purchasing the interest of the minority. The palace and the park, in consequence, may now be regarded as the joint property of the London Financial Company, and of Messrs. Kelk and Lucas, the contractors. More respectable proprietors could not easily be named; and this arrangement constitutes a guarantee that any *bona-fide* and adequate offer to purchase the park and palace for the purpose of a great centre for elevating recreation and instruction, such as has been suggested by Mr. Fuller, will receive proper and candid consideration.

For the first time, then, in its history, the park is in a condition to be sold. Vendors are to be found able, and no doubt willing, to sell. The question now is, who and where is the purchaser?

We believe it is no secret that for some time past an attempt has been made to get hold of the Alexandra Palace for purposes the very opposite of those which have been advocated in our columns. It is to be taken as matter of course that such offers will now be likely to assume a tangible form. The attempt to naturalise amongst us forms of amusement for which certain establishments in Paris have an evil notoriety, can be unknown to but few of our readers, however apt we all are to be silent on such topics. It should be borne in mind that attractions of the nature to which we refer are generally supported by a lavish expenditure of money. It must be expected, therefore, that the proprietors of the park may be plied with financial arguments to allow their property to pass into hands which might, indeed, pay a golden price, but as to the cleanliness of which little can be said.

It remains, then, for the residents to decide the question for themselves. Numerous public meetings have been held, and thirty-two sub-committees have been formed, for the preservation of the property for the people. A different task now lies before these gentlemen from any they have yet attempted. The matter has now to be looked at in a business point of view. No general promises of support, or prognostications of success, will have any value. If the residents and those interested in the spot desire to purchase the property, they must at once be prepared to fulfil the essential condition of a contract for that purpose, the payment of an adequate deposit. Of course we do not mean that such a deposit is to be placed in the hands of the vendors. Proper trustees should be appointed; authorised—on the one hand, to satisfy the vendors that a sum is *in esse* adequate to prove the serious character of any offer made to them; and, on the other hand, to satisfy the subscribers that their funds will not be parted with until full guarantees are given as to the completion of the railway to the palace by a fixed date, the completion of the gymnasium and other unfinished works, and the execution of a definitive contract of sale in pursuance of mutually agreed conditions. If this be done, there will be no difficulty in securing the property from bisection into tea-garden and building lots. We do not speak of the details of any proposed scheme. We are anxious for one object—the securing of the property, in its unity, to the country. If the public put their shoulder to the wheel now, it is theirs; if they hesitate, it is lost. This is the last time of asking; and it will be deplorable to find the opportunity for acquiring the property—most valuable to the general community—and devoting it to some good and legitimate purpose, gone for ever.

THE ALBERT HALL.

THE Queen went to South Kensington on the 3rd instant, to inspect the condition of the building of the Albert Hall.

Her Majesty examined the *terra-cotta* frieze, which will form so prominent a feature in the external aspect of the building, and was conducted through the interior of the edifice, in order to observe the progress made in the fitting-up, and to witness the acoustic experiments which were made as to the resonance of the building. A lady and a little boy sang without accompaniment, and a violin was also introduced. The effect was surprising. In all parts of the vast building, calculated to hold 10,000 persons, the softest note of the singer was clearly and distinctly heard. As for the violin, it sounded as if close by—in whatever part of the building the auditor stood. It seems probable that the effect of the magnificent organ Mr. Willis is now erecting, and which promises to be the largest in the country, will be absolutely overpowering. Much, of course, will depend on the organist; but the effect of the volume of sound on the glass ceiling will require careful attention.

The organ consists of five claviers, each of which may, in fact, be regarded as a complete instrument. The pedal organ consists of twenty-one stops, the choir organ of twenty, the great organ of twenty-five, the swell of twenty-five, and the solo organ of twenty. Some of the stops, such as the baritone in the swell, are now for the first time introduced. Each stop consists in the manual claviers of sixty-one notes, and in the pedal organ of thirty-two—the pipes for the diapason being 32 feet long. The air is supplied to the feeders by steam-power. The front pipes are made of ninety parts of tin to ten parts of lead, and the interior pipes of five-ninths tin and four-ninths lead: the elaborate design is carried out with the most consummate workmanship.

A gore, or gusset, of the glass roof was exposed to view. The effect appeared far from satisfactory, as the treatment was such as to suggest the idea of an iron grating; this will, no doubt, be remedied. An architecturally decorative design for the glass ceiling is indispensable; and if this be happily carried out, the interior of this large hall will be as charming as it is thoroughly original.

To the designs for the frieze, the cartoons for which were prepared by Messrs. Armstead; Armitage, A.R.A.; Horsley, R.A.; Marks; Pickersgill, R.A.; Poynter, A.R.A.; and Yeames, A.R.A., we purpose to revert when the weather will allow of careful inspection.

On the adjoining Albert Memorial (the best view of which is that commanded from the balcony of the Albert Hall), the group of sculpture representing Europe was unveiled for the Queen's inspection. As in the case of the frieze, the state of the weather was such as to preclude any detailed criticism. From our point of view, however, the figure of the nymph seated on the bull appeared heavily to overbalance her *monture*. We hope this want of balance may be less observable from below.

Whether this immense hall will succeed is, at the least, questionable: it may be too far from the centre of London to attract visitors in crowds, and not be often "filled," although there is a large and an increasing local population; but there can be no doubt the hall will be an important and valuable acquisition to the metropolis, and especially to its wealthiest suburb of Kensington, and the whole district south-west of Hyde Park. It must be considered, moreover, as an adjunct to the Horticultural Gardens and its huge conservatories. Taken together, there will be nothing so effective in Europe; while the Museum of South Kensington, close at hand, and the gallery running south of the garden, will be always an additional source of gratification and instruction to the thousands by whom the hall will certainly be visited at all periods of the year.

Perhaps, if regarded merely as a speculation for profit, it may be a failure—this is more than probable; but it is to be looked at in another and better light, and if so it will be a success.

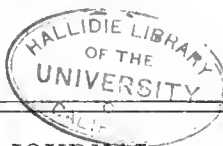

SOCIETY OF PAINTERS IN WATER-COLOURS.

NINTH WINTER EXHIBITION.

THIS Gallery, since last it was open, has sustained a serious loss in the secession of two important members, Mr. Burton and Mr. Burne Jones. The cause of the division was the removal by the committee of a nude picture painted by Mr. Jones, which is said to have given offence to a few squeamish visitors. That the society cannot manage its affairs without coming to open rupture, says little for the discretion or business tact of those in authority. Had a like disturbance taken place within the Academy, that much-abused body would have been denounced in no measured terms. We fear it must be admitted that the Old Water-Colour Society is merely a private body without public duties or responsibilities; that its members seek individual ends, and do not care to take a large view of the interests of Art. The calamity which has now fallen upon the body could not have happened at a time more unfortunate. The Academy, in the possession of spacious galleries, assumes, even unintentionally, a rival position. Accordingly, some water-colour painters are taking to oils, others have tried their fortunes in the water-colour gallery of the Academy. It is at such a moment, when it behoved the old Society to gather its forces together, that two strong men are lost to the cause. The public may be pleased to know that what is the loss of one Society will be the gain of some other exhibition. We shall doubtless have the satisfaction of greeting Mr. Burton and Mr. Burne Jones in another place. In the meantime, the old gallery has made some effort to repair its calamity. Little time has been lost for the election of the best among numerous candidates. Mr. Deane has been brought over from the Institute; Mr. Dobson, A.R.A., consents to divide his talents between Piccadilly and Pall Mall; and Mr. Marsh, a fellow-student of Mr. Watson, also kindly offers to pull the Society through what the council may have deemed a crisis. On the whole the Exhibition suffers less than might have been feared.

The most remarkable drawings in the room are due to Mr. Walker. Graceful as a composition by Stothard is 'The Sketch for Illustration to Miss Thackeray's "Village on the Cliff"' (385). The artist evinces his versatility, his readiness of resource, by the range of his topics, and the variety of his compositions. 'An Amateur' (379), takes the spectator by surprise: the subject has nothing to do with the Fine Arts, but relates solely to a cabbage-field. An old fellow toddles out of doors, and eyes his plenteous crop with the zest of an "amateur." Thus, as is well-known, some of the best pictures may be made out of trifles. Next comes a 'Sketch' (381), after the manner of an etching, for a picture long to be remembered in the Academy—the gipsies, or the wanderers. The nobility of the chief figure is here retained; indeed, it is remarkable how much of grandeur is thrown into minuteness, how much largeness there is on the scale of a miniature. The artist's chief contribution (334) is without a name. So small as to be only suited for the screen, it is full of material. In the foreground float swans and a pleasure-boat, better drawn than is usual on this scale; upon the shore beyond are villagers; into the background defiantly are thrown houses as red as red can be—a gratuitous difficulty which few painters would have dared to encounter is here used as a climax of colour. We are not accustomed to indulge in terms of unmitigated praise, and perhaps it would have been more in accordance with critical usage to pick out the blemishes of these exceptional productions. But Mr. Walker has mitigated his faults; his errors are now but eccentricities; he may be sometimes wrong, but he is always original; and though his manner is strongly pronounced, he seldom, if ever, repeats himself. Mr. Pinwell is a near approach to Mr. Walker; perhaps more, however, in foxiness of colour and lavish use of opaque than in conception. In each master, however, may be traced like peculiarities in composition: the materials

are apt to fall about for want of coherence, the scattered figures are not brought together under symmetric law; in short, it often happens, as 'At the Foot of the Quantocks' (103), that the picture is not one picture, but many pictures. This defect is analogous to that of a novelist, who, instead of weaving characters into one story, should leave each personage an isolated portrait. It appears to us, indeed, doubtful whether Mr. Pinwell can ever make himself either a dramatist or a colourist. And yet it must be admitted that there is no more dramatic composition in the room than 'Landlord and Tenant' (272); though, as a composition, the landlord stands at too great a distance from the tenant. The difficulty which this painter has never been quite able to get over is how to treat his picture as a whole: the parts—as, for instance, that lovely and pathetic group, the poor mother with two starving children clinging to her—are scarcely short of perfect. To look at a group thus skilfully composed gives to an artistic eye infinite pleasure. Not to see these drawings by Mr. Walker and Mr. Pinwell would be indeed to miss an exquisite delight.

In the rank of figure-pictures the gallery contains many works to interest; indeed, the idea of an exhibition of "Sketches and Studies" is to bring together much which may be attractive even in its incompleteness—odds and ends of study having little claim to be faultless in the carrying out. An artist always confers a favour when he enables one of the outside public to understand the processes, the successive steps, by which he arrives at his results. Thus, we thank Mr. Lamont for this 'Sketch for the Picture of Gasgerion' (75), a work which may be accepted as a masterpiece. 'Hawking' (83), by the same artist, is enough to show artistic intuitions: the lines of the figures are disposed expressly to respond to the curve of the stately stairs whereon the hawking-party descends. Mr. Lamont in these sketches displays that indecision in touch which has prejudiced his mature productions. Mr. Lundgren becomes more and more indefinite in form: 'An Eastern Girl' (198) is lumpy; 'The Stolen Kiss' (156) is to be commended by little else than Eastern colour; and that the artist should have colour of any sort, Eastern or otherwise, is more than could be expected, seeing that he was born of the colour-blind school of Scandinavia. But Mr. Lundgren has travelled far and wide from Stockholm, his birthplace; hence he favours us with 'Spanish Peasant-Girls, and a Peasant's House, Spain' (250): these we account the nearest approach to nature he now cares to exhibit. The more recent productions of Mr. Carl Haag are open to like criticism: the colour is hot, the costume showy, the sentiment false. On 'Monks at their Devotion' (286), a more sober work, we gladly dwell as doing most justice to an artist who has produced, when, as a pioneer, he sketched in Jerusalem and Palmyra, good work, ever to be held in grateful memory.

Mr. John Gilbert does not exhibit the kind of drawings we could hope to see in a gallery expressly set apart for sketches. His portfolios must teem with studies; but painters are too wily to disclose the secrets of their studios; hence these winter exhibitions miss their original purpose, and now vary only in quality and not in kind from the chief exhibition of the year, that of the spring. We thank, however, Mr. Gilbert heartily for a noble Rembrandt-like study of Henry IV. in act of soliloquising 'Sleep, O gentle Sleep!' A place of honour has fitly been given to 'A Welsh Stream' (170), after the happiest manner of Mr. Topham. Mr. Smallfield again shows himself one of the most prolific of painters: he is evidently gifted with uncommon fertility of ideas; and there seems reason indeed to believe that Mr. Marks owes to him the first thought of 'St. Francis preaching to the Birds,' in last year's exhibition of the Academy. Yet the original scheme (291) now exhibited for Mr. Smallfield's large drawing differs materially from the composition by Mr. Marks. The charge of plagiarism is too easily made to be always just: in the present case it is not hard to believe that so obvious and so tempting a subject as that of St. Francis and the birds may have suggested itself to both artists at the

same time. Mr. Smallfield's happiest thought is 'Come and see the new Moon' (115). A wee child has started from bed in glee to look at the little moon through the casement, the figure is graceful, the draperies are well cast, the colouring is silvery. Also supremely graceful is an adjacent drawing 'Idle Moments' (118), by E. K. Johnson, an artist who from the first has shown a cleverness and a style more common in Paris than in London. Mr. Watson, a member, and Mr. Marsh the latest of associates, may be deemed brothers in Art: they were born alike in the north country; they have painted together; and they even use the same model. The similarity of styles becomes at once apparent on comparison of Mr. Watson's 'Limpit Gatherer' (58) with Mr. Marsh's 'Pilot' (50). The drawings with which Mr. Marsh makes his entry scarcely justify his election. They are somewhat heavy and wooden at present, but we hope they may improve. Mr. Dobson, A.R.A., another new election, will be of great service to the gallery, if we can take his first contribution, 'St. Agatha' (350), as an average specimen of what we may expect. The artist gains in water-colours a transparency and brilliance foreign to his oil-pictures. He has been most fortunate in his model, and is no less felicitous in the treatment. The handling is facile, especially in the glowing hair: Mr. Dobson has of late been freeing himself from the fixity and opacity of the Germans, to whom he was long committed. We would gladly pass from Mr. Shields in silence, but the heads he exhibits are too large and egregious to be overlooked: it is long since an artist has fallen into such deplorable error.

The landscape-painters do not turn out from their portfolios so many scraps and sketches as we should like to see; perhaps the reason may be that sketching in the old sense of the word is growing obsolete—one of the lost Arts. The habit now is to carry a sketch through many days, till at last towards the end of the first or the second week, it ceases to be a sketch and becomes a picture. Mr. Richardson, however, favours us with a sketch which, after the olden manner, might be dashed off in a summer's afternoon. 'Falls of the Bruan' (303) possibly dates back to the time of Harding, who may be taken as a type of what a sketched used to be before Pre-Raffaellism was dreamt of. V. Bartholomew brings to light an 'Original Sketch from Nature' (177), which, if we mistake not, was made years ago, in a continental tour taken with J. D. Harding as companion. The scene is the now dismantled fortress of Luxembourg: the towers at present razed to the ground are seen as yet standing. Among sketches which have more dash and vitality than finished pictures by the same artists, we would approvingly mention 'Off the Great Orme's Head' (161), by J. W. Whittaker. The drawings of Mr. Whittaker have latterly shown a care which is of less worth than the carelessness formerly accepted because artistic. Mr. Collingwood Smith is another painter who is apt to be uncertain: 'Fishing Boats waiting for the Tide at Sunrise, Hastings' (22), is happy in effect both in sky and in water. Sunsets are but too common in our picture-galleries: we thank the artist who gets up betimes to give us a sunrise. The public, too, will be grateful to E. A. Goodall for 'Verignano, Gulf of Spezia' (54)—a brilliant rendering of a lovely Italian scene which every traveller holds dear. Perhaps, however, the artist who of all others catches most truly and rapturously the poetry and romance of Italy is Arthur Glennie. 'Ancient Ruins under Tasso's House, Sorrento' (245); 'Ponte Salvo, Campagna di Roma'; and 'View of Civita Castellana' (282), recall happy days in Italy when the sky is serene and bright; and ruined bridge and desolated plain suggest a thousand historic associations. Alfred Hunt has lately returned from southern and eastern lands: his eye and imagination have for some time turned towards the rising sun and climes wherein light and colour are an ecstasy and romance. We accept 'The Acropolis, Athens, from the Ilissus' (242), with other drawings on the borders of the Mediterranean, as a foretaste of the fruits we may hope to gather from the artist's journeyings among classic and poetic lands. It is curious to mark, even in a small and comparatively circum-

scribed exhibition like the present, how each latitude calls for a distinctive pictorial treatment—how the artist who has sobered his style in Wales, or Scotland, is thereby incapacitated for southern lands, with their crystalline sky and coloured halo of atmosphere. Even Thomas Danby, who, by parentage and adopted style, may be said to hold a middle course between north and south, prose and poetry, is more at home in the neighbourhood of Snowdon than in the region of the Alps. At any rate, 'The Moleson, Switzerland' (152), is all but identical with scenes which this artist has for many years brought with him to London from Bet-tws-y-Coed and Capel Curig. Mr. Naftel is gaining in tone and delicacy: 'Autumn Moon' (361) has none of the crudeness of his earlier efforts.

The exhibition wears its accustomed aspect in the presence of works which, at a glance, are identified with Birket Foster, C. Davidson, C. Branwhite, Alfred Newton, E. A. Goodall, Francis Powell—not to mention other names which, as a matter of course, swell the collection. Mr. Foster contributes sparkling gems, such as 'The Greta, at Rokeby' (48) and 'Houses at Eton' (79); the execution is far too clean and neat for sketches out of doors; the presumption becomes strong that these are studio works—so, doubtless, are the many powerful productions of Mr. Branwhite. An artist may successfully assume the slight manner of a sketch; but the accident and zest and rapid dash of out-door work cannot be got in the measured methods of the studio. Mr. Branwhite's drawings have never looked better upon these walls than of late: the colour has become more rich and less heavy, and the breadth preserved gives unaccustomed force. Mr. Alfred Newton sometimes carries breadth too far; yet 'Moonlight' (158), if a little over-spectral and stoney, is impressive. The drawing is entered as "a study"—a word sometimes used as an apology for incompleteness. The amount of study needed can scarcely have been very great, inasmuch as the artist has so often favoured us with this sort of thing before, that instead of "a study" he might have called his performance "a replica." Mr. Boyce is still an enigma, and the mystery which encircles his style is scarcely nearer solution by the ten examples he kindly gives of his manner. The strange fascination of these drawings may be in part explained by their unusual combination of poetry with prose—the infusion of ardour into literal fact. Two sketches of 'An old Fortified House in Northumberland' (233), have the precision of architectural drawings; on the other hand, the artist, in 'The Roman Dyke at Dorchester' (338), becomes joyous and bright as the poet of nature. Mr. Powell, it is evident, has not touched the turning-point when a painter retraces his steps and begins to repeat himself. 'Carrick Castle, Loch Goil' (160), is the artist's most mature work: the colour is so managed as to induce harmony out of variety; the warm tone on the hills is balanced by a grey sky full of rain-clouds; the relative distances are truly kept; the idea of space and scale are well conveyed. But such a work, having no pretence to be either a sketch or a study, is one of the many instances of how completely this exhibition has been perverted from its original intent. Mr. Powell makes amends by his frame full of jottings from nature.

The society has gathered to itself some of the most skilled architectural draughtsmen, also one or two of the best animal-painters of the present day. Mr. Basil Bradley, as appropriate to the moment, contributes 'French Horses' (207), a sketch made in Paris. These noble creatures are of the breed chosen by Rosa Bonheur for 'The Horse-Fair.' The gallery is fortunate in having gained over from its rival, the Institute, an architectural painter so adroit as Mr. Deane. This newly-elected associate may, by brilliant scenes in Venice, fill, in some measure, the void felt on the decease of Mr. Holland. Three of the most valued members—Mr. Palmer, Mr. Alfred Fripp, and Mr. George Fripp—reserve themselves for the Spring Exhibition. Indeed, in conclusion, we may remark that this winter gathering favours the associates, inasmuch as the usual restriction as to the number of drawings permitted to them is removed.

SOCIETY OF BRITISH ARTISTS.

WINTER EXHIBITION.

SUFFOLK-STREET artists, encouraged by the success which has crowned the efforts of other societies, have opened a first Winter Exhibition. With advantage, part of the vast gallery has been kindly lent for the exhibition in aid of the distressed French peasantry, thus this winter collection is in extent less wearisome than that of the spring. The quality of the works displayed is just what might be anticipated from the well-known antecedents of Suffolk Street. And once again the interest is not in what is fore-known, but in what comes by surprise; not in the somewhat conventional contributions of the members, but in the wayward and sudden spurts of genius from outsiders. Thus though many may incline to think this last addition to winter exhibitions is one too many, still we gladly acknowledge that a circuit through the rooms discovers not a few works, pleasant and of promise, which we should have regretted to miss.

Of special interest are some dozen pictures collected as a tribute to the memory of J. B. Pyne, a valued member of the Society. An epitome of a brilliant, though somewhat mistaken, career is given in the following highly-coloured, but artificial, works, grouped effectively on one wall: 'Castello Dangeria, Lago Maggiore' (301); 'San Giorgio Maggiore, Venice' (506); 'Isola Piscatore, Lago Maggiore' (507); and 'Ulleswater' (510). The vices of the style are evident at a glance, and yet these landscapes are resplendent as visions—ecstatic creations of the imagination. A comparatively sober and solid drawing, 'Teatro Malibran, Venice' (379), indicates that had Pyne looked less to Turner and more to nature, he could have won, not an ephemeral, but an enduring reputation; instead of a meteor blazing in the sky, his name might have shone among the fixed stars. Turning to 'Sunshine and Mist on the Welsh Hills' (250), we are tempted to use a hackneyed simile, and say that the mantle of Mr. Pyne has descended on the shoulders of Mr. Harry Johnson. We add, with pleasure, that a son of the late Mr. Pyne shares the inheritance of genius, *vide* 'Borrowdale' (93). Mr. J. Danby traces his pedigree as a colourist direct from his own father, but, as with other mannerists, he is best when—as in a study 'Near Bournemouth' (52)—he consents to paint nothing more than he sees. A day or two since, in a private collection, we met with a sketch of Lyme-mouth beach, made on the spot, by Francis Danby, the father: the varied harmony of greys was more exquisite than the blaze of sunset which became habitual to the artist. The son will improve his Art by reverting to nature in her quiet moods. But some painters indulge in greys even to monotony; thus H. Moore paints 'A Grey Morning in the Downs' (27), lovely in silvery light, yet almost too much of a *replica* of the many sea-pieces and coast-scenes before exhibited. Mr. W. L. Wyllie, another artist of signal promise is also in danger of falling into leaden monotonies; and yet we gladly observe that he has, since last we met him, opened new veins which seem likely to yield rich ore with little admixture of baser metal. 'The Beach in Winter' (47) is marked by originality. 'The Northern Lights' (70), though not scintillating sufficiently, prove an observant eye for atmospheric phenomena; while 'A Back-water on the Thames' (156) shows a versatile turn for swans and water-lilies. In these rooms no artist is of greater promise than young Mr. Wyllie.

Messrs. Pettitt, Percy, and Panton, produce pictures after a style habitual to Suffolk Street: 'The Frontier' (118), by the first, is large and ambitious; 'Borrowdale' (499) recalls the best manner of Mr. Percy, who, with his brother Boddington, was for years an ornament to the gallery. These rooms have bright, no less than gloomy, recollections. Mr. Wainwright, another *habitué*, is seen at his best in a placid, pleasing picture, 'A Summer's Evening' (35): the colour and effect are charming; though the texture and execution strike one as lacking vigour, individuality, and variety. 'A Sketch of the Bass

Rock' (221), by J. P. Haverfield, makes a pretty little picture. Mr. Clint, President of the Society, shows by a sketch, 'At Minehead' (528), how much better it would have been for him to have worked out of doors than within his studio. The members of this Society generally have a pernicious habit of doctoring up their pictures for public display. The accepted use of a winter exhibition is in the opportunity afforded for bringing under view sketches and studies. Mr. Heaphy has availed himself of this advantage in some capital materials for pictures: 'The Secret Chamber' (7), 'The Forgotten Deed-chest' (10), and 'The Tapestry Chamber' (11). These and other like studies for backgrounds and accessories indicate with how much deliberate forethought Mr. Heaphy prepared himself for the vocation of an historic painter. C. Lucy, also known in the high sphere of history, affords pleasant insight into accessory work, the by-play to more arduous efforts, in a conscientious transcript of 'Llandudno, with Great Orme's Head' (522). The outlines undulate delicately, while the modelling of the hill seems to tell that the artist descended upon landscape from the higher walk of figure-painting.

The small room devoted to water-colours is, like the "large room" held by oils, just redeemed from mediocrity. 'Lichtenstein Castle' (310), and 'Dorothy Vernon's Walk, Haddon Hall' (453), are good examples of the well-esteemed style of S. Rayner. 'Distant View of Wickham Church' (344) is more favourable to Mr. Tennant than his oil-pictures. It is a pity that some of the habitual frequenters of this gallery have not adhered to water-colours all their lives: oils, as a rule, call for more deliberate study. The brilliant sketches of Mr. Spiers are always welcome: one of the best we have seen is 'The Great Doorway of the Temple of Jupiter, Baalbec' (413). Miss Gilbert and F. Slocombe contribute clever figures: H. A. Harper and J. J. Curnock exhibit drawings felicitous in sunset colour. 'Evening Glow' (429) is the most poetic and artistic landscape we have yet noticed by Mr. Curnock, a rising young painter.

Returning to the large room, the Suffolk Street school shows off its genius unmistakably. Messrs. Barnes, Baxter, W. Bromley, Cobbett, Gow, Levin, Ludovici, Roberts, Woolmer, are birds of a feather who wisely flock together. Mr. Barnes, though abundantly clever, seems intent on exaggerating his faults; we were scarcely prepared for the 'Return from the Well' (94). Mr. Baxter, well qualified to illustrate books of beauty, when painting the lady 'In doubt' (180) again falls into waxiness. Mr. Mann's 'Study of a Head' (533) has, with Mr. Baxter's figures, cognate beauty—a trait of which we are not likely to be tired under the prevailing aspects of the English school. We may commend, in passing, Mrs. Charretie's 'Chezelle' (188); also a charming little scene, 'The Playmates' (280), by G. H. Garraway; likewise 'A Wanderer' (285), by C. Rossiter. C. Bauerle, the German, to whom we owed the only reputable royal picture in the last exhibition of the Academy, is also gifted with a sense of beauty rare as it is delightful in its results. There is no more pleasure-giving picture in the room than 'Happy Childhood' (131). We question, however, whether this artist will prove himself as strong as he is undoubtedly refined: his drawing is not a match for his delicacy: one of the hands, for example, is in size and character out of all keeping with the head to which it belongs. Mr. Clarke's agreeable group, 'Being Plucked' (115) has also more tone than form: the execution wants definition, just, in short, the vigorous touch which Miss Backhouse has thrown into her masterly study, 'Spring and Autumn' (81). Reverting to the members we have a 'Rustic Courtship' (91)—that is, a conventional courtship—by W. Bromley; also, by E. Holmes, groups of peasants and goats going 'Homeward' (92), according to conventional pictorial prescriptions. Dreary in the extreme are such well-meant but soulless efforts. 'The Beach' (155)—young ladies reading under shelter of a boat, by T. Roberts, though not particularly novel, is fairly well painted. 'A Study' (18), by J. Gow, wants what study gives, knowledge and drawing: the artist, it may

be hoped, will not stop his studies at this point. 'The Poet' (138), by A. J. Woolmer, is, as usual, far too poetic for a prosaic world to appreciate. More hopeful for the cause of truth is the literalness which J. Morgan brings to bear on 'The Men that man the Life-boat' (266). Each figure might be a portrait. As an example of how much good talent may be misdirected and lost by painters who keep each other in countenance by cherishing faults they possess in common, we will point to a simple unspoilt study of a 'Sandbank' (160), by E. J. Cobbett. It is scarcely credible that an artist who can turn out honest work like this, whenever he cares to go to nature, should perpetrate 'The Fern-gatherers' (32).

In this gallery one class of contributors is dull, another class extravagant. A. H. Tourrier, whose works we have often commended, is in danger of falling into the latter extreme. 'A Visit to the Wise Woman' (34) seeks effect with strange indifference to truth. Mr. Valentine Bromley, whom we have again and again applauded in the Institute and elsewhere, also shows himself in danger of passing the limits of moderation in that extravagant picture, 'Loves' Song' (75). And yet soon he is himself again in 'Waiting' (234): a lover's meeting in a wood, well conceived and well carried out. 'The Vineyard Watch' (76) is perhaps as near to nature as genius so astounding as that of P. Levin will ever care to approach. We are rather alarmed to see a second Ludovici in the field; and yet if he paint nothing worse than 'Bonheur au cinquième étage' (80), a work which bears the name "A Ludovici, jun.," we need fear little harm. But in certain galleries it is impossible to predict what an artist may some day come to.

It is pleasant, if possible, to end with commendation; and this is scarcely hard in the presence of the 'Cottage Interior' (42), by W. Hemsley, one of most valued of "members." The picture has sparkle yet solidity: it is Dutch in technique, yet in sentiment truly English. 'Patchwork' (124), by Haynes King, another member, is also true and honest in work. E. Vedder, the American, who resides in Rome, sends a clever study of 'A Roman Girl' (163). 'A Breton Peasant' (66) shows the careful steady work to which we have been long accustomed from C. S. Lidderdale. 'A Study' (256), by J. Burr, it is not easy to commend: in aiming at colour and sentiment, the artist has been far too negligent of precise forms and stern facts. Close by hangs a sketch, by F. Holl, 'Up a Court at Whithy' (241), supreme in mastery: the boy is worthy of Murillo's pencil: the treatment is broad; the handling, though professedly sketchy, goes direct to the desired ends. The excellent works which we have been able to single out indicate that the Suffolk Street Gallery has not materially suffered under the sharp competition incident to the constantly increasing number of public exhibitions.

GELATINE,

AND ITS APPLICATIONS TO THE REQUIREMENTS OF ART.

THE three great non-metallic photographic processes, of which we have given a brief description in the last two numbers of the *Art-Journal*, are entirely dependent upon the peculiar properties of the substance called gelatine. But little is generally known of the origin, nature, mode of preparation, and general application of this material, which is likely to assume considerable importance in various branches of Industrial Art. We think that our readers will take interest in a brief notice of such information as we have been able to collect, both from those who use, and from those who prepare, what is, in fact, an edible substance.

Gelatine is one of those partially transparent bodies, readily soluble in water,

which owe their origin to the subtle process of organic life. Like glue, of which it may be called a refined variety, and like gum Arabic, which it more closely resembles in appearance, it is a material which the chemist has never been able to construct out of the simple elements into which he can so readily reduce it. In obedience to the action of heat, to the chemical effect of certain salts, and to the actinic rays which accompany the blue light from the sun, its properties are special, and of great importance. It may be dealt with as if it were a bitumen, or a glass, or a mineral substance of inorganic origin; and few persons would be ready to imagine that the clear brown, semi-transparent plate, which may, at will, be either rendered as hard and insoluble as horn, or washed away in a bath of tepid water, originates in an animal tissue, and was originally manufactured, not for the sun-painter, but for the cook.

The constituent elements of pure gelatine, omitting fractions, are as follows. Fifty parts, by weight of carbon, twenty-five of oxygen, eighteen of nitrogen, and seven of hydrogen, form a hundred equivalents of gelatine. How far the great difference in purity that is to be found existing between the finer and the coarser qualities prepared by the manufacturer, may depend on some slight modification of the above proportions cannot at present be decided. In actual practice it is by extreme care in selection of the materials, and in the removal of all adherent impurities, that the difference of quality is principally secured.

Very many animal substances contain gelatine. Our habitual association of the brightly-coloured jellies that make the circuit of the dining-table with the hoofs of the calf, under the time-honoured title of calves'-foot jelly, suggests one source of supply. Even bones contain much gelatine, which may be extracted for manufacture, but which is brittle and unsatisfactory in its character. The tusk of the elephant contains a gelatine which it is very desirable to have tested for artistic use. The price of such a product would be high; but the great superiority of the jelly made from ivory dust over any other is such as to suggest that a material of great service to Art may be produced from the waste of the ivory-turner. The fact of the production of glue from the bones and other parts of fish, as well as that of the delicate and costly species of gelatine known as isinglass from the intestines of the sturgeon, is generally known.

The gelatine which is principally, if not universally, used in this country for the purposes of Art, is prepared from the skins of the animals of which the flesh is sold by the butchers and consumed on the table. All adherent fat, flesh, and hair, is carefully removed, and the most delicate portions of the skin are set aside to form the finer gelatine—the "refined isinglass" of Messrs. Nelson. It is now some thirty years since the father of the present manufacturer took out a patent for the process. The skins, when properly cleaned, are treated with caustic potash, and submitted to a certain degree of heat, in steam-jacketed vessels. Thus manipulated, the animal matter undergoes a change somewhat similar to the fusion of metallic ore. The cellular tissue is destroyed; and a liquid mass results, which is run out to cool, as iron is run from the furnace into pigs. A second melting, as in the case of iron, is resorted to before the gelatine is fully prepared.

The great demand for the article is for gastronomic purposes. The sheets are cut, by revolving knives, into ribbons or threads

of various degrees of fineness, much as the paste of wheat-flour is formed by the Italian manufacturer into the coarser macaroni and the finer vermicelli. The more delicate sort would, until carefully examined, be mistaken for Russian isinglass. Some little familiarity with the simple but effective processes by which the manufacture of macaroni is carried on in Southern Italy would have led the English manufacturers, long ere this, to abandon the use of the knife for the more economical and mechanical method of passing the gelatine through a metal plate bored with numerous holes of requisite diameter, and drying the pendent threads by a fan. Finer and more regular ribbons of gelatine might thus be produced, we venture to suggest, at a diminished cost.

Opaque, transparent, amber, brilliant, and isinglass gelatines are all produced, and that in enormous quantities, and used as the basis of soups, gravies, blanc-mange, jellies, and creams. The product, under the hands of the cook, is superior to that of calves' feet, which will not, when similarly treated, produce so delicate a gelatine as that which is made from the skin. The only difference between the gelatine used for photography and that used for cooking is, that the former is cast into thin, regular plates, while the latter is cut up into ribbons. It is, perhaps, the first time in the history of Art, since the *tibia* of the long-shanked water-birds was formed into an instrument of music, that the Art-manufacturer has robbed the cook.

We must refer those of our readers who take more interest in the culinary than in the artistic value of patent gelatine to the chemical opinions of Dr Andrew Ure, and to the advertisements of Mr. Nelson. No doubt they have long had an intimate practical acquaintance with the product. We trust that in the various treatment by chromate of potash, chrome alum, carbon, and other chemical agents to which the gelatine plates are subjected, the edible character of the substance is qualified. Otherwise, in case of a siege or a famine, we shall be in danger of having all our Autotypes and Woodbury-types converted into broth. The Heliotypes will alone remain, although their production will be arrested; but our gelatine records will share the fate of the mycological library of the great botanist, Elias Fries, whose large collection of dried fungi was devoured by hungry French invaders. It is to be hoped that they cooked the toadstools before eating them.

The properties by which gelatine invites the attention of the Art-workman are of the rarest and most valuable character. The mere fact of the easy manner in which a readily soluble substance may be made insoluble is one of which advantage may be taken in a hundred ways. When to this is added the rare property of sensibility to light, or rather to actinic influence, it becomes clear that gelatine is but in its artistic infancy. A material which it is possible to chase, engrave, emboss, and model with a delicacy that mocks the microscope, and without the touch of human hand, which may be poured into a mould like gum, and hardened until it will impress its own relief, in intaglio, on a solid metal plate, is one that promises obedience to other artificers besides the copyist of landscape or of portrait. Nothing would be more easy, for instance, than to construct beautiful caskets of plates of gelatine, covered with arabesques, foliage, medallions, or any other enrichment, by photographic aid, hardened into the likeness of amber, or covered with gold, or illuminated

with gorgeous colour. Ornamental book-binding, again has here a serviceable material ready for use. Personal decoration—in the use of brooches, bracelets, necklaces, or other ornaments, depending for their charm on the beauty of design and delicacy of ornamentation, and not on value of material—all branches of plastic decoration in which greater delicacy is sought than can be attained by the worker in papier-mâché—for all these and many other purposes gelatine will hereafter be available.

We mentioned in our second paper on Heliography that chrome-alum renders gelatine insoluble. The mere steeping of a plate of gelatine in a solution of this substance has that effect. Bichromate of potash, on the other hand, renders gelatine so sensitive to light that, on its exposure to the sunbeam, a change is effected similar to that produced by the direct action of chrome-alum. When treated successively by bichromate of potash and chrome-alum, gelatine becomes insoluble, but capable of absorbing a certain quantity of water, and thus increasing in bulk. It is this property which has been made available by the inventor of the Heliotype in this country, and of the Albert-type in Germany. In the Woodbury-type the same substance is used as a vehicle of colour, and the *chiaroscuro* effects producible by gelatine ink upon paper, and even upon glass, are some of the most lovely that have yet been permanently rendered by any means whatever.

As to the essential nature of the changes so readily produced in this organic product, science has as yet given no certain sound. The causes of the behaviour, often apparently capricious, of those compounds which lie on the limits which separate organic from inorganic chemistry, are extremely obscure. It is probably in this very province that the greatest triumphs of the chemist will one day be obtained. Already he has gone so far as to produce delicate flavours exactly resembling those of fruit from the very refuse of the organic structure. The great aim of the most thoughtful minds is to advance yet a further step in this direction. The grand problem before the chemist of the present day is to place the synthetical part of his science on the same level as the analytical province. Direct chemical synthesis is, indeed, even now attainable, as in the case of the production of water by burning oxyhydrogen gas. The greater part of the synthetic triumph of the chemist, however, is attained by the means of double decomposition. Each element, while always following a definite order of preference for every other element, is most ready to enter into composition when in a nascent state, before, so to speak, it is thoroughly aware of its own identity. But in those substances which have been combined by the subtle chemistry of life, whether animal or vegetable, we have a class of products altogether, as yet, beyond the formative power of the chemist. He may transform, as in the case of gelatine, but he cannot, as yet, directly combine. That the conditions which allow of the association of the elements of protoplasm, the basis of organic structure, are rare and rigid, may be deduced from the fact that the direct synthesis of simple elements into organic structure, in the crucible heated by the vital flame, appears to be beyond the power of Nature herself. While taking up flint, lime, phosphorus, and other elements into animal and vegetable structures, she can only feed and augment the cellular substance of which these structures mainly consist upon chemical combinations formed ready to her hand. She can extract the

carbon, hydrogen, oxygen, and azote which, or some of which, form, in various proportions, not only gelatine, but the other elements of the living body, from water, ammonia, and carbonic acid. She cannot, so far as we know, assimilate them if directly presented to her. When, if ever, the time arrives that this secret of the Great Artificer is disclosed—when the chemist shall be able to make gelatine, fibrin, albumen, and other proximate elements of the living being, poverty will be at an end, and misery will bid fair to follow. For then we should be able to produce flour without aid of sun or soil, and broths for which no animal need be slaughtered. The attention which is now being paid to the use of gelatine, and especially to the influence of light upon its substance, is thus interesting to others besides the artist.

F. ROUBILIAC CONDER.

SHILLING ART-UNIONS.

THE administration of the country, whatever branch is responsible in the matter, is exercising a paternal interference in the matter of—*goose-clubs*. The wonted enlivenment of the Christmas week of many a country village—the customary raffle—is to be sternly forbidden, we are told, henceforth, by the men buttoned up in blue, acting under “superior authority.” As to the wisdom of this zeal for morality in humble life we do not profess to offer an opinion. One thing, however, is certain—the *goose-clubs* have not provoked Government repression by advertising that they are held under Government authority. The shilling Art-Unions do this every day. The *goose-clubs* are purely local, spontaneous, neighbourly—with a strong dash of the charitable element in them. The shilling Art-Unions are entirely got up by advertisement; intangible as to their directors and machinery, with more than a mixture of what the French call *exploitation* in them. The *goose-clubs*, if they do, indeed, infringe any law, do so in simple unacquaintance with the fact. The shilling Art-Unions, knowing how thoroughly they are opposed to the spirit, if not to the letter of legislation, hug themselves on the adroitness with which they make the negligence of the administration the main bait whereby they entrap the public. A little cheap credit may be obtained among some people by sharply snubbing this incipient form of rustic gambling. No such political capital appears to have suggested itself as readily available, by taking the steps demanded by public duty in the case of the shilling Art-Unions; and, therefore, they are allowed to go on and flourish. Very merrily they are at work. The other day placards, and advertisements, and flaming gas, and announcements in large letters “under Government authority,” induced us to enter one of these establishments. But we had our walk up for our pains. Nothing was to be seen there except the little scrap of paper announcing, in just the same language as last year, the drawing of 500 prizes “under Government authority.” But the “prize picture-gallery” was in quite another part of town. No specimens were to be seen at this office, which only took shillings on faith. We took the trouble of visiting the “prize picture-gallery.” We had been in the place before. The proprietors, however, had profited by our remarks on that occasion, for the number of specimens exhibited was greatly reduced, and, it is fair to add, their quality was somewhat improved. Not that this should be allowed to invalidate what we have previously urged. The essential features of the scheme are as objectionable as ever. The total absence of responsibility, the want of any check on the relation between the number of shillings taken and the value of prizes distributed, the beating up of the country for subscriptions, the parade of “Government authority” for a scheme the good faith of which it is so utterly impossible to verify—all this demands exposure and repression.

AMERICA.

FROM THE GROUP OF SCULPTURE BY JOHN BELL.

WE have for some time past been preparing a series of engravings from the allegorical sculptures that form a prominent feature in the ornamentation of the National Memorial of the late Prince Consort, in Hyde Park; while we reserve, till the completion of the work, whatever may be necessary to say concerning it as a whole.

The first of these groups is now introduced: it is that symbolising AMERICA, and is by John Bell, a sculptor whose works have long given him a leading position in his profession, and which this group, by its spirited and appropriate conception, and the vigorous yet refined manner of execution, cannot fail to increase.

The central figure represents AMERICA as a quarter of the globe, mounted on a bison, charging through the long prairie grass. Their advance is directed on the one side by the UNITED STATES, and on the other by CANADA, who presses the Rose of England to her bosom. The seated figures in the composition are MEXICO and SOUTH AMERICA. The details and emblems are as follows: the figure of America is of the Indian type; she is habited in native costume, and wears a feathered head-dress: the housings of her wild charger—a noble animal, by the way—are of the skin of a grisly bear. In her right hand is a stone-pointed lance, with Indian “totems” of the grey squirrel and humming-bird; and in her left she bears a shield with blazons of the principal divisions of the hemisphere—the eagle for the States; the beaver for Canada; the lone star for Chili; the volcanoes for Mexico; the alpaca for Peru; and the southern cross for Brazil. In the rear, aroused by the tread of the bison through the grass, is a rattlesnake.

The features of the figure representing the United States are of the North-American Anglo-Saxon type. Her tresses are surmounted by an eagle's plume and by a star, which is repeated on her baldric, and at the point of the sceptre in her right hand; while in her left is a wreath formed by leaves of the evergreen oak, as an emblem of the Northern States, and a blossom of the *Magnolia grandiflora* as that of the Southern. At her feet lies the Indian's quiver, with but one or two arrows in it.

Canada, who is habited in furs, shows features of a more English type. In her head-dress are woven the maple-leaf of the mainland, and the May-flower of Nova Scotia. In her right hand are ears of wheat—corn being one of her most important productions—and at her feet are a pair of snow-shoes, &c.

Mexico, a male figure, is characterised by a face somewhat of the Astec type: his emblems are a Mexican head-dress, staff, and feather-cincture; with the cochineal cactus at his feet. He is in the attitude of rising, restless and disturbed, from his panther's skin.

In the figure of South America, we appear to recognise the half-bred type, Indian and Spaniard: seated on a rock, he is habited in *sombrero* and *poncho*, and Indian girdle; in his left hand is the horseman's short carbine of the country, and in his right a lasso. Close to him is a Brazilian orchid, a horn of the wild cattle of the plains, &c.

It will be evident from these brief details how much of studied thought has been given to the entire composition.



AMERICA.

(THE ALBERT MEMORIAL, HYDE PARK.)

ENGRAVED BY W. ROFFE, FROM THE GROUP IN MARBLE BY JOHN BEAL



THE ROYAL ACADEMY.

ON Saturday the 10th of December, being the one hundred and second year of the foundation of the Academy, Sir Francis Grant, President, distributed the prizes annually awarded to successful students. The recipients were—

Mr. Frederick Cottman; for the best Painting from the life.

Mr. Douglas Miller; for the best Drawing from the life.

Mr. E. Hughes; for the best Drawing from the antique.

Mr. Abel Thornycroft; for the best Restoration from the antique.

Mr. William Gair; for the best Copy of a painting by an old master—the subject, Reynolds's Portrait of Sir William Chambers.

Mr. Walter Lonsdale was awarded the Architectural Travelling Studentship, for his design for a National Mausoleum.

Mr. Henry Hall; for the best Architectural Drawing.

Mr. Abel Thornycroft; for the best Model from the antique.

Mr. F. Cottman; a prize of £10 for the best Drawing from the life done at the Academy during the year.

Some important changes are in course of arrangement in the constitution of the Academy: the number of the council is to be largely augmented, and the "hangers" will hereafter consist of six, instead of three, members. These are improvements by which the institution cannot but greatly benefit; while they will serve to assure the profession generally, and the public, that the Academy is disposed to make progress corresponding with the advancement of the age.

The second exhibition of loan pictures collected under the auspices of the Royal Academy will be brought together too late for us to give any indication of its contents in our present Number. We have, however, great satisfaction in being able to announce that it bids fair to excel even its very admirable predecessor. The replies received in response to the applications have been most gratifying. The utmost readiness has been evinced on the part of proprietors to allow the nation to participate, for a few weeks, in the advantage of their treasures. The arrangements made are liberal and judicious. The pictures offered for exhibition will be inspected before any offers are accepted. Thus the task of selection, always troublesome and often invidious, will be performed in the best and least obnoxious manner.

We regret to learn that Mr. Foley, R.A., is still suffering from the severe attack of pleurisy by which, for several weeks past, he has been completely invalidated. It is in consequence of the sculptor's illness that his model of the statue of the late Prince Consort in Hyde Park has been boarded up, to shield it from the weather.

A marble bust of the late Mr. MacDowell, R.A., has been presented to the Royal Academy, the gift of Mr. W. F. Woodington, sculptor, by whom it was executed and exhibited in the year 1862, in the old galleries, Trafalgar Square.

In consequence of the illness of Mr. G. G. Scott, R.A., the usual course of lectures on Architecture at the Royal Academy, as announced, will not be given this session. In place of such series Mr. E. M. Barry, R.A., will deliver two lectures on that subject; Dr. Meryon, one lecture on Beauty; and Professor Tyndall one lecture, the subject of which is not yet announced. It has also been reported that Mr. Street, A.R.A., is engaged to give a lecture or lectures.

The election of an Academician on the 30th ult., in the room of Mr. MacDowell, R.A., makes the fourth vacancy now existing, in the minimum number of twenty, in the class of Associates.

MINOR TOPICS OF THE MONTH.

MR. P. MACDOWELL, R.A.—Last month we recorded the retirement of this eminent sculptor from the ranks of the Royal Academicians on account of ill-health; but we had no idea that his end was so near. He died on the 9th of December, at the age of seventy. The announcement was received too late for us to do more at the present time than record his decease.

THE NATIONAL GALLERY has recently received the addition of a large and important picture by Cima da Conegliano (*circa* 1489-1541), one of the followers of Giovanni Bellini. The subject is 'The Incredulity of St. Thomas,' and may be called an enlarged version of the picture in the Academy of Venice, of which an engraving appeared in our July number of last year, in the notice of the "Picture-Galleries of Italy." The picture in Venice shows but three figures—those of Our Saviour, St. Thomas, and some ecclesiastical dignity in his sacerdotal robes; that in our National Gallery exhibits Christ surrounded by the eleven disciples: in both compositions the figures of Christ and St. Thomas are identical, or nearly so: the heads of the who e group in the former are very fine. In both, also, the background is architectural, with glimpses of landscape behind. We have not heard where or how this fine work was acquired, but it appears to have been well preserved, for the colouring is rich and brilliant: it has, however, been put into an unusually heavy, massive frame, the gilding of which overpowers all else: this "outward adorning," if it may so be called, is a grand mistake, and opposed to good taste.

MR. J. R. HERBERT is reported to be at work on a companion fresco to his 'Moses giving the Law on Mount Sinai,' in the Houses of Parliament. The subject selected is 'Daniel giving Judgment in the Case of Susannah and the Elders.' The artist, it is also said, hopes that he may make up a trio with a picture of 'Our Lord delivering the Sermon on the Mount.' No hint is given of the destination of these works, nor whether they are public or private commissions.

THE SOCIETY OF PAINTERS IN WATER-COLOURS has given notice that future directions of Associates will take place in March. The third Monday of the month is the day fixed for receiving the drawings of candidates.

THE WINTER EXHIBITION of the Institute of Painters in Water-Colours was opened on the 19th December—at too late a period of the month for it to receive notice in our columns.—Mr. James Fahey, son of the secretary of this society, has been elected an Associate-member.

THE LOAN EXHIBITION, at the gallery of the Institute of Painters in Water-Colours, closed on the 3rd of December, having realised, as we hear, about £200 for the benefit of the Ventnor Hospital at Ventnor, the object of the exhibition.

THE CURATOR OF THE ROYAL ACADEMY.—A testimonial has been presented to Mr. W. Holyoake by a number of artists and students, on his recent retirement from the curatorship of the Academy, a position he has held for some years with great efficiency. The testimonial, a most appropriate one, consisted of a folio of original sketches, and a selection of photographs of pictures by the old masters: accompanying it was an address numerously signed. The presentation was made at a supper given to Mr. Holyoake, over which Mr. Valentine Prinsep presided: among the company were

Messrs. G. D. Leslie, A.R.A., H. S. Marks, Hodgson, Wynfield, F. Holl, H. Friswell, H. J. Leigh, A. Graves, and others—literary men and artists.

THE WELLINGTON MONUMENT.—The *Builder* says—"We hear with equal surprise and regret, that the chief commissioner is inviting tenders from sculptors for the completion of Mr. Stevens's monument. It is impossible wholly to exonerate Mr. Stevens from blame in this matter; but to suppose that any one but himself can satisfactorily complete his work is nonsense, and we suppose few sculptors will be found willing to attempt it." We, differing from our contemporary, hope that some one will be induced to undertake the work: if Mr. Stevens cannot, or will not, finish what was commenced nearly half a generation ago, it is high time that other hands should be sought after, to bring it to a conclusion.

MR. JAMES PENNETHORNE, architect to the Board of Works, has received the honour of knighthood from the hand of the Queen.

THE EAST LONDON MUSEUM, of which a portion of the temporary buildings at South Kensington formed the nucleus, is approaching completion, and will, it is expected, be open during the year.

THE EXHIBITION IN AID OF THE FRENCH PEASANTRY opens at too late a period of the month to enable us to pass it under review. It cannot be otherwise than a large success: for many British artists are contributors, as well as a number of leading painters of France. All the works are gifts, to be disposed of in augmentation of the fund: the receipts will be added to the sums subscribed; and these already amount to nearly £1,000—the Duke of Wellington presenting £100. Alas! the monies thus collected will go but a small way to alleviate the misery the war has brought to the peasantry of France: yet even a little help is better than none. It will be a duty to assist this exhibition; but, independent of the claims thus made on the benevolent, we cannot doubt that it will be greatly attractive.

THE ROYAL HOSPITAL FOR INCURABLES, at Putney, has, through the liberality of one of its warmest supporters, become what may not inappropriately be termed a "picture-gallery." A gentleman—one whose delight is to "do good by stealth," and would therefore not care to see his name publicly associated with an act of most thoughtful benevolence, though we may be allowed to speak of him as the "treasurer" of the hospital—has presented to it as many as four-hundred chromolithographs of the best kind, which he has had put into handsome frames, and hung round the walls of every apartment in the building where the afflicted patients lie helpless; or, if able to move about, where they are accustomed to assemble. It is not easy to imagine with what pleasure these beautiful transcripts of nature are viewed by the inmates, not a few of whom are incapable of seeing anything beyond the walls of the rooms in which, amid pain and suffering, they are, in all probability, destined to pass the remainder of their wearisome lives. Melrose Hall, the name of the hospital, would well repay a visit; it is most beautifully situated, and is open to the public any day of the week. There are many vacant rooms the committee would most thankfully fill did its finances permit, and the afflicted in all parts of the country are craving for admission by hundreds; for there is no distinction of locality, or sect, or creed, to render any candidate ineligible: he or she must be simply pronounced *incur-*

able—what a condition only to think of!—by medical authority. We have no doubt the donor of the pictures already there, would only be too glad to decorate the now empty apartments as he has those which are occupied. There are, we know, one or two other hospitals in the metropolis that have received gifts somewhat similar; but none, so far as our observation extends, which can point to such a munificent donation as that we now record.

BIJOUTERIE AND ENAMEL.—The deplorable state of affairs in France has thrown upon our shores a variety of productions for which there exists no longer at present a market in that unhappy country. Among, to us, the most interesting of these *envois* are the magnificent examples of jewellery and enamel received from Paris, which in the manufacture of such luxuries stands alone. For richness, variety, and elegance of design, those exhibited at the establishment of Mr. Phillips, 23, Cockspur Street, surpass all we have yet seen; and it is due to Mr. Phillips's taste to say, that for his own works, in order to secure the perfection of beautiful and classical design, he has extended his researches to some of the most famous museums of the Continent. Paris is the great modern school of enamel, and its artists have just succeeded in reviving the Art to a degree of excellence unprecedented, when the present posture of affairs may occasion a lapse from which it may not recover, even under the most favourable circumstances, in a quarter of a century. The *cloisonnés* enamels, by Lepec, are the most perfect examples of the Art, consisting of necklaces, pendants, brooches, ear-rings, lockets, &c., with central fields of lozenge-shape, or other forms, of the most delicate colours, serving as backgrounds for small painted figures, modifications and copied originals from the Greek, Pompeian, and Etruscan. In the International Exhibition of 1867, there was a marked recurrence in furniture and articles of personal ornament to the taste of the periods of Louis XVI. and the First Empire. We find this feeling continued in these ornaments, but with a superiority of workmanship and a luxuriance of fanciful adaptation which former periods never attained. We cannot give preference by description to even one of these works, for each, with its strongly marked national features, comes forward with its own peculiar history, insomuch that all, by their eclectic worth, rise to a high standard. The French do not generally carry out their imitations to the severity of exactitude; there is most commonly some surcharge which gives to their inspirations from the antique Greek more than a strong French accent; or renders their Egyptian, not of such and such a dynasty, but of the First or Second Empire. On the other hand, however, the works of Mr. Phillips are, as it may be, conscientious reproductions of the Greek, Egyptian, this or that Roman period, Indian, Persian, Indo-Persian, Scandinavian, Early British, &c.—for all these "styles" are represented. M. Lepec, the more than famous enamellist, is—not compulsorily, but patriotically—in the ranks of the Gardes Mobiles, and thus, with such men in the ranks of her defenders, France risks an element of value which she may not recover in half a century.

FRENCH PICTURES.—Another exhibition of pictures by French artists has been opened at the German Gallery, New Bond Street. It contains many works of much interest and value; among them being examples of the genius of Delacroix, Diaz, Isabey, Ingres, and Troyon—not, how-

ever, the best productions of these great masters; works by Rousseau, Jules Dupré, Regnault, Thirion, Hamon, Delaunay, and others, are of a more attractive order. The collection is, on the whole, interesting, and no doubt will prove tempting to collectors. The leading pictures are, however, for the most part dismal in subject and large in size, and only suitable for galleries.

THE FRIENDS of the late Lord Mayor, Mr. Alderman Besley, have subscribed for, and voted, a testimonial to that gentleman, which, according to resolution, is to be a portrait of himself. To execute this work, the managing committee has commissioned Mr. J. Edgar Williams: it is a life-sized half-length, and when we saw it the head was all but finished, and although the sitter was to appear in the robes of civic state, there were as yet no indications of this. The head is life-like and vigorous, painted with firmness and solidity, and the expression is animated and argumentative. On the publication of this announcement the portrait will have been finished, or nearly so. The works in Mr. Williams's studio amply justify the committee in having given him the commission. However difficult it is to originate in portraiture, there is yet much of novelty in the works we saw on our visit to the painter's studio; not so much in making them pictures, as in conveying into them the zest that bespeaks study, and removes them from the beaten path of portrait-painting. Among the most striking of those we noticed were portraits of the Countess of Dudley; her sister, Mrs. Forbes, of Newe; Lady Augusta and the Hon. John Fiennes, and the child of the latter—these were all grouped in a boat. There were also portraits of the Right Honourable Stephen Cave, Mr. Martin Tupper, and of other persons known in public life.

ENAMELLING.—This art is very much simplified by a process in use and shown at Mr. Solomon's, in Red Lion Square; according to which it is not necessary that the operator have any skill in its practice; but, on the other hand, if he or she possesses any experience in drawing and painting, this new method opens a field of practice much more extensive than that at the command of the unartistic aspirant. When it is said that the designs are worked out on a photographic base, it will be at once understood there remains only a brief course of nice manipulation admirably adapted to be carried out by the hands of ladies. The first desideratum in this process is a perfectly clear, positive photographic image on an ordinary glass taken from a figure, an object, or a locality. The subject must be transferred to a second glass prepared with a film of a particular composition sensitised with bichromate of potass. The image is communicated by means of an ordinary pressure-frame, with an exposure to sunlight of from half a minute to a minute, under blue sky, of three to five minutes, and before the spirit-lamp with the electrical ribbon, of from thirty to forty seconds. In the development of the subject, the process diverges entirely from ordinary photographic procedures. The plate having been prepared for development, this part of the process is effected by brushing over the film surface a very fine black powder, until the subject is perfectly defined through all its lines and markings. This black powder, it may be mentioned, is a mineral compound used in ceramic work. It may consist of oxide of copper and oxide of manganese, &c., or of other components; and the adhesion of this powder, so as to define the subject, is occa-

sioned by the lines and markings remaining moist after exposure, by a proportion of sugar having been employed in the preparation of the film. The subject having been properly developed, the next proceeding is to remove it from the plate or glass on which it has been so far worked. This is done by immersing it in water slightly acid, when the film will leave the glass; and, while yet in the water, may be transferred to an enamel tablet; after which, and when dry, it is submitted to the action of the furnace, whereby the collodion is driven off, and the form is burnt into the enamel tablet. It is not necessary that the subject remain simply black and white—any tint may be given to it. The *rationale* is not a novelty of to-day; but the value of this method of enamelling is its perfect simplicity, and the adjustment of appliances and means towards rendering it an elegant art for ornamentation of many objects.

THE POLYTECHNIC.—Among the amusements at this popular place of entertainment is a series of pictures of some of the battle-fields of the present war, orally described by Professor Pepper, which convey to the visitor very accurate ideas as well of the sites of different battles as of the manner in which this fearfully internecine struggle is carried on, and of many matters whereof we read daily without the means of forming any just conception. The pictures are preceded by portraits of the Emperor and Empress, the King of Prussia and the Crown Prince, Prince Frederick Charles, Counts Moltke and Bismark, and Marshal Bazaine. The first picture is a broad and comprehensive view of the scene of the affair at Saarbruck, with the heights of Specheren, where the Prussians worked their artillery with such destructive effect. This is succeeded by a representation of the burning of the camp at Chalons; and after that, the last charge of the French cuirassiers before Sedan, the retreat of the French infantry into Sedan, and the Prussian army before the walls of Sedan. The small house is shown before which were arranged by Count Bismark and the Emperor the terms of the surrender: we see the two chairs occupied by them during their discussion. After this the Chateau of Belleville is shown, where the Emperor and the King of Prussia met and concluded the surrender. The series includes large reproductions of certain French pictures well known to the public, as 'The Two Friends,' 'Waiting the Attack,' 'After the Attack,' and 'Returning Victorious'—in which an officer appears at the head of a column saluted and cheered by spectators of other regiments. There is also a Prussian officer heading a charge; and a scene illustrating the enthusiasm of the Prussian soldiers, who surround the king and press forward to kiss his hand. In other pictures are represented ambulances and their attendants, with cities which will become celebrated in the history of this fearful war; and what are especially interesting, pictures of the mitrailleuse and other weapons used by both nations, supplemented by representations of the Gatling gun, &c., &c. The manner in which the whole is got up is fully worthy of the fame of the Polytechnic entertainments; and the pictures and photographs convey to the mind that truth which approaches nearest to a knowledge of the reality. For the perfection of the pictures and the descriptions of the various scenes the institution is much indebted to the assistance of M. Paul de Katow; and of Mr. Nottage, director of the London Stereoscopic Company.

REVIEWS.

PUNCHESTOWN, 1868: THE ROYAL VISIT.
Painted by HENRY BARRAUD; engraved
by T. S. SANGER. Published by CRAN-
FIELD, Dublin.

It is so rare to meet a good engraving nowadays, that we cordially welcome this print: it is highly to the credit of the Dublin publisher who has issued it, to the artist by whom it has been produced, and to the engraver by whom the picture has been multiplied. Mr. Cranfield is an enterprising publisher: he does "his best" to promote Art in Ireland; and if Art does not prosper there, it is not his fault. At least, he does as much as our English publishers do: that is no great deal, certainly; but if circumstances in the sister-country were as auspicious as they are here, we believe he would minister more effectually to the public want of good prints than our English print-sellers do—they have nearly all limited their supply of Art to photographic copies of old things, and make no move to supply the world with results of the genius of engravers. We have, indeed, no publisher of prints in England; and as France may now, unhappily, be considered as closed to us, we may look for very few engravings for some years to come.

Mr. Cranfield took advantage of the visit of the Prince of Wales to Ireland, and his presence at the Punchestown Races, to commemorate an interesting event. On that occasion, the leading aristocracy of Ireland was assembled; nearly all its men of mark were present; and it was a right, as well as a good, idea to give a series of portraits of them. They are on the field, underneath the "grand stand," in which are seated the Princess of Wales, the Duchess of Abercorn, and the ladies of the Irish court; on foot or on horseback are upwards of a hundred noblemen and gentlemen, whose names are well and honourably known in Ireland, a large proportion of them being officers of the army. Although the figures are small the portraits may be easily recognised. The horses and riders are preparing for the start; the grouping and general arrangement are happily managed. As a "sporting print" of the higher order, this is undoubtedly one of the very best. It cannot have failed of welcome to the persons portrayed, and may be accepted generally as an excellent work of Art, and an agreeable acquisition to all lovers of field-sports—of that sport to which the British people is especially attached.

SPANISH PICTURES: drawn with Pen and Pencil. By the Author of "Swiss Pictures," &c. With Illustrations by GUSTAVE DORÉ and other eminent artists. Published by the RELIGIOUS TRACT SOCIETY.

This is a very interesting and instructive book, full of useful matter, and abounding in pictures, some of a high class. It tells us "all about Spain;" describes the country, the people, the architectural glories, the games, the occupations, the customs of Spain as it is, with some helps to understand the kingdom in the days of its now departed glory—we may add, of its time of degradation and shame, for something is said concerning the "Invincible" Armada and the "Holy" Inquisition. Perhaps the pencil has done more than the pen to make the volume an attraction—the engravings are admirably executed; some of them, indeed, are of the very highest merit as works of Art.

Taken altogether, the volume will be considered one of the leading favourites of the season, and may be strongly recommended as a desirable gift-book for the young.

GEMS OF FRENCH ART: a Series of Carbon Photographs. Edited by W. B. SCOTT. Published by ROUTLEDGE AND SONS.

Messrs. Routledge have issued few publications this year: that is unfortunate, for their resources are abundant. This volume is evidence of their capabilities: beautifully printed and gracefully bound, it forms one of the most attractive gift-books of the season, and may adorn any drawing-

room table in the realm. It contains sixteen examples of the great artists of France—Frère, Vernet, Ingres, Robert, Delaroche, Gérôme, Meissonier, Rosa Bonheur, and eight others. Copies of their most popular pictures have been produced by the "carbon process," and each is accompanied by descriptive and biographic letter-press from the pen of W. B. Scott—an artist who holds prominent rank as an author.

THE COAST OF NORWAY. By ELIJAH WALTON. The Descriptive Letter-press by the REV. T. G. BONNEY, M.A. Published by M. THOMPSON, Pall Mall.

For many years, we have seen no book so interesting or so beautiful as this: it recalls indeed the palmy days of Art-publications, such as long ago obtained circulation among genuine Art-lovers, who did not consider that works of merit could be produced by the thousand at low prices that brought them within reach of "the million." Although it is, no doubt, a great advantage to have good things cheap—and of such there is no lack—it is matter for earnest rejoicing that, occasionally, a production of high value should be produced at corresponding cost. Yet the price of four guineas is a small price for the exquisite assemblage of twelve chromolithographs, any one of which might be accepted as an original drawing. We lose all idea that to the printer, as well as the painter, we are indebted for such charming transcripts of nature.

Many of our readers are acquainted with Mr. Walton's pictures of scenery in Norway: they have been exhibited, and have obtained large popularity. He has selected the best and most interesting of them, issued them as fac-similes, joined with them valuable explanatory letter-press, and bound the whole together with much taste—and the result is a volume seldom surpassed in interest and beauty at any period of our Art-history.

Norway has, of late, been much visited by Englishmen. To those who have travelled in that grand country of natural wonders, the work is a great boon, but not to them only. The book will find favour among all who can appreciate the magnificence of nature and the excellent in Art. "The Coast of Norway is the most remarkable in Europe, perhaps in the world. A belt of islands, almost numberless, fringes its western side, and protects its ice-worn fells from the ocean surge. Through these the traveller threads his way, almost without a break, from the Naze of Norway to the North Cape. Here and there a great inlet—called a fjord—pierces far into the mountain mass that forms so much of the western coast; in whose sheltered nooks nature wears a more smiling aspect than on the barren seaboard." The passage we quote introduces the volume. We cannot doubt that the enterprising travellers (the artist and the man-of-letters) will find their labours appreciated: their reward will not only be honour, but the more substantial, if less enviable, recompense that attends success.

WONDERS OF EUROPEAN ART. By LOUIS VIARDOT. Illustrated with Sixteen Reproductions by the Woodbury Permanent Process and Eleven Wood-Engravings. Published by SAMPSON LOW, SON, & CO.

This book, a translation from the French, is a brief history of the principal continental schools of painting, with the exception of the Italian, which appeared in a separate volume about a year ago. Commencing with the Spanish school, those of Germany, Flanders, Holland, and France follow in succession. Why that of England does not appear in the list we do not quite understand; unless, as the translator hopes, M. Viardot may devote a distinct volume to the subject, which is not very probable, seeing he has bracketed the artists of his own country with those of other lands. Had he limited his examination to the works of the old masters, the omission of England would be intelligible; but he introduces French painters who, though not living at the present time, were contemporaneous with our generation, as Horace Vernet, Delacroix, Delaroche, Ary Scheffer, Overbeck,

Ingres, and others; and British Art has produced some "wonders" not unworthy of being placed in the same category with the productions of these well-known men.

Those who have carefully studied the epochs of painting and the lives of the artists who have risen to eminence will find little new in what M. Viardot says: to others we can recommend his book as a trustworthy and intelligent digest of the subject. The critical remarks are characterised by taste and judgment, and his descriptions of pictures are lucid and free from unnecessary verbiage. Of the illustrations we may remark that the majority of those produced by the photographic process are really good, and some of the wood-engravings are gems.

COLLECTS OF THE CHURCH OF ENGLAND. Published by MACMILLAN & CO.

This is, beyond question, the most beautiful book of "the season." The collects are the most perfect examples of short prayers. It is somewhat strange that no one has heretofore thought of subjecting them to illustration by Art. The subject is yet open; for in this case Art is limited to floral emblems—each collect being accompanied by either leaves or flowers, often flowers closely associated with the fast or festival commemorated. Thus, for Innocents'-day we have the snowdrop; for St. Peter's-day the water-lily; for St. Andrew's-day the thistle, and so on. The flowers are charmingly printed in colours, and are obviously drawn from nature. Moreover, the binding is exceedingly graceful. On the whole, a book more attractive or more perfect has very rarely issued from the press.

TALES FROM CHAUCER, IN PROSE. By CHARLES COWDEN CLARKE. Published by LOCKWOOD & CO.

A second edition of this book will receive a cordial welcome, with its pretty and pleasant wood-cuts, a portrait on steel, and a brief, yet comprehensive biography of the "father of English poetry." It was a good thought to make Chaucer readable by the young, to tell in prose the fine tales that are with difficulty comprehended in "the original." The work has been well done by an accomplished writer, who is thoroughly master of the subject.

THE RICHES OF CHAUCER. Published by LOCKWOOD & CO.

This book is also edited by the same estimable author—Charles Cowden Clarke—and this also is a second edition—a good sign in an age of mediocrities. To the mere scholar it may be less welcome than it would have been if the "impurities" were retained, the spelling was not "modernised," the rhythm not "accentuated," even the obsolete terms not "explained;" but to the general public—to nineteenth-century English readers, indeed—Mr. Clarke has supplied a boon of magnitude, for he has made the grand old poet easy of comprehension to all. Farther, it is only requisite to state that the book is very beautifully printed: the volume being one of a most attractive order in all respects.

WORK AMONG THE LOST. By the Author of "Home Thoughts for Mothers," "Mothers' Meetings." Published by W. MACINTOSH.

This is a very different class of book from those that crowd our Christmas table, where the tale, the poem, the novel, the wild adventure, and, above all, the beautifully-illustrated and brilliantly-bound children's books are full of the early blossoms of life.

This record of a good woman's labours in the cause of both temperance and chastity stands high above all others in testimony of what has been done, and can be done, by an earnest, sincere worker, believing and hoping that "all things work together for good to those who love the Lord."

It is a record of what has been done, and is doing, at ALBION HILL HOME. To bring about what has there been accomplished, the author

has laboured—at first single-handed—for sixteen years: but her endeavours have been of late greatly assisted; and even now, when the resources of charity are directed into other channels, we know there is still “balm in Gilead,” and that provision will be made to feed the hungry and receive back those who have wandered from the fold—“where there shall be one fold, and one Shepherd.”

THE LAND OF THE SUN: Sketches of Travel, with Memoranda, Historical and Geographical, of Places of Interest in the East, visited during many Years' Service in Indian Waters. By LIEUT. C. R. LOW. Published by HODDER AND STOUGHTON.

Under the above attractive title we have a narrative, by a retired officer of her Majesty's Indian navy, of his expeditions when on active service to a variety of Eastern localities, many of which are but little visited, except by mariners, and are therefore comparatively unknown. Such, for example, are the islands of Perim; the country of the Sormaulies, on the eastern coast of Africa; the Andaman Islands; several places on the shores of the Persian Gulf; the islands of Karrak and Keuk, within the confines of the Gulf. Other places, better known, are also described by the author, as Aden, Bnsorrah, Bagdad, &c. Lieutenant Low's “cruises” are very far from being devoid of incident, being varied with adventure and interest which may be accepted as not merely a “sailor's yarn.” The political and social bearing of much that met his observation, especially with respect to the slave-trade carried on in Africa, gives to his book something more than a simple record of travel. The opening of the Suez Canal must have a great and beneficial influence on the commerce of Great Britain; and information may be gleaned from these pages that will be serviceable to our mercantile community.

CRIS FAIRLIE'S BOYHOOD. A Tale of an Old Town. By MRS. EILOART. Published by FREDERICK WARNE & CO.

The point of this interesting and ably written book is given by the author in her preface: it has been written “in the hope that the fun and adventure permeating its pages may inculcate a hopeful, trusting spirit—the spirit that teaches us in the darkest hour to do our best to help ourselves and others;” and the motto chosen is this:

“God helps those who help themselves.”

It is a long story, somewhat drawn out, and we may doubt if Mrs. Eiloart writes as well for boys and girls as she does for men and women. She is an author of great ability, and of much well-earned popularity; but there is a “knack” in producing books for the young which seems to be a natural rather than an acquired gift. The high moral tone of this volume is unquestionable: the task she set herself is ably worked out.

OLD MERRY'S ANNUAL, 1871. Published by HODDER AND STOUGHTON.

More than 750 pages of excellent matter is here collected and arranged for young people, who may study it with pleasure and profit. Its principal attractions are the stories,—written, for the most part, by authors of ability and popularity: but the pretty book is full of information on various topics important and interesting.

LIGHTHOUSES AND LIGHTSHIPS. By W. DAVENPORT ADAMS. Published by NELSON AND SONS.

This is an agreeable and useful book. The title sufficiently explains the contents. It treats of lighthouses in all parts of the world, foremost among them being those that protect our own shores. It is descriptive, historic, and “anecdotic;” and may be read for information as well as pleasure.

THE SEA AND ITS WONDERS. By MARY AND ELIZABETH KIRBY. Published by NELSON AND SONS.

This book, on the other hand, depends mainly for success on the number and excellence of the illustrations: they are of the very best order, carefully drawn and admirably engraved. The sisters—whose names have been so long and so honourably associated in efforts to improve and strengthen young minds by bringing them into intercourse with Nature—have by no means exclusively depended for the popularity of their volume on its works of Art. Information is conveyed most agreeably and effectually on the many topics incident to the grand subject; not only as to dwellers in the sea and the produce of its vast gardens; but concerning trade-winds, currents, the cyclone, rain and dew, and a hundred other matters that give light to the whole. The accomplished authors have bent their minds so that they may be in harmony with the minds of the young who are to be taught; yet there is nothing low or mean in their “style;” while a marvellous amount of knowledge is often condensed into a page.

THE BROAD, BROAD OCEAN. By WILLIAM JONES, F.S.A. Published by FREDERICK WARNE & CO.

Mr. Jones has given us a volume of very great interest. The table of contents occupies twenty pages: we question whether they might not have been better filled; but a mere glance will suffice to show that nearly every topic connected with the broad, broad ocean has received treatment at the author's hands. It is of course full of anecdotes: stories are told of perils, escapes, adventures, and a thousand marvels of the sea; and they are well and pleasantly told. The author has studied his theme carefully, has read largely, and thought deeply. Seldom has a book of the kind been better done. It is illustrated, but not extensively.

OUR FEATHERED COMPANIONS. By the Rev. THOMAS JACKSON, M.A. Published by S. W. PARTRIDGE & CO.

This book is also very beautifully illustrated; as, indeed, are all the publications issued by the firm: aids are derived from the best artists and the best engravers. In no productions of any price can there be found better Art-work of its kind. Yet here we have a hundred woodcuts, many of them large, at a cost of five shillings. The letter-press is as good as the Art, and that is saying much. “Our Dumb Companions,” a Christmas gift of last year: here, although the subject is not quite so interesting, he establishes the position he has obtained.

AUNT LOUISA'S HOME COMPANION. Published by FREDERICK WARNE & CO.

Some of the old stories of our childhood have been skilfully put together and illustrated by large coloured prints, well drawn—they are, indeed, good and sound examples of Art, through somewhat gaudy in colour, and designed to please the eye of the uninitiated. The pretty book is, however, designed for the very young: it is printed in large clear type, and is neatly bound.

WHISPERS FROM FAIRY LAND. By G. P. D. Published by MITCHELL AND HUGHES.

This is a new edition of a most charming little book; written in a style easy and graceful; and teaching very valuable lessons to the young. Within the compass of fifty pages we know of no fairy tales at once so interesting, amusing, and instructive.

ZIGZAGGING AMONGST DOLOMITES. Published by LONGMAN & CO.

This book will amuse many a fire-side at the dull, yet merry, season of the year: it is a production of much ability; recalling, and not to its advantage, Doyle's “Tour up the Rhine,” it lacks the racy humour and broad character of its predecessor. Imitations are not to be com-

mended; and this is one—at least it is the old idea revived; but the route is different, the personages are new, and the artist is certainly an *artist*: he sketches with great facility; evidently he has filled his note-book as he went along; and the result is a most pleasant gathering together of observations and thoughts.

THE ROCK LIGHT. By ELEANORA LOUISA HERVEY. Published by FREDERICK WARNE & CO.

We do not well know how our young friends may feel, but we have read this book with much interest; indeed, we are not quite certain if it is intended as a contribution to the juvenile literature of the approaching season, or composed for the especial amusement of the “general reader.” The incidents are well arranged; the story increases in interest to the end.

The tale is told by “Rose,” a girl who introduces herself at sixteen, and up to that period has never left the light-house, which was kept by her uncle. We will not spoil the narrative, by dwelling on any particular scenes, but cordially recommend it to our readers.

ADRIFT ON THE SEA; OR, THE CHILDREN'S ESCAPE. By EMILIA MARRYAT NORRIS. With Illustrations. Published by GRIFFITH AND FARRAN.

Mrs. Norris has established her reputation as one of the most amusing writers of juvenile books; her pages are always full of vitality, and she bounds on with a story from first to last.

The character of Arthur—who imagined he would be considered a man if he could smoke, and endured much suffering in consequence—is well developed; and we cannot but say that we regret it is so true to life. Precocious boys are the plagues of many households; and Master Arthur, while receiving the lessons he so well deserved, was the cause of much danger and suffering to his family. “Adrift on the Sea” is especially a book for boys, but girls can read and enjoy it. It is certainly one of the best, if not the best, of Mrs. Norris's stories.

ODD STORIES ABOUT ANIMALS. By the Author of “Neptune.” With Illustrations by HARRISON WEIR. Published by GRIFFITH AND FARRAN.

This is a valuable little book for the nursery: the anecdotes are told in short words, and great ingenuity has been shown in extending them into tales. It is needless to say that as the illustrations are by Harrison Weir, they are truthful to the life—a matter of much importance in juvenile books.

“Nep running off with the umbrella” is worthy of a place in one of our exhibitions: it is exquisitely comic. What a delight it will be to the favoured little one who is presented with this book, to bring it to the drawing-room to show “mamma.”

THE FIRE-SIDE STORIES OF IRELAND. By PATRICK KENNEDY. Published by MACGLASHIN AND GILL, Dublin.

This is an interesting collection of Tales of various kinds and times. Several are well-known to us; but to the English readers of the present period they will be quite new: we can recommend them to the “Fire-sides” of our friends. Mr. Kennedy has been an indefatigable labourer in Irish literature, and deserves well of his country.

WALTER'S ESCAPE; OR, THE CAPTURE OF BREDÁ. By J. B. LIEFDE. Published by HODDER AND STOUGHTON.

An admirable book for boys: full of adventure: exciting enough to interest greatly the young who read it, yet by no means unwholesomely so; for all that is recorded may have happened, and truth is not sacrificed to fiction. The illustrations are well engraved, and may be accepted as valuable examples of good Art.

THE ART-JOURNAL.



LONDON: FEBRUARY 1, 1871.

THE IMPERIAL
MANUFACTORY OF MOSAICS
AT ST. PETERSBURG.

BY J. BEAVINGTON ATKINSON.



IN a recent journey to St. Petersburg I found the famous Mosaic Manufactory of the Russian Government in full operation. Travellers who have visited the kindred establishments in Rome and in Venice, or Englishmen who have seen the mosaic workers at South Kensington, will be able to picture to themselves the *ateliers* in St. Petersburg. The premises, though not large, are sufficient for the works in hand: they stand in the rear of that spacious Academy of Arts, which, with other like imposing structures, gives imperial state to the banks of the Neva. In the ante-room are ranged on easels minor works wrought in emulation of the Roman and Florentine schools; in a raised gallery are ample stores of enamels distributed in pigeon-holes, and classified according to colour; while in adjacent apartments may be seen manufacturing appliances, such as lathes and blow-pipes, for the fusion and abrasion of the enamels. Into one large workshop are concentrated the resources and energies of the establishment: the artisans, or, perhaps more properly speaking, the artists, are not divided off into separate studios, but group themselves under one roof around the several mosaic slabs in process of making. The picturesque scene recalled the workshops, which I had visited a twelvemonth before, of Messrs. Salviati, on the Grand Canal in Venice. On the walls were hung cartoons of finished works: such, for example, as the grand picture-mosaic sent to the Paris Exhibition, and now in the Church of St. Isaac; and upon the ground stood drawings of works still in progress, among which I specially noted an 'Entombment,' 12 feet long and a 'Last Supper' 18 feet long, the figures life-size, both for the enrichment of the same cathedral. The pictorial manipulations were carried forward with timorous care and tentative deliberation. The silence which reigned in the room was broken by little save the occasional chipping of a *tessera* into shape. The process is necessarily slow: no one is in a hurry: not a hand moves with speed—an idle hour will not materially delay a composition which cannot be completed for some years. In Imperial manufactories quality is more thought of than expedition. The director and his staff are handsomely paid by

the Government, upon the principle that products of a high and exclusive character cannot be sustained on a purely commercial basis. In England, unfortunately, we do not tolerate such subsidies; in Russia, on the contrary, partly because Art remains in a state of precarious infancy, requiring fostering care, the State extends munificent patronage. In the Russian department of the Paris Exhibition, the most remarkable products were due to Imperial factories, such as "*Manufacture Impériale de Porcelaines*," "*Manufacture Impériale de Verreries*," "*Fabrique Impériale de Péterhoff*," "*Jardin Botanique Impériale de St. Pétersbourg*," and last, but not least, "*L'Etablissement Impériale de Mosaïques à St. Pétersbourg*." The result of this Imperial favour is, that the mosaic manufactory at St. Petersburg is surpassed, if at all, only by that in Rome.

The parent of the Imperial establishment in St. Petersburg is the Pope's mosaic manufactory in the Vatican. It is indeed singular that, for the revival of an Art anciently rooted in Byzantium, Russia should have to seek for precedents and practical knowledge so far beyond her frontiers as the Roman States. It might have been supposed that mosaics at least would form an exception to the rule that all Art in Russia is imported from abroad. It would naturally have been imagined that the widely-comprehensive system of wall-incrustation, which from Constantinople had extended to Ravenna and Venice, would have found its way northwards to the ancient capitals of Russia. And yet in Moscow I searched in vain among the churches of the Kremlin for a single fragment of mosaic. The only remains of that Art, which is said to be fitted for eternity, is in the Cathedral of St. Sophia, at Kief—an ancient capital and place of pilgrimage, sometimes called the Jerusalem of Russia. It is interesting to observe the structural points in common between this cathedral and the church of St. Mark, Venice; the mosaics are severally of one school, that is, they are of Byzantine origin. Russia being thus all but destitute of examples dating back to historic times, and the Art having fallen into desuetude in Constantinople, the ancient seat of the Eastern Empire, recourse was had to Rome, the centre of Western Art, when the moment came for Russia to make mosaics a national manufacture.

Signor Bonafide, an Italian, the favourite pupil of Chevalier Barberi, the celebrated mosaicist of the Vatican, was, in 1846, entrusted by the Emperor Nicholas to establish in Rome a provisional institution, which might afterwards serve to introduce the art of mosaic-work into Russia. Four youths were sent from the north to serve their apprenticeship in Rome. I cannot find any statement of what remuneration they received, but the Government is known to support liberally her Art-students in foreign lands: ordinary students in the Roman branch of the Russian Academy are "sent for six years, with a pension of £160 a year each, for the journey £40, and for the return £40." The Russian Government seems to have been more than once thwarted in its endeavour to procure the enamel-colours needed for the execution of the mosaic picture of St. Nicholas and other works it had put in hand. The enamels produced under contract with the Roman mosaicist, Vincent Raffaelli, had proved unsatisfactory, and in Rome itself it appeared impossible to obtain the needful materials ready-made. Under these difficulties it was resolved

that the Russians should commence to manufacture for themselves: accordingly, a suitable laboratory was taken in Rome, and furnaces were erected. Signor Bonafide, appointed by the emperor chemist to the establishment, reports upon his success as follows:—"Myself and my brother set to work, ourselves directing and watching the smallest details, so that, in the course of a short time, we were enabled to exhibit productions which surpassed in quality all that existed at Rome in the trade, and which perfectly resembled all that could be found in the stores of the Vatican, even *scorzette* and *porporines*, which had not hitherto been produced for a long time. The production of our enamels was hailed with lively satisfaction by all the 'mosaicists,' and gained the full and entire approbation of Prince Volkonski, both for the choice and beauty of the colours which we had obtained, and also for the square form we adopted for the 'pizze' (pieces) of enamel, a form the most convenient for use, and at the same time the most economical. During the existence of the Russian establishment at Rome, we produced 45,181 pounds of enamel, divided into 4,700 different shades, including enamels of gold and silver. The cost of rent, installation, wood, apparatus, transport, and *personnel*, amounted to 10,667 *écus Romains* and 93 *baiocchi*, which gives a cost for every pound of enamel of 21½ *baiocchi*, or 28 *kopecks* (Russian),"—equal to about 9d. English. I may add, that I doubt the correctness of this price in common with other prices from the Russian establishment. When a manufactory is made Imperial, prices, if not immaterial, are often untrustworthy.

In the year 1851, Signor Bonafide, since deceased, received from the Emperor Nicholas, through Prince Volkonski, instructions to leave Rome and proceed to St. Petersburg, "there to assist in establishing the art of mosaic-making in Russia; and to overcome, as far as might be, the inconvenience of the unsatisfactory quality of the enamels produced by the Roman mosaicist, Vincent Raffaelli, who was then engaged in St. Petersburg, under contract, to supply the necessary materials for the work" in hand. There seems to have been naturally some delay in the organisation of the school of mosaicists, and in the establishment of the workshops. Ultimately it was settled that the enamel colours should be made in one place, the "*Manufacture Impériale de Verreries*," while the mosaics were to be set up in another *locale*, a portion of the Imperial Academy. The staff at the latter manufactory has of late years consisted of about fourteen artists and eight artisans. Painters, such as the late Professor Neff, also another Russian artist, likewise an Italian painter, severally employed on cartoons, are not included. The above facts substantiate the statement that St. Petersburg first borrowed the art from modern Rome, and at the same time they account for the close resemblance between the picture-mosaics made on the banks of the Neva and those manufactured on the banks of the Tiber. I think there can be no doubt that the Russian Government did wisely to go to Rome. In Venice the art had, until a recent period, been long neglected; and even under the revival effected by Dr. Salviati, works as delicate and elaborate as those executed in the establishment of the Pope are quite the exception. I may add that a year ago in Ravenna I found a Roman mosaicist employed in the restoration of 'The Good Shepherd' and the maintenance of other

historic remains. This Italian, working under ancient traditions, used Roman *tessera*, which in Ravenna were deemed better than Venetian. I see no reason to call in question the statement that the *tessera* now made in the "*Manufacture Impériale de Verreries à St. Pétersbourg*" are equal in quality and in variety of colour to the enamels manufactured in Rome. In fact, a chief end sought to be attained through the apprenticeship served by the Russians in Rome, was to perfect the material, as a material, in the essential particulars of colour, substance, and endurance. In St. Petersburg the mosaic designs are poor compilations, ostentatious and empty as is the most part of modern Art in Russia. And such good care has been taken to secure excellence of enamel and workmanship, that there is a fair chance that these common-place compositions in Russia will long survive creations of genius confided elsewhere to less trustworthy materials.

The *technique* of the Russian manufacture has been established, as we have seen, on a sound and scientific basis. Valuable data of the processes employed may be gathered from "Appendix S to Eleventh Report of Science and Art Department," incorrectly entered in the margin as "Mr. Sandham's Description of a Russian Mosaic Establishment," whereas Mr. Sandham merely acts as translator. The report dwells on "economy" of manufacture, notwithstanding the proverbial extravagance of all prices in St. Petersburg, whether of luxuries, or of bare necessities, and tells how the consumption of gold may be diminished. "With us," states this official document, "it is a vital object to economise to the utmost the precious metals, and to obtain the same results by metallic oxides less costly. Copper, for example, is well known by chemists to be capable of three different degrees of oxidation. We obtain from this metal not only three primitive colours, such as yellow, red, and blue, but also the mixed colours, orange, green, and violet. Besides, with the aid of other materials which we employ, and by means of some modifications in manipulation, we obtain all the compound colours, in an infinity of shade." Professor Archer was more precise when, in the columns of the *Art-Journal*, he stated that in St. Petersburg "the metals chiefly employed are gold, silver, copper, cobalt, manganese, lead, tin, antimony, iron, and chromium: carmine, purple, and rose colours are obtained by gold; yellow by silver, lead, and antimony; blue by cobalt; red by copper; brown by manganese; black by iron; green by copper and chromium, &c.; orange by lead." The late director in St. Petersburg lays claim to inventions in mechanism and to chemical discoveries which it is supposed may have improved the products of the furnace. I do not attach to these claims much importance: "a shovel of a new form," for example, scarcely implies any great amount of creative genius. The processes seem much the same as those I have witnessed in Murano. The Russians as a people are more imitative than creative: and that they should be able to produce after established precedents a material equal to the best manufacture whether ancient or modern is greatly to their credit. As I write are ranged for comparison on the table before me *tessera* which I have at various times collected. Among the old materials are remnants from mosaics on the façade of Orvieto Cathedral; also from mosaics in St. Mark's, Venice; likewise from the mosaic of "the Good Shepherd," a work in Ravenna.

And among the new materials are Salviati's glass *tessera*, used in the repair of the old mosaics in St. Mark's, as well as for the modern works at Windsor and in the Houses of Parliament; to these may be added the ceramic or earthenware *tessera* of Messrs. Minton, employed in certain figures at South Kensington; lastly, the *tessera* I brought from St. Petersburg. A comparison of these several examples shows less difference than might have been anticipated. As to relative opacity and transparency, the Minton and the Salviati compositions are opposite extremes: Minton's mixture, which seems little else than baked clay, is opaque and dead in surface as earthenware; while, on the contrary, Salviati's compound is translucent and sparkling as glass. Each material has distinctive advantages. I notice that Sir Digby Wyatt, in a paper read before the Institute of Architects, suggests that the opaque material should be used for the high lights, while the transparent *tessera* might be reserved for the shadows. Such practice would correspond to the well-known maxim in oil-painting: "Load on your lights, and keep your shadows transparent." The materials which come from St. Petersburg are intermediate in character: they are not quite so translucent as the Salviati glass, nor are they so opaque as the Minton clay: they may be likened to the consistency of sealing-wax, which, as far as I remember, was the prevailing aspect of the substance used in the Vatican. Accordingly, the surface of the Russian picture-mosaics when complete, as seen for example in the master-works put up in the Church of St. Isaac, throw off light quite as forcibly as frescoes, and yet on the other hand they do not reflect light as when *tessera* of burnished surface shine like a multitude of small looking-glasses. This last effect was the unpardonable fault of the Salviati mosaics set up some months since in the Central Hall, Westminster. At St. Petersburg considerable credit is taken for "the colour *porporine*—purple." "The reproduction of this colour was the object of the researches of many distinguished chemists, but although they arrived at the constituent elements of this enamel, no one was able to produce it. It is to the laboratory of our establishment that the credit belongs of having produced, in 1847, and down to the present day, an enormous quantity of this precious colour." Also not without reason do the Russians claim excellence for perhaps the prettiest of mosaic products, glazed gold *tessera*, specially needed in a country where, after the example of Byzantium, gold is lavishly used in backgrounds. Mr. Ruskin speaks eloquently of the beauty and utility of this exquisite manufacture as used in St. Mark's. The process by which the gold-leaf is laid on, then placed under the protecting pellicle of glass and so hermetically sealed, has been often described; and the glistening product whether ancient or modern, whether it come from Venice or St. Petersburg, is nearly identical both as to durability and decorative use. It is interesting to observe with what care, with how much attention to minute circumstance, various mosaic manufactories have devoted themselves to the safe and lucent incrustation of the gold-leaf. Even the colour of the vitrious background upon which the gold is mounted has been carefully considered. Salviati lays gold upon red, blue, or green enamel, according to the tone desired: the Russian chemists carry out the same idea, and the factory being imperial, that is sustained by subsidy and independent of commercial considerations,

no pains have been spared to render the substance and surface as nearly perfect as practicable. I have reason to believe that the cost mounts up to that of a luxury; in other words, the outlay, as in the state factories of France, is so heavy as to close access to the markets of the world. As to permanence, it is almost impossible to speak. We all know what absurd claims for indestructibility have latterly been set up for mosaics; the fact being that the finished work must perish with its weakest part, viz., the mortar-bedding. But I have before me a fragment from Orvieto, which shows that the *tessera* themselves are subject to disintegration, and having seen even granite crumble under an Italian winter, it is easy to believe that in St. Petersburg mosaics, unless well protected, must fall to pieces. But in Russia, mosaics being used solely for internal decoration, and the churches being heated by artificial means, there seems reason to believe that the *tessera*-picture may last almost as long as the walls will stand. Reverting to the matter of gold grounds, I may state that in the St. Petersburg *atelier* I made note of raised or embossed gold grounds somewhat comparable with flock patterns in wall-paper decorations. This is a novelty which may be turned to good account. The unmitigated brilliance of a gilded surface is apt to destroy all colour with which it comes in contact; and I have been interested to observe in Venice how Salviati has striven by subdued treatment of gold, passing from light yellow to shadowy tones and even into still more sombre tints of copper, to mitigate excess of lustre. But possibly in the still barbaric state of Russian Art, such delicate modulations may be accounted as loss of power. The multitudinous domes of the Kremlin in Moscow are mostly gilt; and I was surprised to find that no one would join in my admiration of the gold toned by time, oxidised and brought into broken and yet richest harmonies with sky and cloud. Everybody deemed the span-new gilt pumpkin of a dome the nearest possible approach to the divine. The analogy between these golden cupolas and the gold of mosaic grounds is close, if not indeed complete. I have noticed, indeed, that gold mosaics gain in tone by time somewhat as painted glass; crudeness of tone and harsh contrasts are subdued to harmony. I may be excused for thus dwelling at length on a point which in Western Art would be deemed of secondary moment. But in Russia gold is a primary means of decoration, a salient feature in a city panorama. Travellers who have approached St. Petersburg from the sea, or seen Moscow illumined by the setting sun, will know how much of Imperial magnificence, how much of Eastern splendour is due to the gold which illumines the dome-crested panoramas. I think the Government shows a clear intuition of the requirements and capabilities of national Art by fostering a school of mosaic manufacture, which yields a decorative appliance in perfect keeping with historic tradition as well as with the present complexion of popular taste.

The notes I have made on the mode of putting the mosaics together accord with the published report of Professor Archer. A coloured cartoon is the mosaicist's guide; a white surface of plaster laid in a strong framework about half an inch deep is his field of action. Upon this smooth surface the composition is sketched piece by piece. It being thus determined with precision where each *tessera* is to lie, the plaster, which yields softly to the knife, is cut carefully away, and just as carefully is each cube

squared, ground, filed, and fitted into its prepared cell. Thus by slow degrees does the white plaster give place to the coloured picture, vastly more slowly than canvas yields before the stitches of a worker of tapestry. "How long," I inquired, "will that large mosaic of 'The Last Supper' take to complete?" "Five men could finish it in four years," was the reply. The weight of such a work is so immense that the enclosing framework requires utmost strength. The mosaic sent to Paris in 1867 weighed no less than seven tons, and to move such a mass in the *atelier* needs cranes and other mechanical appliances. The Russians deem giant scale essential to grandeur; they seem to consider that their public works must be of a magnitude commensurate with their vast empire; and certainly they accustom themselves to move blocks of stone which are without historic parallel since the building of the Pyramids by the old Egyptians. The grand monolithic columns of the Church of St. Isaac were brought all the way from Finland on rollers; and in like manner the huge granite blocks for the monument to Catharine, now in course of construction, have been dragged through the streets of St. Petersburg. In some four years time, when the mosaic of the 'Last Supper' shall have attained an accumulative weight of ten tons, the removal from the studio to the church will become a serious operation. In the meantime much remains to be done. When the last of some two or three hundred thousand *tesserae* shall be in its place, the whole picture will be turned down on its face, and the plaster cut away from the back. The roots, or fangs, of the *tesserae* being thus laid bare, Roman or Portland cement will be run over the whole surface. A solid back being thus put to the picture, the work is ready for its destination. During its execution it has been of the nature of an easel-picture: on its completion, it will be built into an architectural structure, and thus assume, as far as the treatment may permit, a monumental character.

I obtained a special appointment to see the melting of the enamels under the blow-pipe, the mixing of two colours to make an intermediate third, &c. Travellers acquainted with the glass-works at Murano are not likely to be taken by surprise by the dexterous manipulation needed in the making of the enamel colours in St. Petersburg. The marvellous ductility of glass is, of course, the same all the world over. On the whole, the Imperial glass manufactory, as represented in the recent Russian Exhibition, fell short of the Salviati works, as displayed in the Paris Exhibition; and certainly the feats performed in the way of combination and fusing together of colours are not comparable with the Venetian filagree and other well-known products. But in St. Petersburg they show a somewhat novel arrangement of colours one over the other, as in agate; they also imbed colours, by placing one round the other in concentric circles. I have several such circular or oval *tesserae* on the table before me, each measuring from half an inch to one inch in diameter, with usually an eye of white at the centre, and various shades of yellow, red, brown, or grey around. The process, being once mastered, admits of manifold combinations. The advantage, however, accruing from this ingenious arrangement, is not very evident. The utmost benefit would seem to be that one *tessera* produces the same effect as many, and one will remain more firmly in the cement than several. The sizes of the

tesserae usually vary with the greater or less minuteness in detail; and among the specimens before me some are drawn out to the thinness of a thread or wire, and thus a mosaic may be as finely elaborated as a needle-wrought tapestry. It is evident, as before said, that no cost is spared, no expedient neglected, to approach perfection; and although, after the manner of the moderns, enamel colours are mostly relied on, yet, as with the ancients, the use is not denied of natural materials, such as *lapis lazuli*, provided only natural substances will answer the end in view better than artificial. Thus it will be inferred that all the resources of the mosaic process are called out to the uttermost: the materials are excellent and well applied. The size of the *tesserae* is varied so as to gain what in painting would be termed boldness or delicacy of touch; and the lines in which the *tesserae* are laid are so disposed as to represent, as in line-engraving, the curves and modulations in surface. From the above it will be understood that the Russian mosaicist has at command unusual realistic power: he can give to draperies texture, to robes enrichment; by the use of high lights and deep shadows, by the contrast of transparent and opaque colours, he can give to the human eye sparkling intelligence, and to jewellery or metal-work lustre and translucence. An art essentially decorative thus gains in brilliance.

Russian mosaics are costly: economy of manufacture, as before remarked, is rarely an object with Imperial establishments; indeed, the idea of a State subsidy is to sustain a manufacture which could not commercially pay its way. It is, therefore, not a little surprising to find Signor Bonafide, in his report to the Government, claim cheapness, at least in the cost of the enamels. The only source of economy stated is the substitution of baser metals for the more precious in the production of the colours. It appears that the enamels, including gold as well as other colours, average the rate of 1s. 8d. per pound, uncut into *tesserae*. This is incredibly cheap, as the uncut gold enamels used by Salviati for the restoration of St. Mark's cost 6s. per pound, while varied colours cost 3s. per pound. There must be some fallacy in the Russian official statement. But independently of the cost of the raw material, the expenses at St. Petersburg are excessive. The process, as before described, indicates that speed and simplicity are sacrificed to excellence of workmanship. It is the boast of the authorities that the most skilled labour is employed: an apprenticeship has to be served, and the pupil must show a medal of honour from the school of design in St. Petersburg as a preliminary qualification. Fourteen artists are usually employed, and the most able have been known to earn £300 per annum. Half that sum would be more than a good income for an Italian copyist of pictures in the galleries of Florence or Rome. The total expense of the establishment to the Government is set down so variously that little reliance can be placed on the figures. Monarchs of unlimited and irresponsible powers do not care to confess to the cost of their favourite hobbies. Fortunately the Government of Russia has not to pass its estimates for Science and Art before a House of Commons. Neither is it easy to ascertain the precise cost of any one mosaic when turned out of hand. The works are not on sale; and when we consider that a single picture may be three or four years in the making, it will readily be understood that an

exact account of the expenditure cannot be got at. I find, however, that the cost of the most arduous work yet finished, the composition of saints sent to the Paris Exhibition, is set down in the Russian catalogue at £11,000: a sum not impossible when we remember that the decorations around the altar of the Church of St. Isaac, whereof this mosaic forms part, are stated to have involved the expenditure of £500,000. In St. Petersburg, as in Rome and Venice, the cost of a work of course varies with the fineness of the *tesserae* and the expense of individual colours. Of the various works I saw on visiting the factory, there was a small head of Christ valued at £80 the square foot: thus a mosaic may in price be after the rate of a Turner drawing. How exorbitant is this figure can be judged by the fact that Salviati's figure-mosaics, of a quality suited to the proposed decoration of our own St. Paul's, would not exceed £3 3s. per English foot. Mr. Layard, however, has stated that the most highly-wrought Venetian mosaic would reach £5 per foot: this is just the rate paid for the Munich windows in St. Paul's. The frescoes which are perishing in the Houses of Parliament have cost greatly more—scarcely less than £10 per square foot: mosaic is cheaper than painting. It may, however, be reasonably urged against mosaics, that so small a proportion of the total cost goes to Art as in painting, and so large a part to the material and manufacture. This objection especially holds against Russian mosaics, wherein the design is usually all but worthless in an Art point of view. The exorbitant outlay is in the mechanism of the Art, the laborious character whereof is indicated by the fact that no fewer than 120,000 *tesserae* were used in the mosaic of St. Nicholas in the Exhibition of 1862. Each of these *tesserae* represents more than the common amount of labour. In coarse cheap mosaics the enamels are chopped speedily, almost at a blow, as might be witnessed at an English stall in the 1862 exhibition. In St. Petersburg, on the contrary, every cube is most carefully chiselled into form, and then fitted in its place neatly. Again, in the Salviati mosaics interstices are permitted; the mortar may show between the chinks in the enamels; the surface is allowed to remain somewhat uneven; and these irregularities are not wholly disadvantages when the work is to be seen only from a distance. On the contrary, in the St. Petersburg mosaics the *tesserae* are placed so closely as scarcely to show a joint, while the surface is kept level by a flat edge and the use of smoothing tools. This delicacy of manipulation contrasts strongly with Salviati's economic method of gluing the *tesserae* face downwards on portable pieces of paper. In the *atelier* on the banks of the Neva the artist sees his work: he does not lay down his picture in the dark. Salviati is commercially right: the Russians are artistically right. The number of colours used in Venice, in Rome, and in St. Petersburg, would seem to vary considerably. Mr. Layard states the number of tints employed by Salviati as only 1,500. The number of colours that used to be credited to the Pope's factory were not less than 10,000, and I was assured that I saw around me in the St. Petersburg factory no fewer than 14,000 different tints.* As shades are varied in

* The discrepancy between these several figures is so extraordinary that the writer thought it due to Messrs. Salviati to ask for an explanation. The letter received in reply states that the figures 1,500, as above, are "correct, inasmuch that they are shades actually kept in our manufactory; but thousands more could be made if required—it only requiring different degrees

the furnace at discretion by the intermixture of white, it is evident that the colours might be multiplied even beyond the point at which the human eye could detect the difference.

Mosaic workers have in past ages taken rank as artists. They have been deemed, like engravers, more than mechanists—they are not allowed to fall into oblivion; their names, as, for instance, that of Andrea Tafi, who worked in the Baptistery of Florence, are handed down in the history of Art. In like manner any work which issues from the St. Petersburg factory is identified with the names of the mosaicists employed thereon. The following extract from the reports on the Paris Exhibition, 1867, "presented to both houses of Parliament by command of her Majesty," gives honour where honour is due. "As an important offshoot from Rome, we have," writes Sir D. Wyatt, the reporter, "next to consider an establishment which, but for its being 'Imperial,' and therefore *hors concours*, would unquestionably have received the highest honours any jury could have conferred. I allude to the Imperial glass-works of St. Petersburg, under the especial patronage of Prince Gzkarin, and presided over by Signor Bonafide, the favourite pupil of the celebrated Chevalier Barberi, the mosaicist, of Rome. What the French would call a splendid *gamme* of coloured *smalti* for the execution of mosaics, exhibited by this establishment in 1862, received the warmest commendation from the jury, of which I was a member on that occasion, and was subsequently presented to the Department of Science and Art by the Emperor of Russia. The present exhibition shows advance, rather than falling off; and unquestionably the best pictorial mosaic of all in the building is a colossal one executed with *smalti*, from this establishment, by F. Bouronkin, M. Mouraviev, and G. Agavanov, from a picture by Professor Neff. It represents a group of saints, and for breadth of effect and simplicity of execution leaves nothing to be desired."

Russia has been unwise in the Art-style she has adopted. The designs her mosaicists work from belong to the florid post-Raffaëlite period. Instead of adopting as her model the early mosaics of Torcello, Venice, Ravenna, or Rome, she emulates the showy designs executed by the school of Tintoret and Veronese. The manner adopted is something between the Caracci, Caravaggio, and Delaroche. The drawing for 'The Last Supper,' now in the *atelier*, was made by an artist of Italian descent, and the other works in hand are essentially modern; they are not Byzantine, not mediæval, not monumental, but pictorial. Accordingly, Russian mosaics are often wanting in symmetry, simplicity, and solemnity; they are more of the nature of easel-pictures than of architectonic art. As I pointed out when writing of Art-education in Moscow, the Russians would do well to work out a more expressly national style, for which, in fact, they possess ample historic materials—a style rooted in Byzantium and taking on rich colouring from the East. But instead of this true policy, painters have sold themselves to France, and bartered their Art to Italy. The mosaicists in St. Petersburg work from the compositions of Professor Neff—an artist known in the Hermitage by nude girls

of heat and colour." It will thus be seen, as above urged, that there are no limits to the number of colours which can be turned out from a furnace. It still remains matter of astonishment that in St. Petersburg are needed nine times as many tints as are said to be sufficient in Venice.

bathing. Religious Art is not to be made out of such meretricious stuff. The source of the evil which afflicts the pictorial school lies in great degree in the false style of architecture adopted for the churches and public buildings of the capital—a rank growth of the *Renaissance*; an ostentatious dressing up of forms which have long served as common-places for Italian masters. The famed Church of St. Isaac, for which the mosaicists labour, is as hostile to a good style of wall-decoration as the interior of our St. Paul's is fatal to a pure style of painted glass. The fact is, the religious Arts in Russia are in an anomalous and false position: they are divided between the effete Byzantine and the flaunting modern; there is no interval or intermediate resting-place between a Madonna black as ebony, and a span-new saint decked as a costume for a book of fashion. The Art-revival fostered by Russian emperors is not even on a par with that modern mediævalism—the so-called school of Christian Art, patronised and pampered by King Ludwig in Munich. That the Government is wise in taking to mosaics in some form as a national system of wall-decoration cannot be questioned. It is evident that the exclusion of sculpture from the Russian Church leaves a void not easily filled. Frescoes would have been wholly incompatible with the climate, and, moreover, must have been overpowered by the richness of adjacent marble, malachite, *lapis lazuli*, &c.; whereas mosaics, being built up of solid materials, comport well with the surrounding structure. The commencement already made in this magnificent decorative process cannot fail to have ample development in the future. Some years may be occupied in supplying the Church of St. Isaac with the required enamel-pictures; further years will be needed for the like decoration of the new church in Moscow. In the meanwhile, with the growing wealth of the empire, other churches will arise, which in time must tax the productive power of the St. Petersburg mosaicists.

ROYAL SCOTTISH ACADEMY.

FORTY-THIRD ANNUAL REPORT.

EVERY year since the establishment of our Journal, in 1839, have we been enabled, through the courtesy of the Council of the Royal Scottish Academy, to report its diversified operations, which are second only to those of our own Royal Academy, whereof we get information only by degrees. It appears, from the published statement we have recently received from Edinburgh, that the unfavourable state of the weather during last year's exhibition had been the cause of a decrease in the number of visitors to the galleries; on the other hand, the sale of pictures was very satisfactory, being somewhat in advance of those that found purchasers in 1869. The interest of the exhibition was, as usual, increased by the loan of several important works, the property of various collectors.

The following awards of prizes were made to students:—

ROBERT ROSS	{ For the best Drawing in the Life School.
ABERCROMBY	{ For the best Painting in the Life School.
WALLACE	{ School.
JOHN WALLACE	. . . For Anatomical Drawings.

Messrs. Abercromby and Wallace were bracketed *æquales*: singularly enough, these artists stood in the same relationship to each other in the previous competition for a similar prize.

The KEITH prize was adjudged to J. B. Abercromby, as "the most meritorious student; and the STUART prize to W. F. Hole for a

drawing in Monochrome, entitled 'A Night to be much remembered.'

The vacancies in the number of Members of the Academy caused by the death of the two brothers Messrs. J. E. and R. S. Lauder, were filled up by the election of Messrs. W. McTaggart and J. Dick Peddie, whose places as Associates have to be supplied from the list of candidates, as is also that of Mr. W. W. Crawford, Associate, who died a few months ago.

The Report expresses the deep regret of the Council in recording "the unusually numerous blanks made by death in the ranks of the Academy since the publication of the last Report;" the institution has lost its Professor of Antiquities, Sir James Y. Simpson, Bart.; an Honorary Member, D. MacIse, R.A.; two Academicians, D. O. Hill and James Giles; and one Associate, A. Handyside Ritchie. Three other vacancies, in addition to those already mentioned, have been created in the Academy by the decease of the three last mentioned artists, and will have to be filled up at a future time.

The Academy's collection of works of Art has received the following additions during the year: a marble bust of the late Sir John Watson Gordon, P.R.S.A., R.A., presented by his brother, Mr. Henry Watson; a portrait of D. O. Hill, R.S.A., painted, as a commission from the Academy, by R. Herdman, R.S.A.; 'Dora,' the diploma work of W. McTaggart, R.S.A.; and 'A Suggestion for the Improvement of Edinburgh,' the diploma work of the architect, J. Dick Peddie, R.S.A.

Mr. W. Douglas, R.S.A., having resigned the office of secretary, Mr. Dick Peddie was elected in his room.

SELECTED PICTURES.

FROM THE PICTURE IN THE COLLECTION OF W. COTTRILL, ESQ., HIGHER BROUGHTON.

OUR PETS.

P. J. Edmond Castan, Painter. T. Brown, Engraver.

WE are once more indebted to Mr. Cottrill, of Higher Broughton, for permission to engrave one of the attractive pictures in his collection. It is the work of Edmond Castan, a painter of the French school, whose *genre*-pictures are but little known here, though highly esteemed in his own country; and who bids fair to be as well appreciated by our collectors as he is elsewhere, when they are able to make acquaintance with his works, for which few opportunities have yet been available. Castan is a native of Toulouse, and studied in Paris, under Drolling and F. Gérard, directing his talents to domestic subjects, which, as the example here given shows, he treats in a pleasing and entirely inartificial manner. There is in it nothing of that false sentiment and melodramatic style of composition which so often tend to mar work that is otherwise excellent in works of French origin. The scene is the exterior of a vine-covered cottage in France: a young girl, who is come to draw water from the well, has put down her bucket and picher to caress one of a pair of doves which has perched on her hand fearlessly, as if accustomed to be petted and kissed. The two children are eager to enjoy the same privilege as their elder companion, the little girl stretching forth her hands with importunity for the bird, while her brother looks on pleasurably and waits his turn for a salutation.

The subject is discreetly and very prettily handled; the attitudes of the figures are natural, and the drawing throughout is good. It is, in short, a picture which in every way commends itself.



FIG. 111. CAPTAN PINXT

END OF THE



THE
STATELY HOMES OF ENGLAND.

(OCCASIONALLY OPEN TO THE PUBLIC.)

"The stately homes of England,
How beautiful they stand!
Amidst their tall ancestral trees,
O'er all the pleasant land."

MRS. HEMANS.

By S. C. HALL, F.S.A.

THE ANTIQUARIAN NOTES AND DETAILS
BY LLEWELLYNN JEWITT, F.S.A.

HADDON HALL.



HADDON HALL, as we have shown, is the property of the noble family of Manners. Like that of Vernon, this family is of considerable antiquity; and, although the records of its early members do not extend so far back as those of the Vernons, its history is more illustrious, and its dignities are more exalted. The most ancient of the ancestors of the present Duke of Rutland, of whom there is direct evidence, was Sir Robert Manners, Lord of the Manor of Ethale, in Northumberland, from whom descended another Sir Robert, who married Philippa, daughter of

Sir Bartholomew de Mont Bouchier, by whom he had issue, a son, also named Robert, who married Hawise, daughter of Robert, Baron de Muschamp, in the reign of Henry I. Their great-grandson, another Sir Robert Manners, married Agnes, daughter of Sir David Coupland. Their son, Sir Robert, had issue by his wife, Joan de Heton, four sons; three of whom dying without issue, the second son, William Manners, inherited the estates. He married Ellen, or Janet, daughter of David Bagster, of Derby, by whom he had a son, Sir Robert Manners.

This Sir Robert was returned in the seventeenth year of Edward III., as one of the principal persons in the county of Northumberland, and was entitled to bear arms by descent. In the first year of Edward's reign, being governor of Norham Castle, he distinguished himself by his successful defence of that stronghold against the Scots, who, "despising King Edward's youth, on the very night of that day on which King Edward was crowned, intended to take Norham Castle by surprise; and so well managed their design, that about sixteen of them had already mounted the walls. But the captain, Sir Robert Manners, being warned of the matter beforehand, by one of his garrison, who was a Scotsman, had so well prepared to receive them, that of those who had mounted he took five or six, and put the rest to the sword, their companions below, upon this disappointment, retiring." In the next year he was constituted one of the "conservators of the truce made with the Scots for all hostilities to cease." Soon afterwards he was made sheriff of the county of Selkirk, and appointed to keep and defend the forts of Selkirk, and Ettrick, &c. In the fourteenth of the same reign he represented Northumberland in Parliament, and again subdued Scotch incur-

sions. Soon afterwards he obtained a license from the king "to strengthen and embattle his dwelling-house at Ethale, in Northumberland, with a wall made of stone and lime, and to hold the same to himself and his heirs for ever." The next year he was constituted one of the commissioners to treat with David Bruce and his adherents for a peace, and subsequently was made Lord of the Marches. At the battle of Neville's Cross, in 1346, under Queen Philippa, in which the Scottish king was taken prisoner, Sir Robert displayed great valour, and was entrusted to keep charge of the prisoners, and deliver them to the Constable at the Tower of London. He died in 1355, leaving his son and heir, John de Manners (by his wife Aliva, or Alice, daughter of Henry Strather), only one year and three weeks old.

This John Manners received the honour of knighthood, and married Alice, widow of William de Whitechester; and, dying in 1402, was succeeded by his son, Sir John Manners, who was sheriff of Northumberland, and, with his son John, was accused of the murder of William Heron and Robert Atkinson, or Akyman; they were prosecuted by Sir Robert de Umphreville, and Isabel, widow of William Heron, and were ordered to "cause 500 masses to be sung for the health of the soul of the same William Heron within one year then next ensu-

ing, and pay unto Sir Robert de Umphreville, and Isabel, to the use of the said Isabel and her children by Heron, 200 marks." He was succeeded by his son Robert, who married Joan, daughter of Sir Robert Ogle, and had issue by her, with others, a son, Robert, by whom he was succeeded. This Sir Robert Manners married Eleanor, daughter of Thomas, Lord Roos (by Philippa his wife, daughter of John, Lord Tiptoft, Earl of Worcester), and sister and co-heiress of Edmund Lord Roos, "whereby he greatly increased his estate, and among other possessions, had the ancient seat of Belvoir Castle, built by Robert de Todenei, a noble Norman, on a stately ascent, overlooking the beautiful valley adjacent (thence by him called *Belvoir*, from the fair view of the country thereabouts), and it became the chief seat of that great barony, bestowed on him by William the Conqueror; which seat and barony, in the reign of Henry III., devolved upon Robert de Roos, a great baron, by marriage with Isabel, daughter and heir of William de Albini, the fourth of that name, descended from the said Robert de Todenei; and from the Lord Roos it came to Sir Robert Manners by his marriage," as did also many other estates in other counties. The issue of this marriage was three daughters, who each married into the family of Fairfax, and two sons. The eldest of these sons was Sir George



THE PEACOCK AT ROWSLEV.

Manners, who, on the death of his mother, became Lord Roos, and was also lineal heir to the baronies of Vaux, Trusbut, and Belvoir. He married Anne, only daughter and heiress of Sir Thomas St. Leger, by his wife Anne, daughter of Richard, Duke of York, and sister to King Edward IV., and widow of John Holland, Duke of Exeter. By this lady, who brought royal blood into the family, Sir George had a numerous family, the eldest of whom succeeded him.

That was Sir Thomas Manners, who, on the death of his father, became thirteenth Lord Roos of Hamlake, and Baron Trusbut, Riveaulx, and Belvoir. He was with Henry VIII. and his Queen at the celebrated interview between that monarch and the King of France at Guisnes, and in the same reign was made Warden of the East Marches, and had many other honours granted him. In the seventeenth year of the same monarch he was created Earl of Rutland—"a title which none but the royal family had ever borne, and by reason of his descent from the sister of King Edward IV. had an augmentation to his ancient arms," or two bars azure, and a chief *gules*; which chief was augmented thus:—quarterly *azure* and *gules*:—in the first and fourth two *fleurs de lis*, and in the second and third a lion *passant guardant*, all *or*. He

was also installed a Knight of the Garter. A few years later this nobleman was present at the second interview between Henry VIII. and Francis I.: he was also present at the marriage of his sovereign with the ill-fated Anne Boleyn; and, later on, attended Anne of Cleves to England, and was made her chamberlain. His lordship, who, besides the honours we have briefly indicated, took part in most of the events of this stirring reign and held numerous important offices, married twice: first, Elizabeth, daughter of Sir Robert Lovel; and, second, Eleanor, daughter of Sir William Paston, by the latter of whom only he had issue. To the eldest and second of that issue we now refer.

The eldest son, Henry Manners, succeeded his father, in 1543, as second Earl of Rutland. He was married twice: first to Margaret, daughter of the fourth Earl of Westmoreland, by whom he had issue; and, second, to Bridget, daughter of Lord Hussey, by whom he had no children. He was succeeded by his eldest son, Edward Manners, as third Earl of Rutland, who, dying without male issue, was succeeded by his brother, John Manners (the second son of the second Earl), as fourth Earl of Rutland. This nobleman married Elizabeth, daughter of Francis Charlton of Apsley, by whom he had issue, with others, three sons—Roger Manners, Sir Francis

Manners, and Sir George Manners—who successively became fifth, sixth, and seventh Earls of Rutland. All these dying without surviving male issue, the title passed to the descendants of the second son of the first Earl, as we shall now show.

Sir John Manners, second son of the first Earl of Rutland, and who was consequently great grandson of the sister of King Edward the IV., is the one member of this illustrious family with whom Haddon is especially connected. This John Manners, before he was knighted, became attached to Dorothy Vernon, the youngest daughter and co-heiress of Sir George Vernon of Haddon Hall, known far and wide as "the King of the Peak," as we have related in our last chapter. Disguised, it is said, as a forester or woodman, John Manners for some time lived in the woods about Haddon, in the hope of obtaining occasional glimpses of, and stolen interviews with, Dorothy Vernon; and at length so wooed that he won her, and carried her off on horseback into his own county of Leicester, and there married her. The story of this romantic elopement is one of the pleasantest episodes in the history of Haddon, and will have again to be alluded to, later on. By that marriage the grand old mansion of Haddon Hall, and the Derbyshire property of the "King of the Peak," passed into the family of Manners, and helped to swell its already large rent-roll of estates.

This John Manners, who was knighted in 1603, had issue by his wife, Dorothy Vernon, three sons: Sir George Manners who succeeded him; John Manners, who died at the age of fourteen years; Sir Roger Manners of Whitwell; and Grace Manners, who married Sir Francis Fortescue, of Salden. He died June 4th, 1611; his wife died in 1584.

Sir George Vernon, their son, married Grace, daughter of Sir Henry Pierpoint, and sister to the Earl of Kingston, by whom he had issue, with others, John Manners, his eldest son, who not only succeeded him, but also succeeded his own cousin George, seventh Earl of Rutland, in his title and estates, and thus became eighth Earl of Rutland. He married Frances, daughter of Edward, Lord Montague of Boughton, by whom he had issue four sons and seven daughters.

He was Sheriff of Derbyshire in the ninth and eleventh years of Charles I., and also represented that county in Parliament. His lordship was attached to the Parliamentary interest during the Civil Wars, and was one of the twenty-two peers who remained at Westminster when the king summoned both houses to attend him at Oxford. As a consequence, his castle of Belvoir was seized by the Royalists, and was held by them and Sir Gervase Lucas, and here the king frequently resided; it was finally surrendered to the Parliamentarians in January, 1645-6. In 1649 the castle was demolished, by consent of the earl, who soon afterwards set about rebuilding it, which he completed in 1668. During this time the earl lived principally at Haddon Hall, where he died in 1679. Here he lived in a style of almost princely magnificence, maintaining a large number of servants and retainers, and dispensing his hospitality with a lavish hand, especially at Christmas time.*

* The following particulars respecting one of these open-house entertainments in 1663 are curious and highly interesting:—

	£	s.	d.
Paid George Wood, the cook, for helping in the pantry all Christmas	3	0	0
Paid Robert Twindell, for helping at the like work all Christmas, and two weeks	1	5	0
Paid William Green, the cook, for helping in the kitchen all Christmas	1	0	0
Paid Antony Higon, turnspit, for helping all Christmas	0	3	0
Paid W. Creswick, for pulling fowls and poultry all Christmas	0	3	6
Paid Catharine Sprig, for helping the scullery-maid all Christmas	0	3	0
Paid Thomas Shaw, the piper, for piping all Christmas	2	0	0
Given by my honourable Lord and Lady's command to Thomas Shaw's man	0	10	0
Given by their honours' commands to Richard Blackwell, the dancer	0	10	0
Given by their honours' commands, to Ottiwel Bramwell, the dancer	0	10	0
Given by their honours' commands to Ottiwel Bramwell's kinswoman, for dancing	0	5	0

About this time, from 1660 to 1670, although the family only occasionally resided here, there were generally killed and consumed every year at Haddon between thirty and forty beeves, from four to five hundred sheep, and a number of swine, so that there was no lack of the good things of this world for visitors to this hospitable place.

This nobleman was succeeded by his third and only surviving son, John Manners, as ninth Earl of Rutland. This nobleman was born in 1638, and, in 1679, was created a peer in his own right by the title of Baron Manners of Haddon; and in September of the same year, his father dying, he became Earl of Rutland. When twenty years of age he had married the Lady Anne Pierpoint, daughter of the Marquess of Dorchester, from whom he was afterwards divorced; and married, secondly, Lady Diana Bruce, widow of Sir Seymour Shirley, and daughter of the Earl of Aylesbury, who died in child-bed. His lordship married thirdly Catherine, daughter of Baptist Noel, Viscount Campden, by whom only he had surviving issue. He lived a country life, and "kept up his old mansion at a bountiful old rate," and in a style of even greater magnificence and open-handedness than his father. It is said that at Haddon

alone he kept seven score of servants, and that every day saw his grand old banqueting-hall filled to overflowing with retainers and guests. In 1703 the earl was raised to the highest dignity in the realm, by the titles of Marquess of Granby and Duke of Rutland. He died in January, 1710-11, aged seventy-three, and was succeeded by his only surviving son, John Manners.

John, second Duke of Rutland, when scarcely seventeen years of age, was married to Katherine, second daughter of Lord William Russell, who was beheaded in 1683. He then bore the title of Lord Roos; and the wedding festivities seem, judging from some curious letters still extant concerning them, to have been of the most lavishly extravagant character. This lady, who was sister to the Duchess of Devonshire and to the Duke of Bedford, gave birth to five sons and four daughters, and died in child-bed, in 1711. The Duke married, secondly, Lucy, daughter of Lord Sherard, and sister of the Earl of Harborough, by whom also he had issue, six sons and two daughters: his grace died in 1721, and was succeeded, as third Duke of Rutland, by his eldest son, John Manners. This nobleman, who was born in 1696, married, in 1717, Bridget, only daughter and heiress of Lord Lexington

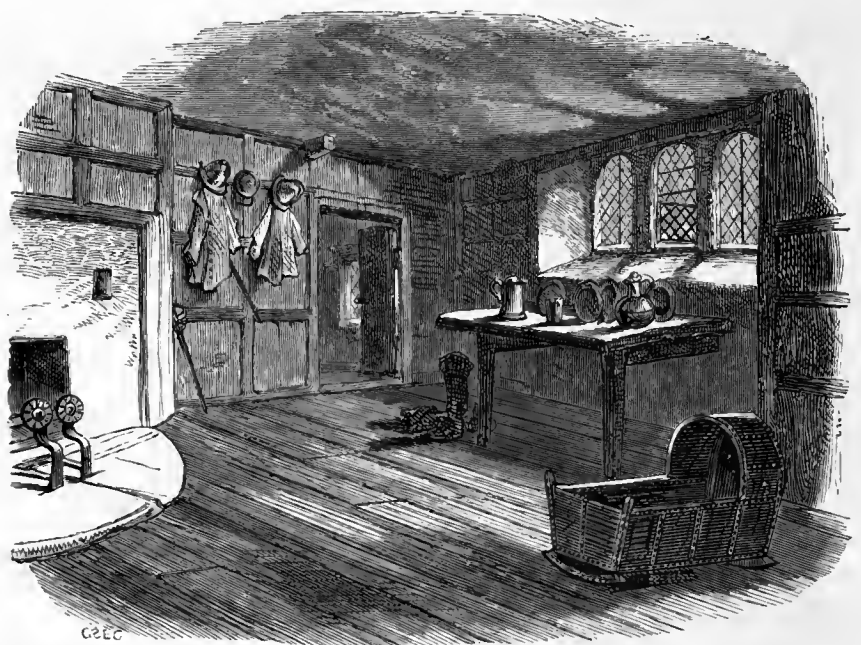

THE CHAPLAIN'S ROOM.

(an alliance that gave him a large accession of estates), by whom he had issue thirteen children, nearly all of whom died young.

He was the last of the family who made Haddon Hall a residence.

The estates of Lord Lexington having been settled upon the younger branch of the family, the second and surviving sons, successively, took, by Act of Parliament, the additional surname of Sutton, and thus founded the family of Manners-Sutton.

The duke, who was familiarly known as "the old man of the hill," dying in 1779, was succeeded by his grandson, Charles Manners, son of the celebrated Marquis of Granby, commander-in-chief of the British forces in Germany, and Master of the Ordnance, who died during his father's lifetime. Charles, fourth Duke of Rutland, married Mary Isabella, daughter of Charles Noel, Duke of Beaufort, by whom he had issue four sons—viz., John Henry, who succeeded him, Charles Henry Somerset, Robert William, and William Robert Albini; and two daughters—viz., the Lady Elizabeth Isabella, married to Richard Norman, Esq., and Lady Catherine Mary, married to Lord Forester. His grace died while holding office as Lord-Lieutenant of Ireland, and was succeeded by his eldest son—

John Henry Manners, as fifth Duke of Rutland, who married Elizabeth, daughter of the Earl of Carlisle, and by her had issue, among others,

his grace the present Duke of Rutland (third son, the two elder ones having died before their father), and Lord John Manners, M.P. His grace died in 1857, aged seventy-nine.

The present peer, Charles Cecil Manners, sixth Duke of Rutland, Marquis of Granby, Earl of Rutland, and Baron Manners of Haddon, &c., &c., was born in 1815, and has held many important appointments. His grace is not married: the heir to the title and estates being his brother, Lord John Robert Manners (Marquis of Granby, by courtesy), M.P. for North Leicestershire, who is also known for the official posts he has held in the government of this country.

The arms of the Duke of Rutland are, *or*, two bars, *azure*; augmented by a chief, quarterly, first and fourth *azure*, two *fleurs-de-lis*, *or* (France), second and third *gules*, a lion *passant-guardant*, *or* (England). Crest, on a *chapeau*, *gules*, turned up, *ermine*, a peacock in pride, proper. Supporters, two unicorns, *argent*, horns, manes, tufts, and hoofs, *or*. Motto, "Pour y parvenir."

And now, having exhausted, as far as is necessary, the family history of Haddon, and given a brief account of the place itself, let us turn to the building as it stands, and describe some of the chief rooms and other interesting features of this once gay, but now deserted, mansion.

The place is grand in its solitude, and attrac-

tive in its loneliness; and as the visitor passes on from room to room, from court to court, from chamber to chamber, or from tower to tower, and peoples them, in his imagination,

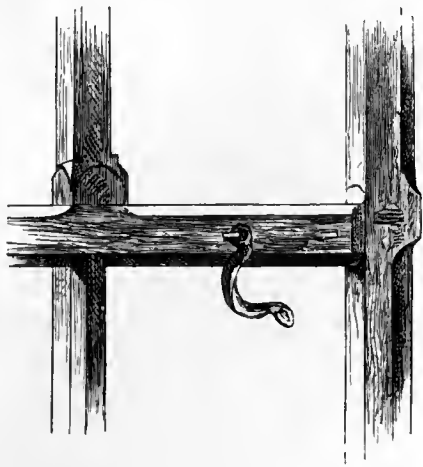

THE HAND-LOCK.

with the beings who have "lived, and moved, and had their being" there, he is ready to say—

"Pleasant to see is this English hall
Of the olden time, on a summer's day,
Turret and tower, and buttress and wall
Shining and shadowed in green and grey.
Strange, to think of those times of old,
And of those who lived there,—only a tale,
Doubtfully, dimly, guessed and told,
Of châtelines fair and of knights in mail,
Though the place remains where they lived and died,
Seen, as they saw it, by you and me,
The scenes of their lives, of their griefs and their
pride,
Telling its tale unmistakably.
The light still shines through the latticed pane,
As it shone to them, and the shadowed door
Is the shadow they saw, and the stains remain
Of the wine they spill'd on the dais floor.
The river that runs by the old Hall's walls;
Murmured to them as it murmurs now;
The golden glow of the sunset falls
As it fell for them, on glade, river, and bough:
The hall where they feasted, the church where they
prayed,
Their cradles, and chambers, and gravestones, stay;
While lord and vassal, youth and maid,
Knight and lady, have passed away."



STAIRCASE TO MINSTRELS' GALLERY.

The CHAPEL which, after the so-called "CHAPLAIN'S ROOM," is the first part of the interior of Haddon Hall shown to visitors, is, as will be seen by reference to the ground plan, at the

south-east corner of the building. It consists, at present, of a nave with side aisle, and a chancel, and is entered from the court-yard by an arched doorway opening into a small ante-chapel, or vestibule, through which the visitor passes. At the entrance is a *stoup*, or holy-water basin, and from the ante-chapel a staircase leads up to the turret. The arches and pillars of the nave are Norman; but the arches have been cut from their original semicircular to their present arched form, and the pillars cut and "shaved" down, and their capitals altered in character. Sufficient of these capitals, however, remains to show what was their original design. At the west end of the nave is a remarkably fine and large vestment chest of very thick timber, having carved on its front two shields of arms. At the opposite (east) end of the nave is a carved corbel, and, on the floor, is the fine old altar-table of stone bearing the usual five incised *crosses-pattée*, emblematical of the five wounds of our blessed Saviour.

Against one of the pillars is a circular Norman font of massive construction, on which is a curiously-constructed cover. This font is shown in one of the engravings in the former chapter. The chancel is raised a little above the nave; and on each side is a large high pew, with open railings in their upper portions, which have

been used for the noble families who have inhabited the place; and the carved panels, and the traces of gilding and colour they contain, show, along with the remains of paintings on the walls, how magnificent must have been this place of worship in its palmy days.

The windows were formerly filled with stained glass, but nearly the whole was stolen and carried away some years ago, and all trace of it is lost. In the east window, however, which is of five lights, and of the Perpendicular period, there yet remain many fragments and figures, &c. In the centre is a remarkably fine Crucifixion; and in the next lights, on either side, is a kneeling figure. Below these are the arms, in shields, *argent*, a lion rampant *gules*, ducally crowned, *or*; *argent*, fretty, *sable*, a canton of the first; and another shield the bearing on which has been lost. At the bottom of the window are the remains of an inscription to Sir Richard Vernon and Benedict Ludlow his wife, as follows:—*Orate pro aïabus Ricardi Vernon et Benedicite uxors eius qui fecerunt anō dñi milesimo CCCXXVII.* This Sir Richard Vernon, who was born in 1391 and succeeded his father in 1401, married Benedict, daughter of Sir John Ludlow of Hodnet, and died in 1451. He was "treasurer of Calais, captain of Rouen, and speaker of the Parliament of Leicester, in the



THE BANQUETING-HALL: WITH THE MINSTRELS' GALLERY.

fourth year of Henry VI. in 1426." Above the crucifix are the royal arms, quarterly, first and fourth France, second and third England.

In the chancel, within the altar rails, on the south side, is a *piscina*, and in the bottom of the north window are the remains of an hour-glass stand. In the south window are the arms of Pype, *azure*, crucilly of cross-crosslets and two pipes in pale, *or*, and those of Vernon, *argent*, fretty, *sable*, on the dexter side of an impaled shield, the impalement on which is lost. In the north window are the arms of Vernon, &c., and others are in a mutilated condition. There are also some good figures, one of the best of which is St. Christopher bearing the infant Jesus.

On the walls of the chapel will be noticed many remains of wall-painting of a comparatively late period, and in the timber-roof are some interesting features.

Leaving the chapel, the visitor will cross the court-yard to the BANQUETING-HALL; but he will notice on his way a flight of stone steps leading from the court-yard, near the doorway of the ante-chapel, up to the state apartments, so that the family could attend the chapel without passing through the hall, and could also, with their guests, be admitted at other times to their suite of rooms.

In this first court-yard he will also do well to take especial notice of the beautiful and intricate

designs on the lead-work of the heads of the spouts—many of which are filled with delicate Gothic tracery—and the gargoyles, or waterspouts, some of which are grotesquely carved in figures of curious character, and some of them of uncouth shape. One or two of these we have engraved for a future chapter.

Entering the open doorway of the advanced porch which, with a wide passage adjoining, forms the way through to the inner, or second, court-yard, the visitor will notice, standing on the stone bench on his left hand a fine Roman altar which, many years ago, was dug up in the grounds. It bears the inscription,

DEO
MARTI
BRACIACAE
OSITIVVS
CAECILIAN
PRAEFECT
COH I AQVITANI
V S

Which may be rendered, "To the God Mars, Braciaca, Ositius Caecilianus, Prefect of the first Cohort of the Aquitani, in performance of a vow"—the term *Braciaca* as applied to Mars being singular.

To the left of the passage four arched doorways conduct respectively to the buttery, the great

kitchen, and other domestic offices, and to a staircase leading to the long suite of chambers on the north side, and also communicating by means of a gallery in the Banqueting-Hall, with all the other apartments of the building. To the right is a massive and time-worn oak screen, with two open doorways, which divide the Banqueting-Hall from the passage. Entering by the first of these openings in the screen, the visitor will not fail to notice a suspicious-looking little iron bracket with ring attached, high above his head. This, tradition says, was an instrument of punishment for enforcing the observance of laws of conviviality. For it is said, if, in the days of feasting and merriment in the "good old times," a man should fail to drink up his quota of liquor, he was fastened up by the wrist to this ring, and the liquor poured down his sleeve so as gradually to trickle down him on to the floor; or, if guilty of any other breach of the law or decorum of the board, he was similarly tied up and compelled so to remain during the carousal, and was treated now and then not only with a stream of cold water poured down his sleeve, but by other indignities forced upon him.

The BANQUETING-HALL, or GREAT HALL as it is sometimes called, measures, within the screen, about 35 feet in length and about 25 in width, and it is of the full height of the building, with an open timber roof. It is entered, as has just been stated, by two open doorways in the screen which separates it from the passage. This screen also forms the front of the MINSTRELS' GALLERY over the passage. The screen is beautifully panelled, each panel being headed with cinquefoil cusps, above which is other Gothic tracery of elegant design. At the opposite end from this screen is the raised dais for the lord and his family and honoured guests, where still stands the grand old table on which so many of the good things of this life have been spread in ages long since passed away. This table is one of the finest examples of its kind yet remaining any where in existence—it is now worm-eaten and decayed, like those who once feasted around it; but still it stands, a proud monument of those ancient times so long gone by. To the right hand, on entering, is the gigantic fire-place with its huge open chimney; and on the opposite side, at the end next the high table, a flight of steps leads up to the state apartments; and close by, through a corner partitioned off by the oak wainscoting, another door leads to the private dining-room and to the grounds. On the walls of the Banqueting-Hall are some magnificent stags' heads and antlers, which bear evidence not only of extremely fine growth, but of great age since they fell to the lord of the chase. There are also several pieces of old furniture: and on the walls are oil-paintings of Martin Middleton of Hazelbadge, and of an old and favourite huntsman and gamekeeper—honoured and respected retainers of the family.

The Minstrels' Gallery occupies one side and one end of the Banqueting-Hall—that portion of the gallery along the side forming a passage from the drawing-room and state apartments on one side to the range of rooms on the other. The portion of the gallery over the end of the hall is considerably wider than the other, and would hold a goodly company of minstrels, or of guests, to look down on the "lord of misrule" and other revels below. In one of our future engravings we shall show the panelled front of the minstrels' gallery, and on the preceding page we give a vignette of the entrance to the gallery from the drawing-room.

Passing out from the Banqueting-Hall, the visitor should next enter the DINING-ROOM, which is one of the most charming, and certainly one of the most interesting, apartments in the whole building. The end opposite to the entrance doorway is entirely taken up by a Gothic window of eight lights, filled with glass disposed in an elaborate geometric pattern. In some of the lights are shields of arms in stained glass, one of which displays the arms of Vernon with its quarterings of Avenell, Pype, &c. &c.; another, Vernon only; and another, Vernon impaled. This room is wainscoted, the upper row of panels throughout the room being filled in with exquisitely-carved Gothic tracery and with heraldic bearings, &c.

Over the centre of the fire-place are the royal arms of England (quarterly France and England) with the supporters, a grey-hound and a griffin, and on one side a shield bearing the three feathers of the Prince of Wales with the initials E. P., and on the other the arms of Vernon with its quarterings, and supported by a lion and a boar. Below these is the motto,

"DREDE GOD AND HONOR THE KYNG," carved in Gothic capitals. Near this also is the carved inscription, "Anno Dni 1545. Monseigneur de Vernon," and, with arms, the initials "G. V.," and "M. V." The remainder of this fine old heraldic frieze, contains a large number of shields bearing the arms of the Vernons and of the various families allied with them, interspersed with the



THE TERRACE.

Vernon crest, &c. At the end of the room next the fire-place is a small, but exquisitely beautiful, recessed, or oriel, window, with seats on all sides, and forming one of the most delicious little retirements imaginable—overlooking, as it does, the lawns and terraces, and the romantic grounds and winding river, of Haddon. This

recess is panelled in the same elaborate heraldic and Gothic manner as the room itself, and, besides the coats of arms, and crests, bears on one of its panels a grotesque head of a court fool, or jester, traditionally said to have been intended as a portrait of Will Somers, jester to the "merry monarch;" and to his predecessor;



THE HALL FROM THE TERRACE.

and on two others the heads of Henry VII. and his Queen, Elizabeth of York.

The ceiling of the dining-room is divided into compartments, by transverse beams, and has been elaborately painted and decorated. In the large window will be noticed a fine old wine-cooler of bronze, and the fire-place and fire-dogs are also very curious and interesting.

The arms in our initial letter are those of Vernon quartering Avenell; the ornaments are portions of the decorations of the ball-room.

Having now described the rooms so far, we leave the visitor for a month, resuming in our next the description of the remaining apartments and of the grounds of Haddon Hall.

OBITUARY.

PATRICK MAC DOWELL, R.A.

IN our volume for the year 1850 there appeared an engraved portrait of this distinguished sculptor, an engraving of his famous group 'The Triumph of Love,' and a biographical sketch, in the form of a letter from his own pen, of his life up to that date. The paper supplied our contemporaries, daily and weekly, with the notices that have appeared since his death on the 9th of December, as announced in our last number. We must refer to it ourselves for the remarks it is now our duty to make.

Ireland has given birth to a large number of our most eminent artists, both painters and sculptors; the latter, perhaps, claiming to be the majority. Mr. Mac Dowell was born in Belfast, on the 12th of August, 1799. His father was engaged in business in that town, but having embarked in some commercial transactions which proved ruinous, his losses so preyed on his mind that he fell ill and died soon afterwards, leaving a widow in very straightened circumstances, and an infant-boy, the future sculptor. At the age of eight the latter was sent to board in the house of an engraver named Gordon, with whom he remained four years; and it was here that a love of Art first developed itself, in the attempts to copy on a slate the prints he saw either in the house or the shop-windows.

When he had reached his twelfth year, the mother and her son came over to England: the latter was sent to reside with a clergyman in Hampshire, where he remained two years. At the expiration of the time, it was thought expedient that some business or profession should be found for him, and as Art of any kind was regarded as too precarious, his friends resolved to apprentice him to a coach-builder, and a master was found for him in London, with whom he lived four years and a half; when, his employer becoming a bankrupt, the youth went to reside in Charles Street, Middlesex Hospital, at the house of a French sculptor or modeller, named Chenu. Here was an opportunity for turning his natural talents to some account; and he made such good use of it as to copy a small figure of Venus holding a mirror, with which Chenu was so pleased that he purchased it. Encouraged by this unexpected appreciation, he continued for some short time to model figures of small size, which he sold. An advertisement that appeared in the public papers—to which his attention was directed by two young Scotchmen then living in the same house with him, in Seymour Street, Euston Square—inviting sculptors to compete for the execution of a monument to the memory of Major Cartwright, a well-known radical politician of the day, induced him to enter the arena with his brother-artists. "I set vigorously to work," he says in his autobiographical sketch, "and working night and day completed a model of the figure, a pedestal, moulded and painted it, and sent it to the house of Peter Moore, Esq., M.P., where the committee was sitting. Arriving there late, they had already selected a model; however, they eventually chose mine, and asked me if I would allow the artist, whose design they had previously chosen, to model the *basso-relievo* which he had on his pedestal, on mine. I thought it but fair that he should do the whole pedestal: this was agreed on, but the sum subscribed at the time did not amount to more than £700, being about half the sum necessary." This lack of sufficient funds to remunerate the

young sculptor prevented him from carrying out his work; but another artist, thinking it would answer his purpose, undertook the task, and actually executed it from Mr. Mac Dowell's model, which he generously allowed him to use, at the request of Major Cartwright's family. It led, however, to the bankruptcy of Mr. Clarke, the sculptor to whose hands the work was entrusted.

But the transaction was not without benefit to Mr. Mac Dowell; Mrs. Cartwright engaged him to produce a bust of her deceased husband; and other similar commissions occasionally followed. When not engaged in modelling portraits, he essayed ideal subjects. The first work of this kind was a small group from Moore's 'Loves of the Angels,' which, at the period when the sculptor wrote to us, was in the possession of Mr. George Davison, of Belfast. His next work was a group from Ovid, 'Cephalus and Procris,' a commission for Mr. E. S. Cooper, then M.P. for Sligo. It was followed by a life-size group of 'Bacchus and a Satyr.' A figure, 'A Girl Reading,' exhibited in 1837 at the Royal Academy, attracted the attention of the late Sir James Tennant, some time M.P. for Belfast, and a native of the town, who at once sat to him for a bust, as did afterwards Lady Tennant; and, further, Sir James gave him an introduction to his friend Mr. T. W. Beaumont, M.P. for Northumberland: this was the fortunate turning-point in Mac Dowell's career; for Mr. Beaumont gave him an order for the 'Reading Girl,' to be executed in marble, and also commissions for two groups of any subjects the sculptor might select. One of these was 'The Triumph of Love,' the noble group we engraved.

The following is a list of Mr. Mac Dowell's principal works, and the dates of their exhibition at the Royal Academy:—Statue of a Girl going to Bathe'—the model in 1840, the marble in 1841; 'A Girl at Prayer'—model in 1841, marble in 1842; 'Cupid'—model in 1842, marble in 1845; 'The Triumph of Love,' 1845: all these were commissions from his friend and patron Mr. T. W. Beaumont. 'Statue of Viscount Exmouth,' 1846, executed for Greenwich Hospital by order of the Government; 'Virginius and his Daughter'—model in 1847, marble in 1850; 'Early Sorrow,' 1850, a commission from Mr. Beaumont; 'Cupid and Psyche,' a bas-relief; 'Eve'—model in 1849, marble in 1865; and a *replica* of 'A Girl Reading,' in 1849; 'Psyche'—model in 1850, marble in 1851; and 'William, Earl of Warren,' a model for the bronze statue in the Houses of Parliament, in 1850; 'The Slumbering Student,' 1851; 'Love in Idleness,' model, 1852; 'The Day-Dream'—model in 1853, marble in 1858; 'The First Thorn in Life,' executed for Mr. T. Baring, M.P.; 'Model of a Statue of the late Earl of Belfast,' afterwards cast in bronze, and erected in Belfast at the cost of the inhabitants, 1856; 'Model of a Statue of the Earl of Chatham,' erected in the Houses of Parliament, 1857; 'Model of a Statue of Viscount Fitzgibbon,' who fell at Balaklava, cast in bronze for the county and city of Limerick, 1858; 'Children of Mr. John Pender,' 1866; 'The Young Mother,' 1867.

Since the year last mentioned Mr. Mac Dowell exhibited nothing but one or two busts: among the numerous works of this class he produced and exhibited during his career may be chronicled, in addition to those of Sir James and Lady Tennant, already referred to, busts of the Earl of Belfast, Lord Dufferin, Lord Beaumont, Alderman Cubitt, M.P.; Sir Henry Stacey, M.P.; Rt. Hon. J. Whiteside, M.P.; Sir Joshua Jebb, Mr. John Pender, M.P., &c.

The last great work from the hands of this eminent sculptor is the fine group typical of Europe, for the Albert Memorial in Hyde Park, which has recently been placed there, but not in time, we believe, for Mr. Mac Dowell to see it in its destined position. We have an engraving of it in hand for early publication. Several of his most important works have at various periods supplied us with subjects for the illustrations of modern sculpture which have appeared in our annual volumes: for example, 'The Triumph of Love' (1850), 'Early Sorrow' (1851), 'Virginius' (1853), 'The Day-Dream' (1855), 'The Earl of Belfast' (1856), 'Lord Fitzgibbon,' and 'The Earl of Chatham' (1858), 'A Girl Reading' (1860). He was elected Associate of the Academy in 1841, and Member in 1845.

A son of Mr. Mac Dowell has on more than one occasion made his appearance at the Academy as an exhibitor of busts.

PHILIP HARDWICK, R.A.

The close of the past year added another name to the list of those whom death has removed from the ranks of the Royal Academy; namely, that of Mr. Hardwick, the architect, who died on the 28th of December, in the seventy-ninth year of his age. He was born in 1792, and entered the office of his father, Mr. Thomas Hardwick, also an architect, who had studied his profession under Sir William Chambers. The life of Mr. Philip Hardwick was, as it has been remarked by a daily journal, "singularly uneventful, and the record of some of his works is really the record of his public career." The first of these which brought him into prominent notice were the buildings at St. Katherine's Docks. The erection of the Euston Square Railway Terminus enlarged his reputation; while several important edifices constructed from his designs in London—as the Goldsmith's Hall, generally regarded as his finest work, the Globe Insurance Office, and the City Club—testify to his adherence to what is known as the classic style of architecture. One of his latest principal structures is the Hall and Library of Lincoln's Inn: in this and some preceding works he was greatly assisted by his son, who bears the same name, and has become most favourably known in the profession.

Mr. Hardwick was for many years architect to the late Duke of Wellington and to the Commissioners of Greenwich Hospital. He was a Fellow of the Royal Society, and of the Institute of British Architects, whose gold medal he received on one occasion: at the International Exhibition of 1855 a gold medal was also awarded him. We must add that the new Roman Catholic cathedral at Limerick, opened in 1860, was erected from his designs. He was elected Associate of the Academy in 1839, and Member in 1841; but in 1869 was placed, by his own request, on the list of "Retired Academicians."

PETRUS VAN SCHENDEL.

Few modern Belgian painters are more popularly known among us than this artist, whose death is recorded to have taken place in Brussels on the 29th of December last: he was in his sixty-fifth year. Visits we paid to his studio in 1865, and the information with which he supplied us at that time, furnished us with materials for the biographical sketch that appeared in our volume in 1867, in the series of papers

entitled "Modern Painters of Belgium:" to the pages in question we must refer those of our readers desirous of learning more of him and his works than we have now space to give. For several years past he was an occasional exhibitor both in London and in our provincial galleries; and since the opening of the picture-gallery in the Crystal Palace, it has rarely been without some examples of "Candlelight" Van Schendel, the *sobriquet* he acquired for his favourite method of treating many of his subjects. As a painter of sacred history this artist had a good reputation in his own country, where he adorned several of the churches with altar-pieces.*

THOMAS BOTT.

The late Mr. Thomas Bott was born at Hyde, near Kidderminster, in the year 1829. He served some years to his father at the trade of making handles for spades; but the employment was not at all congenial with his taste, and during his leisure hours and at every available opportunity he occupied himself with drawing; so that, when scarcity of work compelled him to seek other employment, he was able to obtain what was more suited to his ability. His first engagement as a draughtsman and painter was at Messrs. Richardsons, of Stourbridge, Glass Manufacturers; a firm celebrated for the artistic character of its productions. Mr. Bott, after a little time, went to Birmingham, where for two or three years he painted portraits, in which Art he was very successful: he also decorated Japan wares. Having always a great inclination to paint on porcelain, he left Birmingham, and sought employment from Messrs. Kerr and Binns, at the Royal Porcelain Works, Worcester: this was in September, 1852. His first attempts on porcelain showed very little prospects of ultimate success; but after a few months' practice he was enabled to paint the heads, and to make sketches for the Shakspeare dessert-service for the Dublin Exhibition in 1853. The first piece of any note which he painted was a *plateau* of Parian decorated with a series of subjects from Raffaele's 'Cupid and Psyche.' In 1853 Mr. Binns, being desirous of introducing the style of the Limoges enamels on porcelain, commenced a series of experiments on black and *gros-blue* grounds. Mr. Bott was employed to undertake the task, and the first successful pieces were submitted, in 1854, to H.R.H. the Prince Consort by Mr. Binns. The Prince gave the work his most unqualified approval. From this date Mr. Bott's chief employment was in works of what is now known as Worcester enamel. These works were exhibited in Paris in 1855, and obtained high praise from the jury. In 1860 her Majesty the Queen honoured Messrs. Kerr and Binns with an order for a dessert-service in enamel on turquoise. It was exhibited in 1862.

The subjects for painting in the Worcester

enamels were generally selected from the works of Raffaele, Correggio, and others of the old masters; and Flaxman and Maclise of the modern. A very beautiful *plateau* with the story of Cupid and Psyche, was selected by the city of Worcester for presentation to H.R.H. the Princess Royal on her marriage. Mr. Bott painted the *déjeuner* set presented by the city of Worcester to the Princess of Wales on her marriage. The decorations were in coloured enamels; the subjects from Correggio. He also painted the set of vases presented to the Princess by the Ladies of Worcestershire: they were white enamel on *gros blue*.

A very beautiful *plateau* and ewer of his work was selected for presentation to the Countess of Dudley on her marriage; and a fine set of vases, in the same style, was presented to the Countess of Beauchamp on her marriage. A *plateau* and ewer in white enamel on *gros blue*, with subjects from Maclise, is now on exhibition at South Kensington, and may be considered one of his finest works; but the pair of vases to be exhibited at the International Exhibition in 1871 will certainly be the most important examples which ever came from his hand. The general character of Mr. Bott's works was beauty of drawing and a careful delineation of the human figure: the faces of all his figures are most expressive and exquisitely fine. A list of his principal "pieces" is in preparation.

At the latter end of the year 1869, Mr. Bott showed some signs of ill-health; and in March, 1870, he had a slight attack of paralysis, which entirely incapacitated him from following his usual occupation; and notwithstanding every effort made to check the disease, it gained upon him, and resulted in his death on December 13.

THE EPIPHANY OFFERING AT THE CHAPEL ROYAL, ST. JAMES.

A CURIOUS ceremony is still kept up at the Chapel Royal of St. James, and was duly observed this year. January 6, or Twelfth Day, after the reading of the sentence at the offertory, "Let your light so shine before men," &c., two members of her Majesty's household descended from the royal pew and advanced to the altar rails, preceded by an usher, and presented to the officiating clergy a red bag edged with gold lace, containing the Queen's offering of gold, frankincense, and myrrh, in commemoration of the gifts of the Magi to the infant Saviour. A century ago, the King, preceded by heralds, pursuivants, and the Knights of the Garter, Thistle, and Bath, made the offering in person: this has been discontinued since the illness of George III. According to ancient legends, the wise men, commonly called the Three Kings of Cologne, were named Melchior, Jasper, and Balthazar. Melchior gave our Lord gold, in testimony of his royalty as the promised king of the Jews; Jasper, frankincense, in token of his divinity; and Balthazar, myrrh; in allusion to the sorrows which, as a man, our Redeemer suffered. In the catacombs of St. Nereus and St. Archillens, at Rome, is a painting assigned to the end of the second century, containing one of the earliest known figures of the Virgin, in which four Magi are represented as bringing her gifts—two on each side. Sir J. Maunde-ville tells us the Greeks call the kings Galgalathe, Malgalathe, and Sarathie, and the Jews Appellius, Americus, and Damasus. Sæwulf saw at Bethlehem the *marble* table at which they were entertained by the Virgin. After death the bodies of the three kings are said to have been removed to Constantinople, and thence to Milan. An enormous sarcophagus in the chapel of St. Martin, in the latter city, is still

shown, which is stated to have contained them. In 1162, the bodies were presented to Archbishop Reinald, of Cologne; and a magnificent shrine was prepared for their reception. The sacristan now tells visitors that it is worth £250,000. In the Middle Ages it was believed that their names carried about the person was a never-failing remedy against the "falling sickness."* At Dunwich, in Suffolk, a ring was found some years ago thus inscribed:—

"Jasper fert myrrham: thus Melchior: Balthazar anrum:
Hæc tria qui secum portabit nomina Regum,
Solvitur a morbo, Christi pietate, caduco."

In Art, Melchior was usually represented as a bearded old man; Jasper, as a beardless youth; and Balthazar, as a Moor with a large beard. The monarchs of Spain, where the feast of Epiphany is likewise called the "Feast of the Kings," are accustomed to offer gold, frankincense, and myrrh, on the altar. Selden, in his "Table Talk," p. 20, says—"Our chasing kings and queens on Twelfth Night has reference to the Three Kings." According to Blount, the inhabitants of Staffordshire made a fire on the eve of this day in memory of the blazing star that conducted the Magi to the manger at Bethlehem. In 1792, the French altered the day from "La Fête de Rois" to "La Fête de Sans-Culottes."

Tresylre printed at Paris "La Vie des Troys Roys, Balchazar, Melchior, et Gaspard;" and Wynkyn de Worde, in 1516, printed "The Lives of the Three Kings of Colen." In one of the Chester pageants, acted by shearmen and tailors, they are called Sir Jasper, of Tars; Sir Balthazar, King of Saba; and Sir Melchior, King of Araby.† The sign of the Three Kings was used by Julian Notary, in St. Paul's Churchyard, one of the earliest printers. It was also a constant mercer's sign.

Frankincense (German *frank*, free Saxon *francan*; Latin *incensum*, from *incendo*, to set on fire) was, Dr. Kitto thinks, of two kinds: one from the coasts of Arabia, and the other from India. There is, however, no direct evidence of the existence of the tree or shrub producing it in the southern coasts of Arabia. Wellstead could not see it when travelling in the quarter where it should be sought; and Niebuhr affirms that it was introduced from Abyssinia. Pliny says that incense was not used in sacrifices till after the Trojan war, when fragrant woods were applied to give an agreeable smell to the victims when burning. St. Hippolytus, Bishop of Portus (c. A.D. 235), in speaking of the last days, observes—"The churches mourn with great mourning, because neither oblation nor incense is presented." Though now declared illegal in the churches of the Anglican communion, it was frequently used here after the Reformation.

Myrrh (Latin *myrrha*, Greek *myrrha*, a plant from Hebrew, *mar*, bitter) was used by the Egyptians for embalming their dead. They also offered it to the Sun, or Re, at Heliopolis, when that orb was in the meridian, burning it in censers. Myrrh is an exudation from a tree called *Balsamodendron myrrha*, found in Arabia and Abyssinia. The Greeks attributed a fabulous origin to this resin, considering it produced by the tears of Myrrha, daughter of Cinyrus, King of Cyprus, who had been changed into a shrub. The Jews, who copied the Egyptians in embalming, used myrrh for that purpose. Johnson, in his "Travels in Abyssinia," i. 249, states that myrrh and mimosa trees abounded in Kovanhedudah, in Adal. The former he describes as being a low, thorny, rugged-looking tree, with bright green trifoliate leaves. The gum exudes from cracks in the bark of the trunk near the root, and flows freely upon the stones immediately underneath.

JOHN PIGGOT, Jun.

* For several years past his pictures have been collected by Mr. P. L. Everard, the well-known dealer of Bedford Square, from whom several of the leading amateurs in England and Scotland acquired the specimens which adorn their galleries. The subjects for which Van Schendel was especially renowned were his market-scenes by candle and lamp light, one of which, a very important work, engraved as a woodcut in this Journal in 1867, is now in the possession of T. Mackenzie, Esq., of Glasgow; another is included in the collection of Charles Kurtz, Esq., of Liverpool, while a third belongs to Samuel Taylor, Esq., of Leeds. Small gems from the pencil of Van Schendel are to be found in the possession of Mr. P. Kaye, of Huddersfield; Mr. W. Mallinson, of Huddersfield; J. Clarke, Esq., Fairy Croft, Saffron Waldon, and other connoisseurs, by all of whom they are highly appreciated, and to whom the decease of the artist will considerably enhance the value.

† In the trial of the smugglers for the murder of Chater and Gullely, excisemen of Chichester, in the last century, one of the prisoners was found with this charm in his pocket. With this scrap of paper in his possession he had considered himself quite safe from detection. (Hotten's "Sign-boards," 302.)

‡ In 1336, a splendid pageant was got up at Milan by the preaching friars, to celebrate the festival of the Three Kings: a vast concourse of people assembled to witness it.

INSTITUTE OF PAINTERS IN WATER-COLOURS.

SKETCHES AND STUDIES.

THIS Fifth Winter Exhibition more than sustains any acquired reputation of the Institute; indeed, in some points, these sketches and studies have an advantage over the collection made by the elder and rival society. The exhibition is, in truth, at once more sketchy and more studious. In fact, the effective strength of the Institute is from time to time reinforced by new recruits, so that, within the last few years, the aspect it presents has changed for the better. The latest new-comers, Mr. Small and Mr. Collier, are undoubted acquisitions. On the other hand, we regret to say that the "lady members" and the "honorary members" bring little strength. The latter, it would seem, will have to be given up. The catalogue indicates they have become useless. Two contradictory lists show they have diminished. The first contains the names of Madame Henriette Browne, Mr. Herbert, R.A., and Mr. Maclise, R.A., all left out from the second list. The catalogue confesses to the fact that not a single honorary member contributes to the exhibition, though, in addition to the above, the names of Rosa Bonheur, Gallait, Goodall, Maclou, and Millais are comprised. Such defalcation can scarcely be matter of surprise, seeing how heavily all artists of position are now taxed by the demands of exhibitions ever on the increase. The Institute, however, need not feel discouragement in the failure of a measure which at the time seemed politic. The staff of members and associates remains strong enough to secure an exhibition of at least average value, and of more than common variety. We shall have the pleasure of pointing out the drawings which, out of a total of 355, seem signal in merit, or singular by departure from ordinary routine.

Valentine Bromley and James D. Linton are wholly out of the common beat: the path in which they severally tread is of their own making. The catalogue commences with 'Mischief' (1), one of those quaint, comic, mediæval figures, wherein Mr. Bromley rejoices: the gamut of colour is that of missal-painting. 'A Minstrel' (29), by the same artist, is in like serio-comic vein: herein the furniture, decorated with lanky storks full-length, is of the style to which the "Mediæval Court" in the Exhibition of 1862 was devoted. Mr. Bromley's drawings remind us of the illustrations to Viollet le Duc's works on Gothic architecture in France: they are revivals of bygone days; they have the advantage of recalling epochs when costumes were picturesque, and manners piquant. Mr. Linton, too, is something more than modern: he has fallen under the spell of the historic past; thus '1795' is a figure which, while taken from living nature, has the animus, not to say the diabolical spirit, of Danton and other demons of the first French Revolution. In mood less malignant is 'Fortune-Telling' (334), a drawing exquisite in curve of line and modelling of head and neck. This and prior works lead us to look for higher efforts than Mr. Linton has hitherto ventured on. 'The Minstrel' (237) is a mistake: the artist will have to contend against waxiness and porcelain smoothness of surface. Like other exhibitors in the gallery, Mr. Linton has been trained to precision, and just distribution of spaces, by drawing on wood. Accordingly, he actually gives a wood-block in a gold frame. We think that an exhibition expressly set apart to "sketches and studies" might with advantage illustrate other arts and processes. In these days the arts have endless appliances and applications, and young artists of venturesome spirit and diversified talent are constantly trying their hands on something new and experimental. A gallery which should open its doors to varied applications, utilitarian and ornamental, of the pictorial and plastic arts, is yet a desideratum in the way of exhibitions. The Institute has already given proof of praiseworthy enterprise.

No artists work hand in hand so closely with literature as the members of the Institute. At

least a dozen names on these walls have become familiar in the pages of the leading illustrated papers; and it is understood that *The Graphic* in its Art-department is specially indebted to two or more artists who have made a reputation in this room. Mr. Luson Thomas exhibits a merry-making-scene, 'The First Christmas Pudding' (199), which would serve well for a "Christmas Number." The subject, especially in the child's face, is carried somewhat too far; but the intention evidently is to provoke a laugh. The public are already familiar, in the form of a woodcut, with Mr. Green's felicitous composition, 'Carrying Turf—near Galway' (291). The story is well told, the forms are pronounced with character, and figures and landscape blend and intermingle in pleasant harmony of colour. Mr. Gow is yet another member with a good eye for composition, as seen in 'A Look-out' (65) and 'Reconnoitring' (99): the last is admirably thrown together. The subject may have been suggested by recent military operations: the horsemen are well trained, and their lively attitudes and searching glances show them on the alert ready for emergency. Mr. Charles Cattermole is also strong in composition; indeed, his idea of a picture is usually better than his drawing and detail. 'Alms' (84) is his most complete work: evidently, this artist might, if he chose, approach very close to his great namesake and uncle. Among the mistakes to which he is subject must be placed a weak drawing, 'Cromwell delivering Wolsey's Letters to the King' (229). G. G. Kilburne and H. Mahoney present themselves as painters of pretty incidents. 'Primrose Time' (31), by the former, has almost the neat manipulation of a woodcut turned into colour: the work has both refinement and finish. 'Our Shadows' (326), by J. Mahoney, is a story fit for a child's book, nicely told. 'Modesty' (15) has the usual charm which attaches to the style of Emily Farmer. Last in this list, but not least, we add the name of William Small, the new Associate. 'Mid-day Rest' (14) bears the sign of belonging to the school of illustration; 'Autumn' (208) is another drawing which relies upon a subject and an incident: the colour is opaque and yet brilliant; the style has points in common with that of Mr. Pinwell. 'Dry Weather' (214) has also capital material: the geese seeking for water at a dry well are salient in character as creatures of the same species in a never-to-be-forgotten drawing by Mr. Walker. Mr. Small will evidently make himself welcome in the gallery which he has just entered.

Guido Bach, Augustus Bouvier, John Absolon, and J. M. Jopling, afford little new material for comment. We may say, however, that the worst detractors of Mr. Bach have not had the opportunity of quoting anything so greatly to his disadvantage as 'Hylas' (72). The work is meretricious, affected, and false in colour. Mr. Jopling's 'Still Life—Ireland' (177) is a pictorial pun—the "still" being the apparatus used for the illicit making of whisky. The drawing itself is a queer jumble. And yet whatever this artist knocks off is clever, while careless; as witness, 'Civil Service Camp, Wimbledon, 1870' (192). Here the treatment is essentially artistic, especially in the scheme of colour: a quiet pervading grey obtains lustre through brilliant masses well placed. We yet hope to see a production worthy of Mr. Jopling's talents, though the long delay in the realisation of the high expectations raised by early work begins to be serious.

The Institute has suffered loss in the migration to the old society of Mr. Deane, whose Italian buildings under a sunny sky are missed just in proportion as they will be long remembered. Carl Werner perseveres with his photographic facsimiles: nothing can be more faithful than the 'Arabic House, David Street, Jerusalem' (44). Skinner Prout has settled into a Prout-like style: 'Rouen' (274) is a capital rendering of the old materials left in that once most picturesque of cities. 'A Brown Study—Knole' (243), is a difficult subject skilfully brought together by D. H. McKewan. In the way of animal-painting, R. Beavis contributes a vigorous, and, for him, more than usually accurate study, 'Mountaineers—Argyleshire' (285). Louisa Corboux, a name not seen too

often in exhibitions, fills up a corner with the study of a cat. Flower-pieces, by Mrs. Duffield, are the best of the kind: this class of subjects is apt to repeat itself to weariness: the artist has obtained novelty in 'Sketches of Fungi' (316). Nature never repeats herself, though artists do; except when, as here, they go afresh to her.

The landscapes are neither better nor worse than might be anticipated. Mr. Leitch is, as usual, effective and brilliant in that most brilliant of scenes, 'Isola Bella, Lago Maggiore' (61). Harry Johnson's 'Stonehenge' (55) is after a style not suited to the spot: his well-known manner comports better with southern climes. T. L. Rowbotham, who has long romanced over Italy, comes to the Thames for a "ship-breaking," 'The Last of H.M.S. Agamemnon' (228): the artist surprises the eye by colour and effect, while he fails to satisfy the intellect by accuracy of form. Mr. Fahey has had, at the witching twilight hour, a poet's vision of 'St. Peters and the Vatican from the Tiber' (92). J. H. D'Egville, who seldom misses pleasing sentiment and pictorial unison, exhibits a drawing, silvery and grey, 'From the Foot of the Ramparts, Metz, looking towards Gravelotte' (267). It is strange to think that a scene so peaceful and placid in a picture-gallery should have been in reality ravaged by relentless foes. But nothing can ruffle the repose of an artist's mind when given to quiet contemplation. Mr. Hine, even 'On the Serpentine' (314), is the poet still: unconscious of ought that is cockney, the scene might be laid on Thrasymene or on the lakes of Albano or Nemi, so indifferent is the romantic painter to his local whereabouts. Mr. Maplestone and Mr. Shalders have also betaken themselves to the ideal—a certain plebeian idealism of English scenery, in which moorlands and sheep play the chief part. These artists in their present guise might pass for imitators of old David Cox, could they but subdue the violence of their purples down to the quiet of neutral greys. Two frames containing sketches from nature, by Mr. Henry Tidey, will attract and deserve attention. We rejoice to find William Bennett once himself again: 'Sketch in Marlborough Forest' (272) is in the artist's best style. No one, not even David Cox, has ever translated greens into greys with more exquisite unison. We congratulate the Institute on the acquisition of T. Collier, a sketcher in the old and best sense of the word. 'Near Wareham' (90) has the simplicity of nature when unconscious of picture-making: only a true artist could venture on presenting a subject thus unadorned. 'Crossing Burn Moor, Cumberland' (41), proves that Mr. Collier can not only sketch hastily, but finish deliberately. There is in London at this moment a sphere still unoccupied for Art of this quality. And the Institute, so long as it can mingle talent new with talent long mature, will not in vain throw open these winter exhibitions.

FRENCH PICTURES AT THE GERMAN GALLERY.

THERE is now open at the German Gallery, in Bond Street, a gathering of French pictures, which for many reasons is extremely interesting. The occasion is called "The First Annual Exhibition in London of Pictures, the Contributions of the Society of French Artists," though many of the works bear the names of men who have long since passed away. The affairs of this institution are administered by a committee consisting of MM. Diaz, Daubigny, Dupré, Fromentin, Isabey, Millet, and Ricard, all of whom, with one exception, are of the Legion of Honour. The collection, although limited, carries us back to the time of Greuze and Louis David, and thence forward to the present year of grace; and although there may be wanting many stars of the galaxy of French Art, there is yet wherewithal to assist an earnest inquirer to even correct assumptions with regard to the course whereby French painters have arrived at their present palmy state.

'The Iliad' and 'The Odyssey' are two small pictures by Ingres, remarkable from a variety of circumstances, but especially as the

work of one of the most eminent men of the French school. Both are profiles, and look as if they had been designed for sculptural *bas-reliefs* or for large pictures. They have no approach to the precision of M. Ingres' later works, but seem to refer to the nonage of his studentship, while yet making small chalk portraits for his support. They are curiosities, as the productions of a man who painted comparatively little, yet who exercised an influence over a large following. The concentration of the essence of the Iliad in a single figure would to most men be a hopeless proposition; here, however, is an essay which is less successful as a solution of the all but impossible problem, than happy as an illustration to which at least twenty passages in Homer are applicable. There is a difference so marked in the executive mechanism of these two pictures, as to leave room for the assumption that they were painted at different times. Of the two, 'The Odyssey' is the preferable: the intentions in that figure are declared, and plainly carried out; and there are recognisable the initiative of an advance which might, and did, end in the exquisite 'Odalisque.' 'The Death of Marat' (84), Louis David, is captivating—by no means by the subject—but by the simplicity and perspicuity of the narrative. The picture is so well known as to require no description. Nothing is seen of the figure but the head and bust, and these appear above the side of the bath. The left hand of the dead man yet holds a paper inscribed, "Marie Anne Charlotte Corday au citoyen Marat, Juillet, 1793. Il suffit que je sois bien malheureuse pour avoir droit à votre bienveillance." The rendering is perfectly literal, there is nothing left to sentimental speculation. Another well-known work is 'St. Sebastian helped by Holy Women' (39), Eugene Delacroix. The position of the Saint seems to have been suggested by that of the sleeping Faun. It is a study of foreshortening, but so low in tone that its parts are not clearly distinguishable. 'The Visit to the Hermit' by Greuze (27), is a favourable example of that artist's manner of painting grouped subjects. He is most commonly known by his small life-size single figures, the grace and sweetness of which have never been surpassed. In this picture we have a throng of young country-girls crowding round the hermit, from whom they are receiving presents; among these we observe the frequent re-appearance of that face, his wife's perhaps, we all know so well—a face which, in the advanced years of his long life, he repeated in chalk on paper, and was accustomed to sell for six francs. He had lost in the first revolution a fortune sufficiently ample for all his wants. 'The Christian Martyrs,' Thirion (17), exemplifies a taste which has prevailed greatly among French artists. The scene is a Roman arena, in which appears an assemblage of early Christians, about to be torn to pieces by wild beasts; but this taste is carried to its utmost limit in, 'An Execution at the Alhambra,' H. Regnault (108), in which a Nubian eunuch, it may be, has just severed the head of the victim. The horrors of the scene are but too faithfully set forth: a more healthy instance of M. Regnault's art is a portrait of the late General Prim, mounted on a black charger and surrounded by enthusiastic crowds of his admirers. By Hamon are two or three pieces; notably, a lady seated in a garden. The head looks like a successful modification of that of an antique bust, but the person is too *emboupointée* for comparison with any Greek statue. 'The Musician,' Roybet (87), presents a young man wearing a Venetian dress of the sixteenth century, playing the guitar. There are represented also, by Ziem, 'The Place of St. Mark, Venice' (1); Legros, 'A Snow Effect'; Ribot, 'An Old Man' (6), understood at once as an inspiration from Spanish Art, and very like Ribera; Gericault, 'The Trumpeter' (38); Delaunay, 'A Young Girl of Ischia' (51); John Lewis Brown, 'The Start of the Hunting Party' (55); Troyon, 'The Return of the Herd' (74); Ricard, 'Portrait of a Young Girl' (80); Roqueplan, 'The Young Mother' (96); Millet, 'The Lesson' (93); Diaz, 'The Loves of Psyche' (59); Isabey, 'Mail-Packet entering Harbour' (11); Artan, 'Sea-View' (9) and 'Marine-View' (16), both of which present only breadths of sea-views exclusive of allusion to life,

addressing themselves to the observation to note the phantom forms of the scudding clouds as they flit over the broad face of the waters. This is a daring proposition, and not always carried out with so much success as here.

In landscape the exhibition will be considered richer than those of French Art we have been lately accustomed to see. By Jules Dupré are 'Sunset' (37), 'Night' (28), 'Outbuildings of a Farm' (44), and others; Daubigny, 'The Banks of the Oise' (53), 'Sunset at Villerville' (22), 'A Village in Picardy' (45), 'Evening' (46), &c.; Theodore Rousseau, 'Morning' (61), 'A Large Forest in Winter' (70), 'Evening' (78), 'A Grotto on the Sea-shore—Brittany,' 'Mountains on the Borders of Lake Chambon' (65), &c.; Corot, 'The Rivulet' (94), 'La Charette' (97), 'Country Scene' (98), &c.; Diaz, 'Forest of Fontainebleau' (72).

Of the works we here note it may be observed, that one or two of the landscape-painters are numerically in great force; were these less liberally represented, a greater variety might have been secured: there are, however, sufficient to form a text for an observation on those men of eminence who have risen to distinction in what is called historical-painting. It is not difficult to trace the pedigree of their scholarship, nor is it more so to follow out the path whereby they have arrived at their conclusions in poetic, political, or military painting. But it is not so with the landscape section of French painters. This or that piece is pronounced pure, original in every thought that has contributed to its completion; but it is studiously unlike anything ever done by Claude, Jacob Ruysdael, Mindert, Hobbema, Poussin, Both; that is, it is an entirely new version of nature, and not comparable with anything in Art. There are many whose works are of this character; yet there are others whom we meet on common ground, and who discourse to us in the sweetest accents of Landscape Art. From this exhibition there is much to be learned by those who know somewhat of the recent and living school of French painting. The exhibition, therefore, cannot fail to be very attractive: it will, no doubt, be added to from time to time.

ART IN SCOTLAND, IRELAND, AND THE PROVINCES.

EDINBURGH.—A monument to the late Mr. G. McCallum, a promising young sculptor, lately deceased, has been erected in the Dalry cemetery. It consists of a slab of freestone, in the centre of which is a bronze medallion portrait, by Mr. D. W. Stevenson.

GLASGOW.—The corporation of this city has recently been presented with two busts: one, of the late portrait-painter, J. Graham Gilbert, R.S.A., the work of W. Brodie, R.S.A., and the gift of Mrs. Gilbert; the other, a bust of Shakspeare, by W. Mossman: it is the result of the celebration of the great dramatist's tercentenary, when the press dramatic amateurs performed *As You Like It*; the proceeds being devoted to a bust of the poet to be presented to the city.—The police force of Glasgow has given to the Police Board a memorial bust, in marble, by Mr. G. E. Ewing, of the late chief constable, Captain Smart.

DUBLIN.—A statue of the late William Smith O'Brien has lately been erected in one of the principal thoroughfares of this city. Surely the quasi patriots of Ireland could find many of her sons far more worthy of being thus honoured than the man whose vanity and self-esteem led him to imagine himself the redresser, by physical force, of his country's assumed wrongs, and who paid for his temerity by a lengthened term of penal servitude. Ireland has honoured very few of her great men and women.

BRADFORD.—The exhibition opened at Great Horton, near Bradford, in the month of August, was finally closed in November. It was visited by 71,495 persons, and the sum realised, after paying all expenses, reached £1,888, which is to be applied towards the liquidation of a debt on schools erected by the Congregational Dis-senters at Great Horton.

HERO.

FROM THE STATUE BY J. DURHAM, A.R.A.

POETS, painters, and sculptors have alike paid due homage to the mythological story of Hero and Leander. Hero, as it has come down to us, was a priestess of Venus at Sestos, on the Hellespont, of whose charms Leander of Abydos became enamoured, and to elude observation, was accustomed to swim across the sea at night to obtain interviews with the lady, who, from the top of a lofty tower, directed him on his course by means of a lighted torch. One tempestuous night Leander was drowned on the passage; and Hero, in despair, threw herself from the watch-tower and shared his fate.

Musæus, who flourished about the fourth century, most gracefully sung the tale, though his glowing poem would scarcely be accounted chaste by the refined judgment of our own times. Since his day the story has certainly exercised an enchanting influence upon the poetic imagination, for it has been the theme of numerous writers, foremost among whom must be reckoned Kit Marlowe, feelingly quoted by Shakspeare in *As You Like It*—

"Whoever loved, that loved not at first sight?"

Byron made it the subject of a most charming and touching introduction to the second canto of his *Bride of Abydos*. Tom Moore has left a few sympathetic verses on this theme; and Tom Hood rather a long poem, treating the story with great fancy: he makes a sea-nymph to fall in love with Leander while in the waters as the cause of his disaster; and she bears him to the caves below, only to find the form that so enraptured her voiceless and lifeless.

The figure we have engraved is one of two figures—the other being that of Leander—executed in marble by Mr. Durham, for George Fox, Esq., of Harefield, near Manchester, the owner of Crewick's picture of Bettws-y-Coed, also engraved in this number of our Journal, and of very many others some of which have also appeared in our work in the form of engravings. The sculptor has taken a quotation from Byron's canto as the "argument" of his statue of Hero:—

"Oh! when alone along the sky
Her turret-torch was blazing high
Through rising gale and breaking foam,
And shrieking sea-birds warned him home,
And clouds aloft and tides below
With sighs and sounds forbade to go,
He could not see, he would not hear
Or sight or sound foreboding fear;
His eye but saw that light of love,
The only star it hailed above;
His ear but rang with Hero's song,—
'Ye waves, divide not lovers long.'"

Mr. Durham has evidently thrown great power into the modelling of his statue, while this quality is combined with very considerable grace in attitude of form and general expression: the sentiment of eager expectation, not altogether free from alarm, is fully manifest. A front view of the figure—which, for the purpose of reproducing for engraving, is less desirable than that we have selected—would get rid of some of the angularities that now catch the eye not quite agreeably. The statue, viewed in its entirety, is a work of great merit: we know that the sculptor bestowed much pains and labour upon it to render it worthy of his long-acquired reputation, as well as to make it a valuable addition to the Art-gallery of the liberal patron who gave him the commission for both this and its companion.



HERO.

ENGRAVED BY R. A. ARTLETT, FROM THE STATUE BY J. DURHAM A.R.A.



BRITISH ARTISTS:
THEIR STYLE AND CHARACTER.
WITH ENGRAVED ILLUSTRATIONS.

No. XCVII.—BENJAMIN WILLIAMS LEADER.

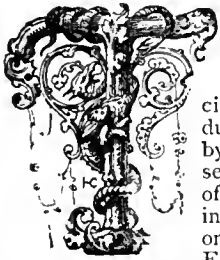

HE baptismal name of this excellent landscape-painter is Benjamin Williams, but he has long adopted the surname of Leader; by this he is known, not only in artistic circles, but among his friends. He was induced to assume it—an old name in his family, by the way—to distinguish himself from the several artists bearing that of Williams, to none of whom is he related. Mr. Leader was born in Worcester, where he has always resided, on the 12th of March, 1831: he is son of Mr. E. Leader Williams, a well-known member of

the Institute of Civil Engineers, who, in his capacity of engineer to the Severn Navigation Commission, has carried out, and is now completing, some large and important works for improving the navigation of that river. In the early days of Mr. Leader, his father, having a great love of Art, was accustomed to occupy some of his leisure hours with painting, to the great delight of his young boy, who would stand by watching him, and sometimes take advantage of his temporary absence from the easel, to put in a few "finishing touches" of his own. We have heard him say that he has a distinct recollection, when a child, of Constable paying a visit to his father at Worcester, though he could not associate him in any way with the glorious Art of one of the great painters of English landscape.

Mr. Williams intended to bring up his son to his own profession, and caused him to pursue a course of study that would qualify him

for it; but the youth found much more pleasure in sketching the picturesque lanes and cottages of his native county, than in taking measurements and drawing formal plans and elevations of locks and weirs: as the result, he soon abandoned engineering for Art. He seems to have had no direct instruction from any painter, but gradually worked his way to knowledge by the impulse of his own natural talents aided by such information and counsel as his father's experience gave him. One of his first pictures, a view near his present residence, was exhibited in the gallery of the Birmingham Society of Artists, where it was purchased by Mr. F. W. Hulme, the landscape-painter: this acknowledgement of its merits by a brother-artist, one, moreover, well able to judge of a good picture, was a great encouragement to the young exhibitor. In the autumn of 1856, Mr. Leader went into Scotland: the mountainous character of the country made a strong impression on his mind; for, till then, he had seen no higher hills than the Malverns, the neighbourhood of which was the great holiday-place of his childhood: a trip to Malvern with sundry wanderings over the hills and rocks was a pleasurable anticipation, to be talked about and looked forward to weeks beforehand. The same may be remarked of another class of subjects this artist frequently illustrates—the cottages, farm-houses, lanes, hedgerows, and churchyards, so exceedingly picturesque and beautiful, which abound in the vicinity of Worcester.

Some of the earliest pictures exhibited by Mr. Leader in London were hung in the gallery of the National Institution, Portland Place. One we saw there, in 1857, called 'A Trespasser,' was characterised in our columns as "of the best promise: we may safely expect the painter to take his place ere long among the magnates in Art." Of two pictures he sent the same year to the Royal Academy—the first time of his appearance there—one, 'A Stream from the Hills,' we also commendably noticed, as did Mr. Ruskin in his pamphlet on the exhibition. A second work, 'An English Homestead,' was hung in the gallery at the same time.

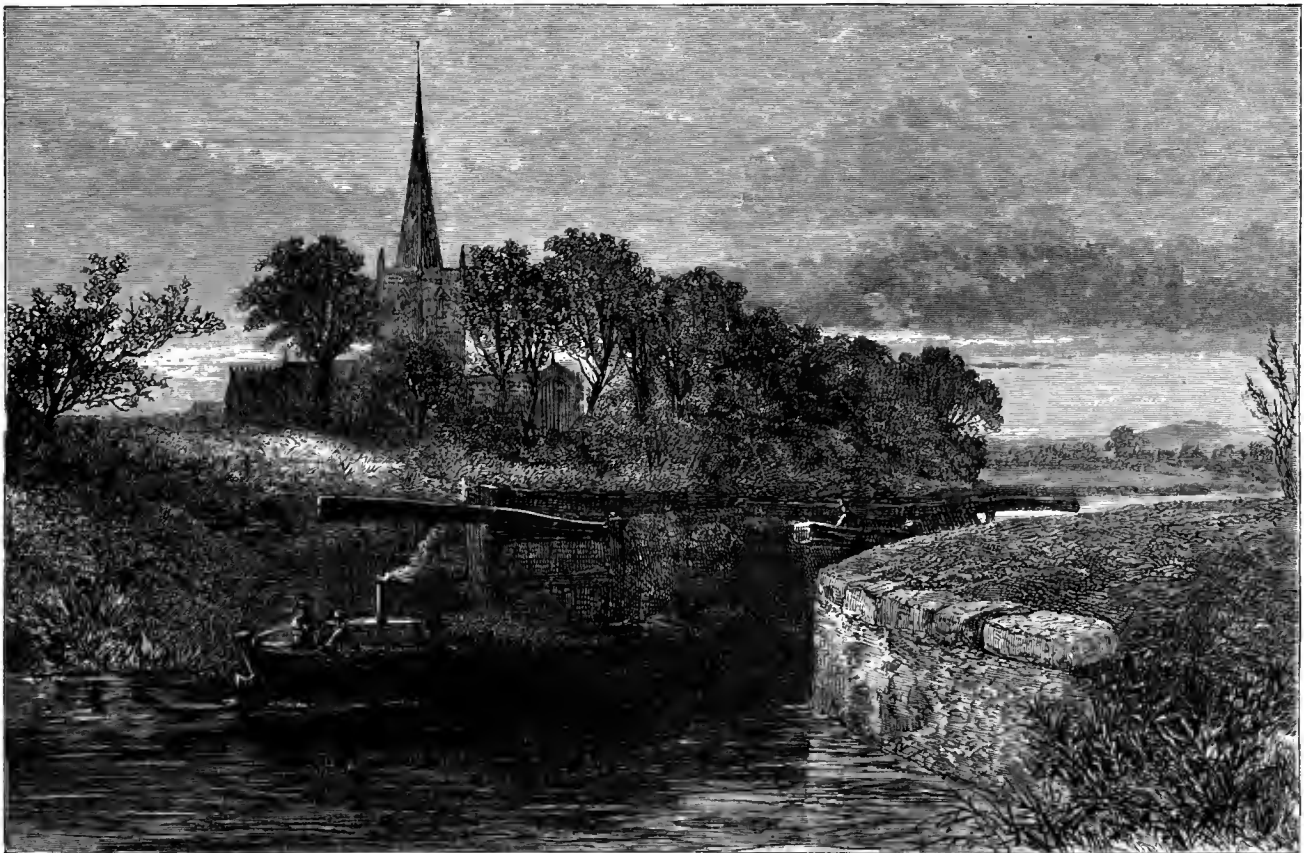

Drawn and Engraved by]

THE LOCK AND CHURCH, STRATFORD-ON-AVON.

[J. and G. P. Nicholls.

In 1858 he contributed several subjects to the National Institution; among them, 'In the Highlands,'—the result of a second visit to Scotland in the autumn of the preceding year,—'Where the Mosses thrive,' and 'Temptation: in the last, a boy standing by the side of the garden of an untenanted cottage, looks wistfully at the ripened crop on the fruit-trees. All these pictures attracted our notice by their truthfulness, and the patient assiduity with which the whole of the details are worked out. One of them—the second on the list, if we mistake not—was purchased by the late T. Creswick, R.A.; and it marks the estimate of Mr. Leader's

works by his brother-artists, when we add to the instances already given, that, out of four pictures in the Academy Exhibition of 1858, one, 'A Sketch on a Common,' was bought by Mr. A. Elmore, R.A.; and another, 'A Quiet Pool in Glen Falloch,' by the late D. Roberts, R.A. The third, 'A Chat by the Way,' was secured by the eminent picture-dealers, Messrs. Agnew. The title of the fourth subject was 'The Heath at Albury, Surrey.' These pictures necessarily brought the artist numerous commissions.

'Still Evening,' exhibited at the Academy in 1861, became the property of Mr. H. Hall: it was, unfortunately and undeservedly,

hung in such an out-of-the-way place in the gallery, as to enable us only to realise the fact; and we remarked at the time, that a fine picture seemed to have been purposely kept out of sight. In the following year he contributed two capital landscapes—'An Autumn Afternoon, Worcestershire,' with sheep in a stubble-field, and 'Summer-Time;' both of them compositions of much poetic feeling. A favourite method adopted by Mr. Leader in the treatment of his subjects is to present dark masses, trees and other objects, set against an evening sky, with the sunlight still glowing on the distant hills. An example of such effect we especially observed in his 'Welsh Churchyard,' exhibited in 1863, in which a group of almost black yew-trees stand, "like mourners watching over the

tombs;" a striking picture, which the taste and judgment of our present prime-minister, Mr. Gladstone, induced him to purchase. A large landscape, entitled 'A Sunny Afternoon, North Wales,' was in the Royal Academy the following year: it shows a reach on the river Llugy; and, to quote our remarks made at the time, is a work "wherein no trick of composition intrudes, for nature seems to grow unchecked by the hand of man, and unconscious of the beauties wherein she is clothed." The artist sent with it another, 'An English Churchyard—Autumn,' a very different subject, but scarcely, if at all, inferior in merit to its companion.

'Autumn's Last Gleam,' one of Mr. Leader's Academy-pictures of 1865, extorted from our critic high panegyric. "Taken for all

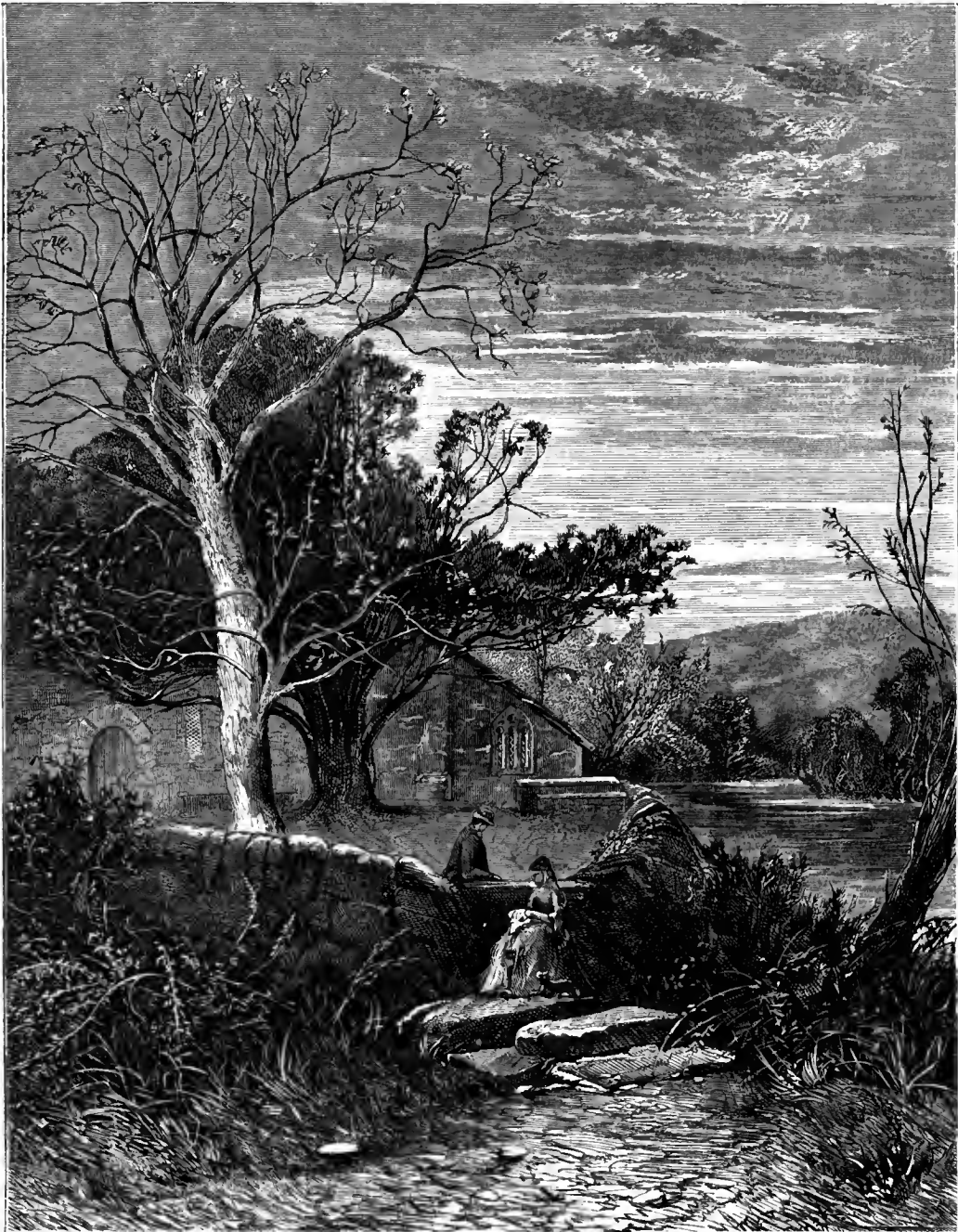

Drawn and Engraved by

THE CHURCH AND RIVER AT BETTWS-Y-COED.

[J. and G. P. Nicholls.]

in all," he says, "we question whether there is in the whole Academy a landscape so free from fault, and at the same time so abounding in unobtrusive merit as this, the masterpiece of Mr. Leader. Every object, whether mountain, tree, or rock, asserts its place without prejudice to its neighbour. The handling is dexterous without ostentation; the pencilling of the tree-stems, and the delicate touching of the leaflets against the sky, are points for special praise." His second picture of the year, a scene in the valley of the Lledr, entitled 'A Sunny Afternoon, North Wales,' is an exceedingly beautiful landscape. Both works were purchased by Mr. Alfred Castellan, of Liverpool. In 1866 we find him

exhibiting two most attractive pictures, with the respective titles of 'The Close of Summer' and 'A Fine Day in Autumn'—examples of Welsh scenery. In the next year he also contributed two pictures to the Academy—'An Autumn Evening in the Valley of the Lledr,' evidently a favourite locality of the painter, and 'Through the Glen:' the latter represents a dark, gloomy wood overhung by lofty cliffs.

That Mr. Leader could sometimes abstract himself advantageously from the beauties of Wales we have already seen; but such dissociation was especially manifested in the two works sent to the Academy in 1868—'A Fine Morning in Early Spring,' a view of the church-

yard of the parish—Whittington, near Worcester—in which he resides, with its venerable elms just beginning to show signs of renewed life, children gathering primroses, and sheep and lambs in the foreground; and 'A Moated Grange,' one of the old farm-houses that abound in Worcestershire, and bear evidence of having in years long gone by been mansions of some pretension. The hangers at the Academy paid these admirable works the compliment of placing them respectively on each side of the President's principal picture,—the portrait of the Earl of Bradford,—hung at the end of the large room.

Passing over, for want of space in the way of comment, his

pictures of 1869,—'An English River-side Cottage,' and 'Looking down a Welsh River;'—we come to those exhibited last year—'Chepstow Castle,' a good subject admirably treated; and 'THE LOCK AND CHURCH, STRATFORD-ON-AVON:' the latter, one of our illustrations, is remarkable for power of colour and general effect: it is the property of Mr. Jardine, of Alderley. Many of Mr. Leader's most important works have never been exhibited, but have passed direct from his studio into the hands of purchasers. Among them are the two subjects we have also engraved, 'THE CHURCH AND RIVER AT BETTWS-Y-COED,' in the collection of Mr. Fox, also of Alderley; and 'THE BIRCH-WOOD NEAR



Drawn and Engraved by

THE BIRCH-WOOD NEAR CAPEL CURIG, NORTH WALES.

[F. and G. P. Nicholls.]

CAPEL CURIG, NORTH WALES: both serving as examples of the attractive and thoroughly artistic manner in which he treats the picturesque scenery of Wales. In these, as in the majority of his other works, he shows a fine sense of the beauties of nature, in her varied aspects, allied with much poetic feeling.

Mr. Leader's style is a happy medium between excess of detail and over-elaboration on the one hand, and dash of execution on the other. There is enough of finish in his works to satisfy those who look for carefulness, but this quality does not degenerate into affected trivialities, while they show breadth of manner and brilliant effect by judicious arrangement of light and shade. His

colouring, too, is generally pure and true to nature: latterly, however, he seems too much inclined to a free use of browns: this is notably prevalent in his large picture, 'A Worcestershire Cottage,' in the present "Winter Exhibition" at Mr. Wallis's gallery in Pall-Mall: the reflections in the water of the cottage and the almost leafless trees are a mass of brown, giving great heaviness to the right side of the composition, while the left side is full of clear daylight: the contrast is not agreeable. We would offer a friendly hint on this point to one of our best landscape-painters, for as such we regard Mr. Leader.

JAMES DAFFORNE.

PUBLICATIONS
OF MESSRS. PARTRIDGE.

THE several works under this head, which we proceed to notice, are produced under the direct superintendence of Mr. J. B. Smithies—a gentleman whose name is closely associated with some of the best useful, philanthropic, or charitable, Institutions of London; who has long been recognised as the “animals’ friend,” and the strenuous advocate of Temperance; whose “good works” are, indeed, very numerous, in many ways. But as a philanthropist he does not come before us: we have to do only with his publications—those, more especially, that derive aid from Art.

The books upon our table range from productions of much elegance to those of a common order—common, however, only in the sense that they are cheap: we have an *Almanack* containing twelve excellent engravings, at the price of one penny; the *Children’s Friend*, in parts, at the cost of one penny; the *British Workman*, for which the monthly charge is one penny; the *Infant’s Magazine*, the *Friendly Visitor*, and the *Family Friend*, monthly periodicals at one penny each part. For those who can expend shillings instead of pence, we have comparatively luxurious volumes: “Dogs and their Doings” and “Our Feathered Companions;” but these are, in so far as Art is concerned, little, if at all, superior to the cheapest of those we have enumerated.

It is to the Art-excellence of these several works we desire to direct the attention of our readers. Within the memory of persons not old, the artist had done nothing for the young: the coloured prints that illustrated “Jack the Giant-Killer,” “Puss in Boots,” and “things” of that class, were atrocities with two or three spots of green, red, and blue, that taught the worst possible taste, and inculcated lessons that had afterwards carefully to be unlearned. Nay, until within a recent period, it was thought a waste of time and labour to incur expense in ministering to the needs of children in children’s books. That evil has been removed: what they now see is, for the most part, thoroughly good: very rarely is aught put before them bad, either in design or in execution; and from the very earliest period in life such prints as those under notice may be accepted as safe guides, whether the object in view be mere pleasure or sound instruction.

Let any person, old or young, take up *The Children’s Friend*. The twelve monthly parts are issued for twelve pence, containing fifty engravings, so good that we need not blush to own we can supply no better in the *Art-Journal*. The same may be said of *The Band of Hope Review*, the twelve parts of which cost sixpence. The *British Workman* is perhaps even better: the leading prints here are in size 16 inches by 12. It would be impossible for money to procure examples of Art of a higher order of its kind. In short, to produce either of these “cheap” works cost has not been considered: excellence only was aimed at, and it has been fully, almost invariably, attained.

It is, therefore, not too much to say that these publications are exercising an influence on the age—of immense importance and value to its future; and he or she will be a great and wise benefactor who helps to furnish every cottage and workshop in the kingdom with a supply of such continual and beneficial teachers. Hung or fixed on the walls of humble dwellings, they would be not only sources of continual delight, refreshments after labour, silent instructors always, but they would give an air of comfort to a home, no matter how rude, have a perpetually humanising influence, and while many from the dram-shop and the beer-shop. Let any philanthropist try the experiment: place some half-dozen of the larger prints on any such wall as we describe: the cost will be sixpence. It will not be long before the good man, or, more probably, the good woman, seeks and finds others of a like kind to associate with them—taking from the miserable toll of the publican to give it to the artist. Who can over-estimate so valuable a boon?

It is enough to say that the letter-press in these cheap publications is always pure, sound, rational, and practical; although religion is everywhere prominent, it is ever associated with consideration, charity, love; inculcating all the virtues of social life, by pleasant lessons rather than serious sermons; beguiling, rather than

pushing on, the reader to what is good, by cheering the eye and delighting the mind.

We give high praise to these “common” publications; but there is no one of our readers who will not endorse our opinion.

We cannot treat with greater respect the more ambitious publications of Mr. Smithies;

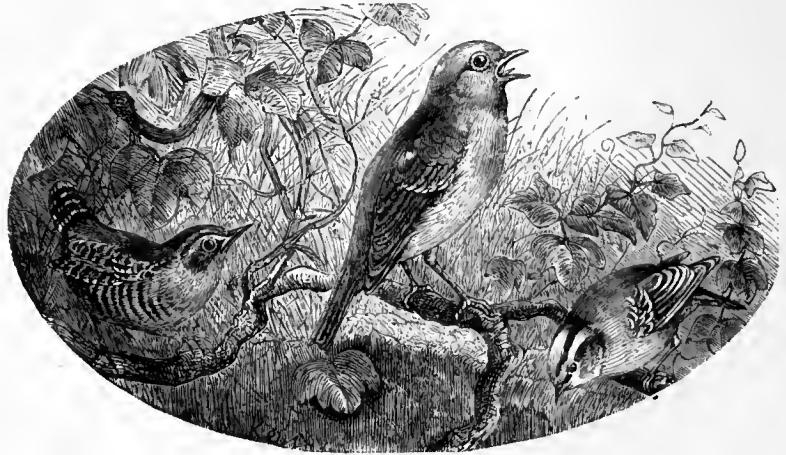

although they have finer paper and better binding, they have not finer or better Art. They are gift-books for wealthier buyers; but there is no family in England, high or low, who might not be content with either of the works

upon which we have passed brief but emphatic comments.

We have borrowed two cuts from “Our Feathered Companions:” we might have done so from *The Infant’s Magazine* or *The Chil-*



dren’s Friend, *The Band of Hope Review*, or *The British Workman*, with equally good effect, for the engravings in the one are as excellent as are those in the other. The Rev. W. Jackson brings before us, by descriptive anecdotes and engravings, the birds with which we are all familiar—in our groves and fields, by our sea-

strands, and even in our streets; while in “Dogs and their Doings,” work is done for them by the Rev. F. O. Morris: the purpose of these good clergymen being to advocate and inculcate humanity, as the great lesson taught by Him

“Who made—and loveth—all.”

THE ROYAL ACADEMY.

SECOND EXHIBITION
OF WORKS BY OLD, AND DECEASED, MASTERS.

THE success which attended the first exhibition last year, has naturally induced a second like virtuous attempt. The Academy has wealth and position that imply responsibilities; and among the functions which devolve on a powerful body representing the Art of the country, whatever conduces to the Art-culture of the profession or of the people at large may be accounted a sacred duty. That the present unrivalled collection, the choicest as well as one of the most extended ever seen under one roof, is calculated to raise the standard of Art, and to refine and elevate the tastes of the people, such of our readers as may have already visited Burlington House will gratefully acknowledge. And, as Englishmen, we cannot look around these goodly galleries without pride that our nation has been strong and rich enough to amass these treasures—that our shores have been so inviolate to the inroads of war that the accumulations of centuries remain intact, so that, at a moment when other countries are made desolate, we are enabled to enjoy cherished possessions in peace and quietness. *Deus nobis hæc otia fecit.*

The collection may be taken as a summary of the history of painting over a period of five hundred years: the earliest work is 'The Last Supper,' by Giotto, who died 1336; the latest is 'Salvator Rosa showing his Picture to a Dealer,' by Daniel Maclise, who was living in 1870. Between these extreme dates lie 140 painters, present in 426 works. The artists most fully represented are Vandyke, Murillo, Reynolds, Rubens, Ruysdael, Teniers, Titian, and Greuze. The greatest strength, as might be expected, from the known proclivities of our collectors, is in the Italian and Dutch schools. Spanish Art, notwithstanding the absence of pictures from Apsley House, is also seen to advantage in the two great masters of Valencia and Castile, Murillo and Velasquez. The chief deficiency is in the early German school: the Teutonic races, however, are represented by Holbein, Mabuse, and Van Eyck. The contributors to whom the public have reason to feel most indebted, are the Earl of Dudley, the Marquis of Westminster, Lord Ashburton, Lord Overstone, Thomas Baring, Esq., and Wynn Ellis, Esq. The hanging seems to have been governed by no other principle than to make each room agreeable. Chronological arrangement, or even a division into schools, may have been impracticable. Thus masters the most distant and manners the most diversified intermingle. Ary Scheffer encounters Turner and Tintoret; Reynolds, Gainsborough, and Constable, meet Rubens, Titian, Rembrandt, and Watteau. Our English painters pass through the trying ordeal unscathed.

The Pre-Raphaelite period is for the most part located in Gallery No. VI. Here is one of the earliest pictures Raphael ever painted: while at the age of seventeen and still in the school of Perugino, he may be said, if the paradox be permissible, to have been himself a Pre-Raphaelite. This famous 'Crucifixion' (307), from Earl Dudley's collection, bears, indeed, the traits of the early Umbrian masters; it is imbued with the spirit of Christian Art; even its defects lean to the side of religion; timidity merges into tenderness; the fearful hand paints reverently. In the whole range of Art-history there are few works of greater interest or of deeper significance. With this youthful production should be compared one of the most lovely examples of Raphael's mature manner—'The Three Graces' (309). The subject, as also the style, indicate how greatly Raphael was influenced by classic Art; indeed, the well-known sculpture-group of 'Graces,' in Sienna, is the original whence this picture was taken. The Greek work is the better of the two; the subject in translation from plastic to pictorial Art loses simplicity and dignity. The student should not fail to compare the above Raphaels with the examples of Perugino; in fact, the rare specimens of early Italian Art brought together

within this room afford an opportunity not to be missed of forming a correct judgment on the Pre-Raphaelite and Post-Raphaelite controversy. From this point of view very important is Fra Angelico's 'Last Judgment' (313), falsely in the catalogue entered as 'Il Paradiso'—falsely we say, because the composition comprises hell no less than heaven. The artist repeated with variations this tremendous subject four times: the version in the Florentine Academy we have usually deemed the best; but this well-esteemed work from Lord Dudley's Gallery is probably the most important example of the master possessed in this country. We are also indebted to the same collection for a choice specimen of that lovely, pure-minded master, Lorenzo de Credi, who, in dying, could not have charged his conscience with having committed a single act unworthy of a Christian artist. 'The Virgin and Child with St. John' (302) has, moreover, the merit of being in excellent condition: the pigments seem as pellucid as when they left the palette. The history of early Italian Art is further illustrated in the same room by some first-rate specimens of artists who in comparison with the spiritual Fra Angelico may be deemed material and mundane. Only in the Brera, at Milan, can Crivelli be better seen: the 'Pietà' (318), a characteristic example of this powerful, yet somewhat repellant, painter, we remember well in the Manchester Art-treasures. Three other specimens are now in Piccadilly, whereof the most noteworthy, 'Peter offering the Keys to the Infant Saviour' (303), we also owe to Lord Dudley. This picture should not escape the attention of decorative painters and designers. Crivelli, as was his wont, elaborates ornament on the accessories: upon his draperies he executes patterns which might with advantage be reproduced by our modern manufacturers. It may be remembered that the little picture by Van Eyck in the National Gallery furnished a London house with a pattern for a textile fabric. In like manner we think our Art-manufacturers might take some useful hints from several pictures in Piccadilly which date back to periods when not only the pictorial, but the decorative, Arts were at their prime. Leaving for the moment the Dudley Gallery, which contributes no fewer than 110 works ranging from Fra Angelico to Correggio, and down to Greuze, we turn to two very remarkable examples of Botticelli—'The Holy Family' (294), lent by Lady Ashburton; and 'The Nativity—Angels hovering in the Air' (278): the last, a work amazing for power and impetuosity, its fortunate owner, Mr. Fuller Maitland, contributed to the Leeds Exhibition. This picture has an importance which merits a place in a national collection. Less prominent, but equally precious, is the small "tempera panel," whereon Fra Filippo Lippi has painted 'A Saint' (281) so lovely as to pass well for an angel. This is one of the many and valuable contributions of Mr. Wynn Ellis. Among historic pictures few in Europe have greater interest than 'The Madonna and Child,' by Domenico Veneziano, lent by the Earl of Crawford and Balcarres, better known as Lord Lindsay, the author of 'Sketches of Christian Art.' This picture has seen strange vicissitudes. The painter, according to Vasari, was murdered in the streets of Florence by a fellow-artist out of jealousy; but Mr. Wornum, in his catalogue of the National Gallery, shows this widely diffused scandal to be untrue. In the 'Epochs,' Mr. Wornum gives the clue to the story of the picture before us in the following sentence:—"Perhaps the only existing work of Domenico is a fresco of the Madonna enthroned, which was removed from a tabernacle on the exterior wall of a house in Florence, and transferred to canvas by Rizzoli, of Cento, in 1852." Lord Lindsay, who has written much in elucidation of Arts and epochs comparatively little known, may be congratulated in being able to exhibit a fresco painted four centuries ago, which still presents a fairly good surface, notwithstanding it has undergone a most dangerous process—the transfer from wall to canvas. Other fragments of this famous fresco have been secured to the National Gallery from the collection of Sir Charles Eastlake.

We regret that, within the limits at our com-

mand, it will be possible only to state in brief the multitude of works here present. In addition to the Italian pictures before mentioned may be rapidly enumerated two superb portraits by Morone; 'A Spanish Warrior' (10), contributed by the Earl of Warwick; and 'Titian's Schoolmaster' (14), lent by the Duke of Sutherland. The supremacy of the Venetian school in portraiture is also attested by the figure of 'Cardinal Lorraine' (238), by Tintoret, contributed by the Earl of Chesterfield. Also 'A Senator' (101), by Sebastian del Piombo, from the collection of the Marquis of Lansdowne, belongs to the highest style of portraiture. Such heads absolutely live on the canvas. Likewise a study magnificent in Venetian colour is 'La Richiesta' (185), by Giorgione, from the gallery of Lord Ashburton. A more anomalous work from the same easel is 'An Italian Villa, with groups of figures' (227), which we owe to the Rt. Hon. Cowper-Temple. Of nine Titians the most conspicuous are 'The Woman taken in Adultery' (63), from the Gallery of the Marquis of Westminster; and a misnamed 'Susannah and the Elders' (365), due to Earl Dudley. The Venetian school is further amplified by more or less well accredited works of John Bellini and Bonifazio. We are again indebted to Earl Dudley for a fairly good example of this latter rare and charming master, 'The Virgin and Child with Saints' (357). The most noteworthy of four Bellinis is 'The Virgin and Child with Saints' (92): on either side hang figures of 'St. Sebastian' (91) and 'St. Mark,' by Il Conegliano, a truly great Venetian painter, comparatively rarely met with out of Italy. All three pictures are lent by Lady Eastlake. By Carlo Dolce we have a replica of the famous picture in Dresden, 'St. Cecilia' (81); by Guido Reni we have 'Fortune' (113), from the Westminster Gallery, one of several like pictures with which we are acquainted—Kugler mentions replicas in the Capitol, at Schleissheim, and in Berlin; by Tintoret there is the sketch for the magnificent picture in Venice, 'The Miracle of St. Mark' (95); and by Correggio, that no less illustrious work, 'The Reading Magdalen' (305)—a figure seen with slight variations in three places, viz., Dresden, Florence, and here in London. To the Dresden picture is commonly assigned the first rank; but Lord Dudley's version usually passes for a veritable Correggio. In addition we may add, that the Academy shows important works by Canaletto, Salvator Rosa, Garofalo, and Andrea del Sarto. The above enumeration indicates how richly are our English mansions endowed with the master-works of the great Italian artists.

The French school need not detain us long; and yet there are choice examples of Nicholas Poussin, Claude, Greuze, and David. We should scarcely know where to find a more delightful specimen of Poussin than 'Il Riposo—a holy family with angels' (85), from the Westminster Gallery. Claude, French only by birth, is present in the two priceless pictures from Leigh Court: 'Landscape—Landing of Æneas' (149), and 'Landscape—the Sermon on the Mount' (156). Louis David, an artist whom it is the fashion to decry, asserts once more his distinguished talent by 'Portraits of Pius VII. and Cardinal Caprera' (362). For this master-piece, as also for an unrivalled display of meretricious and alluring female forms by Greuze, we are indebted to the kindness of Lord Dudley, whose gallery has an equally liberal supply of schools spiritual and sentimental.

The Spanish school is weak except in Murillo, who is represented by no fewer than nineteen works, whereof the major part, which are from the Dudley collection, have been recently seen at Leeds. Of the others, the most noteworthy are 'The Boyhood of St. Thomas Villaneuve' (256), lent by Lord Ashburton, and 'Christ crowned with Thorns' (65), a highly-finished work pertaining to the artist's best period, lent by Mr. Francis Cooke. England is proverbially rich in Murillo, no country so much so except Spain. Lord Dudley sends his large but not very characteristic picture by Zurbaran, 'The Annunciation' (405), likewise exhibited at Leeds: to the same collection the Academy

also owes that magnificent 'Portrait of a Lady' (415) by Velasquez.

Flemish and Dutch masters are in amazing force: the works of Van Eyck, of Rembrandt, Rubens, and Van Dyck are the very best of their kind. Of three Van Eycks, 'A Philosopher in his Study' (191) is pointed out as a remarkably rare and choice example. Of Rembrandt the display is astounding, especially in the direction of portraits: that of 'A Burgomaster' (77), lent by the Earl of Warwick, and an anonymous 'Portrait' (114), from Lord Ashburton's collection, are scarcely to be surpassed. Eleven pictures by the prolific Peter Paul Rubens include master-pieces, such as a portrait of 'Arundel' (158), lent by Earl Warwick, which among the historic portraits at Kensington was conspicuous for rich harmonies of colour cast upon the armour-clad figure. From the collection of Lord Ashburton comes a 'Wolf Hunt' (110), which sustains the reputation of Rubens as one of the greatest of animal painters: the handling and colour are as distinct from, as they are superior to, like works by Snyders. Paul Potter's famous bull at the Hague finds a small and interesting *replica* in 'Bull and Sheep' (172), from the Baring collection, and an all but priceless example of Karl Du Jardin, 'Pigs—swineherd drawing water' (225), is one of the many very choice works lent by Lord Ashburton. Cuypp's cattle do not show so well as his boats and shipping, of which class 'A Calm—boats and figures' (209) is an exquisite specimen. A very choice Vanderneer, 'Landscape and River with Woodman and Fishers' (177), is lent by Lord Overstone. The Hobbimas and Ruysdaels are numerous and good—perhaps only in Holland exist so many works of the Dutch landscape-painters as can be found dispersed among the mansions of England. Also the Academy galleries bear witness to the strong liking of our collectors for the Dutch figure-painters who are here present in rare gems by Terburg, Metz, De Hooghe, Ostade, Steen, and Teniers. Space does not permit us to indulge in description of the very many works of this class which give to the eye, and even to the mind, exquisite delight, by their technical qualities, manipulative skill, realistic truth, and strong individual character. In Terburg's 'Music-Lesson' (142), lent by Mrs. Bradshaw, is one of the lustrous satin dresses for which the painter was so celebrated. Ostade's 'Still Life' (183), from Lord Overstone's collection, also strikes us as scarcely ever excelled for quality and texture of surface. We must leave to the reader the pleasant task of searching out for himself the many traits for which these cabinet-painters of Holland are conspicuous.

English painters, we are proud to say, take their place side by side with the great historic schools without prejudice to their good fame. Reynolds, Gainsborough, Romney, Raeburn, scarcely suffer by juxtaposition with Rembrandt, Vandyke, or even Titian and Tintoret. Among twenty-one works by Reynolds, nothing after the kind can surpass 'Sylvia' (132), lent by Lady Lyveden, or 'The Child in a Mob Cap' (385), from the collection of Lord Dudley. Both stand in everlasting proof of the painter's simple love of nature and sympathetic insight into the guileless moods of childhood. Reynolds, while the favourite of fashion, remained a child of nature, never spoilt in his art: these two picture-portraits, though injured by time, are still, for taste and artistic management, unapproached. 'Portrait of William Pitt,' by Blake, we pass as a parody: the painter must have had a mad fit upon him. Our native school of portrait-painting is further represented by 'Lady Russell and her Child' (137), after Romney's most bewitching manner; also by the 'Portrait of Mrs. Gregory' (54), about the most graceful work by Raeburn with which we are acquainted. Neither must we forget one of the most lovely and simple of heads ever painted by Gainsborough, 'Portrait of Edward R. Gardiner, nephew of the painter' (154). Liquid and pure are the pigments, and the touch is firm as it is delicate. 'Lear and Cordelia' (47), lent by Lady Ashburton, is one of the too few pictures lent by Newton, R.A. In the same room is 'Jacob's Dream' (31), an impor-

tant work by Stothard, R.A., lent by Lord Overstone. We are indebted to Mr. Thomas Baring for two famous examples of Mulready, 'The Whistonian Controversy' (146) and 'Train up a Child in the way he should go' (260). Mulready suffers more than we could have supposed in competition with historic schools.

Terburg, Ostade, Teniers, not to mention Van Eyck, of all of whom there are first-rate specimens, show themselves more thoroughly trained than Mulready, even in the technique of Art. Dyce, though his colours look new and crude by the side of canvases two centuries old, stands without injury the severe test to which he is here put. Two well-known pictures, 'Jacob and Rachel' (59), and 'Joash shooting the Arrow of Deliverance' (99), both lent by Mr. Schwabe, take their place in the gallery as a learned academic Art: they are, perhaps, the nearest approach now practicable to the high style of the old masters. Wholly different—that is, low, and not high—is a marked example of Wright, of Derby, 'The Forge' (245), from the collection of the Rt. Hon. W. Cowper Temple. Equally well does our English school of landscape, as seen in Crome, Constable, Callcott, Muller, and Turner, take its place side by side with the great historic landscapes of the past. Mr. Louis Huth contributes a capital Crome, 'A Landscape with Figures' (35): the tree-study in this simple English woodland is unusually close and true. In the same room are also two memorable Constables: one of uncommon delicacy and refinement, lent by Mr. Henry Vaughan, 'The Hay-Wain' (16), exhibited at Paris in 1825, when the artist received the gold medal from the King of the French; the other, a work of amazing vigour and bold impasto, lent by Miss Constable, 'The Cenotaph at Coleorton in memory of Sir Joshua Reynolds' (44). Constable, in common with Bonington, exerted considerable influence on the French school: Troyon, it is said, modified his style after he saw 'The Hay-Wain' in Paris. 'A Sea-piece' (124), from the Petworth Gallery, shows Callcott to advantage: the artist here combines Vandevelde and Stanfield. The Marquis of Westminster honours the fame of Benjamin Barker—a name scarcely known out of the provinces—according to its deserts, by the loan of a lovely 'Landscape with Figures and Cattle' (230). Lastly, the greatest of our landscape-painters is seen in his most imaginative mood by 'The Fifth Plague of Egypt' (140), lent by the Marquis of Westminster; and in his simple and nature-loving manner in 'Landscape with Cattle' (235), contributed by Lord Leconfield. A serious blunder has been committed by assigning to Turner 'Italy' (40): this work is said to be painted by William Muller, in emulation of Turner. 'The Slave Market' (12), serves to indicate how nearly Muller at one time approached to his great contemporary. Each painter, in fact, was distinguished by genius of an endless variety. We are bound, however, to add that competent judges pronounce both the 'Slave Market' and the 'Italy' to be forgeries. We abstain from publishing the name of the artist by whom these clever imitations are said to be executed.

The only objection we have heard raised against the exhibition, of which we have indicated the chief contents, is that it is too good to last. Doubtless the private collections of England, not being quite inexhaustible, must, when subjected to such heavy contributions, some day come to an end. Accordingly, it is understood that with this crowning success the experiment will probably cease. The President, however, has given the intimation that after a rest of a year or more, these most instructive collections may be resumed. In the meantime we tender to the Academy our warmest thanks for the high service it has conferred upon Art and upon the public at large.

[There is no ground whatever for the report that the Royal Academy will discontinue its exhibition of pictures by the old masters. On the contrary, we have reason to believe such exhibitions will be annual. They have not only "paid," they have been profitable: it is needless to remind our readers that the profits have been given to Art-charities. The private collections throughout Great Britain are not easily exhausted: a yearly supply, for many years to come, may be obtained; and there are few families in the kingdom who would not gladly contribute from their stores.—ED., A.-7.]

EXHIBITION IN AID OF THE DISTRESSED PEASANTRY OF FRANCE.

As an auxiliary means of contributing to the relief of the suffering peasantry of France, an exhibition and subscription were suggested by some English artists and amateurs to Mr. Wallis, the proprietor of the French Gallery, who at once entered warmly into the project, and not only offered a room for the exhibition, but also promised to contribute and exert his influence to procure the support of the English and foreign artists of his acquaintance. Preliminary arrangements having been effected, the project was publicly announced, when co-operation was at once proposed, and offers of pictures were made by many English and foreign artists. Contributions were immediately sent in, and liberal donations of money were made. A committee was formed, consisting of upwards of thirty noblemen and gentlemen, many of whom are distinguished Art-amateurs—patrons, and painters, English and foreign. The list of these names is headed by that of the Duke of Wellington, who is also a liberal subscriber and loan-contributor. It was first proposed by Mr. Wallis that the exhibition should be held in the upper room of the French Gallery, but the contributions and loans were so numerous, that greater space was required; and three rooms were therefore very courteously conceded by the Society of British Artists; yet even these have been found insufficient, as it is said there are works which cannot be hung.

A project similar to this had occurred to Baron Gudin, the eminent French marine-painter, who has been long settled in this country; but on the announcement of the present exhibition, he gave his whole weight and influence towards its promotion.

The loan portion of the exhibition contains works ranking among the most valuable and interesting the art has ever produced; and the contributions from English and foreign painters are on the most liberal scale. To these contributors we feel that but scant justice has been publicly done; we therefore solicit especial attention to that part of the collection. All must deplore the fearful cause which draws from their abiding places such efforts of genius; but we may rejoice at the opportunity of seeing some of these works for the first time, and of renewing acquaintance with others.

The pictures sent by the Queen are—'The Marriage of the Prince of Wales,' by W. P. Frith, R.A.; Wilkie's 'Blind Man's Buff;' and that very richly-coloured humble-life subject by Mulready, called here 'A Cottage Interior,' but which was, when exhibited, called 'Evening.' Of those belonging to the Duke of Wellington there are no less than six by Velasquez, one of which is the famous Agador, entitled here 'The Water-carrier,' which has not been seen by the public for many years. These and other grand works by the same hand bear yet, like the Spanish Titians, the virgin bloom upon them. The likeness of the great painter which accompanies them has the same defiant bearing which characterises the magnificent portrait among those of the painter at Florence, though the latter has in it yet more of the soldier than the painter. A striking contrast to this is presented by the portrait of Murillo, also the property of the Duke of Wellington. There are other Murillos, and a Rubens—a small 'Holy Family,' pure and bright, that would do admirably for association with the small Correggio and the Garvagh Raffaele in the National Gallery. The Marquis of Lansdowne lends his Rembrandt—'Portrait of a Lady in a Ruff'—one of those women by whose superior vulgarity we are so fascinated as to ask, as it was frequently asked of Guido, where he went for his models; for there are no such elderly ladies now-a-days. From the same collection are Reynolds's portrait of Miss Ridge, which was celebrated by Goldsmith in his poem, 'The Retaliation;' the Countess of Berkeley, also by Reynolds; and, above all, 'The Musical Party,' by Giorgione, for which he made several loose sketches that still exist.

Miss Burdett Coutts's small but famous and very valuable, Raffaele 'Christ on the Mount of Olives,' is also here: it was painted, in 1504, as an altar-piece for the nunnery of S. Antonio, in Perugia, and is known as having been in the Orleans and Rogers collections, and latterly in the Royal Palace at Naples. With this may be mentioned the Duke of Wellington's picture by Correggio, 'Christ's Agony in the Garden,' which formerly belonged to Visconti, and subsequently to Philip IV. of Spain. It is recorded by Scanelli that Correggio painted this picture in acquittance of a debt of four or five scudi, equal to about 20s., which he owed an apothecary; and that it was soon after sold for 500 scudi. It has been three times engraved; a copy of it is in the National Gallery: the Duke of Wellington's picture was presented to his father by Ferdinand VII. Lady Eastlake has sent Etty's very brilliant copy of the Giorgione in the Louvre, 'The Concert Champêtre,' and a 'Virgin and Child,' by Borgognone; the Earl of Chesterfield, Vandyck's portraits of the Countesses of Chesterfield and Carlisle; the Duke of Devonshire, 'A Landscape,' by Pousin. Baron Gudín contributes 'The Cock-fight,' Jan Steen; Mr. Cholmondeley, Turner's 'Battle of the Nile; Sir Coutts Lindsay, a portrait by Morone; Mr. G. R. Ward, 'A Spaniel,' by J. Ward, R.A.; and there are other interesting works lent by Mr. Bidwell, Mr. Dobree, &c.

Artists, both foreign and English, have nobly seconded the good work, although the appeal is not made to them especially. The honour of the movement is due to artists and their friends; but it must not on this account be regarded as a class-project, but open to contributions from all.

The Baron Gudín presents 'Saved' (50 gs.); 'Life-Boat in a Storm' (20 gs.); and 'Shipwreck of H.M.S. Captain' (20 gs.); and he exhibits, moreover, on loan, 'Lost,' a picture of great power and absorbing interest, executed by him in 1837, as a tribute to the memory of a beloved brother who was drowned. This fine work was painted for the San Donato Gallery, on the recent dispersion of which it was purchased by M. Gudín. M. Yvon contributes a drawing entitled '1870' (100 gs.), embodying in one very masterly allegory the dire calamities of Paris and of France. M. Gérôme sends a work in every way worthy of his brilliant reputation—it is without title (150 gs.); M. C. Daubigny, 'Pont de l'Arche' (80 gs.); M. Schreyer, 'An Arab Hunting' (140 gs.); M. Tadema, 'Roman Ladies ascending a staircase' (100 gs.); with other contributions of considerable value from foreign artists. And also very liberally have English painters and amateurs responded to the call, as we find upwards of 230 names of donors of works of greater or less value. Among these are Mr. G. F. Watts, R.A., 'The Prodigal Son' (80 gs.); Mr. T. S. Cooper, R.A., 'Sheep' (25 gs.); H. Weigall, 'Tristesse' (30 gs.); Mr. E. M. Ward, R.A., 'The Dangerous Message' (40 gs.); and Mrs. E. M. Ward, 'Little Beatrice in the Arbour' (20 gs.); P. H. Calderon, R.A., 'Tristesse' (30 gs.); F. Leighton, R.A., 'A Study' (80 gs.); Frank Dillon, 'The Tombs of the Sheikhs' (80 gs.); G. F. Teniswood, 'On the Thames—Stormy Evening,' &c.

It is hoped that the exhibition will realise £5,000. Much of its success will be due to the aid it has received from Mr. Wallis, who has presented an admirable drawing by Bright (100 gs.), and a second by Weber (150 gs.).

And one or two words at parting with this precious collection. It contains works of the rarest excellence, some of which have not been publicly seen for very many years, and an equally long term may elapse before they may again be accessible to the public. Those who have been able justly to estimate the announcement of this exhibition and have accordingly visited it, and aided its purpose by subscription, have received, to speak commercially, value for their money. They have, in fact, made an investment which will supply happy memories for a life-time, for such works must ever be remembered with genial satisfaction; although these days are too dark, and sad, and cheerless, for rejoicing even in pictures.

COLONEL STUART WORTLEY'S PHOTOGRAPHIC WORKS.

COLONEL STUART WORTLEY has opened an exhibition of all his Art-photographs at the rooms of the Architectural Union Company, 9, Conduit Street, Regent Street, in order to assist in the work of relieving the terrible suffering now existing, and likely even more distressingly to prevail, in France. If this exhibition yields a return sufficiently large, a special fund will be appointed for the relief of some particular district, or to give assistance to Paris after it is open; but if the sum falls short of what would be required for such purpose, it will be paid over to one of the War Victims' Funds already in operation.

Some of these works have already received a passing notice at our hands, but the collection here numbers a hundred and twenty-seven examples, the properties of many of which entitle them to distinct examination. Accepting them under certain technical allowances well understood, as veritable phases of nature, the student of Art will rise much profited by an earnest study of them. The tyranny of rule in painting has been the bane of Art, and men continually pass their lives without ever discovering the vapidness of their own monotony.

Colonel Wortley's works consist of a variety of portrait, or head, subjects, day and night seaweeds, copies of certain of Turner's pictures, copies of drawings of the old masters, &c., &c. With all professed devotion to nature, few artists would dare to paint these scenes as they are: they outrage all the laws of expediency, and their inevitable photographic infirmities are intractable by those who do not understand the shortcomings of the Art. The solemn grandeur of some of the "Sea-side Studies," affects us with a conviction that the scene has expanded from the limit of a sheet of paper to a vast reality, and that we are alone in the presence of the capricious moon and the dew-distilling stars: such are 'A Study of Clouds,' 'A Sail by Moonlight,' another labelled, 'All the air was white with moonlight, and the water black with shadow.' 'What are the wild waves saying?' is a picture in itself, complying with all the requisitions of scholarly Art. The vignette 'Towards Sunset' is, in the beauty of its light and breadth, the most perfect photograph of its kind we have ever seen; and differing from it in feeling, though not less charming, is the vignette, 'Naples from Capodimonte,' &c.: but we must go to Turner. We remember, when Willmore was engraving the 'Fighting Téméraire,' the great painter was beside himself because the engraver had dared to correct the drawing of the paddle-wheel of the tug-steamer: what would he now say to see the deepening of some of his warmer pictures under photography? There are twelve of these copies, conspicuous among which are 'The Decline of Carthage,' 'Spithead,' 'Dido and Æneas,' 'Van Tromp,' and 'Apuleia in search of Apuleius.' The last has in everything the feeling of Claude, which in this copy is more apparent than in the picture. Those which to us seem to come out most harmoniously as repetitions of the pictures are the greyer works, 'Spithead' and 'Van Tromp,' and these subjects in the photographs gather more force than in the pictures; indeed, where a picture by Turner is so balanced as to admit of a favourable reproduction, he is represented more truthfully in photography than in engraving.

To nearly all Col. Stuart Wortley's head and bust studies, the highest compliment that can be paid is to say that they are endowed with so much of pictorial quality that they would paint well without any modification. The most striking are 'My Queen,' 'Childhood,' 'Santa Agata,' 'Pensive,' 'On Gnard,' and a few others. Whereas in photographic likenesses the great desideratum has ever been extreme definition, these approach nearest to the best examples of Fine Art by a softness of *contour* which might be deemed due to accident or the insufficiency of the apparatus; while here it is a result of the skill and judgment of the operator.

Colonel Stuart Wortley's "Sea-side Studies," as examples of apparently pure photography, are among the most beautiful productions of their kind, especially in their skies.

DEPARTMENT OF SCIENCE AND ART.

DELLA ROBBIA WARE.

THE specimen of Della Robbia ware to which we referred in our last number has now been temporarily fixed in the north corridor of the Museum. It is a work of extraordinary merit, and great beauty. The expression of the faces of Adam, Eve, and the human-headed serpent, is that of life itself. It is true that this expression is heightened by an artifice which the sculptor must condemn; still, enamelled earthenware is not exactly sculpture. It is governed by rules of its own, and Luca and Andrea della Robbia rank as legislators. We admire the effect produced by the bold, though conventionalised, forms and colours of leaves, flowers, and fruit; and we can hardly quarrel with the dark brown hair of the first "gardener," the paler tawny of his wife, or, more effective than either, the darkened irides and pierced pupils of their eyes. The persuasive, coaxing smile on the lips of the tempter is a wonderful study. So is the pondering look of Eve—who is holding forth to her husband, not an apple, but a fig—moreover, of that large size, purple hue, and luscious abundance of juice, that is known to Italians by the name of *archivescovo*—a kind of parallel to our bishop's-thumb. The figures themselves are of the purest white enamel, without attempt at colour of any kind, except the tangle of foliage that always manages to creep around the waist. The serpent is green, and divers of the humbler denizens of Paradise disport themselves in approaches to their natural colour. The whole composition is one of merit approaching the marvellous. No parallel to it exists, to our knowledge and belief, in this country; and its production alone would entitle its author to a very high rank in the golden rôle of Art.

RUNIC DOOR.

A reproduction of a Runic door, from the cathedral church of Varthœstadt, in Iceland, claims attention from the curious archaic character of the low relief it bears. A warrior is riding to the encounter, in one instance of an enormous lion, in another of a mighty dragon. The latter is familiar enough as mere mythology, but how the Icelandic artist should have become acquainted with the maned lion of Africa is less obvious. Perhaps the most remarkable feature of the work is the strong resemblance borne to Assyrian workmanship. The Thor, or Helder, of the Norse carver might pass, with little difficulty, for Sennacherib or Nebuchadnezzar.

RAMBLA (SPANISH) POTTERY.

The rare and beautiful specimens of Spanish Buen Retiro ware to which we have before called the attention of our readers are now accompanied and illustrated (in their glass-case in the Ceramic Gallery) by more numerous examples of a pale, apparently half-baked *terracotta* distinguished as Rambla ware. The colour is something between a pale buff and a light green, and the effect of the articles is that of being made of sun-dried clay. Still there is evidently a strong family relationship to the Buen Retiro pottery, when unpainted. There is one vase, from Majorca, of the same class of earthenware, covered with *appliqué* birds and flowers, of the same biscuit as the object itself, which are curiously, and almost grotesquely, bold. The capabilities of *terracotta* to receive any degree of elaborate ornamentation are well illustrated by this interesting group of objects.

TUDOR STONE-CARVING.

Three quaint carvings, in oolite stone of the Bath or Portland beds, call for attention in the Loan Court. They are ascribed to the reign of Henry VII. Their character is not unlike the carvings around the chapel of the Confessor in Westminster Abbey, although the figures are not quite so quaint. One represents a monk, with rosary, crucifix, and missal. One is a nun, also furnished with a rosary, who bears a large

book, of quarto form, open. Probably she is intended for a chorister. The third is a woman, with a basket on her arm, a dog by her side, an object like a man's hat of the present fashion in her hand, and, on her head and back, what seems to be a prophetic foreshadowing of the present fashion of female head-dress, so loftily does it tower, and so fully does it flow down the back. On further examination, however, it turns out to be a sheaf of corn, borne on the head and shoulders—and the good housewife is probably a gleaner. In each of these three altar-figures great life is given by the rinde expedient of boring a distinctly visible hole in the centre of the eye. Some valuable specimens of very old china; an inlaid Japanese cup, of iron and gold; an Indian vase, sculptured in relief; and one or two very effective bronzes, are to be seen in the same case.

SCHOOLS OF ART.

CIRENCESTER.—At the annual meeting in December for the distribution of prizes, the pupils were addressed by Mr. S. C. Hall, who urged upon them the necessity of close and earnest work as the only means whereby they could reach excellence in any pursuit, and raise themselves to a position honourable to those who gain it, and beneficial to others.

MANCHESTER.—The annual meeting for the distribution of prizes, and to receive the report of this school, has taken place lately; Mr. R. N. Phillips, M.P., presiding on the occasion. The report of Mr. W. T. Mückley, head-master, stated that the works of the pupils had exhibited greater power and ability during the past year, and there was every reason to suppose that the standard of excellence would be raised still higher. The number of pupils attending the classes had been much about the same as in the previous year. At the present time the teachers connected with the institution were giving instruction in twelve schools in the district, and had about 800 pupils under them. The chairman said the documents showed that the institution was becoming more and more self-supporting. He congratulated them on that being the state of things, and he believed that that was a basis for the future prosperity of the school. The report of the committee, as regards the financial condition of the institution, is much less satisfactory. It expresses the regret of the committee that they have to make their appearance again under the same depressing influences as they had experienced for some years past, and with the same general complaint of the want of sympathy and support with regard to the promotion of pure Art in this commercial community. The annual subscriptions had decreased from £458 in 1864, to £260 in 1869-70; but, on the other hand, the fees from the students had never exceeded £700, the present amount. It had been proved that external support had been continually diminishing, and but for the increase of fees, the school would have been more in debt than it was at present. This wail on account of straitened means has long been heard from Manchester, and we had hoped it would by this time have ceased in a locality where wealth and the possession of valuable collections of pictures go hand in hand. One speaker at the meeting, Professor Williamson, alluded, in very pointed terms, to those who gathered noble works of Art around them, but gave no aid to the Art-school in their midst.

SOUTH KENSINGTON.—Sir Francis Grant, P.R.A., took the chair and distributed the prizes to the students of this school on the 16th of December. The report of Mr. Burchett, head-master, read by him at the meeting, stated that, "Since the last distribution of prizes eight students had been recommended for admission into the schools of the Royal Academy; which, including the number of those so recommended in previous years, reached a total of twenty-two. Besides the regular prizes and distinctions, occasional prizes had been offered by the Department and by manufacturers during the year, some for general competition, and some only for this school. By the Department £22 was offered, in eleven prizes, for fans, the competition being limited to female students.

Eleven students of this school competed, sending in fifteen designs, and Misses Montalba and Brooks obtained the first and third prizes, to the value of £7. The Worshipful Company of Plasterers offered prizes of £25 for designs for a "capital of a pilaster" and a "diaper for wall-decoration," limiting, however, this school to one subject. Two students, Messrs. Galli and Marshall, obtained the prizes, of £8 8s. and £5 5s. respectively. A prize of £5 was offered by Mr. M'Crum, of Milford, Armagh, Ireland, for designs for table-damask. For this there were twenty-six competitors and thirty-four designs. The prize was divided between Messrs. Marshall, Wilson, and Nunn. Prizes of £2 2s. and £1 1s. were offered for the decoration of a tramway car. Thirteen designs were made, and the prizes were obtained by Messrs. Claussen and Harris. A steady and progressive success continued to mark the career of the school in which these honours and rewards had been won. In the half-year ending February 29, 1864, the number of students was 382; the amount of fees, £878 11s. For the year ending July 30, 1870, the total number of individual students has been 994, and the amount of fees for the same time £2,623 14s. Among this number of students, 565 were males and 429 females. The principal prizes awarded were three gold medals to Messrs. A. F. Brophy, G. Claussen, and T. M. Rook; but arrangements were made by which these gentlemen received, in lieu of the medal, electrotype copies of the famous "Milton" shield, by Messrs. Elkington, exhibited at the last Paris International Exhibition, and purchased by our Government. The other chief prizes consisted of six silver medals, four of which were won by ladies, Miss Kate Kerr, Miss M. Mansell, Miss E. Montalba, and Miss F. L. Sothern; ten bronze medals, and twelve Queen's prizes of books, all won in the national competition. Sir Francis Grant addressed the meeting in suitable terms, remarking that most important results must be achieved by the establishment of Schools of Art throughout the country, which were educating, as it were, a whole nation, and supplying broadcast a knowledge of the first principles of Art.

ART IN CONTINENTAL STATES.

THE effect of the war on the Art-literature of the Continent has been hitherto chiefly, although not entirely, confined within the geographical limits desolated by the mighty struggle. The serials of Paris are now conspicuous by their non-appearance. Prussia has little time for any Art save the art of war; but the smaller German capitals continue the issue of their Art-periodicals, each marked by a distinctive type of excellence or at least of effort after excellence.

Italy should not suffer paralysis from the condition of France. Nor should the presses of Florence or of Naples cease to work pending the transfer of the capital to Rome. But it is now so long since we have received a number of our excellent contemporary, *L'Arte in Italia*, that we almost fear it may be numbered among the Arts that are extinct. And no new *livraison* of the superb work of the brothers Nicolini on Pompeii has made its appearance on our horizon for an equal time. We trust that these worthy products of the taste and industry of Italy, now one, have not been sent *viâ* France by the book-post, and confiscated by Uhlans, or riddled by Franc-tireurs, on their passage.

BERLIN.—From Berlin we have a serial, *Für ornamentale Kunst*, containing bold lithographs of examples for Industrial Art, especially in iron-work, which are well worth the attention of the English hammerman. The *Architectonisches Skizzenbuch* is another instance of a bold, effective, but somewhat coarse mode of treatment, which seems indigenous to the climate of Prussia. Another serial publication of ornamental details for the architect and decorator comes from Leipzig. The engravings of an Art-serial published at Darmstadt, while by no means deficient in force, have a delicacy that we do not find in German draughtsmanship in

general. Eugene Klemsch, of Frankfort, to whose "Kindergruppen," or groups of children, we recently directed attention, is now publishing a series of—we cannot call them copy-books, but books of ornamental and illustrated letters, of exquisite taste, for which those who practise illumination or artistic writing and painting should make inquiry. Among these Teutonic works we have to mention one from a yet more northerly birthplace, "Ribe Dome Kirche," an illustrated description of a cathedral in Jutland, in Danish and French, published at Copenhagen.—The unveiling of the Schiller monument, which was to have taken place in December, is postponed till the spring, in consequence of the war, and the absence from Berlin of so many distinguished Prussians.

FLORENCE.—Signor Frullini, an eminent Italian sculptor in wood, has recently completed two splendid wardrobes for the Marquis of Westminster: they are decorated with exquisite groups of foliage, fruit, flowers, and birds, laid on a ground of gold: the result is, as may be conceived, an effect of great richness. The sculpture is remarkable for elegance of design and high finish in all the details.

MONTREAL.—The annual meeting of the Art-association of Montreal was held in December, when the secretary presented the report of the council. They had offered a prize of \$200 (£40 sterling) for competition, and it was decided that it should be divided between a painting by O. R. Jacobi, 'The Thousand Islands,' and 'Holysocks,' by D. Fowler. The *conversazione* in March last was honoured by the presence of H.R.H. the Prince Arthur and suite, besides many patrons of Art, and the merit of this exhibition was deemed greater than any previous one. Subsequent to the *conversazione* the gallery remained for eight days open to the public, during which time it had a large number of visitors. For the improvements in artistic taste now manifest in the city, the council feel sure that to the Art-association the public is largely indebted.—A series of five very beautiful photographic pictures of scenes near Ottawa city have been issued by Mr. Notman. Four of them depict the "world of waters" at the Chaudière; and the fifth is a very fine and striking representation of the parliamentary buildings from the tower front. We may also state that Messrs. Notman and Fraser, of Toronto, are engaged on a historical picture of the first Ontario Legislature in session, introducing portraits of all the members.—Theophile Hamel, one of the best known and cleverest of our Canadian artists, died at Quebec on December 23rd. Mr. Hamel studied for his profession in Italy, and was in extensive practice as a portrait-painter.—A large and influential meeting was recently held in Montreal, to witness the opening of the Institution for the Fine Arts as applied to Industry.

ROME.—Photographic details of the sculpture on the Trajan Column have been published by Gustave Arosa. The presentation to the untravelled student of this ancient record in bas-relief demands our gratitude; not only so, but the traveller finds the greatest advantage in comparing the inaccessible groups of which his eye can only grasp the *ensemble* with a faithful copy in his hand. The work is essentially Roman—vigorous, clumsy, ungraceful, deficient in every attempt at perspective, and stamped as if for eternity.—According to a Florentine paper, quoted by the *Architect*, "The Coliseum is as bare as your hand; not a shrub, not a blade of grass, not a lichen on those noble stones. There is an end of the 'Flowers of the Coliseum,' which will exist only in the work of the English amateur, who maliciously gave that title to his botanical work in order to secure a great sale," &c. The Coliseum thus denuded is wonderful; the architectural lines tell much better against the blue sky. All the rubbish has been removed from the arcades, and all the stones lying about, and the arcades themselves are to be enclosed with wooden palisades. In the centre, round the arena, nothing remains but the fourteen stations (altars used on certain Church festivals) and the preaching tribunes. These will, of course, ere long disappear, for what is the use of mixing the sacred and the profane?

THE MERCHANTS OF THE MIDDLE AGES.

BY THE REV. E. L. CUTTS, B.A.

PART III.

THOUGH the commerce of England has now attained to such vast dimensions, and forms so much larger a proportion of the national wealth and greatness than at any former period, yet we are inclined to think that, in the times of which we write, the pursuit of commerce held a higher and more honourable place in the esteem of all classes than it does with us.

It is true that one class was then more distinctively separated from another, by costume and some external habits of life: the knight and the franklin, the monk and the priest, the trader and the peasant, always carried the badges of their position upon them; and we, with our modern notions, are apt to think that the man who was marked out by his very costume as a trader must have been "looked down upon" by what we call the higher classes of society. No doubt something of this feeling existed; but not, we think, to the same extent as now. Trade itself was not then so meanly considered. Throughout the Middle Ages the upper classes were themselves engaged in trade in various ways. In the disposal of the produce of his estates, the manorial lord engaged in trade; and purchased at fairs and markets the stores he needed for himself and his numerous dependants. Noblemen and bishops, abbots and convents, nay kings themselves, in the fourteenth and fifteenth centuries, had ships which, commanded and manned by their servants, traded for their profit with foreign countries. In the thirteenth century the Cistercian monks had become the greatest wool-merchants in the kingdom. In the fifteenth century Edward IV. carried on a considerable commerce for his own profit. Just as now, when noblemen and gentlemen commonly engage in agriculture, and thus farming comes to be considered less vulgar than trade, so when dignified ecclesiastics, noblemen, and kings engaged in trade, it must have helped to soften caste prejudices against the professional pursuit of commerce.

A considerable number of the traders of the fourteenth and fifteenth centuries were cadets of good families. Where there were half a dozen sons in a knightly family, the eldest succeeded to the family estate and honours: of the rest, one might become a lawyer; another might have a religious vocation, and, as a secular priest, take the family living, or obtain a stall in the choir of the neighbouring monastery; a third might prefer the profession of arms, and enter into the service of some great lord or of the king, or find employment for his sword and lance, and pay for himself and the dozen men who formed the "following of his lance," in the wars which seldom ceased in one part of Europe or another; another son might engage in trade, either in a neighbouring town or in one of the great commercial cities of the time, as Bristol, Norwich, or London.

The leading men of the trading class stood side by side with the leading men of the other classes. They were consulted by the king on the affairs of the kingdom, were employed with bishops and nobles on foreign embassies, were themselves ennobled. And the greatness which men attain in any class reflects honour on the whole class. The Archbishop of Can-

terbury's high position gives social consideration to the poor curate who may one day also be archbishop, and the Lord Chancellor's to the now briefless barrister who may attain to the woollack. The great free towns of the German Empire reflected honour on every town of Europe, and the merchant princes of Venice and Florence and the Low Countries on the humblest member of their calling.

But what, perhaps, more than anything else tended to maintain the social consideration of traders, was their incorporation into wealthy and powerful guilds, and the civil freedom and political weight of the towns. The rather common-looking man, in a plain cloth gown and flat cap, jogging along the high road on a hack, with great saddle-bags, is not to be compared in appearance with the knight who prances past him on a spirited charger, with a couple of armed servants at his heels; and the trader pulls his horse to the side of the road, and touches his bonnet as the cavalcade passes him in a cloud of dust; but the knight glances at his fellow-traveller's hood as he passes, and recognises in him a representative of the great Guild of Merchants of the Staple, and returns his courtesy. The nobleman jostling at court against a portly citizen in a furred gown, with a short dagger and inkhorn at his belt, sees in him an alderman of one of those great towns by whose help the king maintains the balance of power against the feudal aristocracy. Yet, after all, why should the merchant be "a rather common-looking man," and the alderman a "portly citizen?" We are all apt to let our sober sense be fooled by our imagination. Thus we are apt to have in our minds abstract types of classes of men: our ideal knight is gallant in bearing, gay in apparel, chivalrous in character; while our ideal merchant is prosaic and closefisted in character, plain and uncourtly in manner and speech. A moment's thought would be enough to remind us that nature does not anticipate or adapt herself to class distinctions: the knight and the merchant, we have seen, might be brothers, reared up in the same old manor-house; and the elder son might be naturally a clown though fortune made him Sir Hugh; while the cadet might be full of intelligence and spirit, dignified and courteous, though fortune had put a flat cap instead of a helmet on his head, and a pen instead of a lance into his hand.

Our plan limits us to mere glances at the picturesque outside aspect of things. Let us travel across England, and see what we can learn on our subject from the experiences of our journey. A right pleasant journey, too, in the genial spring-time or early summer. It must be taken on horseback; for, though sometimes we shall find ourselves on a highway between one great town and another, yet, for the most part, our road will be along bridle-paths, across heath and moor, through miles of "greenwood;" across fords, over wide unenclosed wolds and downs, dotted with sheep; through valleys where oxen feed in the deep meadow-land; with comparatively little arable, covered with the green blades of rye and barley, oats, and a little wheat—

"Long fields of barley and of rye,
That clothe the wold and meet the sky."

Now and then we ride through a village of cottages scattered about the village-green; and see, perhaps, the parish-priest, in cassock and biretta, coming out of the village-church from his mass. Further on we pass the moated manor-house of a country knight, or the substantial old timber-built house of a franklin, with the blue wood-smoke puffing in a volume out of the louvre of the

hall, and curling away among the great oak-trees which overshadow it. We may stay there and ask for luncheon, and be sure of a hearty welcome: Chaucer tells us,

"His table dormant in the hall alway
Stands ready covered, all the longe day."

Then a strong castle comes in sight on a rising ground, with its picturesque group of walls and towers, and the donjon-tower rising high in the midst, surmounted by the banner of its lord. We seek out the monasteries for their hospitable shelter at nights: they are the inns of mediæval England; and we gaze in admiration as we approach them and enter their courts. From outside we see a great enclosure-wall, over which rise the clerestories and towers of a noble minster-church; and when we have entered through the gate-house we find the cloister court, with its convent buildings for the monks, and another court of offices, and the guest-house for the entertainment of travellers, and the abbot's-house—a separate establishment, with a great hall and chambers and chapel, like the manor-house of a noble; so that, surrounded by its wall, with entrance-towers, it looks like a great castle or a little town; and we doff our hats to the dignified-looking monk who is ambling out of the great gate on his mule, as to the representative of the noble community which has erected so grand a house, and maintains there its hospitalities and charities, schools and hospitals; and offers up, seven times a day in the choir, a glorious service of praise to Almighty God, and of prayer for the welfare of His church and people. But from time to time, also, we approach and ride through the towns, which are studded as thickly over the land as castles or monasteries. Each surrounded by a fair margin of common meadow-land, out of which rises the long line of strong walls with angle towers, with picturesque machicolations, and overhanging pent-houses, and the great gate-towers with moat, drawbridge, and barbican. Over the wall numerous church-towers and spires are seen rising from a forest of gables, making a goodly show. Enter, and there are wide streets with handsome picturesque houses, with abundance of garden and orchard ground behind them, guildhalls and chapels, the head-quarters of the various companies. The traders are wealthy, and indulge in conveniences which are rare in the franklin's house, and even the lord's castle; and live a more refined mode of life than the old rude, if magnificent, feudal life. Look at the extent of the town, at its strong defences; estimate the wealth it contains; think of the clannish spirit of its guilds; see the sturdy burghers, who turn out at the sound of the town-bell, in half armour, with pike and bow, to man the walls; consider the chiefs of the community, men of better education, wider experience of the world, deeper knowledge of political affairs, than most of their countrymen, many of them of the "gentleman" class by birth and breeding, men of perfect self-respect, and of high public spirit.

If our journey terminates at one of the seaports, as Hull, or Lynn, or Dover, or Hythe, or Bristol, we find—in addition to the usual well-walled town, with houses and noble churches and guildhalls—a harbour full of merchant-ships, and exchanges full of foreign merchants; and we soon learn that these are the links which join England to the rest of the world in a period of peace, and enable her in time of war to make her power felt beyond the seas. Many of these towns have inherited their walls and their civic freedom from Roman times: they stood like islands amid the flood of the

Saxon invasion; they received their charters from Norman kings, and maintained them against Norman barons. Each of them is a little republic amidst the surrounding feudalism; each citizen is a freeman, when everybody else is the sworn liege-man of some feudal lord.

The experiences of our ride across England will leave their strong impressions on our minds. The castles will have impressed our minds with a sense of the feudal power and chivalric state of the territorial class; and the monasteries, with admiration of the grandeur and learning and munificence and sanctity of the religious orders; and the towns, with a feeling of solid respect for the wealth and power and freedom and civilisation of the trader class of the people.

Our first illustration forms part of a large picture in the great Harleian MS. of Froissart's Chronicle, and represents Isabel of Bavaria, Queen of Charles VII., making her entry into Paris attended by noble dames and lords of France, on Sunday, 20th of August, in the year of our Lord 1389. There was a great crowd of spectators, Froissart tells us, and the *bourgeois* of Paris,

twelve hundred, all on horseback, were ranged in pairs on each side of the road, and clothed in a livery of gowns of bawdekyn green and red. The queen, seated in her canopied litter, occupies the middle of the picture, in robe and mantle of blue powdered with *fleurs-de-lis*, three noblemen walking on each side in their robes and coronets. The page and ladies, who follow on horseback, are not given in our wood-cut. The Queen has just arrived at the gate of the city; through the open door may be seen a Bishop (? the Archbishop of Paris) in a cope of blue powdered with gold *fleurs-de-lis*, holding a gold and jewelled box, which perhaps contains the chrisam for her coronation. On the wall overlooking the entrance is the king with ladies of the court, and perched on the angle of the wall is the court jester in his cap and bauble. On the left of the picture are the *bourgeses* of Paris, their short gowns are of green and red as described; the hats, which hang over their shoulders, are black. On the opposite side of the road (not represented in the cut) is another party of *bourgeses*, who wear their hats, the bands

tington, in Gloucestershire. What is the explanation of the story of his cat has not been satisfactorily made out by antiquaries. Munificence was one of the characteristics of these great merchants. De la Pole, we have seen, built the church at Hull; Cannynge founded one of the grandest parish churches yet remaining in all England; Whittington founded the College of the Holy Spirit and St. Mary, a charitable foundation which has long ceased to exist. Sir John Crosby was an alderman of London in the reign of Edward IV., and allied his family with the highest nobility. His house still remains in Bishopsgate, the only one left of the great city-merchants' houses: Stowe describes it as very large and beautiful, and the highest at that time in London. Richard III. took up his residence and received his adherents there, when preparing for his usurpation of the crown.

Monuments remaining to this day keep alive the memory of other great merchants, which would otherwise have perished. In the series of monumental brasses, several of the earliest and most sumptuous are memorials of merchants. There was an engraver of these monuments living in England in the middle of the fourteenth century, whose works in that style of Art have not been subsequently surpassed: Gough calls him the "Cellini of the fourteenth century." He executed a grand effigy for Thomas Delamere, abbot of St. Albans Abbey; and the same artist executed two designs no less sumptuous and meritorious as works of Art for two merchants of the then flourishing town of Lynn, in Norfolk. One is to Adam de Walsokne, "formerly burges of Lynn," who died in 1349 A.D., and Margaret, his wife: it contains very artistically-drawn effigies of the two persons commemorated, surmounted by an ornamental canopy on a diapered field. The other monumental brass represents Robert Braunché, A.D. 1364, and his two wives. A feature of peculiar interest in this design is a representation, running along the bottom, of an entertainment which Braunché, when mayor of Lynn, gave to King Edward III. There was still a third brass at Lynn, of similar character, of Robert Attelathe—now, alas! lost. Another monument, apparently by the same artist, exists at Newark, to the memory of Alan Fleming, a merchant, who died in 1361 A.D.

Hundreds of churches yet bear traces of the munificence of these mediæval traders. The noble churches which still exist in what are now comparatively small places, in Lincolnshire, Norfolk, and Suffolk, are monuments of the merchants of the staple who lived in those eastern counties; and monuments, and merchants' marks, and sometimes inscriptions cut in stone, or worked in flint-work, in the fabrics themselves, afford data from which the local antiquary may glean something of their history. Many interesting traces of mediæval traders' houses remain too in out-of-the-way places, where they seem quite overlooked. The little town of Coggeshall, for example, is full of interesting bits of domestic architecture—the traces of the houses of the "Peacocks" and other families, merchants of the staple and cloth-makers, who made a flourishing town of it in the fifteenth century: the monumental brasses of some of them remain in the fine Perpendicular church, which they probably rebuilt. Or, to go to the other side of the kingdom, at the little town of North-leach, among the Cotswold hills, is a grand church, with evidences in the sculpture and monuments that the wool-merchants there

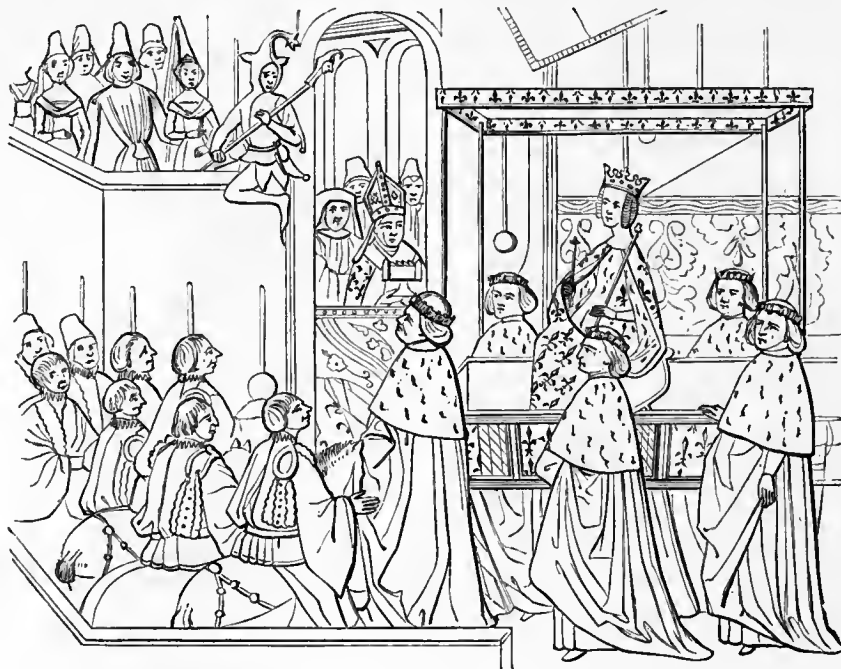

ENTRY OF QUEEN ISABEL OF BAVARIA INTO PARIS, 1389. HARL. MS. 4379, f. 3.

falling on each side of the face. In the background are the towers and spires of the city, and the west front of Notre-Dame, rising picturesquely above the city-wall.

Some of the merchant-princes of the Middle Ages have left a name which is still known in history, or popular in legend. First, there is the De la Pole family, whose name is connected with the history of Hull. Wyke-upon-Hull was a little town belonging to the convent of Selby, when Edward III. saw its capabilities and bought it of the monks, called it Kingstown-upon-Hull, and, by granting trading and civil privileges to it, induced merchants to settle there. De la Pole, a merchant of the neighbouring port of Ravenser, was one of the earliest of these immigrants; and Hull owes much of its greatness to his commercial genius and public spirit. Under his inspiration bricks were introduced from the Low Countries to build its walls and the great church: much of the latter yet remains. He rose to be esteemed the greatest merchant in England. Edward III. honoured him by visiting him at his

house in Hull, and in time made him Chief Baron of his Exchequer, and a Knight Banneret. In the following reign we find him engaged, together with the most distinguished men in the kingdom, in affairs of state and foreign embassies. His son, who also began life as a merchant at Hull, was made by Richard II. Earl of Suffolk and Lord Chancellor. In the end a royal alliance raised the merchant's children to the height of power; but designs of a still more daring ambition at length brought about their headlong fall and ruin.

William Cannynge, of Bristol, was another of these great merchants. On his monument in the magnificent church of St. Mary Redcliffe, of which he was the founder, it is recorded that on one occasion Edward IV. seized shipping of his to the amount of 2,470 tons, which included ships of 400, 500, and even 900 tons.

Richard Whittington, the hero of the popular legend, was a London merchant, thrice Lord Mayor. He was not, however, of the humble origin stated by the legend, but a cadet of the landed family of Whit-

contributed largely to its building. It contains an interesting series of small monumental brasses, which preserve their names and costumes, and those of their wives and children; and the merchants' marks which were painted on their woolpacks, appear here as honourable badges on their monuments. There are traces of their old houses in the town.

A general survey of all these historical facts and all these antiquarian remains will confirm the assertion with which we began this paper, that at least from the early part of the fourteenth century downwards, the mediæval traders earned great wealth and spent it munificently, possessed considerable political influence, and occupied an honourable social position beside the military and ecclesiastical orders.

We must not omit to notice the illustrations which our subject may derive from Chaucer's ever-famous gallery of characters. Here is the merchant of the Canterbury cavalcade of merry pilgrims:—

"A merchant was there with a forked beard,
In mottely, and high on horse he sat,
And on his head a Flaundrish bever hat,
His hote's claped fayre and fetisly,*
His reasons spake he full and tempriety,
Sounding alway the increase of his winning,
He would the sea were kept, for any thing,
Betwixen Middleburgh and Orewell.
Well could he in exchanges sheldist sell,
This worthy man full well his wit beset;
There westein wight that he was in deht,
So steadfastly didde he his governance
With his bargeones and with his chevisance,†
Forsooth he was a worthy man withal;
But, sooth to say, I n'ot‡ how men him call."‡

Of the trader class our great author gives us also some examples:—

"An haberdasher and a carpenter,
A webber, a dyer, and a tapiser,
Were all yelothed in one livery,
Of a solemne and great fraternity,
Full fresh and new their gear of piked was
Their knives were chassed, not with brass,
But all with silver wrought full dear and well,
Their girdles and their pouches every deal,
Well seemed each of them a fair hurgess
To sitten in a gild-hall on the dais.
Each one for the wisdom that he can,
Was likely for to be an alderman.
For chattles hadden they enough and rent,
And eke their wives would it well assent,
And ellis certainly they were to blame,
It is full fair to be yeloped madame,
And for to go to vigils all before,
And have a mantle royally uphore."

The accompanying figures from a monument to John Field, Alderman of London, and his son, are interesting and characteristic. Mr. Waller, from whose work on monumental brasses the wood-cut is taken, has been able to discover something of the history of Alderman Field. John Field, senior, was born about the beginning of the fifteenth century, but nothing is known of his early life. In 1449 he had clearly risen to commercial eminence in London, since he was in that year appointed one of fifteen commissioners to treat with those of the Duke of Burgundy concerning the commercial interests of the two countries in general, and specially to frame regulations for the traffic in wool and woolfells brought to the staple at Calais. Of these commissioners five were of London, three of Boston, three of Hull, and one of Ipswich. These names, says Mr. Waller, probably comprise the chief mercantile wealth and intelligence in the eastern ports of the kingdom at this period. In 1454 he was made sheriff, and subsequently was elected alderman, but never served the office of mayor; which, says the writer, may be accounted for by the fact that in the latter part of his life he was afflicted with bodily sickness, and on that ground in 1463

obtained a grant from the then lord-mayor, releasing him from all civic services. The alderman acquired large landed estates in Kent and Hertfordshire, in which he was succeeded by his eldest son John, the original of the second effigy, who only survived his father the short term of three years.

The brasses have been inlaid with colour: the alderman's gown of the father with red enamel, and the fur-lining indicated by white metal; the tabard of arms of the son is also coloured according to its proper heraldic blazoning: *gules*, between three eagles displayed *argent*, *guetté de sangue*, a fesse?



MONUMENTAL BRASS OF ALDERMAN FIELD AND HIS SON, A.D. 1474.

or. The unfinished inscription runs, "Here lyeth John Feld, sometye alderman of London, a merchant of the stapull of Caleys, the which deceased the xvj day of August, in the yere of our Lord God mcccclxxiiij. Also her' lyeth John his son,

sqire, y^e which deceased y^e iiij day of May y^e yere of" . . . The monumental slab is ornamented with four shields of arms: the first of the city of London, the second of the merchants of the staple, the third is the alderman's merchant's-mark,

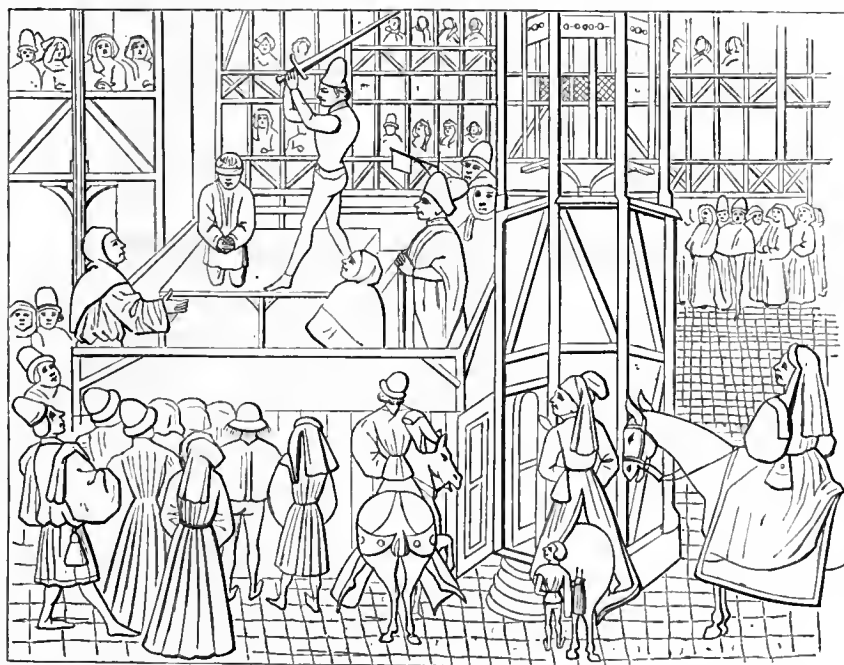

AN EXECUTION IN PARIS. HARLEIAN MS. 4379, f. 64.

and the fourth the arms which appear on the tabard of his son, the esquire, to whom, no doubt, they had been specially granted by the College of Arms. The father's costume is a long gown edged with fur, a

leather girdle from which hang his gypeire (or purse) and rosary, over which is worn his alderman's gown. The son wears a full suit of armour of the time of Edward IV., with a tabard of his arms. The execution

* Neatly, properly.
† Shields, i.e. *écus*, French crowns.
‡ Agreement for borrowing money.
§ Know not his name.

of the brass is unusually careful and excellent.

The third woodcut represents the execution, in Paris, of a famous captain of robbers, Aymerigol Macel. The scaffold is enclosed by a hoarding; at the nearer corners are two friars, one in brown and one in black, probably a Franciscan and a Dominican: the official, who stands with his hands resting on his staff superintending the executioner, has a gown of red with sleeves lined with white fur, his bonnet is black turned up also with white fur. In the background are the timber houses on one side of the place, with the people looking out of their windows; a signboard will be seen standing forth from one of the houses. The groups of people in the distance and those in the foreground give the costumes of the ordinary dwellers in a fourteenth-century city. The man on the left has a pink short gown,

trimmed with white fur; his hat, the two ends of a *liripipe* hanging over his shoulders, and his purse and his hose, are black. The man on his right has a long blue gown and red hat and *liripipe*; the man between them and a little in front, a brown long gown and black hat. The man on horseback on the left wears a very short green gown, red hose, and black hat; the footman on his left, a short green gown and red hat and *liripipe*; and the man on his left, a black jacket and black hat fringed. The man on horseback, with a foot-boy behind holding on by the horse's tail, has a pink long gown, black hat and *liripipe*, purse, and girdle; the one on the right of the picture, a long blue gown with red hat, *liripipe*, and purse. Just behind him (unhappily not included in the woodcut) is a touch of humour on the part of the artist. This foot-boy is stealing an apple out of the basket of an apple-woman, who wears a

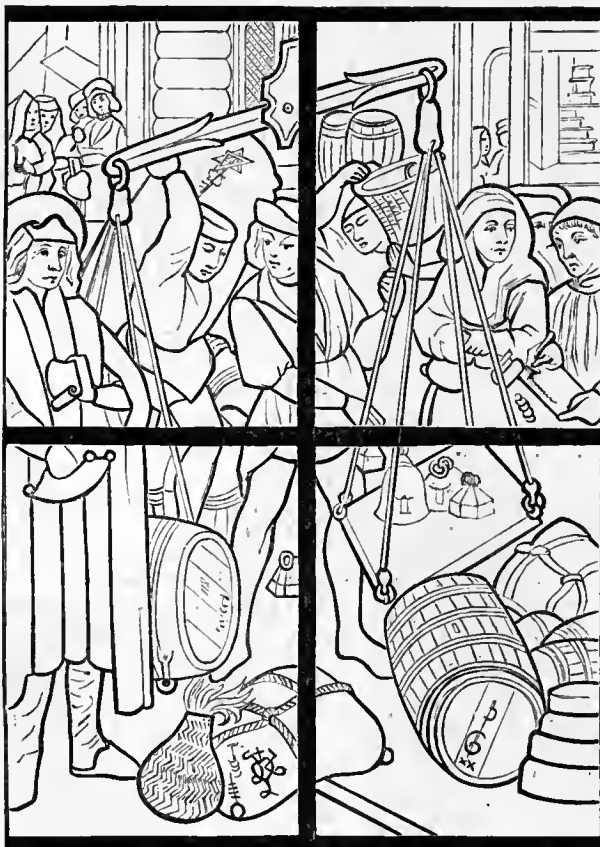

MARCHANDS EN GROS, FIFTEENTH CENTURY.

blue gown and red hood, with the *liripipe* tucked under her girdle; she has a basket of apples on each arm, and another on her head. Still further to the right is a horse whose rider has dismounted, and the foot-boy is sitting on the crupper behind the saddle holding the reins.

The last cut is taken from the painted glass at Tournay of the fifteenth century, and represents *marchands en gros*. This illustration of a warehouse with the merchant and his clerk, and the men and the casks and bales, and the great scales, in full tide of business, is curious and interesting.

Chaucer once more, in the "Shipman's Tale," gives us an illustration of our subject. Speaking of a merchant of St. Denys, he says:—

"Up into his countour house goth he
To reken with himselvin, wel may be,
Of thilke yere how that it with him stood,
And how that he dispended had his good,
And if that he encreased were or non,
His bookes and his bagges many one

He layth before him on his counting bord.
Full riche was his tresor and his hord;
For which ful fast his countour dore he shet,
And eke he w'olde no man shuld him let
Of his accountes for the mene time;
And thus he sat till it was passed prime."

The counting-board was a board marked with squares, on which counters were placed in such a way as to facilitate arithmetical operations.

We have also a picture of him setting out on a business journey attended by his apprentice:—

"But so bifell this marchant on a day
Shope him to maken redy his array
Toward the town of Brugges for to fare
To hyen ther a portion of ware.

The morrow came and forth his marchant rideth
To Flaundersward, his prentis wel him gideth,
Til he came into Brugges meryly;
Now goth this marchant fast and bisily
About his nede, and bieth and creanceth;
He neither playeth at the dis ne danceth,
But as a marchant shortly for to tell
He ledeth his lif, and ther I let him dwell."

SELECTED PICTURES.

FROM THE PICTURE IN THE COLLECTION
OF ROBERT CLARK, ESQ., EDINBURGH.

BORROWDALE.

S. Bough, R.S.A., Painter. W. Richardson, Engraver.

THE varied and beautiful scenery that abounds in and about the English lakes has long rendered the locality a favourite rendezvous of artists from both sides of the Border, and in this picture we have a charming example of the pencil of Mr. Samuel Bough, R.S.A., one of the best living landscape-painters of the Scottish school—a school that can in no way be deemed inferior to our own; in fine poetic feeling and in vigour of style it often, indeed, shows a decided superiority. Mr. Bough's works are in great request north of the Tweed; and we are sure they would be equally so on the south side if they were better known to us than they are—though it might probably take some little time for our collectors to see the merits of a general treatment and of a peculiarity of handling to which their eyes are not accustomed. It is remarkable how slow men are to appreciate the excellence of a kind of Art with which they are not familiar.

Perhaps among the Cumberland lakes none are more renowned for beauty than Derwentwater, a few miles from Keswick, and the locality which encircles it. The little village of Borrowdale is situated in a narrow valley of the same name, at the head of Derwentwater. The whole district is wild and mountainous, approaching to grandeur. The river Derwent has its source at Sparkling Tarn, at the head of the valley, runs between meadow-lands shut in on each side by lofty hills rising to the height of 400 and 500 feet, and expands into the magnificent Lake Derwentwater. The hills, or rather mountains, are richly covered with wood. The Dale itself contains the hamlet of Grange, picturesquely situated at the entrance, and those of Rosthwaite, Seathwaite, and Seatoller. It was once in possession of the monks of Furness. Near Grange is Castle Cragg, a conical hill commanding a fine prospect; its sides are wooded, and on its summit are the remains of an old entrenchment. Another object of interest is the Bowder, or Boulder, Stone, a detached mass of rock resting on a narrow base. The hamlet of Rosthwaite stands at the junction of three valleys. The whole district used to be famous for the lead which the best pencils were made: we speak in the past tense, for the lead which gave Brookman and Langdon such pre-eminence as pencil-makers in our younger days, when we occasionally handled the "tool," has long since been exhausted. We have, however, in our possession still a few pencils of their manufacture, which, if like some wines, they are improved by keeping, ought to be extra good; for we can vouch for their being more than a quarter of a century old.

Dr. Mackay, in his "Scenery and Poetry of the English Lakes," has a passage which may almost stand for a description of Mr. Bough's picture. He says, "The commanding mountains, or fells, of Borrowdale, among which Glaramara is conspicuous in the front, and the Scawfell Pikes in the far-distance, seem to forbid all further progress in one direction. The pass into Borrowdale is both narrow and straight, the whole width being occupied by the road and by the clear river Derwent, that runs its course through rocky and precipitous banks into the Lake Derwentwater."



S BOUGH R S A PINK

W RICHARDSON

PERROWDALE

FROM THE STUDY IN THE POSSESSION OF THE



THE MUSEUMS OF ENGLAND,
WITH
SPECIAL REFERENCE TO OBJECTS
OF ART AND ANTIQUITY.

BY LLEWELLYNN JEWITT, F.S.A., &c., &c.

THE SHAKSPERE MUSEUM; STRATFORD-ON-AVON.

A PILGRIMAGE to Stratford-on-Avon,—the birth-place of the “greatest bard the world e'er saw;” and the town in which he passed his early life; from whose neighbourhood he married his loving wife, the gentle Anne Hathaway; the place wherein his family was born, married, resided, and died; and in which he himself died and was buried—is one of the events of a life, and is looked forward to by all classes of people, and by foreigners and Englishmen alike. On this classic ground, where every street, every alley, and every building tells a tale of the life and times of the immortal bard—whose memory throws a halo of light around the place, and where the visitor

“Finds tongues in trees, books in the running brooks,
Sermons in stones, and good in everything,”
all speaking, telling, and teaching of him—it would indeed have been a disgrace to the age if a Museum had not been established, in which relics of the great bard, and objects connected with his life and times could be preserved “for all time.” The reproach that had so long attached to the town in not having provided a receptacle for such objects, has, 300 years after Shakspeare's birth, been removed by the energy of that prince of Shaksperian scholars, Mr. Halliwell, and his friends; and Stratford can now boast a collection already very valuable and curious, and which will ultimately, it is to be hoped, swell into an assemblage worthy of the universal admiration attaching to the works of Shakspeare.

In Stratford the principal objects, of course, are the house in which he was born, in Henley Street; the grammar-school in which he received his education; the Guild Chapel of the Holy Trinity; New Place, or rather its site, where the poet spent his latter days; and the church where his monument still exists. Of these, as a hint to visitors, it may be well to say just a few words.

The BIRTHPLACE, in which the Museum is located, is in Henley Street. It is an unpretending little lath-and-timber building of the sixteenth century, and has recently been judiciously restored, a vast portion of the original work and timbers being carefully preserved. The room tradition confidently points out as the one in which Shakspeare first saw light, is still in its original state, and has become almost sacred in the interest that is attached to it. And this small room has at one time or other held all the eminent in Literature and in Art, and the great and the noble, of this and the last century, who have wended their way to the place, and left their names by thousands upon its walls. In this house Shakspeare's father resided, and he became its purchaser, and deeds connected with it are to be seen in the Museum.

NEW PLACE, about half-way between the Birth-place and the church, was the residence of Shakspeare from 1597 until 1616, when he died in that house. It was pulled down about the year 1700, but its exact dimensions can be traced by the remaining foundations of the back of the house, more than one room being still visible. The grounds attached to the edifice have the same boundaries which surrounded them in the days when Shakspeare walked and sat in them; “so that here,” says

Mr. Halliwell, “we obtain a glimpse of the poet's existence, his social position in the town as owner of one of its largest mansions and the finest grounds being clearly ascertained.” The visitor will notice with interest the *mulberry tree* in the great garden, which is believed to have been raised from a scion of the original tree asserted by tradition to have been planted by the hand of Shakspeare himself. The tree itself was cut down in 1756, and its wood converted into a variety of ornamental articles; indeed hundreds more have been made and sold as parts of this veritable tree than it was possible even for the largest mulberry tree in existence to have produced! To some of these I shall again allude.

Those who desire to know all about “New Place” should consult Mr. Halliwell's folio

The GRAMMAR SCHOOL, where the poet was educated, and the GUILD CHAPEL, of the time of Henry VII., are in Church Street. The former is a long low building, the school-rooms being in the upper storey, and the lower being the former Hall of the Stratford Guild, where “the quene's pleyers,” “the Erle of Worcester's pleyers,” “the Erle of Leicester's pleyers,” “my Lord of Warwicke pleyers,” “the Countys of Essex pleyers,” “the Earle of Darbycs pleyers,” and others, performed before the corporation, and where, doubtless, Shakspeare imbibed his

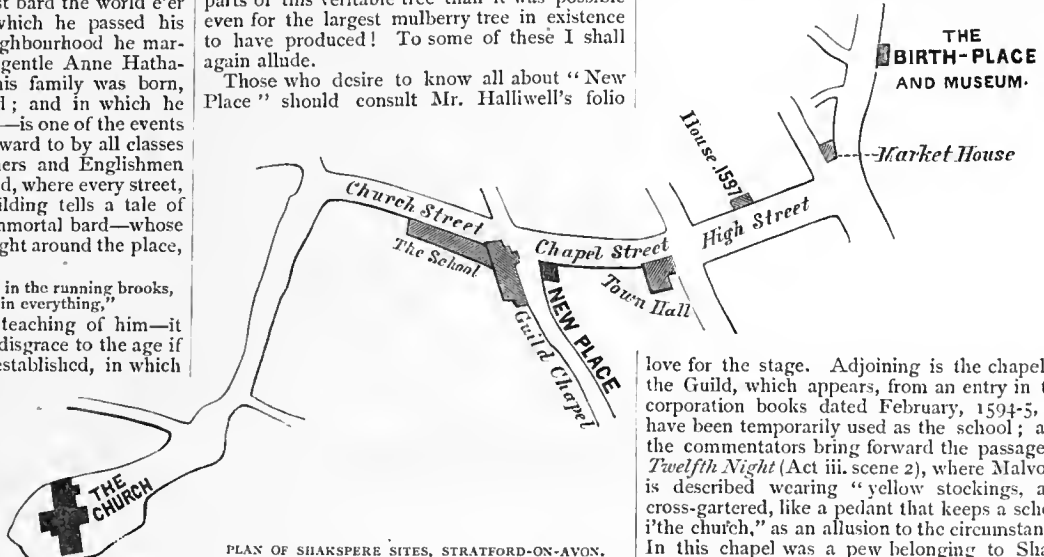

PLAN OF SHAKSPERE SITES, STRATFORD-ON-AVON.

work on that subject, which contains all that can possibly be written or collected together regarding the place.

The CHURCH, one of the most elegant, and certainly one of the most interesting, in the kingdom, stands on the banks of the Avon, at the end of Church Street. It contains the grave and the monument of Shakspeare, and those of his loving wife, and of his daughter and her husband. The visitor to Stratford cannot but look with veneration and with more than ordinary interest on these remains and

love for the stage. Adjoining is the chapel of the Guild, which appears, from an entry in the corporation books dated February, 1594-5, to have been temporarily used as the school; and the commentators bring forward the passage in *Twelfth Night* (Act iii. scene 2), where Malvolio is described wearing “yellow stockings, and cross-gartered, like a pedant that keeps a school i'the church,” as an allusion to the circumstance. In this chapel was a pew belonging to Shakspeare's residence, New Place.

ANNE HATHAWAY's cottage, and the other places in the neighbourhood of Stratford connected with Shakspeare, will naturally be visited by the tourist; but with these we have nothing, in our present article, to do.

The Museum at Stratford-on-Avon is located in Shakspeare's birth-place, in Henley Street. It was one, and certainly one of the most important, results of the Tercentenary Festival held at Stratford in 1864. The movement for this purpose was begun in 1861 by the establishment of a “Shakspeare Fund” by Mr. Halliwell, the “guardian genius” of the locality, the objects of the fund being the purchase of New Place; of the remainder of the Birth-place estate; of Anne Hathaway's cottage, with an endowment for a custodian; of Gatley's copyhold; the purchase of any other properties in or around Stratford intimately connected with Shakspeare; the calendaring and preservation of the records at Stratford which illustrate his life and times; and the erection and endowment of a public library and museum at Stratford. Of these objects, the purchase of New Place (primarily bought, to secure it, by Mr. Halliwell), and the establishment of the library and museum, are accomplished: the latter have been conveyed, and their permanency thus secured, to the corporation of Stratford, upon trust to place their management under a board, consisting of the Lord-Lieutenant of the county, the High Steward of the borough, the Mayor and Aldermen, the Vicar, the Master of the Grammar



SHAKSPERE'S BIRTH-PLACE, NOW THE MUSEUM, STRATFORD-ON-AVON

School, and others; and thus the marvellous collection of Shaksperiana already got together is secured to the public “for all time.” The principal contributors of objects to the Museum appear to be Miss Wheler, who has presented the remarkable antiquarian and literary collections formed by her father, the historian of the town, relating to Stratford and to Shakspeare; Mr. J. O. Halliwell, who has contributed a marvellous collection of Shaksperian books, &c., some five hundred in number; Mr. W. O. Hunt,

memorials, and will read, as hundreds of thousands have done before him, the lines:—
“Good friend, for Jesus' sake, forbear
To dig the dust enclosed here;
Blest be the man that spares these stones,
And curst be he that moves my bones;”

and those to his daughter—

“Witty above her sexe; but that's not all—
Wise to Salvation was good Mistris Hall;
Something of Shakspeare was in that, but this
Wholly of Him with whom she now's in bliss.”

the late Mr. Fairholt, Captain Saunders, Mr. Denman, the Shakspeare Book Club, &c.

Among the more notable objects in the Museum are the following:—The original deed, made in 1596, proving that John Shakspeare, the father of the poet, resided in the house called the Birth-place, in Henley Street—the very house in which the deed is now preserved. The original fine levied on the purchase by Shakspeare of New Place, in Easter term, 1597, the latter part of which important document runs as follows:—“*Inter Willielmum Shakspeare quer. et Willielmum Underhill generosum deforc. de uno messuagio, duobus horreis, et duobus gardinis, cum pertinentiis in Stratford-super-Avon, unde placitum convencionis sum. fuit inter eos, &c., scilicet quod prædictus Willielmus Underhill recogn. prædicta tenementa cum pertinentiis esse jus ipsius Willielmi Shakspeare ut illa quæ idem Willielmus habet de dono prædicti Willielmi Underhill et ill. remisit et quietclam. de se et hered. suis prædicto Willielmo Shakspeare et hered. suis in perpetuum; et præterea idem Willielmus Underhill concessit pro se et hered. suis quod ipsi warant prædicto Willielmo Shakspeare et hered. suis prædicta tenementa cum pertinentiis in perpetuum. Et pro hac, &c., idem Willielmus Shakspeare dedit prædicto Willielmo Underhill sexaginta libras sterlingorum.*” (Pasch. 39 Eliz.).

Another most remarkable and very interesting document, which is sure to be noticed by the visitor, is an original letter written by Richard Quyne in 1598, asking for the loan of £30. This, the only letter or paper

hastin to an ende, and soe I commit thys (to) your care and hope of your helpe. I feare I shall not be backe thys night ffrom the Cowrte. Haste. The Lorde be with you and with us all,

grand-daughter and her husband, Elizabeth and Thomas Nash; and numerous others of equal interest and importance.

The Museum contains a small collection of coins, medals, and tokens of local interest. Among the coins are an extensive series of Roman first, second and third, brass coins ranging from Germanicus, B.C. 15, to Gratianus, A.D. 367, discovered at different periods at Stratford; and a number of English silver coins of various reigns found at the same place. The series of Stratford traders’ tokens is especially interesting. Among these are a bookbinder’s token of 1668, which is of very rare occurrence; and examples of the corporation-tokens of 1669. In reference to the issuing of the latter the following curious entries occur in the corporation archives, under date 1669:—“Agreed that 6lbs. of half-pence be bought and stamped with the corporation armes upon them, and delivered into the hands of the chamberlynes, to exchange the same; and what profit shall accrue by putting them forth shall be layed out for the benefit of the poore;” “for other persons who have put forth halfpence, &c. to call them in under a penalty.”

Among other objects especially worthy of note by the visitor may be briefly enumerated the following:—

A “cupboard of boxes,” 6 feet high by 4 feet 11 inches in width, made in the year 1595, by Lawrence Abelle; it occupied him sixteen days and a half in making, and is still preserved in its original state with its “iron-hinges, locks, keys, and screw-pins,” as described in the bill for its making in Shakspeare’s days. This piece of furniture belongs to the corporation of Stratford, and has by them been placed in the Museum.

An ancient desk, said to have been Shak-



SHAKSPEARE’S BURIAL-PLACE AND MONUMENT, STRATFORD-ON-AVON CHURCH.

Amen! from the Bell in Carter Lane, the 25 October, 1598.

“Yowrs in all kindnes,

“RYCH. QUYNEY.

“To my loveinge good ffrende and cuntryman Mr. Wm. Shackspeare delivert hees.”

Another is the original conveyance, dated 15th October, 1579, from John Shakspeare and Mary, his wife (the father and mother of the poet) to Robert Webbe of their moiety of two messuages or tenements in Snitterfield, the consideration being £4; and a bond dated the same day, for the performance of the covenants in the conveyance.

Other Shaksperian documents are the original grant of four yard-lands in Stratford fields from William and John Combe to Shakspeare in 1602; the copy of the court roll of surrender by Walter Gatley to Shakspeare of premises in Chapel Lane—a property which he specifically devised by will; declarations and precepts in actions taken in the borough court by Shakspeare against Addenbroke and others; deeds relating to property adjoining the Birth-place, of which house the poet and his father are mentioned as owners; an assignment by Ralph Huband to Shakspeare of a lease of a moiety of the great tithes of Stratford; a deed with the autograph—the only



BELLARMINE, temp. SHAKSPEARE.

addressed to Shakspeare which is known to exist, reads as follows:—

“Loveinge contreyman, I am bolde of you, as of a firende cravinge your helpe with xxx li. upon Mr. Bushells and my securitee, or Mr. Mytens with me. Mr. Rosswell is nott come to London as yeate and I have especiall cawse. You shall firende me muche in helpinge me out of all the debettes I owe in London, I thanck God, and muche quiet my mynde, which wolde nott be indebted. I am nowe towards the Cowrte in hope of answer for the dispatche of my buyensness. You shall nether loose creddyt nor monney by me, the Lord wyllinge; and nowe butt perswade your-selfe soe, as I hope, and you shall nott need to feare, butt, with all hartie thankfulness, I wyll holde my tyme and content your ffrende, and yf we bargaine further, you shal be the paic-master yourselfe. My tyme biddes me



BELLARMINES, temp. SHAKSPEARE.

speare’s, removed from the grammar-school to the Muscum.

An ancient chair, brought from the Falcon Inn at Bidford, in which Shakspeare is said to have sat when he held his club-meetings there, and hence called “Shakspeare’s chair.”

The old sign of the same Falcon Inn at Bidford, “where Shakspeare is said to have drunk too deep.”

An ornamental gilt-table from the college at Stratford.

A number of carved oak figures from the Chapel of the Holy Cross in Stratford, and a selection of encaustic paving-tiles from Stratford Church.

Shakspeare’s gold signet-ring, with the initials W. S. intertwined with a true lover’s knot; and some other seals and rings found in the locality.

A pair of stirrups and a sword, said to have belonged to the poet.

The ancient sword of state, formerly carried before the Mayor of Stratford; and two very curious small old maces, also once belonging to the corporation.



ROOM IN WHICH SHAKSPEARE WAS BORN: MUSEUM.

one known—of Gilbert Shakspeare, brother to the poet; the settlement of Shakspeare’s estates in 1639 by his daughter, Susan Hall, and his

The albums or visitors' books of Stratford for many years, in which visitors of all degrees have entered their names.

A curious glass jug, called "Shakspeare's Jug," traditionally said to have belonged to the poet, and out of which, more than a century ago, Garrick sipped wine at the Shakspeare Jubilee.

A collection of almost every thing relating to the jubilee just alluded to, including a chair used in the Chinese temple, medals, and full accounts of the proceedings, &c.

A sheath for a pair of knives as formerly carried by ladies, and by Juliet. This specimen is of box-wood, richly and curiously carved in every part. The subjects represented are the six works of Mercy. Below is a scutcheon supported by an angel, and charged with a merchant's mark, with the initials J. N. On the inner side are six subjects exhibiting the history of the Prodigal Son: on each of the sides appear six of the apostles with their appropriate symbols. Below are the letters W. G. W., and the date 1602. These initials, which occur upon two similar wooden sheaths in the Debruge Dumesnil collection at Paris, dated 1593 and 1615, appear to have been the mark of a sculptor in wood, probably Flemish, noted for his skill in works of this delicate character.

A large and curious collection of mediæval stone-ware drinking-vessels, including Bellarmine or Grey-Beards, ale-jugs, &c., many of them of great interest, and curiously illustrative of Shakspearian times.

The Museum contains, as it is natural to expect it should, a considerable number and variety of articles made, or said to have been made, from Shakspeare's mulberry tree at New Place. Among these, one of the most prominent is the cup presented by Mr. Mayer, upon the pedestal of which is the inscription:—"Cup made from Shakspeare's mulberry tree, by Sharpe, of Stratford-upon-Avon, formerly in possession of Mr. Munden, and used at the meetings of the rebellions seven to drink to the immortal memory of Shakspeare;" and the quotation—

"And that I love the tree from whence thou sprangest,
Witness the loving kiss I give the fruit."

Henry IV., Pt. III., Act v., scene 7.

The "rebellious seven" were, it is said, some of Garrick's corps of dramatic performers, who resented the taking away of certain of their privileges, and were thus designated in consequence.

There are also a curious box with drawer, likewise the work of Sharpe; a slice of the mulberry tree, which formerly belonged to Garrick; snuff-boxes of various kinds from the woods of the mulberry and crab trees; a handsome carved goblet from the mulberry tree, presented by the Shakspeare Club; and a number of other articles made from the same celebrated tree, as well as a phial containing some of the juice of the mulberries gathered from it.

There are also other tree-relics to be seen, among which are some goblets, cups, snuff-boxes, and blocks of Shakspeare's crab tree, in connection with which Mr. Grubb's model of the poet asleep under the crab tree will also be noticed; a box made and carved by Marshall from the wood of Shakspeare's barn at New Place; and a piece of the wood of the genuine Herne's Oak, in Windsor Park, which fell down in 1863, and of which Mr. Perry, the eminent carver, has made some magnificent caskets, &c., and concerning the history and authenticity of which he has published a pleasant little volume. The tree from which this fragment was taken is, there can be no reason-

able doubt, the veritable one alluded to by Shakspeare in his *Merry Wives of Windsor*:—

Mistress Page. There is an old tale goes, that Herne the hunter,
Sometime a keeper here in Windsor Forest,
Doth all the winter-time, at still midnight,
Walk round about an oak with great rag'd horns,
And there he blasts the tree, and takes the cattle
And makes milch-kine yield blood, and shakes a chain
In a most hideous and dreadful manner.
You have heard of such a spirit; and well you know
The superstitious idle-headed old
Receiv'd and did deliver to our age
This tale of *Herne* the hunter, for a truth.

Page. Why, yet there want not many that do feare
In deep of night to walk by this *Herne's* oake:
But what of this?

Mistress Ford. Marry, this is our device,
That *Falstaffe* at that oake shall meete with us.

Our engraving, from Mr. Perry's work, represents the tree as it stood not long before its fall.

Among the oil-paintings and portraits contained in the Museum are many of interest, and they form a very attractive feature in the collec-



HERNE'S OAK, WINDSOR, JUST BEFORE ITS FALL.

tion. The following are perhaps among the most noteworthy:—

Stratford with its parish church before the old wooden spire was taken down in 1764, and also the charnel-house.

A portrait of Shakspeare in oil on canvas, generally known as the *Stratford Portrait*. This interesting relic has been in the possession of Mr. W. O. Hunt and his ancestors a century or more, and is supposed to have belonged originally to the Clopton family, as it was found in an old house in Stratford which Mr. Hunt's grandfather purchased of one of the Cloptons in the year 1758, and where Edward Clopton resided until the period of his death in 1756. It is the only known painting of old date which represents the poet in the same costume in which he appears in the monumental effigy in the church.

Shakspeare in his study, painted by John Boaden.

A large painting of Windsor and the Castle,

and showing the street down which Falstaff is said to have been carried in the buck-basket.

The famed Ely portrait of Shakspeare.

The interior of Stratford Church, taken before its restoration.

Engravings, copies in crayons, &c., of almost all the known portraits of the poet, and of places and persons connected with him and his works.

Of busts and models and casts of Shakspeare, &c., a profusion of examples will be noticed, and examined with pleasure. Among these are Britton's cast of the monumental effigy; Bullock's, Britton's, and Warner's casts from the bust in the chancel of Stratford Church; a reduced model of the statue of Shakspeare in the Town Hall; casts of Garrick, Combe, and others; models of Shakspeare's crest, &c.

Several relics from New Place, discovered during the excavations, will be noticed, as will many interesting records and *souvenirs* of the Tercentenary Festival of 1864. Among the latter of these are the wreath of oak leaves and acorns, which was placed on the bust of Shakspeare at Frankfort, in Germany, on the Tercentenary celebration, and afterwards presented to this Museum by the English circle at Frankfort; and the address of "The Free German Hochstift" to the corporation of Stratford, congratulating the people of Great Britain on the Tercentenary Festival.

At NEW PLACE, where the visitor will also find a kind of museum, are preserved several interesting articles; among them the most important, perhaps, are the many fragments of the house itself which have been brought to light during the excavations made upon its site; and which consist of a curious knife, a candlestick, tobacco pipes, fragments of cornices, and pieces of glass, china, earthenware, &c.

In this place is also preserved a painting, the portrait of a lady, formerly preserved in the Birth-place, and believed to be one of the Clopton family, and of which the following story has been put on record by Captain Curling:—"She was exceedingly beautiful, and the legend connected with the portrait is extremely curious. She was buried alive during the plague here, perhaps at the time our Shakspeare was about two years old, as in that year it raged so fiercely at Stratford, that in a few weeks a fifth of the population fell victims to it. This young lady sickened, and, to all appearance, died of it, and was buried in fearful haste in the vault of Clopton Chapel attached to Stratford Church. Within a week another of the family was seized, and, quickly dying, was borne to the ancestral vault, and, to the horror of the mourners, as they descended the stairs, the light of their torches showed them the figure of a woman dressed in her grave-clothes and leaning against the wall. When they approached and looked nearer, it was Charlotte Clopton. She appeared not long dead, and in the agonies of despair, hunger, and perhaps madness, she had bitten a large piece from her round white shoulder."

It will be seen from this very brief notice, how marvellous and extensive a collection of Shakspeare relics have already been got together in the Museum at Stratford-upon-Avon; and it only remains for me to add, that it is open daily by payment of an insignificant fee, and that it behoves every lover of Shakspeare, his works, or his times, not only to visit Stratford, but to add to the stores of the Museum any Shakspeariana he or she may possess or be able to procure, and thus to help to render the collection one, "not for an age, but for all time."

INTERNATIONAL EXHIBITION,
1871.

THE silence and solitude which prevail in the galleries and halls destined to "house" the International Exhibition of 1871, are proofs how thoroughly Colonel Scott and his staff have taken time by the forelock. Nothing can look less like the scene of gay bustle which is evoked by a Horticultural Exhibition—to say nothing of a display on a scale that ranks as international—than the present aspect of the great garden-quadrangle. The colouring of the cloisters opening on the ground has been completed since we last wrote: a very simple stage, propelled on rollers, being used for the convenience of the workmen. The French Court and annex have been untouched during the month. We cannot but fear that the sorrowful state of France will interfere with the punctual opening of this part of the exhibition. In that case, however, all that is necessary will be to arrange and beautify the garden-court, to hang heavy curtains over the entrance, and to leave the space to be filled in better times.

Upper and lower galleries are now left to dry—a very important desideratum. Only some details of staircases, railings, and landings, are yet incomplete. There can be no doubt of the readiness of the *locale* to receive all the incoming treasures that February will welcome to South Kensington.

With regard to the foreign contributions, Belgium has applied for a large increase of space; and, having obtained somewhat, has asked for more. Sweden and Norway will fully occupy the space allotted to those Scandinavian kingdoms. In addition to the articles they will exhibit under the ordinary conditions, they have engaged to erect a model school-house on the grounds adjoining the galleries, to fill it with their scholastic appliances, and, in fact, to transport to London a working model, or rather, an actual sample, of a northern school. Under the present state of public feeling on this subject this idea is eminently happy, and its accomplishment can hardly fail to secure a great success.

The smaller German states will fill their respectively allotted divisions. The kingdom of Hungary claims an establishment altogether separate from that of the Austrian dominions of King Francis Joseph. Reproductions of ancient or mediæval works of Art are admissible, and are expected, in considerable numbers, from the German, Austrian, and Hungarian artists. The porcelain of Munich and of Berlin will be, it is hoped, adequately represented, as will Spain—generally and thoroughly.

As to Denmark, nothing is yet decided. We hope that no misunderstanding may prevent a fine display of the products of a gallant country between which and ourselves there ought to exist the warmest sympathy. No little Danish blood runs in many English veins. No foreigner so soon, or so correctly, speaks English, as the Dane.

It is intended to hang the large upper corridor of the Albert Hall with architectural and other drawings. Additional space will thus be afforded to exhibitors. We hope that English architects will exert themselves to make a fine display on an occasion when continental brethren promise to muster in force.

We have again to remind our readers of the days on which contributions will be received, which are as follows—February: 1st to 4th, Machinery; 6th and 7th, Scientific Inventions; 8th and 9th, Educational Works and Appliances; 10th and 11th, Pottery and Raw Materials; 13th and 14th, Woollen and Worsted Fabrics and Raw Materials; 15th and 16th, Sculpture not applied to works of utility; 17th, Painting applied to works of utility; 18th and 20th, Sculpture applied to works of utility; 21st, Engraving, Lithography, Photography, &c.; 22nd, Architectural Designs, Drawings, and Models; 23rd, Tapestries, Carpets, Embroideries, &c.; 24th, Designs for all kinds of Decorative Manufactures; 25th, Copies of Pictures, Mosaics, Enamels, &c.; 27th and 28th, Painting not applied to works of utility.

THE ALBERT MEMORIAL.

THE Albert Memorial recalls to mind, in its present state, the image of a splendid butterfly, just struggling to free the lower part of its body from the sordid crust of its chrysalis. Above, golden spires and glittering pediments shoot up, to catch such sunshine as January dispenses. A close hoarding, dim, wet, and dirty with half-melted snow, obscures the lower part of the edifice. The careful way in which the sloping pent-house roofs are fitted to the shaft of the structure adds to the apparent, though temporary, incongruity. It is, of course, impossible to offer any well-considered Art-criticism in the present state of the Memorial. The objection that most naturally occurs is, that the spire is neither one thing nor another—too architectural in its treatment for a sort of jewelled shrine, and too glittering and gaudy for a work of architecture. It is obvious, however, that this impression may be modified when we see the entire design unveiled.

One thing is tolerably certain, that it is a very great mistake to have made the subsidiary groups of sculpture, to one of which we alluded in our last number, of marble. Europa, under the snows of the present winter, gives positive pain to the beholder. Bronze alone should have been employed for these groups; and that bronze such as was cast into the effigies of our Stuart kings, and not the leprous alloy that is displayed in the Nelson lions, or the gloomy resemblance of cast iron that forms some other modern statues. Fine castings of good bronze would have offered a maximum resistance to the corrosive vapours native to London, which will, in a few short years, reduce the features of marble nymphs to an indistinguishable level. In a statue, sheltered by a canopy, the process will go steadily on; but in one exposed to frequent rain the result will be extremely rapid—more so even than with a stone of less delicate grit than marble.

What ultimate change of posture or of proportion may have been effected in the sitting figure representing the Prince Consort, is unknown to us. The trials already made are not reassuring. The difficulties of treating a seated figure in such a position are great; and if, as we conclude, a style be followed that is decidedly and purposely naturalistic, they will, we fear, be found insuperable. We confess to look with more curiosity than hope to the unveiling of the completed monument. A memorial to a great man, and a great public benefactor, erected on the site of the wonderful creation of which he was the chief author, was a becoming idea; but that Art in this country is yet capable of a worthy embodiment of that idea, we more than doubt. No one would more rejoice to find this doubt dispelled than ourselves. After all, if the great amphitheatre display the proportions and grace which it is hoped will prove to be the case, the position of a cross-like monument close by, dwarfed by its shadow, and no way architecturally connected with its lines, is not likely to be a success. If the great dome of the Albert Hall become girt with the halo of popular admiration, what need is there of a second, and a lesser, memorial hard by? If that capacious building should, on the contrary, prove more like the Charing Cross and Cannon Street roofs than the airy cupola of St. Paul's, its ill neighbourhood will extinguish the Memorial. Speaking, as the fashion is, with all reserve, we do not see the escape from this dilemma—one that is complicated in a most unnecessary manner by the dead lock to which Mr. Ayrton's characteristic mode of interference has reduced the question of the rectification of the Kensington Road.

In due course, however, we shall have to deal with the whole subject: the public are anxiously looking for its completion, in the hope—but by no means a confident hope—that it will be a monument worthy of England, the good Prince whose virtues it is to commemorate, and the capabilities of British Art towards the close of the nineteenth century. It is not, however, likely to be finished before the termination of the year; the illness of Mr. Foley interfering with the statue of Prince Albert.

W. WARREN'S
SUMMER SKETCHES IN SPAIN.

A PEARL is not the less prized for having been found in a very rough oyster-shell. But the disengagement of the delicate gem demands the bold enterprise of the diver. We often have to dive in very deep, or very muddy, waters, for the gems which, month after month, we seek to lay before our readers. It is bold diving, for instance, to search for a picture-gallery in Compton Street, Soho.

There, however, for want of a better locality, at No. 12, are now to be seen some 150 original oil-sketches of unusual merit, together with a small miscellaneous collection of objects of rarity and interest: Venetian carvings, Spanish enamels, ivories, crystal and other crosses, and a very fine piece of Spanish tapestry. Mr. W. Warren, while occupying his hand and time in committing to canvas the very interesting sketches of which we have to speak, has been unable to resist the temptation to fill his pockets with an assortment of purchases which are, as we have said, miscellaneous, but all of which possess considerable interest, and some of them no small value.

The sketches themselves—and let our friends not be content with looking at those on the walls, but ask to peep into Mr. Warren's portfolio—were taken during the summer of 1870 in Spain. They include views of Granada and the Alhambra, Seville and the Alcazar, Cordova, Toledo, Gibraltar, and Tangiers. We are not aware of any occasion on which the scenery and incident of these spots have been brought home so completely to the English observer. Mr. Warren's style is peculiar to himself: it might almost be called water-colour drawing in oil. Making every allowance that may be requisite for the extremely unfavourable light obtainable in a London January, we do not think we are complimenting Mr. Warren too highly in comparing some of his sketches with the admirable water-colours of Fortuni, when viewed from a proper stand-point. In depth and brilliancy of colour, especially in his glowing carmines, he is often admirable. Aerial distance and perspective, the rush or the glow of the clouds, the tumble of the sea, and the glitter of the sunbeam on its waves, are given with unusual fidelity, and often with much power. And all this is done with a rapid touch, which is that of a sketcher. In some instances Mr. Warren has thus been able to give us representations of scenes from which the artist has hitherto been excluded. Thus we have interiors of synagogues, cathedrals, and mosques, glowing with mosaic and inlaid stones, and taken, it may be, during the pomp and glitter of the service. We have the ancient Moorish arches, grey with a stucco 1,000 years old, of the most ancient synagogue in Europe. Then we have the interior of the celebrated mosque at Cordova, showing a portion of its 1,096 columns, and interlacing arches. The columns are composed of choice marbles, some of them taken from Carthage, including jasper, porphyry, and verd-antique. The date is fixed at 786 A.D. Again we have the interior of Cordova Cathedral, built as a mosque, with the niche where the Koran was deposited, composed of gold mosaic, said to be the finest in the world. The view of Toledo Cathedral shows the stained-glass windows, the finest in Spain: that of Seville Cathedral indicates the spot where Columbus was buried, previous to the removal of his remains to the Havanas. The castle where Cervantes was confined is shown in another view of Toledo. The Gate of Justice, in the Alhambra, erected 1308, by Yusuf I., shows the symbolical hand and key—the former on the outer arch, and the latter on the inner one. The traditional boast of the Moors was, that the gate would never be opened to the Christians until the hand took the key. We might readily extend the list, but we recommend our readers to trust to their own eyes rather than to our description, and to obviate the ill effects of the cloudy canopy that overhangs Soho, by taking Mr. Warren's sketches home with them; sure as they are to be among those investments of which the value increases by lapse of time.

THE ALBERT HALL ORGAN AND ACOUSTICS.

THE anxiety we expressed as to the possibly overpowering effect of the magnificent organ now erecting by Mr. Willis in the Royal Albert Hall, has been shared and re-echoed by those who are most competent to form opinions on the subject. The resonance of a building for a single voice is not necessarily identical with its adaptation to organ-performances. St. George's Hall, Liverpool, is an instance in point. The walls and floor, as in the case of the Albert Hall, are remarkable for the hardness of the material of which they are formed; but such is the confusion caused by the reverberations when a full organ gives breath to its numerous pipes, that an elaborate fugue is often undistinguishable, even by those who are familiar with the music.

An additional source of possible disturbance is to be found in the proportionate number of each of the two classes of pipes which constitute the organ. We have seen that there are upwards of 6,000 of these elements—a number truly prodigious. Those which may be regarded as the true elements of what an organ used to be, are called flue pipes, some of which are usually visible in the front of the instrument. These pipes have a conical base, widening to the lip, or visible open mouth, and then taper, very gently, to the end. These flue pipes produce the characteristic organ-tones peculiar to the noble instrument, which seem native to the vaults of minsters and cathedrals. The other class of elements consists of what are called reed pipes, in which the sound is mainly produced by the vibration of a metal tongue placed at the mouth of the pipe. This arrangement gives what may be called the nasal tone of the harmonium; and, although stops constructed on this principle are intended to simulate the trumpet, the French horn, and other wind instruments acted on directly by the breath and lips of the performer, there is almost always a *souffron* of the drone of the bagpipe, or the grinding vibration of the clarinet, to prevent the trumpet-stop, for instance, from being mistaken for a trumpet.

Now, in the new organ the proportionate number of the reed pipes has been greatly increased. Hence, in great measure, their disagreeable brassiness of tone—not altogether, however. Age, there can be little doubt, increases the softness and sweetness of a really good instrument, as is most perceptible by any ears that heard the great Birmingham organ when first erected. But the great object of many modern organ-builders and organists is, to represent, by the use of the claviers and pedals of the complex structures, the full chorus of an orchestral band. This, there is some reason to hold, is a great mistake. An organ can no more perform the duty of a full orchestra than a hurdy-gurdy can replace a harp. But in the effort there is danger that the rolling tones proper to the organ should be overpowered, and the true magnificence of organ-music destroyed.

Since the above was written, an opportunity such as we asked for has been given. On the 7th instant, "a few friends," to the number, we should guess, of some couple of thousands, dropped in to hear a second set of acoustic experiments in the Hall. The performers were a lady, who sang two very effective *solos*, and the band of the First Life Guards. The result of the experiment, if not conclusive, was satisfactory. The scaffolding which on the last days of the old year lined the inner shell of the large amphitheatre, had been removed, as if by magic. The stack of timber in the centre, on which the roof had rested, still remained. This was likely to disturb the sound. On the other hand, only a very small portion of the glass roof was fixed, and the wooden planks which covered the remainder of the area were better for auditory purposes than the glass is likely to be. Thus, on the whole, the effect was not unlike what it may be when the finished Hall is one-fourth or one-third full.

The body of sound emitted by the band appeared to be magnified, without being, as a

whole, multiplied. The effect of different instruments was decidedly different. The full notes of the ophicleide seemed to roll down from the roof. The trumpets and cornets rang sharp through the building. The drums rolled from the orchestra—the sound of these instruments being more distinctly referrible to its actual local sound than that of any other. The notes of the clarionets and oboes perhaps lingered longer around the walls than those of the other instruments. In some places the ear could detect a double sequence of notes—the air and the echo;—but, on the whole, the effect was admirable. A series of observations on separate instruments will now be carried on, so that the actual acoustic relation between each pitch and quality of sound, and the actual resonance of the building, will be ascertained. Thus if reed instruments, or any other, prove to be less adapted to the building than the voice, the piano, and the trumpet certainly are, the orchestra performance can be arranged accordingly.

Thus far, at all events, Colonel Scott deserves, and received the other day, the warmest congratulation.

PHOTO-CRAYON PROCESS OF SARONY AND CO.

SOME photographic portraits on glass and on china, that have been produced by Messrs. Sarony and Co., of Scarborough, are specimens of a new and beautiful method of applying the chemistry of light. Messrs. Sarony have an establishment at Scarborough on a very large scale. They are also licensees of the autotype process; and in their application of carbon pictures to glass and to porcelain, they have struck out in an entirely new direction. They are in possession of lenses of large diameter, and magnify an ordinary photographic likeness to life-size with unusual force and power. The softness of outline and delicacy of shade produced on the glazed surfaces are extremely pleasing to the eye. The application of photography to ceramic ornamentation is yet in its infancy, and will, we have no doubt whatever, make rapid progress. Of the various methods now under trial, there is none that appears to promise so much as that of Messrs. Edwards and Kidd. This consists in the printing of designs on transfer-paper, by the heliotype process, in metallic colours, which can be readily transferred, by the ordinary process, to the surface of the biscuit, and fired in the usual way. Real enamelled pottery can be thus produced at a surprisingly low cost; and objects of artistic excellence may become our constant and serviceable companions. Messrs. Sarony will no doubt avail themselves of an invention which will further extend the power of their establishment.

The photo-crayon process we have not had the opportunity of inspecting. It is described as being a combination of a transparent positive with a crayon backing, blending with it in tone. The result is said to resemble a fine and highly-finished crayon-portrait of photographic truthfulness, delicately and softly worked in the face, and holdily and sketchily finished in the background. The result is such as to be quite deceptive in the means by which it is produced, and to lead even artists to attribute it to the skill of the miniature-painter.

The healthful and romantic Yorkshire watering place, which has become within the last quarter of a century the Brighton of the north, possesses, in the establishment of Messrs. Sarony and Co., an artistic institution that has but few rivals in the country. A visit will well repay the trouble of inspection. We may, at this distance, examine isolated specimens of the productions of the establishment, but a just idea of its capabilities can be found only on the spot. Especially the use of photography, as furnishing an accurate outline or sketch for a portrait to be worked out in oil, is a subject that may here be studied.

MINOR TOPICS OF THE MONTH.

THE ELECTION AT THE ROYAL ACADEMY of an Academician, which took place on the 30th of December, resulted in the choice of Mr. W. E. Frost. That intelligence will gratify many; it has been long looked for, both by the public and the profession; and, although a mere act of justice—"better late than never." We hope it is not too late; for the recent pictures of the artist are not what his earlier works are—what, we believe, they would have been had the place that was his of right been accorded to him nearly a quarter of a century ago; for he was elected an Associate in 1846, and he is now verging on sixty years of age. Surely there must be something wrong in a system that keeps back from professional rank such a painter until preferment is of little value to him: no member of the Academy will dispute that if he ought to be elected now, he was as well qualified for election more than twenty years ago. Yet that is the system—evil in its consequences often, and objectionable always: to reform it, however, never enters into the minds and hearts of those who are of "the forty." Mr. Frost has produced works that may be classed among the best achievements of British Art; moreover, he has been always respected as a gentleman in every sense of the term; that is—professedly at least, in the estimation of the Royal Academy—something. There have been "waiters in the cold," whose admission has been postponed because of some blot in character: the case of Mr. Frost is the very opposite of that. He would confer honour upon any society of which he was a member. We rejoice, therefore, that justice has "at long last" been accorded to a most excellent artist and a most estimable man. The vacancy thus filled up was caused by the death of the sculptor MacDowell; there are now two others, created by the decease of the architect Hardwick, and the resignation of Mr. Westmacott. No doubt a sculptor will be the next elected. Consequently the Academy is in a position to add four to its number of Associates—and four only, if it be resolved to limit to twenty the Associate-list: a limitation which, we affirm, implies bad faith to Parliament and the public, unless it can be shown that no more than four artists of desert are waiting—patiently or impatiently—outside.

THE ROYAL ACADEMY summoned its members to a meeting on the 24th January, for the purpose of electing three Associates. As our columns were in type on that date, we are precluded, until next month, from recording the decisions of the assembly.

MR. WESTMACOTT, R.A., has resigned his position as member of the Royal Academy: the step is highly to the credit of that accomplished gentleman and artist: he thus makes room for a younger man, while we cannot doubt that the Institution will continue to have the full benefit of his large experience and practical knowledge.

MR. FOLEY, R.A.—We are glad to state that, though the continued illness of this eminent sculptor still confines him to his room, the more severe symptoms of his attack are gradually subsiding.

HER ROYAL HIGHNESS THE PRINCESS LOUISE has kindly enriched the Exhibition in aid of the French Paganry, by the contribution of three pictures by her own hand: a landscape in oils, and two water-colour drawings—'A Study of a Head,' life-size, and 'Maidenhood.' It is gratifying to chronicle the success of this most

deserving project: up to this date over £3,000 has been received towards the relief of our poor peasant neighbours.

INTERNATIONAL EXHIBITION OF 1871.—The following nobleman and gentlemen have consented to act as judges to select paintings for the forthcoming exhibition:—The Viscount Bury, M.P.; the Lord Elcho, M.P.; Sir Coutts Lindsay, Bart.; Messrs. Alfred Elmore, R.A. (representing the Royal Academy); Alfred Clint (representing the Society of British Artists); Alfred Hunt (representing the Society of Painters in Water-Colours); Henry Warren (representing the Institute of Painters in Water-Colours); F. Dillon; and H. S. Marks. This list differs but slightly from that we printed a few months since.

THE ARCHITECTURAL EXHIBITION, for many years held in Conduit Street, will no longer take place, the undertaking having been declared a pecuniary failure; but a somewhat similar exhibition—that is, one of working drawings and details, a purely technical display—is, according to the *Architect*, being organised by the joint action of the Architectural Association and the Council of the Architectural Museum.

THE BRITISH MUSEUM, it is stated, has been presented by Sir William C. Trevelyan with a series of very interesting drawings by English artists of the last century. They comprise eight examples of N. Pocock, a marine-painter; one by Jacob More; and four by Edward Edwards, who was employed by Boydell to make drawings from the old masters for his publications, and by the Society of Antiquaries for the same purpose. Edwards, who died in 1806, held the post of teacher of Perspective at the Royal Academy, and wrote a work on that subject, and also produced other books on Art. He was the compiler of the "Anecdotes of Painting," a supplement to Walpole's well-known work.

THE ARTISTS' AND AMATEURS' SOCIETY, of which Sir Antonio Brady has lately been elected President, held its first *conversazione* for the season on the 19th of January; too late in the month for us to offer any report of the meeting. The remaining evenings are on Feb. 23rd, March 30th, and May 4th.

MR. T. FAED, R.A., informs us that the picture entitled 'Hide and Seek,' engraved in our last month's number as one of his works, is the production of Mr. R. T. Ross, R.S.A. Our explanation of what must be considered an error is this: the engraving was made from a large photograph procured by us from the Autotype Company, and represented to be from a picture by Mr. Faed. The photograph was originally taken by Mr. Annan, of Glasgow, who disposed of the negative, with others, to Mr. Swan, the inventor of the Autotype process, as Mr. Annan has since informed us. The composition in no way differing from those usually painted by Mr. Faed, we had no doubt whatever of its authenticity, and therefore did not think it necessary to submit it to him for verification. We very much regret the mistake—the only one, it may, perhaps, be allowed us to say, that has occurred in a list of considerably more than three hundred woodcuts we have given from the works of British Artists in the series of papers published under that title. M. Ross—whom we hope to include among the number at some future time—we are assured will not feel aggrieved that a work of his has been mistaken for one by his distinguished countryman; and Mr. Faed, we know, is most unwilling to claim credit for that to which he is not entitled.

THE SOCIETY FOR THE ENCOURAGEMENT OF THE FINE ARTS opened its thirteenth session, on the 10th of January, with a *conversazione* in the gallery of the British Artists, Suffolk Street. Lectures are announced to be delivered by the following gentlemen during the season:—Messrs. Wyke Bayliss, and W. Chaffers, Dr. Hyde Clarke, Dr. Doran, Dr. H. Heinemann, Dr. Zerffi, Messrs. Henry Marston, W. Cave Thomas, T. Gilkes, and J. Dafforne: other lectures are promised.

THE ARTISTS IN PARIS.—Much public interest is excited with reference to the position of several leading artists of France who are fighting within the beleaguered walls of Paris. Probably their fate will be decided before our Journal is in the hands of its readers. It is indeed lamentable to think that a morsel of lead or the fragment of an iron shell may destroy such men as Meissonnier, Gustave Doré, and a score of other great men, who are, in a sense, the property of the world. We earnestly hope and pray that their lives may be prolonged for an heroic future. It is, however, known that many have taken sanctuary in London. It is certain also that several of the best artisans of Paris are in this country: their skill is now, and may be for some time to come, at the command of British manufacturers: they will be wise who seek and find such serviceable auxiliaries.

THE LADIES' EXHIBITION will again open in Conduit Street, in February: it has done well in past years, yet it hopes to do better, and it may do better if it be helped by artists who have achieved distinction, and will not disdain to co-operate with the comparatively junior members of "the sex." There are many ladies who do very wrong to keep aloof: they may gain something, they can lose nothing, by joining as contributors; at all events, they may have the comforting consciousness of strengthening that which, without such aids, cannot but be weak.

PICTURE SALES.—Messrs. Christie and Manson announce for sale early in the ensuing season the collection of drawings belonging to the late Dr. Scriven; the remaining works of the late Mr. F. Halliday; the collection of paintings, the property of the late Mr. W. Anthony; sculpture by the late Mr. Alfred Gately, of Rome; the remainder of the valuable stock of foreign pictures of Messrs. P. L. Everard and Co., of Bedford Square and Brussels; works by the late J. B. Payne; and the collection of ancient and foreign pictures formed by the late Mr. Robert Nasmyth, of Edinburgh.

ALEXANDRA PARK AND PALACE.—The Woodgreen committee for promoting the opening of this establishment, on the plan proposed by Mr. Francis Fuller, has awarded the prizes for the essays on this subject as follows: The first prize to Mr. R. Glover, jun., Surinan House, Stratford, Essex; and the second to Miss M. A. Morel, daughter of the Rev. M. Morel, the Vicarage, Wallingford, Berks.

MR. GAMBART has issued a small engraved copy of the 'Light of the World' by Holman Hunt: it is but 2½ inches wide by 5 inches in height: it is, however, very charming—some will prefer it to the larger print. The publisher's purpose is to forestall the "thieves" who pirate, by photography, the best Art-publications of the day: against whom there seems to be no redress. We have at this moment before us two printed lists of photographs containing among other piracies from recent engravings, many from the Royal Gallery and other works issued in the *Art-Journal*; it would be utterly

futile to take steps against such rogues: they are not to be found to-day where they were located yesterday; and if the "strong" hand of the law clutched them, there would be merely a return—"no effects." Moreover, the Copyright Act presents obstacles instead of aids in the way of justice.

THE CRYSTAL PALACE.—The last report of the directors of the Crystal Palace Company is, we regret to find, not encouraging. The receipts had fallen about £5,000 below those of the preceding year, 1869: the general result of the year's working was, that on an expenditure of £97,000, the net earnings had been £43,000. A long and desultory discussion took place with reference both to the present and the future, but the report was at last adopted, and a dividend of one per cent. declared for the benefit of the shareholders.

SOCIETY OF ARTS.—Mr. Alan S. Cole somewhat recently read a paper before this Society "On a New Method of Producing Mural Painting by Fictile Vitrification." It related to a process introduced by Mr. Campbell, of the firm of Minton and Co., of the Staffordshire Potteries, of manufacturing *tesseræ* by compressing a composition of stone and clay into metallic moulds. Mr. Campbell's resources enable him to contrive a complete palette of vitrifiable colours, almost similar to the ordinary oil-colours; and the artist can apply them to the *plaques* in precisely the same way as he would oil-colours to his canvas. The *plaques*, when painted, are fired; and, upon withdrawal from the oven, should alterations be considered necessary, the artist can do so by painting in his corrections, which may be fired into the composition. The texture, as Mr. Cole described it, is identical with that of oil-painting; and the result of the process he described to be "permanent painting upon a true and level surface—illimitable, if necessary, in its size." Several distinguished artists, and other gentlemen took part in the discussion that followed: among whom were Messrs. C. W. Cope, R.A.; E. M. Ward, R.A.; R. Redgrave, R.A.; E. J. Poynter, A.R.A.; J. G. Grace, Professor Donaldson, Mr. Hyde Clarke, and the chairman, Mr. Ayrton, M.P.

NATURAL FEATURES OF FRANCE AND GERMANY.—Under the title of a map of the natural features of France and Germany, Mr. Stanford has published a very excellent illustration of the seat of war. The map distinguishes the river systems, watersheds, and mountain chains, according to La Vallée's physical, historical, and military geography. It also shows the fortified places, state boundaries, and railways; and indicates the principal towns. The plan adopted is such as to give due prominence to the physical features of the country. The sea is well represented by a sort of blue granulation, and the eye takes in the general outline of the district at a glance. We think it would have been better had the latitude and longitude been indicated on the frame of the map; although we quite hold with the omission of the meridian and parallel lines from the surface of the plan itself. Mr. Stanford has given us in this sheet a very good example of what a map ought to be.

MR. MATTHEW NOBLE has produced a very admirable bust of the late Earl of Derby: it is placed in the Guildhall, which contains busts of many other worthies of the age and country.

MR. P. L. EVERARD'S remaining collection of pictures, chiefly by Belgian artists, will be sold at Christie's on the 18th of February: it cannot fail to attract the best

connoisseurs of England, for it contains examples of all the eminent masters of the French and Belgian schools; indeed, there is hardly one of their famous masters who does not contribute one or more to the collection—Gallait, Coomans, De Haas, Duverger, Dillans, Castan, Carolus, Rosa Bonheur, Koller, Tadema, Stevens, Verboeckhoven, Van Schendel, Frère, Diaz, Meissonnier, Campotosto,—the list is far too large to copy entire. Buyers at this sale may purchase with a certainty that they acquire true works. Mr. Everard has established a high and honourable position in England as a dealer: his connections are numerous and of the highest order in this country as well as in Belgium. He has introduced among us a very large number of the most valuable and instructive productions of the greater masters of the Continent; and we believe there are few of our more important galleries to which he has not been a contributor. A dissolution of partnership, in-so-far as England is concerned, leads to the distribution of his present collection; but he is a permanent resident in London.

THE ANNUALS OF MESSRS. DE LA RUE.—Although late with our notice, it is a pleasant task to award praise to the renowned stationers to whom we have been so often, and in so many ways, indebted. It is sufficiently notorious that of all the diaries and pocket-books of the year, those issued by Messrs. De la Rue are by far the best: persons who use them can be satisfied with no others. They are not only neatly and well bound and printed,—the information is skilfully condensed, and sufficient in extent for all suddenly needed purposes. As usual, Messrs. De la Rue issue the “playing-cards” of the year; for use they have long been pre-eminent. The artist has been summoned to render efficient aid: some of the backs submitted to us are very charming specimens of Art.

THE GREEK CANON OF PROPORTION.—A correspondent writes to us:—“I shall feel obliged if any of your readers can furnish me with a sketch of the line of argument adopted by the defenders and enthusiasts of Ancient Greek Art against the assertion that some of the antique statues are out of proportion as regards the heads. I should also like to be informed whether there is any reason, other than the fashion of the times, to account for the fact of the upper lateral part of the foreheads of their male statues being invariably hidden beneath the hair.” Perhaps some of our readers who have made Greek sculpture an especial study, could reply to these queries.

THE BELLEEK POTTERY has produced an admirable copy of Fontana's statue of ‘The Prisoner of Love,’ engraved for the *Art-Journal*. It is of statuary porcelain, more than two feet in height, and may, therefore, be regarded as an important achievement of the potter's art: the material is second to none that has hitherto been applied to the manufacture; indeed, it so very closely resembles marble as to be easily mistaken for it, even after examination. The modelling is more than usually excellent; the artist who has made the reduction deserves high credit. This effort of the Irish factory will bear comparison with the most meritorious of the productions issued from Stoke-upon-Trent, and may be accepted as conclusive proof that the porcelain of Ireland rivals that of England. If Belleek continues to send forth such works, the renown we foresaw and foretold will be everywhere admitted, and its trade greatly enhanced. To Ireland, with its few manufactures, that will be a vast boon.

REVIEWS.

SPANISH TOWNS AND SPANISH PICTURES. By MRS. W. A. TOLLEMACHE. Published by J. T. HAYES.

“SPAIN is probably the only European country,” writes the author of this volume, “which has not been overrun by tourists. Whilst the picture-galleries of Italy, Germany, and even St. Petersburg, are familiar to most English travellers, the Royal Museum at Madrid, which contains, perhaps, the finest collection of pictures in the world, is comparatively unknown.” Two exceptions must be taken to this passage: one, that it is very questionable whether the Hermitage Gallery at St. Petersburg is better known by actual observation of foreigners than the Madrid Gallery; the other, that the latter certainly does not by any means contain the “finest collection in the world,” though it unquestionably stands without a parallel in the number and value of Spanish paintings.

And now, having delivered ourselves of this comparatively insignificant protest, we at once say that Mrs. Tollemache has produced a book of much interest, and one, too, which future travellers in Spain may find of value. There is just enough information concerning the roads, and the chief towns visited by her, to serve the purpose of others; while the remarks upon the principal buildings are trite and judicious.

By far the larger number of pages is absorbed by a notice of the great pictures in the galleries of Madrid, Seville, and Valencia: these are examined not so much critically as explanatorily; concise histories of the personages represented being given in lieu of strictures on the style and manner of such artists as Velasquez, Murillo, Antonio Moro, Zurbaran, El Mudo, and others of the Spanish school; Rubens, Vandyck, Raffaele, Titian, Leonardo da Vinci, Paul Veronese, Andrea del Sarto, of other continental schools. In all the descriptions, whether of paintings or places, men or manners, Mrs. Tollemache writes pleasantly, gracefully, and unaffectedly; so that what she calls “an unpretending manual,” is in reality a very interesting traveller's guide-book—carefully printed in large type, and tastefully bound. It is illustrated with photographs of the ‘St. Paul and St. Anthony,’ by Velasquez; of a portrait of Velasquez, and one of Murillo. The author has dedicated her work very appropriately to Sir William Stirling Maxwell, whose kind perusal of its pages has, she states, “given her encouragement.” By the way, we may here repeat a remark made by us some time ago, that a new edition of Sir William's “Artists of Spain” is much wanted: the book has for many years been out of print, and is, therefore, quite inaccessible to hundreds who desire to possess it, as the most comprehensive and valuable work existing on the subject of which it treats. Less is known in this country of the Spanish schools of painting than of any other: the reappearance of the volumes to which reference is now made would be hailed with no little satisfaction by all students of Art.

LIGHT AND DARKNESS. Engraved by W. RIDGWAY, from the Picture by G. SMITH. Published by the ART-UNION OF LONDON.

Mr. Smith's picture, exhibited at the Royal Academy in 1865, represents a touching subject, and is treated with thought, feeling, and judgment. In the interior of a cottage, where a large family of old and young is gathered, a blind female reads, from one of the raised-letter Bibles invented for the use of such as are afflicted with loss of sight, the truths of Scripture to the inmates of the dwelling—hence the appropriate title “Light and Darkness.” The group of figures, ten in all, is very strikingly set forth; but the impression made on the hearers by the reader is varied and unmistakable. At her feet sits a young girl, watching intently the operation of the fingers over the open pages of the book; behind her is an elderly couple listening attentively to the sacred words: the expression of the face of the old man, as he looks earnestly into that of the “cottage missionary,” is most

benignant. In the rear of these are two younger females: one, a married woman with an infant in her arms, looks deprecatingly at her husband, a villager in a round frock, whom a drunken companion is endeavouring to draw away to the fair held on the green close by, and which is just visible through the open lattice-window. The other younger female, probably a sister, stretches out her hands to try to arrest the progress of the man; and a little girl, carrying a doll, looks at the latter, half-frightened and half-imploringly. The scene is an admirable and instructive homily, and we are pleased to find the Art-Union of London offering to its subscribers of the present year, a subject in every way so excellent and so deserving of popularity. Mr. Ridgway in his engraving has done it full justice.

THE WONDERS OF ENGRAVING. By GEORGE DUPLESSIS. Illustrated with Ten Reproductions in Autotype; and Thirty-four Wood Engravings by P. SELLIER. Published by S. LOW, SON, AND MARSTON.

The history of engraving has employed the pens of so many writers at different times, that anything in the way of novelty, or that would add to the amount of information already acquired, is not now to be expected. Yet, it will doubtless attract to the subject many who are at present ignorant of it, when it is brought before them in the popular and attractive manner we find in M. Duplessis's treatise, now translated from the French. Tracing back the early history of the art, the exact origin of which has always been lost in a kind of obscurity, the author reviews the various schools of engraving in each of the European countries where it has flourished. The earliest known example of the art had, till very recently, been assigned to the anonymous woodcut, ‘St. Christopher,’ in the possession of Earl Spencer, which bears the date of 1420, as we read it on the reproduction forming the frontispiece of the volume now on our table, though M. Duplessis gives it, in his text, as 1423. Whichever may be right, an engraving very recently discovered by Baron Reiffenberg, and now in the Museum of Brussels, goes a little further back than either year, for it is understood to bear the date of 1418. “In our day,” adds M. Duplessis, “thanks to two plates printed on the leaves of a manuscript which M. Henri Delaborde has described and commented on,” in the *Gazette des Beaux Arts* of March, 1869, “with remarkable clearness, we know, that in 1406, the art of wood-engraving must have existed and the printing-press been brought into use.”

When we came to the chapter upon engraving in England, it appeared to us that its author had scarcely done justice to the men of our own country; and we subsequently noticed, in the preface, a remark by the translator—whose name we would gladly give had it been appended, for he has done his work faithfully and well—that he shares our opinion. Abraham Raimbach, who died more than a quarter of a century ago, “closes,” according to M. Duplessis, “the list of English engravers”—in line. But there are some of Raimbach's contemporaries and successors whose works will go down to posterity almost, if not quite, as valued as his own. We quite agree with the translator's remark—“Many of our most illustrious names are unnoticed, whilst others are brought into undue prominence.” We have but to mention among the former, John Burnet, Pye, J. T. Willmore, and E. Goodall.

A word or two touching the illustrations introduced into the volume: a few, both woodcuts and autotypes, are satisfactory; the rest only mediocre; they are, especially the former, tame and wanting in brilliancy.

THE CAT'S PILGRIMAGE. By JAMES ANTONY FROUDE, M.A. With Six Illustrations by J. B. Published by EDMONSTON AND DOUGLAS, Edinburgh.

This drawing-room book is the unbending of a large and strong mind. The vignette on the title-page is an aid to carry out the author's intention: the cat, with folded paws,

is listening to the counsel of an owl, to "meditate—meditate—meditate;" the dog is fast asleep over a dull book; the fox is blowing bubbles; the ox is looking regretfully into the mug he has drained. The superb cat of the frontispiece is certainly a noble specimen of the feline race.

It was a quaint conceit of the great historian to send the cat on a voyage of discovery, to find out and ascertain "what arc we here for."

She certainly was a philosophic animal, who must have received her education on Mr. Froude's hearthrug. Having been properly brought up, married, and widowed, and the mother of a large family, all well-to-do in the world, she determined to find out "the use of it," if possible. Her conversation with the dog was not satisfactory to her scientific turn of mind; yet she had led a very happy life; and did not even fret for her "son," though he was "a nice fellow," with whom she spent "many jolly evenings," yet now she seemed "to get on quite as well without him:" the whole of her soliloquy is full of character; and so is her conversation with the sleepy dog, who would not wake up or be "bothered," because, to quote his own words—

"I am tired; I stood on my hind legs ten minutes this morning, before I could get my breakfast, and it hasn't agreed with me."

"And who told you to do it?" said the cat.

"Why the lady I have to take care of me," replied the dog.

The whole of the dialogue between the cat and dog is admirable; but the cat thinks the dog a lazy, unphilosophic brute; and so trots away on her own account, to see what she can glean of wisdom, from creatures in the wood.

She inquires of the blackbird what one should do to be as happy as he is.

"Do your duty, cat," is the answer. Poor puss! she received the same advice from the ox, and from the bee, and of course believed that she had been always doing "her duty." But the most interesting interview recorded in the volume, of her history, is that between the owl and the cat—where the bird of Pallas tells her among other things to "meditate," and the cat repeats her desire of learning how to be happy—and how to perform her "duty."

She also assures the owl, that she loves "meditation," above all other things, only she wants something to meditate about: upon this the owl informs the cat that ever since the moon changed she has been "meditating" on one subject.

"From the beginning" (she says) "our race have been considering which first existed, the owl or the egg. The owl comes from the egg, but likewise the egg from the owl."

"Mercy!" said the cat.

"From sunrise to sunset, I ponder on it, O cat! When I reflect on the beauty of the complete owl, I think that must have been first, as the cause is greater than the effect; when I remember my own childhood, I incline the other way."

"Well, but how are we to find out?" said the cat.

"Find out," said the owl. "We can never find out. The beauty of the question is, that its solution is impossible. What would become of all our delightful reasonings, O unwise cat! if we were so unhappy as to know?"

"But what in the world is the good of thinking about it if you can't, O owl?"

"My child, that is a foolish question. It is good in order that the thoughts on these things may stimulate wonder. It is in wonder that the owl is great."

"Then you don't know anything at all," said the cat. "What did you sit on Pallas's shoulder for? You must have gone to sleep."

"Your tone is over flippant, cat, for philosophy; the highest of all knowledge, is to know that we know nothing."

The cat made two great arches with her back and her tail.

"Bless the mother that laid you," said she; "you were dropped by mistake in a goose's nest. You won't do. I don't know much; but I am not such a creature as you, any how—A great white thing."

The mingled philosophy and satire of this, speaks for itself. We will leave it to our readers to accompany the cat during the remainder of her pilgrimage; but it is a pleasure we rarely enjoy to introduce such an original dialogue as that between the owl and the cat to our friends, even at Christmas time.

In the name of the public—the younger portion of it more especially—we thank Mr. Froude for what any one but himself will consider a condescension: it is pleasant to see the philo-

sopher in a gamesome mood, leaving the study-chair and gambling with children on the carpet, giving joy to those who are feeling the way of first footsteps in life. The historian will be often, no doubt, otherwise occupied—seldom better.

CHURCH DESIGNS FOR CONGREGATIONS: ITS DEVELOPMENTS AND POSSIBILITIES. With Nineteen Plates. By J. CUBITT, Architect. Published by SMITH, ELDER, & CO.

This is an age when ecclesiastical architecture in many diversified forms is, to use an ordinary phrase, "in full play." Churchmen are building edifices for public worship in every new locality; and Nonconformists are erecting chapels which, in outward appearance, differ in little or no respect from those built by Churchmen. Towers and spires rise up both in old and new localities; and sacred edifices which show neither the one nor the other contribute their quota to the general aggregate. Still, in the opinion of Mr. Cubitt, "The Art of building satisfactory churches is one that yet remains to be perfected. It is one, in fact, that has only begun to be studied seriously within the last few years. Until very recently, nearly all our religious architecture, whether Protestant or Catholic, Anglican or Nonconformist, has been a development or a repetition of one single idea. The style may have varied, its artistic merit may have been great or small; but its arrangement, with few exceptions, has all been based on the same type. The essence of this type is a nave with aisles; in other words, a space for the congregation, divided into parallel avenues by rows of columns."

It is obvious that this method of building is in many respects disadvantageous both to minister and people, by excluding the former from the sight of a large number of his hearers, most, if not all, of whom have a wish to see the person of him to whose voice they are listening; and there are few public speakers, especially clergymen, who do not like to have their auditors within their view. "What, then, is to be done?" asks Mr. Cubitt; "to build column churches unfitted for their purpose, or thin column ones unworthy of their destination?" Neither; but to step out of the enchanted circle of habit and precedent in which we go round and round and get no further, to break through "the tyranny of custom, and to find a type in which architecture and practical utility are not incompatible. Such a type does not present itself in the ordinary nave and aisles plan, whether its nave piers are thick or thin. But it may be hopefully sought for in either of these two ways—by designing our churches without columns at all, or by designing them with substantial columns placed where they will cause no obstruction."

This last passage is the key-note of the volume before us, the foundation of which was laid in a series of papers published somewhat recently in the *Building News*. The subject is one belonging more especially to the organs of the architectural profession. It must suffice for us to remark, that Mr. Cubitt's object, which is to show how character and fitness may be combined in designs for churches, is fully and ably discussed, and elucidated by a large number of illustrated examples of existing edifices and of ground-plans.

BUDS AND FLOWERS. By MARY HOWITT. Published by NELSON AND SONS.

It is always a pleasant task to notice a book from the pen of Mary Howitt. Not alone for its intrinsic worth, its pure, moral teaching, its high religious tone—never oppressive, but ever charitable: there is in all the estimable lady writes a taste and tact that may aid, most beneficially, to form young minds and make the study of literature a graceful as well as a happy occupation. Her "style" is always sound—refined, yet forcible: few works for the young can be put into such hands with greater certainty of beneficial results. There is no living author whose writings for children may be placed before them with more entire confidence. The book is a volume of poems: it

consists of fifty compositions of great beauty; some of them, indeed, may be classed among the best compositions in our language. We might quote many that would bear out this high praise; while there is no one of them that will not be read with delight by young or old.

Each poem has at least one illustration: altogether the charming book contains eighty-seven engravings, from drawings by "H. Giacomelli,"—an artist with whom we were made acquainted by his Art-accompaniments to the "The Bird," by Michelet. They are very varied in character; birds and flowers being in all cases the groundwork of the design. They are admirably drawn, and very skilfully engraved.

WONDERFUL STORIES FROM NORTHERN LANDS. By JULIA GODDARD. Published by LONGMAN & CO.

A very interesting book, mainly designed for children, but by no means exclusively for them. The stories of the brothers Grimm are sufficiently familiar: these now before us are from less-known writers, but of, at least, equal value. Fairy tales will always be attractive, especially when they are, as they are here, admirably illustrated by Art; moreover, it is certain that the fairy-lore of England, Ireland, Scotland, and Wales, is, for the most part, a bequest of our Scandinavian ancestors. We thank the author of this volume for an addition to imaginative literature of much worth.

IN THE EASTERN SEAS; or, the Regions of the Bird of Paradise. By W. H. G. KINGSTON. Published by NELSON AND SONS.

Boys are much indebted to this prolific writer: he caters well for their enjoyment and instruction: frequent travel in many lands has given him much knowledge: he dispenses it wisely and well, never leading astray by misdirection or wrong excitement, but always interesting his readers in a skilfully-told tale, combining pleasure with instruction. This gracefully bound, printed, and largely illustrated volume is among the best examples of an author ever usefully employed when he gathers and arranges materials to gladden and benefit the young.

THE STORY OF SIR RICHARD WHITTINGTON. Written and Illustrated by T. CARR. Published by LONGMAN & CO.

The poet and the artist are one: the work of both is well done; so, indeed, is that of the printer. The graceful volume is in old English type, and has been produced at much cost: it is one of the books *de luxe*, which are scarcely expected to be profitable—which are, indeed, "labours of love." The illustrations are in outline; skilfully drawn, and composed with judgment and taste: they are excellent works of Art. The story of good Sir Richard—"thrice Lord Mayor of London"—is told in verse, in the style of the ancient ballad-makers—a style by no means so easy as it seems. It is, in truth, very difficult to preserve their simplicity without degenerating into puerility. Mr. Carr has succeeded better than most of those modern imitators: we might have read it as a production of two centuries ago: and that is saying much. In a prose preface he gives us all that history and tradition have preserved of the great and good Lord Mayor of London.

The book is, therefore, a pleasant and very elegant book of the season.

CHRISTMAS AND THE NEW YEAR IN MANY LANDS. By W. H. CREMER, Jun.

Though the Season has past, the young will see many more days of Christmas and the New Year, and will very often visit Mr. Cremer—from whose well-known establishment this pretty little book issues. It is brief, but comprehensive, and will teach boys and girls much they desire to know, and ought to know: they will be gratified to learn how the great festivals are commemorated in other countries; and thus enhance their pleasure while enjoying their own. Every page is illustrated by an agreeable and explanatory wood-cut.

THE ART-JOURNAL.



LONDON: MARCH 1, 1871.

INDIAN ARCHITECTURE.

THE EASTERN GATE OF THE SANCHI TOPE, BHOPAL, CENTRAL INDIA.



Length something like systematic attention appears to be about to be paid to the archaeology of our Indian Empire; for in spite of the efforts of Mr. James Prinsep, and Mr. J. Fergusson, F.R.S., more than forty years ago, it is surprising how

little is really known about even the leading characteristic of Indian architecture. The death of the first-named gentleman at a time when he may be said to have fairly laid the foundation for a systematic inquiry into, and record of, the great excavated and constructed temples of the East, was a misfortune; and although Mr. Fergusson, happily still spared, and among us, took up the work with great energy and intelligence, and, so far as his own efforts were concerned, with distinguished success, many difficulties have beset the question, and among the most insurmountable was that of obtaining really accurate representations of the great works of the architects and sculptors of India. Happily, of late years, photography has been the means of overcoming this difficulty, with a success, too, unsurpassed probably in any other similar field of operation. The military authorities, and especially those connected with the corps of Royal Engineers and Royal Artillery, have taken up the question, and a series of sun-pictures by various hands have been produced, which in themselves are startling evidence of the wonderful character of many of the existing edifices anterior to, and coeval with, the commencement of the Christian era. A series of these photographs is to be seen, thanks to the liberality of the lenders, in the Oriental Cloister at the South Kensington Museum.

Recently the India Board has directed the organisation of an archaeological survey of Hindostan, and Major-General Cunningham, R.E., has been appointed to its direction. This officer's knowledge of the subject—now thought important enough to be systematically investigated—and his literary efforts to popularise and explain the bearing of Indian archaeology on the past history of the country, are the best proofs of his fitness for the task assigned to him, and also good evidence that the work will be done in no perfunctory spirit.

The rise of Buddhism in the sixth century B.C. led to the construction of some very remarkable examples of Indian architecture, and among these best known and preserved is the Sanchi Tope at Bilsah, Bhopal, in Central India.

Major-General Cunningham, R.E., says: "A Tope is properly a religious edifice dedicated emphatically to Buddha; that is, either to the Celestial *Adi Buddha*, the Great First Cause of all things, or to one of his emanations, the *Mánushi*, or 'Mortal' Buddhas, of whom the most celebrated and the only historical one is

Sákya Muni, who died B.C. 543." He also divides the Topes into three distinct kinds: * "First, the *Dedicatory*, which was consecrated to the supreme Buddha; second, the strictly *Funereal*, which contained the ashes of the dead; and third, the *Memorial*, which was built in celebrated spots."

The probability is that the great Tope at Sanchi belongs to the second class, as the distinguishing symbol of the first class, the representation of *two eyes*, is wanting. Mr. Fergusson's work on *Tree and Serpent Worship*, and Colonel Maisey's descriptions and lithographed sketches of the details of this remarkable structure at Sanchi, together with the series of admirable photographs by which the work is illustrated, has rendered the great Tope and its adjuncts—for there is a smaller one not far distant—tolerably familiar to those interested in the archaeology of India. This monument is now brought before the students of Hindoo design in a still more practical manner by the execution of a plaster cast of the Eastern Gate (Fig. 1), in the Kensington Museum, which it is intended shall be first publicly exhibited, with

other reproductions of that institution, in the International Exhibition of 1871. The work has been effected in a most satisfactory manner by a trained corps of sappers of the Royal Engineers and a body of nine native workmen, under the direction of Lieut. H. H. Cole, R.E., Superintendent of the Archaeological Survey of India, North Western Provinces. The expedition was a novel one, as the nature of the operations to be got through involved much forethought and care, especially as to the season and the time within which the work could be accomplished. The party left Calcutta on December 10th, 1869, and Jubbulpore on the 13th. Here sixty bullock-carts were procured, in which the materials, tools, plaster of Paris, &c., in all a weight of 28 tons, had to be transported to the place of destination, 180 miles distant. Sanchi was reached on January 7th, 1870, and the work was at once commenced. The cast was completed on February 21st; and, being packed in suitable sections, arrived at Liverpool early in June last, *via* Hoshungabad, Bombay, and Suez Canal. Three copies were then made at South Kensington by the month of October, and

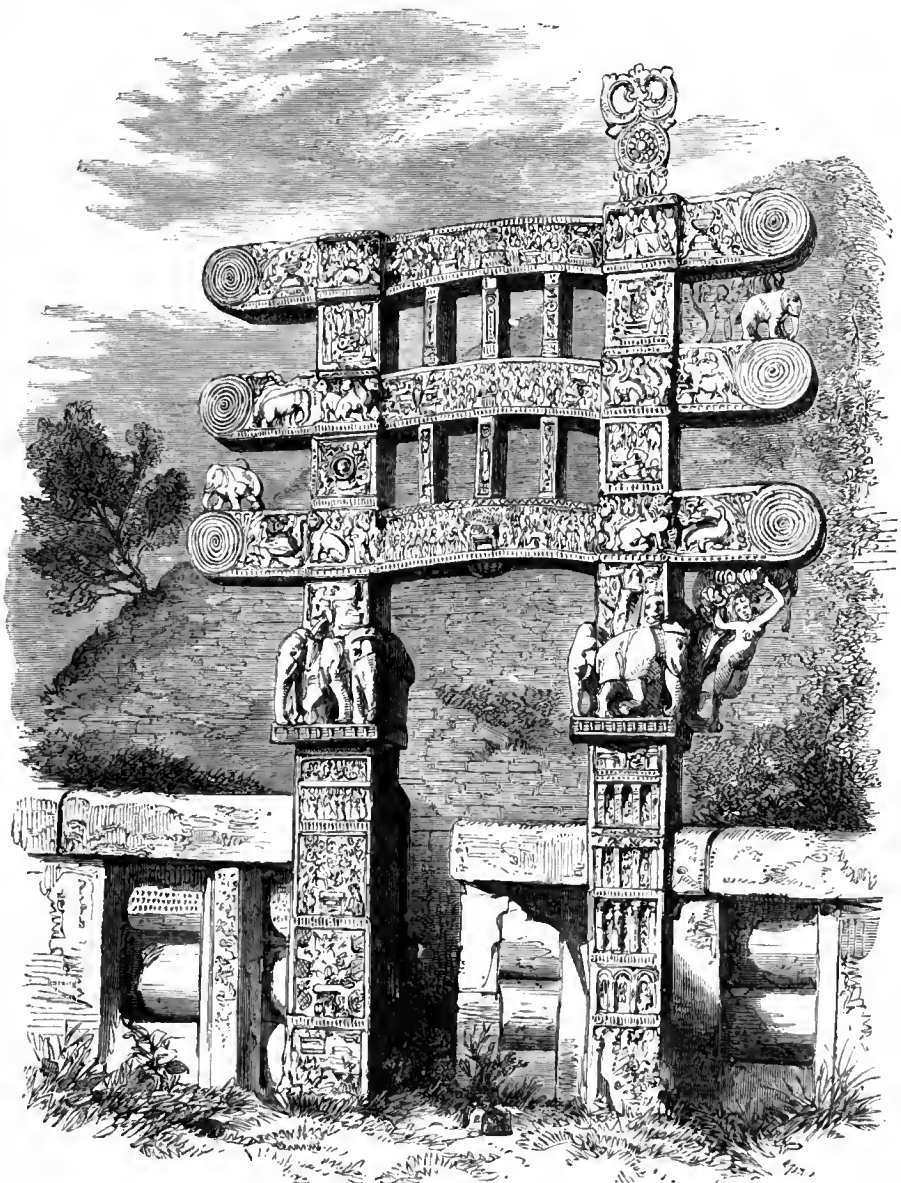

Fig. 1.

one of these was erected experimentally in a portion of the Museum, preparatory to its being placed in the forthcoming Exhibition.

The Tope itself is situated at the top of a sandstone hill about 300 feet above Sanchi.

The great body of the structure is a solid dome of stucco and brick, 121 feet in diameter and 62 feet in height. It is surrounded by a stone-railing 8 feet in height, placed at a distance of 9 feet 6 inches, and four stone-gateways corresponding to the cardinal points of the compass. Each gate is 33 feet high, and 11 feet 9 inches

* "The Bilsah Topes," page 7.

* *Ibid*, page 12.

in width to the outside of the side pillars. A small model at the South Kensington Museum gives a pretty accurate notion of the general proportions of the structure.* The railing is 8 feet 8 inches high, the vertical stones being 2 feet apart. The date is somewhat variously stated. Mr. Fergusson maintains that no stone structure is to be found in India of an earlier date than the reign of Asoka, about 280 years B.C., when Buddhism became the state religion. It had existed 300 years, the prophet Sákya Muni, subsequently known as Buddha, having died in 543 B.C., after having so far established the faith which bears the name of Buddhism among the aboriginal races as finally to bring within its influence the whole of Northern India. General Cunningham gives the date of the Dome of the Tope as about 500 B.C.; the stone railing has been assumed to belong to about 250 B.C.; and the gateways, with which our present interest lies, at from 19 to 37



Fig. 2.

of the Christian era. Mr. Fergusson, however, sets it down at probably about 50 A.D.

Nothing to our mind indicates the origin of early Indian architecture from a wood-constructive type more completely than these gates. Indeed, our conviction is, that they must have been executed in stone, to replace previous structures of wood, which, probably, like the railings, had decayed; and were being constructed of the more durable material, with possibly such improvements in detail as the practice and experience of the sculptors enabled them to introduce. The more closely the cast of the Eastern Gate now under consideration is examined, the greater the conviction becomes that the carving, as well as the structure, is based upon the treatment of the more easily wrought substance. In fact, all aboriginal races commence their efforts in sculpture by carving in wood, quite as much as they base their architectural constructions in stone on the more primitive erections in the

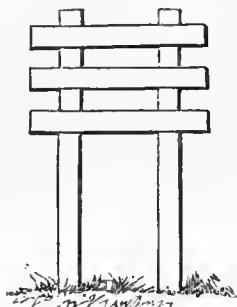

Fig. 3.

less durable, but more manageable and more easily procured, material.

As will be seen by the first illustration † here introduced, the Eastern Gate, like the other three, consists of two square pillars, which are crossed at the required height by three lintels, or architraves, all of which overhang the supporting columns on each side. The lintels are

* In the model, which is in soap-stone, and made by native draughtsmen from drawings executed during the recent survey, an important detail has been left out. Mr. Fergusson in his "History of Architecture," Vol. II., and in "Tree and Serpent Worship in India," states that on the top of the Tope is a flat space about 34 feet in diameter, formerly surrounded by a stone railing; and in the centre once stood a feature known in Indian architecture as a Tee (Fig. 2).

† From a photograph by Lieut. Waterton, R.A.

slightly curved in the middle, and suggest the structure of an arch. They are terminated at each end by a spiral, or species of volute. In all probability the wooden type was simply constructed of two uprights formed of two trees properly squared to admit of decoration, and the three cross pieces "halved" into the vertical posts at the angles of union, also properly squared (Fig. 3). Nothing could possibly be more

primitive, and yet few structures would be more suggestive of, or better adapted to, decoration. The stone railing suggests precisely the same origin; and the Tope itself might originally have been simply a comparatively small mound of earth, in fact a *tumulus*, or *barrow*, the introduction of which as a place of sepulture in the West has been attributed to Buddhist priests.* Thus, if some of the Topes of the East are, as

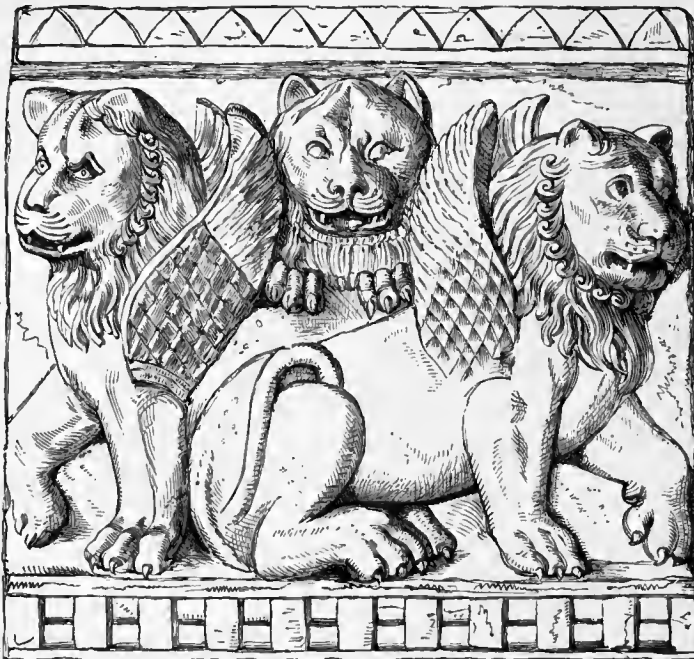

Fig. 4.

traditionally stated, the burial places of Buddhist saints—and the great Tope at Sanchi was especially sacred from its antiquity—it is by no means improbable that Asoka may have converted the earthy tumulus, or barrow, into a brick and cement Tope; and its date in this form may, as Mr. Fergusson suggests, not be earlier than 250 B.C. The interior, to a great depth, is composed of brick and earth; the outer

covering of stucco having been originally about four inches in thickness.

It is generally supposed that the Eastern Gate, with which we have now specifically to deal, is the most modern of the four gates, and that the southern one is the most ancient; but it is impossible to define the difference in date. The southern was probably the first constructed, from the fact that a flight of steps, or the

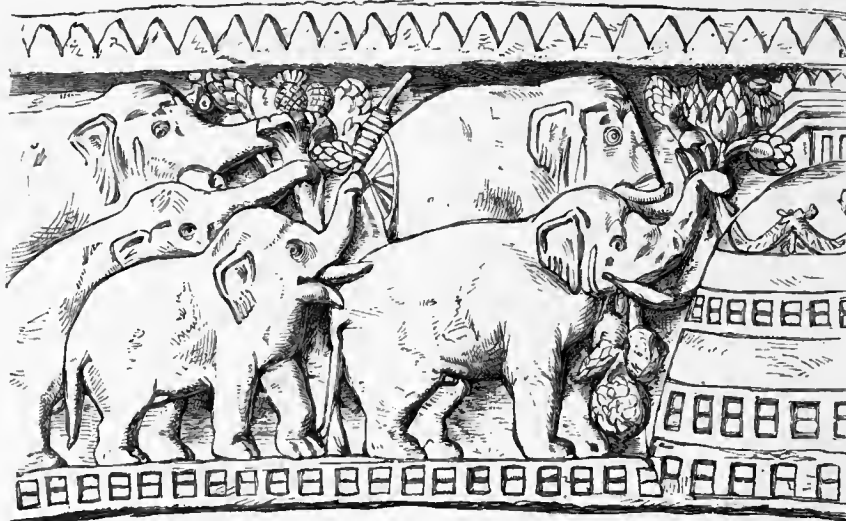

Fig. 5.

remains of them, indicates that it was at least the principal entrance, and therefore the one first erected; and even if the whole series replaced others in wood, still the southern one would, in the circumstances named, be the first of the more permanent structures. Colonel Maisey, however, states as a proof of its probable priority, that "it appears to have been the only gateway for a long period: its pillars are different in style to the others, and the

buildings and sculptures struck me as having served as models for the other gates, which, though evidently the work of superior artists, have not so original an appearance." In spite of this we are inclined to adhere to our theory

* The Druids of the British Isles, worshipping in groves of oak. Thus became, in fact, tree-temples, if not trees, objects of worship, for the oak was the sacred tree of the West.

of primitive structures in gates and rail as types of the more permanent erections of a later age, when Buddhism had been adopted as the state religion under Asoka; for the object would then be to render the shrines of the adopted faith as permanent as possible: first the mound itself, then the fence, and finally the gates, the decorations of which symbolised the ritual of Buddha, and permanently illustrated the purpose to which the Tope itself was dedicated.

Whatever the corruptions of Buddhism may have led its devotees to adopt as objects of worship at a later period—as shown in the Tope at Amravati, ascribed to the period reaching from the fourth to the sixth centuries of the Christian era, when serpent-worship largely prevailed—it is very evident that at Sanchi the chief objects were the Tree and Dagoba, or Tope, as there are very few indications of the recognition of the serpent to be found in the sculptured details of the Sanchi gates. The Wheel, however, which represented the Law, was also an object of some consideration—possibly of adoration; and Mr. Fergusson states that this was the third object of worship, and that a sculptured wheel surmounted, and was the central ornament at the top of, each gate. The Chakra, or wheel, is also supposed to represent Dharma, the second member of the Buddhist Triad. On each side of the wheel, and in the position of a finial to the pillars, the Trioul ornament was placed. This is supposed to contain within its construction the symbols of the five elements, or the material universe—earth, water, fire, wind, and ether, represented primarily by the square, circle, triangle, crescent, and cone.*

The two pillars are fully decorated in the front and on the sides, and partially at the back; but this being next to the Tope itself has the lower portions hidden by the stone-railing, or fence, and only one compartment, or *bas-relief*, is seen on each side. On the right-hand pillar is the representation of a Dagoba, and on the left the Sacred Tree—as already stated, the principal objects of worship at Sanchi. The front surfaces are covered with reliefs of a most interesting character, representing ritualistic and domestic scenes. The two races, Hindoo and Dasyu, are each represented and fairly contrasted with each other. Some of the scenes depicted can only be intended to represent some phase of the natural or merely corporeal life of man. Others as evidently aim at depicting a higher condition of being, and run distinctly into the positively religious life. Sometimes men alone are represented, at others men and women; then animal and vegetable life is mingled with these, or take their place as the most essential features of the subject. Water with water-plants, aquatic fowls and fish, the rude boat of the Dasyus, in one instance contrasted with the artistically-constructed barge of state, so to speak, of the Hindoos in another.

The inner faces of the pillars have each a relief of a single figure in strong projection at the base, about half life-size, representing a warder, or guardian of the entrance, in full costume.

In the right-hand pillar, the whole space above the warder, with the exception of a small panel at the top, in which is represented tree-worship, is occupied by a very remarkable relief practically divided into four stages, or parts, which represents events in the life of Śākya Muna. The upper division, or stage, gives a vision of the annunciation of Buddha; while the lower one represents the prince, at the age of twenty-nine, putting away his robes of state, and taking the dress of an ascetic, in order to begin the mission which he only accomplished after fifty-one years of labour and self-denial. The other scenes are not so easily understood, but evidently refer to Śākya Muni's ordinary life as Prince Siddhārtha. The reliefs in the inner face of the left-hand pillar—above the warder, of course—are various, and evidently of a domestic, rather than mythological, character. The upper one seems especially illustrative of the manners, habits, and customs of the Hindoos in the first century of the Christian era. The third compartment, however, is remarkable

as giving a representation of a regular Chiaitya, or Tope, as dedicated to *Adi Buddha*, the Great First Cause, or Celestial Buddha. These Topes, as already remarked, are distinguished from those dedicated to the Mānūshi, or "Mortal" Buddhas, by having the symbol of two eyes carved upon them; and in the representation of the Tope in the compartment above named the two eyes appear, one above the other.

The outside face of each pillar is decorated with architectural ornaments consisting of lotus

flowers, &c.; that on the left-hand pillar having a scroll running through which issues from the mouth of a crocodile at the base. The decorations on the right-hand pillar are of a more purely geometric character, admirably arranged and executed, and worthy of close study as an ornamental composition.

On a line with the capitals which surmount the pillars, and in the angle formed by the projection of the lowest lintel, were two spandril or bracket-like perforated compositions, consisting of a statue of a female, small life-sized,

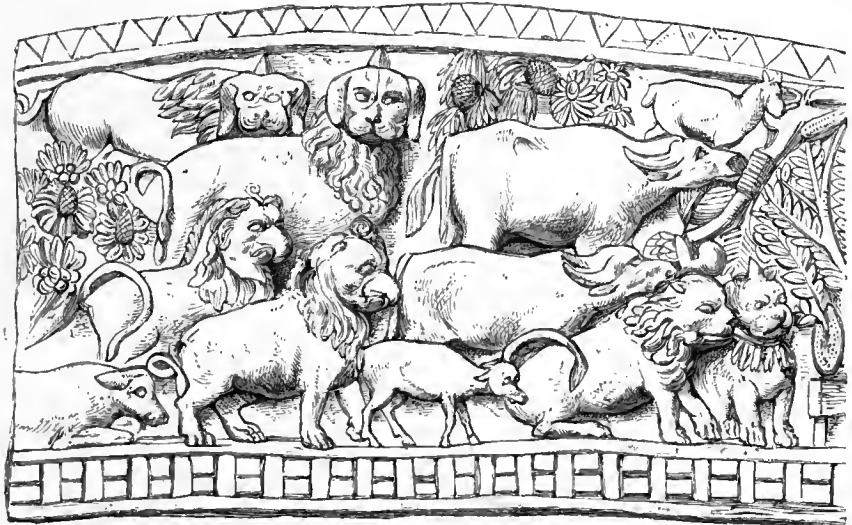

Fig. 6.

overshadowed by a tree. The feet of the figure rest against the lower part of the capital, and it leans outward in a diagonal line; the one arm being uplifted above the head with the hand holding the branches of the tree; the other arm is passed through a wreath suspended to the tree, and the body thus swings from the feet and the canopy of foliage. The figure is suggestive of Eve, and probably represents the universal mother, in the Buddhist sense; possibly in a higher degree than Cybèle represented the earth in the Greek mythology. Only one of these figures remains in the Eastern Gate, and

thus only one is reproduced in the cast; it is a work of great vigour and artistic skill.

Each of the columns is surmounted by a square capital composed of elephants so grouped as to bring the heads of the animals to the angles. Figures of men riding on the elephants, and bearing trophies and banners, form the decorations of the surfaces of the square blocks above the capitals. In the wonderful and life-like execution of these elephants, the peculiar excellence of the sculptures of this gateway is illustrated in a remarkable manner. In fact, one feels that no representation of an elephant by

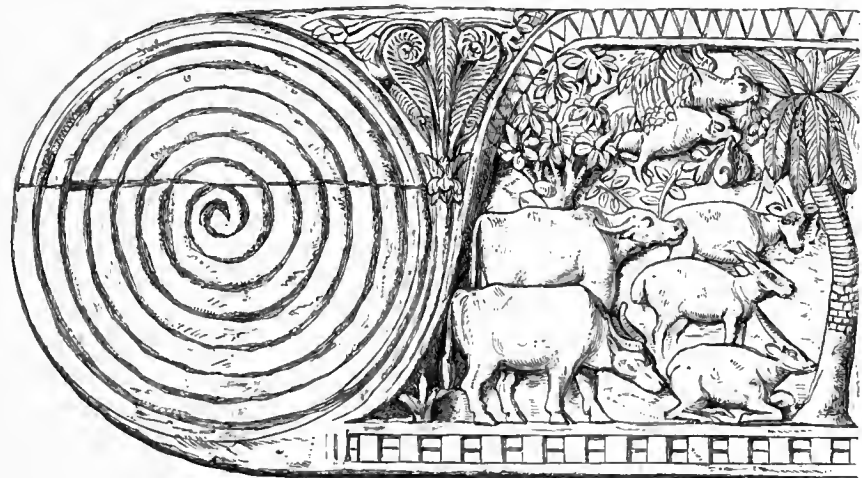

Fig. 7.

any Western artist will bear the slightest comparison with these first-century Oriental stone-carvings. The truth of form, the character in the texture of the body, and the movement of the limbs; above all, the pendulous, but flexible and delicately prehensile characteristics of the trunk—are so peculiar, that at first sight they convey a certain undefined impression of having been cast from nature; but the artistic vitality, so to speak, contradicts this idea as quickly as it is suggested.

One of the first principles of the great moral

code of Buddhism is kindness to animals, and a tender interest in all created beings. This, no doubt, arises out of, or is conformed by, an essential doctrine of the faith, the metempsychosis. In the sculptures of the Sanchi Gates the various phases of animal life in connection with the worship of the Tree and Dagoba, or Tope, are very fully shown. The character and expression of some of the creatures represented is very far beyond the technical representations of the same animals in modern Art; and, strange to say, in spite of the great skill shown in the

* See Fergusson's "Tree and Serpent Worship," p. 106.

latter in the imitation of nature, very much less conventional. These Hindoo sculptures are simple and loving attempts to depict nature in an unsophisticated form. The elephants at once express power and intelligence, not mere size and unworldliness. The cattle low, and the deer appear to move with a gentle grace. The birds soar with energy, and the representations of the peacock express vigour and elegance, without affectation.

With these general remarks upon the leading characteristics of the sculptures of animal-life, we shall be able to make more clear the chief features of the decorations of the stone lintels, and the subordinate, but sustaining, details of the upper portion of the Eastern Gate as shown in the reproduction.

In the central portion of the front of the lowest lintel, or architrave, is a relief representing tree-worship. A procession of musicians and worshippers moves along bearing offerings of flowers, standards, &c., of which the limits of this paper will not permit a detailed description. This, however, would be comparatively useless without an attempt to interpret its meaning. Artistically the result is similar to the decorations of the pillars. On each side of this relief are square blocks in a line with the axis of each pillar and its capital. These are embellished

with a group of three winged lions interlaced, as shown in the illustration (Fig. 4). Admirably composed and treated, they are eminently characteristic of the style of similar details and symbolical decorations in other parts of the gate. As composite creatures, they are treated conventionally rather than naturally, and form a contrast to the manner in which the elephants, oxen, and deer are executed. The spaces between these blocks and the spiral, or volute, which terminates each end of the lintel are filled with quaint, but elegantly treated, reliefs of peacocks and trees. The spirals are of the same character in each lintel. They are ascending spirals of seven or eight convolutions. All issue from a floriated trefoil starting point, spreading from the upper line of the lintel. They have, therefore, a different character to the Greek volute, which is a descending spiral.*

The back of the lower lintel, next the Tope, is a very interesting artistic example of the treatment of the elephant. It represents two groups of elephants, of which the illustration gives one; that nearest to the right-hand pillar. These elephants are bringing offerings of branches of trees to the Dagoba, or Tope, which is placed in the centre of the lintel, in the position of a key-stone to the slightly arched line of the architrave (Fig. 5). The action of these

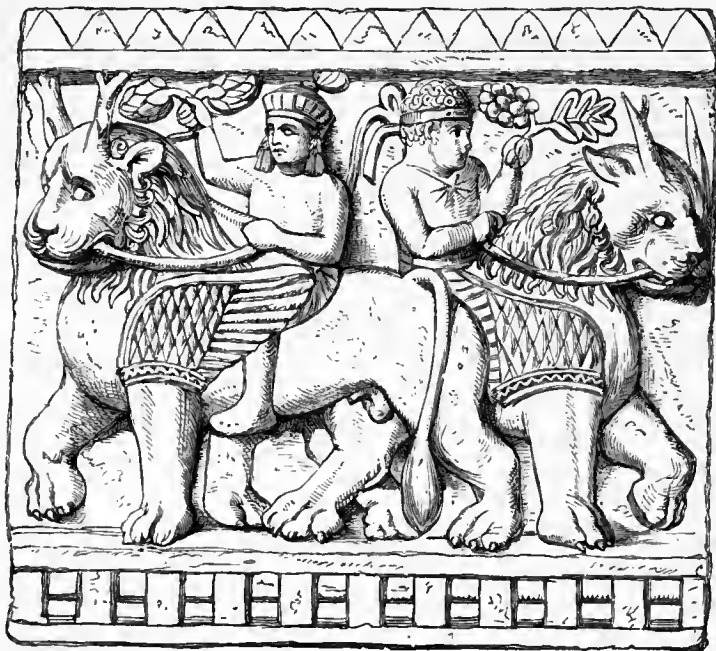

Fig. 8.

animals is vigorous and characteristic, and the execution in the original especially excellent. The relief on the block on each side, corresponding to that in which the winged lions are carved, is composed of a species of lama having pendulous ears. Both pairs are recumbent and have riders upon their backs, the heads being so arranged as to balance each other, and form a symmetrical decoration. The space between those intermediate blocks and the spirals are filled with elephants, as a continuation of the central group.

The middle lintel has on the front a relief representing tree-worship, the sacred tree being the central object. A city, with its buildings and walls crowded with people, occupies the left of the tree; and on the right are praying figures, and the footmarks of Buddha. Richly-caparisoned led horses, evidently objects of worship, are distributed through the work. The intermediate blocks, on a level with this lintel, are decorated with a repetition of the three winged lions, or at least a composition which has all the effect of a repetition; and the spaces between them and the terminal spirals are filled with elephants and trees, the animals being executed with more than the average skill shown in other parts of the gateway. The elephant connected with the right-hand

pillar is frolicking, trunk in the air, with remarkable energy in front of the tree; some floating figures, being in the background. His riders are falling off through the exuberance of his saltatory movements, which are really as graceful as it is possible to expect in a creature so heavy in form and so massive in its muscular system. The corresponding elephant, on the opposite side, next to the left-hand pillar, is probably the most perfect example of animal life in the whole work. The form and texture of the creature is perfect.

The relief at the back of this middle lintel is the most remarkable composition in this gateway, and Mr. Fergusson considers it the most curious at Sanchi.†

In the centre is the sacred tree, and this is the object of the worship of "all the beasts of the field," and one may almost add "the cattle on a thousand hills," so strikingly does it bring the latter expression to mind. The savage animals—lions, &c.—with certain composite creatures—lions with eagle's heads—

* This peculiarity is mentioned here, as an attempt will be made to interpret the religious meaning of many of the details at a more suitable opportunity; this not being a suitable theme for the *Art-Journal*.
† "Tree and Serpent Worship," page 104.

occupy the lower line; then come oxen, buffalo, and deer; and in the upper line rams, sheep, and the more gentle creatures, some of the sheep having human faces (Fig. 6). But the most notable feature is a representation of the Naga, or five-headed serpent, not as an object of worship, but as himself a worshipper of the tree. Mr. Fergusson says: "It does seem strange that a god who everywhere else is worshipped should here be represented as worshipping, and not a human or celestial god, but a tree. It is evident we are still far removed from the supremacy which the serpent afterwards assumed at Amravati." In fact we see here the difference between the purer form of Buddhism in the first century, and that which prevailed in the fourth, fifth, and sixth centuries of the Christian era.

The blocks on each side are decorated reliefs of two kneeling Bactrian camels, the heads balancing each other outwardly, so as to produce a symmetrical composition; the riders forming a central group. This is considered good evidence of intercourse with Central Asia, as the animal is now unknown in India; but it is uncertain whether the two-humped camel was used as a beast of burden in that country at the period when the Sanchi Topi was erected. The spaces between the intermediate block and the spiral are filled with reliefs of cattle, deer, trees, &c. (Fig. 7), in continuation of the central subject.

The topmost lintel is decorated in front with a representation of tree and Dagoba worship; two trees and five Dagoas occupying the whole length of the lintel, except the portions on which the spirals are carved. Two trees and three Dagoas occupy the central space, and are hung with garlands, floating figures being represented above the worshippers which stand between them. A Dagoba with similar accompaniments occupies the interspace between the block and the spiral on each side. The blocks are decorated with reliefs of horned oxen, richly caparisoned, and kneeling, with riders upon their backs, the heads being turned outwards, and they thus balance each other on the vertical line. This is stated by Mr. Fergusson to be the same subject as that on the front of the top lintel of the northern gateway.

The back of the lintel, just described, has a relief representation of tree-worship only, continued along the whole surface to the spirals on each side. There are seven trees, each of a different species. All, however, are equally objects of adoration, and therefore may this be considered as good evidence that the *ficus religiosa* was not the only sacred tree in the Buddhist system. All the worshippers here are human, none of the lower animals being represented in either of the reliefs which embellish the topmost lintel of the gateway, except in the intermediate blocks. Those of the front, as already stated, have representations of horned oxen; which, it may be as well to observe here, suggest in a very marked manner the sacred ox of the Hindoos, as frequently represented in other sculptures. Each relief at the back, and in connection with the tree-worship only, consists of horned and winged lions, moving with riders on their backs, as shown in the illustration (Fig. 8). These are treated with great dignity, and the carving is executed with much spirit and skill.

Above the topmost lintel, as already stated, the chief decorations were the Wheel, in the centre, and the Trisul, over each pillar. Only one Trisul remains complete in the reproduction of the Eastern Gate for the South Kensington Museum. Between each lintel in the central portion are three upright stones at equal distances, thus dividing the interspaces into six compartments, which are now empty; but on consulting a photograph of the northern gateway we have evidence that they were filled up with suitable decorative emblems, of a character analogous to those described as embellishing the other members of the eastern gateway. Statues of elephants and horses, duly caparisoned, with riders upon their backs, occupy the interspaces in the northern gateway, producing a rich effect in the mass of well-arranged ornament, thus forming the triad of the structure.

* "Tree and Serpent Worship," page 104.

There are intermediate portions of the two pillars between each lintel, and consequently between blocks already described. These are decorated with symbolical subjects in much lower relief than the blocks on a level with the lintels, and these blocks are thus made to contrast with the lintels themselves.

The subject in the space between the lowest and the middle lintel is evidently the wheel surmounted by a Chatra, or umbrella ornament, festooned with garlands, and with worshippers on each side. The corresponding space on the right-hand pillar is filled with a decorative and symmetrical arrangement of two elephants with a seated figure between them. The other two spaces between the middle and topmost lintel are decorated with subjects of an analogous character.

The overhanging portions of the lintels on each side are bare in the reproduction, with the exception of a statue of an elephant in the projection next to the left-hand pillar; and the middle lintel has a similar statue on the corresponding part, next to the right-hand column, with the fragments of the statue of a female figure, tree, &c., between the elephant and the vertical line of the pillar.

On again referring to the photograph of the northern gateway, lions seated on their hind-quarters, and looking eastward from the centre-line of the structure, are found to occupy the same position as the elephants in the reproduction of the Eastern Gate—that is, immediately over the spirals of all the lintels; and the spaces between the back of the lion and the line of the pillar are filled with perforated reliefs of a similar character to the fragments in the Eastern Gate—a female figure, tree, &c.: in fact, a repetition, in small, of the subject which forms the bracket-like composition, filling the angle of the projection of the lowest lintel and the capital.

To the artist, the architect, the antiquary, the ethnologist, the historian, and the theologian, this reproduction of a work at once so complicated, yet so simple—so old, yet so fresh and vigorous in its leading patterns—cannot fail to be of great interest. One source of surprise, as of congratulation, is the perfect state in which the carvings have come down to our day; for the original is executed in a compact red sandstone, which might have been expected to crumble to pieces generations ago.

The meaning of the work, its true purpose, the lessons it preached, and the ritual it taught, nineteen centuries ago, can probably never be read in their integrity. Possibly the true interpretation of the early chapters of Genesis may be the true interpretation of the symbolism of this gateway. Who shall read it? It is easier to answer who shall not! Those who insist that the book of Genesis treats of the same subject as the science of geology, to the overthrow of the facts of the latter, or who forget that the Book of Books should be read in the light of its Divine Author, and not by the infinitesimal rutilight of their wits, will never see more in this work than gross Paganism and a blind and degraded idolatry.

Trees, serpents, and temples—for Topes were centres of worship—are not altogether without their meaning in the Word of God. The primitive and degraded use, the materialistic and senseless interpretation of the pure symbolism of the child-period of mankind, never destroys its meaning. The serpent, as the "most subtle of all beasts," is not without a parallel in these latter days. There is nothing so pure or so good, so wise or so true, but the activity of the spirit it symbolises can degrade and ultimately destroy. Nor can the trees of the first and the last books of the Bible—Genesis and Revelation—be forgotten. In the latter, the leaves of certain trees "were for the healing of the nations:" a type, the true meaning of which a materialistic,* earth-crawling, and dust-eating age has as little conception as the serpent-worshipper of other times had of the religion which had become degraded by the pride of self-derived intelligence, and the love of dominion in its unworthy professors.

GEORGE WALLIS.

* "On thy belly shalt thou go, and dust shalt thou eat."—GENESIS iii. 14.

SIR M. D. WYATT ON FINE ART.*

THE volume before us is the second which the munificent bequest of Mr. Felix Slade has been the means of adding to the literature of the Fine Arts. Mr. Ruskin, the Slade Professor at Oxford, has already given to the world some of his lectures delivered in that city; and Sir M. D. Wyatt, occupying a like position at Cambridge, now publishes his thirteen lectures on Architecture, Sculpture, and Painting. Each Art is considered under three aspects—history, theory, and practice.† In his introductory lecture, the Professor pointed out that the Arts, which will in future not be neglected at our universities, have, in France, Germany, Switzerland, Italy, and Russia, been systematically cultivated. We are glad to find that the stigma long resting on our great seats of learning in neglecting the cultivation of the Arts—which, at least refine by our appreciation of the beautiful—has been to a great extent removed by the appointment to the Slade professional chairs such men as Dr. Ruskin and Sir Digby Wyatt. Since the latter, in 1836, when only sixteen years of age, gained a prize for an essay from the Architectural Society, he has produced some valuable books, chiefly on the Arts of the mediæval period. Important works in India testify to his architectural ability, and it is impossible to speak too highly of his services in connection with the International Exhibition. We think he made a mistake in not illustrating his lectures by diagrams and drawings. The students at Oxford had the advantages of a series of drawings, photographs, chromolithographs, &c., selected by Mr. Ruskin, and placed for their inspection in the University galleries. Professor Wyatt's large experience—gained, for example, in his travels (1852-4), for typical examples of works of Art to adorn the Crystal Palace—would have been profitably employed in selecting a like series to place before his Cambridge students. He recommends Fergusson's *Beauty in Art* to those who desire to enter more in detail into the study of the stages by which men realise Art-perception. We quite agree with our author when he says: "A cultivation of those Arts ought never, in a highly civilised country, and especially in its universities, which are clearly the foci of its civilisation, to be regarded otherwise than as a most important branch of education; important under at least four aspects; firstly, from the humanising influence which such studies exert upon the student; secondly, from the fact that in proportion to the gravity and preponderance of such studies in the education scheme of the population of a country, results the greater or less excellence of the works of Art produced, either through their agency, or under their correcting judgment; thirdly, because it is impossible to study the principles upon which beauty in the Fine Arts depends, without discovering, gathering up, and storing, knowledge of laws, the action of which will be found to extend from the realms of the Fine Arts, over those cognate branches of literature and science, which naturally form the staple of every most advanced curriculum, such as that adopted in your university; and, fourthly, because one cannot but regard those whom I have the honour of addressing in this room, and such other students as in other places may be favoured with the instruction of my colleagues, but as it were leaven, destined to permeate and influence the general masses of the population of this country, with whatever knowledge of Fine Arts they may acquire through the Slade foundation." Fine Art may be studied for the sense of delight it yields, the spirit of refinement it gives, and that it is man's work of creation.

* FINE ART; a Sketch of its Theory, Practice, and Application to Industry: being a Course of Lectures delivered at Cambridge, in 1870, by M. DIGBY WYATT, M. A., Slade Professor. Published by Macmillan and Co., London.

† According to the terms of the bequest the Professors are bound to deliver a course of not fewer than twelve lectures on the history, theory, and practice of the Fine Arts, delivered in full term, and open to all members of the University free of charge.

"'Tis to create, and in creating live
A being more intense, that man endows
With form his fancy."—Byron.

The lecturer did not aim, by the trenchant onslaughts of a Pugin, or the graceful eloquence of a Ruskin, to advocate the claims of a particular style of architecture with which he was more intimately connected. We look in vain in the work before us for any evidence of violent partisanship. On the contrary, the aim of the Professor seems to be to point out the beauties of the various schools of architecture as impartially as possible. He sees no reason to doubt that the same principles of governance which Mr. Ruskin has laid down for one desiring to excel in the practice of mediæval architecture may have been followed in every particular by the classical architect. He finds "alike in the best examples of Grecian and mediæval architecture, that functional propriety of the parts is never neglected, hidden, nor confused; that each material receives the proportion of substance, bulk, and surface treatment corresponding with physical peculiarities and best methods of technical elaboration. The grille, or candlestick, of the mediæval architect assumes no greater temerity and no more happy variety of metallic treatment than does the candelabrum or tripod of the Greek. The terra-cotta of both exhibits its plastic origin and style of finish. Marble and stone are worked and combined with no less propriety in Grecian than in mediæval Art. There is no doubt greater variety in mediæval Art, but there is no greater propriety. Each style is true to itself, and all that is most majestic in either is common to both." He would have a declaration of peace in the architectural camp, causing the followers of the two armies to walk hand in hand in a joint triumph, and he believes if we unite "the objective practice of Pugin and the mediævalists to the excellent subjective system transmitted to us from classical ages," we shall have no cause to fear for the result.

There are many indications that, had it not been for the rigidly-enforced laws of the Egyptian priesthood, that people would have produced works in sculpture of a higher order of merit. But even when they had the advantage of intercourse with the Greeks, that intercourse did not improve their sculpture, but at that period it rapidly declined. In Assyrian sculpture we have more variety and less conventionality with a direct gain of Art-qualities. The earliest Greek statues were of wood. The Greeks excelled in the practice of selection, or taking from a number of models, the part or feature of each which seemed most elegant, and then skilfully combining them. Their discoveries in science and improvements in philosophy assisted them materially. Roman sculpture falls far short of the Greek, inasmuch as we miss "the triumph of intellectual over physical beauty, and an incorporation of sculpture with architecture has made both perfection." Passing on to mediæval sculpture, its merit appears to consist in the power of enforcing lessons of faith inculcated by the priesthood—elegance gave place to spirituality. Such works as the gates of the Baptistery, at Florence, by Ghiberti, show the surpassing beauty works of this school sometimes attained. Torrigiano infused new life into our sculpture in the reign of Henry VIII. Lord Lindsay has well expressed the Christian theory of sculpture. He says that Nicola Pisano, "in practice at least, if not in theory, first established the principle that the study of nature, corrected by the ideal of the antique, and animated by the spirit of Christianity, personal and social, can alone lead to excellence in Art; each of the three elements of human nature—matter, mind, and spirit—being thus brought into union and co-operation in the service of God, in due relative harmony and subordination. The Siennese school and the Florentine—minds contemplative and dramatic—are alike beholden to it for whatever success has attended their efforts. Like a treble stranded rope, it drags after it the triumphal car of Christian Art! but if either of the strands be broken, if either of the three elements be pursued disjointedly from the other two, the result is, in each respective case, a grossness, pedantry, or weakness." Professor Wyatt points out that the Christian sculptures, aiming at the expres-

sion of perfect beauty, failed to remember that it was only within the limits of human types of form that any such expression could be judiciously conveyed. He sees nothing in the most beautiful sculptural subjects which, however spiritually treated, could not benefit by "the fashioning of the actors in the drama represented into the guise of those perfect types of humanity so laboriously elaborated by the Greek."

Sculptors of all schools are too apt by labour and minute study of the human form to acquire the power of individualising, losing the more admirable one of generalising, so thoroughly attained by the Greeks. In fact, this latter quality was characteristic of the age of Pericles.

Sir Digby Wyatt points out that in Thomas Banks, who worked in the latter part of the eighteenth century, we meet with the first Englishman of taste for poetical sculpture. But real genius in the art may be said to begin, in this country, with Flaxman, and it is lucky we have such an admirable collection of his works. It is a great mistake to think that Flaxman did not care for Gothic sculpture. On the contrary, he was among the first to study the works of Giotto, and of our native sculptors at Wells, &c. His "Lectures on Sculpture" are a valuable contribution to the literature of the subject. In the work before us we have a well-deserved tribute of praise paid to Canova, "whom it is too much the fashion in the present day to decry. Tested by comparison with the antique his style may occasionally appear weak, and his ideas too often find in their embodiment an almost too great appearance of artificiality, but his works, when contrasted with those of his immediate predecessors, stand out as light from darkness. The nature, purity, and beauty of the forms of which he made use, and the simple but most elegant execution of his work, and his refined taste and appreciation for beauty of every class, deservedly stamp all his works with real and unquestionable merit. A man of extraordinary versatility, he laboured in every class of his art. His monuments are frequently well-designed, and he entirely re-created basso-relievo in subordination to the laws of reasonable fitness in such compositions. It is ever to be remembered that he was one of the first, if not the first, to pronounce authoritatively upon the merits of the Elgin marbles; and but for the energy and firmness with which he proclaimed his conviction of the value of these masterpieces, our country might never have retained them for the public good."

It is difficult in the limited space at our disposal to give an adequate idea of the interesting matter contained in the four lectures on Painting, given with Professor Wyatt's usual facility of expression.

Grecian Art reached its acme of perfection in the days of Apelles. In the Archaic paintings of Pompeii we shall find indications of the characteristics of the Grecian as well as of the Roman schools. In these great facility of hand and power of direct imitation are observed. Limited knowledge of perspective was disguised generally by placing the actors in a picture on a nearly uniform plane. When the empire was transferred to Byzantium, both painting and mosaic gained in Orientalism of colour, but lost in graphic power. Formal mosaics on a gold ground covered the vast architectural vaults with little pictorial merit. The movement of innovation in Art which took place in 1000 A.D., Professor Wyatt thinks came from the North, and from native Scandinavian energy. "Both in the Celtic and Frankish races, even while yet unconverted, there asserted itself an individuality of type in ornament which betokened an energy of will and delight in beauty, which, with greater cultivation, could not fail to fructify into individual artistic character under the guise of painting." In Ireland, before this period, we find a wonderful originality, exhibiting itself in a school of miniature-painting, which the Anglo-Saxons imitated.

Cimabue (b. 1240) was the leader of those who altered the formal Greek types, "endowing them with freedom and pictorial grace, reflecting a spiritual liberty of conscience, and faith in a loving and beautiful creed." Our author points out that the domination of Italian over

Greek Art at the commencement of the thirteenth century was contemporaneous with the triumph of Latin over Greek arms in the conquest of Constantinople. Cimabue and Giotto were the founders of the great Florentine school, which reached great excellence through Orcagna, Fra Angelico, Andrea del Sarto, Fra Bartolomeo, to Michael Angelo. The Church has always been the foster-mother of Art, hence the great preponderance of sacred subjects in such schools. Artists of the fifteenth century, by studying remains of classical antiquity, infused improvements in anatomical correctness, and other schools improved other features. In Raffaele we meet with the characteristics of the greatest painters who had preceded him. "It was not the ability and talent of his great master Perugino alone which he embodied in his works, and carried to perfection, but it was all the sublime he could gather from Michael Angelo, the beautiful and correct that he could derive from Leonardo da Vinci; he unites the strength and dignity of the Florentine with the sweetness and purity of the Umbrian school. Upon them he engrafts much of the beautiful tone of colour and aerial perspective of the Venetian school, and he never loses sight of the classical fullness of form and distinctness of composition characteristic of the Paduan."

It is curious that in the Art of printing and painting in oils the utmost perfection was attained in the earliest examples of each Art. The invention of the latter has always been ascribed to John Van Eyck, known in Italy as Giovanni of Bruges. Vasari says it was introduced into Italy by Antonello da Messina about the middle of the fifteenth century. Our National Gallery has a fine example of his genius. At Venice this system of painting tended to the development of the system of painting in translucent colours, and the production of magnificent effects of light and shade. Velasquez seems to Professor Wyatt "to have been the painter who certainly attained the power of representing all that can be seen in the subject of a picture with greater truth and greater feeling than any other artist who ever lived. In the *method* of his pictures he realises perfection, and in his best works there is more solidity when solidity should appear, and more air when air should appear, than I have ever been able to find in the paintings of any other master. Murillo, his great rival, had many noble qualities as a painter and none more transcendent than his power of creating an impression of space and atmosphere. His figures always stand free and detached; they are fully raised and lifted from one another, and from his backgrounds; so that they appear almost as if projected in accordance with the laws of binocular vision."

The foreigners who settled among us taught us the progress which had been made during the fifteenth and sixteenth centuries in Italy, Germany, and Spain, in the Art of painting. With the Coopers and Oliver's a national school, limited at first to miniature-painting, began to arise. Then came Thornhill, the great "original" Hogarth, and the first president of the Royal Academy, Reynolds. Sir Digby Wyatt points out that our superabundant wisdom, which the Greeks turned in the direction of the Fine Arts, is with us turned in the direction of science. We are almost the only highly civilised nation which has not a Minister of Fine Arts, and the head of the only department which has a direct practical action upon them has publicly expressed his indifference for those Arts. Sad it is that the Slade Professor should have been able to make such statements as these: "Our nobility and our rulers shew but little signs of sympathy, while royalty itself has shed but a weak and ineffectual ray upon the progress of Fine Art in England. In the last generation it was far otherwise. The names of Fitzwilliam and Egremont should ever be honoured, and the founders of the British Institution did far other service to the country than those degenerate trustees of the noble funds of which they should have been good stewards, who have suffered that most excellent Institution, which in its time did rare good service to the Art of painting, to die of premature decay and atrophy."

We find some capital advice to the painter of *genre* who selects from the page of history, writ-

ings of poets and novelists, and the incidents of every-day life, themes for his pencil. The painter of this class of subjects must take care to record only what is worthy of being remembered. Men's minds have an affection for incidents which have survived in story or tradition, and will be more lastingly popular than trivial scenes selected from times present. If a comparatively mean subject is selected it will have to be treated under "some exceptionally beautiful aspect of light, shade, or colour. It is to their command over this power of gliding over with the pure gold of circumambient light the baser metal of our common nature, that the masters of the Dutch school owe their enduring celebrity and consideration. To paint a village barber operating upon a grinning rustic, would appear to be an utterly unworthy employment of a painter's talent; but to so represent the scene as to invest it with an absolute truthfulness of impersonation, a justness of light and of reflection, a truth of colouring, and a perfect roundness of modelling, given, not by mechanical labour, but by a succession of brilliant and intelligent touches of the pencil, is to ennoble what would otherwise be mean, and to raise into the world of *genre* painting that which, less beautifully presented to us, would be fitting only for the province of caricature."

We have endeavoured briefly to give our readers an idea of these interesting lectures; for a more extended view we refer them to the book itself. We congratulate Professor Wyatt on his work, and hope that his future lectures at Cambridge will as ably fill in the "sketch" of Fine Art he has given us.

ART IN THE PROVINCES.

BIRMINGHAM.—The autumn exhibition of the Royal Birmingham Society of Artists was closed on the 14th of January, after a very successful season; the number of visitors to the gallery and the amount of sales showing a considerable increase, in both cases, over those of the preceding year. The total sale of pictures, at catalogue prices, amounted to £3,088; the Art-Union Society of Birmingham selecting works to the value of about £608. The principal pictures bought were—'Happiness,' by J. J. Hill, £120; 'Japanese Chrysanthemums,' by Miss A. F. Mutrie, £157; 'A Spanish Lady,' J. B. Burgess, 110 gs.; 'Near Capel Curig,' J. Syer, £100; 'Land at Last,' A. C. Stannus, £80; 'The Balcony,' A. Johnston, £80; and 'A Sermon in Rome,' A. B. Donaldson, £80.—On the 16th of the month a lecture on "Decorative Art" was delivered before the members of the Midland Institute, by Mr. E. J. Poynter, A.R.A., dividing the subject into two parts, treating respectively the elements of beauty in relation to Art-manufactures, and next in relation to painting.

CHALDON.—The parish church of this pleasant and sequestered Surrey village has recently been under repair. During the operations the workmen engaged in cleaning the plastered walls discovered, at the western end of the edifice, signs of an ancient painting, which at length developed itself into a large fresco, 10 feet in height, and about 18 feet in breadth. The subjects represented are souls in purgatory, their descent into it, their deliverance from it, and their reception into heaven, each being divided from the other by horizontal bands of geometrical pattern. The date of the work has been fixed by some members of the Archæological Society to be of the eleventh century or early in the twelfth; and it is stated that the society proposes to give some account of it in their next publication. The discovery has, we understand, drawn much antiquarian interest to the spot.

LIVERPOOL.—The Town Council intends to hold an exhibition of works of Art in Brown's Library, soon after the closing of next Royal Academy exhibition. It is to be quite independent, as reported, of the Liverpool Academy, though the hanging of the pictures will be superintended by the president of that institution: and admission is to be gratuitous.

THE PEG-TANKARD.

THE Peg-Tankard is of very ancient origin, dating as far back as the time of King Edgar, when England was under Saxon rule. It is recorded of this monarch that, in order to restrain the habit of drunkenness which had become a crying evil in his reign, and which had been introduced among his subjects by the Danes, he caused "pegs," or "pins," to be placed in the drinking cups of that period, at certain distances, to limit the quantity of liquor allowed to each person, and ordained punishment to those who exceeded their proper marks.

Dean Hook, in his "Lives of the Archbishops of Canterbury," attributes the introduction of pegs in tankards to the intervention of Dunstan, who was primate from 957 to 988, and says that, "owing to quarrels which frequently arose in taverns from disputes among toppers as to their respective share of the liquor when they drank out of the same cup, he (Dunstan) advised King Edgar to order gold or silver pegs to be fastened inside the pots, that, whilst every man knew his just measure, shame should compel each to confine himself to his proper share. Hence, the expression of being 'a peg too low.'"

Dr. Pegge asserts that pegs in tankards contributed more to the encouragement than the prevention of hard drinking, and states that the first person that drank was to empty the tankard to the first peg, or pin; the second to the next pin, and so on, by which the pins were so many measures to the compositors, making them all drink alike, or the same quantity; and as the distance of the pins was such as to contain a large draught of liquor, the company would be very liable by this method to get drunk, especially when, if they drank short of the pin or beyond it, they were obliged to drink again.

The term is still extant, when, speaking of a person who is much elated by drinking, that he is "in a merry pin;" which, no doubt, originally meant that he had drunk to the pin, or mark, and that his brain had become affected by his potation. Cowper describes John Gilpin as in "merry pin"

The drinking flagons, which I am about to describe, are, with a few rare exceptions (including the famous Glastonbury tankard, which is of oak, and the maple tankard, preserved in the Ashmolean Museum at Oxford), the only wooden peg-tankards at present known. The three examples here figured are of maple-wood, slightly worm-eaten, but, nevertheless, in excellent preservation as specimens of mediæval Art. The tankard, No. 2, is regarded from the style of carving and ornamentation as the most ancient. They are all secured by a thick coating of varnish from the further ravages of the worm, and are now in the possession of WILLIAM FRIPP, Esq., The Grove, Teignmouth, by whose kind permission the drawings were made.

The first and most important of these tankards is of large size, being 8½ inches high, and 6½ inches in diameter. It holds two quarts of liquor, and is divided by six pins into measures of one-third of a quart each.

It stands on three feet, each foot formed by a fruit of the melon tribe; and the carving is very rich and elaborate. On the lid, raised by means of a knob above the handle, is depicted the figure of the Saviour, enclosed in an oval wreath. He is seated on clouds, crowned with the *nimbus*, and is pointing to the globe and cross he holds in his left hand. Immediately above the head of the figure is an arched scroll, on which is inscribed, in capital text, the word *Salvator*. The lid is further enriched with carved bosses, birds, fruit, and foliage, ranged alternately on the surface.

On the body of the tankard and inside the lid the figures of the four evangelists are disposed, medallion-wise, in the act of inditing their gospels.

The centre and sides of the cup are filled in with the figures of St. Matthew, St. Mark, and St. Luke, with their respective attributes—an angel, a lion, and an ox—each enclosed in an

oval border consisting of a wreath, broken at regular intervals by ebony rings and bosses. In the upper and lower spaces, between the compartments, figures of angels appear floating on clouds, in the act of blowing trumpets; and in the central spaces branches of fruit are grouped in a circular form.

Inside the lid is a carving of the beloved disciple and evangelist, St. John. He is repre-

sented as a beardless youth, with locks flowing over his shoulders, holding a pen in one hand and a book in the other: this subject also being enclosed in a fine border. The head of each evangelist is surmounted by an arched scroll, bearing his name, as in that of the Saviour on the lid.

The base of the tankard is finished with a border corresponding with the wreath on the lid.



No. 1.

The handle of this cup is very fine: it is richly carved in a scale-like ornamentation, the outer edges are thickly studded with black knobs, and terminate at the base in a large foliated boss, in which the ebony mountings are again introduced with good effect. This tankard is a noble specimen of the taste and skill of the era it exemplifies, and is the most imposing and beautiful of this interesting group.

The peg-tankard, No. 2, stands on three carved pines, which form the feet. It is 7

inches high, and 6½ inches in diameter, and is capable of holding three pints, which are divided into draughts by four wooden pegs.

The lid-elevator, or knob, is surmounted by a pine, and the base of the handle terminates in a cherub's head with wings. On the face of the handle the quaint figure of a long-eared owl, seated on a perch, is carved, edged with a narrow delicately-cut border, and the sides are decorated with a garland of leaves.

The body of the tankard is divided into six



No. 3.

No. 2.

irregular compartments—three large and three small, ranged alternately. They are separated by tall twisted columns, from which spring depressed semi-circular arches. Each of the smaller spaces is filled with a single patriarchal figure—viz., Moses, with peaked beard and flowing hair; Aaron with the incense-pot; and David with harp and crown. The larger divisions are occupied by groups of figures—the

subjects taken from remarkable scenes in Scripture history. In one of these spaces is commemorated the "Offering of the Wise Men;" in a second, "Moses striking the Rock;" and in a third, "The Meeting of Rebecca and Eliezer at the Well of Nahor." In the central compartment, which is shown in the engraving, the patriarch is in the act of striking the rock, and the water is apparently gushing out of the

end of his rod. He is arrayed in a vestment girt round the loins with a cincture, and his head is garnished with a pair of uncouth looking horns, probably to typify the declaration of the psalmist, that "the horns of the righteous shall be exalted."

The rim of the lid is decorated with a foliated border. On the centre, which is raised, the Passion of Christ is depicted; and underneath, the twelve apostles, with their emblems, are "ranged in order due."

The third and last example of this interesting group is of much smaller dimensions than either of those previously described, being only 6 inches in height, and 4 inches in diameter. It is divided into half-pints by three wooden pegs. It is apparently the least ancient of the three, and the ornamentation is of a different character; for whereas the other examples are scriptural, this is altogether floral, in subject. It is also comparatively fresh-looking, and untouched by the worm; and is, therefore, probably of not earlier date than the introduction of tulips into Germany from the East, about the middle of the sixteenth century (1554), though it may have been copied from eastern models before that time—the tulip having long been known as a favourite flower in Turkey, where a feast of tulips has been annually celebrated from time immemorial.

This tankard stands on three elongated lions to form the feet, and the base is ornamented with a scalloped border. It is divided into three compartments, each of which contains a vase of tulips in full bloom, confined by a semicircular arch, and between each arch rises a single flower. The lid has a dentilated edge, and in the centre, within a circular border, is the figure of a lion *passant*, the intermediate space being filled with festoons of the vine.

These ancient drinking-flagons are said to have been brought from Germany by a collector at the close of the last century; from him, probably at his death, they came into the market, and passed into the hands of a London dealer, who sold them many years ago to their present possessor.

A. C. G.

THE WORKING MEN'S COLLEGE.

THE Working Men's College, in great Ormond Street, is an institution that should command the attention and the support of the public. The use of the word "College," as descriptive of this institution, may mislead. At the same time it is not easy to pitch upon another English word to denote the establishment. We use the word conventionally, to describe either a 'secondary or higher school, or an association, of persons, pupils or otherwise, living together under certain corporate rules. Neither of these definitions applies to Great Ormond Street. The subjects of tuition commence with the beginning, with elementary English grammar, and elementary arithmetic. The highest slight attempted by the pupils of the third year's course reaches to the *Hellenica* of Xenophon, to trigonometry, and to the use of the microscope. Thus it would seem that the entrance examination—if there were such a thing—would be confined to that familiarity with the letters of the alphabet, which would enable the student to read and to copy an extract from any ordinary English book, and to acquaintance with the four elementary rules of arithmetic. We do not mention this as any disparagement of the Institution. On the contrary, we think that it is so broad and catholic a principle, that we rejoice at its adoption. Still, it must be borne in mind, and it is most important that all possible pupils should know, that it is not necessary, in order to enter the Working Men's College, to have had any great amount of schooling.

Then as to collegiate restrictions. The hours of attendance are from 8 to 10 P.M. The entrance fee is 1s. 6d. The term fee is 1s. The fee for a class of one hour is 2s.; for a class of two hours 3s.; for French and German classes 2s. 6d., and 3s. 6d. For drawing in the life

class 2s. 6d., in the other classes 4s. for three nights in the week, and 5s. for five nights in the week. We presume that these payments cover the entire term, which, in the current instance, extends from January 9th to March the 4th, 1871. This, however, might be more clearly stated in the preliminary programme. As it stands, it is open to the question, whether a fee of 2s. is not expected as the price of attendance at a class or lecture occupying a single hour. This of course, would be beyond the reach of the greater number of persons whom the institution is intended to benefit.

The branches of instruction, the usual collegiate name for which is faculties, are these: Art, history, and law; languages, including English; mathematics; physical science. The order is noteworthy. It tells much of what is passing in the minds of the Executive Committee. We rejoice to see the first requisite in the education of the workman put first. The Latin grammar—a never-to-be-forgotten friend of early boyhood—quotes the ancient saying that "faithfully to have learned the liberal arts softens men's manners and elevates them above the brutes." This would be a worthy motto for the college. But next, in our opinion, should rank mathematics; and third, physical science. Language should follow, and history and law, demanding for their advantageous exposition to the working man the service of lecturers of the highest order of mind, men who habitually breathe an atmosphere free from the slightest taint of the party politics, or the *doctrinaire* philosophy of the day. Nothing can be more important than that the light thus shed on the less highly prepared mind should be pure and untinted—white light, not any hue of the political spectrum. A lecturer who is deaf, owing to what are called liberal views, to the outcome and witness of history, would be no less mischievous a teacher than one who was blind, from conservative instinct, to the actual facts and omens of the day.

In addition to the classes above indicated, there is an elementary class for reading, and writing from dictation, the elements of grammar, and arithmetic; from division to practice. There is a series of free general lectures on the Saturday evening, on history, geology, physics, and the law of nations in peace and war. There is an adult school for teaching the subjects required for entrance to the college, a very valuable and benevolent adjunct. There are vocal music classes in connection with the college, which are open to persons of either sex and any age on the nominal admission fees of 2s. for the half-year in the first section, and 3s. in the second. There is a library open to members every day, except Sunday, from 7 to 10 P.M. Very many of our friends can materially serve a useful institution by presenting to this library such volumes as they can spare, hardly any one but can make such an offering without inconvenience, and "many a little makes a mickle." There is a coffee-room with moderate charges. The teachers are almost wholly unpaid. Artisans and working men of London, visit the spot where so much has been freely offered for your service! English men and English women—all who know how intimately the prosperity and stability of England depends on the education of the working bees of our great hive—fling, each of you, your mite into the treasury of the Working Men's College.

We cannot too often urge upon our readers that the working men of the Continent are advancing, with rapid and sustained march, along the path which a few sincere and fore-thinking friends of English industry are thus attempting to open for our own craftsmen. The point in which we are most in arrear, in this respect, is perhaps the association of schools with centres of industry, not merely locally, but organically. In a city where, as in our metropolis, there is so much journeyman-work and home labour, an establishment like the Working Men's College is a benefit of no ordinary kind. But we must not relax in our efforts for the formation of special schools. And we shall recognise those as the most useful and best conducted which spread the most widely, not the spirit of self-satisfaction, but the thirst for knowledge.

F. ROUBILIAC CONDER.

SELECTED PICTURES.

FROM THE PICTURE IN THE COLLECTION OF W. COTTRILL, ESQ., SINGLETON HOUSE, LOWER BROUGHTON.

THE DAUGHTER OF ZION.

J. F. Portaels, Painter. W. Greatbach, Engraver.

THE works of this distinguished Belgian painter have, through the medium of the various exhibitions in London and elsewhere, within the last three or four years, become tolerably familiar in this country; and, as a consequence, are sought after by collectors, whose judgment guides them to selecting that which is really excellent. His 'Souvenir d'Orient,' exhibited at the Academy last year, though certainly not among the best works we have seen both in and out of his studio, is a most attractive picture; while his 'Esther supplicating Ahasuerus on behalf of her Nation,' in the Academy exhibition of the preceding year, is an eminent example of his powers as a brilliant colourist.

It could scarcely escape the notice of those who have made themselves acquainted with the works of M. Portaels that he almost invariably gathers his subjects from the countries of the East, in which he has been a frequent traveller; and he finds in them, and in their past as well as present history, materials of unquestionable interest; these he is capable of working up, by the aid of a creative genius, into pictures that command attention for their many valuable qualities. The book of the prophet Jeremiah called his "Lamentations," contains several passages in which the Jerusalem of his time, when the Hebrews were exiled from it by the armies of the "stranger," is represented under the similitude of a woman, or women, sorrowful and destitute. The first chapter opens with such a comparison: "How doth the city sit solitary, that was full of people! How is she become as a widow." In the second chapter we find: "The elders of the daughter of Zion sit upon the ground and keep silence; they have cast up dust upon their heads; they have girded themselves with sackcloth; the virgins of Jerusalem hang down their heads to the ground." And again, in the same chapter: "All that pass by clap their hands at thee; they hiss and wag their head at the daughter of Jerusalem, saying, Is this the city that men call the perfection of beauty, the joy of the whole earth?"

It is this last passage that supplied M. Portaels with the subject of his picture; but its general treatment appears to have little reference to the time when Jeremiah mourned over the prostrate condition of the once glorious city. Jerusalem, as we see it here, is the Jerusalem of the present time; the mockers passing by are richly-attired Easterns of a modern type; the naked child with arms outstretched towards the "Daughter of Zion," and the figure bearing a younger child on its back, in the rear, it seems impossible to connect in any way with the principal group. The only intelligible link of connection with the period assumed by the artist to be indicated is the sorrowing, barefooted girl seated by the wayside. And yet in spite of its many anachronisms of time and place, it is, as a work of Art, a very fine picture; the subject is most poetically treated throughout. It was sold last year at Messrs. Christie's, from the collection of Mr. Everard, for the sum of 880 gs. Its size is so large as to make it a feature in the collection of its present owner.

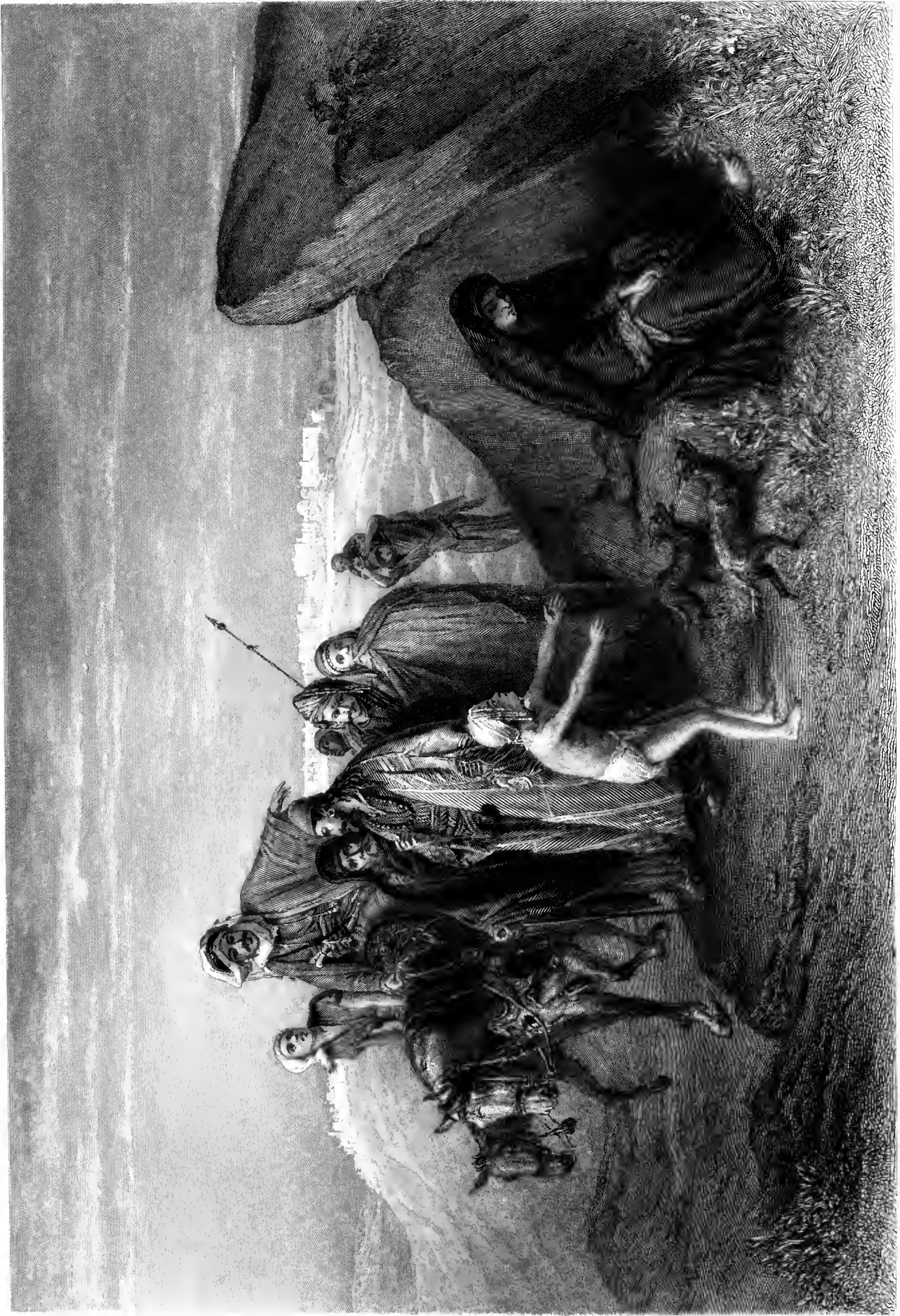

W. H. WOODS

THE LIFE OF THE BROTHERS



THE
STATELY HOMES OF ENGLAND.

(OCCASIONALLY OPEN TO THE PUBLIC.)

"The stately homes of England,
How beautiful they stand!
Amidst their tall ancestral trees,
O'er all the pleasant land."

Mrs. HEMANS.

By S. C. HALL, F.S.A.

THE ANTIQUARIAN NOTES AND DETAILS
BY LLEWELLYNN JEWITT, F.S.A.

HADDON HALL.

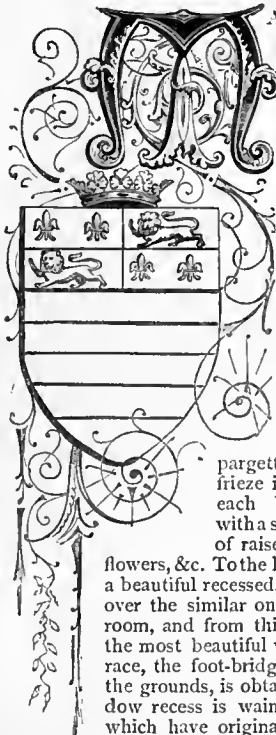

MAKING his way through the Banqueting Hall, the visitor will reach a doorway on his right opening into the DRAWING-ROOM, which is situated over the Dining-room described in our last chapter. It is a charming room, hung with grand old tapestry, above which is a frieze of ornamented mouldings in

pargetting work. This frieze is of five heights, each being decorated with separate moulding of raised festoons, fruit,

flowers, &c. To the left, on entering, is a beautiful recessed, or bay, window, over the similar one in the Dining-room, and from this window one of the most beautiful views of the terrace, the foot-bridge, the river, and the grounds, is obtained. This window recess is wainscoted in panels which have originally been painted and gilt—portions of the colour and gilding still remaining; its ceiling is in the form of a large star of eight points, with intersecting

flowers, &c. To the left, on entering, is a beautiful recessed, or bay, window, over the similar one in the Dining-room, and from this window one of the most beautiful views of the terrace, the foot-bridge, the river, and the grounds, is obtained. This window recess is wainscoted in panels which have originally been painted and gilt—portions of the colour and gilding still remaining; its ceiling is in the form of a large star of eight points, with intersecting



STEPS TO THE BALL-ROOM.

segments of circles attaching the inner angles to each other, and forming a geometric pattern of great beauty. The ceiling of the room is also

richly ornamented. Above and around the fire-place the wall is wainscoted in panels, in a similar manner to the recess. In the fire-place is one of the most curious of existing grates, the alternate upright bars of which terminate in *fleurs-de-lis*, and a pair of exquisitely beautiful fire-dogs; the two bosses on each being of open metal-work, of the most chaste and elaborate design and workmanship. They are of brass; and the bosses, which are circular, are designed in foliage and flowers. In these beautiful remains Haddon is especially rich; but the pair in this room, and the two remarkably fine enamelled bosses in the so-called "chaplain's room" are the most interesting and elegant. Opposite to the recessed window, a doorway in the tapestry opens upon the side-gallery of the "Banqueting Hall," and so gives access to, and communication with, the apartments on the opposite side of the quadrangle.

The opposite end of the drawing-room from the entrance doorway is occupied by a large window, of similar size to that in the dining-room beneath it, which overlooks the lower court-yard or quadrangle. In this room are still preserved some pieces of ancient furniture. Near the further window, a doorway opens into what is called

THE EARL'S DRESSING-ROOM, a small but

remarkably pretty apartment, hung with tapestry, and lighted by a recessed window. This room, as shown in our engraving, immediately communicates with

THE EARL'S BED-CHAMBER, so called in connection with the one just described, because thus occupied by the Earls of Rutland when residing at Haddon. This room is hung with tapestry representing hunting scenes, &c. From this chamber a doorway opens into

THE LADY'S DRESSING-ROOM, also hung with tapestry, and lighted with a recessed window. From this room a doorway opens out to the top of the flight of steps already spoken of as giving access to these apartments from the lower court-yard. By this means access was easily obtained to the chapel, and the lord and lady could enter or leave these apartments without passing through the Banqueting Hall. A small padlocked door, in the tapestry of this room leads up a narrow flight of steps to the leads over the chapel and to the open side of the belfry tower, where the works of the old clock may be seen.

Returning through the earl's bed-chamber and dressing-room, from the fire-grate in which it is said "the celebrated Count Rumford obtained his plan to prevent chimneys smoking," and retracing his steps through the

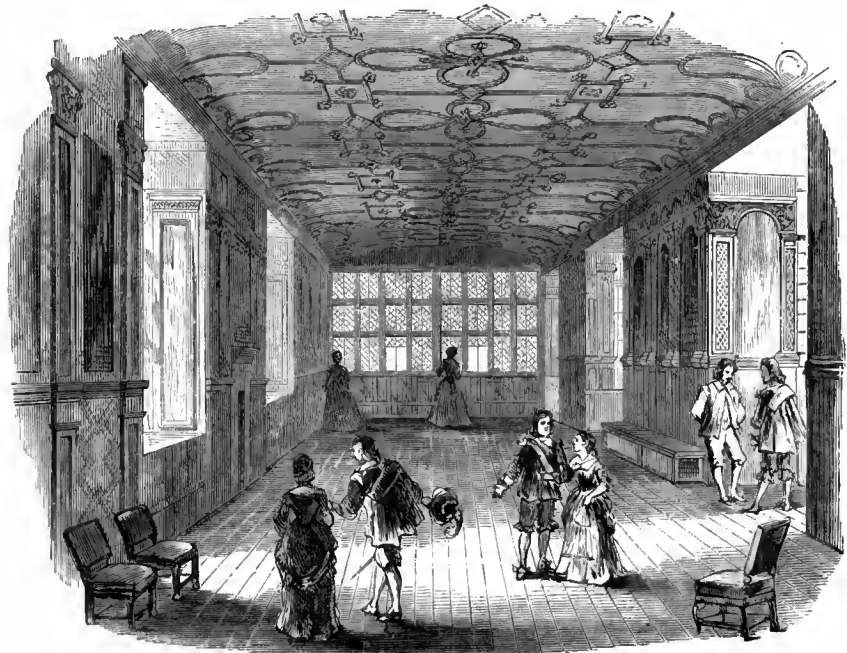

THE BALL-ROOM, OR LONG GALLERY.

drawing-room, the visitor passes out to the landing-place of the staircase leading up from the Banqueting Hall. From this a doorway leads up to a small rude apartment, with a fire-place, and an old chest; and also leads to the leads of the roof of the drawing-room, earl's bed-room, long gallery, chapel, &c.

Descending these stairs again to the landing, we enter the LONG GALLERY, or BALL-ROOM, one of the glories of fine old Haddon, by a flight of six semicircular steps of solid oak, said to have been cut from the root of a single tree that grew in the park of Haddon, the trunk and arms of which are also asserted to have furnished the whole of the timber of the floor of the long gallery, or ball-room, itself. Thus, if the story be true, the whole of the flooring of this superb apartment, which is 109½ feet in length, and 18 feet in width, as well as these massive steps outside the room, were obtained from one single oak-tree grown on the spot.

Ascending the STEPS, of which we give an engraving, the visitor will do well to notice the lock and other details of the door, which are somewhat curious. This noble apartment extends, as will be seen on reference to the engraved plan already given, nearly the entire length of the south side of the upper court-yard—commencing near the Banqueting Hall, and, running the entire remaining length

of the upper court-yard, is carried out into the winter garden beyond.

This grand room is wainscoted throughout its entire dimensions with oak panelling of remarkably good architectural character. The general design is a series of semicircular arches, alternately large and small, divided by pilasters with foliated capitals, and surmounted by a frieze and a turreted and battlemented cornice. The pilasters, divided like the whole design up to the frieze, are of three heights. The basement of the wainscoting, about one eighth of its entire height, is plainly panelled, and devoid of all ornament. The second height, rising to more than a third of the whole, is of a much more decorated character. The pilasters are fluted, and the spaces between them filled in with geometric designs, the narrower spaces being by far the most elaborate in their design. The third height is a series of semicircular arches, alternately wide and narrow, divided by the pilasters, the crown of the arch of the narrower ones being on a level with the springing of the larger ones. The whole of the arches, in which pictures formerly hung, spring from small brackets and semi-pilasters at the sides of the pilasters, and are elaborately decorated. Over each of the smaller arches is a shield of the arms of Manners, with a crescent by difference, and surmounted on the frieze by their crest, a

peacock displayed, also differenced with a crescent, alternating with those of the Vernon crest, a boar's head. The pilasters in this height are carved in scale pattern, and are finished with capitals of foliage filling up the spandrels of the arches. Above these is the frieze, the spaces of which are occupied respectively with the crests just named, alternating with the rose and thistle conjoined on one stem. Above this is a remarkably fine turreted and battlemented cornice, in which the loop-holes, &c., are cut quite through the whole thickness of the wood.

The ceiling of this magnificent room is covered—the coving receding for the cornice. It is covered with elaborate and exquisitely designed geometric tracery, consisting of squares, lozenges, quatrefoils, &c., beautifully foliated at their points, and containing shields of arms and crests, the arms being those of Manners impaling Vernon, and the crests those of Manners and Vernon alternately. This ceiling was originally painted and gilt in a very rich manner, remains of the colouring and gilding being still distinguishable, here and there, through the whitewash. On the walls still hang one or two



GALLERY ACROSS SMALL YARD.

pictures, which perhaps, however, only add to the solitariness of its appearance.

On the south side of this noble apartment is a charming central recessed window of large size, 15 feet by 12 feet—large enough, in fact, to accommodate a goodly party around the fine old central table, which still remains—and two smaller recessed, or bay, windows. On the north side are two windows looking into the upper court-yard; the east end is entirely taken up by a strongly stone-mullioned window of twenty-four lights, with a side window on each side. In the recessed windows are the royal arms of England, and the arms of Vernon, Manners, Talbot, &c., in stained glass. Our engraving shows about one half, in length, of this noble room.

Opposite to the central recess is a fire-place, which still holds the original fire-dogs rising from goats' feet, and decorated with human heads and heads of goats. In the centre of the large window at the end will be observed a glass case, containing a cast of the head of Lady Grace Manners, whose monument is in Bakewell Church. She was the daughter of Sir Henry Pierpoint, and wife of Sir George Manners, of Haddon, the eldest son and heir of Sir John Manners and Dorothy Vernon his wife. Lady Grace "bore to him (her husband) four sons and five daughters, and lived with him in

holy wedlock thirty years. She caused him to be buried with his forefathers, and then placed this monument (at Bakewell) at her own expense, as a perpetual memorial of their conjugal faith, and she joined the figure of his body with hers, having vowed their ashes and bones should be laid together."

From near the upper end of this Long Gallery, or Ball-room, a highly-enriched doorway opens into the Ante-room, or Lord's Parlour.

The ANTE-ROOM, now occasionally called the "Lord's Parlour," and, two centuries ago, was designated the "Orange Parlour," is a small room, hung with paintings, and having around the upper part of its walls a cornice embellished with the crests of the Vernon and Manners families. The interest, however, attached to this apartment rests in the strongly-barred door which opens from it on to a flight of stone steps leading down to the terrace and



THE ORIEL WINDOW DINING-ROOM.

winter-garden. This doorway, known far and wide as DOROTHY VERNON'S DOOR, we have engraved, both as seen from its exterior side and its interior side, and have also given the "initial" illustration to the first chapter.

It is said, and no doubt with truth, that it was through this doorway and down these steps that the lovely Dorothy Vernon, one of the coheresses of that grand old family, passed on

the night of her elopement, and that at the top of the opposite flight of steps, shown in our ground plan, and known as "Dorothy Vernon's Steps," she was received into the arms of her ardent and true lover, John Manners, who had horses in waiting; and that they flew through the woods and fields until they gained the high road, and made their way into the neighbouring county. It was through this doorway then

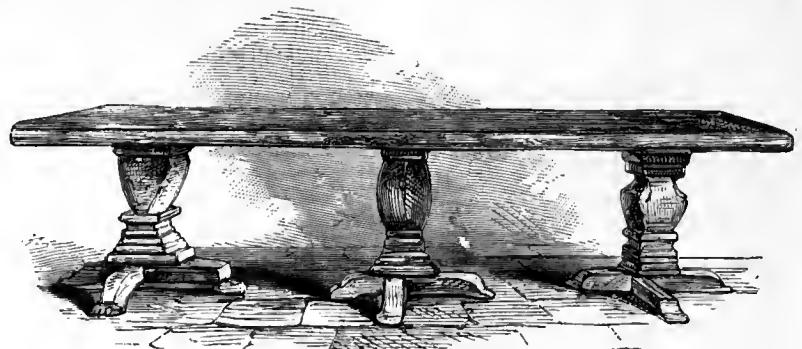

OLD OAK-TABLE IN THE BANQUETING-HALL.

that not only the lovely Dorothy passed, but with her the fine old mansion itself and all its broad lands, into the hands of the noble family now owning it.

Very sweetly has the tradition of the love and elopement of this noble pair been worked up by imagination in a story, "The Love-steps of Dorothy Vernon," by a popular writer ("Silverpen") in the "Reliquary," and thus another modern writer very pleasantly embodies it in verse:—

"The green old turrets, all ivy-thatch.
Above the cedars that girdle them, rise,
The pleasant glow of the sunshine catch,
And outline sharp on the bluest of skies.
"All is silent within and around;
The ghostly house and the ghostly trees
Sleep in the heat, with never a sound
Of human voices or freshening breeze.

"It is a night with never a star,
And the Hall with revelry throbs and gleams;

There grates a hinge—the door is ajar—
And a shaft of light in the darkness streams.

"A faint sweet face, a glimmering gem,
And then two figures steal into light;
A flash, and darkness has swallowed them—
So sudden is Dorothy Vernon's flight!"

Passing through the ante-room, the visitor next enters the STATE BED-ROOM, known two hundred years ago, it seems, as the "Blue Drawing-room." The walls are hung with Gobelin's tapestry, the subjects being illustrations of Æsop's Fables; and above this is a frieze, similar to that in the ante-room, bearing the crests of Vernon and Manners. This apartment is lighted by a large bay-window, overlooking the upper court-yard, and raised a couple of steps above the level of the floor of the room itself. In this window stands an antique dressing-table and a grand old looking-glass, which are worthy of the most careful examination. Over the chimney-

piece is a fine example of pargetting, representing Orpheus, by his musical powers, charming the brute creation.

The STATE BED, shown in our engraving, measures 14 feet 6 inches in height. It is furnished in green silk velvet and white satin, exquisitely embroidered and enriched with needle-work. It is one of the finest remaining beds in existence, and is presumed to be the work of Eleanor, daughter of Thomas, and eldest sister and coheir of Edmund, Lord Roos, of Ham-lake, and wife of Sir Robert Manners; which lady died in 1487. According to traditional report it was removed many years ago from Haddon to Belvoir Castle, and afterwards restored to Haddon. The last person who ever slept in it is said to have been George IV., when Prince Regent; he occupied it during his visit to Belvoir Castle.

From the State Bed-room a doorway behind the tapestry opens upon a short flight of stone steps, leading to what is usually called the ANCIENT STATE ROOM, or PAGE'S ROOM, and which two centuries ago was called the "Best Lodging-room."

This apartment, like the previous one, is hung with Gobelins tapestry, the subjects being illustrations of some of the events in the life of



GATEWAY UNDER THE EAGLE TOWER.

Moses. The thickness of the walls, the small size of the windows, and the lowness of these rooms, show that they belong to the more ancient part of the building. From the Page's Room a short flight of steps leads into a passage, or small room, which may appropriately be called the archers' room, and is shown in our engraving, where the visitor will notice a remarkable WOODEN FRAME for the stringing of bows and cross-bows—the only one probably which he will ever see preserved. It forms one of our illustrations. The passage leads by a few stone steps into a rude apartment, probably a guard room, where, behind the rafters, innumerable bats now build their nests; also into the cross-bow room, where the bows were hung; and into several other old and cheerless looking rooms; also to a spiral stone staircase, which, springing from the gateway under the PEVEREL TOWER, leads by seventy steps, some so worn that they have been covered by wooden ones, to the top of the tower, the ascent of which will amply repay the visitor for his trouble by the grand and interestingly beautiful view he obtains of the mansion and the neighbourhood. Of the turret on the PEVEREL, or EAGLE TOWER, we give an engraving.

Having descended the tower the visitor returns

through the state bed-room, into the Ante-room, and is here usually dismissed into the grounds, through "Dorothy Vernon's door." As we have not, however, initiated *our* tourist into the mysteries of all the rooms and passages of this noble pile of building, we will not dismiss *him* in this summary manner, but bring him back into the Banqueting Hall, whence we will show him the kitchens and suite of rooms on the north side, and then conduct him to the grounds and to some of the interesting places in the neighbourhood.

The KITCHEN and range of domestic offices at Haddon are very large and extensive, and show, more strikingly than any description, the marvellous amount of cooking that must have been carried on, and the more than princely hospitality observed by its owners in its palmy days. The four doorways, already spoken of in our second chapter as existing in the wall of the passage opposite to the screen of the Banqueting-Hall, and beneath the Minstrels' Gallery, have all of them pointed arches. The first of these doorways, on entering from the

lower court-yard, or quadrangle, yet retains its old oaken door. This room was the *buttery*, and the door still has, perfect, its buttery-hatch in the middle. This is a small opening, with a little wicket to close and fit, just large enough to pass out a trencher of provisions to the servants or retainers, or as alms to wayfarers. From this room, a flight of stone steps conducts to the vaulted cellars, and it also communicates with the storerooms, and other offices, &c.

The second doorway, which is open, leads down a long passage to the GREAT KITCHEN. At the end, the passage terminates in a strong and massive half-door, the top of which is formed into a broad shelf. To this point only were the servants permitted to come, but were forbidden access to the kitchen itself. The dishes were placed on the door-shelf by the cooks on the one side, and removed by the servitors on the other, and by them carried up the passage into the Banqueting-Hall. The kitchen is of immense size, its ceiling supported by massive beams and by a central support of solid oak.



ANTE-ROOM TO THE EARL'S BED-ROOM.

It contains two enormous fire-places, stoves for various purposes, and spits, pothooks, and tenter-hooks by the score; enormous chopping-blocks, dressers of all sorts and sizes, tables of solid oak, six or seven inches in thickness, and hollowed into circular chopping-troughs—one of which is worn through by constant use—and every possible appliance for keeping open house in the most lavish style. Adjoining the kitchen are a number of rooms, bakehouse, larders, pantries, salting-rooms, &c., all fitted in the same marvellously massive manner. In one of these should be noticed an enormous salting-trough hollowed out of one immense block of wood, without joint or fastening. This is among the most wonderful relics of the place, and ought to claim attention from the visitor.

The third doorway opens into what is conjectured to have been the wine-cellar—a vaulted room well adapted for the purpose, and close at hand for the Banqueting Hall.

The fourth doorway opens at the foot of a flight of stairs leading up to the apartments on the north side, which, for more than half its length, contains a second as well as a first floor.

These rooms are many in number, and curiously labyrinthine in construction, and although not possessing attraction enough to be shown to the general visitor, are nevertheless among the most interesting in the mansion. Some of them are hung with tapestry which ranks among the best in the house: one room especially, where groups of children gathering fruit are depicted, is peculiarly beautiful. In two of the apartments on this side are charming little closets, on the tapestry of one of which the royal arms are depicted.

One of these tapestried rooms is named in an old list of apartments of 1666 as "Lady Dorothy's Chamber," and a neighbouring apartment is called "Lady Cranborne's Chamber." A third tapestried apartment was called "Roger Manners' Room." All these rooms are on the central portion of the northern side of the Hall, over the kitchen and adjoining rooms. The apartment over the buttery was the "Great Nursery."

Most of the rooms on this side of the building have evidently been intended for sleeping apartments; and there is a staircase with ornamental rails, on which remains of the original gilding

still serve as a relief to the sombre colour of the oak itself.

One of the most charming "bits" on this side is a short WOODEN GALLERY, here engraved, with oak balustrades, which leads across a tiny little open court from one of the tapestried apartments to another, and on the walls of which mosses and lichens grow in luxuriance. It is just the spot, opening from the heated rooms, for a lounge in the pure air; and no doubt from this gallery Dorothy Vernon, and many another high-bred dame, has looked up to the stars overhead while passing from room to room, on a festive night as well as on many a quiet evening.

Among the apartments not usually shown are also two handsome wainscoted rooms, with carved ceilings, situated over each other, in the entrance gateway tower. Above the uppermost of these is a room supposed to have been a place of confinement, because there are traces of *external* bolts and bars. It has two windows, in one of which are two massive stone seats inserted in the wall. It has also a door leading out to the leads.

Most of the points of interest have now been described; but the curious rambler, who may choose to linger and pry into nooks and corners, will do well to visit some of the

basement rooms—as that on the left-hand side under the Peverel Tower—an arched warder's room, where he will note the thickness of the walls (7 feet); the next room westward, which seems to have been the earlier kitchen and bake-house; the room under the state bed-room, used in later times as a gymnasium for the family; the annoury, which is under that portion of the long gallery with the deep projecting recess; and the rooms under the long gallery nearer the dining-room, where the splay of the windows is nearly 9 feet, and which seem to have been used as washing houses. Also the so-called aviary, which opens toward the garden, under the earl's bed-room and adjoining rooms; and of the rooms yet unmentioned on the west side of the lower courts, suffice it to say, that on the ground floor, next to the so-called chaplain's room, were two waiting-rooms; and then the steward's room, next to the chapel entrance; over this entrance the steward's bed-room, approached by a spiral staircase near the belfry tower from a closet in which access is gained to the leads; and after passing the clerestory windows of the chapel, there is an angle commanding a good view of the lower court. Then on this first floor are a bed-room, the "bar-master's room;" the real chaplain's room, in which is now a collection of bones; a small

BEAUVAIS, AUBUSSON, AND GOBELINS TAPESTRIES.

AMID the relics of Mediæval Art that now command such high and augmenting prices, tapestry holds a rank apart. The extraordinary amount of time, as well as the rare quality of skill, requisite to produce a really fine piece of tapestry or of embroidery, are such as to place a sharp limit on the number of specimens likely to be brought into the market. Add to this the consideration that careful preservation of tapestry is most unusual. Dirt and neglect, rats and mice, haste in removal or untaught zeal in hanging.

As mural decoration of the very highest order, nothing, for this country, equals tapestry; its judicious introduction gives a dignity and grandeur to an apartment large enough for such adornment, that nothing else can give. "La Grande Mademoiselle" said of the ancient Chateau of La Tremouille "*qui sent sa noblesse de longue main*;" and something of the same incommunicable *cachet* lingers over products of the great French looms, or the work of subtle fingers now resolved to dust. Even could we overcome the chemical difficulties which have hitherto made attempts at *fresco* in this country a mockery and an eyesore, what painted wall can compare to an arras chamber?

Those of our readers who are interested in tapestry should take an early opportunity of visiting the Gallery, No. 48, Great Marlborough Street, where Mr. Sampson, of Hanway Street, has on view some rare specimens of Aubusson, Beauvais, and Gobelins work, which he has had the good fortune to purchase at Rome and at Venice. The Beauvais tapestries bear the signature of Duplessis, and the date 1724. They represent allegorical subjects, and are very remarkable for the sort of mosaic of which they are composed. The four pieces of Aubusson are extremely curious. They represent Chinese domestic scenes. But the designs, although no doubt Oriental in their origin, have been translated into French in the loom. The women, in especial, are rather European than Asiatic; and the *petit pied* displayed by these dames is not the golden lily, so adorable to a Chinaman, and so suggestive of deformity to an Englishman. The colours are bright and admirably fresh. The signature on one piece of the set is M. R. O. Aubusson Piron. All these come from the collection of Signor Mario, at Florence.

Four large webs of Gobelins tapestry, one 24 ft. 9 in. long, the others 16 ft. 10 in. long, and all 13 ft. 6 in. high, are perhaps unique as a set. Their preservation is perfect, although they bear the date 1789. The wonderful freshness of their colours is accounted for by the fact that they remained carefully hidden from the light of day from 1793 till 1855, since which date they have been hung in a room without windows, built expressly for their reception, in the Contarini Palace, at Venice. Mr. Sampson gives the history in detail. The designs, by Detroy, were made at Rome in 1741. The tapestry was wrought by Andran and Cozette. They are said to have cost £20,000. The legends are embroidered on each, in a small plaque, in the centre of the border, which is wrought in imitation of a gilt picture-frame, with a *fleur-de-lis* in each angle. In the first, Jason tames the brazen bull by means of the magic herbs given him by Medea. In the second, the armed men springing from the dragon's teeth destroy one another. In the third Jason espouses Creusa. The wreathed and veiled head of the priest in this piece is especially fine. In the fourth Creusa expires from the poisoned vestment, the treacherous gift of Medea. The action and movement of the figures in each scene is vigorous and sustained: the distant landscape is admirably rendered. The vivid freshness of the colouring is that of the day of completion. We do not think Mr. Sampson says too much when he calls these webs the very finest specimens of the Gobelins tapestry of the Louis Seize era ever submitted to public notice in this country.

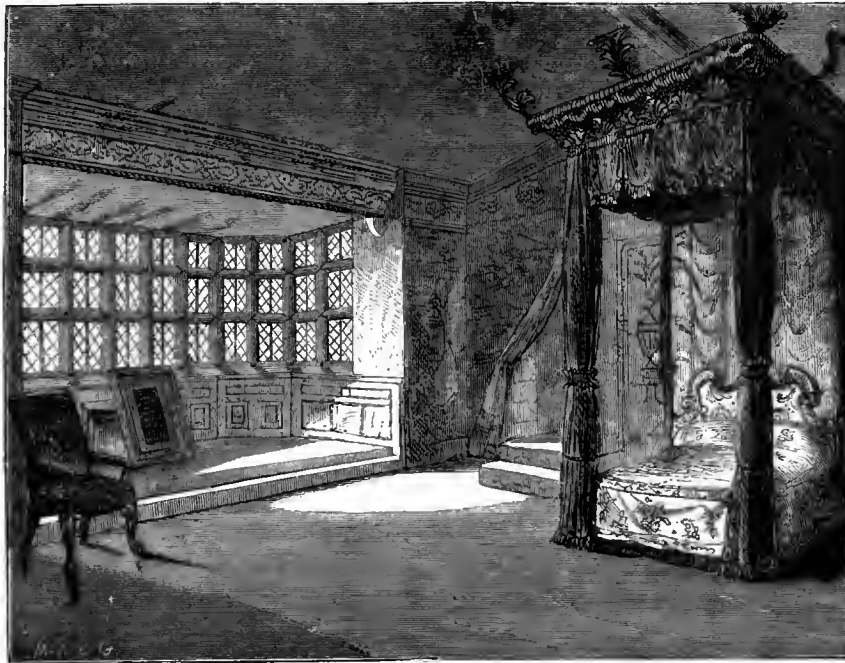

THE STATE BED-ROOM.

room still used by the duke for private papers; and another bed-room, which brings us back to the entrance gateway.

But enough has been said of the interior of Haddon to satisfy the wants of the tourist, and, although we could linger for hours over the various rooms not yet specifically described, and fill a couple more chapters with their description, we must reluctantly leave them, and pass on into the grounds, and so make our way to Bake-well, to show the visitor the last resting-places of the noble families to whom Haddon has belonged.

Leaving, then, by a small doorway at the end of a passage leading out from the Banqueting Hall, and passing the dining-room on the right, the visitor will enter what is called the "Upper Garden." To his right he will see below him, on looking over the strongly-butressed wall—one of the oldest parts of the building—the "Lower Garden," roughly terraced down the hill side, and to his right a gravelled path leads by the side of the building to the wall of the chapel, where, by a long flight of sixty-seven steps, it descends to the old foot-bridge—one of the prettiest objects in the grounds: this we have engraved.

To his left, the "Upper Garden," 120 feet square, is a lawn; up its centre, as well

as around it, runs a broad gravel walk, opposite to which rises a splendid wide flight of stone steps, with stone balustrades, leading to the TERRACE and WINTER GARDEN. Along the sides of this garden are beds partitioned off by hedges, or as they may more appropriately be called, walls of yew and box.

The TERRACE, one of the glories of Haddon, extends the full width of the Upper Garden, the balustraded wall running flush with the end of the Long Gallery. From this terrace the finest view of the south front of Haddon is obtained, and it is indeed a view to revel in, and not to be forgotten. The WINTER GARDEN of the terrace is planted with yew-trees, many centuries old, whose gnarled and knotted roots may be seen curiously intertwining and displacing the stone edgings of the parterres. It is altogether one of the most charming out-door "bits" which even the most romantic and vivid imagination can conceive.

At the north end, in a recessed corner, formed by the wall of the long gallery on the one side, and by the outer wall of the Winter Garden on the other, and overhung with a grand old melancholy-looking yew-tree, is "Dorothy Vernon's door," previously spoken of as opening out from the ante-room. To this we shall refer in our next.

A GENUINE ARTISTIC RACE.

PART I.

AN examination into the condition of Art among a people is much like feeling the pulse to ascertain the health of a man; Art itself being the æsthetic ebb and flow of the tide of civilisation, covering life with significant beauty or leaving it uncomely and barren of delight. By watching the currents we may perceive how far it succeeds in disguising the prosaic exigencies of human existence, and in detecting the wholesomeness or unwholesomeness of the flow. Although Art should induce spontaneous enjoyment, yet its final effect ought to prompt a critical inquiry into the causes of our pleasure, what it reveals of the race that creates it, and its full meaning as a distinctive idiom of the universal language of our species. Any less mental analysis would reduce it to the level of a mere instrument of sensuous gratification, as transitory in our memories as the passing melody of a bird or the fragrance of a flower.

When we find ourselves in a wholly new field of inquiry and enjoyment, although more liable at first to err in judgment than when investigating things long familiar, the novelty adds to the charm and freshens the intellect into greater activity. For the instant, there is a new world to explore. Without further preliminary remark I invite the reader to come with me into one that, until recently, has been as unknown as the interior of Africa, but which, the better we are acquainted with it, the more it instructs and entertains. I refer to Japan. Our first mental operation should be to cast aside familiar ideals, and even ordinary rules of Art, and enter into this new world without other desire than to enjoy everything æsthetically good in principle, after its kind, however much it varies from the forms and laws we have been trained to view as the only sound ones. It is with Art as with religion. If we brand a rite as foolish simply because of its strangeness, we may unwittingly shut ourselves out of a new form of truth or source of happiness. We should carefully examine it, if only to increase our knowledge of humanity. Besides any æsthetic enjoyment on finding that instead of the anticipated ugliness or viciousness there is real beauty, the respect which supplants prejudices born of ignorance prompts to a more fraternal estimate of our fellow-men, whatever their creeds or colour. But the lesson is greater, if, in addition to strangeness of aspect and ideas, we discover a positive superiority in any point to our fixed standards, necessitating the training of our own minds to more acute perceptions of nature and a more refined feeling of beauty, in order to attain the level of those on whom we pass judgment.

This is emphatically true of Japanese Art. While anyone may be struck with its most obvious qualities of finish, execution, and colour, but comparatively few strangers can take in at first glance its exquisite delicacy and subtle harmonies of tints and designs. The wonder is all the more, when we come to know its finest characteristics, that a nation of forty millions of semi-barbarous heathens, as we have been taught in our school-books to view them, could have attained to such skill and taste as to make its prolific objects possible at all. It is one event for a race to rear a Michael Angelo, whose works are far above the comprehension of the multitude, isolated by transcendent genius; and quite another to invent innumerable beautiful objects which all can appreciate and enjoy, but which could not have existed unless there had been numberless competent artists and a national capacity of invoking their happiest efforts. There is all the more need for us promptly to inform ourselves of the principles, limitations, and specific features of the lovely, original Art in question, as it is rapidly being modified, and may wholly disappear before European intercourse. The same fatal decadence into mechanical uniformity and cheapness which has been experienced in China from this cause, now threatens Japan, only its power of resistance is greater. For the present, however, it continues to be the only land where the true artistic instinct holds out in its pristine

vigour. Indeed, the Japanese are the sole survivors of that state of civilisation, once universal, which took more delight in delicious ornament than in prosaic convenience and comfort.

Once, each European school of Art had a local stamp, as sharply defined as the idioms of the parent countries. Now the Fine Arts everywhere affect the same general characteristics as do the fashions of civilised nations; while the strictly decorative have succumbed in spirit to the purely industrial. A disposition to cheapen and multiply the minor Arts by mechanical processes of uniform application is fatal to artistic thought. In the end it not only effaces our intellectual convictions, but blunts the appetite for beauty. We lose our consciousness of harmonies of form and colour, and actually learn to prefer a monotonous multitude of cheap and ugly things to masterpieces of Art, whose laws we no longer comprehend, and the feeling for which has become inscrutable. Without our noting it, the senses degenerate if stunted of a wholesome æsthetic element. Any race that neglects or misapprehends Art gradually weakens its intellectual cognisance of æsthetic law, and finally confuses its practice and idea with other matters. The primitive instinct and experience having gone, education must be begun anew on a different basis in order to revive even a desire for the beautiful. At first the natural craving of men for beauty suffices to prompt to its pursuit. In the second stage of indifference we have to be *taught* what is beautiful. Man learns anew to enjoy objects to which his senses had grown callous, or, maybe, that even displeased them. Education has now become all important in matters of Art.

As regards Japan, the first consideration is to know what *not* to look for; next, what to. Every nation keeps in view its specific ideal. This type of perfection may have a realistic or idealistic physiognomy, or a mixed one of both features. An artist conceives a supernal being, but clothes it in the lusty charms of earth, as did Rubens and Rembrandt; the thought only being born of the spirit, while the model is of the flesh. Others, like Fra Angelico, eliminate material grossness, leaving to us a clear perception of the spirit. A Leonardo and Raffaele combine the two into another type of idealism, so graceful and pure that it is difficult to draw the line between their mixed motives. In fine, there is a vast variety of idealisms from the sublime eternisations of matter by Michael Angelo to the grotesque diabolisms and impish extravagances of the Japanese designers. We should keep steadily in view the exact impressions in these matters which a school of artists wishes to convey and its technical means. In the Art of Japan we are not to look for the metaphysical abstractions of that of Egypt, forms invented to awe and mystify the spectator; nor yet for the aim of the Grecian, perfect types of mental and physical beauty for poetical and sensuous enjoyment; still less for the more difficult ones of the mediævalists of Europe, who sought to bring down to the level of human recognition beings transformed by the glories of heaven. Each of these great schools took the human figure as the point of departure of their varied conceptions, striving to lift the finite into the infinite. The Japanese, on the contrary, manifest no similar ambition. Nevertheless, they have an evident ideal of female loveliness and manly strength; but the results, as types of beauty, are unpleasing to European eyes. By no latitude of taste can we like their cumberously draped men and women, with their narrow eyes, elongated noses and chins, false eyebrows, hideous toilettes of the head, want of grace of contour and action, and deficiency of elevated sentiment in their faces. Their gods and heroes impress solely by their extravagant attitudinising, furious action, or grotesque symbolisation. There is no attempt at beauty of outline, perfect modelling, or the intellectuality which we hold to be the mirror of a lofty soul. To a certain extent every effigy of their distinguished personages suggests a caricature. It would be curious to note what impression the best Grecian forms would make on a cultivated Japanese. Apparently his race is as callous to our types of beauty as savages to operatic music. A correct idea of the beau-

tiful in the human species as an Art-motive has yet to be developed among them. As they have never attempted anything in this direction, we must omit in our estimate of their Art the chiefest element and triumph of our own.

Architecture, in a noble sense, is equally unknown to them. By its means they show no spiritual longings, but simply make for themselves and their gods temporary homes and shrines, bizarre in construction, tent-like in principle, and in no measure responding to that instinct of immortality which incarnates itself in our finest ecclesiastical edifices.

This neglect of the most impressive of all the arts may be due in great part to the destructive earthquakes of Japan, which render any permanent architecture almost impossible. Be this as it may, painting, sculpture, and architecture, in their supreme significance—the *Fine Arts*, with the human soul and form as their fundamental motive; and human excellence, or spiritual loveliness, as their distinctive aim of expression—are not included in the æsthetic constitution of the Japanese. Keeping this fact in view, we may pleasantly study whatever they do attempt. Whenever their rule varies from ours it is justified in the result. Inside of their own scope they display a *finer* Art than we have ever imagined, based on a keen sense and delight in nature, apart from man himself. They do make an objective use of their own species, but with a different appreciation from ours. Having no feeling for plastic beauty, they cannot replace the Greeks, but they give us what these failed to bestow. Japanese Art is a fitting and graceful supplement to the European. Narrower in range, less profound in motives, it is more subtle, intense, and æsthetic in decorative expression; more full of delightful surprises; more rich in unexpectedness, so it may be called. This judgment will not surprise those to whom it is familiar, although it may be challenged by the ignorant. The best qualities of the old Art of Europe are unheeded now, because our senses as a people have fallen off from their former sensitiveness and knowledge. But with Japan we are called to experience entirely new and strong sensations, which astonish, and almost oppress, races now accustomed to be pleased with thin, pale tints, monotonous meaningless forms, vapid imitations of natural objects, and confectionery compositions. But, as is happening in the revival of polychromy derived from Greek practice, so with Japanese taste, as we make further progress in the science of Art, we shall learn to rejoice in many of its aspects whose strangeness at first almost repels our curiosity.

The highest use to which Japanese Art has put the human figure is exemplified in the statue of Daiboudhs, at Kamakoura, erected more than six centuries ago—a bronze effigy of Bouddha, 60 feet high, sitting with the knees doubled beneath the body on a lotus flower. The most impressive image of the Nile is animated as compared with the passivity of the great Hindoo reformer seen in this conventional likeness. He is enjoying the supreme bliss of Nirvana, that ecstatic unconsciousness, or non-existence, which Säkymouni holds out to his disciples as a final compensation for repeated lives in various forms on earth. A motive thus abstract obliges the artist to banish every trace of ordinary individuality from the features and form. Not even the look of passive reflection, which faintly discloses the *conscious* soul, must be allowed. The image is to suggest absolute self-annihilation—a human face reflecting the blank stare of eternal nothingness, which, baffling all inquiry into the future, bids mankind be consoled for present evils in its promise of a final absorption into the nothingness from which they spring. If it be difficult to impress dumb matter with the spirit of human thought and action, how much more difficult must it be to make it portray the most abstract idea man is capable of forming, and putting it into his own shape, which so eminently suggests action. Yet the sculptor has obtained a positive success. Retaining the common characteristics of the human figure largely conceived and broadly modelled, avoiding exactness in detail, he has raised a colossal statue which, while suggesting man, inspires less awe from

its massive proportions than its inscrutable calm, and measureless distance from mundane interests and cares. Whether, as a gigantic idol for the unlettered or an eloquent symbol of the most elusive of all metaphysical mysteries to the educated, it is a wonderfully indoctrinated effigy equally impressive to all minds. A people who could create it had the loftiest conception of the capacities of Art. The long, wave-like ripples of drapery that flow over its shore-like limbs, the gem-like head-dress of snail-shells, so effective as a symbolised ornament, the broad contours and masses, all harmoniously combine into a simple majesty of form and intensity of enigma.

There is no direct school of the nude in Japan, or love of it in their Art. In *genre* designs they depict common life with a free pencil; partial nakedness of itself in the labouring classes suggesting immodesty no more than the unclad limbs of animals. Oriental costumes of the better sort are more chaste in their fashioning than the styles permitted by the best society in Europe. In the sensual seductions of dress and calculated exposures of personal charms the European is more of an adept than the Oriental. In Japan the fashion, unchanged from generation to generation, is of a prescribed cut to virgin, wife, and courtesan; and each class of society keeps rigidly to its own. The garments of the women have a general resemblance to men's. They are made of narrow pieces of cloth or silk sewed at their edges, and falling straight from the shoulders, without any attempt to cut the stuff to fit or improve the figure. During cold weather, several of these, thickly wadded, are worn one over the other. Hence there can be no elegant flow of drapery, fine lines, and display of attractive points, as exist in Europe. Unlike their sisters of Christendom, the women of Japan of high position, when in full dress, are overmuch clad. Their beautiful contours are buried in heavy, angular, and sharply-adhering draperies, forming large masses of elegant and decorous, but awkward, clothing; concealing even the feet, and compelling a shuffling gait. Court etiquette obliges the men who come into the Imperial presence to trail after them long robes and trousers which dangle beneath their feet, giving them the appearance of approaching on their knees. Both sexes of rank being so completely covered by a costume extremely rich in colour, but incapable of fine flow of lines, it is easy to perceive whence comes the chastity of dress and the lack of graceful human form of the Japanese artists. At the same time their standard of modesty, free of any corrupting desire or influence, permits in their pictorial literature a liberal exhibition of family life and scenes of toilette such as we repudiate in ours. And yet the sensuality of the French school has no counterpart in their motives or design. Deities, heroes, and ladies, are equally overwhelmed with clothing. The artists manage their difficult drapery with skill, bestowing on it an amount of study which Europeans devote rather to the figure beneath. As respects this, the Japanese find more satisfaction in vigorous, muscular action than in beauty of person or graceful movement. Their chief effort, however, is given to make the design tell its story in an emphatic, realistic manner, with the smallest expenditure of technical means. In this sort of characterisation they excel. The key-note to their compositions is found in an active imagination, which revels in the terrible, homely, grotesque, mystical, and demoniacal. Their vision goes to the night-side of nature, ingeniously, frightfully, and often ludicrously personifying its phenomena; never rising to a lofty spiritual apprehension of their theme. Consequently, devils, demons, apparitions, and incantations of appalling shapes, abound in their Art; while the good or protective deities seldom rise above the burlesque or homely in appearance. Their functions are usually indicated by exaggerated members, forms of intense action, or superlative repose, instead of being spiritually reflected in their features or manifested by conventional symbols of holiness, except the *nimbus*, which Christian Art borrowed of paganism. The most comely deity is Ben-zai-ten-njo, the favourite of the seven household gods—a woman answering to

our Venus, in the full maturity of her charms, but profusely clad, usually sitting or standing by the sea-shore, playing on a musical instrument. Quamon, queen of heaven, similar in general appearance and greater dignity of manner, is too much absorbed in her own heautitude to be cognisant of the aspirations of mortals. Her *nirvana* is complete: indeed, the superhuman goodness of these celestial ladies, neither of whom is very beautiful, seemingly consists in their unconsciousness of any happiness except their own.

Hofksaii, who lived in the last century and was the founder of the latest and most original school of design, says it is easier to invent new forms than to draw exactly what one sees in nature—an opinion not in accord with European experience, but agreeing with Japanese practice. Besides the popular demonology, there is another reason for their passion for inventing new and curious forms, founded on their fantastic interpretation of the features of their landscape. Japan has always been a land of mystery and romance even to its own people. Its religions, rites, legends, and literature promote a mystical and pantheistic sentiment, degenerating into sorcery, exorcisms, and magic. The supernatural element in the national character is confirmed and intensified by the appalling typhoons and earthquakes which annually ravage the land. Their skilful jugglery is largely based on the popular belief in monstrous apparitions answering to the occult forces of nature. A class of diviners, analogous to the spirit-medium of America, invoke the shades of the dead. The imaginative bias has also an auxiliary in the grotesque and weird shapes, sometimes frightful, of the basaltic rocks by the sea and the dense forest vegetation, throwing out suggestions of uncanny things hiding in nature, awaiting the breaking of the spell that holds them by some disturbance of the elements.

The fiercest of the submarine monsters, lurking in the still depths of the fathomless waters, is Tatsmaki, dragon of the typhoon, the most terrible of their invented demons. Its frightful jaws snap together with a crash like thunder whenever his horned head, fury-lit eyes, and snake-like *antenna*, floating amid surging masses of coarsest hair, rises to the surface, during the loudest howling of the tornado; while its enormous green and ruby body and long tail, crested with gold like a flame, claws unclutched and threatening, mingles in the convulsive heave of the wind-lashed ocean, revelling in the elemental uproar; a fearfully magnificent image of the destructive force of the most terrible of storms to the sailor.

Japanese fancy indulges the bizarre humour, with a touch of caustic criticism on an "occasion" offering. It likes to transform the sacred utensils of Buddhist temples, vases, candlesticks, incense-burners, and images, into diabolical flying imps, holding high festival, under the direction of rollicking demons. Again, in a more sober spirit, we find it depicting the separation of the soul from the body after death, heralded, as the mediums declare, by a slight crackling noise. Assuming its phantom life it hovers awhile over its own corpse, taking its general appearance, and reflecting its principal traits while living. A touch of the ludicrous, which the Japanese artist never refrains from when any opportunity is given, is often thrown in, generally in the person of an affrighted witness. Ghosts are no greater popular favourites in Japan than elsewhere. Sometimes a moral lesson is hinted, as in the shade of a mother who has committed suicide, leaving an infant destitute. She is made to haunt the spot of her crime, bowed down with remorse, until she can find some one to assume the charge which she wickedly abandoned. Criminals are forced to hover in prolonged misery about the scene of their execution. We see no visions of a celestial paradise according to the Christian idea. The outlook into the unseen is retributive, and appalling in almost every instance given. This comes perhaps from the doctrine of the annihilation of the righteous—a dogma which effectually bars the imagination from depicting individual happiness beyond the horizon of human life.

We must, however, discriminate between the motives and styles imported from China and

those strictly indigenous. There is a marked difference between them. The genuine Japanese is characterised by vigorous natural traits. It is by turns strongly individualistic, idealistic, or naturalistic; intensely sincere and local, lively in fancy as in movement and tint, and borrows less from its neighbours than it is able to give back; but, owing to its insular position, exercising no influence outside of its own borders, at least until a year or two ago, when it attracted the attention of some European artists, and excited the enthusiasm of foreign amateurs. Daiboudhs doubtless owes its type and motive to the ancient Buddhist sculptors of India. There still exist in Ceylon and Java similar works of earlier date. The true Japanese are impregnated with the opposite qualities of vehement realistic life, although subjects drawn from Buddhism retain somewhat of its mystic and contemplative spirit, even under the vigorous guise given to them by the native draughtsmen. But this kind of Art-composition is simply Chinese and Hindoo ideas put into the æsthetic vernacular of Japan, strengthened in the translation. In lieu of a feminine tameness of characterisation we get masculine strength and action by means of forcible touches and tints. A striking example is to be seen in the *Trial of a Soul*, composed of six figures, admirably distributed and delineated. The Judge of Hell is seated at a draped table on which lies the book of law, regarding with compassion the execution of the sentence he has pronounced on a wretched mortal held down by one fiend while another is administering the prescribed blows with swinging force. His good genius, neglected in his life, stands sorrowing in the back-ground. The evil one, having consummated his mission, gloats over the final scene in close proximity to his victim. There is no supernal horror such as is depicted in the ordinary Christian pictures of this class. Indeed, in feeling and design the composition recalls the Etruscan style of telling the same tale of woe. Each figure is appropriately costumed, grouping and action are simple and serious, and the meaning plain and suggestive. The torturing devils have countenances worthy of their cruel functions, which are further indicated by bestial horns. As a spectacle, the picture might fittingly represent the usual rapid process of Oriental justice, except that the solemn gravity of the principal actors announces that more than common interests are at stake. A noteworthy point is the contrast between the grim satisfaction with which the uplifted hands of the evil genius beats the time of the avenging strokes, as if they were music to his ears; and the pitiful gaze of the judge as he leans almost protectively towards the writhing wretch, and clasps his hands in convulsive sympathy.

There is another picture which haunts my imagination like an apocalyptic vision. It is on silk, mounted on ivory rollers. The composition combines profoundest mysticism with extreme simplicity of treatment and extraordinary grandeur of inventive design, filling the mind with : consciousness of primeval spheres when the world was formless and void. It is as a voice out of the night of ages, deep calling to deep, as the Divine Will bids light and water and earth appear. There is an art that baffles description and defies analysis. Its power is over the soul into which it enters as a spiritual tonic, electrifying it with a fresh current of immortality. Pagan although the conception might have been, it imparted its mystic awe to my inmost being, and made me feel as if in the symbolical presence of the Supreme.

I will briefly recount its features even at the risk of making this confession seem pure hyperbole. Those who have senses only for sheer human uproar can deride and pass on. What can they see in the deep-drawn breaths of this illimitable ocean, whose vast storm-waves sweep onwards before the hurricane in foaming hemispheres, until lost in the driving heaps of dark clouds that repeat their forms, and mingle air and water in a vapoury mass on the distant horizon? But look! In the foreground rises a sharp volcanic rock, edged with green, over which the salt spray dashes in claw-like spurts. The sacred turtle of the Japanese mythology, trailing after it the fabulous leathery appendage which forms its fan-like tail, has climbed out of

the sea to its surface, and is looking upwards into the sky, watching a spiral vapour, or breath, of so translucent a substance as to let the murky background of sullen atmosphere, relieved above by a broad belt of greyish ominous light, be seen through its more ethereal matter. This mystical air-spout descends, in a constantly diminishing column with a spirit-like movement, to the mouth of the turtle, from the beak of Tsouri-Sama, the holy-lord; a gigantic crane, emblem of longevity and peace of soul. Its immense milk-white form swooping downwards with majestic stroke of wing; its jet-black neck and head topped by a crimson crest, and curling gracefully towards the turtle on which its piercing eyes are fixed; with its equally black tail and legs thrown upwards in a sublimely conceived action, balancing the similarly bold and grand movement of the wings; these all make up a mysterious figure, in relief against a blood-red orb, whose lower edge is lost in driving mists. The upper "portion of its disk gives out an intense lurid glare, like that of the sun when half-shrouded in fog; while far above, and extending on either side, shines the infinite empyrean. Does Milton's verse—

"Those who with mighty wings outspread
Dovelike sat brooding o'er the dark abyss
And made it pregnant"

equal this? Were ever the cosmic creative forces better symbolised by Art? *

JOHN JACKSON JARVES.

Florence.

OBITUARY.

SIR GEORGE HAYTER, K.S.L.

MORE than half a century ago the name of this now nearly-forgotten artist, who died on the 18th of January, at the age of seventy-eight, was almost as well known, if not so highly appreciated as a painter of portraits, as his contemporary Sir Thomas Lawrence. The son of Mr. C. Hayter,—an artist of considerable reputation, whose talents had gained for him the appointment of professor of drawing and perspective to the Princess Charlotte, afterwards married to Prince Leopold of Saxe-Coburg,—Sir George was born in St. James's Street, London, 1792. Whilst young he entered the schools of the Royal Academy, where he obtained two medals. It has been stated that he entered the Royal Navy, and was a rated midshipman in the service at sixteen years of age. However this may have been, he could not have remained very long in the navy, for in 1815 he was appointed "Painter of Miniatures and Portraits to the Princess Charlotte and Prince Leopold of Saxe-Coburg," the late King of the Belgians. In the year following he went to Rome, and there studied till 1819, when he was made a member of the Academy of St. Luke in that city. Returning to London he took up his residence here as a painter of history and portraits, and remained till 1826, when he went back to Italy, and was elected a member of the Academies of Parma, Florence, Bologna, and Venice. On his way homewards he stopped for a considerable time in Paris, painting portraits. On the accession of her Majesty he was appointed "Portrait and Historical Painter to the Queen;" and in 1841 "Historical Painter in Ordinary to the Queen," from whom he received the honour of knighthood in 1842; some years previously he had been made a knight of the Persian order of the Lion and the Sun.

We have remarked that Sir George Hayter was almost as much in requisition as Lawrence; and it will only be necessary in support of the assertion to offer a list of

some of the numerous individuals among the aristocracy who sat to him for their portraits, either life-size or as miniatures, in addition to those he painted of royal personages. Between the years 1824 and 1833, including five years when he was absent abroad, he sent to the Academy portraits of the Earl of Surrey in his robes as first page to George IV. at his coronation, of the Dowager Countess of Pembroke, Lord Lynedoch, the Archbishop of York, Earl Clare, Earl of Essex, Bishop of Chichester, Sir H. C. Coote, Lord Alexander G. Russell, Lord Francis Leveson Gower, Countess of Warwick, Lord Stuart de Rothsay, Lord John Russell, the Baroness de Delmar, the Countess of Lichfield, Viscount Melbourne, &c., &c. In 1838 he exhibited the 'Portrait of the Queen, seated on the Throne of the House of Lords, painted by her Majesty's command for the City of London.' That we believe to be the last year in which Sir George Hayter appeared at the Academy; he was then in the prime of life, and at the height of his popularity; it cannot, therefore, be assumed that he had retired from practice, and it is somewhat singular that he should have thenceforth so persistently abstained from exhibiting. Whether or not he was ever a candidate for admission into the Academy we know not.

As a painter of history Sir George obtained but little reputation; his best-known works—indeed, we are unacquainted with any others worth mentioning—are 'The Trial of Lord William Russell, at the Old Bailey, in 1683,' painted for the late Duke of Bedford, and exhibited at the Academy in 1825; 'The Coronation of Queen Victoria' and 'The Royal Marriage;' 'The Trial of Queen Caroline, in the House of Lords,' and 'The Meeting of the First Reformed Parliament,' all of which have been engraved. As a writer he is known as the author of an appendix to the *Hortus Ericæus Woburnensis*, on the classification of colours, with a diagram containing 132 tints, with nomenclature.

ALEXANDER MUNRO.

We regret to record the death of this eminent sculptor, on the 1st of January, at Cannes, where, during the last four years, he had resided in the winter months, on account of delicate health.

He was born at Inverness in 1825, and about the year 1848 or 1849 came to London; here he was introduced by the Duchess of Sutherland to the late Sir Charles Barry, then engaged on the erection of the Houses of Parliament, who found him occupation on the sculptured works of the edifice. This employment was, however, not congenial with his taste and feeling, so he soon sought out other fields of labour. In 1849 he exhibited some busts at the Royal Academy, and continued for some time to contribute works of this kind, both male and female. His first ideal sculpture exhibited was a very beautiful group, 'Paolo and Francesca,' the plaster-study of which was seen in the International Exhibition of 1851, where it attracted the attention of our present prime minister, Mr. Gladstone, who gave the sculptor a commission to execute it in marble; this was exhibited at the Royal Academy in 1852. In the year following he contributed to the same gallery 'The Brother's little Pet,' a group of two children of the late Mr. Herbert Ingram, proprietor of the *Illustrated News*; 'Egeria,' a sketch for a statue for a fountain; 'The Seasons,' a frieze for a chimney-

piece; and a medallion, in marble, of Lady Constance Grosvenor.

A colossal marble bust of the late Sir Robert Peel, now forming a part of the Peel memorial at Oldham, a bust of Mr. Millais, R.A., a medallion of Lady Alwyne Compton, a bronze of the Chevalier Bunsen, with other like works, were seen in the Academy exhibition of 1854. In that of the following year he contributed several examples, conspicuous among which were 'Child-play,' a marble group of the children of Mr. Herbert Ingram, and a bust of the Rt. Hon. W. E. Gladstone, of whose children, a son and daughter, a marble group in alto-relievo, he exhibited in 1856, with 'Repose,' a study in marble of an infant, and several other works. To enumerate all Mr. Munro's varied contributions to the Academy would be to give a very long list; but we may point out among the most conspicuous 'Hippocrates,' the model of a statue to be presented by Mr. Ruskin to the new museum at Oxford (1857); 'The Lover's Walk,' a group in marble, and 'Undine' (1858); 'The Young Hunter,' 'The Brothers,' and 'Joan of Arc' (1862); 'Young Romilly' (1863); 'A Sleeping Boy' (1864); 'The Duchess of Vallambrosa,' an alto-relievo (1869).

But there are many other important works from the hand of this highly-gifted sculptor which have never met the eye of the public in the galleries of the Academy; for instance his statues of Galileo, Davy, and James Watt, companions of his Hippocrates in the Oxford Museum; his colossal statue of Watt, at Birmingham; a colossal statue of Mr. Herbert Ingram, at Boston; the statue of Queen Mary, consort of William III., in the Houses of Parliament; and a statue of a nymph serving as a fountain placed in Berkeley Square by the late Marquis of Lansdowne. Though all these works show talent of a high order, Mr. Munro specially excelled in female busts, and in his representations of children both singly and in groups; in all of these there is refined and delicate sentiment, a quality which, in the case of the "little ones," was often allied with graceful fancy. "Few artists," said a recent writer, "ever numbered a larger, more various, or more deeply-attached circle of friends, by whom his memory will always be cherished as among the purest, sweetest, and most lovable of men."

ALEXANDER G. HENRI REGNAULT.

It was not to be expected that the artists of France would be absent from the ranks of the brave men of all classes who banded together in the heroic though, as the result has proved, vain attempt to roll back the strong tide of invasion that has recently overrun and desolated the fair provinces of their country; and not a few have sacrificed life to their patriotic devotion. Among the latest who have thus fallen is Henri Regnault, who was killed, with many of his comrades of the Garde Nationale, at the attack on Montretout, on the 19th of January, at the early age of twenty-four. He was son of M. Regnault, the accomplished director of the porcelain works at Sèvres, whose taste and cultured mind had no little influence on the Art-education of the young painter, who studied under Cabanel, and entered the school of the *Beaux Arts*, in Paris, where, in 1866, he carried off the *Grand Prix de Rome*, and, in 1869, gained a medal. Two pictures, 'Salomé' and 'Judith,' exhibited by him last year in the *Salon* at Paris, received from critics and his brother-

* To be continued.

artists high commendation. Among the French pictures exhibited but very recently in the German Gallery, Old Bond Street, were two contributed by Regnault: one 'An Execution in the Alhambra,' the other an equestrian portrait of the late General Prim, who is surrounded by a crowd of enthusiastic admirers. Both these works were pointed out in our pages of last month as among the most noticeable in the collection. When the war broke out, the artist, it has been said, "was at Tangiers, in Morocco, painting the large picture which now hangs in the gallery in Bond Street as his last work;" but he hurried home to take part in the defence of his country, notwithstanding his position as the winner of the *Grand Prix* would have exempted him from serving. By his untimely death France has undoubtedly lost a painter who gave good promise of a distinguished future.

OTTO WEBER.

The death of this artist, slain towards the close of last year while fighting in the ranks of the Gardes Mobiles of Paris, must also be reported. He was a native of Berlin, but had lived a considerable time in Paris, where he studied under T. Couture. M. Weber gained considerable reputation for his skill as an animal-painter.

MAX EMANUEL AINMULLER.

Among the deaths announced towards the close of last year was that of the above artist, known chiefly as a painter on glass. A Munich correspondent of the *Architect*, writing from that city on the 18th of December, says: "We have sustained a severe loss in the death of Max Emanuel Aijnmüller, one of our Art-veterans, who breathed his last here on the 8th instant. Born in the year 1807, he devoted himself to architecture on his entrance into the Munich Academy. Here, however, he showed a special talent for ornamentation, and devoted himself to this branch of Art. On completing his studies he received an appointment as ornamental designer in the Royal Porcelain Manufactory at Nymphenberg, but quitted this to join Frank in glass-painting, for which he felt a decided inclination. He applied himself specially to the technical branch of this Art, and we do not assert too much in saying that it owes to his unflinching exertions that distinguished position amongst the sister Arts which it now holds. In former years he also drew the greater portion of the ornaments in the large windows produced by the celebrated manufactory at Munich, and justly shared the European fame that establishment then enjoyed, and sustains at the present day. Under his direction were produced the splendid glass-paintings for the Cathedrals at Ratisbon, Cologne, and Speyer, for the churches of Au (a suburb of Munich), the University church at Cambridge, and latterly for St. Paul's Cathedral, in London, the Cathedral in Glasgow, and some public buildings at Edinburgh. His former studies in architecture subsequently led him to architectural drawing, in which he was distinguished, both for the beauty and correctness of his designs, principally in the Gothic style. Aijnmüller has contributed much to the splendour of the new Pinakothek. The Academy of Munich recognised the merits of their former pupil by admitting him as a member of their body, and he was honoured with several orders."

Besides the works above mentioned, Aijnmüller executed some paintings on

glass for the Israel Church in St. Petersburg, representing the *Salvator Mundi*; one in Hamburg, from a picture by Overbeck; at the English church, Stuttgart; in the choir of Augsburg Cathedral, after Schrandolph; and in Basle Cathedral, after Fortner. Our readers will doubtless remember the controversy that appeared, two or three years ago, in our own and other public journals, in allusion to what some were pleased to call the "vitreous transparencies in Glasgow Cathedral and elsewhere in Great Britain, which provoked the condemnation of artists and architects, who, recognising the decorative principles by which the Art of the glass-stainer should be ruled, and finding that these works are transparent pictures, displayed by transmitted instead of reflected light, find in them violations of the logic of design."

MISS LOUISA HERFORD.

The death of this young lady, who gave promise of becoming an excellent artist, was announced towards the close of last year: it ought not to be passed unnoticed by us, inasmuch as she was the first female pupil admitted into the schools of the Royal Academy. Now there are many; all of whom, probably, owe their advantages to Miss Herford's bold venture, when she sent in the usual drawing required from candidates for admission. It was signed "L. Herford," and the examiners admitted it, assuming, it may be supposed, that it was the work of a male, and not that of a lady. When, however, the author's name became known, objections were made to her admission; ultimately her claim to become a pupil was allowed, and, as a matter of course, the doors of the school were opened to other female-candidates, if found to be duly qualified.

ILLEGAL LOTTERIES.

THE Treasury has "come down" on one of the illegal Art-Unions, the originators of which have not had the wit to take shelter under the very corners of the Act of Parliament. Mr. J. Cannon, a jeweller, had to make his appearance before the Lambeth police-court on the 20th of January, in answer to the charge preferred against him by the Treasury of having promoted an illegal lottery, under the title of the South London Art-Union. The publican at whose house the tickets were drawn was also prosecuted. Mr. Straight, for the defendants, complained that his clients had been proceeded against for this lottery when they could, being respectable, have obtained permission to hold it by application to the Privy Council. We agree with the learned counsel that great injustice has here been done. Only—we put the boot on the other leg. The wrong of the case, in our view, is, that by a simple application to the Privy Council persons may, and do, defeat the object of the law; and that neither the Privy Council, nor any one else, takes any heed how the formal permission, when obtained as a matter of course, is used or abused. Witnesses were called to prove that the "drawing" was properly conducted, and that none of the subscribers present were dissatisfied with the *modus operandi* of Cannon. The same, no doubt, might be said of all the shilling little-goes. Nothing but the most flagrant stupidity would allow the appearance of foul play in the drawing. Neither, it was urged, were there any money-prizes. Of course not: why should there be? Mr. Cannon was, probably, no worse, and no better, than his rivals who have the good fortune to be able to advertise "under the authority of the Government." The magistrate took a very simple view of the case. It was not necessary, he said, to enter into the question whether lotteries were properly carried

out, for, under any circumstances, they opened the door to great frauds. It is this which we have all along urged. In the shilling lotteries which have come under our notice there is absolutely no guarantee of fair dealing—no check whatever on the relation between receipts and prizes. It lies altogether in the bosom of the secretary, or manager, or prime mover of the concern, to determine whether there shall be even a record of the receipts. If the tickets are serially numbered, there may be such an account; but there is nothing to prevent its being kept in a private pocket-book, or served, as the bill for the palace of Versailles was served by Louis Quatorze—put into the fire, that no one should know the amount. A certain number of prizes are catalogued, a certain series of lucky numbers are drawn and duly advertised: the uncertain amount of shillings received drops out of sight.

Mr. Ellison said there could be no doubt that the entire proceedings were illegal. He was not prepared to say that there had been any fraudulent transaction, or any intention to defraud. Still the law had been broken. The defendants had rendered themselves liable to imprisonment as rogues and vagabonds. With this very definite hint they were allowed to retire, only entering into their own recognisances to come up for judgment if called upon. This is all very well. A severe sentence, in view of the immunity granted by the Privy Council for precisely the same proceeding to any one who takes the precaution of asking for it, would have been too iniquitous. But we wonder with what sort of complacency Mr. Poland enjoyed his triumph when he was unable to deny that the defendants had been cast only because they had been less provident than their predecessors—they had not "obtained permission." Hence the illegality. If the law be such, it is high time that it was altered. The encouragement of legitimate Art was the object of the freedom given by statute to the subscribers to Art-Unions from the penalties afflicting the keepers of lotteries. Can any one pretend that shilling Art-Unions lead to this end?

SELECTED PICTURES.

FROM THE PICTURE IN THE COLLECTION OF W. COTTRILL, ESQ., SINGLETON HOUSE, HIGHER BROUGHTON.

THE SPRING OF LIFE.

H. Campotosto, Painter. J. C. Armytage, Engraver.

IN this picture, as in the other large engraving introduced into this number, we have an example of the modern school of Belgian painters. M. Campotosto is a *genre* painter who is rapidly making as good a reputation here as he has already done in Brussels, where he resides. The works exhibited by him in the International Exhibition of Paris, in 1867, gained very favourable notice in that city. Subjects of such a description as 'The Spring of Life' are certain of finding admirers, though they may not attract by any display of impressive incidents. A quiet, unassuming "touch of nature," whether of the grave or the gay, so long as it is presented in a truthful and really artistic manner; is rarely passed unheeded and unappreciated, and of this character is the picture before us. Two young peasant children, of Belgian type, have repaired to a stream, probably from some light labour in the field, to quench their thirst; which they are enabled to do without any personal inconvenience, having had the foresight to provide themselves with a jug of tolerably large dimensions: this the elder of the two holds to the lips of her companion with judicious care. The composition in itself offers no text for lengthened comment; it tells its own tale very prettily and very naturally.



H. W. H. PHOTO. INX.

W. A. S. W. PHOTO. INX.



THE MUSEUMS OF ENGLAND,
WITH
SPECIAL REFERENCE TO OBJECTS
OF ART AND ANTIQUITY.

BY LLEWELLYNN JEWITT, F.S.A., &c., &c.

THE SCARBOROUGH MUSEUM.

SCARBOROUGH, which has taken to itself, or had given to it—it matters not which—the appellation of “Queen of Watering Places,” is fortunate in possessing, although small in extent, a Museum containing many objects of the highest interest. I have therefore chosen it for my present article, and doubt not that choice will call increased attention to its treasures from visitors in the coming “season.”

Scarborough itself, as our readers well know, is at once one of the most beautiful and charming, as well as most fashionable, of our English watering places; and, as a summer resort to seekers both of health and of pleasure, possesses peculiar attractions and advantages. Those who come for health find it in the Spa, rich in carbonates and sulphates of lime and magnesia; and in the pure air and the magnificent sea, the one of which they inhale with every breath, and in the other they can bathe to their heart's content. Seekers of pleasure may find it in the esplanade, the promenades, the music-saloons, and other places of fashionable resort. Those who come for either or both of these purposes,

and desire to add usefulness and instruction to them, will find abundance to gratify and interest them in an examination of the grand old Castle, and in St. Mary's Church and the Museum. It is with the latter of these only, however, that I have now to do.

The Museum at Scarborough is situated near the Cliff Bridge on St. Nicholas's Cliff. It is a rotunda terminating in a dome, and is built in the Roman Doric order of architecture. It was founded and erected in 1828, at a cost of about £1,300, from the designs of Atkinson and Sharpe, and it forms a striking object in connection with the beautifully laid out grounds and terraces around it. Recently two wings, one on either side, and of considerable length, have been added. They are of the height of the ground floor, each wing being three windows in length, and of corresponding style in masonry with the central rotunda.

The Museum contains a remarkably fine and valuable geological collection, arranged by William Smith, “the father of modern geology,” who was born at Hackness, in this neighbourhood; an extensive and well classified collection of jaspers, agates, &c., from the Scarborough coast and its neighbourhood, which is most useful to the visitor in assisting to arrange his own “finds” in the locality; an excellent marine aquarium; a number of natural history specimens; and many miscellaneous objects. But, besides these are a goodly number of objects of ancient Art and of antiquity, which are especially worthy of note.

One of the most prominent objects—and its importance is much enhanced by its extreme rarity—is a tree-coffin with the skeleton found in it, of the ancient British period. Of this curious relic it is necessary to give some few particulars. It was discovered in 1834, at Gristhorpe, on the summit of a high hill between Scarborough and Piley. On this hill were three

tumuli, the northern and southern of which, on being opened, disclosed urns with burnt bones, and were, therefore, good examples of burial by cremation; the central one contained this tree-coffin, and was a peculiarly curious example of burial by inhumation. The tumulus measured 2 feet in height and 40 feet in diameter, and consisted of stones raised over a pit dug in the clay of the diluvium to the depth of 6 or 7 feet. At the bottom of this pit, or cist, lay this large coffin, covered with a quantity of oak-branches, over which was spread a layer of clay. The coffin, which is here engraved, consisted of the trunk of a large oak-tree split down its middle into two portions, and roughly hewn on its outside. It was hollowed to admit the body. “The markings seemed to indicate that it had been hollowed with chisels of flint; but the tree had been cut down with a much larger tool, the marks being such as would be made with a stone hatchet. It is 7 feet 6 inches long, and 3 feet 3 inches broad. In the bottom is a hole 3 inches in length. The lid was kept in place by the uneven fracture of the wood. The bark was in good preservation, with its coating of lichens distinct. At the narrow end of the lid, cut in the bark, was a sort of leaf-shaped knot, perhaps intended for a handle. In the coffin was the skeleton of a very large and powerful man, of about seventy years of age, surrounded by water, floating on which was a quantity of pulverulent adipocere (a kind of waxy powder). The well preserved state of



TREE COFFIN FROM GRISTHORPE.

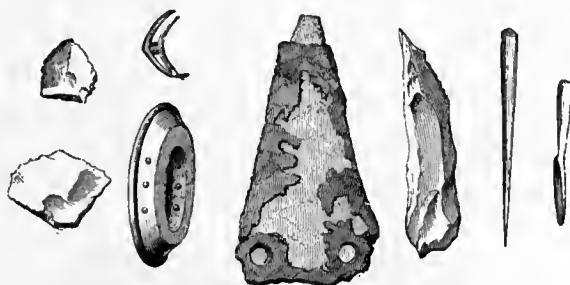

BRONZE DAGGER, ETC., FOUND IN THE TREE COFFIN.



TREE-COFFIN FROM GRISTHORPE.

the skeleton and its dark ebony colour were no doubt due to the tannin and gallic acid of the oak, the free access of water, and the nature of the enclosing clay cist, impervious to air.” The body had been laid on its right side, with its head to the south and face to the east. The skeleton measured at least 6 feet 2 inches (the femur measuring 19½ and the tibia 16½ inches), so that the man when living must have been tall and powerful. He had been laid in the usual contracted position with the knees drawn up, so characteristic of the British period. The inside of the coffin measured only 5 feet 4 inches in length.

The body had been wrapped in the skin of some animal having soft hair like that of the sheep or goat, and fastened at the breast with a bone pin 3 inches in length. In the coffin were found, with the skeleton, three flakes of flint; a bronze dagger, which had been attached to its handle by two rivets; a perforated bone disc, probably a part of the handle; “the fragment of a ring of horn—a fastening, perhaps, of the dress; a small implement of wood, with a rounded head; and the bone pin already alluded to.” On the lower part of the breast was an ornament of a very brittle material, in the form of a rosette, with loose ends: by the side was a shallow basket, about 6 inches in diameter, formed of bark, curiously stitched with the sinews of animals. At the bottom of this basket were decomposed remains, probably of food. There was a quantity of lanceolate

foliage and decayed vegetable substance, supposed to have been the remains of mistletoe.

The skull of the skeleton found in this coffin, and which is probably that of a chief of importance of the great Brigantian tribe of Britons, is extremely large and of great capacity—being represented by no less than 84½ ounces of sand—and is remarkable both for its thickness, elevation, and breadth. It has been carefully described and illustrated by Dr. Thurnam in the “Crania Britannica,” and has thus been described by the late Professor Retzius, the distinguished anatomist and craniological ethnographer:—“The form of the outline is a broad oval; the length exceeds the breadth by about a sixth. The upper surface rounded; the forehead slightly arched, low and broad; the temple arched and full. The parietal tubers strongly developed; the sides of the skull almost perpendicular. The occiput, seen from behind, nearly square, and, as in the Finns, rounded: it is not so abrupt and short as in most brachycephalic skulls; the superior semicircular lines and the occipital protuberance strongly developed. The mastoid processes large; the auditory passages much behind the middle of the long axis. The superciliary arches and part of the glabella project strongly from the frontal region. The nasal bones directed upwards. The orbital caroties large. The malar eminences small; the zygomatic arches but little prominent. The teeth have a slight projection forwards, and are much worn away

horizontally. The jaws tolerably large and well-proportioned, and the hollow of the cheeks much depressed.”

Several other tree-coffins, it may be well to note, have been at one time or other found in Yorkshire tumuli, and elsewhere; the last on record being discovered by the Rev. Canon Greenwell, at Scale House, Rylestone; and described, along with the Scarborough example, in the *Reliquary* for July, 1865.

Another remarkably interesting object is an ancient British necklace, found in a barrow opened some years ago near Egton, in the North Riding of this county. It consists of twenty-eight long beads, six circular studs, and a central ornament, decorated with punctured ornaments in lozenge form. It is formed of jet, but of that inferior kind known in this jet district as “jet wood.” The centre ornament is, however, made of what is known as “best jet.” Along with this necklace a jet bead and some flint implements were found.

The Museum is peculiarly rich in examples of Celtic pottery, including both cinerary urns, food-vessels, drinking-cups, and so-called “incense”-cups, which are, I believe, neither more nor less than small urns for the reception of the ashes of infants, so that they might be placed within the larger urn containing the remains of the mother. This is abundantly proved to my mind by recent discoveries, in which these small vessels have been found in the mouths of the larger ones, and, like them, contained burnt

bones and ashes. Whether the infant, as in many cases is likely, was sacrificed on the death of its mother, in the belief that it would thus partake of her care in the strange land to which by death she was removed, or whether it died from natural causes, it was a pleasant thought to bury its remains with those of its parent in the way these urns indicate.

Among the Celtic pottery alluded to, some of the more noteworthy examples are:—

From a barrow at Way Hagg, on Aytou Moor, opened in 1848, an "incense-cup," 3 inches in height, and 2½ inches in diameter at the top, ornamented with lines of punctures, and having, as is not unusual, two perforations, one on each side; and a fine cinerary urn of the type so prevalent in Derbyshire and the surrounding counties, 15 inches in height, and 12½ inches in diameter at the mouth, ornamented with encircling and herring-bone, or zigzag, lines, produced by indenting thongs into the soft clay. In this urn a bone pin, several flint implements, and a bone ornament perforated with two holes for suspension, were found, and are preserved in the Museum, as



SPECIMEN OF SCARBOROUGH WARE.

are also some singular perforated stones from the same barrow.

From the Ravenhill barrow, opened in 1849, a cinerary urn with herring-bone, or zigzag, ornament on its rim, 6½ inches in height, and 4½ inches in diameter at the mouth. Another cinerary urn of nearly the same size, ornamented on its rim with lines of punctures; and a remarkably pretty "incense"-cup, ornamented with reticulated lines, and having two perforations in its side. From this barrow, likewise, are some perforated stones of the same character as those from Way Hagg. There are also the remains of a large urn, in which, among the bones and ashes, were found several flint implements, a portion of a flint celt, and a bronze pin.

From a barrow on the cliff, near Scarborough, called Weapon-ness, from the primary interment, a food-vessel of remarkably good form, 5 inches in height, and 6 in diameter at the mouth, elaborately ornamented over its entire surface, with encircling and diagonal lines of the usual character; and from the secondary interment, a cinerary urn 12 inches in height, the same in diameter at its mouth, also elaborately ornamented. From the same barrow will be noticed a stone hammer and a leaf-shaped spear or arrow-head of flint. This barrow, it may be well to note for the information of the visitor, was 30 yards in circumference. The primary interment was in the centre, in a stone cist, the skeleton being found in the usual contracted position, and having the food-vessel

behind the head. This cist was covered with a large flat stone, over which a mound of loose stones was raised. The secondary interment, an inverted urn containing burnt bones,



MEDIAEVAL GROTESQUE VESSEL, SCARBOROUGH WARE.

was found near the south-west edge of this stone cairn, and near it were the stone hammer and flint implement. Over the whole of this a layer of earth of about 3 feet in thickness made up the remainder of the tumulus.

From Com-Boots, or Camp-Butts, near Hackness, an "incense"-cup is worthy of special notice: it is 1½ inches high and 3 inches in diameter, ornamented with indented horizontal and diagonal lines, and bearing the remarkable feature of having fifteen upright perforations, or incisions, in its circumference. This variety of small urns with incisions is of rare occurrence; and the Museum is fortunate in possessing another excellent, and more elaborately ornamented, example with six holes cut through in its circumference.

Besides these, are several other urns of the same period from other barrows in the neighbourhood.

There is also a goodly collection of flint implements, exhibiting most of the usual forms found in the district, which is especially rich in such remains. It was in this neighbourhood, it will be recollected, and at Whitby, and other



TWO-HANDLED CUP OF SCARBOROUGH WARE.

places on the coast, the prince of fabricators, "Flint Jack," carried on so successful a trade in selling as ancient flint implements those

of his own forging. The examples in the Scarborough Museum are, however, genuine specimens, found in the barrows of the district; and many of them are of very interesting character. The same remark will apply to the celts and to the stone hammers.

Among the flint implements are several remarkably fine barbed arrow-heads, and others of the leaf-shaped and angular varieties, as well as dagger-blades, spear-heads, flakes, &c., from a barrow on Robin Hood Butts, from Howden, from Scarborough, and other localities. There is also, found near Scarborough, a remarkably good example of socketed bronze celt, with loop, of the usual form.

Among the Roman remains, which are few, is a singular cinerary urn with a lid. This very unusually formed vessel, 18 inches in height, was found at Knapton, near Scarborough, and contained a deposit of burnt bones. The rare feature connected with this example is the lid, of the same kind of clay as the urn itself, with which it is covered, and of which but few specimens have been brought to light. A fibula of the same period, found near Hull, is



SPECIMEN OF SCARBOROUGH WARE.

also preserved. There is also a very nice Anglo-Saxon fibula, found near Scarborough.

Among other curious remains are some of considerable local interest, illustrating as they do an

Art lost to the neighbourhood. These are remains of mediæval fictile vessels of singular form, which were discovered on the North Cliff, Scarborough, in 1854. An account of this discovery was drawn up by Mr. Leckenby, to whom I am greatly indebted for the valuable assistance he has rendered me in the preparation of this account of the Museum, and for his readiness at all times to assist in any archaeological inquiry. From the account drawn up by Mr. Leckenby, it appears that during some excavations carried on by Mr. Nesfield, "were brought to light a long series of arches, forming what had evidently been the kilns of the pottery, the structure of the bricks of which they were composed being admitted by competent judges to belong to the fourteenth century." Two of these arches were removed to the Museum. Among the fragments found were some grotesque heads, probably portions of handles, and a singular vessel, of which the accompanying is an engraving, made in form of an animal, with a twisted horn. It is of the same class of ceramic productions as the one engraved in my account of the Salisbury Museum (page 346 of the last vol. of *Art-Journal*). It is, with the exception of the feet, covered with a green glaze. Other examples of Scarborough pottery are a two-handled vessel of unusual form, and a portion of another vessel in form of an animal.

Among the other noticeable articles in the collection may be briefly named the following:—
Some querns, or hand-mills, probably of the Anglo-Saxon period, and of the usual forms.

A cross-legged effigy of a knight, supposed to be a De Mowbray, "brought from the lower part of the town," but the original locality of which, probably the old church on the cliff, is not known. The effigy is 8 feet in length and 2 feet 6 inches in width, and is in a dilapidated condition.

Several Egyptian antiquities, including a coffin from Thebes.

Some curious keys, from Scarborough, Pontefract Castle, and other localities.

A capital of a pillar, found among the

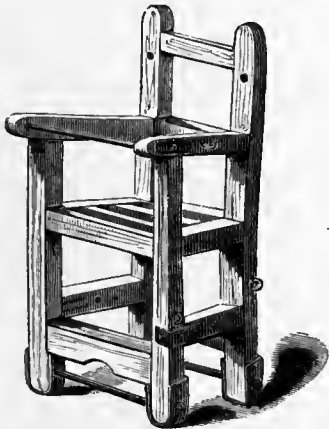

THE SCARBOROUGH DUCKING STOOL.

ruins of the old chapel in the Castle-yard, beautifully sculptured on one side with the Crucifixion, with a figure on each side the cross, and on two others a figure with mitre and crozier. Another stone, from the wall of St. Thomas's Hospital, with initials and the date 1575. The main bell from the same hospital, and a stone which was formerly fixed in a wall near the Bar, and bearing an inscription recording the fact of the town's defences being set in order at the time of the rebellion of 1745.

There is also a small brass plate, found on St. Nicholas Terrace, bearing the inscription FR WILLIS DE THORNTON, in Lombardic capitals. This William de Thornton was, according to Hinderwell, living in 1120. The brass,

most probably, is a relic of the now totally lost Church of St. Nicholas, on whose site it and other remains have been found.

Two old fons, an antique corset, an interesting hunting-horn, and a wooden drinking vessel of curious construction, are worthy of note.

One of the most singular local remains, however, preserved in the Museum, is the old *Ducking-stool* belonging to the town of Scarborough; and to this obsolete instrument of punishment for scolding women it is necessary to draw attention. Corporations of towns and lords of the manor, as well as others in the Middle Ages, had the right of inflicting punishment for various offences committed in their jurisdiction; and as they took to themselves the power of inflicting punishment, so they generally devised the mode by which it was to be inflicted. In many instances the rights of having a gallows, a pillory, and a ducking-stool, &c., pertained to the manor, and were specifically mentioned in deeds and other documents connected with it. The most usual punishments were the pillory, the whipping-post, the cage, the stocks, the finger-stocks, the mortar, the whetstone, the brank, and the tumbrel and ducking stool; the brank and the cucking-stool and ducking-stool (for the two latter varied from each other) were mostly used for the punishment of scolding women; most of the others for offenders of the sterner sex. The ducking-stool was in some places simply a chair in which the offender was placed and dragged round the town on a tumbrel, while in others it was affixed to a pole, so that the poor woman's tormentors might play at "see-saw" with her over a pool of water, and give her a dip over head each time she descended; while in others again it was hung at the end of a chain or a rope, passed over pulleys, and drawn up and down into the water and out again at the pleasure of the inflicter of the punishment. The chair of the ducking-stool at Scarborough is shown in the accompanying engraving. It is a substantial arm-chair of oak, with an iron rod extending from elbow to elbow, just as the little wooden bar is placed in a child's chair to prevent the occupant from falling forward. The seat is of open bars, and there are holes in the top of the uprights of the back, by which, by means of chain or rope, it could be suspended. It was originally placed upon the old pier, so that its unfortunate victims were "ducked" in the sea. For the purpose of illustrating the use of this curious relic, I give a fac-simile of an interesting old engraving representing the ducking of a



MODE OF DUCKING.

woman, in a chair of very similar construction to the one preserved in this museum. In this instance it is affixed to a kind of tumbrel.

The Scarborough Museum, of some of whose contents the foregoing notes will convey a tolerable idea, belongs to the "Scarborough Philosophical and Archaeological Society," one of the most energetic and useful of provincial societies, and counting among its members many men of high scientific attainments, and is under the care of an excellent and very intelligent curator, Mr. Roberts, to whose attention I am indebted for much help in my inquiries. It is much to the credit of the society that a tablet, recording what may be called the foundation of the Museum, is placed in one of its rooms. It is

worded as follows:—"The collection of fossils, minerals, and other specimens of Natural History and Antiquities, formed by the late Thomas Hinderwell, Esq., author of the 'History of Scarborough,' was presented to this institution by his nephew, T. Duesbury, of Beverley, Esq., who thus established the basis of the Scarborough Museum, MDCCCXXVIII. The Council of the Scarborough Philosophical Society, desirous of recording their veneration for the virtues and scientific labours of the former and their gratitude to the latter, inscribe this memorial." It ought to be added that the society possesses in the same building, a useful library of scientific books of reference.

THE NEW SOVEREIGN.

THE Rt. Hon. the Master of the Mint is to be congratulated on his last achievement. Congratulated, that is to say, if the new coin is to be regarded from one point of view, and weighed in one particular balance. If it be desirable that the gold currency of Great Britain should be made the symbol of the adoption of a certain set of views by the administration—if it be wise to proclaim to the world, by the widely-circulating testimony of the English sovereign, that the rulers of England are contentedly or contemptuously ignorant of Fine Art—if it be satisfactory to furnish abundant proof that, in the direction of the English Mint, not only artistic talent, but also mechanical excellence, are entirely disregarded—the new sovereign must be held to be a great success. For this is what it does, upon the face of it. It bears the same relation to the noble gold coins of the best period of our currency, that a print from a slovenly *cliché* bears to a proof engraving. It is a crucial instance of the difference between what is cheap and what is good. It betrays an equal ignorance of the laws that so regulate a coinage as to give it historic value, and of those which regard either its aesthetic propriety or its artistic merit. The only thing left for its originators to regret is, that existing prejudices have prevented them from stamping their new issue in aluminium or Abyssinian gold.

When, in the year 1817, the George and the Dragon first appeared on the English sovereign, there was ample room afforded for criticism. Still, there was much to be said in defence of the design. It is true that modern education led men to enquire, somewhat irreverently, what England had to do with a certain George of Cappadocia. On the other hand there is no doubt that the cry of "St. George for Merry England!" has rung in some of the grandest moments of our history. There was thus an historic fitness in the plastic illustration of the legend. And this fitness was the more cordial from the coincidence with the name of the reigning monarch—a name which, in the first crowned Guelph, had been a mere accident, but which had every appearance, at the close of the wars of the Empire, of becoming dynastic. Alike, then, as a graceful allusion to the regal name, and as an historic memento of old times, the spirited group of St. George overcoming the Dragon was no unfit subject for the reverse of the five-pound, two-pound, and one-pound gold coins, and of the silver crown, of the third and fourth Georges.

"Spirited group," we said, and such it was: but here the commendation must stop. The animal bestridden by the victorious saint was full of life, but it was not exactly a horse. The laws of equilibrium are as little respected in the composition as those of comparative anatomy. The position of the quadruped's head, with reference to its fore feet, is simply impossible. Men well acquainted with the horse declare that on no occasion are that animal's feet to be seen in advance of some portion of its head, either the nose or the tip of the ear. In a long and extensive series of observations on this very point we can remember but a single exception to the rule, and that was in the case of a horse in harness of so remarkable a form as at once to attract the attention. In rearing, the question may be less readily answered; but the horse of the St. George is *not* rearing, but prancing. The rendering is absurd. It is true that the horse in sculpture is almost as invariably conventionalised as is the lion; on the brow of which animal both sculptors and painters impress a frown that has no counterpart in nature. Thus they vainly strive to denote, as by a sort of hieroglyphic, the terror of the wrathful glance. In the same way Grecian Art has sometimes striven to indicate the speed and spirit of the horse by exaggeration of its action. But the horse of the saint on the English coins is taken neither from nature nor from Greek exemplar. It was cut in steel (we believe by Wyon) after a gem cut in jasper by Pistrucci. That artist copied, with some alterations of detail, a *cameo* by Pikler, which

was itself a copy of a portion of a *shell cameo* representing a battle. Of course no great excellence is to be looked for in a shell *cameo*, which, at best, could but be a copy of some more authentic gem.

It is evident from the date in the exergue that the George of 1871 is not a mere reprint from the old die. On more minute inspection it becomes evident that while all that was bad in Pistrucci's group has been retained, all that is good has evaporated. The bad drawing is there, the spirited modelling has disappeared. The face has the vigorous expression of a wax doll. The thigh that compresses the flank of the horse is excavated by a long furrow unknown to anatomy. We do not know to whom the handiwork is due, but we should consider that some workman at about thirty-five shillings a week has gladdened the soul of the Master of the Mint by showing him how rapidly he could work, and how much the country could obtain for the money.

The absurdity of stamping a George, and a bad George, on the reverse of a Victoria, is heightened by the treatment of the obverse. Conventionalised heads of gods or of sovereigns may be reproduced in disregard of the flight of time; but when, as has been the case since the time of Henry VII., careful portraiture is attempted, it is misleading in the extreme to represent a sovereign in the year 1871 under the youthful aspect which she bore in 1836. Even if an old die has not been used for purposes of economy, the expense of modelling a truthful portrait has at all events been saved. A grand and noble saving! We will not call it a cheese-paring. We will speak with true and hearty respect of any *bonâ fide* economy of public money, large or small; but when such economy is made at the expense of public dignity and of public education, as in this instance, we denounce the miserable blunder.

The stamping of the coin in the examples we have seen is as bad as can well be. In some the outline of the profile is blurred, in others the field is blistered, in all the milling round the edge is like that of the screws of a theodolite. The coin is a disgrace to the country.

In the long series of the coins of English sovereigns commencing with the rude pieces of British kings bearing hieroglyphic horses, rudely incised after the patterns of Greek coins, with those of the kings of Wessex, of Mercia, and of Northumbria, and with tokens of saints and archbishops, the first step from utter barbarism is made in the time of Alfred. An intelligible attempt at a human profile, not without some spirit and form, then attracts the eye. With the Confessor, the Byzantine fashion of a full, or three-parts, face, significantly makes its appearance. Slow progress is to be detected in the character of the coinage down to the time of the Tudor dynasty, when a comparatively high degree of Art is developed through the four successive reigns. This period, it will be remembered, is also that in which the nearest approach to the beauty of the Greek medallists was attained by Cellini and other artists in the series of pontifical coins. But the English sequence of gold and silver money rises to higher excellence under the Stuarts than under the Tudors, attaining its *apogee* in the famous petition crown of Simon, portraying the profile of Charles II., and in the yet more exquisite half-crown that accompanied it. The *interregnum*, moreover, is illustrated by the same great medallist, who has given a very Miltonic version of the truculent and remorseless features of General Cromwell. From the time of Simon the history of the English mintage has been that of gradual though marked deterioration. The fine guinea piece of George II., struck in 1729, is probably the best of this part of the series. A slight rebound may be traced after 1815, but the good taste then displayed soon disappeared. In the 1857 crown-piece of Queen Victoria the old "tacetotum" arrangement of four shields placed crosswise obtains on the reverse, without the excuse of the older coins, which, marked with a slight floriated cross quartering the disc, attempted to render at the same time reverence to God by the cross and to the king by the scutcheon. In this pretentious piece, the

slovenly omission of the tinctures of the arms deserves special reprehension. Thus we come down through various degrees of ever-increasing poverty of invention and of execution, to the makeshift token of 1871—the Queen's profile of 1844, or earlier, on the obverse, the George of George III. in 1817 on the reverse, and that total absence of clearness of stamp and of workmanlike execution that is the especial honour of the present Master of the Mint. We paid a second visit to the Bank, after having written these lines, to see if we had been unfortunate in our specimens. Out of a small handful there produced not one was a perfect coin. In one the obverse was faulty, in another the reverse, in most of them the milling. All those who envy or hate England, all those who know, while entertaining such feelings, how much of the future safety of the country depends on the restoration of that pre-eminence in mechanical and industrial Art which we once proudly boasted, will clap their hands over the new sovereign; for they will see in it the indubitable proof of the contemptuous ignorance with which artistic truth and merit are regarded by the English Government.

ROYAL SCOTTISH ACADEMY.*

THE infancy of any institution claiming to be of national interest and importance generally reveals some curious facts as to its birth, and to the causes which have marked its progress to maturity. The early history of the Royal Scottish Academy is no exception to this almost universal rule, and bears some analogy to that of our own Royal Academy established more than half a century previously. So long ago as the year 1727 there was founded, by Act of Parliament, in Edinburgh, an institution that obtained the title of the Honourable Board of Trustees for Manufactures in Scotland, with the object of "encouraging and promoting the fisheries, and such other manufactures and improvements in Scotland as may most conduce to the general good of the United Kingdom." in connection with this "Board," a master was appointed, in 1760, to teach the youth of both sexes the elements of drawing, more especially with regard to designs for manufacturers. Hence arose the Edinburgh School of Design, with which the future Academy became ultimately associated.

But, as Sir George Harvey, who now fills the dignified office of President of the Scottish Academy, tells us in the volume on our table, a second important organisation came into the category of operations. In February 1819 there was formed in Edinburgh an "Institution for the Encouragement of the Fine Arts," on the principles of the late British Institution in Pall Mall, London, for the purpose of having annual exhibitions of pictures by the old masters. It consisted chiefly of noblemen and gentlemen who became shareholders, or life-members, on the payment of the sum of £50, and was managed entirely by directors chosen from among the subscribers, no artist being permitted to have any voice in the direction so long as he exercised his profession. The first exhibition of this society took place in the year of its formation, and a second in the year following.

Previously, however, to this, the leading artists resident in Edinburgh had joined together to exhibit their works; and continued to do so from 1809 to 1813. During this period the sum of £1,888 had been accumulated; but the society "not being sufficiently restricted by their laws from breaking up at any time, and the money proving tempting, it was proposed and carried at a general meeting that it should be divided among the members." The Scottish artists were now without a home of their own; and a few years afterward the elder Institution, finding that the exhibitions of pictures by the old masters were not remunerative in any way, made overtures to the artists that the exhibition of modern pictures and sculptures should take

place under its auspices, subject to the obligation on the part of the Institution that the "entire free proceeds" should be devoted to the benefit of the artists and their families. The first exhibition under the new arrangement took place in 1821.

Matters went on in this state for four or five years, yet not smoothly; the artists, who were Associate-members of the Institution being dissatisfied because no consideration whatever was given to them in the management of the exhibitions: as a result, several of them commenced, in 1826, to make arrangements to found a Scottish Academy.

In the summer of that year, a document to the above effect was handed round for signature by William Nicholson, chiefly known as a portrait-painter in water-colours. When printed and published it bore the names of twenty-four artists—the original number of the members and Associates of the Academy. It was proposed to open an exhibition as early as possible: this would require all the works that the limited number of members could contribute; "but when it is mentioned that, of the twenty-four who originally constituted the Academy, nine took fright at the responsibility connected with the movement, and resigned, leaving only fifteen in all to carry on the work, it will not be considered surprising that great anxiety as to their possible success was felt by those who remained." Nothing daunted, however, by this defection, the adherents of the contemplated Academy met together, and determined to hold an exhibition in the early part of 1827: rooms were engaged in Waterloo Place, Edinburgh, and "friends in London and elsewhere were applied to for contributions of works of Art, to assist in meeting the formidable combination arrayed against the infant Academy in its first struggle for existence;" for it is to be noted that the Institution, which had now received the title of "Royal," continued its course, supported by several artists of that period, who subsequently rose to eminence, among them the late Sirs W. Allan and J. Watson Gordon, Messrs. A. Nasmyth and W. Simson; while to keep up the spirit of the adherents of the Institution, the directors about this time gave commissions for paintings, value £50 and upwards, to each of the nine Associates who had attended a meeting called by them; while the three who declined to be present received no share of their patronage. Thus, at the very outset of the Academy a strong opposition was raised to it; and the odds against success were greatly increased by the conduct of the directors of the elder society. Both opened their exhibitions simultaneously, and though that of the Institution was admitted to have been the more attractive, the Academy "kept up a brave heart, and enjoying the sympathy of the public and the press, the first year past over upon the whole satisfactorily. In the second year, 1828, "the two exhibitions were more equally matched. . . . For the third exhibition increasing efforts were made, and on this occasion the Royal Institution was fairly driven from the field." The result led to the discontinuance of the exhibition of modern works of Art by the Royal Institution, "which ceased henceforth to compete."

We have no room to follow Sir George Harvey through his most interesting narrative. It must suffice to add that in 1829 the body of artists who had adhered to the Institution, till driven away by its directors, "whose intolerable management they could no longer endure," and who had endeavoured, unsuccessfully, to organise a constitution for themselves, became incorporated, by arrangement with the Academy, which, thus united, held its first general meeting in November of that year. The royal warrant for a charter of incorporation to the Academy was not completed until 1838: henceforth it became "The Royal Scottish Academy."

There is much in the records here put forth by its President worth looking into by those who feel any interest in the growth and development of our leading Art-institutions: they are brought down to the year 1854. Sir George Harvey is one of the few artists now living who took part in the foundation of the Academy, and subsequently has been actively associated with all its proceedings.

* NOTES OF THE EARLY HISTORY OF THE ROYAL SCOTTISH ACADEMY. By GEORGE HARVEY, K.T., P.R.S.A. Published by Edmonston and Douglas, Edinburgh.

THE DUDLEY GALLERY.

THE SEVENTH EXHIBITION
OF WATER-COLOUR DRAWINGS.

THIS, the seventh "General Exhibition," is worthy of its predecessors, the room is closely packed with 665 drawings, and the number of works again crowded out altogether proves the sustained popularity of the Gallery. An exhibition open to all the world cannot be otherwise than widely comprehensive. The contents are varied and pleasing, though, as heretofore, not a little eccentric. Talent disappointed of its reward; juvenile genius, wayward and wide of the mark; still find in this gallery kind reception. The interest, from the first incited by an exhibition thus conducted on a liberal basis and in an impartial spirit, remains unabating. Moreover, the good cause is gaining from year to year fresh adherents. If on the one hand the Dudley Gallery suffers from reprisals made by rival associations—if Mr. Lamont may have been carried away to the Old Water-Colour Society, and Mr. Linton led captive to the Institute—the Dudley receives compensation in return. Mr. Burton, a recent seceder from the elder Society in Pall Mall, finds himself in the post of honour in Piccadilly: "La Romania" (172), one of the first fruits of his Italian tour, merits the central place at the top of the room. Other leading positions on the walls are scarcely less worthily occupied. "Thoughts of Christmas" (269), is a drawing which proves the wisdom of the Academy in adding the name of Mr. Marks to the list of its Associates. At the private view of the Dudley the painter received the congratulations of his friends on the election which had taken place only two days before. The Dudley Gallery is neutral territory, wherein all parties meet on friendly footing, and thus an artist on his election into the Academy does not think of cutting his former associates. Accordingly, on the Committee of the Dudley are retained the names of G. D. Leslie, A.R.A., Edward J. Poynter, A.R.A., and W. F. Yeames, A.R.A.; and among Royal Academicians is found in the list of exhibitors R. Redgrave, R.A. Of foreign artists of note we observe Gérôme, Fortuny, Legros, Schlesinger, Tourrier, Willems. Among *habituals* of the Gallery we observe works of at least accustomed merit by Walter Crane, Donaldson, Hemy, Hodgson, Luxmore, H. and J. C. Moore, Breton Riviere, Arthur Severn, Simeon Solomon, Miss Spartali, Spencer Stanhope, and G. A. Storey. This strong staff of contributors affords some surety that the drawings we proceed to pass under review are worthy of attention.

"La Romania" (172), by Mr. Burton, is, taken for all in all, the most remarkable drawing in the Gallery. Though the subject be only a Roman model, yet the style has the elevation which comes of converse with the old Italian masters. The tone is low, the colour deep and shadowy, the sentiment quiet and poetic. Wholly different in style—in other words, allied to the old German instead of to the old Italian masters—is a drawing scarcely less remarkable, "Cinderella and her Sisters" (123), by Napier Hemy, a favourite pupil of the late Baron Leys. This young and promising artist has hitherto appeared in this Gallery chiefly as a painter of landscape; yet, whatever be his subject, the treatment is thoughtful, studious, and impressive, with less of mannerism and servility than usually falls to the lot of inveterate mediævalists. Mr. Spencer Stanhope is one of those artists who in the direction of Gothicism has long passed the happy medium, the line which divides moderation from extravagance. "The White Rabbit" (248), by this artist, may be praised for rich colour, but little more. Mr. Stanhope has been sometimes more happy in his parody on classic styles, than here when assuming a mediæval manner. It is a pity that he cannot, if only for sake of novelty, hetake himself for once to nature. Mr. Walter Crane is another of the pleasing yet perplexing eccentricities of the Gallery. Perhaps the most presentable offspring of his fancy yet given to the world is "Bluebeard and Gloriana" (88). This composition of peacocks, vases, columns, terrace-walks, park-lands, and silvery lakes, is

suggestive to the imagination. The scene has the charm of quietism, of stately solitude; the drawing is accurate, as the execution is tender and unostentatious. We shall watch with interest the future of this young artist.

Mr. Simeon Solomon is never so much at home as in the Dudley Gallery, and to our mind has seldom shown himself so well as on the present occasion. Once again his genius oscillates between mediævalism and classicism. "The Mystery of Faith" (89), pertains to the religion and the ritual of the Romish Church. A priest, robed richly, elevates the Eucharist; his eye fixed as in a trance, his countenance that of an ascetic, reveal a soul steadfastly set on "the mystery of faith"—the Real Presence. The execution is worthy of the conception; the artist has achieved a triumph. Scarcely less successful in the opposite direction of the classic, is "The Singing of Love" (496). The figures here brought upon the scene are, Somnus, Memoria, Morpheus, Amor, Voluptas, Libido, and Mors; each personates some distinctive phase of love, divine or carnal. The forms are typical, they signify a noble godlike race of beings, somewhat akin to the purest types on Greek vases, and sometimes reminding the spectator of Miltonic conceptions of archangels ruined. Almost the only other successful treatment of the nude is in Mr. Clifford's "Meadows of Asphodel" (287). The colour is rather pale and cold, but the forms are well modelled. Mr. Poynter, yet another artist of high aim, who habitually frequents this room, seems rather in the way of exaggerating his defects. The portraits he now exhibits tend to hardness and dryness, to a certain scattered confusion in background and subordinate details. Otherwise it were difficult to extol too highly the "Portrait of Lady Wensleydale" (253). More than commonly pleasing is the "Portrait of Lady Blanch Ogilvy" (580). Mr. Poynter's heads carry the persuasion of uncompromising truth. The artist disdains the flattering ways of courtier painters. "A Pastoral" (517), from the same pencil, shows a quiet sympathetic eye for English landscape.

Mr. Marks, A.R.A., enlivens the gallery by comic "Thoughts of Christmas" (269). A monk, sly and sleek, looks with loving eye upon a fat and drowsy herd of pigs lying in a beechwood. The theme defies refinement, still coarseness is escaped. The story speaks for itself, the character is broad, the execution much to the point. Mr. Hodgson, like Mr. Marks, seems destitute of the sense of beauty; the strength of each artist lies in the delineation of character. "New Boots" (78), by Mr. Hodgson, is strong in purpose and firm in touch; also his "Ostrich-Hunter" (594), if not an attractive, is evidently a literal study from the life. Mr. Hodgson's recent labours in Algeria led us at one time to suppose that his election into the Academy was not far distant. Among "The St. John's Wood School," Marks naturally had the first chance, Hodgson may come next. "The White Cockade" (70), shows Mr. Luxmore's accustomed care; the drawing in hands and head is capital. Near by we gladly come upon a subject felicitously chosen by Mr. Garraway, "Chinese Artist at Work" (64). In form the drawing may lack firmness, but the colour catches the harmonies known to belong to Orientalism. We may expect still further developments arising out of the growing taste for Chinese and Japanese ornament. Hubert Herkomer also contributes to the clever eccentricities of the Dudley. "At Tréport—War News, July 1870" (57), might have better served for a page of an illustrated newspaper than for a London picture-gallery; yet the Art brought into play is something better than pictorial penny-a-lining. The composition is quite exceptional for multiplicity of detail and studied character, but the result is a drawing crowded to excess. The style is allied to that of Mr. Pinwell. Mr. North and Mr. Hanhart are also disciples in the Walker and Pinwell school. "May on the Hills" (77), not disagreeably displays the mannerism of Mr. North; the colour is hot, the horizon high—the sky, in fact, has been almost forgotten. "A Farmyard, Somersetshire" (218), is much to the credit of Mr. Hanhart. Yet why do these artists affect a colour beyond the simplicity of nature?

Mr. Houghton might in mercy have spared us a second edition of "The Son of Asgad" (141). The figure is powerful but repulsive; the flesh looks metallic. Mr. John Richardson again produces works praiseworthy for strength rather than for delicacy; yet "The Row to the Moors" (40), has been rightly rewarded with a place on the line. Mr. Hamilton Macallum has improved since we met him last; but the "Launch of a Lochfyne Fishing Smack" (167), is a difficult subject still beyond his power. Very admirable are two small studies, by this artist, on the screens: "Steering down Lochfyne" (541), and "At Anchor" (573), are true in drawing and firm in execution. This sound way of working is sure of its reward. Also Mr. Tom Gray, now as heretofore, gives promise of success: "A Bill of Fare" (371) has a character which only requires more detail in the carrying out to become satisfactory and complete. Mr. Jopling, in a somewhat flaunting figure (21), suggested by a stanza of Mrs. Barrett Browning, again practises clever tricks of the brush. Close by hangs a quiet, painstaking drawing, by Joseph Knight—"Blanchisseuses Bretonnes" (28). We also notice some truth-seeking studies by John Skill. R. W. Macbeth follows up his success in a former exhibition by "A Sketch" (254); there is no study in the room more solid or artistic. On the back of the first screen should be observed some interesting sketches by Cavé Thomas, "for the mural decoration of the Flaxman Hall, made at the invitation of the Graphic Society." The three single figures—Homer, Pythagoras, and Apelles—are representative of Literature, Science, and Art.

The Dudley Gallery has from the first been a favourite resort of the ladies: a dozen ladies, at the very least, here distinguish themselves: there is, in fact, a greater display of female talent in this room than in the gallery in Conduit Street, exclusively set apart for the benefit of ladies. Several of the exhibitors, as for example Miss Adelaide Claxton, have gained thorough mastery over water-colour painting as a medium or process. In the delineation of ghosts, Miss Claxton is indeed unrivalled; long practice, no doubt, makes perfect. Miss Spartali is another lady who wanders from the beaten track. Originality, and above all, feminine grace and beauty, adorn the most arduous composition yet attempted by this lady—"Antigone, in defiance of King Creon, giving Burial Rites to the Body of her Brother Polynices" (75). The action is finely tragic, the colour seems a reflex from Venetian harmonies. Evidently to the same school of revival belongs "Romeo and Juliet" (336), a well-conceived but unequal work by Miss L. Madox Brown. Neither can we pass without commendation "The Picture-book" (470), by Miss Lucette Barker; "The Bazaar" (472), by Clara Montalba; and "Annette" (516), by Miss Constance Phillott. A figure in chalk (639), by Miss Ellen G. Hill, has a breadth and a mastery unusual in the English school.

The Dudley Gallery is further distinguished by the best flower-painting now to be met with, and again we have to acknowledge our obligation to the ladies. Caroline Eastlake, Emily S. Armstrong, and Ellen C. Coleman, severally contribute studies which cannot fail to arrest attention. Miss Eastlake is entitled to special commendation: her productions manifest ability, taste, and industry—are conscientious transcripts of nature, wrought with exceeding care and skill. "Chrysanthemums and Primula" (617), by Miss Armstrong, is singularly successful in form, colour, light, and shade. Another brilliant "Study of Chrysanthemums" (56) we owe to H. Sterling. Other commendable flower and fruit pieces are produced by Jessop Hardwicke, Sidney Whiteford, and J. Bunker.

Some foreign artists of note contribute to the Gallery. Among them, as already stated, are Gérôme, Fortuny, and Willems; but we have no space to indicate their productions.

The landscapes in this gallery continue to present an anomalous character. The Dudley brotherhood approach nature with a foregone conclusion—in other words, they are mannerists. And yet they are not agreed upon any one manner to the exclusion of all other forms of eccentricity. Thus, in satire, it has been said

that the room contains everything but nature. Yet by way of exception it were easy to select studies true as poetic. The brothers Henry Moore and J. C. Moore, among the earliest exhibitors to the Gallery, again contribute drawings brimful of atmosphere and sunlight. The former, however, has somewhat muddled his sketch 'On the Seine' (152). We shall hope to see better fruits of his trip to France made before the War. His brother, J. C. Moore, still abides in Italy, whence now, as of yore, he sends landscapes exquisite for tone of tender greys and for sentiment of unbroken tranquillity, such as 'St. Peter's and the Vatican from Monte Mario' (182). If Italy should now rise into new life, our artists must use more joyous colours. In fact, Glennie and Alfred Hunt, in the Old Water-Colour Gallery, are accustomed to dress up Italy brightly; Mr. Moore's sombre clothing is exceptional. Mr. Field Talfourd also deals largely in what may be called the Dudley mixture of chalk and water; yet 'Near Fawley' (189) has pleasant passages of quiet grey. Likewise for that unbroken unity in tone whence mainly proceeds pictorial sentiment, much to be commended is 'Santa Maria del Orto, Venice' (205), by F. C. Nightingale. 'The Seine near Fontainebleau' (46), by Arthur Ditchfield, is equally quiet and unobtrusive. Cleverly managed by Madame Bodichon is a large intractable scene—'Richard Cœur de Lion's Castle, at Saucy, Les Anderlys, France' (465). Mr. Arthur Severn, too, is not easily discouraged by difficulties: 'The Sea at Scarborough' (27) is extravagant; more balanced, and indeed calm and lovely as the serenest of Italian weather, is 'Evening on the Tiber' (128). This charming drawing justifies the expectations Mr. Severn raised when first he exhibited in this gallery. By C. R. Aston we have never seen a better work than 'Winter Morning—sketch on the Mersey' (329); the light is silvery, the cloud-study specially fine. W. R. Beverley shows accustomed spirit and knowledge of effect in 'Old Bridlington Pier' (452).

While some artists in the Dudley are sober and quiet, others play wild pranks with colour. Turner's pictures were never more insane than a certain feverish landscape in 'October' (312), by Albert Goodwin. As usual in such pyrotechnic displays, form is sacrificed to effect. 'Thun' (237), by Charles Earle, and sundry drawings by A. B. Donaldson, are also more conspicuous for colour than for drawing. Indeed 'Ronen' (191), by Mr. Donaldson, resembles a piece of worsted work rather than a picture. Mr. George Mawley also allies himself to schools of colour in a drawing of 'An old Stone Quarry' (279); the manner is akin to the grandeur of Linnell. S. Vincent, in several contributions after his accustomed manner, likewise gains golden tones. 'The Last of Autumn' (87), by Miss Katherine Malleson, is poetic in effect and conscientious in detail. Miss Anna Blunden also continues her faithful mode of work. 'Vesuvius from Ischia' (210), however, would be better for nicer modulation in the colour. Frank Dillon contributes some interesting studies made in Norway. 'The Romsdal' (223) is true to the geological structure of the rock-bound coast, while 'Midnight at Kukevaag' (301) is equally faithful to the striking phenomenon of perpetual day.

Animal-painting and architectural drawing claim a few faithful adherents. Breton Riviere attaches a facetious title to a well-painted fox hungering for fowls beyond his reach. The colour is somewhat crude. Heywood Hardy gives onward movement to a horse at full gallop: the picture is altogether well managed. H. M. Marshall is to be congratulated on his first entrance to the gallery. The famous 'Market-place, Siena' (448) is faithfully rendered. Mr. Macquoid gives capital texture to crumbling stonework, and Mr. Phené Spiers proves himself an artist as well as an architect in a well-studied drawing of the west front of Limburg Cathedral' (533). In fine, we trust we have said enough to indicate that the Dudley Gallery contains the elements of a successful and prosperous season: this it justly merits, and will doubtless have.

INSECT LIFE.*

THE first idea that naturally occurs on looking over such a volume as this by Mr. Duncan, is the vast amount of close, minute, and patient investigation which must have been expended to arrive at the facts disclosed. A knowledge of the organisation and life of almost all other orders of creation—beasts, birds, and even fishes—seems to be more readily attainable, as they lie more open to us; but the insect world is altogether of so different a character to any one of these, and is so singular in all its stages

of development, that one can scarcely realise the industry and wearisome observation essential to an examination of the habits of these creatures of the air and the ground. It is a wonderful study, and as interesting as wonderful.

An anonymous writer humorously and practically says: "Insects must lead a truly jovial life. Think what it must be to lodge in a lily; imagine a palace of ivory and pearl, with pillars of silver and capitals of gold, all exhaling such a perfume as never arose from a human censer; fancy, again, the fun of tucking themselves up for the night in the folds of a rose,



THE METAMORPHOSES OF THE MOLE-CRICKET (*Grylotalpa vulgaris*).

rocked to sleep by the gentle sighs of the summer air, nothing to do when you awake but to wash yourself in a dew-drop." This is the sunny side of insect life, but it has also a dark side; these tiny denizens of the forest, the fields, and the damp marsh, "swim, fight, and

devour in the tranquil glassy pools, hour after hour, and without. They embody the very principles of vitality, activity, and destruction."

Insects, we are told by geological naturalists, existed in very remote ages, and their wings have been found beautifully preserved in the remains of those old forests and swamps which have been found in coal, dug up from depths of hundreds of fathoms, and covered by sediments that are the remains of old continents and seahotoms, the thickness of which is the measure of the time they took to form. Yet so far back in the annals of nature the tiny insects came from the egg, lived as gormandising grubs,

* THE TRANSFORMATIONS, OR METAMORPHOSES, OF INSECTS (*Insecta, Myriopoda, Arachnida, and Crustacea*). Being an Adaptation, for English Readers, of M. Emile Blanchard's "Metamorphoses, Mœurs, et Instincts des Insectes;" and a Compilation from the works of Newport, Charles Darwin, Spence Bate, Fritz Müller, Packard, Lubbock, Stainton, and others. By P. MARTIN DUNCAN, F.R.S., Professor of Geology in King's College, London. Published by CASSELL, PETER, and GALPIN.

changed into sleepy *pupa*, and burst forth into lively winged creatures.

Linnæus comprised within the great zoological group of *Articulata*, or articulate animals—that is, jointed—the true insects, the hundred-

legs, spiders, and crabs. Each of these divisions has its place in Mr. Duncan's well-digested compilation from the writings of the many naturalists from whom he has derived the information here given—information as varied

DEPARTMENT OF SCIENCE AND ART.

THE southward extension of the main court of the South Kensington Museum is complete, so far as structure is concerned. The flooring, painting, and mural decoration are rapidly advancing, and we may expect the immediate unveiling of the temporary screen, against which the famous Gates of Paradise, by Ghiberti, and the more ancient gates by Bonanno, are now fixed. A great improvement will be effected by this enlargement.

In fact, want of space is becoming a normal complaint at South Kensington. To the large collection of paintings, acquired by, or lent to, the Museum, has now been added a large loan by Mr. Butler Johnson, forming a part of the Monro Collection, a title familiar to our readers. The arrangement and display of these paintings appear to have perplexed the officers of the Museum unusually, as they have been for some time waiting, in a part of the gallery containing the collection of fans, from which the public is, *pro tempore*, excluded. Labels and descriptions are not yet prepared.

IVORY TANKARDS.

Four splendid ivory tankards have been lent to the Museum by Viscountess Strangford—unusually fine specimens of German work of the sixteenth and seventeenth centuries. Of these the boldest is adorned by a group, or wreath, of sea-nymphs and divinities, with a flight of cupids over their heads, executed in such bold relief as to be almost in the round. The cup itself is ornamented with enamel, and a cupid bestriding an eagle heads the cover: this is a sixteenth-century production. Diana and Actæon is the subject represented on another tankard, of later date. The Rape of Europa forms the subject of a third, also of the seventeenth century. The fourth, somewhat more Chinese in its treatment, inasmuch as the outer surface of the figure is reduced to the same plane, and the cutting is vertical, appears to represent the Rape of Proserpine. The knob is a figure blowing a horn: this is also attributed to the sixteenth century. With these is a Flemish cup, of the seventeenth, lent by Lady Stuart de Rosshay, representing the Rape of the Sabines. The style of treatment is more subdued, the relief lower, than in the German work. The artist has avoided the curious errors into which the use of relief that rises into the round in some parts, while it is limited by the plane of the back-ground in others, is certain to hurry any but a perfect master of his Art. We hope the Museum will be allowed to reproduce these bold and curious ivories.

ART-LIBRARY.

Among the illustrated works and drawings added to the Art-museum during the year 1870 we observe a fine copy of Rossini's "Antichite Romane," in nine volumes, large folio. The five large volumes, some of them in two parts, of Gough's "Sepulchral Monuments in Great Britain," form another acquisition. Then we have Siebold's "Nippon," an atlas of views of Japan; Krelscher's "Costumes of all Nations," a folio atlas of the works of Canova, and another containing seventy-seven engravings of sculptures by Gibson.

A valuable addition to the original drawings is made by a set of eighty-seven coloured drawings, by the Abbé Gravina, of the famous Duomo of Monreale, near Palermo. Then we have drawings of the mosaics of the Church of Santa Maria Maggiore, at Rome, and of that of San Lorenzo, at Milan, made expressly for the Museum; and 143 native Hindoo drawings, of the seventeenth century, of the sculptured pillars and supports of the famous pillared hall of Madura. Italian architecture is illustrated by a set of coloured drawings by L. Gremer. It is to be regretted that the narrow space within which the library is compressed is such as to render it difficult for the public to derive full benefit from the very valuable collection of drawings in the possession of the Art-Library.

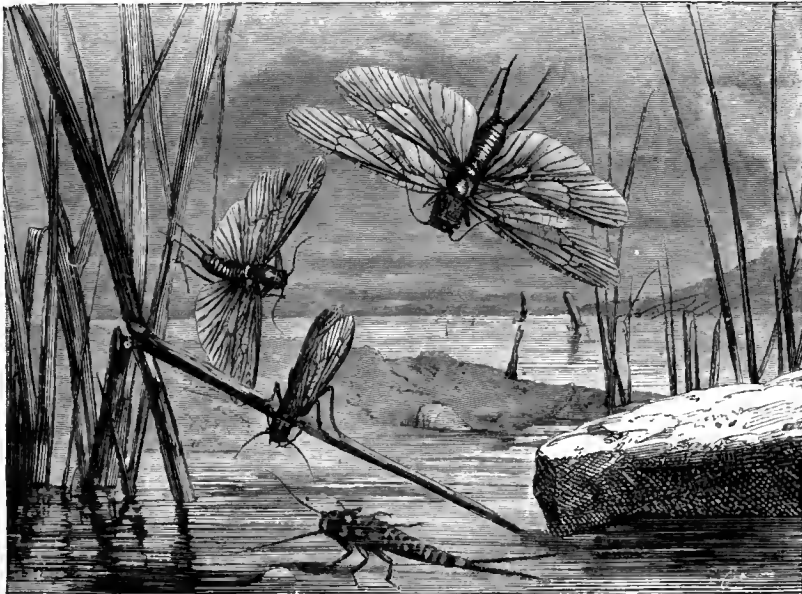

THE METAMORPHOSES OF PERLA MARGINATA.

as it is amusing and instructive. We look, for example, at a troop of gay butterflies dancing in the air, or a cloud of gnats surrounding us on a summer's evening, and ask ourselves of

what real use they are but to serve as food for each other, or for races distinct from their own; and yet they fertilise the soil by scattering decomposing matters, and prevent them from

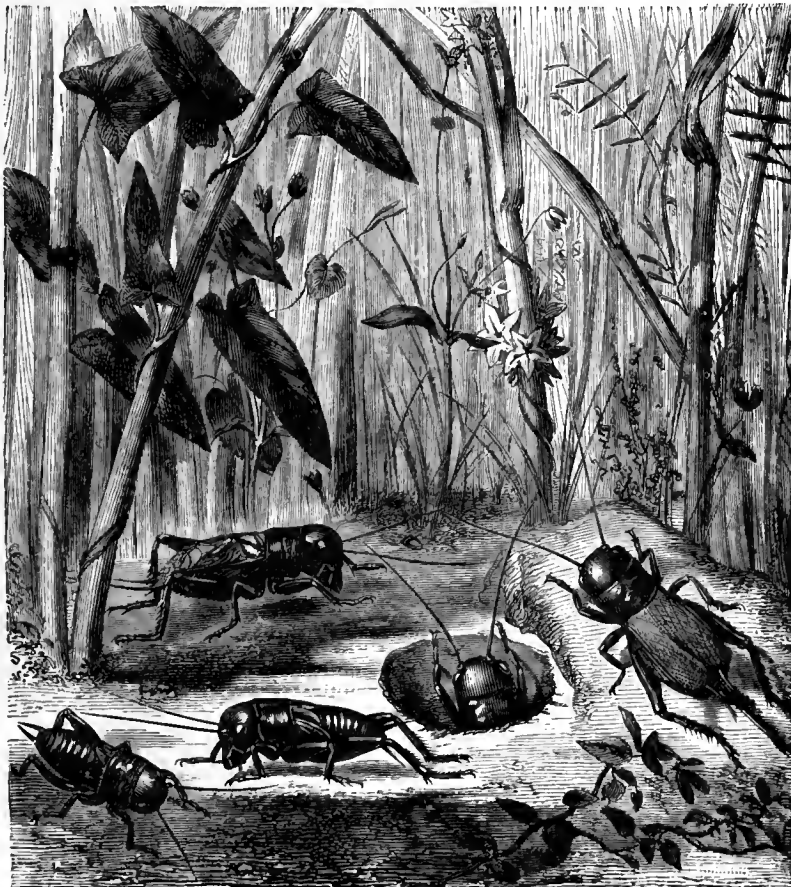

METAMORPHOSES OF THE FIELD CRICKET.

vitiating the atmosphere; they check the undue growth of vegetation, and otherwise aid in maintaining the equilibrium of Nature.

Among the vast number of books published by Messrs. Cassell and Co. to advance the

spread of scientific knowledge, this cannot fail to take a high place: its pages are full of admirable woodcuts—of which we give three examples—all helping the reader to master a marvellous and interesting subject.

SCHOOLS OF ART.

LAMBETH.—A concert was given, on the 27th of January, in the Vestry Hall of this parish, towards a fund now being raised for enlarging the Lambeth school, which is found to be too small and ill-provided for the number of pupils under the able management of the head-master, Mr. J. Sparkes. The performers were some of the students, male and female, who, with the aid of a few friends, contributed to make the evening very agreeable.

LEEDS.—The successful competitors in the Leeds School of Art and Science received their prizes, at the last annual gathering, from the hands of Lord Houghton, who delivered an excellent address to the assembly, not merely in reference to the express object of the meeting, but with this embracing matters of general, social, and political interest. The report of the Art division of the school shows the number of pupils in attendance during the past year to have been 326, against 255 in the preceding year. These numbers are exclusive of the pupils taught in the day-schools, which would bring the whole up to the gross amount, males and females, of 552 under instruction. The committee feels that so far as the work of the school is concerned, the principle adopted in August, 1869, of appointing a master whose duty is entirely confined to the work carried on in the institution, has proved highly successful. The Art-pupils are under the superintendence of Dr. Puckett.

LINCOLN.—An exhibition of the works of the pupils of this school, towards the end of last year, was followed by the annual meeting for the distribution of prizes. The exhibition was attended by more than 4,000 visitors, and during the evenings the working-classes assembled in large numbers. The report of the head-master, Mr. E. R. Taylor, alludes to the great deficiency of accommodation experienced by himself and his pupils to enable them to pursue their labours to the best advantage; notwithstanding this disadvantage, the awards made by the Department of Science and Art at the last national competitive examination were again in advance of the preceding year: one national medal being gained by Mr. W. Mortimer, and three Queen's prizes by, respectively, Miss A. Mackenzie, Mr. A. Foster, and Mr. G. Wormal: the total number of awards being 150, against 140 in the year 1869, and 94 in 1868. The chief prize, a silver medal, given by the ex-mayor of Lincoln, Mr. J. Ruston, was gained by Mr. J. T. S. Young.

HALIFAX.—The annual meeting of this school was held in the month of January. The report stated the regular classes have maintained a good average attendance throughout the year, in marked contrast to previous years, when the attendance during the summer months had always fallen off. One of the students, Mr. T. Holland, obtained a certificate of the third grade at the annual examinations held at South Kensington last February. Two of the students, Mr. Drake and Mr. Smith, are now studying at South Kensington, having each obtained national scholarships of the annual value of £50. In the year's national competition one of the students, Mr. F. Spencer, obtained a silver medal for a design for "wall-decoration." Mr. H. Robinson was awarded a bronze medal for "design for carpets." Three other students obtained prizes of books for successful elementary designs.

NEWCASTLE-UNDER-LYNE.—The annual meeting of the friends of this school has been held, when the Rev. Sir L. T. Stamer, Bart., presided. The report of the head-master was satisfactory as regarded the progress of the pupils. The drawings of thirty-nine students were sent to London in April last for the national competition, when four prizes were awarded.

NEWINGTON BUTTS.—Mr. Locke, M.P. for Southwark, distributed the prizes to the successful competitors in this school somewhat recently; in his address he strongly urged the artisan classes to avail themselves of the opportunity afforded by this school and other similar institutions to raise themselves and their crafts to the position they ought to occupy in the labour-market of the world.

ART IN CONTINENTAL STATES.

GREECE.—*La Grèce Pittoresque* is a work in course of issue in serial numbers, published at Brussels, Paris, and Amsterdam. The engravings resemble those of English engravers before the habitual use of steel plates. The illustrations are after drawings by Loffler, and the descriptions are by D. M. Bosch.

MADRAS.—The Maharajah of Jeypore has offered, according to the *Architect*, to contribute a lac of rupees, about £10,000, towards the establishment of a School of Art for Madras. We do not understand this announcement: there has been for many years past a school in Madras, under the superintendence of Dr. Alexander Hunter, a gentleman long resident in the city, whose love of Art induced him to relinquish his profession—that of a physician—to devote his time, talents, and energies, in promoting Art-education in India, in which he was very successful. We have often been in communication with him, and have reported the results of his labours; and more than ten years since, when he paid us a visit, we published in our Journal some papers from his pen he left with us, on "Geometry and its Application to Decorative Purposes in India," with illustrative diagrams, drawn and coloured, as we then understood, by pupils in the Madras school.

MADRID.—The *Athenaeum* reports the death, on the 14th of January, in this city, of Edouardo Zamacois, a pupil of Messonier, and a French medallist of 1867. He was a frequent exhibitor at the Paris *Salon*: two pictures contributed by him especially gained attention, his 'Buffon au 16^e Siècle' exhibited in 1867, and his 'L'Education d'un Prince' in 1870. He has left a large picture unfinished, the scene of which is the Saloon of the Ambassadors in the Palace of Madrid. Zamacois was a native of Bilbao.—From the same source we learn that the King of Spain has commissioned the following historical works:—"The Arrival at Carthage," by Gishert; 'The Entrance into Madrid,' by Rosales; 'The Oath in the Cortes,' by Casado; and 'The Official Reception in the Palace,' by Palmarioli. Some Spanish sculptors are also to receive commissions for busts.

MANTUA.—A process has been instituted before the tribunals by the municipal council of Mantua against the *conseil de fabrique* of that town, for having sold the picture of Saint Sebastian, by Delacroix, which was the gift of the State. The tribunal held that the sale was conclusive, as in favour of the purchaser. The question of the responsibility of the sellers has yet to be decided.

MILAN.—The *Academy* reports the discovery of two valuable pictures in the loft of a villa near this city. One, 'The Infant Christ in the Manger,' about 3 feet in height, is assigned to Correggio; the other, a life-size half-length, 'Christ bearing the Cross,' to G. Ferrari: both are described as being in good preservation.

NUREMBERG.—"We notice with regret," says the *Architect*, "that the exigencies of modern requirements are gradually beginning to do their work in this interesting city. Until lately, Nuremberg was the only place in Europe which had managed to retain intact its mediæval character: the city walls and towers of the fourteenth century, the moats and drawbridges—all these things make, or rather made, an indescribable effect upon the nineteenth-century traveller, even before he entered the place itself. Gradually, however, one by one, these features seem doomed to disappear. Two years ago two towers in the outer wall were taken down; a third has followed since; and now we learn, not without regret, that it has been determined to raze three more bastions, and fill in the moat in front of them, for the purpose of affording increased means of locomotion." We are sure that every lover of archæology will share in the feeling of regret expressed by our contemporary.

PARIS.—The desolation wrought by shot and shell around Paris is such as to give additional interest to every record of its former splendour. Among these we call attention to the fine copy of "Les Galeries Historiques de Versailles," in

nineteen volumes, large folio, recently added to the Art-library at South Kensington.

PESTH.—More than a year ago we stated the probability of the Hungarian government purchasing the famous Esterhazy picture-collection: this, it is reported, has now been done, the parliament having liberally voted the sum of 1,300,000 florins, equivalent to about £650,000 in our money, for the purpose. The collection, famous for its examples of Murillo and of the old Flemish painters, was removed some time since from Vienna to Pesth, where it now will form the nucleus, and a noble one, of a National Gallery.

PHILADELPHIA.—The centenary of the Independence of the United States is to be celebrated in this city, in 1876, by an exhibition of manufactures and works of Art, a bill for the purpose having passed the House of Representatives at Washington.

VIENNA.—An exhibition of drawings and engravings, by Albert Durer, is to be opened in the Museum of this city on the 20th of May.

AGRICULTURE.

FROM THE GROUP BY W. C. MARSHALL, R.A.

THIS is one of the four subsidiary groups of sculpture intended for the Albert Memorial in Hyde Park; and will occupy a position at the base of the principal erection: the four large compositions—of which we introduced one, AMERICA, into our January number—will stand on pedestals removed from the architecture, though connected with it by projections of marble, with flights of steps on each side.

Mr. Marshall, in his symbolical treatment of AGRICULTURE, has gone back to an early period of the art of husbandry. Like the rest of the groups, it consists of four figures, the principal one being the genius of Agriculture, who points out to a husbandman the advantages on the side of modern improvements in field-implements, as exemplified in the plough of the ancients side by side with emblems of the steam-engine—the cylinder and the piston. On the left of the standing figure is a female seated, holding a sickle in one hand, and supporting a sheaf of wheat with the other. On the opposite side is a shepherd, examining some lambs of the flock; allusive to the breeding and rearing of cattle as a legitimate part of agricultural operations. By thus connecting the link of the present, so to speak, with that of the past, the sculptor has rendered his work instructive; for the union carries the thoughts from the comparatively easy toil of the rustic labourer of our own time, who possesses all the means and appliances which human ingenuity and mechanical skill offer to facilitate his operations in the field, back to the period when tillage was carried on under difficulties not easily surmounted, and the primeval curse seemed yet to rest upon man with all its unmitigated force, "In the sweat of thy brow shalt thou eat bread."

Mr. Marshall has thrown his group into a very graceful whole; and we have endeavoured to reproduce it from the best point of view that includes the four figures: it will, however, be evident, that in doing this some one or other of them must suffer: it would be impossible to give in a picture or flat surface, with equal advantage to each, a group of figures, which, in the original, form a kind of circle, and should be examined from several points, to do them full justice.



AGRICULTURE.

(THE ALBERT MEMORIAL. HYDE PARK.)

ENGRAVED BY H. C. BALDING. FROM THE GROUP IN MARBLE BY W. C. MARSHALL R.



GLASGOW INSTITUTE OF THE FINE ARTS.

ON the 30th of January, the Glasgow Institute inaugurated its tenth anniversary by the usual *conversazione* in the Corporation Halls, under the presidency of the Lord Provost. Preliminary to our noticing the pictures, we would advert to the ampler resources and improved management of the society. Besides the vastly larger attendance on every successive exhibition and the consequent increase of sales, the directors are enabled to expend about £1000 yearly in the purchase of works intended to form a permanent collection. And, by extending membership to all persons interested, they hope to acquire a library, provide lectures, and endow a fund for decayed artists and their widows. The council of management is chosen annually, and the plan of the Royal Academy, to elect a hanging committee distinct from the jury who select the works for exhibition, has been recently adopted. One result of this arrangement is, that whereas last season every work offered was accepted, causing a large influx of inferior productions, the total number is this year materially reduced, while the general quality is advanced. A single word, however, against a prevailing custom, that of the introduction of loans from private galleries. For although we admit the contingent advantage in raising the standard of taste, yet it does seem scarcely fair to occupy the best places with pictures whose well-known merits have been already acknowledged by purchase. Why should not the walls be reserved for the products of those hard-toiling, earnest men whose incomes depend on their labours? We are led to speak the more strongly on this point as there are many of these loans in the present exhibition. And though when we look on that charming freak of maiden fancy, 'Fortunes,' by Leslie, or Thomas Faed's expressive 'Day is Done,' or the 'Willie Baird' of McTaggart, or Watts's 'Venus and Cupid,' we cannot but gracefully own their influence; still the thought returns that these loan works are not in their right place here.

Referring to the catalogue, we find out of 638 contributions an unusual amount of the foreign element—Honour to strangers! so we shall glance first at our Continental friends. The landscapes they send us are remarkable for extent of prospect, thus testifying to great facility in perspective drawing. They evolve distance so well as to lend twofold enchantment to the view. Witness 'Evening,' by A. Lier, where the eye wanders over glimmering waters arched by an immensity of dappled hues that fade far, far away into the dusky horizon. Witness, too, a 'Scene in the Tyrol,' J. De Kayff, in which the dreamy air hangs motionless over an interminable stretch of country. 'After a Snowstorm,' A. Schreyer, is a splendid reality of rude weather, perplexed travellers, and disordered cattle. Foremost, however, of foreign landscapes stands 'Rain and Sunshine,' W. Lommens. The clouds trailing in a black mass overhead, yet broken at intervals by the struggling sunlight, the lurid canal creeping along, the hush of nature's contending powers, all are rendered with the poetic fidelity of a high-toned mind. Among figure-pieces, 'The Tiff,' C. Bisschop, is chaste and effective. A female, whose profile is shown in a mirror, turns away in displeasure from her male companion, who, with face averted, clutches his hair in token of mental disturbance. 'The Reprimand,' F. Verhas, proves how thorns may lurk under a luxurious life; while great delicacy of finish is perceptible in Escosure's 'Amis de la Duchesse.' 'Taking the Measure,' A. Dillens, is full of *bourgeoisie* humour. The shoemaker's expression as he applies the instrument to the woman's foot is inimitable. In F. Flüygen's 'Princess Elizabeth and her Children,' the latter are excellently grouped, but the drawing seems flat and the colour weak. 'The Reverie,' J. Coomans, a female lavish in costume and possessing certain attributes of beauty, we cannot commend, by reason of the undue display of charms for which the only term

is meretricious; and whenever Art touches this ground, the spell is broken. When will J. Portaels vary his theme? He cannot but paint excellently as in the 'Normandy Flower-Girl.' But one string, however sonorous, grows wearisome, and these draped heads and heavy eyelids begin to pall. 'The Fisherman's Return,' J. Israels, abounds in careful details, yet is deficient in that *abandon* of joyous affection befitting the occasion. Thoroughly Dutch it is, thoroughly quaint—shall we not rather say, tame in expression? Why should the mother look sad? A. Ludovici has two burlesques after 'Guy Fawkes' Day' rather confused. And Madame Ronner gives several characteristic examples of animal ferocity and cunning—specially a 'General Flight,' where her drawing powers are largely tested, and come out victorious. Eugene de Block delights us with 'A B C,' the child's lesson by the mother's knee is soft and sweet, and steals upon the sense like "spoken sunshine."

While England supplies many valuable works, the Scottish artists are numerous and satisfactorily represented. There are two London men, W. L. Wyllie and C. J. Lewis, comparatively new to our catalogue, to whom we are richly indebted. We do not wonder that the former was honoured with the Turner gold medal in 1870, for there is a power in his painting which points to a sympathy with that great master. All his four pictures are fraught with an originality which, if not genius, is something closely allied to it. His cloud conceptions, as in 'Boats putting out,' fantastic shapes of rainy grey, careering athwart the sea, are quite his own, and yet they are nature's too. 'Napoleon's Ruined Harbour at Ambletuse' is a perfect ideal of desolation. But the 'South Foreland' is Mr. Wyllie's *chef-d'œuvre*. The theme itself, and the handling of it; the lonely watchlight on the intractable rock; the wide strata of ragged shelving stone; and that sky, thick peopled with the sunset's mystic vapours, what can we say but that the whole is sublime—is Turner-esque? Of Mr. Lewis's pictures 'Barley Harvest' is our favourite. The glorious expanse of ripe waving grain is beautifully relieved by the children rustling through it: while the sheep brouse on the wooded height, and the quiet country stretches in mellow luxuriance beyond. How tenderly J. W. Oakes introduces the sunlight in 'The Mill Road!' And then in his 'Morning—Bay of Uri,' how nobly he grapples with these Alpine activities, and lays his fearless hand on mist, and peak, lake, glen, and cloud! 'The Ford' is the best specimen we have seen of Beattie Brown. We feel its truth, and seem to scent the morning air. Alexander Johnston decidedly gains ground in his 'Music.' The two young females, blonde and brunette, are posed with easy grace, the colour is firm, and the details well wrought out. Miss E. Osborne is happy alike in the selection and manipulation of her single contribution. 'Lost' represents a child, who has strayed in a lonely thoroughfare, accosted by two Sisters of Mercy. The sweet simplicity with which the story is told is its charm. The picture was sold within a short time of its exhibition. James Archer sends three finished cabinets. 'My Great Grandmother and Grandfather,' a fine study of bygone years, though the mother's eyes have a slight stare that rather mars their brilliancy. 'Sir Patrick Spens' we made acquaintance with in the Royal Academy exhibition of last year. We would particularise J. Morgan's 'Snow-Balling' as instinct with boyish life and frolic; and 'A Warm Friend,' wherein a fisherman lends a light to his comrade's pipe (both standing knee-deep in water) is admirable. There are strength and beauty in a 'Highland River,' J. R. Marquis, only the multitude of objects suggests composition in the landscape, a device which pure Art disavows. We confess to disappointment in Lionel Smythe's 'History of a Great Battle.' An old man scoring his early memories on the ground with the point of his staff is a good subject; yet here we feel it is but indifferently told. The *locale* is excellent, but the principal figure wants interest. A. Perigal, the industrious, who appears to devote himself almost exclusively to the study of West Highland scenery, does fair justice to five

interesting prospects. 'The Guardian of the Glens,' C. E. Johnson, is a noble work. Rock, mountain, mist, and heather form a grand combination, and here are worthily represented. A word of cordial commendation to J. Pettie for 'The Ballet Lesson.' The face of the old dancing-master and the eager straining step of the girl are irresistible in their grotesque exaggeration. The picture, as our readers will remember, has been engraved in the *Art-Journal*. Walter Paton goes on his way rejoicing. There is ever the same soft *glamour* about his sunsets and crescent moons that draws the heart—ay, and the money too, out of the pockets of the *cognoscenti*. In the 'Falls, Glen Ashdale,' he soars a higher flight, and his pinion is bright and strong. The breath of spring is on our brows as we gaze on 'Cadzow Forest,' J. Docharty. And that rude 'Highland Cottage,' H. Darvall, with its mossy thatch, and the soft light on the hillock where the girl plies her knitting, is like a note of some old melody. 'The Return of the Patron Saints,' A. B. Donaldson, we must characterise as an extravaganza, wherein the rules of Art are wholly disregarded; while the grace that is possible to be snatched beyond these rules has not been reached. R. Brydall, who wields a somewhat fantastic brush, is with us again in 'The Elf-Dance,' and 'Bottom the Weaver.' C. Rossiter and V. Bromley give us each a specimen of the Pre-Raphaelite school, in clever cabinet pieces—'Scouts,' and 'Quoit-Players.' Colin Hunter "trawls" and "barks" the nets with all his customary skill. And E. Hayes carries us to lie 'Becalmed at the Mouth of the Scheldt,' or to swing and shiver in the 'Lifeboat' over the tempestuous seas. 'Snowdon,' by J. Finnie, lacks management of light and shadow. Not so 'The Port-Road, Skye,' where the *chiaroscuro* of the wild solitude is most skillfully arranged. 'The Bouquet,' J. Robinson, is a poor, tame affair, feeble of design, and washy in colour; and 'Juliet and Nurse,' A. Rankley, though bolder in outline, is flat and unsatisfactory. John Burr's 'Auld Lang Syne' well sustains his reputation. The sly smile on the child's face listening to her grandfather's fiddle, and the musician's grave satisfaction with his own scraping, form a clever and humorous combination. 'The Coquette,' J. Carolus, is one of those highly-finished interiors whose exquisite colouring is its chief recommendation. James Peel claims the merit of versatility, with firm handling of his subjects. In a 'November Morning' the figures and cattle are skilfully posed, and the misty background exceedingly effective. W. H. Weatherhead is a conscientious artist, but fails somehow to infuse interest into his work: 'The Duet' is manifestly the result of much thoughtful labour, yet why do we turn away dissatisfied?

The largest canvas in the rooms is Mrs. Anderson's 'Elaine' (previously noticed in our Journal). We have also in this exhibition 'The Duke of Montrose's Retreat into the Highlands,' R. Ansdell; 'To Obey is better than Sacrifice,' J. Linnell, Sen.; Macdonald's 'Prince Charlie's Parliament'; 'The Burial of Charles I. in St. George's Chapel,' C. Lucy; J. Napier's 'Esther'; 'Fontainebleau Forest,' Rosa Bonheur; a charming female portrait by Sir Francis Grant, and the sunny 'Vintage' of Carlo Ademollo. The portraits include several "presentations," and others, by D. Macnee; the most conspicuous being that of Principal Barclay, of the Glasgow University. Norman Macbeth's masterpiece, the Rev. Dr. Bruce, is also here; with the portrait of the late Duke of Athole, by J. M. Barclay; and many others.

The water-colours are fewer in number than usual; but many—as 'The Pyramids,' C. Vacher; 'Birchwood,' F. Walton; 'A Gleam of Hope,' C. Rossiter; 'Helvellyn,' Woolnoth; and more which we have not leisure to specify, attest the skill of their authors. There is a small section devoted to architectural drawings, among which Mr. Dick Peddie's 'Suggestions for the Improvement of Edinburgh' have caused some talk. No sculpture of the imaginative school is exhibited, except a pleasing figure, 'Young England,' by Halse; and there are a few busts by Brodie and Mossman.

INTERNATIONAL EXHIBITION OF 1871.

THE great gap which the war will cause amongst the contributors to the International Exhibition can hardly be filled during the present year. France, after having set an admirable example of spirit and energy, and spent some seven or eight thousand pounds in erecting the French Court, is now, it is hardly necessary to remark—nowhere. As to Germany, application has been made to her government for aid, which has been altogether refused—all available funds being devoted to a far different contest. It is out of the question to expect much, in such a case, from popular or personal enterprise. In some cases, including Wurtemberg, Baden, and Dusseldorf, local or municipal funds have been devoted to the purpose of encouraging and aiding exhibitors, and Germany will be, to that extent, represented; but we are not in expectation of much from other parts of the empire.

There can, we apprehend, be no doubt that every possible aid will be given to enable French exhibitors—should they come forward at the twelfth hour—to avail themselves of what has already been done by their countrymen. Even up to, and beyond, the time of the investment of Paris, the French government held to the engagements of its predecessor in this respect, and the balloon-post brought orders to proceed with the courts. We shall hope they will not be altogether deserted, even for a single year. We venture to suggest that facilities might be given—and, no doubt, will be—to French residents in England to show any articles in their possession illustrative of their national industry.

The Spanish commission has been appointed. The government of Spain has referred the management of matters connected with the Exhibition to a special department of the ministry of public works, and has published an official notification, in the *Gazette* of Madrid, that a preliminary exhibition of the objects intended to be sent to South Kensington will be annually held in the Spanish capital. Juries will be appointed to select from this exhibition objects that are considered worthy to be sent to London as representative of Art in Spain. These juries are appointed; following, of course, the English distribution of objects into scientific inventions, objects of Fine Art, and manufactures. Exhibitors will have no cost or trouble to undergo, further than the delivery of their articles at Madrid itself—all further arrangements for shipping and transport to London being cared for by the Government. If the exhibitors, after this, get their property back again safe and sound, they will be much to be congratulated. All articles are to be in the hands of the British Commission by the 15th of April. The services of the jurors are to be altogether honorary.

We are happy to find that Denmark has thought twice, rather than lose the opportunity of exhibiting her Norse jewellery, her walrus-tooth ivory carvings, her fictile terra-cottas, her wood-marquetry, and other objects of artistic interest, in the galleries at South Kensington. At the eleventh hour a Danish commission has been appointed. We congratulate both the Danes and the exhibitors upon the fact—which being arrived at, we have the more satisfaction of having delayed, until it was happily unnecessary to publish, the pro and con of the misunderstanding now happily terminated.

Italy has also, at the same advanced period of the business, named her commission. If she be as well represented at South Kensington as she was at Islington, in the Workman's International Exhibition, she will take no mean rank among Art-producing countries.

The lists of contributions from some other countries are so far advanced as to furnish materials for the commencement of the catalogues. This is the case with regard to Norway, Dusseldorf, Baden, and Wurtemberg. It will be seen that at all events a portion of the German empire has not entirely forgotten the arts of peace, while forging the thunderbolts of war.

Exhibitors should remember that it is not

the object of the managers of the Exhibition to allow such a repetition of similar objects, from the same contributor, as to approach the limits of advertisement. The general idea has been, that the objects admissible from a single exhibitor should be, in the case of scientific inventions, three at the outside; in the case of Fine Art objects, five; and in that of manufactures, twenty. It is not said that this will be absolutely a hard-and-fast line. Still, it is something like the rule which the commissioners will be likely to carry out. It has much propriety and common-sense to recommend it; and exhibitors will spare themselves trouble, expense, and, possibly, chagrin, if they apply it for themselves in the first instance.

The glass-cases are gradually filling the eastern gallery. They are substantial, neat cases, of ebonised wood, and good plate-glass—some of them supported on turned legs, others standing from the ground to the height of six or eight feet. Before this number of the *Art-Journal* is in the hands of our readers, though after it has left those of the printer, it will be possible to form a very good forecast of what the exhibition is likely to be.

Arrangements are in progress to facilitate the entrance of visitors to the Exhibition into the Royal Horticultural Gardens, and *vice versa*. The brickwork arcade lining the gardens is being completed by the insertion of terra-cotta plaques and medallions. A wooden trellis-work is being run along the open side of the arches, which will be covered by creeping-plants. The northern arcade of the conservatory will be fenced off, and appropriated to Exhibition visitors, thus completing the communication between the galleries on either side of the gardens, and also with the Royal Albert Hall. Season-ticket holders in the Exhibition will be allowed to enter the gardens at reduced prices, and a corresponding reduction in the terms of entrance to the Exhibition will be made to the ticket-holders of the Royal Horticultural Society. In fact, Art-Museum, Art-Library, Gardens, Exhibition-Galleries, and Amphitheatre, will form one associated series of combined attractions for the public.

The month of February will have passed when our Journal is in the hands of the public; we regret much that British contributors were compelled to deliver their contributions so early; they have almost universally complained that it is so; it was, we humbly think, needless; and will certainly have kept away many from the exhibition.

EXHIBITION OF THE SOCIETY OF FEMALE ARTISTS.

THIS society shows a persistency worthy of the best of causes. Undaunted by discouragement, it ever renews virtuous efforts, and whatever may be wanting in point of Art finds compensation in good intentions. The misfortune seems to be that "female artists" are not content with the single blessedness of a gallery all to themselves; they court, in fact, those galleries where they can enter into rivalry with the opposite sex. Hence, from time to time, "Female Artists" have to deplore serious secessions: a reputation may possibly be won in Conduit Street, but the high rewards of the profession have to be sought elsewhere. The beneficent managers of "the Society of Female Artists," though they rightly spurn commiseration, deserve, indeed, encouragement. The cause at heart has remained good, while suffering from inadequate support. Taking into account, then, the difficulties involved, much credit is due to lady-patronesses, honorary members, life-subscribers, and others, for the good exhibition now open. At the private view might be observed many persons who feel sincere interest in the undertaking; and there seems reason to hope that the gallery will not now, or in coming years, languish either from lack of talent or from want of timely patronage.

The gallery, as heretofore, is divided between water-colours and oils: on the side assigned to the former we observe more or less successful attempts at the figure, or rather at costume, by Madame Bisschop, Mrs. Backhouse, Helen

Thornycroft, Julia Pocock, Louise Stern, Rebecca Coleman, and Miss F. Claxton. Madame Bisschop has advanced amazingly, as might be anticipated, since she surrendered her maiden name of Swift for that of one of the most promising painters of Holland. 'L'Espoir de la Fouille' (99), displays the best traits of her husband's style. Though the colour be rather opaque and the background over heavy, the general effect is powerful and brilliant. Shadows, deep as those of Rembrandt, are lit up by warmest lights; drawing is nowhere shirked, the outlines throughout are put in firmly as if with a reed pen. On the whole, this is the most masterly work in the room. Somewhat more juvenile, yet abounding in promise, is Miss Helen Thornycroft's 'Study' (181) of a bearded Turk. The colour is poor and the background dense, but the drawing of the head and the expression of the hands are admirable. Also worthy of commendation is a faithful study from the life, 'Die Haustochter' (76), by Miss Julia Pocock, who, unlike the major part of the sisterhood, does not through vain ambition attempt more than can be accomplished. Want of knowledge, coupled with the desire to make a vast impression, is the bane of female artists. 'Thinking it over' (47), by Miss Stern, the subject being limited to a boy and a book, seems to have promise of something yet better. Also 'A Child's Message to Head-quarters' (293), by Rebecca Coleman, merits encouragement. Miss F. Claxton and Mrs. Backhouse, however, are not to be thus put quietly aside by faint praise: 'Juliet' (254), by the former lady, is highly spiced, and 'A Girl at Crochet' (13), by Mrs. Backhouse, is thrown off with a sketchy and confident hand. 'The Little Blonde' is slight in finish, but of much grace and beauty: there are few more efficient works in the collection. We rejoice also to find that an artist, bearing the name of Bouvier, has for once gone to nature. 'The Goldfinch' (170), by Miss Bouvier, though rather artificial in the figure-painting, may be taken from the life. At least, we venture to prophesy that the lady's talents would not have long to wait for reward, if she could be induced to forsake a false ideal for the realism of nature. On a screen should not be overlooked five dreams by E.V.B. (the Hon. Mrs. Boyd). These drawings in black and white evince considerable inventive power: the story in its progress gathers mystery: Albert Dürer, towards the close of the dream, was evidently called in to assist.

The ladies of the family of Mr. E. M. Ward, R.A., lend their presence to the gallery—'Going to Market—Picardy' (416), is a composition Mrs. Ward contributed to the last Academy exhibition. This clever artist is at home, in every sense of the word, in a charming little drawing, 'A First Step in Life' (339). In pictures of the nursery the painter is unrivalled. Mrs. Ward has the satisfaction of bringing betimes before the notice of the public the talents of her daughters. Really the painstaking drawings of interiors and doorways by Miss Flora and Miss Eva Ward, indicate that the young ladies may live to distinguish themselves among female artists.

From a multitude of landscapes, mostly marked by mediocrity, may be selected for somewhat more than commendation, contributions by Miss M. Croft, Mrs. Marrable, Madame Boddichon, Miss Warren, Miss Kempson, Miss Morice, Miss Deakin, and Mrs. Dundas Murray. 'Old Eastbourne' (152), and 'Low Tide, Lynmouth' (185), by Miss Croft, are cheerful and pretty; the artist is pleasing in colour and joyous in daylight. Mrs. Marrable contributes ten drawings, her talents thus have ample sphere. They are drawings of high and standard merit, and would attract attention and approval anywhere. 'Near Benhill Wood, Surrey' (304), is Miss Warren's best landscape; the drawing, being small, is not beyond her power. Miss Nichols has but one work, 'The Brook' (9), the execution is careful throughout, and has promise. 'Solitude' (117), by Miss Kempson, is grand in mountain-form, and effective in colour; the treatment, however, as usual among female artists is obvious, not to say trite. 'Low Tide' (205), by Jane Deakin, has been brought into pleasing tone; the lady would prove her know-

ledge of nature by greater resolution in the forms. A charming drawing, 'On the Norfolk Coast,' by Mrs. Dundas Murray, demands special notice for its truth and force. 'Cope at Brenchley: Early Spring' (140), by Miss Morice, shows that care in detail and accurate observation of the facts of nature, which most ladies appear to hold in contempt. Seven or eight small paintings, under agreeable titles, are by Mrs. Crawford: four of them represent "the seasons;" others 'Industry,' 'Idleness,' &c: they will attract attention as works that manifest earnest feeling and sound judgment, and show good teaching in a good school. They are pleasant pictures, such as are loved in English homes.

On the screen are some carefully executed medallions in marble, wrought by Mrs. Freeman of Rome, and Miss Foley of Rome, severally lent for exhibition by Mr. and Mrs. S. C. Hall. Two of them are charming copies of infancy, true to the life; the other is a portrait. Miss Foley is an American lady, resident at Rome: in her own country and in Italy she has obtained large and merited celebrity: she is, indeed, one of the many sculptors of whom the New World may be justly proud.

Flower-pieces abound as heretofore; in fact, the names of the ladies who can paint flowers fairly well, are legion. Again Miss Charlotte James succeeds to admiration: 'A Gathering in Autumn' (27), is as transparent and brilliant in colour as true in form. Also, we would direct special attention to 'Periwinkle' (215), and other like masterly studies, by Madame Hegg, firm in touch, and certain of result; the flowers stand out boldly in forcible distemper colour, on a deep-toned paper. We had expected to meet with good work by Miss Eastlake: the lady, however, would seem to have forsaken the "Female Artists," in favour of the superior attractions of the Dudley Gallery: and that is matter for regret. We have marked, as meriting attention, studies by Miss Lane, Miss Webb, Miss Walter, Miss Fitzjames.

The oil-paintings, about one hundred in number, show, we could fancy, some slight improvement on previous years. Miss Ellen Partridge contributes a powerful portrait of 'Professor Macdonald' (435). Mrs. Charrette, too, has seldom succeeded better than in 'Alan and Linda,—children of Col. Mackinnon' (386). Mrs. Crawford also attracts attention by a couple of effective little figures, 'Industry' (364), and 'Idleness' (371). These pictures evince a knowledge above the average of surrounding attempts. Louise B. Swift succeeds in the painting of a dog in 'Guard it well' (390); 'Feeding time' (423), likewise, is better in dogs than in humanity. In the way of landscapes, two may be worth notice, 'Sunrise on the Jungfrau' (403), by Fanny Assenbaum, is startling by reason of the wide expanse of white snow-fields. The picture would be improved by closer study in the detail. Clever, and brilliant in light, are Italian Studies (345, 372), by Mrs. Benham Hay. Perhaps the most artistic landscape among the oils is 'Morning on the banks of the Medway' (430), by Miss C. F. Williams. The treatment is simple and broad, and the details are kept in due subjection to the general effect. Mrs. Stanard, whose showy fruit-pictures we used to encounter in the British Institution, reappears in London, with no diminished force, among "Female Artists." 'Apricots' (413), and 'Hambros' (420), are scarcely inferior to the effective pictures of Grönlund, and Robbe of the Belgian School. The approved talent of Miss Starr is pleasantly represented by a 'Sketch' (334). On the whole, the most remarkable work among the oils is 'Found at last' (394), by Miss Alyce Thornycroft. The action of the mother who at last comes upon her lost child, is finely conceived. The picture suffers by crude colour in the background, and the young artist still lacks executive power to do justice to her thought. The gallery in Conduit Street is not open in vain, when it gives to young people the opportunity of bringing their talents to the test of public exhibition. It may, moreover, be truly said, that in no other room in London can pictures be better seen or more justly appreciated.

TERRA-COTTA ALTO-RELIEFS FOR BURSLEM.

WE have recently inspected, with more than usual pleasure, the designs for the sculptural adornment, in *terra-cotta*, of the Wedgwood Institute at Burslem—now in course of execution. The designer and modeller is Mr. Rowland J. Morris, a pupil of the Kensington School of Design. The treatment of the subject is a credit, not only to the artist, but to the establishment of which the work is an out-come. The breadth and largeness of style, the originality of ideas, the appropriate and well-balanced filling of given spaces by figure groups, are all so many proofs of the truly artistic spirit impressed on his pupils by Mr. Burchett, the head-master of the school; and more especially by Mr. Felix Miller, the director of this branch of the establishment. We propose to take a convenient opportunity for giving our readers a glance at the state and products of the school itself, and of the service which it bids fair to render to Industrial Art.

Mr. Morris's reliefs, taken from 'The Triumph of Julius Cæsar,' by Andrea Mantegna, form two series. One consists of ten oblong plaques, representing the details of the work of the potter, the other of twelve nearly square panels, each containing a figure illustrating one of the months of the year.

The months are all of life-size, but in each case the figure is so brought together in a kneeling, stooping, or sitting posture as to keep within an outline approaching the square. A very picturesque effect is thus given to the series. At the same time there is little repetition of attitude. It is impossible for a sculptor to say that the designs are appropriated, or altered, from any known examples. There is originality in them, as well as force, and a noble conventionalising of the head and features of which we cannot speak otherwise than in high terms. January, a female draped figure, kneels on one knee, embracing, a nude boy—the young year,—in whose hand, thrown over her shoulder, is a posy of snow-drops. February is a young rustic, armed with a bill-hook, and grasping a newly-grafted sapling. March kneels with a dibble in one hand, with which he prepares to plant a cabbage seedling which he holds in the other. April, perhaps the most perfect figure of the series, in the original sketch has her face in profile, and both her arms thrown up. In the finished model the May is a graceful half-kneeling figure, facing the spectator, and characterised by a wreath of spring flowers. June is represented by the sheep-shearer. July by the mower with his scythe. August by a reaper with a sheaf of corn, which, however, is rather more like maize than wheat, in its tufted growth. September is an especially happy inspiration, a Kentish hop-picker, with all the nerve and vigour of one of those sturdy maidens who present the nearest resemblance now anywhere to be found to the sculptured votaries of Bacchus. An intruder in a hop-garden runs a very close chance of being tossed into the hop-bin, a fate which might be thought not altogether disagreeable if the English Bacchante had not been considerably poetised by Mr. Morris. October stoops to raise a basket of grapes and apples. December tries to warm his hands and flowing beard over a fire; an old, old idea, yet newly treated by the artist.

The reliefs illustrative of the labours of the potter are not less original than those representing the months. First, we have the gallery of the coal-mine, with the miners in their appropriate dresses, their picks and other tools, the trolly—a low truck on which the coal is wheeled to the bottom of the shaft—and the great gift of Davy—the safety lamp—which, even now, the miner will at times carry in one hand, while he solaces his toil with a glowing pipe, or even illumines it with a naked candle. Then we are introduced to the mill. Then to the mixing and wheeling of the clay. "Throwing" is the next of the series—a young female turns the wheel, which gives motion to the whirling table of the potter. In this employment, picturesque enough in sculpture, female labour

is now, we are glad to say, rarely employed. The potter forms the vessel, as he has done for thousands of years, and a man carries off a tray full of his work to the fireman. Then comes turning and handle-making, in which work both sexes are engaged. "Modelling, mould-making, and figure-making" is the subject of the next panel, a title which explains itself. Then comes "saggur making," the formation of the earthenware cases, like large bread-pans, in which the smaller articles are enclosed in the furnace, to prevent injury from dust or dirt. "Plate-making," a separate branch of the craft, comes next. Then printing, on revolving cylinders, and dipping, into a vessel full of liquid enamel. Last of the series is "painting, varnishing, and gilding," a department in which female skill is appropriately employed. The series gives an admirable view of the principal procedures of that craft which owes so much to Wedgwood.

It is a matter of great satisfaction to us to find that the Ceramic School of England has given such vigorous signs of active and independent life. While fully admitting that the exquisite delicacy of the old Wedgwood ware has never been rivalled by any subsequent potters, it is yet in all respects well that the efforts of the rising race of artists have not been confined to the barren limits of imitation and of reproduction.

We regard this matter from a national standpoint—and thus we rejoice in what promises to be a cradle of English Art. English seasons are represented in the months. We have, in place of the ever-copied Italian Vintage, the equally picturesque and *naïve* hop-picking. We are not sent, for the illustration of the history of pottery, to study reproductions of Egyptian, Assyrian, or Etruscan moulders of clay. It is the actual movement and habit of the English potter that is brought before us, conventionalised and idealised enough to remove any sordid associations—coarse work in clay is *very* coarse—but yet stamped with a proud and elastic nationality. When we contrast these scenes, again, with the base and slavish realism into which portrait-sculpture is sinking, as evinced by some recent English, and still more by some recent Italian productions, on the one hand, and on the other with the slovenly half-work—of which also we can cite recent examples—which the authors dignify by the term conventionalising their subject, we think it the more needful to insist on the mode in which the Scylla and Charybdis of modern Art have been both safely avoided.

We must not speak of these productions of Mr. Morris as the work of a school alone. They are the creations of a native artist, and an artist who promises to make his name well and worthily known hereafter. This promise is enhanced by the circumstance that he is not content with his work, nor afraid of that constant, incessant, immense labour by which alone talent can win its way to fame. But it must be borne in mind that natural talent, even if it amount to the heroic proportions of genius, is never independent of the true school of study and of labour. An untaught genius may produce works which surprise us *because* they are the works of an untaught man. What we require is work that is noble in itself. The early guidance of artistic taste and skill in a right direction effects, therefore, an economy of time which, if wasted, can never be recalled. Twenty years of wandering after truth, even if it include a visit to Rome and a faithful drawing of the *chef-d'œuvre* of ancient sculpture, can never produce the same result as two or three years of well and wisely directed study, under such guidance, and aided by such appliances, as we rejoice to recognise at South Kensington. Objecting, as we do in many important particulars, to some of the principles which regulate that establishment, we are the more willing to bear a hearty testimony to success when we meet it. And indeed, in this instance, success is attained because the course which we always advocate has been followed. Our opinion is, that the best traditions of Art and of Science should be not ignored, but followed and wrought out. Thus we hold that architectural works should be committed to trained and practised

architects—not to military engineers or amateurs. Thus we hold that appropriate knowledge should always be sought out and utilised—not that any man should be shaken by chance into any place. Now in such regeneration of Ceramic Art this wise course has been followed. Drawing has been efficiently and systematically taught. Men trained and competent for the task have been selected to train others. The normal course of artistic education has been adopted and developed. The result is good, beyond expectation. We hope, and we believe, that we are but at the beginning of the triumph.

Mr. Morris has in these works achieved a reputation honourable and high; he is, we believe, destined to obtain a very foremost place in his arduous profession; it is by no means an exaggeration to say—nothing, *as a continuous series*, so entirely good has been produced by any English sculptor since the time of Flaxman. He is young, his career is but beginning, as yet his name is unknown to Art; we feel assured, however,—if his industry is equal to his genius—he will become one of the most renowned of its professors.

PORCELAIN AND OTHER CLAYS.

No branch of Art, either Fine or Industrial, is so truly local in its nature as ceramic work. To a great extent, indeed, the characteristic of localisation may be said to be a peculiarity of plastic, as distinguished from graphic, Art. But while this is true to a great extent, it is chiefly in the lower departments of sculpture that it occurs. The style of decoration peculiar to a district, depends very intimately on the character of the stone which it produces. In countries destitute of stone, or floored with hard and rugged rocks that refuse to lend themselves to the chisel, native sculpture is unknown. In regions, on the other hand, where a fine and marble-like travertine has been deposited by the gentle current of the rivers, or where a soft, homogeneous limestone tempts the knife or the graver, decoration bursts into spontaneous flower, and the humblest abodes are adorned with foliage, or fret-work, or even animal representations, on jambs, and cornices, and mullions. But for the nobler kind of sculpture, the material is so rare that it has become the subject of special commerce and merchandise. Vicinity to Carrara will hardly make a man a sculptor. On the other hand, in the *ateliers* of Denmark, of England, of France, and of America, no less than in those of Rome and of Florence, the pure white marble of that unrivalled quarry is to be found as a matter of course.

But in the industry of the potter, under all its different branches, the material in which he works is so bulky, so crude, so different in its value in a raw and in a wrought condition, that the pottery is almost, if not always, confined to the close vicinity of the bed of clay which is utilised for the purpose of manufacture. With this natural localisation of the work is associated a certain family likeness, readily discernible by adepts in the matter, which stamps the production of a special fabric with an unmistakable physiognomy. Thus, in all our early English schools of pottery we find a definite stamp, which is due rather to the special qualities of the clay, than to the schooling of the workmen. Let the same artist deal in precisely the same way with two samples of clay from different mines, and the result will be different. Thus Bow, Chelsea, Derby, the different Staffordshire establishments, and every branch of the old English school, has its separate character. Thus the peculiar veneer of the Henri Deux ware can be imitated exactly in no clay but that of Oiron. With enamelled pottery, artificially coated by a glaze, the case is of course different. But in all true china, terra-cotta, and non-enamelled earthenware, the test of the mode of behaviour of the clay under firing is absolute.

With the wide extension given of late years to the products of the potter, the exportation of commerce of special clays for special purposes, is becoming more and more common. Thus from Cornwall in the year 1869, we learn from the keeper of the Mining Records, upwards of 100,000 tons of kaolin, commonly called china-clay, and nearly 30,000 tons of china-stone were shipped. This quantity shows an increase on the former year: of fire-clay, on the other hand, which is produced at St. Agnes, a decline in the shipment has taken place, 875 tons being consigned to Wales, and 500 tons being locally consumed. Devonshire exported, in 1869, 44,500 tons of clay, from Newton and its neighbourhood, which were shipped at Teignmouth; and 11,700 tons from Lee Moor and other china-clay works. From Poole, near which port there is an extensive bed of clay supplying local works, 60,000 tons were shipped last year, one third going to London and nearly another third to Runcorn. This shows an increase over the total shipped in 1868 from that port of 2,000 tons. We have no returns as to clay shipped from Belleek. It would be interesting to know whether the iridescent faience now produced in Worcestershire is manufactured from Belleek clay, or, if not, to what it is to be ascribed the wonderful resemblance in fabric. The egg-shell ware producible from the Belleek clay, as any one may see by a visit to Mr. Mortlock, in Oxford Street, is not to be surpassed in its wonderful and delicate transparency by the best Oriental china.

A pottery map of England, showing all the sites of ancient and modern manufacture, and indicating the geological qualities of the several deposits, would be a great boon to Industrial Art. We commend this idea to the authorities in Jermyn Street. A comparative map of the world, pointing out the most famous ancient centres of ceramic work, and supplying the geological key, should accompany the English map, which would be drawn on a larger scale. A very large amount of valuable information, of the utmost service to the manufacturer, might thus be supplied, at small cost, by those who have the materials at command.

CRYSTAL PALACE.

THE Directors, with a view of increasing public interest in the picture-gallery of the palace, have resolved to recur to a plan adopted one season four or five years ago, and which was, we believe, found to answer so well that we are surprised it was not continued. They have announced their intention to offer prizes for "the best pictures of the English and foreign schools, to be exhibited at the Crystal Palace on and from the first of May, 1871, and during the continuance of the International Exhibition in London." The prizes for the English school will be:—For the best Historical or Battle-picture in Oils, £40; for any other Figure-subject in Oils, £35; for Landscapes or Sea-pieces in Oils, £30; for the best Water-colour Drawing, irrespective of subject, £25. Experience having shown that continental artists prefer, as a rule, honours rather than money, large silver medals will be awarded to them according to the following classification:—History and *genre*-history, 2; *Genre*, exteriors and interiors, 2; Landscape and Animals, 2; Marine and Coast Scenes, 1; Interiors and Exteriors of towns, churches, &c., 1. No picture will be considered eligible which is not actually the property of the painter; and it must have been painted within the last two years. The jurors are to be selected from gentlemen well-known in Art-circles. All communications may be addressed to the Superintendent of the Gallery, Mr. C. W. Wass.

LORD MAYO'S SPOLIA OPIMA.

MEN, to say nothing of women, have adorned themselves with the spoils of the chase from the earliest date of which we possess record or relic. Coats of skins are mentioned in the same ancient story that first tells us of a woven hempen garment. The plumes which are so proudly borne by the peacock are transplanted, without need of manipulation, to the head of the barbaric chief or the dusky beauty. Those of the ostrich would not be recognised by their original wearer when, having passed through the stoves of Leghorn, they come to decorate a drawing-room at St. James's. But the half-clad nations of warmer climates witness a lustre and glory of animal plumage unknown in our grey climate. We may watch the stately peacock—an export from India as old as the time of Solomon—dreamily spreading forth his magnificence in the sunny walks of some venerable country mansion; we may admire the metallic reflection on the neck of the blue or black pigeon, the emerald lustre of the caged "blue-bird," or the less familiar sparkle of the crest and tippet of the pheasant; and here and there by the side of rapid and shady brooks, we may catch a glimpse of the brightest of the English *fauna*—the blue and orange glory of the king-fisher, darting like a flame over the water; but for more varied splendour of plumage we must seek regions nearer the equator. From the forests of India Lord Mayo has collected some magnificent specimens of furred and feathered game, to which Mr. Edwin Ward has given the second life due to the skilful taxidermist. The contrast between a skin carefully prepared, in the first instance, for transmission to this country, and then entrusted to the care of such an artist as Mr. Ward, and the long and rueful lines of dusty and grimy specimens which fill the cases of the British Museum, is almost as great as that between a man and a mummy. Drawing-room ornaments of the greatest elegance are constructed out of these sylvan trophies. The Argus pheasant, his tail spread out in a fan, forms a screen of more than four feet in diameter. Smaller screens, needing the protection of bell-glasses to preserve their beauty, are made of white satin, with two or three tiny birds, or gigantic butterflies, relieved on the gleaming surface. Cases containing thirty or forty birds of every variety of form and colour—though all selected for diminutive size—with woven nests, and eggs like snigar-plums, again form screens to arrest the heat, but not the light, of the fire. In close companionship with Lord Mayo's spoils are objects of interest from very different localities. The Lapland owl—*Strix Laponica*—is a magnificent impostor of a bird, who assumes commanding proportions—while really small in limb and in body—by the aid of a full, thick, wadded petticoat of feathers (most of his congeners only wear trousers), and a head-dress which cannot be termed a hood, but which makes up an apparently enormous head out of ears, eyes, and features.

But the most original of Mr. Ward's reproductions of animal form is one, the mere title of which would be received in the nursery with shouts of applause. It is the glorification of a rocking-horse—none other than a rocking-elephant. A baby elephant, born in the Zoological Gardens, but misliking the soil or the climate, has been arranged on rockers, furnished with a saddle accommodating four children, and with a seat for a more enterprising boy at each extremity of the rockers. Then there is the lovely humming-bird jewellery, a patent for which was taken out by a jeweller some five or six years ago, but which has been manufactured by Mr. Ward for twenty years back. Beetle-jewellery—brooches, and bracelets, and necklaces, all formed of the diamond beetle. The last thing we can notice in this organic adornment is the tiger-claw jewellery—the carved, compressed, cruelly-pointed claws of the tiger, set in gold, and looking like something between jade and amber.

Mr. Ward's rooms, where the objects belonging to Lord Mayo have been exhibited freely to the public, are at 60, Wigmore Street, Cavendish Square

MESSRS. AGNEW'S EXHIBITION
OF
WATER-COLOUR DRAWINGS.

THIS collection is rich in many things ancient and modern. May we not call those men the ancients of our water-colour school, whose names are shut up in books, and whose reputations are become rumours? It is not often we find, mingling in a throng of drawings of the present day, others that have arisen from that slight method of working prevalent when water-colouring went little beyond a broad wash. Of these drawings there are nearly 200, and they have evidently been gathered in from the four winds, for they immediately illustrate, or refer to, every state of the Art. There is an example of Girtin, 'The Rainbow' (132), which will be curiously examined by all interested in the story of water-colour: such works will now come to the surface as the Art becomes more extensively appreciated. By Stothard are 'The Novel' (12), 'Nymphs Bathing' (150), and 'A Conversation Scene' (158)—drawings evidently made for engraving, showing the drudgery to which the artist was condemned by the vulgar exigencies of his time; yet are they sufficient to familiarise us with the mind of the man who could never conceive a Satan or a Beelzebub, a Macbeth or a Gloucester. Even in those three drawings we taste that ineffable sweetness which was the savour of his whole Art-life. Nos. 45 and 71 are respectively 'On the Thames' and a 'Landscape,' in both of which is exemplified Varley's predilection for composition; as both are characterised rather by poetic conception than natural suggestion; but always marked by peculiar elegance and beauty. His colour is, it may be said, strongly mannered, for he has not dealt with the tints, but the lights and darks, of nature. With Varley we may mention Sir. A. W. Callcott, for their studentship was passed together, and both, though by diverse means, laboured sympathetically to the same end. The latter is represented by two drawings both (166) called 'Italian Landscape,' and both recognisable as nearly akin to some of the lovely Italian landscapes which he put forth from time to time. But in everything Callcott did there was much more than a mere dry record of time and space, as was abundantly shown in his last great work, an English landscape, in which he seemed to have summoned to his aid all his fascinating power of describing home-scenery. Of Turner are six examples, all in his latter or flamboyant manner, and after he had parted company with Girtin, De Wint, and all those who insisted on painting their material substantially. The subjects are 'Corfe Castle, Dorset' (2); 'The Niessen' (114); 'A Swiss Lake' (121); 'In the Tyrol' (127); 'Abbotsford' (152); and 'A Wreck Ashore' (169); and here again and again we are transported into dreamland, whence we return more than ever impressed with the enchanting visions whereby the senses have been absorbed. Some of these look as if made for engraving, having here and there lines purposely left somewhat hard, to get the plate up to a certain amount of definition. And what of David Cox? He is here also, living and discarding in no fewer than thirteen different themes—there may indeed be more, these are what we have seen; and among them are 'A Forest Scene' (116); 'Bolsover Castle'; 'The Vale of Dolwyddelan' (128); 'Ulverstone Sands' (144); 'Landscape with Castle,' &c.; and in one or other of these is proclaimed some great feature of nature. Copley Fielding is present, telling admirably in some of those drawings which he worked out in a great measure on the spot, as 'Dartmouth' (10); 'Guildford, Surrey' (48); 'A Scotch Lake,' &c. 'An English Landscape' (1), is a good instance of his feeling in composition; and in several is shown his wonderful power in dealing with atmosphere and distance. Specimens of G. Barret are entitled—'Softly sighs the breath of Evening' (25); 'Classical Ruin—Moonlight' (83); 'View near Shropshire' (90); and 'A Landscape Sunset' (97). No. 83 is a very elegant example of a taste that prevailed with many of

the best of our earlier water-colour painters until it was superseded by intense naturalism.

By P. De Wint there are 'The Undercliff—Isle of Wight' (87); 'Dunster, Somersetshire' (38); and 'Near Alston Moor' (110); and by Prout 'Nuremberg' (24), and 'An Old Mill' (115); in which the artist is exhibited at home and abroad. The veteran J. Linnell must not be forgotten, because we are so seldom reminded of him in water-colour. His drawings are—'Sunset at Hampstead' (171), and 'On the Thames' (170), both of which have reference to ulterior essays. 'Wind and Rain' (77), and 'Off Portsmouth' (4), by George Chambers, are fresh and sparkling memoranda of what he saw and what he meant to paint. The former of the two is so fully made out that in working from it he might alter it, but could not give it a more perfect finish. 'Muleteers at Granada' (145), by J. F. Lewis, R.A., may be cited as a curiosity; so rarely do we see a sketch by Mr. Lewis of the early period of his career. This drawing was, we think, published in the series of his Spanish sketches. He and David Roberts were among the first English artists who broke ground in the then virgin-field of the Peninsula. 'Moel Siabod' (20), by Müller, owes everything to the sparkling accident of its rapid execution. 'Autolycus and his Wares' (100), J. Gilbert, is a large drawing, and very full of figures, pointing directly to the source of inspiration; but, perhaps, wanting in the pungency which seasons Mr. Gilbert's less crowded presentations, as 'Christopher Sly and the Page' (50), the exquisite scene from Gil Blas (37), and 'Lancelot and Gobbo' (81). 'The Suppression of a Monastery—an episode of Harry VIII.'s time,' is a scene peculiarly in G. Cattermole's vein. It presents a noble interior crowded with figures; the abbot and the monks departing, and the authorities of the king's commission packing up the plate and the other valuables. Roberts's drawings refer to his Spanish and Oriental series, being—'The Gate of Justice—Entrance to the Alhambra' (39); 'Ramleh, Palestine' (67); 'The Great Sphinx' (78); 'Nazareth' (105), &c. By Creswick there is but one drawing, it is called 'Crossing the Brook' (96); drawings by Creswick are not numerous; his small illustrative works were generally in oil. By E. Duncan, 'The Bass Rock—before Sunrise' is really a grand production; in everything strikingly original. 'Landscape with Sheep' (65), and the charming study, 'A Cloudy Day, South Wales,' are also by E. Duncan. 'Sabrina' (133), and 'A Study' (135), are two very masterly sketches by W. E. Frost, R.A. The elegant taste for such classic conceptions has all but died out. We know of no other artist who could, with so few lines, realise so much grace and beauty. 'Going to Market—Pont-y-Pant' (14), is one of F. Tayler's very spirited sketches. There are also 'Bringing down the Kye' (30), and equestrian subjects, in which he stands alone. 'Easing her down' (16), is one of R. T. Pritchett's very characteristic Dutch sketches, of which there are several of great merit. By Birket Foster are drawings in the best phases of his light and brilliant manner: and landscape and cattle-subjects charmingly finished by H. B. Willis: in the same direction T. S. Cooper, R.A., distinguishes himself by several highly-finished studies. There is also a very finely composed and highly-finished incident of Spain by an artist—Havelock Mason—as yet but little known, but who is, of a surty, destined to become famous.

The collection altogether, from its variety and comprehensiveness, forms the most interesting exhibition of water-colour drawings, considered historically, we have for a long time seen. In addition to the works mentioned, there are others by Topham, Hunt, Smallfield, Lundgren, Richardson, J. D. Watson, G. A. Frupp, W. B. Burton, J. B. Pyne, Carl Haag, G. Dodgson, &c., &c.; and, notably, a very charming drawing by Kaulbach, reminding us of the very best ideals of Thorwaldsen.

We have looked at this collection as a great lesson replete with refreshing memories, of which it is a privilege to have reawakened.

MINOR TOPICS OF THE MONTH.

THE ROYAL ACADEMY.—On the 24th of January, Messrs H. S. Marks, F. Watson, and T. Woolner, were elected Associate-members of the Royal Academy. These elections are satisfactory: the three artists had claims to the distinction. There are others yet "outside" who have as good right as they had to admission within: but the wisdom of "the forty" persists in limiting the associates to twenty—notwithstanding a clear contract with Parliament and the public to augment the list when candidates presented themselves with claims unquestionable and admitted. We could name a dozen—perhaps a score—who are as worthy of the honour as any of those who enjoy it. The principles of honour and equity are ignored by the Academy in excluding those who are as "capable" to day as they will or can be during any period of their lives. It is to be hoped that, during the present session of Parliament, some patriotic member, who loves Art, and renders homage to Justice, will ask the why and the wherefore of a course so prejudicial to the one, and so utterly opposed to the other.—Four lectures on Architecture will be delivered at the Academy during the present month: two by Mr. E. M. Barry, R. A., on the 2nd and 16th; and two by Mr. G. E. Street, A.R.A., on the 9th and 23rd.—Mr. Weekes, R.A., commenced his series of lectures on Sculpture at the Royal Academy, on the evening of February the 13th, and continued them on the evenings of the 20th and the 27th. The three remaining lectures will be delivered respectively on the 6th, 13th, and 20th of the current month.

THE OFFICIAL CATALOGUE.—Her Majesty's Commissioners for the London International Exhibition, 1871, have arranged with Messrs. J. M. Johnson and Sons, of Castle Street, Holborn, for the printing and publishing of the official catalogue. Messrs. Johnson were, it will be remembered, the publishers of the several official catalogues connected with the Universal Exhibition at Paris in 1867.

ROYAL ALBERT HALL.—The Hall will be opened by her gracious Majesty on Wednesday, the 29th of March. An advertisement states that the cost of a box on the second tier, containing five seats, will be 15 gs., the boxes on the first tier "being all appropriated." The prices of ordinary seats vary from £3 3s. each to £1 1s. If these enormous charges be for "that occasion only," they may, perhaps, be justified; it is probable that 8,000 persons will be readily found to give any sum for a sight of the Queen, and to hear the National Anthem in her presence. It will be an event to remember, as a source of happiness, during a long life. But we hope these prices do not indicate that a feast of music is to be enjoyed only by the very wealthy. To say nothing of the high moral and intellectual teaching—which is understood to be a first duty of the projectors of the Albert Hall—it would be a very short-sighted policy to place so emphatic a ban against the admission of the middle classes.

THE INTERNATIONAL EXHIBITION.—The *Art Journal* Catalogue will be commenced on the 1st of May; the first part being issued on the day of the opening of the Exhibition. It will contain engravings of the works of leading Art-manufacturers of England—Copeland, Minton, the manufactory at Worcester, in porcelain; the works in silver of Hunt and Roskell, and Hancock;

the venetian glass of Salviati; the furniture of Gillows, the cabinets of Jackson and Graham; and some of the beautiful works in wrought iron and carved wood of Italy. We shall continue to issue such engravings from month to month during the greater part of the remaining months of the year; and we shall hope to represent, as heretofore, all the leading manufacturers of the world, who are contributors to the Exhibition. It is needless to state that the only tax we levy on the manufacturer is that he incurs by furnishing us with photographs or drawings from which, aided by study of the actual objects, our engravings will be made. We shall make no deduction from the ordinary number of pages, and we shall not omit (as we did in the case of the Paris Exhibition) one of the three engravings on steel; but the pages which represent the Exhibition will consist of only twelve pages—sufficient, we believe, to satisfy the public and the contributors.

ROYAL SCOTTISH ACADEMY.—At a general meeting of the Royal Scottish Academy, held in Edinburgh, Mr. J. M. Barclay, A.R.S.A., and Mr. G. Paul Chalmers, A.R.S.A., were elected Academicians, in room of the late Mr. D. O. Hill, R.S.A., and Mr. James Giles, R.S.A. Mr. Barclay is a portrait-painter; Mr. Chalmers's works are chiefly figure-subjects.

AT THE SOCIETY FOR THE ENCOURAGEMENT OF THE FINE ARTS, on Thursday, the 23rd of January, Sir Digby Wyatt in the chair, a deeply interesting and highly instructive lecture was delivered by Dr. G. G. Zerffi, on Pre-Historic Art. It was illustrated by diagrams and drawings, and gave great satisfaction to a large and intelligent audience.

A LARGE MEDAL has been struck, by order of the Corporation of London, to commemorate the visit of the Sultan of Turkey to the Metropolis in 1867. The die is by Messrs. J. S. and A. B. Wyon, chief engravers of her Majesty's seals, and is an excellent specimen of this kind of Art. The obverse shows a fine portrait of the Sultan, modelled from a photograph taken "by command," by Abdullah Frères, of Constantinople, for this special purpose; round the portrait is the inscription, "ABDUL AZIZ OTHOMANORUM IMPERATOR LONDINUM INVISIT, MDCCCLXVII." On the reverse are figures representing the City of London clasping the right hand of Turkey, who is in the act of unveiling herself. In the background, between the two figures, is seen an altar, with the word "Welcome" upon it; in front of the altar appear the civic shield, with emblems of festivity and plenty. Behind the figure representing the City, is a seat from which she is supposed to have risen to welcome Turkey; St. Paul's fills up the background; while behind Turkey is a view of the Mosque of Sultan Achmet, at Constantinople. The number of medals struck—they are all of bronze—is 350; some have been presented to the Sultan, and to other distinguished personages who took part in the ceremonies connected with his Majesty's visit to London; the remainder being distributed among the members of the Corporation. It forms one of a series of medals commissioned at various times by the Corporation to commemorate public events of civic interest. We hear the Sultan has, through his representative here, sent Mr. Joseph S. Wyon, the elder of the two brothers, the Order of the Medjidie of the 4th class, in testimony of his approval of the work.

ART IN THE CITY.—The *City Press* announces that the paintings somewhat recently discovered on the old walls of Whit-

cross Street Prison, which are assumed to be by G. Morland, "have been wilfully damaged and defaced;" and regrets that no efforts were made by the authorities to preserve them. We share the regret of the writer if the pictures were worth looking after; but of this there seems to be no evidence.

MISS HELEN WILKIE, a niece of Sir David Wilkie, has published the work we announced some time ago—"The Rustic Album"—a series of lithographed designs to contain portrait-cartes. As the title intimates, the compositions are derived mainly from flowers and leaves, associated with other objects supplied by the woods and lanes, including birds and insects: they are rigidly true, yet highly poetic, and manifest thorough knowledge of Art. For the purpose intended, nothing so unequivocally excellent has yet been produced. The variety is a leading feature of the work. There are forty prints; but as many of them have spaces for three photographs, nearly a hundred cartes may be mounted in the very beautiful volume.

MONUMENT TO THE LATE GEORGE CATERMOLE.—Some months ago we announced that a subscription was in progress with the view to place a monument over the grave of George Cattermole in the cemetery at Norwood. The object has been attained, a sufficient sum having been collected.

A FRENCH ART-SCHOOL IN LONDON.—Some time ago we announced that the distinguished French artist, M. A. YVON, intended to establish in London a school for the instruction of students. The principle has long been "common" in Paris, but it is almost unknown in this country; yet immense results have arisen, and might naturally have been expected, from the practice. An accomplished mind presides, a practical hand guides, and long and large experience directs, the studies of those who seek to obtain knowledge of a sure and safe order under the direction and watchful care of a master. Among us, the student is generally entirely ignorant as to where he is to go for education in Art; he feels that he is "all wrong," and yet might be made "all right;" he finds books in abundance, but knows the utter weakness of theory without practice—practice efficiently controlled and directed. This want Mr. Yvon is about to supply; his school will be established ere long, and, we believe, with the very best prospects of ultimate success. He will not, however, commence active operations until he has a full list of pupils. Those who desire to join such a class may communicate with Mr. Yvon, at 96, Strand.

MR. J. SANT, R.A., has been appointed painter in ordinary to the Queen, in the place of the late Sir George Hayter. The excellent artist and accomplished gentleman will, of course, receive the honour of knighthood.

AT THE BAZAAR IN BAKER STREET, where works of various kinds are exhibited for sale for the benefit of "the Refuge Fund," may be seen a small collection of pictures by ancient and modern masters, which some of our English collectors would do well to visit. The paintings by old masters must speak for themselves—in some instances they do so forcibly; but those of modern masters are guaranteed. Among them are productions by Coignet, Corot, Grenet, Schelfoot, Baron, and François. Those who are not disposed to buy will have pleasure in examining the small but interesting and valuable collection; while those who desire to complete galleries by the addition of examples of masters not often or easily obtainable, will do

well to see the exhibition, and judge for themselves. At least, they may be assured that confidence will not be misplaced in communicating with the curator.

GOVERNESSES' BENEVOLENT ASYLUM.—Miss Sass having died at a good old age, between eighty and ninety, a vacancy occurred for an inmate of the excellent and honourable asylum. Miss Sass, the venerable sister of the artist who was much respected as an Art-leader some fifty years ago, was nominated to the asylum by Mrs. S. C. Hall. That lady enjoys the privilege of nominating a successor to Miss Sass, and she has given the appointment to a niece of the artist, John Varley.

MOSAIC WORK BY CONVICTS.—A very well-executed pavement in mosaic, of black and white marble, is now being laid down in part of the Loan Court at the South Kensington Museum. We are informed that the work is executed by convicts. The material costs almost nothing, as we are aware that, in London, sculptors actually pay to have their marble chips removed from their studios. The marble is cut into *tesse* of somewhat less than an inch square. These, arranged in a pattern of black rings interlacing on a white ground, are bedded on Portland cement, and form blocks of a foot or 14 inches square, and above 2 inches thick. These blocks are laid on concrete. The pavement is clean, durable, and handsome—so much so as to be far superior to its origin. The idea and execution are admirable.

PIN QUIVERS.—One excuse, and a good excuse, for an ornament is to render it useful. Have our fair readers—or even those of the ruder sex—ever felt at a loss for a pin? The faithful pincushion of our grandmothers is no longer worn in the pocket. Woe to the ill-advised youth who darts a lurking pin into the lining of his vest. Yet the fact remains that occasions do often occur—in the ride, in the walk, in the picnic—where the affirmative reply to the question, "Have you a pin about you?" would be delightful to more persons than one. Let no one in future be driven to answer "no." Little golden quivers, each large enough to hold three or four moderate-sized pins, are now fitted as trinkets for the watch chain. We have seen them at Mr. Bailey's, jeweller, Bedford Street, Covent Garden; and any of our readers who go there will hereafter thank us for the introduction to a very skilful, industrious, and conscientious working jeweller.

PICTURE-FRAMES IN FICTILE WOOD.—We have seen specimens of various patterns of frames for engravings, made by Mr. Hornsey, of 155, Bermondsey Street, which will be valued by collectors of such engravings or photographs as they desire to place on their walls. The frames are made of seasoned pine. Some of them are venerated with maple, some gilded in mat and burnished gold. But the specimen to which we call attention as a novelty that bids fair to become a favourite, is a frame covered with a thin coat of a hard composition, which is coloured and polished to resemble wood. A gilt moulding within, and one without, the frame, give lightness and elegance to the simple form. The work is clean, durable, and exceedingly cheap.

ARAB ART.—Under this title a series of very beautiful illustrations of Oriental Art is in course of issue. In the number we have seen is a fine specimen of *faïence murale*, or enamelled wall-tile, enriched with graceful blue, red, and green Arabesque *fac-simile* copies of pages of Arabic manuscript, adorned with linear patterns in blue, gold, red, white, and

grey; with white letters, in cursive Arabic, relieved on a rich pattern. There are drawings of the windows of the mosque called, in the spelling fashionable for the moment, QEYCOON, in which pierced-stone tracery does duty for glass. The pattern of a brown texture, adorned with beasts of a construction entirely superior to that of any terrestrial quadruped, also claims attention.

THE "CHURCHYARD WORKS," BURSLEM.—These historically interesting works—the pot-works of the father of Josiah Wedgwood, and where the "great Josiah" himself spent his earliest days—have, we are pleased to learn, after being closed for a long time, just been reopened by Messrs. Clarke and Wood, and they will be devoted to the decorative branches of the potter's Art. This is as it ought to be; for the works have capabilities for carrying on a first-class decorative trade both for home, continental, and American markets. It has been almost a reproach to the pottery district that these works have not always been kept in active operation.

THE LATE EXHIBITION AT SYDNEY was a great success, manifesting the vast resources of the country that may be even now styled "great," although yet in its infancy. The best of its contents in Art-manufacture, and, of course, in woollen utilities, we shall see in South Kensington. Several accomplished artisans have recently emigrated to the colony. Probably there will ere long be an importation of skilled workmen from France. The result cannot be otherwise than satisfactory.

MULREADY'S DRAWINGS.—A correspondent urges us to inquire what has become of a number of drawings—life studies—by Mulready, acquired by the Royal Academy; purchases out of its funds for the benefit of students. They must be somewhere: but the somewhere cannot be ascertained by those who would gladly avail themselves of such serviceable aids. It is, we have reason to believe, unknown even to the members.

THE INTERNATIONAL EXHIBITION AT VIENNA.—It is officially announced that a Great Exhibition of the works of Art and industry will take place at Vienna in the year 1873. The particulars are not yet published; but we may assume that the arrangements will be much as they have hitherto been. The capital of Austria has many advantages and some disadvantages, but no doubt the former will much outweigh the latter; and another grand display of the world's produce may be looked for—always presuming that peace, and not war, will then be paramount in Europe.

VALENTINES.—As usual, the Valentines of all sorts and sizes, and at all prices from a penny to a guinea, issued by MR. RIMMEL, are by far the best; indeed, he seems to have "the trade" all to himself; for other public caterers who make "a show" in shop-windows, seem to have as little notion of Art as they have of love-making in the moon. Mr. Rimmel's Valentines are all of "French fabric." Of a surety "they do these things better in France." No doubt they were designed, printed, and produced there many months ago, when light hearts gave birth to light fancies. Some of them have high merit as works of Art: into some are introduced real butterflies and birds—humming-birds; some are combined with musical boxes; all have floral adornments, graceful and beautiful, such as might supply models for flower-painters, grouped and arranged with exceeding elegance.

REVIEWS.

ART EDUCATION. By the Hon. MRS. RICHARD BOYLE. Published by MACMILLAN & Co.

WE are no advocates of "women's rights" according to the now common interpretation of the term. We do not care to see females step out of the path to which both nature and long-established custom have assigned them, in order to enter the arena of politics, whether parliamentary or parochial, or to don the professor's gown in schools of science and learning. They are, and have been for years, most valuable teachers in many branches of learning, but their lessons have chiefly been taught through the press, and from the quietude of their own homes. Yet are there seasons and places where woman's voice may be publicly heard without outraging the modesty of her sex, and where her teachings may have equal weight and effectiveness—sometimes more of both—than those of men. When Mrs. Boyle read the paper on Art Education, now appearing in a printed form, before the pupils of the Frome School of Art, on the last occasion of distributing the prizes, no one could justly say the lady was not in her right place on the platform; for Art is a subject which a female may legitimately advocate in public, if permitted so to discuss any question.

And the advantages of Art Education, with the benefits arising from Schools of Art, are here set forth perspicuously and gracefully. Glancing at the noble works of the old mediæval builders, when there was no straining after Art—which was then "not so much a particular faculty as the general result of vigorous and enthusiastic minds expressing themselves in that way; they knew not, and they cared not, if any before them had done the like; only they strained each nerve, and set their faces to the work until every obstacle was overcome"—the author alludes to the decline of Art, "which," she says, "began about the period of the Reformation; and the difficulties we must struggle with in feeling after its true spirit are partly, perhaps, the price to be paid for our enormous advance in Science." From that time till about twenty years ago the art of design retrograded rather than advanced, and then people began to find out "how exceedingly ugly most of their modern things were. . . . And so at last, our eyes being opened, we began to amend our ways, and Schools of Art were established one by one throughout the kingdom." With a general survey of the practical advantages and the pleasures arising from a knowledge of drawing and the power of applying that knowledge to useful or ornamental work, Mrs. Boyle brings her address to a close. "The happy gift of design," she says, "is, as I believe, the delight of an added sense." This lady, or we are mistaken, has beforetime made herself favourably known to us as the author of some illustrations, if not of the books themselves, published with the initials E.V.B. We are well-pleased to meet her in a new character—that of a public Art-teacher.

STONE-MONUMENTS, TUMULI, AND ORNAMENTS OF REMOTE AGES; with Remarks on the Early Architecture of Ireland and Scotland. By J. B. WARING. Published by JOHN B. DAY.

Mr. Waring, in this sumptuous volume, has sought to bring together and compare those remains of remote ages on which history or written record throws but a very poor and uncertain light, and to give at one glance, by the aid of a series of well-arranged plates, as clear, full, and correct a view as possible of contemporary remains of different peoples and countries; and so to seek "to spread a knowledge and excite an interest among general readers, in respect to a former state of civilisation, as yet but little understood or appreciated, although of the highest interest to us all, since it relates to the life and manners of our forefathers in times so remote as to be, in point of fact, pre-historic." These objects he has well and ably carried out, and his book, besides being devoted to the stone-monuments of

past ages, becomes itself a lasting and splendid monument of the author's skill and industry.

Of later years antiquarian writers have so divided and sub-divided ages and periods, that it is more impossible to comprehend their definitions and their divisions, than it is to understand, by comparison, the remains themselves; and we are glad to see that Mr. Waring openly, as others of our most industrious and clever archaeologists have recently done, declares that he places but "little reliance on any arbitrary division of stone, bronze, and iron ages." We, from our own researches, know that, as in Gothic architecture, there are "transition" periods between the different styles, so there are the same periods in the ages alluded to. We know that the stone-age preceded that of bronze, and that of bronze was the precursor of that of iron; but we know, at the same time, that the one gradually gave way to the other, and that bronze remains are found alike with those of stone and of iron. There is nothing defined, and nothing ever can define, the close of one of the ages and the advent of the next, for the one grew out of the other, was gradual in its spread, and was therefore simply a progressive process.

Commencing with the monuments of stone, Mr. Waring passes on from the Temple at Arcadi through those of Minorca, Sardinia, the Hebrides, Ireland, and Wales, to our own English counties, illustrating the British dwellings, subterranean galleries, &c., of Gullval, and other places, and so on to the remains in the Orkneys, the Shetland Isles, Kertch in the Crimea, Italy, Sicily, Denmark, Germany, Scandinavia, France, and, indeed, every country from which early examples can be gleaned; and he has arranged them with great skill, so that they may readily be compared one with another. This is especially the case with the series of stone circles, avenues, and cromlechs, &c., which he has most carefully illustrated.

Passing on from these and the sculptured stones, monoliths, perforated stones, &c., Mr. Waring next gives examples of ancient Irish building and of early Scotch masonry, showing a remarkable affinity between the round towers and the chapels or temples of the two countries, and comparing them with the round towers in England, Wales, &c. Weapons, personal ornaments, domestic and other implements, and a large number of other objects are next fully illustrated; the last plate of the series including the recent discoveries of Anglo-Saxon remains in Yorkshire. The plates, of which there are no fewer than 108 of large quarto size, are carefully and most clearly drawn, and the letter-press descriptions are sufficiently brief not to be tiresome, and are not overburdened with technicalities, which, in such a work, would be out of place.

It is by a careful comparison of remains, and by that comparison alone, that archaeologists are enabled to arrive at correct conclusions regarding the ages and the uses of such relics as may come before them; and Mr. Waring's book will, in this respect, be found eminently useful. It is an excellent text-book, and one which may be referred to with advantage both by the student in archaeology and by the most accomplished antiquary.

IONA. By the DUKE OF ARGYLL. Published by STRAHAN & Co.

This is a learned and yet a popular book; the author, who graces the highest position in the peerage, is also a man of letters, and perhaps is prouder of his pen than he is of his coronet. His Grace tells us all that he is, or probably, can ever be, known, of the most interesting island that borders the British dominions. Even archaeologists have made but slight acquaintance with its marvels, while mere tourists have given but a glance at its monuments, twelve centuries old, as they steamed on to more attractive Staffa—its not far-off neighbour. This is a small but singularly full book; full of description, legend, tradition; a wealth of fancy and a store of facts, written in a remarkably graceful style, simple and unadorned by artifice, yet so rich in fancy as to be at times poetry in prose.

The story of Columba (the founder of the monastery whose ruins constitute one, and only one, of the attractions of the little island) is so related as almost to bring before us the holy man and the time in which he "flourished." It is a grand and yet a beautiful portrait the author draws of the saint in his solitude, or battling against the evils of the world without; the pioneer of the holy faith which, by God's blessing, is now deeply rooted in our highly-favoured land.

No doubt his Grace will induce many to visit Iona. It is easily reached; a steamboat conveys tourists, daily we believe, from Oban to the Holy Island, and to Staffa; a day will be well spent even in a necessarily brief survey of two places, very opposite in character, yet both of surpassing interest. It is needless to say that pleasure will be largely enhanced by reading this delightful record of the one, and perusing the book of nature for all that can be known of the other.

The publisher has illustrated the volume by several excellent engravings—of the cathedral, the island from various points, and the more remarkable and best preserved of the ancient crosses. Not only the tourist, but the general reader, will seldom find 140 pages so full of interesting and instructive matter.

STRANGE DWELLINGS: being a Description of the Habitations of Animals. By the Rev. J. G. WOOD, M.A., &c. Published by LONGMANS.

This most deeply interesting volume is full of charming engravings; but they by no means constitute its principal attraction. The book is read with a feeling akin to that which is excited by a thrilling romance. Yet the stories are told with so much simplicity; facts are detailed in language at once so easy and so graceful; matured knowledge is rendered in a manner so very simple of comprehension; while philosophy is introduced, "not harsh and crabbed, as dull fools suppose," but as a winning and seductive friend—that the volume cannot fail to become a general favourite with the young—to be read also with delight by the old. The author has conferred many benefits on all ages and orders. As a naturalist, there may be others who know more than he does, but there is no one who manifests such thorough skill in conveying information.

AT THE BACK OF THE NORTH WIND. By GEORGE MACDONALD. Published by STRAHAN & CO.

Mr. Mac Donald holds a high position in British literature; his fictions are full of valuable matter; he is an eloquent and graceful writer, who makes a story very interesting, while strongly instructive; there is no one of his many books that may not occupy a prominent place in any library—public or private—for he is ever a healthy teacher, as well as an agreeable companion. Moreover, a lofty tone of religion pervades all he publishes; it is neither narrow nor sectarian, but is based on the broad principle of charity—acceptable to all, objected to by none; catholic in the true sense of the term. The world already owes him much, and is, we trust, destined to owe him much more.

This is a story for the young. We are by no means sure that Mr. Mac Donald writes as well for the young as he does for the matured; men very seldom do; but if there be a lack of simplicity and of power to enter thoroughly into the minds and hearts of children, there is entire sympathy and perfect love, which supply the places of other attributes that may be wanting in this able, eloquent, and rigidly right author.

The story is of a boy who makes a friend of "North Wind"—a friend who takes him much about, teaches him much, and makes much of him. It is full of instructive episodes, of lessons very useful to be learned, and of profit in the present and the future to be derived from trying to be, and succeeding in being, good.

If there be works that will more interest and excite boys and girls, there are none that may be read with better results; and if this will not add

to Mr. Mac Donald's fame, of a surety it will not detract from it.

The book is lavishly illustrated; the engravings are "peculiar," as the story is. Both may be somewhat "dry;" but the artist, as well as the author, may be tried by a high standard, and maintain unquestioned right to public approval.

ANCIENT IRISH ARCHITECTURE. Drawn and Published by ARTHUR HILL, B.E. Cork.

It is Mr. Hill's intention to produce a series of works under this one general title, and in it to illustrate some of the more remarkable existing remains of early architecture in Ireland. The two works of this series which are before us are devoted respectively to the church at Kilmalkedar, and that of Templemahoe, Ardfert. Of these two ruined churches, which are now fast falling to decay, Mr. Hill has given a brief history and description, just sufficient to render his admirable plates intelligible and useful. The plates, which are lithographic, and drawn by Mr. Hill from actual measurements and sketches made expressly for the work, consist of ground-plans, elevations, sections, and details of every kind, including the various plain and sculptured mouldings, arches, windows, and doorways, &c. To these are added a number of admirable photographic views, produced in a very high style of the Art by Mr. Hudson of Killarney. Mr. Hill is doing really good service to Ireland, and to architectural archaeology, by producing these works; and he, along with Mr. Close, who has recently issued, through the renowned firm of Marcus Ward & Co., of Belfast, a somewhat similar work on Holy Cross Abbey, deserves our thanks for putting on record these valuable views and details of buildings which are so rapidly passing away.

THE ANIMAL WORLD. Vol. I. Published by PARTRIDGE & CO.

This book is published under the auspices of the Society for the Protection of Animals: it is a collection of the twelve monthly parts that have been issued during the year 1870, and is intended as a report of the proceedings, and an advocate of the principles, of one of the most useful of all the societies of London that write over their doors of entrance—

"Supported by voluntary contributions."

The literary contributions are by popular authors, foremost among them being Mrs. Howitt and Mrs. S. C. Hall; the engravings are of great excellence, and altogether, perhaps, in the list of periodical publications, there is no one better worth the twopenny it costs monthly.

It will be an act of mercy to aid its circulation, to distribute it widely among those to whom the care of the lower world is mainly confided; indifference to the comforts of animals is far more general than cruelty to them, but it is quite as pernicious in its effects; and there are tens of thousands who seldom reflect that misery may result from want of thought. There are higher sentiments that should guide men and women in their treatment of "brutes," but even policy dictates that to use them well is sound wisdom.

The Society for the Prevention of Cruelty to Animals has, however, daily some case of absolute, unmitigated, and utterly inexcusable cruelty to report; and very often harrowing statements pass before the public through the police offices. This publication aims at the root of the evil, and will go far to destroy it. It does not advance to the combat with wrathful looks and weapons unsheathed, but seeks to convince by argument and convert by example; by essays, tales, poems, anecdotes, and beautiful prints, it strives to make way into the intelligence of its readers and render them humane as the result of sentiment, sympathy, and conviction.

No better work can be done, therefore, than to assist in extending the circulation of this useful, interesting, and, indeed, charming periodical.

The first annual volume is dedicated to Miss Burdett Coutts, a lady who is ever foremost in all good works that tend to benefit humanity; of whom it may be emphatically said, in reference

to the tens of thousands who are made happier and better by her influence: "When the ear heard me, it blessed me; and when the eye saw me, it gave witness to me."

DEBRET'S PEERAGE AND BARONETAGE, 1871. Published by DEAN & SON.

These ever-useful volumes are again welcome; they are necessities of daily life; as indispensable as a morning newspaper; for convenience, accuracy, ease of reference, and succinctness of information, they have never been surpassed; although volumes of a good size, and admirably printed and bound, they are issued at a price that brings them within the reach of all classes—to the tradesman behind his counter, as well as my lady in her boudoir, and the gentleman in his library.

ON THE EVE: a Tale translated from the Russian of IVAN S. TOURGUENEFF. Published by HODDER & STOUGHTON.

A very pleasant story is here given to the English reader. It describes society in the vast empire of which so little is known in England; we doubt, however, if it will prove most attractive to the young, for whom we assume it to be mainly intended.

SUNDAY ECHOES IN WEEK-DAY HOURS: a Tale Illustrative of the Journeyings of the Children of Israel. By MRS. CARY BROCK. Published by SEELEY, JACKSON, & CO.

This is a good book—emphatically so—but it is dull; the Israelites supplying by no means the larger portion of it. Certain boys and girls receive lessons from parents and guardians that they may do wisely and well to store up in their memories; but we fancy few of them will care to read, or to hear read, so many prosaic sermons at Christmas time.

TALES OF THE SARACENS. By BARBARA HUTTON. Published by HODDER & STOUGHTON.

Although the reading world has had enough—more than enough, perhaps—concerning the Saracens and the Crusades, this prettily "got-up" volume, admirably illustrated by Edward H. Corbould, will be welcome to many who are not "full of the subject." A well-told tale is interwoven with interesting historic facts, and conveys a large amount of information. The book may be read for amusement or instruction, or, rather, for both.

VALENTINE'S DAY, AND VALENTINES. By W. H. CREMER, JUN. Published at 210, Regent Street.

Mr. Cremer has published another pretty little book apropos to the season; he has done Christmas and Easter, and now does St. Valentine's Day—its history, that of the saint, and its various invocations to Love throughout nature. It is gracefully written, each page is adorned by a wood-cut, it is neatly "got up," and forms a pleasant little brochure for the young-folk who visit his inviting establishment. Although the main purpose of the publication is to let the world know that he is the world's vendor of "toys" for all ages, from the infant up to "out of teens," the author has given an agreeable and welcome guest to our homes, while they are guarded within and without by "February-fill dyke."

RECORDS OF 1870. By EDWARD WEST. Published by E. WEST, Bull and Mouth Street.

This is the tenth year of this little publication; it deals—in a page of poetry to each—with some fifty of the leading events of the past year. The poems are graceful and good—good as compositions, and very good in sentiment and feeling. 1870 has presented more themes for gloom than gladness—the war absorbing all other topics. The subject is dealt with in a spirit of generous and sympathising humanity; in some cases the lines are touching, in others grand, and always rising above mediocrity.

THE ART-JOURNAL.



LONDON: APRIL 1, 1871.

BRITISH ARTISTS:
THEIR STYLE AND CHARACTER.
WITH ENGRAVED ILLUSTRATIONS.

No. XCVIII.—JAMES ARCHER, R.S.A.

BORN in Edinburgh, in 1824, Mr. Archer, like many other Scottish painters, owes his early education in Art to the School of the Board of Trustees for Manufactures in Scotland, originally established so far back as 1727, towards "encouraging and promoting the fisheries, and such other manufactures and improvements in Scotland as may most conduce to the general good of the United Kingdom." The funds set apart for this purpose, £2,000 a year, were placed under the management of the Board, but subject to the control of the Lords of the Treasury. "In carrying out the purposes of this Act," says Sir George Harvey, President of the Royal Scottish Academy, in his recently-published volume on the early history of the Academy, "the Trustees, originally twenty-one in number, offered premiums for the best designs or drawings of

patterns for the improvement of manufactures; and in the year 1760 a master was permanently appointed to instruct the youth of both sexes in drawing; thus laying the foundation of the School of Design, which has now existed and prospered under the management of the Board for more than a century."

This School, as already intimated, has done good service to Art, and, in its present advanced condition, may be considered in some degree analogous to the School of our Royal Academy, though that of the Royal Scottish Academy would, perhaps, bear fitter comparison. The Trustees' Institution has long been under the direction of some of the most able artists of the northern capital, and when Mr. Archer was a student, the late Sir W. Allan, P.R.S.A., was master there. During the first ten years of his artistic life he limited his practice to drawing portraits in chalk, for which he had so great demand that but little time was left for anything else: his first drawing of this kind was a portrait of a grandchild of the celebrated Lord Jeffrey. Of his oil-pictures exhibited in the Scottish Academy of which institution he was elected Associate in 1853, and Academician in 1858—we have but little record; but a picture, 'The Last Supper,' exhibited by him in 1849, shows that he began early to attempt subjects of a high order; and this not unsuccessfully, as may be gathered from a remark made in our Journal at the time,—“freely grouped, solemnly fine in expression, and most creditable as an entire work.” In 1852 we find him exhibiting in Edinburgh numerous works of a very diversified character—history, portraiture, *genre*, and landscape; as if he had scarcely yet decided in his own mind which class should have undivided attention for the future.

In 1854 Mr. Archer first appeared as an exhibitor at the Royal Academy, by sending two portraits in chalk; one, of the Countess of Kintore, the other, that of Miss Hope-Johnstone: also a cartoon of 'The Last Supper,' from which he painted, and exhibited in the year following, an oil-picture: both the cartoon and the painting were favourably noticed in our columns. 'Musing' and 'Amused' are the titles of his two works exhibited at the Academy in 1856. The picture 'IN TIME OF WAR,' one of our engraved illustrations, does not support the title given to it when it hung in the Academy in 1857: the scene itself is eminently peaceful; but we may assume that the letter brought by the elderly lady, and which she seems most unwilling to intrude on the younger, probably



Drawn by W. J. Allen.]

FAIR HELEN OF KIRCONNEL.

[Engraved by Butterworth and Heath.

a married daughter, contains some painful intelligence arising out of war. It is a most carefully painted domestic scene, in praise of which much might be said; and was a commission from a gentleman in London, now deceased. A stanza from Tennyson's "Lord of Burleigh" supplied Mr. Archer with the subject of the only pic-

ture exhibited by him in the year 1858; it bore the title of 'A Hidden Sorrow,' and shows only a single figure, that of a lady, whose countenance indicates a troubled mind.

We come now to a class of subject from which, perhaps, have been plucked the brightest laurels with which this artist is deco-

rated—the semi-historic romances and ballads of olden time. The first of these, 'Fair Rosamond and Queen Eleanor,' appeared at the Academy in 1859,—a clever picture, representing the beautiful Rosamond kneeling before the injured and inexorable queen in supplication for her life. The next year he sent to the same gallery 'Lady Jane Beaufort,' wife of James I., the "poet-king" of Scotland; the picture was suggested by a poem of the monarch's entitled "The King's Quhair :—" James and the lady are here seen in the garden of Windsor Castle. The picture is in the collection of

Mr. J. Wylie, Hunsdon House, Hertfordshire. 'Playing at a Queen with a Painter's Wardrobe,' exhibited at the Academy in 1861, is an amusing and skilful appropriation of an artist's studio-properties by a little girl who has arrayed herself in royal habiliments: the work is the property of the Earl of Stair. With it Mr. Archer sent the first of a series of four paintings illustrating "The Historie of King Arthur :—" it bore the title 'La Mort d'Arthur,' and shows the dead monarch taken away in a barge, attended by three queens, and Nimue, "the chief lady of the lake." The second,



Drawn by W. J. Allen.]

IN TIME OF WAR.

[Engraved by Butterworth and Heath.

'HOW KING ARTHUR OBTAINS THE MYSTIC SWORD EXCALIBUR,' was exhibited the year following, and is engraved on the next page. The composition may be best described in the extract from the history which suggested it :—"So they rode til they came to a lake, which was a faire water and a broade, and in the middes of the lake King Arthur was ware of an arme clothed in white samite, that held a faire sword in the hand. . . . 'What damosell is that?' said the King. 'That is the lady of the lake,' said Merlin. . . . 'Well,' said the damosell, 'goe ye into yonder barge, and rowe

yourselfe unto the sword, and take it and the scabbard with you, and I will aske my gift when I see my time.'" Our readers may judge, from the engraving, of the excellence of this picture.

In 1862 Mr. Archer left Edinburgh, and took up his residence permanently in London, sending to the Academy Exhibition of 1863 the third of the series of the "King Arthur" pictures, 'The Sancgreall, King Arthur relieved of his grievous Wound in the Island-valley of Avalon,' by the application of the contents of a "holy vessell borne by a maiden, and therein is a part of the holy blood

of our Lord." In the old romance, it is the *vision* of the Sanguine that heals. The two last-mentioned pictures are also the property of Mr. Wyllie.

A humorous, yet well-studied and very carefully-executed picture, 'How the Little Lady stood to Velasquez,' was contributed to the Academy in 1864: "those who have studied the marvellous portraits by Velasquez," was our note of this work at the time, "will know how duly to appreciate this transcript in brief, not to say this parody on the great originals." With it appeared 'Sir Launcelot and Queen Guinevere,' a subject also taken from the history of King Arthur, but not intended as one of the series to which reference has been made. Three pictures were sent by this painter in the year following:—'My Great-Grandmother,' 'Old Maid Maggie, you're Cheating,' and 'The Puritan Suitor:' of the three, the second on the list most engaged our attention; it is capital in subject, and expressive in character. Two quite young

girls are seated at a table playing the game of "old maid" with cards: one of them, finding that fortune forebodes defeat, charges her companion with dishonesty. The incident is admirably told, while all the technical qualities of the work are excellent. In 1865 he exhibited three pictures, concerning two of which we will simply quote our critic's remarks as the best testimony to their merit. "Mr. John Archer is another of our young artists who is making sure progress. His picture of last year, 'You're Cheating, Maggie,' placed him in a foremost position among our rising men; its sequel in the present exhibition, 'Hearts are Trumps,' is of the same solid and sterling quality. The subject is the game of whist, with dummy. Three ladies, meditating mutual cheating, are seated at a table, cards in hand. The ladies are acquaintances we formed in Mr. Archer's previous picture; the motive also in the two works is similar. We think, however, the present picture has been carried out, especially in the accessories, more thoroughly. . . Mr. Archer's



Drawn by W. J. Allen.]

KING ARTHUR OBTAINS THE MYSTIC SWORD EXCALIBUR.

[Engraved by F. Kempton.

second work, 'Buying an Indulgence for Sins committed and to be committed,' is, as the title suggests, of the nature of a satire, properly possessing little beauty and much grotesque character."

The whole of the three pictures exhibited by Mr. Archer in 1867 merit special detailed notice, had we space to devote to them. One, however, must be singled out, 'The Time of Charles I.,'—portraits of the children of Mr. W. Walkinshaw, of Hartley Grange, Hants,—because we believe the artist to be the first who adopted the idea of portraying children *in costume*; his previous example was 'How the Little Lady sat to Velasquez.' A charming composition, with all its old-fashioned accessories, is the group of young children, which would do no discredit to the period of the renowned Spanish master. The other pictures of the year were 'An Introduction,' and 'Henry II. and Fair Rosamond,' each good in its way: the last was sold to Mr. Shand, Advocate, Edinburgh.

In 1868 appeared the fourth of the series of the "King Arthur" pictures, 'The Funeral of Queen Guinevere,' showing Sir Launcelot and "his eight fellows of the Round Table" escorting the

body of the queen to her tomb in Glastonbury. The picture was bought by the Council of the Art-Union of Edinburgh, as one of the prizes to be distributed. A novelty from the easel of this painter is a little work, one of much excellence, entitled 'Bringing Home Fern—Evening:' a group of rustic figures in a landscape.

'Against Cromwell: a Royalist Family Playing at Soldiers,' was exhibited, in 1869, with 'FAIR ELLEN OF KIRCONNEL:' the latter founded upon a tragic incident of olden time, that happened in Dumfriesshire, in which a daughter of the Laird of Kirconnel was accidentally shot by a rival suitor as she rushed forward to shield her lover from the bullet of the assassin. We have no room for comment on these well-sustained pictures; nor on Mr. Archer's 'Sir Patrick Spens,' the only work exhibited by him last year.

We remember seeing in the International Exhibition of 1862, an admirable work by Mr. Archer, called 'Summer-time, Gloucestershire,' which we had not noticed at any preceding exhibition. 'Buying an Indulgence' was in the Paris Exhibition of 1867.

JAMES DAFFORNE.

SELECTED PICTURES.

DAVID BROUGHT BEFORE SAUL.

Louisa Starr, Painter. S. S. Smith, Engraver.

At the annual distribution of prizes, in December, 1867, to the students of the Royal Academy, the first name which appeared on the list was that of a lady, Miss Louisa Starr, who received a gold medal for the "best historical painting;" the work thus honoured being that here engraved, "David brought before Saul." As it is only within a comparatively short period that ladies have been admitted into the Schools of the Academy, it is most creditable to Miss Starr that she should have carried off the highest prize from all, her male competitors; and it also shows the Academy had acted wisely in at length allowing females to participate in the privileges of its schools. But why should the Academy limit its grace or favour to the preparation of a class of students for the practice of Art? exciting their emulation in the arena of competition by awarding them prizes, and then putting a bar against the reception of future honours should they be found worthy of wearing them. Why, in short, should not ladies be eligible for election into the corporate body of the institution? It would form no novelty in the annals of its constitution; in fact, such admissions would only be reverting to the earliest position of the Academy, when Angelica Kauffman and Mary Moser ranked among its "Members." So long as these are limited to the number of forty, it would, perhaps, be too much to expect to see three or four ladies included in it, and even among the twenty Associates; but with a wider, and—in the best interests of Art—a more liberal and comprehensive scheme of distributing academical degrees, such concessions would be both graceful and politic. In literature, in the sciences, and in many other intellectual acquirements, women are making their influence and abilities felt in the social world; then why as artists should they find the doors that are open to others closed against themselves? We are not arguing this point with reference to Miss Starr, who is yet a comparative novice, and can wait for whatever the future may decide in her favour; but there are lady-artists of long standing who would shed no fictitious lustre on the roll of the Academy.

Miss Starr's picture, 'David brought before Saul,' was exhibited at the Academy the year after it received the honour awarded to it. The subject is taken from the scriptural passage in the history of the future King of Israel, where it is written,— "And as David returned from the slaughter of the Philistine, Abner took him, and brought him before Saul, with the head of the Philistine in his hand." The composition is simple, and the artist acted wisely in not loading it with numerous figures and accessories, as under the circumstances she might well have been tempted to do. The young victor, kneeling modestly, lays his prize at the feet of the monarch, who regards him with a strange, half-incredulous look, as if he could not realise the fact that such a stripling could have overthrown the terror of the Hebrew hosts. The figure of Saul is very striking; dignified, yet easy in pose. Behind his chair is Jonathan, who already seems to feel that yearning towards David which afterwards grew into a friendship that has become a proverb. The picture is not without evidence of the work of a "young hand," but its merits richly deserve the honour it received.

A GENUINE ARTISTIC RACE.

PART II.

LET us now turn to examples of Japanese pantheistic humour. Among the most curious we find the "Guardians of Heaven," possessing the anatomy of wrestlers, with wild gestures, looks of fearful import, and having circlets of tongue-shaped flames about their heads. These beings in their general aspect are not unlike the Etruscan door-keepers of hell, with more propriety called "furies." Indeed, the popular supernatural imagery of Japan is quaintly terrible, and absurdly materialistic. Besides their vulgar superstitions, the common people have a propensity for what is coarsely ridiculous. Their fancies are singularly fecund in naïve humour of this sort, even as respects their gods. In the personifications, however, of Houni-Toko-Tatsi, their supreme deity, as a kindly contemplative old man wearing a broad-brim hat and a heavy cloak, their idea, except in the costume, does not vary materially from the Christian one of the "Father" in heaven. But the Japanese have invented scores of minor deities, each charged with some special function, as is every Roman saint. Instead, however, of being superior in form and spirit to men, they seem inferior, often ludicrously and grotesquely frightful; but devoid of malice, although possessing a greater capacity of mischief and tickleness. The artists of Japan reverse the poetical machinery of pagan Greece. In place of effigies of high beauty and intelligence they feed the imagination with the impish, ugly, jocular, bizarre, and extravagant. As an instance in point, is the figure of Raïden, the demon of thunder. We associate this phenomenon with the anger of a powerful and majestic being, all omnipotent. But Raïden is a fantastic hairy imp, more bestial than human in type, with knotted joints and contorted limbs, who leaps about "like mad" in the centre of a dark cloud, banging away with heavy sticks at a wheel-like circle of flat drums, which he swings around his head; a pitifully droll figure in itself, but not unsuggestive of the rattle of the electrical fluid.

The god of wind, Fûten, is a more serious, but equally ugly, conception, half-enveloped in an immense bag swollen with imprisoned tempests, which he carries on his back, holding the two ends in his hands ready to unloose their destructive forces on the earth whenever the caprice seizes on him. As the patron of arms, the Mars of Japan, there is a hybrid monster, partly man above, animal beneath, or neither, just as the imagination can take hold of the strange medley of functions. The face of the bestial position resembles one of those hideous *rococo* knockers common to palace doors when the devil was all-rampant in social life, while the more human part has enough heads, arms, and weapons attached to its nondescript form to furnish an entire army. As a symbol of the anarchy, cruelty, and wholesale slaughter which make up an Oriental's notion of warfare, it is quite pertinent; more so than the patron saint of horsemanship, who careers through the clouds on a coal-black steed with fiery eyes, brandishing two swords over his head like an *aureola* of flame, scowling the while so fiercely as to make the world aghast as his supernumerary limbs are actively engaged in what seem to be acrobatic tricks. It is a relief to turn to Yebis, the provider of daily food, a jovial marine-demon, with a gigantic crawfish for his head-gear, sea-weed for waist-drapery, and spindle legs that end in wave-like claws. There is a droll mixture of knavery and benevolence in his lumpy countenance, as he holds out his gifts, or skips about on the back of a fiendish dolphin, performing a sort of sailor-like fandango. There are more artistic effigies of Yebis in bronze, but of the same general character, which is, evidently, the fisherman's type of a jolly good-fellow, for a protecting deity.

Daikokou, god of riches, an immensely obese man, seated on bales of merchandise, holding a miner's hammer in one hand, in his ample costume looks like a caricature of a daimio. His opposite, Hotei, the incarnation of contentment in poverty, is a yawning, big-bellied, sturdy vagabond, scantily clad; exactly the

fellow to invite the attentions of a village-constable in New-England, as having no ostensible means of livelihood. Both are great favourites, though how much is depicted in serious and how much in a satiric view, we cannot decide. There is an unmistakable touch of the latter in all these figures, and but little that bespeaks profound veneration or devotion. The god of longevity, Shiou-Ko, decorously clad in flowing robes, of a good figure for so old a man, has a smiling countenance, topped by a *cranium* that rises prodigiously above his eye-brows,—an abnormal mass caused by constantly reflecting on ways of promoting the welfare of men,—so well managed as to appear almost becoming. Japanese heroes in their outward guise fare no better than the gods. The founder of the line of the Mikados, Zimmou, who reigned 660 years B.C., is clothed in rich mail, which, by itself, makes him look extremely warrior-like; but a fan in his hand, head-dress of deer-horns and peacock feathers, false eyebrows, and a superb gaudiness of drapery, cause him also to appear like a masquerading reveller rather than the venerated ancestor of the oldest family of sovereigns on earth.

The quaintest specimens of humour, designed with an artistic keenness which makes their queer attitudes and performances seem natural, are those impossible beings, so common in their sketch-books, with legs or arms extending five or more times the length of their bodies, and yet who preserve the dignity and almost the grace of normal humanity, while doing things as unaccountable as their laughable proportions. Sometimes their heads, connected with their trunks only by a sort of umbilical string, fly off in the opposite way to which their bodies are running, gyrating a moment in the air, and finally, upside down, find themselves staring with a sardonic grin into the faces of frightened folks, who lose their wits on seeing these trunkless inverted heads, with bodies blundering about in another direction. Perhaps the most wonderful of these inventions is that double-bodied and headed individual, who, although so copiously provided with brains and viscera, has but one pair of arms and legs to wait on them; a no less strange freak of Art than is the living negro girl of America with her four arms and legs, two heads and only one body. As a drawing it is extremely well done. The countenances are really noble, with somewhat of a dandyish cut of hair and whiskers. Each head, as with the negro girl, maintains a will and character of its own, but the hands and feet are used in common, apparently gesticulating and marching in unison to one impulse. They or it, as you please, without a rag of clothing, are promenading on the sea-shore, in the society of other extraordinary creatures, including some of the long-armed or long-legged gentry, which attributes, however, never are found together on the same individual. They have ugly features, and crouch on the sands. One projects his ungainly arm a rod before him to grasp a scroll which has just been brought from the "south-east kingdom" by one of its "feathered people," who descends with rapid sweep of wing head downmost. The legend states that this people "have checks lengthened out like those of birds; their beaks are red; their eyes white. Wings grow upon them, and they can fly a short distance; they resemble birds, but are not hatched from eggs." All these features are strictly observed by the artist. He has constructed something which is neither all man nor all bird, but has the qualities of each accurately blended, as are those of man and animal in the centaur. Feathers and wings run almost imperceptibly into clothing. On one view the face seems to be entirely a bird's beak and skull; on another, it looks like a human *cranium* with a low forehead and sharp nose. In another plate two of these beings are represented fighting as cocks fight, their feathers torn and flying about, and their faces animated by human intensity of passion and capacity of stratagem. The bloated demon of gambling, with cuttle-fish eyes, and ensnaring flexible feelers quivering over them, delightedly watches the struggle. Often in lieu of a beak they display a slim nose several feet long, which they turn to practical use by placing the end on a comrade's shoulder





and hanging bundles to it, partly supported in one hand to ease the weight and prevent oscillation. These long-noses are great jugglers. They write, paint, toss and catch rings, and do all sorts of tricks, with this well-trained member. Indeed, impossible acts and growth of limbs are so cleverly managed as to appear feasible and natural. We come to look on them as no more outside of nature than a fresh turn to the wheel of fashion bringing up the monstrosity of yesterday as the beauty of to-day. In this naturalness of their unnatural in Art lies one of their specific triumphs. We may forgive ourselves for believing in the existence of the Japanese mermaid, for their strangest vagaries really look like studies after life. Specimens of monsters in whom each member and function is antagonistic to its neighbour, so plausibly constructed as to make the whole appear vitally sound and well adapted to its own ends in life, could be generated only in imaginations steeped in a belief in their existence somewhere. The *rococo* grotesques of Europe are wanting in this principle. Besides being stupidly ugly and imbecile in motive, they are far less original in thought, and have no organic life, truth of instinct, or reason of being. Not even a Raffaele or Razzi could impart to their bizarre fancies the constitutional verity of existence which animates the Japanese designs; still less bestow on them a corresponding dignity and purpose of characterisation. Theirs are out and out artistic lies, unworthy of their powers of invention, and with the latter painter frequently indecent. The common run of artists dwarfed, distorted, or befouled nature with no adequate result in way of decorative design, not even of pleasurable surprises or grim humour. For proof, examine the frescoed ceilings of the corridors of the Florence gallery, which embody the best and worst of this species of ornamentation. But the Japanese artists amuse by the quaintness and freshness of their ideas; edify by the profound comprehension of their motives and materials; and excite our senses by forcible suggestions of the unseen things in the universe. Spiritual in the Christian sense, never; but always entertaining. Nevertheless, in some of their compositions there is to be seen a physical grasp and grandeur that borders on the sublimely terrible. Witness the spectre evoked by a magician out of his inkstand, issuing as a vapour, and slowly taking the shape of a huge dragon, with claws that can clutch mountains, and a spine whose crackle, as it uncoils, reverberates like the roll of thunder. Its noxious breath darkens the air, and condenses it into a mass of gloom, in which glisten two round fiery eyes, like phosphoric balls. Does not this spectre woefully signify the poisonous effects of a vitiating literature on any land?

But it can scarcely be claimed for the Japanese artists, however powerful in some of their conceptions, that they attain complete sublimity of style. This is due to no failure in executive skill, but to a subtle impulse which almost always stops them short of the highest language of Art, and incites them either abruptly or insidiously to introduce irony, coarse humour, or malicious common-sense, which seem to be national traits. These are a counterpoise to low superstition, but also a check to the finer idealisms. A spiritual faith with its concomitant feeling of beauty are overlaid by the grosser habits of mind. Even that magnificent image of physical terror, the dragon of hurricanes, is shown, not so much as destroying men, as subjecting them to ludicrous catastrophes; and the god of thunder is to be seen frantically struggling on the ground, thrown out of his cloud-home by the recoil of his own lightnings.

The passion for caricature, mainly jocose, quite overcomes the sentiment of veneration towards the deities that preside over domestic affairs. These are treated as of the artist's own flesh; jolly, fine fellows, made at home in their families, to bring them good luck and drive off evil spirits, in whose active intermeddling in their households all good Japanese devoutly believe. There is little evidence of the positive idolatry in their Art which obtains where image-worship is made a serious rite; and the common mind is less discriminating between the purely spiritual gods and the fickle creations of its own

fancies, on a level with its own nature, with the direct mission of administering to physical wants. The primitive worship of Japan, known as Kami, an example of the better side of its religious instincts, is held in rustic chapels, constructed in beautiful groves, where the eye reposes on picturesque views. In the centre of these small temples there is suspended a highly-polished metal mirror, as an emblem of the unseen, all-seeing god, who, reading the thoughts of men, reflects them back by this simple means to their own view. It behoves, therefore, no one to approach this mirror except with a pure soul. In the degree it reflects the worshipper's peace of mind, it measures his progress towards holiness. Pieces of white paper are hung about the walls as tokens of the cleanness of mind and body required of the followers of the Kami before entering the sanctuary. There is nothing else to distract attention from the mute lesson of the mirror. To those who can appreciate its symbolism it appeals with a directness that makes the worship of Kami a miracle of abstract simplicity and spiritual efficacy. By no other of man's forms of worship, unless it be the silence imposed on the followers of Fox until the spirit moves the tongue to speak, does the human soul appeal more directly face to face to the great soul of the universe without intervention of priestcraft or idols. A people which could thus conceive a religion must have an innate consciousness of the Supreme that no Art could effectively portray, and which as effectually bars any attempt to image the divine essence as any law of Mahommed or Moses. At the same time their humorous, æsthetic temperament, joined to their familiar associations with the special attributes of a divine Providence, as delegated to inferior beings not dissimilar to themselves, although not the loftiest inspiration to Art, is nevertheless a prolific incentive, and aids the common mind in preserving its almost juvenile elasticity and contentment.

How can a poor man murmur at his lot in the face of his tutelary Yebis? the merry kind-hearted fisherman, no more rich in worldly goods than himself, always cheerful and ready to do a neighbourly act! Does not the philosophic laughing Hotei live like the meanest peasant; his sole possessions being a fan, knife, and a big leather wallet to hold the frugal gleanings which form his meagre diet? This last article serves also for a mattress, or a float on which to cross a river; often as a mat for the urchins to play on, attracted by his pleasant stories or the pranks which he encourages on himself. He tells them the best things in nature are free to all who know how to enjoy them, and warns the little fellows against vice and luxury. Benten, too, the beautiful lady, the inventor of music, whose grand appellation is Ben-Zaiten-njo, has she not had fifteen sons, all stalwart honest fellows of different professions, and is she not the model-mother of Japan, as well as queen of delights, and the pattern housekeeper and mistress of all the prosaic virtues? I wronged the excellent woman in likening her to the Grecian Venus, for she is a superior type of womanhood: a practical domestic guide to the family in one aspect; in another, a mystical incarnation of the supremest functions of nature and humanity; the veritable god-mother of Japan, about whose head burn three divine flames encircling three lovely pearls, and whose eight hands are all busy in promoting human welfare.

Neither should we overlook the kindly grave old gentleman, in the dress of a learned doctor, Topi-Toku, god of talents, with his organ of benevolence grown so large in meditating how to instruct and amuse the young folk; in usefulness worth a dozen of the niggardly St. Nicholas, who limits his gifts to once a year. Wise and friendly deities all, dearly loved, yet treated with a jocose intimacy which would try any human friendship. They are adepts at games, love to bet, and condescend to private theatricals to amuse their earthly clients. If in a gay mood, Benten sings, and accompanies herself on a lute, like any roving troubadour. When industry moves her, she sets as benevolent an example of making up garments for the poor as any member of a Christian sewing circle. In fine, there is

nothing a Japanese may conscientiously do to amuse or benefit himself which is not likewise done by their social deities, whose morals appear to be much above the standard of Olympus, even if their manners have less style. They are democratic, not aristocratic, gods, of the people's own breeding; rich in homely virtues, and not without many of the accomplishments of their betters of Greece. All this domestic mythology is very pagan; but where can we find in other religious personifications any of a less reprehensible character? In some respects it is a pictorial expression of some of the moral precepts of the Sermon on the Mount; the "bread of life" put into the vernacular language of a multitude still in the childhood of their intellectual development.*

JACKSON JARVES.

OBITUARY.

JOHN FREDERICK ECKERSBERG.

[THIS notice has been forwarded to us from a correspondent at Christiania, a countryman and intimate acquaintance of the deceased painter.]

John Frederick Eckersberg was born at Drammen, on the 16th of June, 1822. There was nothing in his early boyhood that gave promise of the rare artistic talent of which he afterwards proved himself possessed, nor had he an opportunity of seeing works of Art of any description in his native place. He was a clever boy, who could turn his hand to many things, and to more purpose than boys in general; for instance, he had a taste for gardening; and would amuse himself with household chemistry, such as distilling perfumes, &c. He received the school-education usual for those who were not intended for the learned professions, and having completed this, his father, who was a merchant, and wished him brought up to mercantile pursuits, allowed him, as a recreation, to accompany a near relative to Holland. Here young Eckersberg begged to be allowed to remain some time. With the sanction of his father, his relative placed him with a private tutor in the small town of Edam, in order to learn the Dutch language, which might be useful to him hereafter, as a considerable trade was then carried on between his native place and Holland.

Although Edam could not boast of much more in the way of artistic painting than Drammen, it certainly was here that his eye was first opened to the light of Art. The writer of this notice distinctly recollects the admiration with which the youth viewed the glass-paintings on one of the churches—the only, but in that branch very good, works of Art Edam possessed—on an evening when they were illumined by the setting sun; and the joyful enthusiasm with which he expressed himself about the beautiful effects of the variegated light. As even trifling circumstances or traits in the early life of men who afterwards raise themselves to a prominent position are of interest, I will mention as a proof how open his mind was, though unconscious of it at the time, to receive and store every new impression even to the minutest details: being one day with him on the downs near Scheveningen to look at the sea and the coast in a heavy storm, the scene had taken such hold of his mind, that ten years after, when conversation happened to turn upon marine-painting and our excursion to the downs, he at once

* To be continued.

roughly sketched off in water-colours a view of the sea, with the different vessels in sight, that could not in point of accuracy have been more faithfully portrayed if taken on the spot.

Having been introduced to some of the principal families at Edam, a member of one of them took him to Amsterdam for a few days. He was shown the sights. Much as there was of interest in the large city to astonish the boy, who had only seen such places as Drammen and Edam, it was the treasures of Art in the National Gallery—at that time even richer than now, before the pictures by the masters of the Dutch school had been removed to the Hague—that riveted his attention, and inspired him with feelings unknown till then, opening up to his mind a world new and beautiful. Here was the turning-point in Eckenberg's life; for even if the thought, "I will be as one of these," did not momentarily flash upon him, the impressions he then received grew stronger day by day, and the thought and wish to try to do something crowded irresistibly upon him.

He began alone, in his solitary room, with no one to teach, no one to guide him. But faltering as his first attempts necessarily were, they were not without marks of talent; for a skilful drawing-master and painter in water-colours, who lived at Edam, accidentally seeing some of them, found so much of promise, that he offered him his assistance. This proposal, if nothing else came of it, certainly strengthened the dawning consciousness of his artistic call.

At eighteen years of age he returned to Norway, and was placed in a mercantile house in Christiania. With the turn his mind now had taken, it was not to be expected that he should find himself content in this position. He continued to draw in his leisure hours, and the holidays he entirely devoted to his love for the Art. His progress, however, could only be slow, teaching himself without aid as he did, being too modest and bashful to seek assistance. During two years spent in this way, his secret wish ripened to a determined purpose, and he at last told his father of his intention to change the desk for the easel. But the stern man of business would not listen to such a nonsensical whim, as he called it, and gave him a severe reprimand for his want of attention to business.

Eckersberg, however, having now decided upon his course, did not allow the parental authority to alter his determination; and he boldly set out upon his self-chosen path, without either encouragement or pecuniary assistance from home. It is without a doubt, that this circumstance, and his being at the early age of scarcely twenty thrown on his own resources, called forth and strengthened that energy and that earnest purpose which were ever characteristic traits throughout his after-life.

He now procured himself an introduction to the technical drawing-school, and met with both encouragement and assistance from the artists then in Christiania. His talent rapidly developed itself during the next few years, and as he worked on to improve himself, he gained his living by copying oil-pictures, painting portraits, and small original sketches. In 1846, having obtained one of the Government stipends for young artists, he went to Düsseldorf, and there entered the Academy in the class for landscape-painting, under Professor Schirmer, and made such good use of his time, both in this class and also in the one devoted to drawing from living models, that

Schirmer being highly satisfied with him, he next year got one of the separate studios for more advanced pupils. After having continued some time longer at the Academy, he took a private studio in Düsseldorf. He now began to find a sale for his pictures, and would probably, following the example of most of the Norwegian artists, have remained at Düsseldorf, if the political disturbance, consequent upon the French Revolution in 1848, had not driven all the foreign artists away from Germany.

Eckersberg returned to Christiania, and as he had a tolerably profitable sale for his works, he soon found himself in a fair way towards an independent position; trusting to this he hastened to fulfil a youthful engagement of some standing, and married in 1850 the lady who now survives him. To every appearance a quiet, contented life after his many struggles now lay before him; but he was not destined long to enjoy these promising prospects: sickness began to visit his home, and soon he was himself attacked by a dangerous disease in the respiratory organs, which threatened such rapid increase, that the physicians, as a last and only remedy, recommended a sojourn in Madeira. Difficult as this project was for him with his very small means, he undertook the voyage with surprising confidence, and arrived at Madeira in 1852, sick, accompanied by his wife, and yet with nothing to depend upon but himself and his pencil. The first few months he was even too ill to work, and when the effect of the beautiful climate began to mitigate his illness, he was at first obliged to turn to portrait-painting, as the readiest means of converting his Art into the great requisite at such an expensive place—money.

This also answered very well, for he received many sitters, and it introduced him to numerous acquaintances, among the temporary residents at Funchal, especially the English. By degrees he regained his health and strength, and could employ his time to advantage for his speciality of Art; so he set about travelling over the island, taking sketches of many of its picturesque and magnificent scenes, from some of which he afterwards finished his well-known series of pictures of Madeira. After an absence of two years he returned to Christiania in 1854, and removed the same year to Düsseldorf, with the intention of taking up his permanent residence there. But the climate did not suit him; symptoms of his old complaint began to show themselves in such alarming degree during the first winter, that with the spring the physicians urged him to hasten his removal. He returned home, and by judicious treatment and the greatest care he recovered, although the disease itself could not be considered eradicated.

As he now saw it was possible both to paint at home and get his pictures sold, he determined to remain, and from that time he lived in Christiania, only making two journeys abroad to see different exhibitions.

The principal reason why all the young Norwegian artists used to go to Copenhagen, Düsseldorf, or other places abroad, renowned for their academies of painting, was the total want of such an institution in their own country; and, very naturally, the thirst for higher artistic instruction, that vainly had been felt by many a budding talent, now, when Eckersberg had fixed himself at home, turned towards him. To relieve this want, and to satisfy the many applications for artistic assistance, he

founded his painting academy in 1859. The importance of this institution was soon acknowledged by the Government, and the Norwegian Chamber of Deputies has ever since voted it a yearly subsidy; from this institute has issued forth a number of young artists, who, though the greater part of them still may have to win a name, already have proved themselves a credit to their master, and in the future annals of Norwegian Art will certainly uphold the reputation of Eckersberg's academy, and long cherish the memory of the friendly master, who guided and assisted them—many gratuitously—in their years of probation, and subsequently gave them his advice.

Every summer but the last, he made an excursion to the various interesting parts of Norway, from which he always brought back a rich harvest of sketches that served him for subjects; and these compositions bear witness to that power of conception which enabled him to portray the grandest features of nature with unquestionable reality of truth. From the charming neighbourhood of his summer retreat at Sandvigen, near Christiania, he selected subjects for many beautiful pictures.

As a Professor of the Art, his name had now acquired a reputation in the artistic world, as many a flattering testimonial from foreign exhibitions bear witness, and his works were in demand from most countries.

In his private life he had to contend with difficulties of a pecuniary nature, having been induced, by his sense of filial duty, to overstep the prudential line so far, that he brought upon himself responsibilities, of which, at the time, he did not understand the nature; these had also now been cleared off, and from that quarter no more threatening clouds obscured the serenity of his future prospect.

But his days were numbered; he was cut off in his prime, after a short illness, at his favourite residence at Sandvigen, on the 12th of July, 1870.

Eckersberg received many marks of distinction. Charles the XV., the present king of Norway and Sweden, conferred upon him, in 1866, the knightly honour of the Swedish order of "Wasa;" and in 1870, only a few months before his death, the Norwegian order of "St. Olaf." Previously he had been honoured by king Oscar I. with the gold medals "*Pignus memoriae*" and "*Literis et Artibus*."

[We may add that the works of this artist are not unknown to us. In the Paris International Exhibition of 1867, a large picture by him received unequivocal commendation in our column, as did also his previous contributions to that of 1855. In the recent exhibition at Manchester was a fine work from his easel, which we hope may have found a purchaser; for we understand the deceased painter has left a widow and children, to whom its sale would be highly beneficial; Eckersberg unfortunately having died before he could realise a provision for them.—ED. A.-J.]

WILLIAM HOLL.

This excellent engraver died, after a long and painful illness, on the 30th of January. He was born at Plaistow, in Essex, in February, 1807, and was the second son of William Holl, an eminent portrait-engraver, who taught him his art. The son followed for a long time in the footsteps of his father, and some of his best works in portraiture will be found in Lodge's "Portraits of Illustrious Personages of Great Britain," in Knight's "Gallery of Portraits," and in

Finden's "Portraits of the Female Aristocracy." Many of his plates were executed for the edition of the Bible, published by Messrs. Blackie, of Glasgow; and also among the illustrations of T. Moore's poems; in the latter are some fine heads after W. P. Frith, R.A.

In 1851, Mr. Holl completed the large plate, for the Art-Union of London, of 'An English Merrymaking,' after the picture by Mr. Frith; it was the first plate of large size engraved in what is termed the "chalk" style, and was very favourably noticed in our columns at the time of its publication. It was followed by 'The Village Pastor,' and 'The Gleaner,' also from paintings by Mr. Frith; and by a large number of portraits from drawings by G. Richmond, R.A.; including distinguished members of the Grillon Club, Lord Lyndhurst, Keble, and Faraday. He had completed, just prior to his death, an engraving, for the Art-Union of London, of the 'Rebekah,' after F. Goodall, R.A. This plate is not yet published.

The subjects he had in hand at the period of his demise are, at his expressed wish, being finished by his brother, Mr. C. Holl, and his able assistant, Mr. F. A. Roberts, both of whom had been associated with him for the last thirty years.

Mr. Holl was an indefatigable worker; the number of plates which proceeded from his studio was very large, including both portraits and figure-subjects. All are characterised by artistic feeling and great delicacy of execution.

VICTOR GIRAUD.

The disastrous continental war has added another artist to the list of its victims in the person of this painter, who died on the 21st of February from disease brought on by exposure and exhaustion on the fortifications during the siege of Paris. His latest and best-known pictures are 'The Slave-Market,' and 'The Bird-Charmer,' for which he received medals of the 2nd and 3rd class respectively, at the *Salon* of last year.

NATURE'S SUBSTITUTES FOR GLASS AND POTTERY.

BY P. L. SIMMONDS.

It is curious to take a glance at the drinking vessels, water and food holders, which were in use by man before glass and earthenware were thought of, and which nature provided ready to his hand out of her abundant stores in the vegetable and animal kingdom. Many of these are now replaced by the handiwork of the potter and glass manufacturer, whose wares are carried on the wings of commerce to the remotest regions of the globe. A cursory survey of some of the rude appliances which are now rapidly passing away cannot but prove interesting, for on very many of these domestic utensils a large amount of artistic embellishment was lavished, rude, no doubt, but characteristic; and some of the more elaborate ornamented drinking vessels of wood, ivory, horn and shell, form even now objects of admiration.

Among the many contributions which Nature supplies to the wants of man, the various excellent vegetable substitutes for glass and earthenware for drinking vessels and other domestic purposes are not the least. In uncivilised regions, and to many tribes of natives, these are invaluable. Their abundance, convenience, durability, and cheapness, are not among the least of their advantages. The rind or woody coat of gourds and some other large fruits, the hard capsules or seed-vessels of some trees, the internodes of the gigantic bamboo grass, the hollow fronds of fuci, turned cups and bowls of

wood, in various places, are brought into use as water-vessels, platters, or other domestic utensils.

The term calabash is applied very indiscriminately, in a popular sense, both to the hollow shell or rind of the fruit of the true calabash-tree and that of various species of cucurbits.

In Africa, the East and West Indies, South and Central America, and the Pacific, calabashes and gourds serve for all kinds of domestic utensils. Cups and saucers, baskets and bowls, pepper and salt dishes, &c., of various sizes, plain or carved, are made of them, taking the place of earthenware and glass, and not being so easily broken.

Jarves, in his "History of the Hawaiian Islands," says the most useful article, and one which can be applied to an almost endless variety of purposes, is the fruit of the cucurbita, the calabash or gourd. From it their drinking vessels, dishes, masks and musical instruments were made. It still supplies the want of iron, glass, crockery and wooden ware. In travel it answers for a trunk; at home for a closet. They are often prettily ornamented after the same patterns as their mats or tapas, and are of every size, from the smallest water-cup to the great poie-dish, capable of holding ten gallons.

Generally speaking, the species and varieties of cucurbits are harmless and eatable, contributing a very important part of the diet of the poorer classes in countries which are subject to long summer-drought. Hence in the south of Europe, in India and Africa, they are invaluable to the inhabitants of those countries; but the orange-gourd is bitter, and a variety of the bottle-gourd occasionally poisonous.

Two principal species of gourds are known in Chili, the white-flowered and the yellow-flowered. Of the first kind, called by the Indians "quanda," there are, according to Molina, twenty-six varieties, several of which produce fruit that is sweet and edible, but that of the others is bitter.

Of the bitter kinds the most distinguished is the cider-gourd (*C. siceraria*, Molina), so called from the Indians making use of it, after extracting the seeds and perfuming it, to ferment their cider. It is naturally of a round form, and frequently grows to a large size. It is also used by the natives instead of baskets, and in such cases they give it whatever shape they think proper.

The true calabash is the woody rind of the fruit of a West Indian tree, the *Crescentia cujete*. The fruit varies in size and figure, being sometimes round or oval, at other times bottle-shaped. The popular name is derived from the Spanish Calabáza. Cups, mugs, ladles, bowls, basins, and in fact almost every article of household use, are made from them by the lower classes in tropical countries. They are even used for saucepans or kettles to boil water in, for the shell is so hard and close-grained as to bear the fire several successive times without injury.

When intended for ornamental vessels they are sometimes highly polished and have figures carved or engraved upon them, which are variously tinged with indigo, red, or other colours. Some under the name of "totumos," most elaborately carved, and valued at several pounds, were shown in the Venezuela court at the London International Exhibition in 1862.

In the interior parts of Brazil the fruit is cut in halves, the pulp removed, and the rind or shell reduced by scraping. This being sufficiently dried, is painted both inside and out by the Indian women with ingenious and sometimes beautiful devices. They are the universal drinking cups, and there bear the name of "cuyas."

The round calabashes will hold from one to four pints, and the blunt oval ones sometimes as much as seven quarts. Some of the largest species of gourds when cleared of their pulp have been found to hold twenty gallons—and would have served for the veritable pompion for Cinderella's carriage.

Gourds are very convenient, not only as water-dippers, but as receptacles for numerous small articles. In the Southern and Western States of America it is common to find a pail, and one or more drinking-gourds, at some convenient spot about the house—generally on the front piazza, where every traveller can help

himself to a draught of water. Often too on visiting the springs by the roadside or in the plantations, the indispensable gourd is found hanging to a tree. They are grown of all sizes from a gill to a gallon; and one kind, that grows without the elongation for a handle, we have seen of the capacity of half a bushel, and the shell so hard that it would last many years for dry storage. In Texas, a variety with a depression in the middle, and bulb of equal size at each end, is frequently used to carry water on horseback, for it can be conveniently lashed to the saddle.

The principal crockery, if one may so use the term, of the Maoris of New Zealand, was supplied by the *hue*, or gourd. At great festivals the chief delicacies were placed in these large calabashes, which were often beautifully carved or ornamented with tattooing. In these vessels the Maoris carried water, stores, potted fish, birds or flesh, and they were also used for a lamp as well as a dish.

The national infused beverage of South America, *Mate*, made with the Paraguay tea (*Ilex Paraguensis*), is served in a gourd usually edged with silver and often richly ornamented. It is imbibed through a "bombilla," a silver tube which at the bottom expands into a bulb pierced with holes to act as a strainer.

The yellow-flowered gourd called "penca," is of two kinds, the common and the mamillary; this last (*C. mammeata*, Molina) in its leaves and flowers resembles the first, but the figure of the fruit is spheroidal, with a large nipple at the end.

Acosta, in his "Natural History," says, "the calabashes of the Indians are another wonderful production for their size and the luxuriance of their growth, especially those called zapallos (*Cucumis zapallo*, Steud), the pulp of which, particularly in Quaresma, is eaten boiled or fried. There is a great variety of this species of the calabash; some of them are so large, that when dried and the shell divided in the middle and cleansed, they are used as covered baskets to put provisions in; others that are smaller are employed as vessels to drink from, or handsomely wrought for various purposes." The bottle-gourd (*Lagenaria vulgaris*) bears fruits which are at first long and cylindrical; but as these ripen they swell exclusively at the upper end, and acquire the form of a flask, the neck of which is their base. When ripe they become hard enough externally to hold water, and accordingly when the pulp is removed, they form good bottles, and are extensively employed for that purpose. It is necessary, however, that they should be repeatedly washed out, so as to remove all trace of the prevailing bitterness; otherwise their use is dangerous. In India the poorer classes eat the fruit boiled with vinegar, or fill the shells with rice and meat, thus making a kind of pudding of it. The pulp of the fruit is often used in poultices; it is bitter and slightly purgative, and may be employed instead of colocynth. The hard shell when dry is used in India for Faqueer's bottles, and a variety of it is employed in making the stringed instrument known as the "sitar," as well as buoys for swimming across rivers, transporting baggage, &c. In Jamaica, Africa, and many other places within the tropics, the shells are used for holding water or palm-wine, and so serve as bottles; hence the popular name. They are sometimes called calabash-gourd and trumpet-gourd.

The shells of the cocoa-nut are very commonly used in many countries for water-bottles, dippers or ladles, and drinking-cups. Some are frequently elegantly carved and ornamented, and set in silver. Several thus mounted, enriched with Singhalese carvings, were shown at the Exhibition of 1862, in the Ceylon and Indian Courts. Of the cocoa-nut shell, hubble-bubbles, or water-smoking pipes are also made in India.

The double cocoa-nut of the Seychelles (*Lodoicea Sechellarum*) realised at one time fabulous prices, greedy native kings having given a loaded ship for a single one. From its rarity the albumen was supposed to be endowed with medicinal virtues of an extraordinary character. Although they have now lost much of their repute, they are still held in such estimation by the negroes and poor people of other

islands, that sailors always try to bring away some in their vessels. When preserved whole and perforated in one or two places the shell serves to carry water, and two of them are suspended from opposite ends of a stick. Some of these nuts hold six or eight pints. If divided in two between the lobes, each portion serves, according to its size and shape, for plates and dishes or drinking-cups, these being valuable for their great strength and durability.

The "cabombas," or cups of the *zabucaia*, or monkey-pot (*Lecythis urnigera*, Mart.), which contain the *sapucaya* nuts of commerce, are frequently of great size and excessive hardness, and are closed by a lid like that of a pyx or soap-box. The aborigines of parts of South America use these not only as goblets, but as pots and dishes. Hence Linnæus called the plant *Lecythis ollaria*. The lid of the cup falls off when ripe. Portuguese turners make pretty boxes and other small articles out of these solid cups. In the Brazilian Court at the London Exhibition of 1862 some handsome specimens were shown. The hard capsules of the Brazil nut (*Bertholletia excelsa*) may also be used as a durable drinking-cup, when one section has been removed by a fine saw. From the nut of another South American tree, the *Attalea funifera*, the "coquilla nut" of commerce, very pretty egg-cups are frequently turned. The rind or shell of the large fruit of the *Adansonia digitata*, sometimes called the Ethiopian sour gourd, or monkey bread-nut, is used by the Soahili of Africa as a substitute for water-buckets. Other cups and buckets of vegetable origin are moulded in gutta-percha and caoutchouc. The large dried hollow fronds of a gigantic fucus serve as water-buckets on the Pacific Coasts of South America. Water-pitchers used to be made by the aborigines of Tasmania of the broad-leaved kelp. They were often large enough to hold a quart or two of water. These and the shell of a species of cymba were the only vessels they had for carrying water. The Australian aborigines now make an effective water-bucket, called a "pegee," out of the tough leaves, or *spathe*, of a palm, suspended to a cross stick.

Very prettily-carved cups of bamboo often reach us from China; and turned goblets of various fancy woods are common in many countries; nor must we forget the bitter cup of the shops, turned from the wood of one of the *quassia* tribe, the *Picraena excelsa*, Lindley, of Jamaica, from whence we may long quaff an impromptu tonic before the medicinal properties of the wood are exhausted. Tumblers, or goblets, of *quassia* and *sassefras* wood, are also made in Brazil. The Pacific islanders have their "kava" bowls, and the Kaffirs their huge wooden bowls for millet-beer and other intoxicating beverages. The pledge-cup and wasail-bowl of maple wood, known under the name of "maxers," are still prized as curiosities.

Thus much for vegetable cups, but there are very many of animal origin equally useful.

The "carapace" of several species of sea-turtle and tortoise make very convenient water-receptacles, while numerous sea-shells are used for the purpose, such as the pearly nautilus mounted, the green snail as it is commercially called, a large species of *Turbo*, and others more shallow, which serve as water-dippers.

The early drinking-horn and water-holder is not yet out of date, and very prettily-carved drinking-cups are turned out of ivory. Of these there are many examples in the South Kensington Museum.

Another cup of animal origin which possesses a high value in the East, is carved from the horn of the rhinoceros. These horns are imported into China from Burmah and Sumatra, and from Africa through Bombay. They are highly valued by the Chinese, from a notion that cups made from them exude whenever a poisonous mixture is poured into them; thus they act like the Venetian glass of our ancestors, and are as highly prized as that eccentric fruit, the *cocos-de-mer*. A perfect horn sometimes sells as high as 300 dollars, but those that come from Africa do not usually rate above 30 or 40 dollars each. The principal use of these horns is in medicine and for amulets, for only one good cup can be carved from the end of each horn, and consequently the parings and fragments are

all preserved. Leather water-bottles, &c., of skin, are still in use in parts of Europe and Africa. The *girbehs*, or water-skins carried on camels are made of untanned antelope hide, and the *sensamien* are bags of leather fitted with a mouth-piece screwed in, with a hole and straw or reed to drink from; some water-skins of sheep or goat for carrying wine, oil, or other liquid, are made without seam. The skins are worked off the body without outward cut, down to the lower joints of the legs, which are left hanging on the skin, and bound across two and two, or crosswise, to keep all firm and united, the neck of the hide forms the mouth, and is firmly bound round and round with strong cord. The leather wine-bottles of the peasants of Spain and Portugal may still very commonly be seen. The dubbars, which are used in India for holding oils and other fluids, are made of gelatine, prepared by boiling cuttings of skin, and shaped on earthen moulds. The leather fire-bucket has almost gone out of use now.

Black jacks, or leather drinking-cups, with silver rims, are still frequently met with as curiosities. The most convenient, portable, and durable travelling-cup I have met with, is one lately made of vulcanite, on the telescope principle, which compresses into a flat surface for the pocket, and is yet perfectly water-tight when expanded.

The shells of the ostrich egg are converted, in South Africa, into water-flasks, cups, and dishes. Bush-girls and Batalahan women, who belong to the wandering Bechuana tribes of the Kalahan desert, may often be seen coming down to the fountains from their remote habitations, sometimes situated at an amazing distance, each carrying on her back a *kaup*, or a network, containing from twelve to fifteen ostrich egg-shells, which have been emptied by a small aperture at one end; these they fill with water, and cork up the hole with grass. The green emu-egg of Australia, set in silver, also makes a very handsome drinking-cup. A powder-flask, or drinking-vessel, is frequently made from the singular upper mandible and appendage of the rhinoceros horn-bill (*Buceros rhinoceros*).

Lastly may be noted that it was an ancient barbarous custom for victors to quaff draughts out of the skulls of their enemies; the most elegant sample of this kind of drinking-cup was the human skull shown in the Chinese department of the International Exhibition of 1862, by Captain Tait, richly set in gold, reported to be the skull of Confucius. Pounded human skulls, well dried, formed, we are told, the chief ingredient in the celebrated Goddard drops, "the true medicine, which was purchased of Dr. Bates by King Charles II., so much famed throughout the whole kingdom, and for which he gave him many hundred pounds sterling."*

The skull drinking-cup was perhaps even better than the pounded skulls, although fanciful notions were long current as to certain curious medicaments for various ailments.

These few notes on drinking-vessels and domestic utensils, derived from the animal and vegetable kingdom, will, at least, have an interest in contrast with the more finished and skilful specimens of glass, pottery, and china shown at the International Exhibitions.

ART-WORKMANSHIP COMPETITION.

EIGHTY-TWO objects were sent in competition for the prizes offered by the Council of the Society of Arts. The branches of industry illustrated are as follows:—carving in wood, stone, and ivory; inlay in wood and in marble; modelling in plaster; metal-work; die-sinking; cameo-cutting (in shell); book-binding; painting on porcelain; and glass-blowing.

We have to regret, as on former occasions, the very limited number of manufacturers and of workmen who came forward to avail themselves of the liberal offers of the Society. The contrast presented between the anxious and disinterested exertions of those who strive to

encourage Art, for its own sake and for that of the public welfare, and the heedlessness of those to whom the knowledge and practice of Art means "bread and cheese," and ought to mean something more, is disheartening. What does the English workman need to stimulate him to well-directed exertion? He has allowed the area of his own exhibition at Islington to be filled, almost exclusively, by foreign industry. He sends the small number of objects we have named to a national exhibition in the Adelphi. While we see—rejoice to see—individual instances of the highest promise, the general state of apathy and self-content is one of the gloomiest prognostics that indicate the future of the country. Our manufacturing eminence will leave us, as eminence in other branches of national boast has already left us, and that both swiftly and irremediably, unless the industrial classes become aware of their actual condition, and of their educational deficiency.

The greatest improvement we have observed in the exhibits of the present year over its predecessors is in the forged work. There is one of a pair of wrought-iron gates executed for the Union Bank of London by T. Winstanley, 25, New Compton Street, from a design by Mr. F. Porter, which is an excellent specimen of that style of work for which our smiths were once famous. The producers of this gate have very deservedly been rewarded with the silver medal. Two elegant wrought-iron brackets are also deserving of commendation. In brass there is a gas-standard by Mr. Joseph Taylor, which is by no means to be despised; and an inkstand by the same artist in the same material, also merits praise. There is some very good work in damascening on the blade of a trowel, which shows how the skilful artisan may be led to throw away time in executing poor designs—time which, under the guidance of better education, might produce works altogether excellent. There are marks of skill in the Head of a Satyr, executed in *repoussé*, by Mr. Theuerkauff, and in a portrait after Jean Gougon, also in *repoussé*, by Mr. R. Tow.

As to wood there is an important specimen, priced at £100, of an inlaid loo-table in Amboyna wood. The lower part is enclosed by four marqueterie panels. It is designed and partly executed by Thomas Jacob, 4, Upper Charlton Street, Fitzroy Square, and bears marks of the careful study of the artist in one of our Art-Schools. The Society's silver medal, and a money-prize of £25, have been awarded to Mr. Jacob, as well as the North London Exhibition prize, offered for the best specimen of skilful workmanship in the Society's exhibition. There is a carving in limewood, of dead game, by R. J. Tadsbury, Edwinstowe, Notts, which displays both force and delicacy of treatment. An oak panel, of a design adapted from an old panel, by J. Osmond, and a mirror-frame, carved in oak and ebony, by W. H. Holmes, 107, Dean Street, Soho, are also very good bits of carving. Although the specimens exhibited are so few, we are glad to note a considerable advance in excellence over those of the preceding year.

The same cannot be said as to glass. It is melancholy to observe only seven exhibits by two manufacturers in this material. They challenge a comparison with the Venetian work, which it is only by a stretch of compliment that they may be said to imitate. If Birmingham is fairly represented by these specimens, she ought to be ashamed of herself. For that matter, so she ought on the other supposition, of her being almost altogether unrepresented in this important and beautiful art.

In modelling in plaster, the workmanship is much in advance of the taste. Mr. J. W. Gould's figure of a child, which has earned the society's silver medal and £10, gives us the idea that the artist must consider that a sort of photography in plaster is good sculpture. In the well-executed friezes, by Mr. I. Daymond, the fatal English notion that the right-hand portion of a composition ought to be such an exact reflexion of the left hand portion as would be given by a mirror, is painfully apparent. Much of our English work is rendered absolutely detestable by this bilateral symmetry. The iron gates to the Marble Arch at Hyde Park Corner are a notable example.

* Bates's "Dispensatory," by Dr. Sale. 1700.

THE STATELY HOMES OF ENGLAND.

(OCCASIONALLY OPEN TO THE PUBLIC.)

"The stately homes of England,
How beautiful they stand!
Amidst their tall ancestral trees,
O'er all the pleasant land."

MRS. HEMANS.

By S. C. HALL, F.S.A.

THE ANTIQUARIAN NOTES AND DETAILS
BY LLEWELLYNN JEWITT, F.S.A.

HADDON HALL.

AT the close of the last chapter we left our readers at the north end of the Winter Garden of Haddon Hall, in that charmingly shady corner formed by the wall of the Long Gallery on the one side, the outer wall of the garden on the opposite, and the third by that most attractive feature of the mansion, "Dorothy Vernon's Door." Having kept our friends in this delightful nook for a month, that they might revel in all its beauties, and ponder well upon what we have told them, we now purpose proceeding with our pleasant task.

From Dorothy Vernon's door a short flight of stone steps, with balustraded sides, leads down to the Winter Garden, on the opposite side of which, nearly opposite to this doorway, a long flight of stone steps leads up to another, and considerably higher terrace, called DOROTHY VERNON'S WALK—a broad pathway, or promenade, passing between an avenue of lofty lime and sycamore trees—and one of the most secluded and romantic "lovers' walks" in the neighbourhood.

The old BOWLING GREEN, near the summit of the hill above Haddon, occupied an acre of ground, and was approached by an avenue of trees. It was enclosed by a thick hedge of yew, with a flight of stone steps for an entrance. On

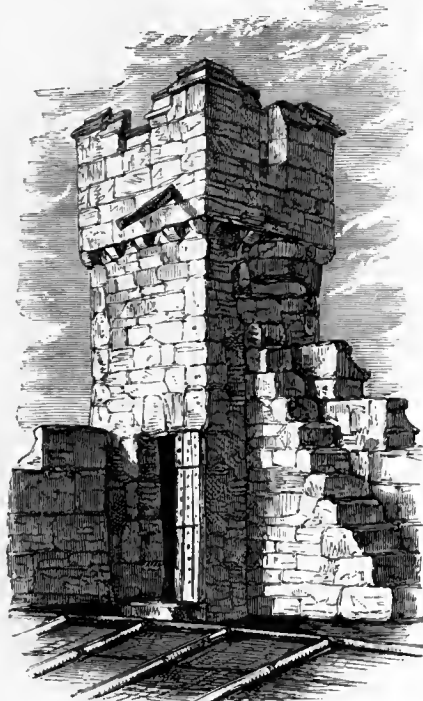

THE EAGLE, OR FEVEREL TOWER,

one side was a lodge, or summer-house, over one of the doorways of which are initials and the date of 1696. The "Green" is now converted into a garden.

There is also a plot of ground, levelled, and in form a parallelogram, which is known as the "archery ground."

Before leaving Haddon, the visitor should step inside the building now used as a stable, in which he will find some features worthy of

observation. In the cottage inhabited by the kindly and respected keeper of Haddon, Mrs. Bath, is some fine carved furniture, and in the garden in front, the yew trees, cut into the form of a Peacock and a Boar's head—the crests of Manners and of Vernon—form pleasing objects, and are sure to attract the attention of the visitor.

The meadows around Haddon—with the river Wye twisting and turning about in all imaginable forms—are very delightful, and some of the pleasantest strolls conceivable may be taken along them, both up and down the stream which is full of fine trout, and is, therefore, a source of endless delight to the angler.

Having thus—in this and the preceding three chapters—given our readers as full an account as would appear necessary both of the noble families to whom Haddon has belonged, and of the Hall itself, and told them as much of its history as will suffice for all purposes of the Tourist, we take leave of this interesting pile, and proceed to speak of one or two matters connected with its immediate neighbourhood, before passing on to the fine old church at Bakewell, where lie interred so many of the families of Vernon and Manners. Haddon has been a prolific theme for writers, and an endless source of inspiration for poets and artists, and

long will it continue to be so, for no "olden" place can be more picturesque or more romantic. It is said that Mrs. Radcliffe was so struck with it, that she laid the scene of her "Mysteries of Udolpho" here; and Allan Cunningham, the Countess de Carabella, and numberless other writers, have made it a theme for some of their pleasantest productions; William Bennett took it and its hospitable owner, Sir George Vernon, as the subject of one of his most successful novels, "The King of the Peak;" while D. Cox, Nash, Cattermole, Harding, Rayner, Morrison, and a host of other artists, have added to their reputations by painting some of its more attractive features.

As may naturally be expected, in a neighbourhood so rich in interest as that of Haddon, some singular discoveries have at one time or other been made. Among these the Roman altar, already described in our second chapter, is perhaps the most important.

The opening of barrows in the neighbourhood has brought to light many interesting remains of the ancient British period, and also of Romano-British times. These consist of interments in which have been found cinerary urns, drinking-cups, bone mesh-rules, flint implements, bronze celts, and other articles.

Some fine antlers, and parts of antlers, of the



ROOM OVER THE ENTRANCE GATEWAY.

red deer, one of which, with four points at the top, measured more than 3 feet along its outer curve, and was 6½ inches in medium circumference, have also been found. But these are not the only remains of extinct animals found in the neighbourhood, for those of the wild dog, the wild hog, the horse, the deer, the roebuck, the goat, and the ox—both the *Bos Urus* and the *Bos Longifrons*—all of which once ran wild in Derbyshire, have been found, in the course of deep draining near the Hall, and preserved under the careful direction of Mr. Nesfield.

Perhaps the most elegant relic yet discovered is the ring shown in our engraving, which is in possession of his grace the Duke of Rutland. It was found a few years ago, not far from the "Bowling Green," and is evidently of the fifteenth century, and is of extremely fine workmanship and elegant design. The hoop is wreathed, and has originally been enamelled, and bears between the foliage the inscription, in old English letters, "de boen euer," which is one of frequent occurrence as a posy upon mediæval rings, probably, in this case, meaning *de bon cœur*, and showing the hearty affection of the giver to the receiver. The little figure engraved on the besel is St. John the Baptist, with the Lamb enfolded in his mantle, and has most likely also been enamelled. It is probably a

kind of charm-ring—i.e., a ring possessing physical or phylacteric qualities against epilepsy, the *mal de St. Jean*. It is of the purest gold, and weighs ninety-seven grains.

Another interesting "find" was the Washing Tally already referred to, which is of the time of Charles I., and of extreme rarity. Of this Tally, as intimately connected with the inner and home life of Haddon, at the period of the height of its hospitality and glory, we give the accompanying accurate engraving, which is drawn of a somewhat reduced size. This very interesting relic is 5½ inches in length, and 4½ in depth. It is formed of a piece of beech-wood, a quarter of an inch in thickness, covered with linen on the back and sides. Its construction is precisely that of a "Horn-book." In front, the names of the different articles of clothing are printed from a copperplate and protected by a sheet of horn. Around the edge, a narrow strip of thin brass, fastened down with highly ornamented nails, attaches the horn, the paper, and the linen to the wood. The "tally" is divided into fifteen squares, in each of which is a dial numbered from 0 to 12, and above each square is the name of the article of clothing intended to be taken into account. These are "Ruffes," "Bandes," "Cuffes," "Handkercher," "Capps," "Shirtes,"

"Half-shirtes," "Boot-hose," "Topps," "Socks," "Sheetes," "Pillowberes," "Table-clothes," "Napkins," and "Towells." On each of the dials is a circular brass indicator, fastened by a little pin in its centre, so as to be turned round at pleasure. Each indicator is pierced on one side, close to the edge, with a round hole, through which one number only on the dial is visible at a time, and opposite to this hole is a raised point by which the indicator can be turned as required.

Another little relic of Haddon "in the olden time" is a wooden vessel called, but of course without the slightest authority for the name, "Dorothy Vernon's Porridge-pot." It is a small wooden basin, or bowl, of curious form, and evidently of great age, and may, doubtless, have held many a mess of porridge in its time. We shall give an engraving of this interesting little relic, which, along with a rude rolling-pin, was taken away at the time of the breaking up of the establishment at Haddon Hall, by one of the retainers named Dale, in whose family it has, until lately, remained. A members of this family of Dale will shortly be named in connection with a singular epitaph at Bakewell.

Passing on from Haddon to Bakewell, the tourist will not fail to notice the Dove-cote on a mound near the road-side, and from this road-side



DOROTHY VERNON'S DOOR: INTERIOR.

he will obtain one of the best and most charming views of the Hall to be gained from any point.

It may here be well to note, that although Haddon Hall is no longer used as a residence by the Duke of Rutland, he has within three or four miles of it a delightful shooting-box, Stanton Woodhouse, pleasantly situated, and charming in every respect, where he and others of his family occasionally sojourn. This and his other shooting-lodge, Longshawe, some distance across the moors of the same county, are two charming retreats for the sportsman. It may be mentioned, too, that at Rowsley, close at hand, is the splendidly executed effigy of Lady John Manners and her infant, by W. C. Marshall, R.A.

We have gone at much length into the history of this venerable structure, and illustrated largely its many and interesting peculiarities; as we intimated at the commencement of these papers, although Haddon receives more visitors than any other of the time-honoured mansions of England, there exists no sufficiently descriptive guide by which pilgrims to this shrine may be instructed, when walking through its now solitary corridors and chambers, or upon those terraces that have rather improved than deteriorated by the centuries which have given to them the graces and glories of age. We have

thus, we believe, supplied what many needed, and what cannot fail to augment the enjoyment to be derived from a visit to the locality.

The charm derived by comparison is here, especially, near at hand, for princely Chatsworth is distant only three miles from venerable Haddon. It will probably be our privilege, hereafter, to describe this seat of the dukes of Devonshire: the grandest, the richest in its adornments and contents, the most beautiful and the most perfect of all the mansions—comparatively modern—of the kingdom. It has all that Haddon lacks; but it is not, like the old home of the Vernons, sanctified by Time.

There are thousands—in the New World more especially—to whom these records of Haddon will recall to mind and memory days of pleasant pilgrimage; when, rapt in thought, the imagination was free to revel, summoned from the past to the present only by the shrill sound of the railway-whistle, the utter incongruity of which with the surroundings elicits a petulant regret for the moment, that science has invaded this nook of English ground, rendering far-off Derbyshire as much beaten ground to the tourist as the parks, whether new or old, that adjoin any of the populous towns of England.

But surely such facilities will promote home-travel, and so remove from many the reproach that they are better acquainted with the attractions of foreign lands than with the charms of their own country. Yet all that Nature, in the abundant fulness of her wealth, can supply, may be obtained and enjoyed, without a single drawback, in many of our English shires—in Derbyshire more than any; while its glorious remains of ancient grandeur are at least as numerous and inviting, within a day's rail of the metropolis, as they are in kingdoms that tempt the traveller to encounter annoyances, vexations and dangers inconceivable, to those who are wanderers nearer home.

BAKEWELL CHURCH, the burial place of some of the members of the Vernon and Manners families, to whom Haddon Hall successively belonged, is nearly two miles distant from Haddon, and may be seen on looking up the valley of the Wye. Bakewell itself is a pleasant and remarkably clean little market-town, built on the banks of the Wye; there are several good public buildings in the town itself, and many substantial residences in its neighbourhood. It is, however, to the church only that we now desire to call attention in a short description.



DOROTHY VERNON'S DOOR: EXTERIOR.

It is a cruciform building, of about 150 feet in length from west to east, and about 105 feet in width across from wall to wall of the north and south transepts, with a central tower and spire. It contains some extremely fine Norman and Early-English features, and is lofty, and remarkably well proportioned. In the centre rises a noble tower, the lower part of which is square, and the upper octagonal, with the angles boldly chamfered, and this is surmounted by a lofty spire. There can be no doubt, from remains which have been found, that a church had existed on this spot from very early pre-Norman times. In Domesday survey, it is stated there were two priests for the church of Bakewell. It was afterwards made a collegiate church. It was granted by William the Conqueror to William Peverel, his natural son, but was, with the other immense possessions of that family, forfeited by attainder by one of his descendants in 1154; it remained in the possession of the crown till it was given by Richard I., on his accession to the throne in 1189, to his brother, John Earl of Mortaigne, afterwards King John. To him is traditionally ascribed the rebuilding of the nave (with the exception of the west end, which he is said to have left standing), and its

endowment; but it is more probable that it was built and endowed by a Peverel, who gave part of the Bakewell tithes to Lenton Priory. In 1192, Earl John gave the church, with all its prebends and other appurtenances, to the present cathedral of Lichfield. In 1365, a chantry was founded in the church by Sir Godfrey Foljambe and Avena his wife, whose beautiful little monument will be seen on one of the piers of the nave. The nave, which was erected probably about 1110, is separated from the side-aisles by semicircular arches, rising from piers of solid masonry instead of pillars. At the west end is a fine Norman doorway ornamented with beak-head mouldings and other characteristic features.

The church was extensively repaired and restored in 1841, when numerous very interesting remains were brought to light. These included an extensive series of incised sepulchral slabs, of very early date, bearing crosses of various forms, and many interesting devices; several ancient crosses used as head-stones; a considerable and extremely beautiful assemblage of fragments of encaustic paving tiles; and several fragments of coped tombs, and of crosses with the interlaced ornament so characteristic of the Saxon period, as well as many stone coffins, and

sculptured fragments of mouldings, capitals, &c., belonging to the more ancient edifice.

Of these curious remains the greater part was, thanks to the care of Mr. F. Barker and the Rev. H. K. Cornish, preserved in the porch of the church, and consist of considerably more than fifty incised slabs—some of which are perfect, and others in fragments—and perhaps a score or two of other stones. It is also stated, and is much to be regretted, that at least four times the number of sculptured stones preserved were rebuilt into the walls during the alterations, so that, including a number taken away and now preserved at Lomberdale, there must have been from three to four hundred found. In the same porch, a selection of the ornamented paving tiles is also preserved; among the patterns are many of extreme beauty and elegance.

The font is also deserving of especial notice. It is octagonal, each of its sides bearing a figure beneath a crocketed canopy. A fragment of another ancient font will be seen in the porch.

The part of Bakewell Church, however, with which we have now particularly to do is the VERNON CHAPEL, in which, divided from the south transept by a beautiful open oak screen, lie buried the later Vernons and the earlier members of the Manners family connected with Haddon. This chapel was, it appears, erected "late



STEPS TO STATE APARTMENTS.

in the Decorated period, about 1360, upon the walls of the former chapel. The Early-English half-pillars at each extremity of the arches had been retained, and were very beautiful examples, well worthy of imitation. The hollows of the mouldings, up to a certain height, being filled with bold roses, capitals in a different style were afterwards added to suit the decorated arches. The central pillars, with their central clustered shafts, are of singularly elegant design; the tracery of the windows partakes of the flamboyant character. The upper part of the buttresses was also altered to correspond with the new work." It will bear comparison with any structure of the kind in England, and has been rebuilt in good taste.

In the centre of the Vernon Chapel stands a fine altar-tomb, bearing the recumbent effigies of Sir George Vernon, the "King of the Peak," and his two wives, Margaret Taylebois and Maude Langford. This tomb is an extremely beautiful and characteristic example of the elaborately decorated monuments of the period to which it belongs. Along its sides, under a series of canopied arches, are figures bearing shields of the arms of the Vernons and their alliances and those of the families of his two wives. Sir George is habited in plate armour and surcoat,

and wears a straight long beard and straight hair. He has a double chain and a sword. The inscription on this interesting tomb is as follows:—"Here lyeth Sr George Vernon, Knight, deceased ye — daye of — an^o 1561, and dame Margaret his wyffe, daughter of Sir Gylbert Taylebois, deceased ye — daye of — 156—; and also dame Mawde his wyffe, dawghter to Sr Ralphe Langford, deceased ye — daye of — anno 156— whose solles God pdon." The inscription, it will be seen, has never been finished, the blanks for the dates not having been filled up. The surcoat worn by the knight is elaborately emblazoned with his own arms with all its quarterings; and, taken altogether, this is a remarkably fine and interesting monument.

At the south end of the chapel stands, to visitors to Haddon, perhaps the most interesting of its monuments. It is that of Dorothy Vernon, about whose elopement we have already discoursed, and her husband, Sir John Manners, with their children. This lady, it will be recollected, was one of the daughters and co-heiresses of Sir George Vernon, whose monument we have just been describing, and his first wife Margaret Taylebois, and by her marriage with Sir John Manners, she conveyed Haddon Hall and the other Derbyshire estates of the Vernons to the family of Manners, to whom they still belong. This monument, we, for the first time, engrave.



THE FOOT-BRIDGE.

shields of arms, the one bearing Manners quartering Roos and two others; and the other, Vernon quartering Avenel and two others. The lower part of the monument contains four figures of the children of Sir John and his wife Dorothy, and two shields, the one bearing the arms of Manners, and the other those of Vernon.

At the opposite or north end of the chapel is a much larger and more pretentious monument, that of Sir George Manners, son and heir of Sir John Manners and Dorothy Vernon, and of his wife, Grace Pierrepont. At the top is a large shield bearing the arms of Manners with its sixteen quarterings, and on each side is an obelisk. Beneath these is a massive and bold cornice, supported on Corinthian pillars, forming a recess in which is a semicircular arch, elaborately carved, and over it the inscription, "The day of a man's death is better than the day of his birth." Under this arch and cornice are the effigies of Sir George Manners and his wife, kneeling, and facing each other, while between them is a double desk, or lectern, on the front of which are the words—"Thy prayers and thine alms are gone up before thee," and a shield bearing the arms of Manners impaling Pierrepont. Behind the figures, on a tablet, is a Latin inscription, which has been thus translated:—"Sir George

It is a large and very imposing-looking erection. At the top, the centre, is a large shield, bearing the shield of Manners with its sixteen quarterings, and on either side is an obelisk ornament, one of which bears the arms of Manners and the other of Vernon. Beneath these is a bold cornice and ornamental frieze, on which again occur three shields with the arms, respectively, in the centre Manners impaling Vernon; and on one side Avenel, and on the other Roos.

This cornice and frieze surmount a semicircular arch, beneath which are the kneeling figures, facing each other, of Sir John Manners, in plate armour, and his wife Dorothy Vernon, in close-fitting dress, with cap, and ruff or ruff around the neck. Between them, there is a pedestal, bearing the following inscription:—"Here lyeth Sr John Manners, of Haddon, Knight, second sonne of Thoas, Erle of Rutland, who dyed the 4 of June, 1611, And Dorothe his wife, one of the daughters and heires to Sr George Vernon, of Haddon, Knight, who deceased the 24 day of June, in the 26 yere of the raigne of Queen Elizabeth, 1584." Above the pedestal is a large shield, with quarterings of the armorial bearings of the families of Manners and Vernon and their alliances; the shields bearing the sixteen quarterings of Manners, differenced with a crescent, impaled with the twelve quarterings of Vernon. On the spandrels are also

Manners of Haddon, Knt., here waits the resurrection of the just in Christ. He married Grace, second daughter of Sir Henry Pierrepont, Knt., who afterwards bore to him four sons and five daughters, and lived with him in holy wedlock thirty years. She caused him to be buried with his forefathers, and then placed this monument, at her own expense, as a perpetual memorial of their conjugal faith, and she joined the figure of his body with hers, having vowed their ashes and bones should be laid together. He died 23rd April, 1623, aged 54. She died——." Sir George is represented in armour, and his lady is habited in close dress, with ruff, hood or coif, and long veil. Beneath the figures of the knight and his lady, the monument is divided into two heights, each of which is formed into an arcade holding the effigies of their children. The upper arcade consists of four semicircular arches, with shields of armorial bearings in the spandrels. Within the first of these arches is the effigy of the eldest son—a "chrisom child"—who died in infancy and is, as usual, represented bound up, mummy fashion, in swaddling clothes; in the second, the kneeling effigy, in armour, of John Manners, who ultimately succeeded to the title of eighth Earl of Rutland; and in the third and fourth, those of two of the

daughters. In the lower arcade, which is formed of five archways, the first two being semicircular and the remaining three pointed, are respectively the kneeling effigies of Henry Manners, who died at the age of 14, and is habited as a youth; Roger Manners, in armour; and three daughters. In the spandrels of the arches, as in the upper arcade, are a series of shields with armorial bearings. Over the nine arches are the nine inscriptions as follows:—Over the "chrisom child," "Mine age is nothing in respect of thee;" over the son and heir, "One generation passeth and another cometh;" over the youth Henry Manners, "My days were but a span long;" over the fourth son, Roger, "By the grace of God I am what I am;" over the daughters, beginning with the eldest, "A virtuous woman is a crown to her husband," "The wise woman buildeth her house," "A gracious woman retaineth honour," "A prudent wife is from the Lord," and "She that feareth the Lord shall be praised." On the pedestal by Sir George, "Christ is to me both in death and life an advantage," and on the opposite one, by his wife, "I shall go to him, he shall not return to me." The arms on the shields are those of Manners, differenced with a crescent; Pierrepont; Manners impaling Montague; Sutton impaling Manners; Howard im-

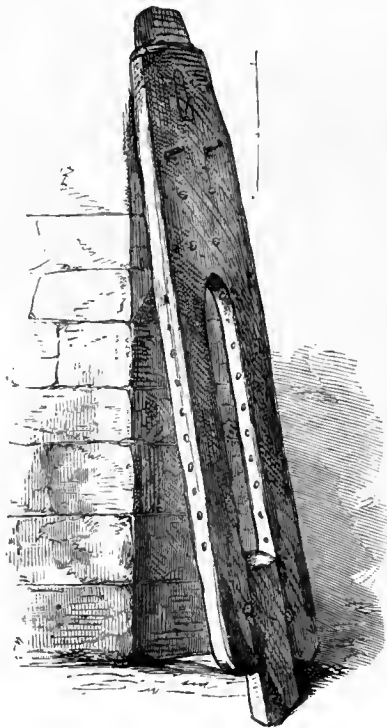

THE RACK FOR STRINGING THE BOWS.

paling Manners; and the other alliances also impaled.

On the wall is a memorial to John Manners, son of Dorothy Vernon and her husband, Sir John Manners, with the inscription—"Heare lieth buried John Manners, gentleman, third son of Sr John Manners, Knight, who died the xvi day of July, in the yeere of our Lord God 1590, being of the age of 14 yeers."

The most ancient, and certainly one of the most interesting monuments in the church, is that of Sir Thomas de Wendesley, or Wensley, of Wensley, who was killed at the battle of Shrewsbury in 1403. It is an altar-tomb, with the recumbent effigy of the knight in plate armour, wearing the conical helmet or bascinet, and camail or tippet of chain mail, with gussets of the same at the arm-pits. His girdle, which is exceedingly rich, encircles his hips; the sword is lost, but the dagger remains. His surcoat is emblazoned with his arms, and he wears the collar of SS. On the front of the helmet is inscribed IHC NAZAREN.

In the chancel is an altar-tomb to John Vernon, 1477, the inscription on which runs as follows:—"Hic jacet Johis Vernon filius et heres

Henrici Vernon qui obiit xii die mensis Augusti Anno Dni Mo cccclxxvii cuj anime piciet de;" and in the Vernon Chapel is an incised slab, with the arms of Eyre.

In the nave is a small but exceedingly beautiful monument bearing the half-length effigies, side by side, under an elaborately-crocketed canopy, of Sir Godfrey Foljambe and Avena his wife. The knight is represented in armour, with conical helmet or bascinet, and tippet of chain mail; his surcoat bearing the arms of Foljambe. The lady wears a reticulated caul. In each of the spandrels is a shield, the one bearing the arms of Foljambe, the other that of the family of Ireland, of Hartshorne, to which the lady belonged.

There are several tablets and inscriptions in various parts of the church which are worthy of a passing glance, and there are also some memorial stained-glass windows of good design. Among these is one in memory of the late Duke of Rutland, representing the Resurrection, bearing the following inscription:—"The above window was erected, by subscription, in memory of John Henry, Duke of Rutland, who died 20th January, 1857, aged seventy-nine years." Others are put in to the memory of the late Mr. Allcard, Mr. Walters, and of Mr. Jonathan Wilson.

Before leaving the interior of this fine old

church, it will, no doubt, interest the visitor to be told in fewer words, and more correctly than could be gleaned from the strange tales sometimes told in the place, the story of the uncovering of the remains of Dorothy Vernon, her husband, and other members of the family, during the rebuilding and alteration of the church. When the excavations were commenced on the site of the monument of Sir John Manners and his wife Dorothy Vernon, the remains of two persons, supposed to be the knight and his lady, were found; the skull of the one was identified as that of Sir John, by its peculiar form and its likeness to his sculptured effigy: that of the other, which lay near it, with beautiful auburn hair still attached, among which were some pins that had been used to fasten it—was naturally, and no doubt correctly, considered to be that of the once lovely Dorothy. In another part three children's leaden coffins were found, but not opened, and the bones of an infant (probably the "chrisom child," represented on the tomb of Sir George Manners) were discovered rolled up in a sheet of lead. These, no doubt, were the children of different members of the Manners family. A leaden coffin was also found which contained the body of a lady. The part of the lid over the head had been violently torn away—the piece of the sheet of lead being missing—and this was carefully and

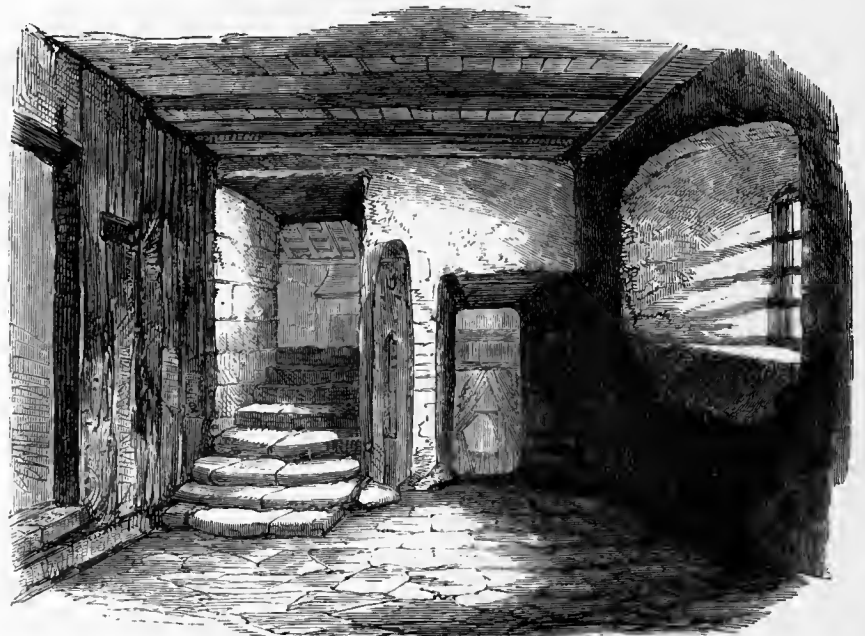

THE ARCHERS'-ROOM—FOR STRINGING BOWS, ETC.

thoroughly examined. The body had been buried in lime, but the part of the lid had been torn off, the head cut off, taken out, and surgically examined, and then hastily replaced, but with the face downwards. The rest of the body was undisturbed. Several other bodies were, of course, found, as were some few other interesting matters which require no notice here.

In the churchyard, near the east wall of the south transept, stands one of the finest so-called "Runic crosses" in the kingdom. It is, exclusive of the modern pedestal, about 8 feet in height: the upper limb of the cross is broken off. Of this fine old cross we give an engraving. The front of the cross, which in bad taste has been turned towards the wall, is sculptured in four heights, with figures beneath arches—the upper group being the Crucifixion: the whole, however, is much defaced. The opposite side, the one shown in our engraving, is boldly sculptured, with a beautiful scroll-pattern of foliage terminating at the top in an animal, and at the bottom is a cross within a circle; on the head is a figure on horseback. The sides of the cross are sculptured in scroll-work of foliage, of much the same design as the side just described; the end of one of the limbs bears an interlaced ornament, and the other a figure. This cross, and the one at Eyam, a few miles

distant, are among the most perfect and beautiful remaining examples of the early period to which they belong.

If the tourist still wishes to linger for a few minutes in the churchyard, he will find much to interest, to please, and to amuse him. To interest him in examining the external features of the church, especially the Norman doorway and arcade, &c., at the west end, and the beautiful doorway of Early-English design on the south side, as well as the stone coffins grouped together in one corner. To please him, in the magnificent view he obtains of the surrounding country, especially of the valley of the Wye as it runs its zig-zag course towards Haddon; and to amuse him in reading the strange verses which occur on some of the grave-stones which crowd around him on every side, and in the church itself.*

[References are in this chapter made to several engravings which do not appear, but which will be given in the next and concluding part; they specially refer to the church at Bakewell. Generally, indeed, in these papers we have been unable to place the engravings beside the letter-press which describes them.]

* To be concluded in our next.

ROYAL SCOTTISH ACADEMY.

FORTY-FIFTH EXHIBITION.

THIS Exhibition, which opened on the 15th February, was inaugurated by the usual banquet on the previous evening. Principal Sir A. Grant, in the course of his speech, remarked that the early history of the Academy, as it had been recently set forth by Sir George Harvey, was a record of struggles; jealousy and prejudice having opposed its progress on the one hand, while the Government viewed it with coldness and misunderstanding on the other. Now, happily, these conflicts were over, the members had secured an honourable status, and a fair field for the display of their talents; while the young aspirants who gave hope of future distinction were many and various.

One thousand and ninety-four works are before us—the product (hand and brain) of five or six hundred men and women more or less gifted: we will examine them in detail, so far as space can be found for the purpose.

Passing over Maclise's 'Sleeping Beauty,' which made its mark many years ago, a very prominent picture is 'After the Battle' (467), by R. Herdman, R.S.A., painted on commission for the "Association for the Promotion of the Fine Arts." The subject is painful. A man in the flower of his strength lies upon a bed hastily constructed of old chairs in a lowly cottage. Sorely wounded in some recent fray, he is manifestly near the end of that other battle common to us all. The surrounding figures are variously expressive of emotion. The father sits nerveless in the stupefaction of sorrow, the mother bends lovingly to wipe the poor damp head on which the dew of death is fast falling; while the wife, totally overcome, throws herself on the body in the eloquent *abandon* of misery. The colouring is chaste and the scene impressive. A young artist, W. E. Lockhart, continues to fulfil his early promise in his 'Spanish Venta' (1). The muleteers, who are about to leave a small hostelry and resume their journey through the wild Sierra, are well grouped. One coarse fellow has the wine-flagon at his mouth, another puffs his cigar, while an attendant damsel of bronze complexion shows her white teeth in a pleasant smile at their departure. There are sundry accessories—an old man at his dinner, and a child playing with a rabbit; the distance, in which a rude wayside-cross is discernible, is ably indicated; and there is no crowding of objects to confuse the eye. Want of finish, however, is perceptible, and the faces are even more roughly painted than their individuality requires. In the wide canvas, 'Wishart preaching against Mariolatry' (557), by W. F. Douglas, R.S.A., we do not find the treatment equal to the theme. The principal figure lacks requisite energy and dignity. There is a huddle in the grouping, and the profusion of bright colour does not blend harmoniously. 'Brought in to Die' (380), by the same hand, is in better taste and tone. The female prostrated before the crucifix at sight of her disabled lord, though bordering slightly on the theatrical, is well conceived. 'Van Tromp's Duel' (48), J. B. Macdonald, A., is an odd incident skilfully told. Coolly smoking his pipe, sits the hero on the gunpowder-barrel, while the advancing figure catching the summons for "the bravest man to come and set fire to it," draws back in consternation at the challenge. Sir George Harvey, P.R.S.A., contributes a fine landscape, 'Inverarnan—

Head of Loch Lomond' (355), conveying with quiet power a sense of nature's royalty. His 'Far from Home' (441)—in which a female wanderer, weary and disconsolate, is sitting, yet not resting, on a wide moorland, gazing far into the grey horizon—is full of suggestive feeling.

Besides his interesting work, 'Adrift' (327) (commended in the London Academy last year), W. M'Taggart, R.S.A., has a pretty fancy of a little maiden, 'Amy' (580), fresh and tender; an excellent head of 'An Old Fisherman' (165), and more particularly, the 'Two Children of James Stevenson, M.P.' (573). These last are charming, not as mere likenesses, but ideal transcripts as well. Here is childhood revealed through a golden lens, and yet fidelity to nature is unimpaired. Of similar character is the 'Edith' (335) of Otto Leyde, A., whose portraiture by the way is ample, and always infused with the imaginative quality that so enhances their value. We are happy to see that foreign subjects are being studied by some of our best artists, after the example of the late John Phillip, R.A., whose 'Signal' (361), a lady about to drop a camelia from a balcony, is here surpassingly beautiful. This gem was bequeathed by the deceased owner to the town of Stirling. Keeley Halswelle, A., triumphs in his 'Pilgrims at the Scala Santa, Rome' (1029). The 'Sketch,' as he modestly calls it, is in water-colours; yet it has all the elements of a fine picture, which we hope he will yet reproduce in a finished form. The figures are replete with interest. The poor prostrate creatures wildly embracing the cold stones, the woman holding the child, her eyes gleaming with earnest rapture not of this world, the old man tattered in garment, but solemn and erect of demeanour, the girls quietly telling their beads, the holy adjuncts befitting place and circumstance, altogether form an admirable exposition of Roman Catholic devotion, faith, superstition, idolatry—call it what you will. J. Pettie, A.R.A., contributes his 'Touchstone and Aubrey' (333), seen last year in the Royal Academy. What singular fancy has taken R. Gavin, A., to fill his canvases with mulattoes and quadroons? Truth to tell, they are more curious than pleasing. Yet decided talent is shown in the 'Mulatto Flower Girl' (23); and firm handling, with fine solid colour, in 'The Toilet' (101). Of the four contributions of J. Archer, R.S.A., we prefer 'The Council (not Ecumenical) Interrupted' (485). Some little girls, seated, in joyous freedom, on the meadow grass, have their pic-nic hastily intruded upon by an older sister who delivers an unwelcome message. They must disperse, the day's amusement is over. 'The Heather-Gatherers, Surrey' (246), is firmer in tone than is usual with this artist, and the fading light is sweetly rendered.

R. T. Ross, R.S.A., has a most agreeable cottage interior, entitled 'Sunshine' (238). If humble homes were always as bright as this, there would be fewer shadows in the life of the labouring man. The father, who has just come home, is tossing up the cherub newly lifted from the cradle, the young wife rises to put aside her wheel, the tea is ready on the board near which sits the cheerful grandmother; and were it not for a certain pinky paleness of tint, we should absolutely find no fault at all with this bit of household 'Sunshine.' The same hand shows versatile power in 'The Salmon Fisher' (845), where everything is conscientiously detailed, down to the heavy "tackets" in the youth's jack boots, and the basket of trout he has just captured from the Tweed. R. Ross, Jun., treads dutifully in his father's steps. There is a humorous touch combined with careful paint-

ing in 'Tastes Differ' (198). A town-bred girl is receiving a visit from a country cousin, and the point of interest centres on the contrast of costume. The middle-aged female, with the antiquated gown and traditional coal-scuttle bonnet, looks somewhat doubtfully on the fashionable finery displayed before her; and the total want of affinity on the subject of dress between the two parties is sufficiently amusing. We thank James Drummond, R.S.A., for an interesting view of 'Cardinal Beaton's Palace, Edinburgh' (287), lately demolished under the City Improvement Act. The architectural drawing is excellent, with picturesque effect. W. F. Hole is a rising painter, and aims at originality in his themes. 'Gutenberg at work in the ruined Monastery' (488), is admirably conceived. The renowned "inventor," enconced in the dusky cloister, surrounded by the mysterious implements of his art, the dim light slanting on his red robe and thought-worn countenance, eloquently reveals the time, tide, and circumstance; while 'The Betrothal' (640), an eastern scene, full of soft light, gives occasion to fine rich colouring, where the lovers plight their troth beneath the palm and acacia. 'Cottars digging Potatoes' (70) is a simple episode of rural labour, fresh and vigorous, upon which we congratulate W. D. McKay. John Dun's 'Country Wedding' (73) wants animation; and though the foreground figures are characteristic, there is a general overcrowding, and the colour is weak. We linger amused over 'They couldn't say their Carritch' (297), by E. Nicol, A.R.A., R.S.A. How the forcible hand of the Irish master speaks in every limb and lineament of these triant youths, "kept in" by reason of their defective theology! 'Not in sight' (141), by J. A. Houston, R.S.A., is a clever specimen of his buoyant style. We feel the breeze on the sunny sea-beach, where the boy and girl strain for the first glimpse of their father's boat. Hugh Collins surely rises early and sits up late; his 'Head of a Child' (223) is beautiful in *pose* and expression; but his largest and best work is 'Horses drinking in the Burn' (715), readily purchased as soon as exhibited. W. Proudfoot is very successful in his twin illustrations of 'Huntingtower Castle' (273 and 496). The old stones, alive with moss and weeds, in the giant battlements; and the crumbling desolation of the Banqueting-Hall, allure the mind to suggestive thought. 'The Day's Work done' (253), by G. Hay, A., where the tidy woman is washing her hands in token of labour finished, is clever; and better still is the same artist's 'Dainty Fare' (293).

P. A. Fraser's interior, 'Idleness' (395), is certain to be a favourite. A female domestic, neglectful of her duty, has fallen asleep in an easy-chair in the half-arranged room. A book she has been trifling over lies on the floor, and the only thing wanting is the face of the angry mistress at the door ready to pounce upon the culprit. J. Bamborough's 'Doubtful Bargain' (535) is one of the few subjects in the humorous vein upon which artists seldom venture. The women coquettishly choosing a looking-glass is a sly hit at female vanity aimed with good effect. There is much sweetness, albeit the colour is rather crude, in R. Sanderson's 'Among the Tombs' (741): the children at play amid man's last resting-place are as gleesome as if they trod on flowers, not graves. What is place to them? what do they know of death? We are attracted by 'The Showman's Child,' E. Douglas (752). The weary girl, in her light ballet-attire, has thrown herself to sleep in a rude corner behind the caravan. A sleek, intelligent pony stands on faithful guard beside her; a mischievous

monkey looks down from the roof of the machine, while a tambourine, cards, and other accessories of the showman's trade, are scattered about. It is one of those episodes of our multiform life where the gay is strangely blent with the sad. 'Reading the War News' (740), W. F. Vallance, discovers a group of fishermen variously posed, very truthful, and carefully painted. T. Faed, R.A., H.R.S.A., confines his kingcraft to some wonderfully quaint fragments of front doors, and interiors of humble old grannies and their kindred about Loch Long; while Sir Noel Paton, R.S.A., makes his sole appearance in 'The Commander-in-Chief of the British Forces in the Crimea, and Staff; Jan., 1855' (827); little more than an outline of skeleton Death, on a skeleton horse, surrounded by famine and disease, all set triumphant in battle-array. The old idea, we need scarcely say, is here wrought out with all this great draughtsman's customary power.

We must not omit allusion to the 'Author' (466), presumably Sir W. Scott, by W. S. Watson, R.S.A. It is good, solid work, and by far the best we have seen from his hand. Of lady-artists of the *genre* school, Mrs. Charretie deserves mention for the exceeding grace of her figure in 'Grapes' (698); and for the rich telling colour in 'Zuleika' (709). 'A Saw-mill Yard' (1070) is very creditable to Miss J. Frier; and Miss C. Ross shows herself something more than an amateur in her 'Amateur Artist' (853). Miss M'Whirter brings an approving smile to the lip by her 'Panegyric on Folly' (889). It is a squib on the girl of the period, which, though scarcely coming within prescribed artistic rules, is quaint and clever.

The landscapes are manifold as the moods of the mind. Every diversity of season and scene is laid under contribution; and despite the fatigues of rail or steamer, we glide from one climate and country to another, and feast our vision on the wonders of many lands. It is interesting to study the various modes in which different intellects deal with nature; how the poetry or the prose of each individual temper first selects, and then tones, his subject. For example, let us turn to 'Standing Stones on Mauchrie Moor' (2), by J. McWhirter, A., and observe the solemnity breathed over a theme which with commonplace management had proved tame. See also his 'The Monastery—Moonlight' (495), where the solitary monkish form paces the old court; we pause in meditative sympathy, and catch the echo of the vesper-hymn. More subtle still is the influence of J. Farquharson's 'Homeward plods his Weary Way' (603). The twilight effect over a wide tract of bleak country, relieved by the single figure creeping along, bent with exhaustion from the long day's toil, is impressive as a choice stanza of one of our ancient poets. A. Pcirgal, R.S.A., is conspicuous in this respect. We are glad to notice too that he has this year left the beaten path of the West Highlands, and introduces us to new latitudes. His Norwegian experiences are a pleasant change, especially 'Romsdal, Norway' (720), a scene wild and magnificent as any in Caledonia, and requiring a bold pencil to do it the justice it has here met with. Equally prolific, Waller H. Paton, R.S.A., revels in the beauties of his own Scotland, and delights us with the summer glories of wood and stream, by sun or moon, in her favourite retreats. What can be lovelier than the 'Outlet of Loch Achray—Summer Evening' (221), where the evening splendour is melting into sapphire twilight, and dewy peace rests upon hill and glade? What prospect more romantic than

'Knock Castle—Sound of Sleat, Skye' (154), with castle, crag, and ocean bathed in the moonlight sheen? It is over Arran, however, *par excellence*, that Mr. Paton loves to wave his wand; and so worthily does he use his power that we would have him elected painter-laureate for that mountain-island.

W. B. Brown's 'Neidpath Castle, on the Tweed' (296), is the very spot one might choose for autumnal meditation, so soft is it and grave in tone. J. Docharty gives us the clouds and the mists of our own weeping skies in 'Loch Eck' (173), and 'Loch Etive' (134); his 'Glen Masson' (249) is a grand exposition of mountain and flood. 'Ben Venue' (566), by A. Fraser, R.S.A., is a dream of something fairer than this world can show; and Miss M. Macnee's 'Cape Garajáo, Madeira' (606), a moonlight scene, is rendered with such tender feeling, that we regret to find it her only contribution. The majority of pictures exhibited by J. Cassie, A., are private property, and of these, as a rule, we refrain to speak. His 'Big Guns on the Tay' (284) is not of sufficient interest to fill so large a canvas. It is pity so excellent a painter should spend time and labour on inanimate matter no more suggestive than nondescript cannon. S. Bough, A., is charming as ever in the breadth and depth and height of his scenic utterances. And though we submit he has nothing so fine this season as his 'Borrodaile'—the picture engraved in the *Art-Journal* of February last—yet the 'Sunny Day in Iona' (152), and 'A Highland Glen in Rosshire' (225), leave a mark on memory not soon effaced. J. Adams has a clever cattle-piece, 'A Border Raid' (682), spirited and firm. That amphibious sportsman, 'The Duck-Hunter' (900), paddling his solitary boat among the reeds and rushes, is very creditable to R. M. Ballantyne. A whimsical fancy had seized R. Cowie, Jun., to shape that 'Enchanted Castle' (278), in the clouds, so like to a cloud itself; yet it is a pretty fancy withal, and sets one a-thinking. The notable sea-pieces are from the studios of E. Hayes, H. K. Taylor, C. A. Lodder, and some others; the stiff breezes, dashing waves, and straining masts affording ample scope for their peculiar powers. There is a paucity of female-portraits. That of Lady Don-Wauchope (505), by R. Herdman, R.S.A., is by far the most attractive. But Norman Macbeth, A., rises in esteem for his admirable 'Presentation Portrait of the Rev. Dr. Fairbairn, Free College, Glasgow' (332). From J. M. Barclay, R.S.A. Elcct, we have four proofs of increasing skill; while George Reid, A., along with force and fidelity, as in the portrait of Dr. Keith, (89), superadds the finish of fancy, so delightful, in 'Dorothy and Lucy, Daughters of A. Macintosh, Esq., Colearn' (231). The greatest work of D. Macnee, R.S.A., is the full-length of Sir A. Grant, Bart., painted for the University of Bombay (261). The figure has dignity without stiffness, the face is affable and intelligent apart from pretence, and the result is elevated and expressive. The sculpture consists principally of busts by W. Brodie, R.S.A., J. Hutchison, R.S.A., W. Mossman; &c. 'The Tryst' (789), by W. C. Marshall, R.A., H.R.S.A., is beautiful; as is also 'Charity' (775), the meek-eyed, W. M'Gillivray. 'A Roman Dancing Girl' (809), by J. Hutchison, R.S.A., strikes us as somewhat heavy in the proportions. But a few words on Mrs. D. O. Hill's 'Aziola' (810). The girl holding the "wee howlet" is all grace, innocence, and sweetness, most lovely and lovable. The work is elegantly executed in marble, and claims high rank for this very talented artist.

VISITS TO PRIVATE GALLERIES.

THE COLLECTION OF WM. QUILTER, ESQ.,
LOWER NORWOOD.

AN Art-collection, consisting exclusively of water-colour works, would in earlier days of picture-collecting have been a phenomenon: and would also be wanting in many points which distinguish modern gatherings of the same kind. The collection, of which we have now to speak, comprehends several hundred works, all doing honour to the reputation of the eminent men whose names are attached to them. It will at once be understood that the contents of a catalogue so numerous could be satisfactorily set forth to view, only in a house specially designed for such a purpose. Mr. Quilter's dining-room is hung almost entirely with works by David Cox, among which are some of the grandest essays of the artist—essays that have respectively marked the years of their exhibition as *anni mirabiles*. Cox's drawings (finished and sketches) amount in number to nearly two hundred and fifty; to some of these we turn at once. We have looked at him through many a murky cloud and much driving rain, but we now take a turn with him on the 'Terrace—Powis Castle,' in order to be able to negative the vulgar supposition that he never saw a fine day. It would be difficult to suppose that Cox had any honour save in his days of drenching rain, and the massive drifts of his tumultuous cloudland; but here we have a drawing of which the sentiment is never reached in scenic effect. In substance, it presents a portion of the castle, along which extends the Terrace, whence rise high the towers and walls. The life of the situation is a company of ladies and gentlemen on the terrace. The tint is generally a warm glow, which pervades the drawing, but without falling anywhere into the weakness of monotony. This drawing stands apart from Cox's works generally, and proclaims him gifted with a power which, from his other productions, would never be attributed to him. In its particular feeling it is the most graceful production the artist has ever put forth.

Cox was very fond of flat scenery, to which he imparted an inconceivable charm by his command of the means of expressing distance. Subjects, moreover, of this kind left him a wide field upwards to deal with that part of his landscape in which he was always so great. In those really grand pictures to which he has given simply the names of the trees that are prominent objects in the landscape, as 'Birch' 'Elm,' &c., we recognise the exertion of Cox's supreme powers. From the titles, it must not be supposed that the form and character of the tree was the proposed study, although it is described in a manner surprisingly true when we remember the artist's fluent method of working. 'Soldiers on the March,' is another of those large drawings wherein he has constituted the sky a composition of vast sublimity, to which the homely landscape presents a very effective foil. Differing in everything from these, 'Hay-making,' certainly one of those works by which he will be remembered, shows a summer-sky and a sunny plain, presided over by stately piles of *cumuli*. This drawing charms us not more by what it sets forth than what it suggests. In 'Deer Stalking in Bolton Park,' also an important work, the artist again reminds us of his prevalent impressions. In a piece of very wild scenery, dominated by a lowering sky, we see in the distance a group of deer, and the sportsman screened behind a near rock waiting for the favourable moment. The drawing entitled 'Old Mill and Moor,' has afforded an opportunity for a display of that power in the possession of which this artist stood almost alone, we mean the expression of distance. The subject is simple, but the drawing can never be otherwise than of value as a triumph of Art.

Much as we may desire to dilate in circumstantial descriptions of these magnificent works, they are so numerous it would be impossible even to note the titles. Cox never signalled himself in street-architecture; but he drew, with imposing effect, the ruins of ancient castles, as also those which remain entire. Of such subjects there are, in this collection, Kenilworth, Conway, Barden Tower, Harlech, &c., also

'Beaumaris,' an admirable drawing. A 'Hop-Garden,' 'The Golden Vale, Carmarthen,' and 'Staffordshire Lanes,' are of rare excellence. So likewise are a palace on the banks of the river, 'Tamworth,' 'Highland Scenery,' 'Battersea Mill,' 'The Fells of the Ogwen.' It will be understood that in such a series by one artist, all his resources and means are shown from the merest pencil-sketch to the most elaborate production. The minor sketches and drawings are kept in portfolios and drawers.

The works by Turner are among those of his best time, as 'Ramah,' 'Rokeby,' 'Leatherhead,' 'The Pass of St. Bernard,' 'The Upper Rhine,' 'Geneva,' 'Thun,' 'Sion,' 'Cashiobury,' and the 'Tomb of Cecilia Metella.' We cannot refer to a list of Turner's works, however short, without being reminded of the beautiful illustrations which, through his means, have been sown broad-cast through our literature. Several even of these titles suggest some of the most charming landscape-engravings ever produced by any school; changed, in some degree, and modified, perhaps, here and there, but always according in one principle of transcendent loveliness, these engravings referred to drawings of unexampled splendour, though they still fall short of the drawings themselves. Let us turn to Rogers's "Italy;" we may instance Geneva, and the passage of the St. Bernard, in the latter of which Turner has appropriated David's Napoleon on his white charger. It is unnecessary to describe works so well known; no praise, however just and pointed, can enhance their value. These are all in Turner's last and confirmed manner; they are among his greatest successes, and afford us glimpses of this world rather as it should be than as it is.

In the subjects mentioned below, the mental resources, mature judgment, and rare executive skill, of G. Cattermole are fully set forth. They point immediately to the sources of their inspiration; and although the artist allowed himself certain licenses in dealing with them, it is felt that in many cases such liberties constitute the force of the composition. Three scenes are given from Macbeth, 'The Death of Duncan,' 'Macbeth and the Murderers,' and 'The Passage of the Kings.' In the first the monarch is not seen, but we learn his whereabouts by indication. He is still on his couch, and the grooms lie in the ante-room. The point of the drawing is Macbeth's agony of remorse, which we read as well in his features as in his action. In the second subject we find Macbeth in semi-state; he receives and instructs the murderers, writhing under the dread consciousness of one foul murder while contemplating a second. The two desperadoes look fully the outcasts they describe themselves, men at odds with fortune, and clutching at any desperate chance of lawless life. Macbeth is seated on a chair of ceremony, and in the composition great use is made of drapery, which is so skillfully disposed as not to look like an expedient but a necessity.

"Ay, now I see 'tis true,
For the blood-bolied Banquo smiles upon me,
And points at them for his.—What, is this so?"

Such may be accepted as the text of 'The Passage of the Kings,' which in the rendering is limited to the prominence of Macbeth on the one hand, and the spectral array on the other. The supernatural is firmly asserted, perfectly maintained, and not embarrassed by negative accessory. The heads only of the kings are seen, the forms being lost in the fumes of the incantation. To this, 'Old English Hospitality' presents a marked contrast, as being an interior crowded with figures, among which is prominent that of the lord of the banquet. It is a scene by no means carried beyond the probabilities of a Christmas festival given by a baron of the fifteenth century to his dependants, and even strangers who have come in from the neighbouring highways—a feature which widens the circle of the hospitality. This kind of composition is a remarkable quality of Cattermole's Art. His assemblages are not merely crowds, but companies, of individuals, to each of whom is assigned a distinct and appropriate character. But at each remove we meet with famous drawings by this artist. When we say many are among his very best it will be under-

stood that even one example would make a reputation, as 'Shakspeare as a youth reciting a birth-day ode before Sir Thomas Lucy,' 'The Darnley Conspirators,' 'Trying the Sword—the Knight and his Lady visit the Armourer's Shop,' 'Rizzio,' 'Hamilton of Bothwell Haugh,' 'The Escape,' 'The Doge of Venice and his Daughter—Vesper Bell,' 'The Baron's Chapel,' 'Charles on his way to Scotland,' 'Charles at Holdenby House,' 'Douglas stealing the Keys,' and the grand Benvenuto Cellini drawing.

Copley Fielding was one of those artists gifted with second sight, the utmost power of which is shown in two directions. His works are 'Rivaux Abbey,' 'Loch Awe and Ben Cruachan,' and 'The Race of Portland.' In the two landscapes we have examples of his greatest force of mellow tints, accompanied, as usual with him, by strong masses throwing off the silvery distances which meet the eye like phantom forms begotten of the sun and mist. Again, the sea-subject—who would pronounce it as by the painter of the "rosy-fingered mom?" It shows us a small cutter, over which has just passed a storm-cloud, draping all the right section of the sky with a funeral mantle. We have attentively considered both Ruysdael's grand storm-cloud, and Turner's 'Port Ruysdael'—painted in emulation of the former,—and Fielding, it seems to us, saw both, and sat down to his work with a resolution to outdo both. It is an essay of rare excellence.

The drawings by F. W. Topham refer to his Irish experiences; they are 'Oliver Goldsmith when at Trinity College, Dublin, hearing his Ballad sung, gives his last Farthing;' 'An Irish Beggar and her Daughter at a Holy Well;' 'Little Nelly in the Churchyard,' and 'Girl Spinning.'

Very rarely do we find such a combination of extraordinary qualities as fascinates us in the works of William Hunt. His figures or his flowers would each have made an enduring reputation, for in both he is an originator and both are equally valuable. In the lowest comedy of rustic life Hunt is an accomplished dramatist; his humour is genuine without any lapse into caricature. His *personæ* play their parts with an earnestness thoroughly characteristic of their low degree. Faithful to the genuine nature of his idea, he never falls into the error of giving his impersonations a gloss out of keeping with their sphere of action. 'Gipsies at work' is a sarcastic hit at the idle vagabond life led by these people. One is peeling turnips, and the rest of the group amuse themselves in divers manners. 'Too Hot' is one of those single figure-subjects, in the endowment of which Hunt stood alone. It presents only a boy seated with a basin of porridge before him, so disposed as admirably to support the title. It is wondrously brilliant in colour, intense in living expression, and is perhaps the finest work Hunt ever produced in this vein. To turn to an instance of his power in an opposite direction, we have 'Primroses,' one of the sweetest and simplest pieces of nature ever exhibited. There is in it so little of subject, that an ordinary student of floral forms would be at a loss to carry it beyond a rough sketch, though it is here worked out to a study of infinite beauty and considerable value. And again, as showing the indescribably minute execution peculiar to this class of Hunt's drawings, the wondrous precision exemplified in 'A Bird's Nest and Primroses' has never been surpassed—no, not even in the marvellous achievements of that most fastidious of all students, Albert Dürer. There is also a 'Pine' with a garniture of other fruits, all rising to the high character of the subjects already mentioned. None of the compositions are surcharged, the material indeed is sometimes so sparse as scarcely to be called a subject; but in this way the point of the picture is pronounced with its fullest accent of hue and form, for Hunt was always most careful not to injure by competition the force of his principal object. The drawing, 'Plums,' has all the delicate beauty of nature, and not less successful is 'Fresh Garlands.' We turn again to a figure, a 'Boy Blowing Bubbles,' which in every essential point is not less careful than 'Too Hot;' but the gem of the selection from Hunt is a family of primroses on a piece of mossy bank, the finest thing of the kind that has ever been done.

Besides the works we have named, there are many others by him of almost equal merit, numbering altogether not fewer than thirty.

'Lancaster' and 'Southall' are two admirable drawings, by P. De Wint; they look like pendants, although their local constituents are of a different nature. Both are earnest and simple, and, although sufficiently substantial in all, have yet a large proportion of the silvery sparkle whereby De Wint was wont to relieve his prominent objects. They are long drawings, somewhat panoramic in form. Of 'Lancaster,' we see the castle, the river Luns, and the bridge; beyond which the eye passes to a remote distance, over the sands and flats on the coast to the right. 'Southall' is simply a canal-view; but the water, with its sedgy brink, is treated in a manner to give it all the significance of a river. These drawings possess points of interest which rank them among the best of De Wint's works.

Those who have not seen Prout's 'St. Pierre—Caen' can scarcely estimate his powers in breadth of effect. It is the back view of the Cathedral, with adjoining buildings, as seen from the right bank of the little river Orne which flows under the High Street. Other works, into which a high degree of finish and refinement are wrought, are 'The Bridge of Sighs,' 'Augsburgh,' 'Cross and Buildings,' 'Crypt,' &c.; church-porches, fragments of architecture, all of which, with ingeniously constructive skill, are rendered into pleasing drawings. Of Prout's works, altogether, there are forty-two.

The drawings of David Roberts, R.A., represent, in their manner, different periods of his career—as, 'Abbeville Cathedral,' 'Granada,' 'Jedburgh,' 'Whitehall,' 'Rhonda,' and 'Gate at Petra.' 'Abbeville' and 'Jedburgh' have, we believe, been engraved, and belong to his early period. They are distinguished by that imposing character which he succeeded in giving to all his architectural studies. 'Rhonda' is one of his Spanish series, and the 'Petra' subject is one of that grand series he brought home from the Holy Land, and which was published by Alderman Moon. The permission to visit the ruins was purchased of the particular tribe of Arabs that then held the place, and, as soon as the term agreed on had expired, Mr. Roberts and his escort were stoned out of Petra.

It is not often we meet with any of John Varley's works. There are some half-dozen here—two 'On the Thames,' 'Eton College,' and one of the remaining three is a composition in which are found all the dignity and elegance that were peculiarities of the artist.

By C. Stanfield, R.A., are five drawings. They are 'Lago Maggiore,' 'Santa Maria della Salute,' 'St. Michael's Mount, Cornwall;' the two others are Italian subjects. In these sketches there is as much of sparkle and daylight as in Stanfield's finished oil-pictures. The facility and decision of their manner are very captivating.

'A Fish Girl—Newhaven,' by F. Tayler, is not of the kind of subject-matter by which Mr. Tayler is most favourably known: this, however, and the pendant example, 'A Fisherman,' are perfect instances of his single-figure studies. When, however, we turn to 'The First of September,' which alludes to the commencement of partridge-shooting, there appears at once material of the kind on which Mr. Tayler has built his well-merited reputation. In the generic description of sporting-dogs he stands alone. His 'Highland Drovers,' 'Cattle and Figures,' are also valuable examples of his free, but always certain, manner. 'The Ferry-boat,' as a sketch, is masterly; further finish would be insufferable.

'The Brewers' Hall, Antwerp,' is ever memorable as one of the most remarkable drawings of its author, Louis Haghe; of whom it is but scant justice to say, that he never exhibited a work against which carelessness in any degree could be charged. His other productions here are 'An Interior' and 'An Exterior—Winter;' the latter a drawing of much interest.

One of the grandest essays in the collection is 'The King's Trumpeters and Kettledrums,' by J. Gilbert. Strikingly original and brilliant, it represents a portion of the mounted band of the guard of Charles I. By the same artist there is

a second drawing, of which the subject is 'The Duke of Gloucester and the Murderers,' an extremely difficult subject to invest with the very pointed character necessary to its interpretation; but it has been treated so successfully, that there is not a second thought as to the actors in the scene.

The substance and finish of Carl Haag's works are so captivating that we are never weary of looking at them. In this collection there are—'Pifferari,' 'A Tambourine Girl,' 'A Tyrolese Huntsman,' and a female figure, exhibited in 1858, and again, at Munich, in 1859. There are also two caravan-scenes, results of Mr. Haag's experiences in the Desert: they are, 'The Arrival at Palmyra' and 'Leaving Palmyra.'

There are six really precious mementoes of the late James Holland—precious because showing the best points of an artist who was a brilliant star in two constellations. The simple word 'Roses' points to a group of flowers which, if not the finest flower-study he ever made, has at least never been surpassed by anything from his hand. His other subjects are, 'Venice,' 'Scene in Venice,' another Venetian view, and a drawing of flowers. Holland's 'Venice' beckons us back to that mysterious city of the sea, the history of which is a romance.

By Birket Foster is a masterly drawing called 'Storm and Rain,' and three others—'St. Goar on the Rhine,' 'Saltburne,' and 'The Cottage,' and by W. Bennett, 'The Giants of the Forest,' 'Hastings,' 'Lochl Clair,' and some others very powerful.

The simple water-colour drawings of P. F. Poole, R.A., are really more attractive than his similar small groups in oil, although we now see but few of either. These, we believe, have been the successes of his studentship; they present generally, only it may be, a young mother and her child grouped in an open landscape—the whole charming in colour and feeling. Thus the specimens here are, 'A Mother and Child' and 'A Girl at a Spring'; the harmony, beauty, and sparkle of which leave nothing to be desired, save that Mr. Poole should produce more of such works. It is by no means a condescension for an artist of high aspirations to paint such pictures, for to compare small things with great, they contain qualities entirely distinct from those of Mr. Poole's large works.

A drawing by J. F. Lewis, R.A., 'A School at Cairo,' is a valuable instance of that microscopic elaboration which characterises his eastern studies. We stand before this drawing contemplating in wonder that singular care with which, especially, household-material is realised. It is conspicuously set forth in this composition, of which the entire complement—figures, garniture, and local accessories—is made out with an inimitable precision of line and surface. The living element is a grave and learned Turk presiding over his thin class of young pupils. The truth of the situation may be accepted as incontrovertible, but the means by which it is asserted would, as a proposition to most ordinary practitioners in Art, be simply heart-breaking. There are also by Mr. Lewis, 'Caged Birds' and 'An Eastern Girl.'

W. Müller is represented by drawings immediately referring to different periods of his career, which was comparatively brief, yet he worked so rapidly and diligently that his labours were very productive. His examples of home-scenery are unassuming, but firm, and sometimes a little hard in manipulation. They are called 'A Windmill,' 'Landscape—Winter Scene,' 'Farm House and Cattle,' 'Woody Landscape,' &c. 'The Tomb of Francis II. at Nantes,' 'The Château of Brisac,' refer to his tour in France about 1843, which produced his valuable series of Renaissance Remains and Decoration; and his drawings of 'Lycia,' 'The Wandering Tribes of the Desert,' 'Ramah,' 'Pinará,' refer to his last sketching tours.

By E. Duncan are some drawings of infinite beauty—the subjects simple enough but ennobled by the terms of their interpretation—they are a 'Harvest Field,' 'Gathering Vraick,' a distant view of a city, 'On the River Lea,' 'Rye, from Romney Marshes,' &c. 'Venice,' by J. D. Harding, reminds us of his sketches at 'Home and Abroad'—it has quality equal to that of his best works. By E. W. Cooke, R.A., are

'Dover,' 'Ramsgate Harhour,' 'Dover Harbour,' and 'Fishing Boats,' and in the same department, by G. Chambers are 'Hulks,' 'On the Thames,' 'Cheyne Walk, Chelsea,' and a 'Sea-piece.' 'An Indian Beauty,' 'An Eastern Boy,' 'A Spanish Girl,' are the titles of three of the four head-studies by E. Lundgren. Some of the names of the following artists may not be known to the present generation, though their works hold their own with the best of those of the living school: 'Highland Scenery,' G. Robson; 'Marine View,' J. Owen; 'Beach with Fishermen,' S. Austen; 'Village Choristers,' J. M. Wright; 'Rannock Moor,' G. A. Fripp; 'Old Hall,' J. Nash; 'Diana,' W. E. Frost, R.A.; 'Heidelberg,' T. M. Richardson; 'Cattle,' W. F. Witherington, R.A.; 'Italian Composition,' W. L. Leitch; 'Venetian Scenery,' J. Callow; two drawings by Bonington, &c.

Every available inch of space in Mr. Quilter's rooms is covered with drawings of the rarest excellence. In addition to those on the walls very many others in portfolios and drawers are worthy of a long complimentary essay to themselves—and how impossible this is, it is not necessary to point out. In a collection so numerous, little more can be done than to note the titles, with the name of the artists.

PICTURE SALES.

THE collection of paintings and drawings left by the late Mr. J. B. Pyne was sold by Messrs. Christie, Manson, and Woods, on the 25th and 27th of February; the number reached nearly 400, but no work was disposed of at a price worth special note.

Upwards of 160 paintings and drawings by British and foreign artists were sold in Messrs. Christie's rooms on the 4th of March: the works were collected together from different sources, and the principal examples were:—'The Beggar-Boy,' a drawing by F. W. Topham, 110 gs. (Jones); 'Wreck near the Corbière Rocks on the Jersey Coast,' a drawing by E. Duncan, 150 gs. (McLean); 'May-Day,' a drawing by Birket Foster, 265 gs. (Williams); 'The Black Boy,' W. Hunt, also a drawing, 115 gs. (McLean). *Oil-pictures*:—'The Cherry-Seller,' G. Smith, 145 gs. (Baldwin); 'On the Rhine, near Bonn, looking towards the Drachenfels,' C. Stanfield, R.A., 138 gs. (Cox); 'Paris and Helen,' F. R. Pickersgill, R.A., 168 gs. (Cox); 'York and Lancaster,' and 'The Garden Close,' a pair of charming flower-pieces by Miss Mutrie, 150 gs. (Holland); 'Andromeda,' W. E. Frost, R.A., 140 gs. (Tooth); 'Carshalton Mill, Surrey,' P. Nasmyth, 265 gs. (White); 'New Wars to an Old Soldier,' T. Faed, R.A., 325 gs. (Agnew); 'The Nutting Party,' W. Collins, R.A.; this picture was the gem of the day's sale; it was painted for the late Rev. R. A. Thorpe, and is referred to at some length in the biography of the painter by his son: the picture excited keen competition, and was knocked down for 945 gs. (Agnew). 'An Interior'—view of a bird and dog-fancier's place in Bristol, W. Müller, 140 gs. (Warne); 'The Spaewife of the Clachan,' J. Phillip, R.A., 200 gs. (Mendoza). The following foreign paintings were the property of a gentleman of Paris:—'View from St. Mark's Quay, Venice'—looking towards the Dogana; and 'A Canal Scene, Venice,' a pair by G. Ziem, 150 gs. (Gordon); 'Rocks in the Forest of Fontainebleau,' and 'The Forest of Fontainebleau,' a pair by Diaz, 140 gs. (Rutley); 'Cows in a Shower,' Troyon, 240 gs. (Harrison); 'A River-Scene,' and 'A Woody River-Scene,' a pair by Jules Dupré, 570 gs. (Permain). The remaining four examples came from the collection of the late Mr. Henry Boden, for whom they were painted:—'A Highland Scene,' sportsmen reposing, with dogs and game, R. Ansell, R.A., 305 gs. (Lee); 'An Avenue,' with figures and a dog, T. Creswick, R.A., 125 gs. (Johnson); 'A River Scene,' with a watermill, T. Creswick, R.A., 145 gs. (Bartlett); 'Landscape,' with figures crossing a rustic bridge, and a dog at the brook, T. Creswick, R.A., 180 gs. (Boden). The sale realised about £9,000.

SELECTED PICTURES.

FROM THE PICTURE IN THE POSSESSION OF THE PUBLISHERS.

MEN OF WAR AT SHEERNESS.

H. T. Dawson, Painter. A. Willmore, Engraver.

DESCRIBING, in the year 1866, a picture, we then engraved, by Mr. H. Dawson, we remarked that his "son, Mr. H. T. Dawson, has somewhat recently made an appearance which promises well for the future." The annexed engraving furnishes evidence indisputable of the assertion, for we have rarely seen a marine subject handled by a young artist that gives more sure hope of success: indeed, it shows qualities, both as a composition and in detailed treatment, which are generally to be found only after long and studious experience. In the two principal vessels lying at anchor on the Medway we have placed in juxtaposition two noble specimens of naval architecture, each respectively typical of the art that seems to be almost passing away and that which appears destined to supersede it: in other words, the old "wooden walls" of England and the walls of iron. From an artistic point of view the merits of the two ships admit of no argument: the former sits gracefully and picturesquely on the water, her sides swelling out, and bristling with lines of guns through her open port-holes; the latter very far from a "thing of beauty," but, under the present system of naval warfare, without doubt a more dangerous foe to the enemy that encounters her.

Beyond these two are several men of war of the old school, as they may be termed, laid up "in ordinary," and, in all probability, destined to remain so; at least, so far as refers to any part they may take in actual warfare. Ships of this class, we expect, have had their day, and well the naval annals of England show how nobly they sustained "the battle and the breeze." The "ancient mariners" of our country have far less faith in iron than in wood; and even the younger ones would "rather put to sea in a tub than in a copper," as a sailor once remarked in our hearing. Individual or collective courage has but little chance of distinguishing itself under the new system of naval architecture: the range and destructive power of a ship's armament, and the strength of resistance offered by her metal sides, will have, as a rule, to decide the victory in future actions. No future admiral will seek to break the enemy's line of battle by leading his ships right through it, as Collingwood did his division at Trafalgar; and no captain will succeed in laying his vessel alongside his adversary's, as did Nelson in Jervis's action off Cape St. Vincent; when he steered the *Captain*, a seventy-four, between the *San Josef*, a Spanish three-decker, of 112 guns, and the *San Nicholas* of 80 guns, and carried both by boarding. Mr. Dawson's picture involuntarily carries the thoughts back to past naval history.

To the right of the composition is seen one of the numerous Martello towers erected along the coasts of Kent and Sussex in the early part of the century, when England was threatened with invasion. Little of the town of Sheerness is visible; the greater part is concealed by the two large vessels. The action of the water is lively and natural: the sky indicates a "gusty" day; light fleecy clouds, catching the sunshine, traverse a great part, while a heavy rain-cloud is discharging its contents over the distant sea-scape.

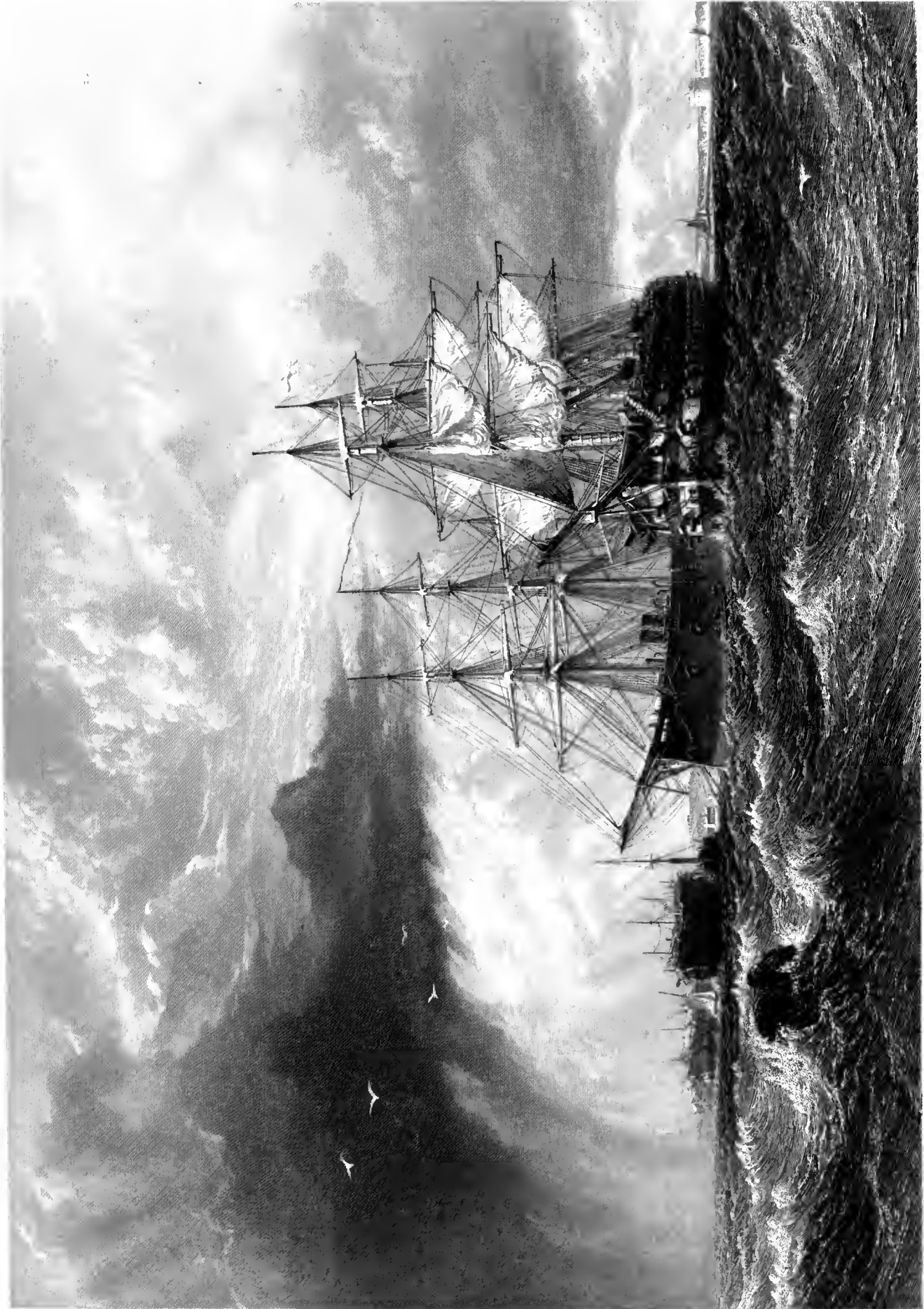

A. W. LINDSEY

THE U. S. S. ALBATROSS



THE MUSEUMS OF ENGLAND,
WITH
SPECIAL REFERENCE TO OBJECTS
OF ART AND ANTIQUITY.

BY LLEWELLYNN JEWITT, F.S.A., &c., &c.

THE COLCHESTER MUSEUM.

COLCHESTER, the *Camulodunum* of the Romans, and one of their principal towns, is a place the interest attaching to which is of vast importance. Situated on the borders of the Iceni, who owned his power, it was here that the British King, Cunobeline (so well-known to general readers by Shakspeare's embodiment of him under the name of Cymbeline) fixed his chief residence, and here that he established his mint and held his court. Here it was, also, that his sons were defeated by Claudius and Aulus Plautius, which event placed the royal town in the hands of the Roman conquerors. It was here too, later on, that Ostorius, after the defeat of the Brigantes, fixed the headquarters of the Roman power, the town being the first in this country which was raised to the rank of a *Colonia*. Under him "the city was adorned with public buildings, and more especially with a temple dedicated to Claudius, and was increased in size and importance." This temple Tacitus tells us was considered by the Trinobantes of Essex "as a kind of citadel to hold them in perpetual bondage, and the priests who celebrated religious worships in it as so many harpies who lived upon the substance of

the natives. It would be no difficult task, they thought, to destroy the Roman colony, for it had no fortifications to protect it." Before their revolt, with that of the Iceni, broke out, many signs and indications of the approaching insurrection were made apparent to the Romans; for, according to Tacitus, "At Camulodunum the statue of Nero fell to the ground, and turned its back, where its face had been, as if it fled before the enemy. Women were seen, as if mad, singing wild songs in which they foretold the destruction of the colony. Strange noises were heard in the house of assembly, and loud howlings in the theatre. In the estuary of the Thames was an appearance like that of a sunken town. The sea assumed the colour of blood, and human forms appeared to be left on the shore by the ebbing tide. All these things were of a nature to encourage the Britons whilst they overwhelmed the (Roman) veterans with terror." The few soldiers sent to the relief of the inhabitants occupied this temple, and everything but it was plundered and burnt at the first attack, and the temple itself, in which the soldiers had taken refuge, was captured after a siege of two days.

But it is not my purpose to trace the history of the town of Colchester—it is enough for me to say that it was a place of importance with the Romans, during the entire time of their rule in Britain; and that under the Saxon and Norman kings—for the castle was built by the Conqueror—it lost none of its importance; while in later ages the interest attaching to it has in many ways increased.

It will easily be perceived from these brief remarks how rich a locality it must be for the

establishment of a museum, and how prolific a mine of archaeological wealth the place must furnish. And so it is. The whole neighbourhood so abounds in interesting remains of its earlier inhabitants, that scarcely an excavation can be made in any direction without some relic, or curious fragment of one kind or other, being brought to light. The result—and an especially good result it is—is that the Colchester Museum contains perhaps a more curious, varied, and valuable collection of remains of Roman Art than almost does any other. To some of the more notable of these objects I now proceed to direct attention. And first as to the sculptures.

One of the most interesting and unusual remains is a Sphinx,—known by antiquaries as "the Colchester Sphinx,"—which was discovered while digging the foundations of the hospital. This remarkable figure, which is 25 inches in height, the same in length of the base, and 10 inches in breadth, is carved in oolite in a masterly manner, and was evidently intended for placing in the open air. It represents the Theban Sphinx seated over the mangled remains of one of its human victims. This fabled monster, here so admirably carved in stone, combines the five-fold attributes of a virgin, a lion, a bird, a dog, and a serpent, all of which are faithfully represented in the sculpture. The head, breasts, and arms, are those of a beautiful virgin; the body and teats are those of the female dog; the hinder part, hind legs, and fore paws are those of a lioness; the tail, doubled in short folds, is a serpent; and the wings are those of a bird. Beneath the body of the Sphinx lie the hand and a leg-bone of a man, and the



BRONZE LAMP.

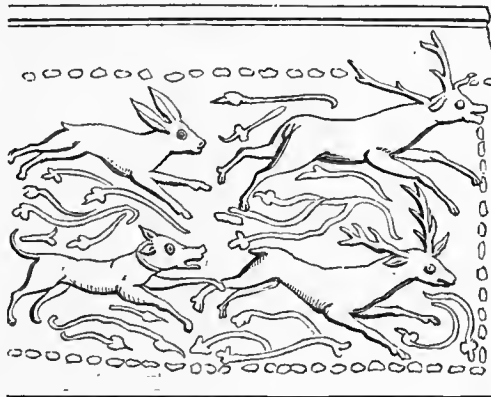

GROUP FROM THE COLCHESTER VASE.

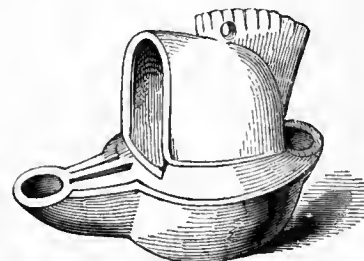

LAMP IN FORM OF HELMET.

head—with the eyelids closed in death, the corners of the mouth drawn down, the muscles strained and set, and with an expression of agony and exhaustion—lies between its arms. On the base a large letter S is cut in the stone, and is probably the initial of the sculptor or the quarry. It has been conjectured that the Sphinx may have been the emblem of *Camulodunum*, and this idea gains strength from the fact that the Sphinx occurs on the reverses of some of the coins of Cunobeline struck in that city. A small bronze Sphinx was, only a short time previously, discovered nearly on the same spot.

Another interesting stone is a sepulchral slab found close by the stone Sphinx just described. Its inscription is, however, very much mutilated; the remaining words being described as—

VIVIT
.....
LEG III AVG
LEG XX VAL V
.....
MILITAVE
VIXIT ANN

Of Roman bronzes the Museum contains many highly interesting and very valuable examples. Those most especially noteworthy are the following:—

A bust of Caligula, found in forming the line of railway about a mile from Colchester in 1845, at a depth of about five feet below the surface. It is a remarkably fine bronze, the features being

highly "characteristic of the disposition and habits of mind of this emperor, and corresponding with the descriptions which have been handed down to us of his personal appearance." The bust rests on a globe, the symbol of Roman sovereignty. The pedestal is inlaid with silver, in an elegant scroll-pattern with a pendant flower between the scrolls.

A remarkably fine head of Silenus, which has "evidently ornamented an open-mouthed vase, in form like a bucket (*situla*), the loop surmounting it having received one end of the arched handle, which passed over the mouth and fastened into the loop of a corresponding figure on the opposite side of the vase. The character of the features of the face are those of Silenus or Priapus; it has a profusion of hair, which is parted in the middle of the forehead; the beard falls in spiral curls, turning from the centre of the chin; on the top of the head is a wreath of ivy, from between which issue bunches of grapes, and two clusters fall behind the pointed ears; the countenance is majestic, though somewhat sensual in the projection of the under lip." This fine example of Roman Art was found with the bust of Caligula just described. It is 12 inches in height without the pedestal.

A graceful statuette, 6 inches in height, of Jupiter Conservator, dug up at St. Mary's Lodge, Colchester. The attitude of this figure has been described by Westmacott as "simple and dignified; the *pallium*, thrown gracefully over the shoulders, hangs over the left arm, the hand of which doubtless held a sceptre; in the right hand is a thunderbolt; the head is designed

and treated with the grandeur of manner which the type requires, but the lower limbs are coarse."

A remarkable bronze figure of Cupid riding on a sea-griffin, presented by Mr. Errington, which we engrave on a following page.

A statuette of Mercury, with a purse in one hand and a *caduceus* in the other, found at the Turrets, Colchester.

A finely executed Roman bronze bust of Pan, represented with pointed ears, and with horns on his forehead. The whites of the eyes are formed of an opaque composition; the pupils of transparent blue glass, with a darker coloured iris. It is by competent authorities considered to belong to the Augustan era, and is a fine example of Art.

A remarkably fine *prefericulum*, a *prefericulum*-vase, the handles terminating in masks, and a tripod lamp-stand, all of bronze, are also noteworthy; as are likewise some bronze handles and other remains.

Among the other bronzes of various ages are the figure of a goat; two statuettes of Hercules, with club, and lion's skin; a statuette of Mercury; two statuettes of boys running (attributed to Fiamingo); a figure of Victory, &c., &c.; and a large letter V, 8 inches in height, which has been strongly gilt, and has still attached to it the iron staples by which it had originally been fastened to the stone, it is supposed, of the front of the temple of Claudius at Colchester.

A Roman helmet found at St. Alban's, and a steelyard weight formed in the figure of a Cupid, discovered at Colchester, are also noteworthy.

The ancient pottery found at Colchester, and exhibited in this Museum, is perhaps one of the

most extensive, as it certainly is the most interesting, collection in any provincial museum, and presents among its treasures examples of most of the known wares, as well as varieties of vessels. For instance, among the Roman and Romano-British wares are fine examples of Samian; of imitation or English Samian; of Durobrivian or Castor ware; of Upchurch ware;

of Salopian and Yorkshire wares; and what is peculiarly interesting, a number of vessels of Colchester manufacture, made at the Roman pottery which existed on the left side of the Lexden Road, where a kiln and many other remains have been discovered. This discovery is noted in the "Collectanea Antiqua" of my friend, C. Roach Smith, who has done so

much to illustrate and preserve records of the Roman remains of our country. To some of the more striking of these fictile remains it may be interesting to draw attention.

The most notable of all is the Romano-British vase, known most appropriately from its unique character as the "Colchester Vase;" this we engrave, as well as one of the ornamental designs.



SEFULCHRAL DEPOSITS FOUND AT COLCHESTER.

This very remarkable urn, which is 9 inches in height, and 7 in diameter, was found, in 1853, at West Lodge, Colchester—a locality well known as occupying part of the site of a very extensive Roman cemetery which bordered the road from Londinium to Camulodunum—and was presented to the Museum by Mr. John Taylor. It formed the chief of a group of vessels in a sepulchral deposit, and was used as a cinerary urn, being filled with burnt bones and ashes. When found it was covered by a *mortarium* which was inverted over its mouth, and thus formed a lid to the urn; by it stood a *patera* of Samian ware decorated with ivy leaf on its rim, wherein was a bottle of straw-coloured pottery. The urn, which is of Durobrivian (Castor) ware, the figures and ornaments being laid on in "slip," is covered with bas-reliefs representing subjects of very different character, but all referring to sports and scenes in the arena. The central group is a scene in a combat between two gladiators, a *Secutor* and a *Retiarius*. The *Retiarius* has been vanquished; he has dropped his trident, and raises his right hand to implore mercy at the hands of the spectators. The *Secutor*, armed with a close helmet, and an oblong shield and sword, is advancing on his conquered adversary to strike the fatal blow, unless his arm is stayed by the merciful voice of the assembly. The costume of both is strictly correct, and as well executed as the nature of the material would allow. "The manner in which,"

says Mr. Roach Smith, "the leg and arm are protected is shown with care and minute finish, even to the nails in the shoes; the peculiar fylfot ornament upon the shield, which often occurs upon the monuments of the Ælian Dacians, quartered at Amboglanna on the Roman wall, is also worthy of notice." The



SEFULCHRAL DEPOSIT, COLCHESTER.

group to the right represents a very popular performance among the Romans—and indeed in later times—that of a bear-tamer and his trained bear. The bear, in this case, is shown between two men, the bear-ward and his attendant. The dancing or performing bear appears either to have become rebellious, or to have put on such

an appearance as a part of his trained performance; and the bear-ward, whose legs are protected with bands of metal or leather, and whose left arm bears a shield, holds in his right hand a whip with which he is lashing the bear, the strokes falling across its head. The assistant, armed with two sticks, is approaching on the other side. The group to the left is a hunting scene, in which a dog is chasing a hare and two stags, the animals being interspersed with foliage. The most remarkable feature in this urn is the inscription, cut with a *stylus*, which occurs over the figures. Above that of the *Secutor* in the gladiatorial scene are the words MEMN · N · SAC, viii., which Mr. Smith explains as "Memnius (or Memnon) numeri secutorum victor ter," meaning, Memnius (or Memnon), of the *numerus* (or band) of *secutores*, conqueror thrice; and over the head of the *Retiarius*, VALENTINVS · LEGIONIS · XXX, e.g., "Valentinus of the thirtieth legion," which was doubtless his name. Over the head of the bear-tamer with the whip are the words SECUNDVS · MARIO, the meaning of which is not very clearly ascertained. The skill exhibited in the production of this beautiful urn will be better appreciated by the visitor, when he remembers that the figures and ornaments were not formed in a mould, but were laid on by the potter, by hand, with a "slip" of thin clay, and modelled with a kind of blunt skewer: the lettering being scratched in with a *stylus* or other sharp instrument.



SEFULCHRAL DEPOSITS FOUND AT COLCHESTER.

Of Roman cinerary urns there is a very considerable collection, embracing most of the usual varieties. Among these are urns of dark-coloured clay, and of hard red ware; some of the latter of which have handles on the sides, and others, of both varieties, have covers. Many of these are what may be called jar-shaped. Others are of a coarse dark-coloured clay, and

others again of a light fawn colour, while some are of glass. There are also several drinking cups and other vessels used both for domestic and for sepulchral purposes. Indeed, the Colchester Museum is without exception one of the richest in any locality in sepulchral urns of the Romano-British period.

One of the most curious and important

features of the Museum is the large assemblage of TILE-TOMBS, and the sepulchral groups they, and other interments, contained. These are all worthy of the most careful and extended examination. Among the more noteworthy of the tile-tombs are the following. A tomb formed of six tiles, containing three *unguentaria* and a cinerary urn of black clay, lying on its side,

filled with burnt bones. A tomb formed of two upright tiles, supporting a stone covering stone, and containing a cinerary urn and two *unguentaria*. A tomb formed of six tiles, containing a leaden cist of cylindrical form with the cover soldered on, which contained burnt bones. A tile-tomb containing fifteen vessels of various clays, consisting of a large cinerary urn of dark clay, two Samian-ware *paterae*, and three other *paterae* of other wares, two urns of globular form, and one partaking of an angular shape, a lamp, and four bottles with handles and narrow necks. A tomb formed of two hollow flue tiles set up on end, supporting a flat tile, and enclosing a cinerary urn of glass. Another tile-tomb containing eleven vessels, comprising an *amphora*-shaped urn with handles; a light coloured bottle placed upon the foregoing; seven urns of various forms; a cover to one of the urns, ornamented with engine-turning; and a *patera*. A tile-tomb containing a large cinerary urn, four bottles, four urns of various forms, a *patera* of red clay bearing the letter R scratched upon its surface, and a *terra-cotta* lamp decorated with a mask. One of these tile-tombs, of which many other examples are found in the Museum, is shown in our engraving.

A highly important tile-tomb is the one which has been formed of about forty tiles, built into a small square chamber, the upper ones overlapping others until they nearly reached the top, when the aperture was closed by two others. The group in this highly interesting tomb consists of a beautiful amber-coloured glass urn, with vertical raised ribs, and wide mouth; a green glass cinerary urn of globular form with wide mouth, covered by a beautiful glass *patera*; a large cinerary urn of globular form, also of glass; an elegant *prefericulum* of light green glass, with globular body, narrow neck, and wide spreading lip, with a graceful handle reaching over its mouth and ornamented with "pinched-up or denticulated ribs;" three clay urns of various forms; a clay bottle or jug with narrow neck and small handle; a *patera* of black clay, in which lay a coin of Domitian; a *terra-cotta* lamp bearing the figure of a horse; a curved bronze pin, and a bronze pin with amber boss and a number of flat amber beads strung upon it.

Of the other sepulchral groups, all of which, like the tile-tombs, have been found at Colchester, the following will be sufficient to enumerate; and they will show better than anything else the mode of interment adopted by the Roman owners of the place. One of these groups consists of a cinerary urn containing burnt bones, and covered with a part of a tile, a smaller urn, and a red-ware bottle. Another consists of two small cinerary urns and a *patera*. Another, besides the cinerary urn, contained a Samian *patera*, two bottles, and a mirror. Another, consisted of the cinerary urn with handles of red ware; a black urn ornamented with diagonal lines; a bottle, and a Samian-ware cup. Another with a large urn, two small bottles, and two *paterae*.

Another group consists of fifteen vessels of various kinds, and another of thirteen; among which are a large bottle or jug, and three smaller ones, three small urns, three *terra-cotta* lamps, two Samian-ware *paterae*, and a sepulchral bottle of blue glass. Several other groups will also be noticed, each possessing some marked and interesting feature in the vessels comprised in it.

Of *amphora* there are several remarkably fine examples. One of these is of reddish clay, with two handles, and is painted with white scrolls; it contained an interment of burnt bones when found. Another *amphora* is of very large size, and formed of yellowish clay. It has two handles, and a narrow neck, its body being of oval form; through its upper portion holes have been bored for the purpose of separating it from the base of the vessel, so as to admit a large cinerary urn, containing the burnt bones and ashes of the deceased. Thus, this large *amphora* was cut in two parts, and the remains of the deceased enclosed in a cinerary urn were placed within its lower half, with two narrow-necked and handled bottles, and then the top replaced, and the whole buried. There is also an *amphora*, measuring no less than 4 feet 3 inches in height, and a fine one from Lexden Park.

There are also one or two leaden coffins of great interest; but it is much to be regretted, that although several of these relics have at one time or other been found at Colchester, they have either been taken away to enrich other museums, or doomed to the melting-pot, instead of being permanently preserved on the spot. A remarkably fine Egyptian mummy, brought by Mr. G. H. Errington from Thebes, and several Egyptian and other antiquities have recently been presented to the Museum by that gentleman.

The Roman glass vessels should be carefully noticed, as some of them are of very unusual character. Among them is a large globular

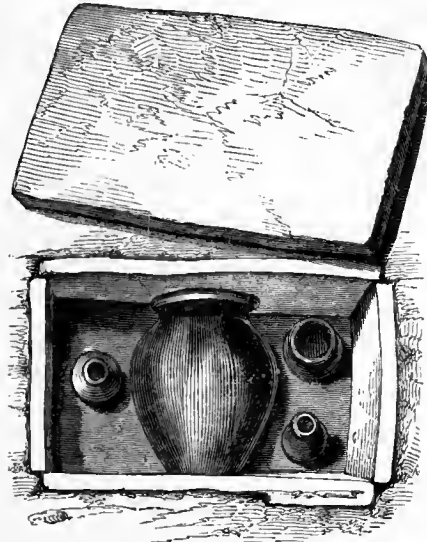

TILE-TOMB FOUND AT COLCHESTER.

cinerary urn of green glass, with wide mouth, which, when found, contained calcined bones and ashes; a beautiful urn of amber-coloured glass, with vertical raised ribs and wide mouth; and an elegantly formed *prefericulum*, of light green glass, with globular body, narrow neck, and wide spout or lip. It is in form much the same as a jug or ewer, and the handle, which is ornamented by "pinched-up, or denticulated ribs" curves inwards into the neck of the vessel. These three fine specimens of Roman glass were all found in one interment, along with a number of other articles. There is also a remarkably fine and large hexagonal glass sepul-

chral bottle, with flat handle and broad rim at the neck, which, when found, contained calcined bones. It is 8 inches in height. A glass *patera*, and a number of glass lachrymatories or *unguentaria* will also be noticed. There is also a large square glass bottle, with a flat ribbed handle, of uncommon size, being 13 inches in height, and 6½ in diameter, and a glass urn, filled with calcined human remains, found within a clay urn of the usual form. Those of the most beautiful character, however, are a cylindrical glass bottle, with a single handle, covered with iridescence, and filled with burnt bones, found inside a cinerary urn; and a lachrymatory, the iridescence on which is of the most exquisitely splendid colour.

A number of hypocaust, flue, and drain tiles will also be noticed. Several are ornamented with wavy lines and scroll-work.

Some of the Roman lamps are curious and very beautiful. One of them, in *terra-cotta*, bears the figure, in relief, of a warrior, helmeted, and holding a sword and shield; another, of light coloured ware, bears the figure of a horse galloping, reined; another, of large size, has three openings for burners; another, of bronze, is in the form of a griffin; others again bear respectively a mask, a horse, and other devices, while a large number are entirely devoid of ornament. Many of the lamps have been found in the tile-cists and other interments at Colchester, and doubtless some of them are of local manufacture. There are also preserved in this Museum some interesting lamp-stands of lead and of clay.

In Samian ware will be noticed some beautiful *paterae*, cups, bottles, *mortaria*, &c., some plain, others with the usual ivy-leaf pattern, and others again bearing various designs in relief. Several have impressed potters' names and marks.

Among the objects of personal use and ornament especially deserving of notice, are some necklaces of amber found in interments at Colchester; a bracelet of Kimmeridge shale, and some bracelets or *armilla* of bronze; ladies' hair-pins of bone; a metal mirror or *speculum*; a number of bronze pins; and some beautifully formed *strigils*, *styli*, *ligulae*, spoons, tweezers, buckles, needles, combs, &c. There is, too, a fine series of *fibulae* of various forms, of the Romano-British and Anglo-Saxon periods; many of the examples exhibiting peculiar beauty and elegance; also several finger-rings of bronze, jet, and other materials.

Among other miscellaneous articles will be noticed a Roman flute of bone, in three pieces; some querns or hand-mills; a Roman medicine stamp, of bronze, with ring handle, and bearing the letters, for stamping, R · F · HYGINI;



BRONZE FIGURE OF CUPID RIDING ON A SEA-GRIFFIN, FOUND AT COLCHESTER.

locks and keys of the same period; roundels of baked clay, which have been used for playing some game of chance; bronze bells; two fine *gypcieres*; and several curious examples of roundels of bone, as well as a large number of other equally interesting antiquarian relics.

Among the roundels some are especially worthy of note. These are what have evidently been used as tickets of admission to a theatre, and therefore attest, very strongly, to the importance of Colchester during its Roman occupation. One of these is of slate, and bears on

one side the figure of an elephant and the letters ETKERON; another of these tickets, formed of clay, has on one side a galley with rowers and the letters XVI, and on the other an incised square; a third, of red clay, has on one side a stag and ETV, and on the other a circular ornament; another has also the figure of a stag; and others again have various geometrical and other devices. Among the *tesserae*, too, are many of great interest, some of them bearing names, numbers, and other inscriptions.

Several leaf-shaped swords of bronze, and

bronze daggers, spear-heads, &c., as well as flint arrow-heads, bronze celts, gouges, and palstaves, and stone celts and other implements will also be noticed.

Among the mediæval pottery are some good *Bellarmines* and other vessels which are worthy of examination.

The Museum contains a very interesting, and somewhat extensive, collection of coins, mostly found at and near Colchester, and comprising ancient British, Greek, Gaulish, Roman, Saxon, mediæval, and modern coins and medals, in



THE "COLCHESTER VASE."

great variety. The Roman series comprises gold, silver, and first, second, and third brass, from an early down to a late period of the empire, it includes many fine and rare examples, ranging down from Augustus to Arcadius. The English series, too, contains several fine specimens.

There is also a tolerable collection of the traders' tokens issued in Colchester in the seventeenth century.

A remarkably useful collection of local books and manuscripts, may also be noted.

Among other miscellaneous articles worthy of especial note are an ewer and salver by Briot,

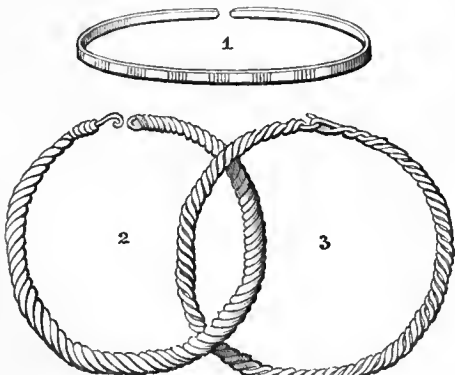

ARMILLE AND BRACELET, COLCHESTER.

with medallions of the elements and of the seasons, and the head of Briot himself; a plate by the same; a pair of curious early carved nut-crackers; rubbings of a leaden coffin found at Colchester; relics from a Swiss Lake-dwelling; and a remarkably interesting set—or rather part of a set—of roundels.

These roundels, or fruit-trenchers, are seven in number, and are stated to have been made in the year 1596. They are formed of lime wood, and are about 5 inches in diameter, and an 8 of an inch in thickness. They are, says Mr. King, "diversely painted with arabesque patterns, foliage, various old-fashioned garden flowers, the flower and fruit of the strawberry, and the foreign pomegranate, chiefly in red, green, white, and gold. In the centre of each roundel is inscribed a rhyming couplet or posy, and upon scrolls or ribands, texts or admonitions

from holy Scripture." Some of the posies and verses of Scripture are as follows:—

"Thy truth send down, Lord, from above,
And give me grace the same to love.

"Have no pleasure in leyinge, for the use there off is naught."—ECL. vii.

"The loose of lyfe, of goods and landes,
O grasious God, is in thy handes.

"Kepe ye Kings Co'mandme'ts. Praie for kings and rulars. Feare ye the Lord and the kinge. Feare God, honor ye kinge."—1 PET. II.

"From feare and force of all oure foes
Preserue us, Lord, and them depose.

"If any man saie, I loue God, and hateth his brother, he is a lyar."—JOHN IV. "Every one that hateth his brother is a man slayer."—JOHN III.

The Colchester Museum, of the contents of which I have given this brief account, is jointly the property of the Corporation of Colchester and of the Essex Archaeological Society. For the purposes of location of the Museum the late Mr. C. G. Round, M.P., gave free use of apartments in the fine old castle of Colchester, for the display of the objects, and for the residence of the Curator: this provision is being liberally continued—and long may it be so—by his nephew and successor, Mr. James Round, M.P. The Museum, which is entirely free to the public, is under the care of Mr. Gunner, the curator; and it is much enriched by a series of admirable drawings by Mr. Parish, to whose skill as an artist the public are indebted for many beautiful representations of Colchester antiquities, and for drawings which decorate the walls of the building. The Essex Archaeological Society, to which many of the treasures of ancient Art belong, is one of the most useful and important of local antiquarian associations; it is under the able management of its secretary, Mr. W. H. King, and is doing its good work in the county in a manner which is highly creditable to its council.

SCHOOLS OF ART.

BIRMINGHAM.—The annual meeting of the Birmingham School of Art and Design was held, under the most favourable auspices, on the 22nd of February; Sir M. Digby Wyatt occupying the chair. The number of students attending the school amounts to 1,077; 606 of whom are artisans engaged in the manufactures of the town. The financial state of the school is satisfactory; it shows a balance in its favour of £27 4s. 9d.—this is chiefly attributable to the fees received from the students attending the classes. It is a noticeable fact, that of the 169 subscribers to the support of the school, 40 only are manufacturers! The new features introduced in the past year were the classes for the production of applied designs, and for wood-engraving. The works of the students, in addition to those made in accordance with the prescribed studies issued by the authorities at South Kensington, embraced a very large number of designs for articles of manufacture, stimulated by prizes offered by the president and a number of gentlemen interested in the practical usefulness of the school. The result may be said to have been satisfactory, taking into consideration the ages of the competitors, the majority of which did not reach the age of twenty-one. Most of these designs were well and carefully drawn; it is probable the original features discernible in them were not many, or of very great excellence; it is only proper, however, the power to draw well having been acquired, that the student should be encouraged to attempt to design—for which purpose Schools of Art and Design were originally instituted. In the evening Sir M. Digby Wyatt addressed a crowded audience in the Town Hall. The address was of an eminently practical character, admirably adapted to students and the audience generally: we regret we cannot find room even for an abstract of it.

CAMBRIDGE.—The prizes to the successful pupils at the last year's examination were presented to them, on the 14th of February, by Lord Houghton, who, in his address to the meeting, referred to the recent establishment in

the town of a Professorship of Fine Arts in connection with the University; and which, his lordship remarked, was not done a day too soon. The nobility and gentry of the present day did not study and appreciate Art like their ancestors of a century back, and he recommended the authorities of the University to endeavour to foster among the young men of the colleges an appreciation of Art.

DARLINGTON.—The annual meeting and exhibition of this school was held in the Mechanics' Hall in the month of February. The exhibition was enriched, as on a former occasion, by a large collection of water-colour drawings, photographs, etchings, and other works of Art from the South Kensington Museum. The productions appeared equal to those of any former year in freehand, shading, water-colours, and mechanical drawing. According to the report, the total number of students who have been at any time under instruction during the past year has been 180, an increase of fifteen over the previous year. The average number in the school was 106, which shows an increase of seven in the average attendance as compared with 1869. The increase is in the ladies' class and the general evening class. The number who presented themselves for examination in March last was 109, and out of these 77, or 70 per cent., were successful. As compared with 1869, this shows an increase of 13 competitors, and the percentage of those who passed was then only 58 per cent. Prizes were awarded for special proficiency to 16 students, and four completed their full certificates in the four branches of the examination.

MACCLESFIELD.—A meeting of the committee of this school was held somewhat recently to receive the report of a deputation which had waited on the South Kensington authorities with reference to a new building. The result of the meeting is said to have been satisfactory, and Mr. J. Ford, head-master of the school, was directed to prepare plans for the projected edifice, in order that they may be submitted to the Government for approval.

NOTTINGHAM.—Lord Belper presented the prizes to the successful students of this school, at the Exchange Hall, at the annual meeting of the subscribers and supporters. The report of Mr. Rawle, head-master, stated that the number of students who attended during the past year was 503, showing an increase of 94 over the previous year. The general work of the school was considerably in advance of any former year; while the number of drawings, &c., sent up to London for inspection was 1,800, or exactly 50 per cent. more than the average proportion of each student's work throughout the country: there were also more in the advanced stages than in 1869. The school has again taken the highest number of prizes among provincial institutions, which makes the third consecutive year that Nottingham has headed the lists. It is now the only school in the kingdom that has gained gold medal awards for four consecutive years—South Kensington alone excepted. The last gold medal was obtained for a design for a lace curtain, which has since been manufactured by Messrs. Adams & Co. The school has obtained the highest award in the country for architectural design—a national silver medal. It was suggested that an architectural "club" should be formed in connection with the institution; the chief object of which was to afford students the opportunity of preparing and reading papers, and to study together the various phases of architectural work.

ROCHESTER.—The annual distribution of prizes to the successful students at the Art-schools in Rochester and Chatham has taken place: an exhibition of the works of the pupils was previously held. The area in which this school is situated includes a large population: such an institution ought, therefore, to find abundant support.

SHEFFIELD.—The last annual meeting of the friends and supporters of this school proved more than usually successful: a very large attendance of visitors being attracted to the rooms by an excellent display of works of Art of various kinds. Mr. George Dawson delivered an effective address to the company assembled.

SOUTH AFRICAN DIAMONDS.

It is not our intention, in the present paper, to enter into the vexed question of the merits of the various routes * to the diamond fields, or to describe at any length the region itself. So many contradictory reports have appeared in the public prints of the discoveries, their effect upon the market, and the quality of the stones, that we think a few carefully selected facts upon these points may interest our readers.

Exactly four years have now elapsed since the first diamond was found by a Dutch farmer in the Hope Town district. In March, 1867, Dr. Atherstone, of Graham's Town, received this stone for examination, and pronouncing it genuine, it was exhibited at the Paris Exposition, and afterwards purchased by Sir P. Wodehouse, the governor of the colony, for £500. Others were discovered soon after in the Vaal and other districts, but stones do not appear to have been found in any quantity till 1869, when, according to an "official" statement, 141 diamonds, valued at £7,405, were shipped from the Cape. In this year (1869) the "Star of South Africa," weighing 83½ carats, was found near Sandfontein, on the Orange River. The man who discovered it sold it for five hundred sheep, ten head of cattle, and a horse. Messrs. Lilienfeld Brothers afterwards purchased this gem; in 1870 it came to England, and is now in the possession of Messrs. Hunt and Roskell, where we had an opportunity of examining it. By cutting it has been reduced to 46½ carats, and is valued at £20,000. During last year, according to the statement before quoted, 5,661 diamonds were found, estimated value £124,910; but this is probably under the mark, as the customs returns for that year give 3,686 shipped for Algoa Bay, value £97,423. Many diamonds have been sent home by post and other means, so that it is very difficult to get a correct estimate. A correspondent of the *Times*, in a report from Cape Town, dated October 3, said that the statement of a monster diamond having been discovered was perfectly true, and that the actual gem is 107 carats (the Koh-i-Noor weighs 102½ carats), of pure water, octahedral in form. This has been brought to England by Lieut. Vibant, of the Natal party. The same writer said that Captain Rolleston has left for England to organise a company on a large scale to work systematically. The *Friend of the Free State* publishes a letter from a correspondent from Pniel, dated October 2, in which is a most interesting account of the discovery of a splendid gem weighing 88½ carats,† for which the finder was offered £22,000 on the spot.

"Mr. Wheeler, of Beaufort West, and six of his relatives, have been at work on the Pniel bank for four months. They had, to Thursday morning, picked up twenty-one diamonds, but did not consider that this would be sufficient to realise their expenses, and they had just resolved to pack up and be off, when Wheeler, who had been standing by his cradle and overlooking the working of it, held up his hands and shrieked as if he had been shot. 'What's up?' asked his assistant. Wheeler, when he had recovered his breath, explained that immediately the first bucket of water thrown into the cradle oozed away, he saw the light come up from a stone half buried in gravel, and seizing it, he found it

* A pamphlet published by Messrs. Silver & Co., of Cornhill, gives much important information to emigrants. Mr. Gill, in a little work published by S. Low & Co., and in a letter to the *Times*, Jan. 18, 1871, advocates the route from Port Elizabeth via Graaff-Reinet; and Dr. Williams, in two long letters, *Times*, Sept. 28, 1870, and Jan. 18, 1871, advocates that by way of Algoa Bay and Graham's Town. All these letters contain valuable information. The Cape Town route is the longest, i.e. between 800 and 900 miles; the others about 500. Mr. Gill says, to Englishmen accustomed to railways, a journey by ox-wagon from Cape Town to the Vaal River would be intolerable torture. He says a waggon party must, by this route, allow itself at least two months for the journey.

† The Shah diamond weighs 86 carats, and was presented by the son of Abbas Mirza to the Emperor of Russia. The Piggott diamond (weight 82½ carats) was sold by Rundell and Bridge to the Pasha of Egypt for £30,000. It must be remembered that we have been obliged, in comparing these stones, to give the rough weight of the South African specimens, which would be greatly reduced in cutting.

to be a diamond about the size of a pigeon's egg. How he felt he could not describe; how he acted they had seen. At last they realised the fact, and then they cheered like mad. All the Pniel diggers heard the cheer, and ran like mad; the Klipdrift diggers and dealers heard it, and seeing the diggers swarming like bees at one spot, rushed down to the boats and crossed over. Hundreds and hundreds of persons saw the gem, handled it, and turned it over; so many, indeed, that the proprietors began to fear that their wonderful diamond would be eaten up, and they declined to exhibit it to any more people. Wheeler and one of his companions set out with their prize the same evening, and have determined now not to sell it in Africa. They are determined to see England, and to dispose of the stone in that great land of liberty, which at breakfast-time on Thursday morning they had never cherished a hope of seeing."

The *Celt* is assumed to have brought this diamond to England, which is called the "Star of Beaufort." The Tabb diamond, of 37 carats, one of the finest gems from the Vaal River, is said to present under the microscope the appearance of "a cluster of pointed mountain-summits lit up by vivid sunlight, and diffusing all the colours of the rainbow."* A correspondent of the *Natal Mercury*, writing from Hebron, says he saw a diamond that a Koranna picked up, weighing 62 carats, nearly square, of a pale straw colour. A Mr. Rose bought it, and gave a waggon and oxen, fifty head of cattle, £50 worth of goods, and £300 worth of sheep for it. To give an idea of the value of this stone we may mention that the Sancy diamond (54 carats, or 8 carats less) was sold by James II. to Louis XIV. for £25,000. It afterwards came into the hands of Prince Paul Demidoff, and in 1865 was purchased of the family by Messrs. Garrards for Sir Jamsetjee Jeejeebhoy, of Bombay. (King's "Natural History of Precious Stones," p. 69).

A report in the *Times* dated Plymouth, Jan. 23rd, 1871, announcing the arrival of the *Briton* with diamonds, states that a Mr. E. C. Wrench, who left Claremont in August, was said to have found three diamonds, the largest being valued at £1,000, the other two at £200; while Messrs. R. Smith and A. Muller, residents of Burghersdorp, had been to the fields for three months and had returned with £8,300 each, the value of their finds; and one firm in Cape Town was said to have had £7,000 worth of diamonds handed to it by one man. The *Times* thinks that the aggregate value of diamonds found during 1870 could not be less than £200,000. Diamonds are now cheaper than they were in 1861, but it is certain that the South African discoveries have had little effect on the market. To prove this we have only to turn to reports which have been furnished by merchants. Mr. Harry Emanuel states that the yearly average yield of the Brazilian mines is about £800,000, and that of the Indian, Borneo, and Australian, from £150,000 to £200,000. Messrs. Levenson and Goldschmidt add a nearly equal amount brought into the market by private holders, owing to deaths, &c., making nearly £2,000,000 a year—so that the £200,000 worth of Cape diamonds would make little difference. The gentlemen last mentioned state that the diamonds consigned to this country from South Africa have generally been valued at four or five times their worth. The *Norseman* was said to have brought £80,000 worth, but £18,000 was nearer their value. Mr. Emanuel states that the quality of the stones is in most cases inferior to those of India and Brazil. For many years the United States have absorbed the principal diamonds of first-rate quality that come to the European market. He believes that it will require a considerable period of time and a great increase of production before we see any diminution in the value of fine diamonds. Messrs. Williams and Hill corroborate Mr. Emanuel's statement respecting the value of ordinary Cape specimens, though some of the larger stones (the Star of South Africa, for example) have

* This weighs 5 carats more than the Cumberland diamond purchased for £10,000 by the City of London, to be presented to the Duke of Cumberland after the battle of Culloden. It was restored to Hanover by her Majesty the Queen.

been of fine quality. They state that they and all diamond merchants are giving a higher price for fine gems than has ever been paid before at any period on record, and they contradict the *Times* statement that diamonds are cheaper than in 1861.

The value of diamonds at different periods is a very interesting subject. In his work on "Diamonds and Precious Stones," 1867, Mr. Emanuel gives a table showing the value of these stones in 1606, as sold in Venice by the merchant Giovanni Ricardo, copied from a Hebrew work by Portaleone. In this a brilliant weighing 1 carat is set down at £21 13s. 4d.; 2 carats, £86 13s. 4d.; 3 carats, £195; and 5 carats, £346 13s. 4d. In 1750 Jeffries' tables appeared, which are "based on the assumption that a diamond increases in value in proportion to its weight, in the ratio to the square of its weight, that is to say, supposing the value of a 1-carat stone be £8, one of two carats will be worth $2 \times 2 \times 8 = £32$." According to his table a stone of 3 carats is only worth £72, and 5 carats £200. In 1791 the French jewellers appointed to value the crown-jewels fixed 1-carat stones at only £6. The Revolution of 1848 lowered them to about £4 10s., but they rose rapidly after; and Emanuel, in 1865, places the 1-carat stone at £21, the 2-carat at £80, and 5-carat £350, or nearly their value in 1606. In the suit of "Van Minden v. Pyke," it was stated that diamonds had risen 25 per cent. since 1861. In this year Messrs. Williams and Hill give £25 as the price of a fine 1-carat stone.

"Adamantia" (the popular name for the diamond fields) is a region very difficult to define; in fact there seems hardly any limit to its extent. The principal portion, however, is the strip of land between the Hart and Vaal rivers. It will be remembered that in 1853 we formally abandoned the tract between the Orange and Vaal rivers. The Dutch boers here formed a republic, but some families migrated farther, forming the "Trans-Vaal" Republic. The diamond-region seems to be a sort of debatable land. The *Times* says Lieut.-General Hay, Lord High Commissioner, has addressed a despatch to the President of the Orange Free State asking for proof of his title, if any, to the lands east of the Vaal River, the same being claimed by the Chief Waterboer. Mr. Mann says that Pniel, "the latest centre of interest in this district," is a point on the Vaal "310 geographical miles in a direct line from D'Urban, the port of Natal." A writer in the *Natal Mercury* (quoted in *Times*, Dec. 31st, 1870), dating from Hebron, says that "about 1,000 diggers have gone to Gorn-Gorn, about nine miles farther down. About 6,000 diggers are down below altogether. Nine boats are constantly crossing the river. Regular streets are laid out. A music-hall and a masonic lodge are being built. The Free State has given up all claim to the ground on this side of the river. The Trans-Vaal claims it, and I think it belongs to them, but we are not quite certain. There has been a meeting this week and it has been put to the vote whether to give it up to the Trans-Vaal or start an independent republic. I think there is no doubt it will be a separate republic. There are reports that Jantje, Cassibone, and Mahuru—three Caffre chiefs, threaten to come down upon us at Hebron, and nearly all the Caffre servants have gone." He says that at Klipdrift the Trans-Vaalers have had the majority of votes, but the diggers would not give it up.

The diamond has been rarely found in its matrix. Prof. Maskelyne says, that in Brazil, it has been traced to its home in the *Itacolunnite* (from the mountain Itacoluni in that country), a micaceous quartzose schist, containing talcose minerals intersected by quartz veins. These rocks are probably metamorphic, and, therefore, not in their original condition. Gold is frequently found associated with the diamond, and it is curious that the primary crystals of each are alike and also their secondary modifications. A conglomerated mass of quartz pebbles with diamonds and gold, in Mr. Ruskin's collection, found in the bed of a river in Brazil, shows the connection. It is, however, very rare to find them so well exemplified as this. To a small extent diamonds in Brazil have been worked from the original vein in the rocks, but the process is

very expensive, and diamonds are nearly always obtained from the alluvial beds of rivers.

It is stated that the source of the South African diamonds is to be found in the Drakensberg mountains, which flank Natal to the westward. Mr. G. S. Higson, who surveyed the region, says he was successful in discovering an immense deposit of the underlying rock. "It is a porphyritic gneiss, and no doubt has a very extensive range in South Africa. Mr. Hübner showed me specimens of the same fundamental rock which he had found covering a large area of country to the north; it is the underlying stratum at the Tatin and northern gold fields, at the chief Machin's town, in the Bamangwato hills, and forms the great mass of the Maquassie range of mountains in the Trans-Vaal; but Mr. Hübner had been unsuccessful in tracing it again after leaving the Maguassie."

Professor Tennant, in a lecture delivered Nov. 23rd, 1870, at King's College, stated that a great variety of other minerals had been found in the same neighbourhood. Many have been broken owing to the carelessness of the finders; for though a diamond will scratch all other substances, it is so brittle that a fall will sometimes be sufficient to break a fine stone. This was so little understood formerly that many persons to test a diamond placed the stone upon an anvil, thinking it would resist a heavy blow from a hammer.*

A great deal of difference of opinion exists as to the formation of diamonds. Brewster supposed the gem to be nothing more than a fossil gum; and Mr. King observes that his theory is strongly supported by the existence of the *carbonado*, or amorphous black diamond, in such large quantities, bearing the same relation to the pure species as jet does to amber. Professor Göppert thinks they were at one time in a soft condition because of the impression of grains of sand, &c., on their surface, and also by the inclosure in them of other crystals, germinating fungi, &c.,† Liebig considers the various colours of the gem arise from the presence of uncrystallised vegetable matter. Chemists and mineralogists have declared that they can expel the colour of diamonds by heat; but Mr. Emanuel says that this is fallacious, for although the stone when exposed to strong heat appears whiter this is only owing to a crust being formed on the outside which impairs the transparency, and that the colour returns when the stone is repolished. He admits, however, that red flaws occasionally lose their colour by exposure to great heat. Diamonds, too small to be of any value, have been produced by placing certain quantities of water, phosphorous, and bisulphide of carbon in a vessel left undisturbed for some time.

Professor Maskeleyne says, "Of the numerous solutions of this problem (the production of the diamond), one possesses peculiar interest, viz.—that considering diamonds as deposits on the cooling of fused metals (or other substances) surcharged with carbon. Graphite, boron, and silicon are formed on the cooling of fused aluminium surcharged with these elements; and the same elements—in other respects so closely grouped with carbon—separate in the adamantine form seen under analogous circumstances. The

* An ancient test of a diamond was to put a dark varnish on one side of the stone, which, if real, gave it great brilliancy, and if not, rendered it lustreless. This was called giving "the tincture." Mr. King says this was sometimes evaded by setting the imitation diamond with a vacancy between its *culasse* and a black back-ground, the air confined in this space preventing the rays of light from being stopped too suddenly by the ground. The diamond was formerly never set in a transparent form. De Boot, in the seventeenth century, thought the diamond proof against fire, and that was the general opinion in early times. Averami and Targoni, in 1664, burnt diamonds with the burning-glass of the Grand Duke of Tuscany. Lavoisier, Newton, and Smithson Tennant, all experimented on the combustion of the gem; but Sir H. Davy first settled its composition. He found that carbonic acid gas was the only product of its combustion. Fire is often used to improve diamonds. In the case of "Van Minden v. Pyke" (August 9, 1865), it was stated that when a large stone is disfigured by a yellow flaw, it is customary to roast it in a crucible of horax, changing the yellow into bluish black, and improving the appearance of the gem. It is well known the pink topaz is only the yellow changed by fire; so a yellow diamond has been changed to pink, but a few days after it returned to its former hue.

† See Göppert on the "Vegetable Origin of the Diamond."

latter indeed are crystallised in different systems from the diamond, but they possess many of its characters in a remarkable degree." The diamond is composed of thin laminae deposited over each other in a direction parallel to the faces of the primitive crystal. In the sixteenth century this property was known, for De Boot states that he knew a physician who boasted he could divide a gem into five scales like pieces of talc. Mr. King says that Dr. Wollaston made some profitable speculations by purchasing large diamonds with flaws at a low price, and then dividing them into smaller and perfect crystals. In ancient times diamonds were polished by rubbing them against each other. In 1475, Louis de Berghem, of Bruges, invented diamond-cutting, though it is probable a rude method had been employed in the East before this time. When Tavernier, in 1665, visited the Raolconda mine, he found a number of diamond-cutters established there. If a stone contained flaws they covered it with facets to conceal them. Great improvements were introduced in diamond-cutting in the seventeenth century.

There is no doubt that persons going to the fields must make up their minds to very hard work. The population of the Pniel side is sober and steady, and that over the water is hard-working and English. Crime is punished in a rough and ready manner, blacks being flogged, and whites put across the river. Dr. Williams says the earlier comers kept close to the rivers for the convenience of washing the gravel. Now that there are about 15,000 males there, many have to retire to a distance, and have to cart the water requisite for washing a considerable way. Diamonds have been found twenty-five miles from the Orange River, and there seems hardly any limit to the extent of the fields. Once on the ground it is said a man may live economically for £60 or £70 a year. A writer in the *Times of Natal* writes: "We find nothing in the surface-wash, which goes down about eight feet, although there is a chance of doing so, others on claims near us having found near the top. About eight feet down we come to a different wash, the stones being covered with a lime sediment and quite white on the outside. It is in this wash that we pick out the diamonds. We have gone down 14 feet, and intend to see the bottom of it if we can, in hopes of meeting something larger than what we have yet got." Another writer says, "We get up at sunrise, have a cup of coffee, and then cart ground down to the river till say eight o'clock. We then have breakfast, after that wash and cart the stone till say three o'clock, and then till sundown pick up ground ready for next day. The sorting is the worst of the work, it is awfully tedious looking over the stones. We have a large cradle with two sieves; the top sieve lets through stones as big as nuts; the bottom one much smaller stones. We put a lot of stuff in the top sieve, rock the cradle, while a Caffre pours water on, till all the small stones have gone through the top sieve and the dirt is all off. We then look roughly over the big stones in the top sieve, and throw them away. The bottom sieve is then emptied on to a table, and we have to look carefully over the stones. As yet we have only managed to pick up, cart on, wash and sort two cartloads a day, three of us at work, myself, R—, and a Caffre." Mr. Higson says rubies are pretty plentiful but small, the largest he saw was between 4 and 5 carats. At the latter part of November two storms raged with great fury over the fields, destroying considerable property. After that, great annoyance was experienced from immense swarms of locusts moving along the ground in a wingless state.

It is difficult from the contradictory reports to give a reply to the question respecting the chances of remuneration to intending emigrants. Dean Williams seemed to invite persons to come to Graham's Town with £5 in their pockets. The propriety of this invitation was questioned by Mr. Gill, of Graaff-Reinet, who asks what they are to do when the £5 are gone and the stubborn soil still refuses to yield up its treasures. He says if four or five hands club together, and in case of non-success tell off one of their number to work at a trade while the rest dig, they may do well. He thinks that men in general, or parties of men, who can tide over the first six

months of possible disappointment, and who will be making no great sacrifice in leaving England, may give the fields a consideration. Dr. Williams believes "no one knows of any person or party who has worked steadily for six months without finding diamonds more than sufficient to pay all expenses. The percentage of large stones—say from 18 to 40, 50, 60, and 80 carats weight, many of them gems of the best shape and description—is something marvellous to those who know a good deal of the Brazilian mines. I give you one of the latest instances. An old man of sixty-five or seventy years, white-haired, weakly-looking, and somewhat stooped, once in good circumstances, but recently reduced to poverty, left his little remaining property to his creditors and went to the fields. He returned the owner, with his partner, of between £4,000 and £5,000 worth of gems" (*Times*, January, 1871). The fields are a lottery with fine prizes, but certain it is that many have drawn blanks. Mr. Gill says no one should sacrifice £200 a year to go, or work for a shorter period than three months. He tells emigrants to avoid as a rule expensive outfits, and that married men are best away. A person who knows the fields well states that the average find is not more than one diamond daily to one hundred persons. With this statement we close our paper, thinking we have given facts enough to show the importance of the discovery, and the chances of success to intending explorers of "Adamantia."

JOHN PIGGOT, JUN.

PAUL GUSTAVE DORÉ.*

"FAMILIAR as a household word" is the name of Doré in every part of the world into which European Art, in its most popular phases, penetrates. As a result, it would be impossible to point out a single artist of any place or time whose works have so much engaged the attention of the critic's pen, whenever the versatile genius of this gifted illustrator has put forth some new claim to consideration. As each successive production from his pencil has made its appearance it has had its due share of notice in our columns; but we are again tempted to introduce his name by the publication of a magnificent volume, of large quarto size, containing a choice gallery of 250 engravings, selected from his principal works. It was an excellent and a happy idea of Messrs. Cassell and Co. to issue such a gathering; for we have in it a concentration, as it were, of Doré's varied range of fancy and artistic power—in his scriptural designs—in the solemn, often appalling, illustrations of the Italian poets—in the lovely ideal landscapes of nature—in the animal world—and in the grotesque humours of Don Quixote, Munchausen, and others. This is no limited radius to enclose the conceptions of one mind, but Doré has proved himself equal to carry out the tasks he at different times undertook, though not always with an adequate amount of success; nor could this be reasonably expected; setting all other considerations aside—such, for example, as the total unfitness of the minds of some men, however highly gifted, to grasp every kind of subject—the fact of an artist being called upon to travel over ground,

"From grave to gay, from lively to severe,"

almost at one and the same time, would be sufficient to render his productions in some degree unequal; their very diversity is in itself likely to produce complexity, or irregularity, of invention. Mr. Ollier's estimate of Doré is perfectly true:—"he has his faults, like other men; but his genius is so predominant as almost to blind us to its drawbacks. He takes people by storm, and scarcely allows time for

* THE DORÉ GALLERY: containing Two Hundred and Fifty Beautiful Engravings, selected from the Doré Bible, Milton, Dante's Inferno, Dante's Purgatorio and Paradiso, Attala, Fontaine, Fairy Realm, Don Quixote, Baron Munchausen, Croquemitaine, &c., &c. With Memoir of Doré, Critical Essay, and Descriptive Letterpress, by EDMUND OLLIER. Published by Cassell, Petter, and Galpin.

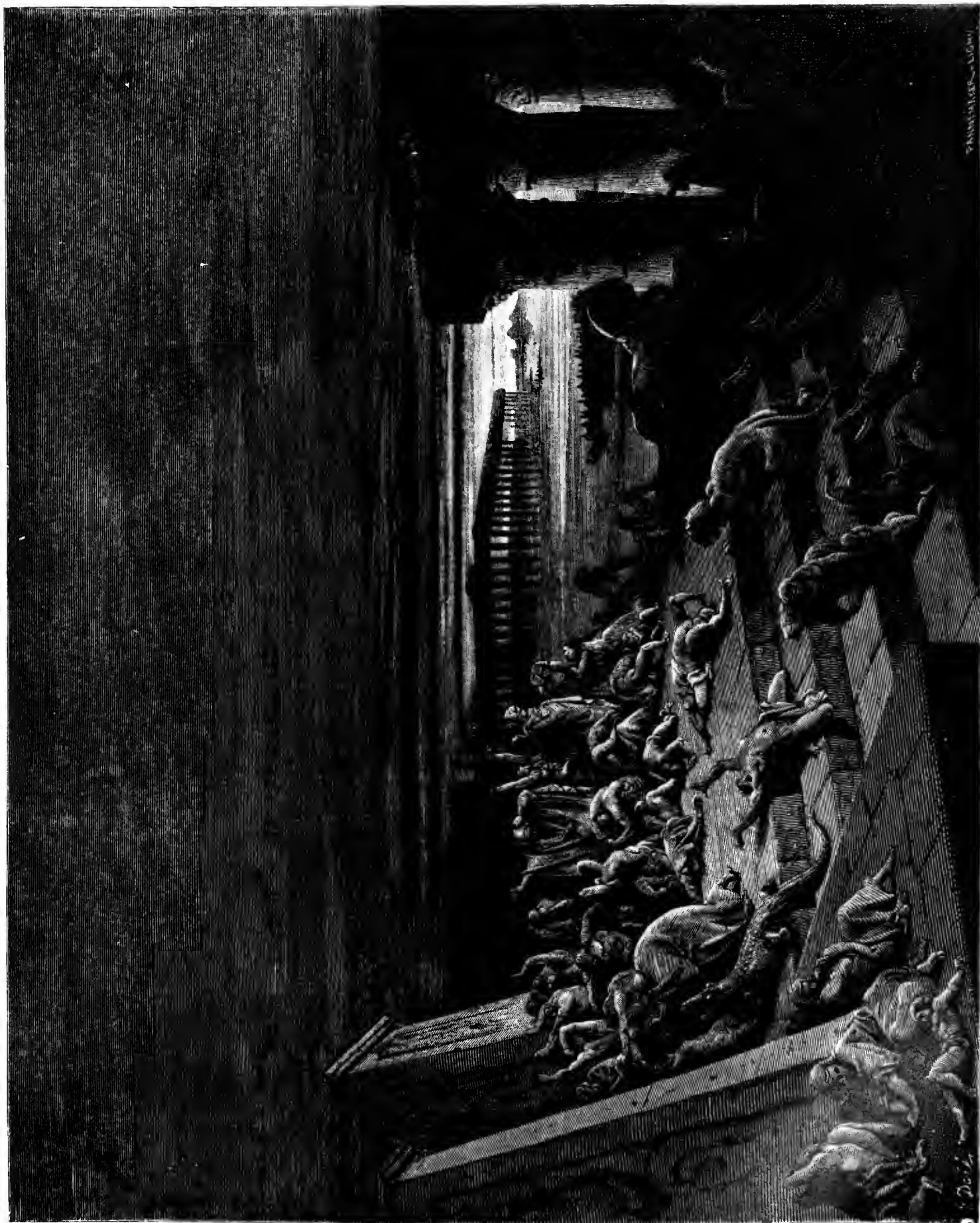

THE PLAGUE OF DARKNESS





THE PALACE OF SLEEP.



their judgment to interfere with their admiration. The marvellous number of his designs—the immense extent of literature which he has illuminated by the conceptions of his vast and wild imagination—the poetic beauty of some of his illustrations, the elfin humour of others, and the lurid glare and gloom of not a few—are so many sources of that feeling of amazement which fills the mind when once it has fallen beneath the spell of this magician."

Instead of attempting to analyse and describe the contents of this volume, which would after all be little more than a repetition of what had been previously said when writing of Doré's works in their separate and distinct classifications, we choose rather to extract from the book a passage referring to the artist's personality, quoted by Mr. Ollier in his prefatory memoir:—

"Doré has recently had a studio built for himself in the Rue Bayard. It is the largest in Paris, but in spite of its extent he has scarcely room enough in it for his numerous pictures—many half completed, and many still in execution. This studio is daily visited by persons of all grades of society. Doré receives all in the most favourable manner—talks, jests, listens, and tells the news of the day—never ceasing, at the same time, the bold touches of his brush upon the canvas. His appearance is very attractive. He looks like a youth of twenty-four (he has recently entered his thirty-ninth year), who, with bright, happy eye, is gazing forward into the world. He possesses unusual strength of body, which is, doubtless, to be traced to his great fondness for gymnastic exercises. He pursues these with eagerness, and was formerly one of the boldest climbers. When he was in Rouen, some years ago, he climbed up to the highest point of the cathedral there, to the great astonishment of the crowds who looked on at this unexpected scene. But immediately after this aerial journey he was arrested by the police, who accused him of having placed the inhabitants of Rouen in the utmost alarm by his perilous boldness. He was the first to make the ascent of the Aiguille de Florin, in Savoy; and he made many attempts also to ascend the Matterhorn. These attempts however, failed. But though he has not succeeded in ascending the Matterhorn, he has painted it with masterly power. . . . Few can compete with Doré in social talents. He talks well, he sings admirably, he plays the violin, if not, perhaps, with professional skill, yet with great understanding; and he is a clever conjuror, rarely failing in a trick. There is, therefore, no *salon* in which he is not gladly received; and when he visited the Court at Compiègne, some years ago, he arranged all the festivities there, and was, so to speak, the soul of the Court life. In his own *salon* he often gathers together a distinguished circle of friends, and many an excellent artist and musician is to be met there. Doré loves music passionately, especially German music, and no one admires and esteems Beethoven more than he does. Some work of Beethoven is always sure to be heard in Doré's *salon*."

Mr. Blanchard Jerrold wrote, in the *Gentleman's Magazine* for September, 1869,—“In Doré's spacious *salon* of the Faubourg St. Germain, covered with his work, is a little world of Art. The professor of science, the man of letters, the gifted songstress, the physician, the composer, the actor make up the throng; and the amusements are music and the discourse of things which are animating the centres of intellect. A happier and nobler picture than this handsome square *salon*, alive with the artist's friends, each one specially gifted, and with the painter-musician in the centre, dreamily talking of some passing incident of scientific interest, with his fingers wandering listlessly over the strings of his violin, could not be—of success turned to worthy ends. The painter has been through a hard day's toil. You have only to open a door beyond the *salle-à-manger* to light upon a workroom packed with blocks and proofs, pencils, and tints, and sketches.” This is where the artist works at his marvellous book-illustrations. “A long morning here, followed by a laborious afternoon in the Rue Bayard,” his painting-studio, “has earned the

learned leisure among intellectual kindred upon this common ground of Art, where all bring something to the pic-nic. Frolic fancy is plentiful. Old friends are greeted with a warmth we formal people cannot understand. The world-famous man is *mon cher Gustave*, with proud motherly eyes beaming upon him, and crowds of the old familiars of childhood with affectionate hands upon his shoulders. Dinner is accompanied by bright, wise, unconstrained talk; coffee and cigars in the lofty saloon; and music and laughter, the professor parleying with the poet, the song-bird with the man of science.”

This is a pleasant picture of social artistic-life in Paris, rudely invaded, however, of late by the tumultuous din of war, and the stifled anguish of thousands gaunt with hunger, or saddened by bereavement. How could Doré labour at his Art amidst such direful calamities? and so, with hundreds of his professional brethren, all inspired with the same patriotism, he joined the ranks of the defenders of his country in the vain attempt to drive out her enemies from the land. We rejoice to know that he has not fallen in the field of battle with Regnault, and Otto Weber, and many more, who have been numbered with the slain.

But to return, briefly, to the noble volume, the “Doré Gallery,” from which we have been permitted to select two illustrations to accompany this notice. The first of these, ‘THE PLAGUE OF DARKNESS,’ is from the illustrations of the Bible, and is one of those we specially commended five years ago when reviewing the whole series. It is a grand and appalling picture, recalling to mind the compositions of our own John Martin. The subject would be one impossible to treat, if the scriptural description were literally followed; for we read that the darkness was such as to be “felt;” and the Egyptians “saw not one another, neither rose any from his place for three days:” as a consequence, it must be assumed that every person and every object was invisible. But here people are gathered together, out of their dwellings, in groups, and all is seen in the atmosphere of a dim twilight. Poetic licence, which the painter has also a right to claim, justifies a treatment that only could make the subject practicable to the artist.

A very different picture is ‘THE PALACE OF SLEEP,’ taken from a series of designs bearing the title of “The Fairy Realm,” in which Doré has illustrated some of the leading incidents of tales familiar to us from our nursery-days, as “The Sleeping Beauty,” “Little Red Riding Hood,” “Cinderella,” “Puss in Boots,” and others. ‘The Palace of Sleep’ is from the first of these: it shows the prince who is destined to set free his lady-love from the enchantment, arriving at the castle, only to find all its inmates, and every living thing appertaining to it, wrapped in the deep slumber which overtook them suddenly as they were engaged in their several employments;—

“Huntsmen bold returned from sport
Snoring, borne to lips.”

horses and dogs also fast asleep in the precise attitudes in which the enchantment found them at the moment. Many of our readers will doubtless remember Maclise's beautiful picture of ‘The Sleeping Beauty;’ an interior scene, with the lady, surrounded by her attendants, all in “the sleep that knows no waking” till the spell is broken by the arrival of one to whom, according to the legend, is given the power of dispelling the mystical charm. Doré's conception is full of picturesque beauty—in the rich architecture of the stately edifice over which the climbing plants have grown with luxuriant wildness, and in the strange yet significant grouping of figures and animals. The fancy of the artist had abundant materials to work with, and he has made excellent use of them.

The ‘DORE GALLERY’ should be in the hands of every one desirous of possessing some collected record of the varied powers of the genius of this extraordinary artist: the 250 designs, accompanied by Mr. Ollier's appreciative essay and descriptions, are the best introduction that could well be offered for such a purpose.

THE
NEW BRITISH INSTITUTION,
39, OLD BOND STREET:

AT any other time than the present, surprise might have been expressed at the number of foreign works on the walls of this gallery. The much vexed question of hanging is fairly met and disposed of here, by such a discrimination of quality as apportion the best places to the best pictures. It is difficult, therefore, to understand why a gallery, so well lighted and so advantageously situated, is not more directly supported by an affluence of English painters of a certain reputation. On looking round, we see works by men of eminence, but they are few in comparison with the advantages offered. In all modern exhibitions that which is called “high art” is at a discount. The rule holds good here; we are attracted, however, to a very careful study by C. Lucy, ‘The Burial of Charles I. in St. George's Chapel, Windsor’ (72), wherein Bishop Juxon, in the act of reading the burial service, is peremptorily stopped by Colonel Whichcott, the Puritan governor of the castle. The only persons permitted to be present, were the Duke of Richmond, the Marquis of Hertford, Lords Lindsay and Southampton, and Sir Thomas Herbert. As Mr. Lucy's works are generally large, this, it will be understood, is preparatory to one of them, and will, in larger dimensions, come out very effectively. In ‘Francis I., Prisoner at Madrid’ (136), F. A. Fraustadt, the artist has selected a subject of many difficulties, which are not very triumphantly met. Francis became the prisoner of Charles at the battle of Pavia, and was at length removed from Italy to Spain, where his sister Margaret was permitted to join him. She is here in the act of consoling him in his distress. Of ‘Ariel’ (173), several versions have at different times been exhibited, we mean of that proposition presented in the lines—

“On the bat's back I do fly
After sunset merrily,”

but they have all been too heavy both for poetry and sorcery. In this case, Ariel looks still too weighty, but the dispositions are the best we have yet seen. He lies extended on the bat, and, in opposition to the broad disc of the moon, is flying over the sea. The whole idea is masterly and worthy of the very court of faydom. The artist is H. C. Selous, ‘Jouissance Spirituelle’ (7), P. Vander Ouderaa, presents a group of three figures in Venetian costume, and, by the way, in personal points very like the figures of Giorgione. In all its mechanism the work is of high merit, but the purpose of the artist has been directed less to putting his figures in communication with the observer, than to the fulfilment of the exigencies of execution and the observance of the proprieties of composition. ‘Bringing in the Boar's Head’ (198), H. S. Marks, A.R.A., shows us the head-cook of some noble family whose badge he wears, bearing into the hall the dish named, set forth according to the requirements of Christmas festivity in bygone days, when our country was called “Merrie Englande.” The cook has warmed to his work, and feels the importance of his office. He looks as if intended for transfer into a larger work. ‘A Naiad’ (61), W. E. Frost, R.A., is one of those charming oil-miniatures which Mr. Frost sends forth with such an accomplished grace. We know not why these unique studies should be so provokingly small. ‘The lost Child’ (44), E. W. Boks, is a carefully-painted picture, in which the story is very perspicuously told. No. 188, C. Calthrop—without title—speaks plainly the point of a sad history. A murder has been committed, and the son of the murdered man shows to two ladies the blood stains on the floor of the room where his father met his death. By J. W. Bromley is a picture called ‘Reproof,’ the scene of which is the inner vestibule of a cloister, where a girl has been surprised by one of the ecclesiastics in conversation with a youth, and is subjected by the monk to a grave reproof. There is much independence in the dispositions. ‘Reflections’ (60), J. W. Chapman, is a small study of a female figure sitting in reverie by the fire. If it be

intended as a memorandum for a larger production, something creditable may be made of it.

'The Hunting Party' (62), T. F. Marshall, shows rather the appointments of a hawking than a hunting party. 'Assunta' (64), H. Wallis, a profile, it may be supposed, of an Italian model, rich enough in mellow brown tints to have been painted from a genuine *contadina*, certainly not imitated from any of the thin and blanched features of those presumed natives of the *Campagna* of recent importation among us. Allusions to the war are not so numerous as might have been expected; there is, however, one very admirable study, 'Aid to the Wounded on the Battle Field' (165), T. Jones Barker, which, it may be presumed, is preparatory to a larger work. The scene presided over by the moon is strewn with all the *débris* of recent battle, and an angel of mercy in the form of one of our own countrywomen is binding up the wound of a French soldier. The study is complete in all its dispositions, and masterly in its style of narrative. From the theatre of action we are taken to Belleville by 'Vive la République' (59), T. Davidson, a well-painted head of an inhabitant of that faubourg where all is "rouge." Again we are reminded of the vacant places at the domestic hearth in 'War News' (152), A. J. Verhoeven Ball, wherein two ladies are weeping over a letter just received. 'The Jewel Casket' (74), and 'A Dutch Interior' (180), A. Savill Lumley, we instance as remarkable examples of resolute and successful labour. The executant is, we believe, youthful as a painter, but his work would bespeak maturity of study.

'La Débutante' (82), Haynes Williams, is a young actress receiving from her dresser the final touches to her costume. The picture has valuable points; the background especially is successful. 'Who touched me?' (56), J. Smeatham; it need scarcely be said that this alludes to the miracle wrought by our Saviour as described in the eighth chapter of St. Luke, the cure of the woman with the issue of blood. The subject is at once declared, but the composition is scarcely distributive enough for a picture. 'A Capuchin Monk' (91), A. Baccani, a single figure, is substantial and effective. 'Love and Jealousy' (121), F. De Bruycker. If the purpose of the painter here, be to describe rustic simplicity in its very simplest guise, he has succeeded to admiration. 'The Beggar Girl' (130), R. Schmitt, is a small life study (short half-length) of a child asking alms. In the features there is much sweetness of expression, and no trouble has been spared to render the study interesting. In 'The Church of Frari, Venice, hung for the Ceremony of Corpus Christi,' there is what is too frequently wanting in church-interiors, that is, a due assertion of space; it must be acknowledged that here the difficulty is amply met. In 'The Story of a Letter' (145), H. Dauriac, we have a perfect example of the best class of social French *genre*. The subject is utilised again and again every year. 'In Ambush, ready for a Spring' (176), C. Verlat, is a prettily told anecdote of how a happy family of ducks kept holiday in a weedy pool, unconscious of the presence of a hungry fox.

In the gallery are some landscapes of much power and truth. Prominent among these are—'Souvenir des Ardennes' (79), I. Van Luppen; 'A Dutch Village' (195), F. Lamorinière; 'Tintern Abbey' (155); and 'At Chiswick, Evening' (66), G. F. Tenniswood; others, by Lupton, Godet, Wüst, W. Williams, W. B. Scott, Couldery, S. R. Percy, J. Peel, Lidderdale, Meyer, G. A. Williams, A. Perigal, R.S.A., &c.; various others by J. Archer, R.S.A., W. Gale, H. H. Canty, T. Worsey, Mornewick, Macquoid, J. Hayllar, J. G. Naish, T. Grönlund, &c. Among the very best of the landscapes is one that bears a new name, Breanski; it is that of a young Englishman of Polish descent; we had noticed with high approval some works by him at the neighbouring exhibition in New Bond Street; of a surety he is destined to occupy a high place in the list of landscape-painters. A flower-picture, 'Where the Bee sucks' (23), W. J. Mückley, is a work of infinite sweetness and originality. There is also a screen containing water-colour drawings, several of which have been noticed on former occasions: many of them are of great excellence.

ALEXANDRA PARK.

It is not often that the journalist can congratulate himself on having pitched the key-note of an air in which his contemporaries, one by one, join in chorus with hardly a dissonant sound. To escape controversy may be the result of avoiding originality of opinion. To start new views, which are received with disapprobation, is a lot as common and as unsatisfactory as to maintain the dead level of commonplace. But to start a new theme, and to find each successive investigator of the subject join in asserting its importance, is a bit of good fortune which shows that, at least, the theme was worthy and well chosen.

Support of this general character has been given to those views as to the future of the Alexandra Park and Palace which the *Art-Journal* was the first to bring before the public. In our number for December, 1869, we gave a description of the noble park-like scenery and the superb grove that crown the swell of Muswell Hill, and spoke of the development which it was possible to give to the building that was there left to solitude and decay. In the following number we pointed out the danger that existed that this valuable district should fall into the hands of the builders, and become a smoke-producing, instead of a health-producing area. Further, we showed that, as compared with the Crystal Palace at Sydenham, the Alexandra Palace would be the natural centre of attraction of three-fourths of the residents of London, and of fourteen-fifteenths of those of the country at large. In March last we entered into the question of the rise in the value of land which had attended the formation of the Crystal Palace and of the South Kensington Museum in their respective localities. In the former instance we cited an increase, in fifteen years, at the rate of seven hundred per cent. In the latter we find an advance from the price of £3,250 per acre, at which the Kensington Gore estate was sold on the death of Lady Blessington, to that estimated by Mr. Cole in 1864, of £25,000 per acre. As a further illustration of the steady rise in the value of land within the area of a populous metropolitan district, we may mention that, on the occasion of a recent auction of the spare city land adjoining the Holborn-viaduct, offers at the rate of £212,000 per acre were refused.

We have received a little pamphlet composed of extracts from notices by the Public Press illustrating the capabilities and advantages of the Alexandra Park Tontine Association. Down to the commencement of November last, this work contains twenty articles, some of them of considerable length, from the *Sun*, the *Morning Advertiser*, the *Saturday Review*, *Lloyd's Weekly News*, the *City Press*, the *Railway Record*, the *Railway Gazette*, and various local papers. In all these the tone is the same. The beauty of the spot, the importance of its preservation, the public spirit and sagacious consideration evinced in the plan which Mr. Fuller and his friends have matured for the development of the property, are all very cordially acknowledged in these organs of public opinion.

By the time that these pages are in the hands of our readers, we anticipate that a definite appeal will have been made to the public, organised with such skill, and backed by such weighty and well-known names, as to leave little doubt of its full success. In that success we shall rejoice, less for the verification of our own predictions, than for the great boon that will thus be secured to the metropolis and to the country at large. The residents in the vicinity have shown that they fully appreciate the vital importance to the neighbourhood of the preservation and development of the Park. Their steady and hearty support has never failed since their attention was first asked on the subject in our columns. Nor have the actual proprietors shown themselves indisposed to deal with the subject on liberal terms, so soon as the costly and ruinous plague of internal dissension was stamped out. We believe that now, for the first time since the erection of the building, all persons interested are willing to pull together. If this really be so, the main difficulties of the case are overcome, and the opening of a noble source of instructive recreation is only a question of time.

ART IN SCOTLAND AND THE PROVINCES.

EDINBURGH.—A novel exhibition was opened a few weeks since, for the benefit of the Sick Children's Hospital. It consisted of rubbings taken from stones chiefly in Argyleshire, and from brasses in some of the eastern counties in England, by "Unda." The pictures—for pictures they are, although of a rude character—are exceedingly interesting, and represent sepulchral slabs containing effigies of knights and saints, priors and minstrels, ornamental crosses and stone tracery.

BIRMINGHAM.—The Birmingham Royal Society of Artists, in addition to its Spring Exhibition of Water-Colour Drawings, and its Autumn Exhibition of Oil-Paintings, has during the present session increased its usefulness by adding to its programme lectures on Art-subjects. In October last a course of four lectures on sculpture was delivered by Mr. H. Weekes, R.A., Professor of Sculpture to the Royal Academy. This was followed in November by a course of lectures on the Development of Gothic Architecture, by John Henry Chamberlain, Professor of Architecture to the R.B.S.A. A third course on Artistic Anatomy is about to commence, to be delivered by Mr. Furneaux Jordan, F.R.S.C., Professor of Anatomy to the R.B.S.A. The lectures already delivered have excited much interest, and have been well attended by the students of the Life Class and subscribers to the school.—The Spring Exhibition will be open to the public ere this is in the hands of our readers: we shall refer to it hereafter.—The Art-Museum for Birmingham (alluded to by us in the autumn of last year) is coming into shape. The purchases made from the India collection of metal-work, carvings in wood, ivory, &c.; the Venetian glass of Salviati; examples of English glass of local manufacture, by T. and E. Barnes, with a collection of Japanese enamels; examples of Lac work, lent by Mr. Frederick Elkington; also a number of very fine pictures, among which are examples by Reynolds, Müller, Linnell, Turner, and others, attract numerous visitors to the Free Art-Gallery of the town.—The designs for the Corporate Law Court buildings, to be erected in the vicinity of the Town Hall, have been sent in. The opportunity of adding to the architectural features of the town ought not to be lost sight of. Mr. Waterhouse has been selected as consulting architect of the Estates and Building Committee.—The forthcoming Exhibition of Industrial Art at South Kensington is exciting but little interest among either the manufacturers, or the public. The prominent features in it, *i.e.*, china wares, textile fabrics, and machinery, do not appeal to the industries of the town; but we understand a few of the leading manufacturers of metal-work and stained-glass have been invited to contribute some of their best examples.

NEWCASTLE-UPON-TYNE.—An exhibition of oil-pictures and water-colour drawings is about to be held in the galleries of Messrs. Hay, of this town.

SALFORD.—We have received the thirteenth annual report and financial statement of the Working-Men's College, Salford, for the year ending September 30th, 1870. This institution was established in 1858. The president of the council is the mayor, the vice-presidents and the trustees are the Bishop of Manchester and eleven other gentlemen of local mark. The numbers of students who have entered since the commencement of the college, have risen from 260 in 1858, to 767 in 1869. In 1870 there is a slight falling off, the numbers having sunk to 645. In April and May last thirty-two separate examinations were held in subjects taught at the college. Of these, twelve were under the rules of the department of Science, three under that of Art, eleven in subjects fostered by the Society of Arts, and six others under the Lancashire and Cheshire Institutes. Details of the examinations passed, and honours attained, are given in the report. The receipts for the year amount to £531 6s. 10d., the expenditure to £429 6s. 1d. The assets of the college are £2,722 6s. 10d., showing a healthy and promising financial condition.

THE COLLECTION OF SIR ROBERT PEEL, M.P.

EXACTLY a quarter of a century since, in the year 1846, appeared in our Journal an account of the collection of pictures formed by the late Sir Robert Peel, and adorning his mansion in Whitehall Gardens. The article in question formed one of the series of papers, which, at intervals, have appeared in our columns to this day, under the title of "Visits to Private Galleries;" and it was written with the concurrence and aid of the distinguished owner of the gallery. We could little have imagined then it would be our agreeable task to record the fact that this most valuable collection of pictures would become the property of the Nation; it is so, however; and as soon as arrangements can be made for the removal of the works, they will be added to the contents of the National Gallery in Trafalgar Square, to which they will form a most valuable and important addition—the more valuable because our National Gallery is comparatively weak in those schools and masters, in which the Peel collection is very strong; namely, *genre*-subjects and landscapes of the Dutch and Flemish schools, many of these painters are not represented at all in our national collection: their presence there will, consequently, be the more highly prized.

The sum for which the present Sir Robert Peel has consented to dispose of his treasures is stated to be £70,000; a most liberal estimate of their value on his part; for there cannot be a doubt that, if these seventy pictures—the number assumed—had been brought to the hammer of Messrs. Christie and Manson, they would have realised twice that amount, if not more. Parliament will not be called upon to vote a sum for this purchase. The Trustees of the National Gallery have considerable funds in hand, the unexpended balance of former grants; and as there is an annual subsidy by Government of £10,000 for the purchase of pictures, some arrangement, it is presumed, may be made, which the country will not feel as an additional burthen; but were it otherwise, and were Parliament asked to vote a sum for the special purpose, we are sure the public would approve of the bargain.

The works that are about to become, if they have not already become, the property of the nation are, so far as information has reached us, the following:—

RUBENS. 'The Chapeau de Paille,' a picture of boundless reputation; written and talked about wherever Art is known, and familiar to every class of amateurs by numerous engravings. It is the portrait of M^{lle}. Lunden, a young lady of the family of that name living in Antwerp in the time of the painter. So well-known a work needs no description: the lady herself is stated to have been the *belle* of Antwerp; and Rubens, when he painted the portrait, must have been excited by her charms to do them ample justice: it is undoubtedly one of the most fascinating pictures that human hand ever portrayed. By a strange perversion of sound, it has for a long time gone by the name of 'The Chapeau de Paille,' although it was formerly known as 'The Chapeau à l'Espagnole;' in Belgium it was called 'Het Spaansch Hoedje,' from the Spanish hat worn by the lady. Rubens is said to have valued it so highly that he would never part with it; and it is noted in the inventory of effects taken after his death as 'The portrait of a lady having one hand crossed on the other.' At the death of his widow, it became the property of the Lunden family, and so remained until the last descendant, a M. Van Haveren, sold it in 1817 to M. Stiers, of Antwerp, for £2,000, or, as others say, for £2,400. On the death of M. Stiers, in 1822, it was sold by auction in Antwerp, for about £3,000, to M. Nieuwenhuys, who brought it to London. The latter offered to sell it to George IV., who declined to purchase; and it was then exhibited for some time in Old Bond Street, where it was seen and admired by thousands. In 1823, it was at length sold to Sir Robert Peel, who is said to have given for it £3,500, the largest sum ever known to be paid for a half-length portrait.

Another famous picture, but one of a very different kind, by the same painter, is a bacchanalian scene, 'Silenus, with Satyrs, and other Figures;' all life-size half-length, painted with great brilliancy, and still retaining almost its freshness of colour. It was one of Rubens's favourite works, and remained in his possession till his death, when it passed, in 1640-2, into the hands of Cardinal Richelieu: it subsequently, according to Dr. Waagen, became the property of the Regent Duke of Orleans,—who presented it to a gentleman, as a mark of esteem, for some important service rendered to him,—and passed later through the following collections: De Tartre, Lucien Buonaparte, 1816; Bonnemaïson, 1827. It was sold by Mr. Smith to Sir Robert Peel for £1,100.

G. METSU. 'The Duet.' A most important work of this elaborate painter. A lady, holding a music-book, is preparing to sing; while a gentleman tunes his violin to accompany her. The picture, which has always borne a high character, has passed through the collections of Choiseul, Praslin, Solirene, and Talleyrand.

'The Music Lesson.' A lady at a harpsichord; a man with a champagne-glass near her: richly painted.

F. MIERIS. 'Le Corsage Rouge;' a title derived from the red tunic, trimmed with ermine, worn by a female, who is feeding a parrot. This gem of a picture has adorned the galleries of Gaignat, the Duke de Praslin, and Beckford, of Fonthill.

G. NETSCHER. 'A Lady with a Distaff,' dated 1671: she is habited in a yellow tunic, bordered with ermine, and a white satin petticoat. From the collections of Blondel de Gagny and Prince Galitzin.

'Maternal Instruction.' A girl being taught to read by her mother, while a younger child is playing on the floor with a dog. Waagen calls this "one of the artist's most pleasing pictures." It is engraved by De Launay, and was formerly in the Orleans gallery.

'Blowing Bubbles,' dated 1670, represents two boys thus amusing themselves. This work has always been esteemed among the best of Netscher's productions. It is well known from the engraving; and the various collections through which it has passed, evidence the desire for its acquisition: these are the galleries of Randon de Boisset, Poulain, De Calonne, Le Brun, and the Duchess de Berri; from the last it was purchased for £280, though not a foot square in superficial measurement.

G. DOU. 'The Dealer in Game.' A celebrated picture of this master, representing an old woman at an open window conversing with a young female about the purchase of a hare. There are two other persons introduced into this charming composition. The execution of the whole is marvellous, while the heads of the figures have a life, a vivacity, and an expression of character not always to be seen in the works of the artist—one of the most 'delicate finishers' of the old Dutch school. The estimated progressive value of it will be seen from the prices it has realised at various times. It was sold from the Duke de Choiseul's collection, in 1772, for £692; from the Prince de Conti's, in 1777, for £800; from the Duke de Chabot's, in 1787, for £832; at the sale of the Coupry Duprè collection, in 1821, it was bought in for £1,040, and was sold two years afterwards from the Beckford collection for 1,270 gs. What the late Sir Robert Peel gave for it we cannot ascertain, but undoubtedly it was not obtained for less than the last-mentioned sum.

G. TERBURG. 'The Music Lesson.' A *chef-d'œuvre* of this graceful painter: it represents a young lady, in a yellow velvet jacket trimmed with ermine, and a white satin petticoat, seated at a table, playing on a lute. Her master, on the opposite side of a table, accompanies her with his voice, while he beats time: another man is listening to the musicians; a spaniel and some splendid objects of furniture are also in the room. It was sold from the De Julienne collection, in 1767, for £112; from that of the Duke de Choiseul, in 1772, for £144; Prince de Conti's, in 1777, for £192; Marquis de l'Ange's, in 1781, for £234; Duke de Praslin's, in 1808, £520; De Serévillie's, in 1812, for £600; Prince Galitzin's, in

1825, for £972; and at M. Barchard's, a year afterwards, for about £1,000; the sum, it is believed, Sir Robert paid for it. Engraved in the "Choiseul Gallery."

JAN STEEN. 'The Music-Master,' signed, and dated 1671. A young girl, in a yellow stomacher and blue petticoat, seated at a harpsichord, her master is making some observation on her performance; a boy with a lute stands behind them. It is a work of very delicate execution, great freshness and clearness of colouring, and masterly *chiar-oscuro*. "It is seldom," remarks Waagen, "that he painted such pictures, which are very charming, and therefore fetch high prices." This was bought at a sale in Paris, in 1818, for about £310.

D. TENIERS. 'The Seasons.' Four small pictures, well known from the engravings by Levasseur and Sarrugue. Spring is personified by a young garruler bearing an orange-tree; Summer, by a reaper tying a sheaf; Autumn, by a peasant with a flask of wine in one hand and a glass in the other; and Winter, by an old man, habited in a furred cloak, and warming his hands. This series had previously adorned the collections of the Countess de Verrie, Le Prade, Blondel de Gagny, Gros, Nourri, Des-touches, Le Brun, and Prince Talleyrand. At the sale of the De Verrie Gallery, in 1737, it realised about £12; in 1717, when the Talleyrand collection was disposed of, the 'Seasons,' had risen in value to £180.

'La Surprise Fâcheuse.' The interior of a large kitchen, where is seen an old peasant caressing a young woman occupied in washing an earthen pan, while his wife sees the act from a door in the background, by which she is entering the apartment. In the best manner of Teniers's execution, particularly in all the details.

'Le Mauvais Riche,' is the title given to the figure of an old man, in a rich costume, tormented by a host of hideous figures and grotesque forms whom he has conjured up. Waagen calls this picture 'The Magician.'

P. DE HOOGE. 'Interior of a Paved Court,' round which grape-vines are clustering; a woman and a child are there introduced: the scene is beautifully lighted up with sunshine. Signed "P.D.H., 1658." In 1825, the sum of £945 was paid for it.

'An Interior,' with figures, possessing all the beautiful effects and gradations of light that entitle De Hooge to be called "the Cyp of Interiors." It represents two gentlemen and a lady seated at a table near a window, through which the sun is shining brightly. Formerly in the Pourtales collection.

HOBBEMA. No collection in the world, perhaps, can compare with that of Sir Robert Peel's in masterpieces by this rare and great landscape-painter. There are here four examples: the most important of which, sometimes called 'The Avenue,' from the rows of trees skirting a fore-shortened road, represents the village of Middleharne, supposed to be Hobbema's birthplace; the road leads to the village, situated in the background, from which the church rises conspicuously. On both sides of the road are nursery-grounds, in one of which a man is at work. It is a pure page of Nature, so unaffected and unadorned that it attracts at once; and yet, being the mere transcript of a scene of the most ordinary and commonplace description, we really forget it is a picture at all, but are deluded into a vision of reality of the objects represented. This picture was sold at Dort, in 1815, for a very small sum; in this country it realised a few years afterwards £800.

'The Water-Mill:' the stream covered with water-plants, amid which three ducks are swimming; there are also several cottages surrounded by trees, and lighted up by the sunbeams breaking through a veil of thin clouds. A fine picture.

'A Woody Scene.' A charming small painting of elaborate finish, and true to the freshness of Nature.

'Ruins of the Castle of Brederode, Holland,' dated 1667. A magnificent landscape, less encumbered with trees, and of a more classical character than usual with this painter. The reflections in the water of the ruin are given with the most perfect illusion. Sir Robert Peel paid Mr. Nieuwenhuys £880 for it.

We can do no more now, for want of room, than indicate a few of the other leading masters represented in the collection, with the titles of some of their pictures.

P. WOUVERMAN, by whom are six works:—'Interior of a Stable,' with ladies and cavaliers; from the collections of the Count de Merl and Mr. Watson Taylor.

'La Belle Latière,' engraved by Le Bas, under the title of '*Halte de Officiers*,' formerly in the collections of the Count Dubarry, Poulain, and Mr. Webb.

'Coast Scene, with Fishermen.' An interesting history is attached to this small picture. Wouverman is known to have passed a great part of his life in straitened circumstances. Elizabeth, Queen of Spain, hearing of his talents, commissioned him to paint a picture for her; this coast-scene is the result: unhappily, payment for it did not reach the abode of the artist till a few days after his death. The royal arms of Spain, and the words "Elizabetha Regina" are on the back of the painting.

'The Ass,' which stands upon a hill against a background of landscape; in the middle ground are four figures and a grey horse lying down. Engraved in the Choseul gallery.

'Sandy Road and Figures,' a small picture, with minute figures of great excellence.

'The Grey Horse,' on which a man is placing faggots; a woman, child, and dog complete the group.

W. VAN DE VELDE the Younger. Of this famous marine-painter are no fewer than eight examples.

'A Light Breeze,' with indications of an approaching storm. From the collection of Lord Charles Townshend.

'A Calm,' dated 1661. An exceedingly fine picture in the artist's most brilliant manner; formerly in the gallery of the Duke de Berri. The sum of £500 was paid for this beautiful little picture.

'A Calm,' dated 1654. Good, but not equal to the last. Cost £300.

'The Beach at Scheveling.' The very perfection of coast-scenery for execution, and enriched with some admirable figures by A. Van de Velde. Formerly in the possession of M. Schimmelpennick and of Count Pourtales. Bought for £800.

Another 'Calm.' From the Choseul Gallery.

'A Light Breeze.'

'A Gale.'

The two last from the Pourtales collection.

'The Dutch Coast.'

A. VAN DE VELDE. 'Winter Amusements.' Truthful and vigorous in execution. Formerly in the collection of Mariette, the Prince de Conti and Count Pourtales.

'Crossing the Brook.' Of excellent quality, painted with singular firmness, and brilliant in colour. From the collections of Randon de Boisset, the Duke de Praslin, M. Helsleuter, and Sir Simon Clarke, at whose sale it was purchased by Sir Robert at the price of 750 gs.

J. RUISDAEL. 'The Waterfall.' One of the best pictures of this master. Formerly in the Bretano collection, and subsequently in that of Lord Charles Townshend, from whom it was bought by its late owner.

'A Winter Landscape.'

'The Sportsman,' in a group of oaks, with a white dog running through a pond.

J. WYNANTS. 'Landscape.' A passage of barren scenery, enlivened by some capital figures by A. Van de Velde.

'Landscape,' with figures, by Lingelbach.

P. POTTER. 'Landscape and Cattle,' dated 1654. One of the painter's latest and most exquisite works, and one of the gems of the collection. Formerly in the possession of Lindert de Neuville, Van Loquet, of Amsterdam, and Lord Gwydir, from the last of whom it was obtained for 1,200 gs.

L. BACKHUIZEN. 'The Mouth of the Thames.' A large picture, with stormy effect.

'Coast-Scene.' On the beach are several figures and a vessel. Engraved in the Le Brun gallery.

Other artists, of whom examples will be found in the collection, are Van Ostade, Du Jardin, Cuypp, Gonzales, Moucheron, De Koningh, Slingelandt, Hackaert, Vanderheyden, &c.

THE NATIONAL GALLERY.

THE Report of Mr. Boxall, Director of the National Gallery, for the past year, has been issued in conformity with the order of the House of Commons. The document is short, but contains some details not without interest.

The first refers to the purchases that have been made. These are, 'An Interior, with an Old Woman peeling Apples,' by D. Teniers, bought of Mr. G. H. Phillips, for £600; 'St. Peter, Martyr,' by G. Bellini, bought of Signor G. Baslini, of Milan, for £280; 'The Procession to Calvary,' by B. Boccaccino, also bought of Signor Baslini, for £360; 'The Madonna and Infant Christ, St. John the Baptist, and Angels,' assumed to be by Michel Angelo, purchased from the executors of the late Lord Taunton, for £2,000; 'The Incredulity of St. Thomas,' by Conegliano, purchased from the authorities of the town and hospital of Portogruaro, for £1,800. These purchases were made with the balance £4,503 12s. remaining in the hands of the Trustees at the commencement of the year, and a portion of the parliamentary grant of £10,000, for 1870-71, for the purchase of pictures. The balance now in hand is £9,500.

The following paintings have become the property of the nation from bequests and donations:—'The Madonna and Child enthroned, with St. Francis and St. Sebastian,' by C. Crivelli, presented by "Elizabeth Mary, widow of Richard, second Marquis of Westminster;" 'Pardon Day in Brittany,' by Charles Poussin, presented by Mr. R. E. Loft—placed in the gallery at South Kensington; 'Rocky Landscape, with Tobias and the Angel,' Salvator Rosa, presented by Mr. Wynn Ellis; 'Fishing Boats in a Breeze, off the Coast,' J. M. W. Turner, R.A.; 'Dutch Shipping and Boats in a Calm,' P. J. Clays; 'Dutch Boats lying in the Roads of Flushing,' also by P. J. Clays. The last three paintings were selected from the bequest of the late Mr. J. M. Parsons, and have been placed in the South Kensington collection.

The pictures which have undergone restoration are Stothard's 'Greek Vintage,' G. Pousin's 'Landscape, with Dido and Æneas taking shelter from the Storm,' and Claude's 'Landscape, with Cephalus and Procris.'

Fourteen works have been covered with glass during the year, to screen them from dust and impure air, namely,—Sir E. Landseer's 'Peace,' 'War,' and 'Alexander and Diogenes,' Wilkie's 'Portrait of T. Daniell, R.A.,' 'The Circumcision,' by Marziale; 'St. Peter, Martyr,' by Bellini; 'Madonna and Child' &c., by Michel Angelo; 'Old Woman Peeling Pears,' by Teniers; 'Marriage of St. Catherine,' by Borgognone; 'Landscape, with Death of St. Peter, Martyr,' by Bellini; 'Fishing-Boats in a Breeze,' J. M. W. Turner; 'A Greek Vintage,' T. Stothard; 'Dutch Shipping,' by Clays; and 'Landscape, with the Story of Cephalus and Procris,' by Claude.

The number of pictures by foreign or old masters which have been copied by students and others, is 52; by modern painters, 87. Of the former 137 copies were made; of the latter 232. The favourites among the old paintings were Van Dyck's portrait of Gevartius, copied 12 times; Rembrandt's portrait of an Old Lady, 10 times, Rembrandt's portrait of himself, 9 times; and Velasquez's portrait of Philip IV. of Spain, 8 times. The majority of copies, it will be seen, were of portraits. Of modern painters, Turner's 'Fighting Temeraire,' was copied 12 times; Uwins's 'Le Chapeau de Brigand,' 12 times; Dubufe's 'The Surprise,' 10 times; Herring's 'The Frugal Meal,' 9 times; Reynolds's 'Age of Innocence,' 8 times. Creswick, Constable, Collins, and Stanfield, stand the next highest on the list. One may naturally ask, what becomes of these copies, amounting in the aggregate to 369? We fancy that some of them, and of previous similar "studies," may be seen in shop-windows where questionable *works of Art* are displayed.

As many as 327 new students were entered in the books in 1870. The number of visitors at the Trafalgar Square collection is set down at 898,715; and to the South Kensington galleries at 1,014,849; in the latter case it is assumed

that all who go to the Museum visit also the picture-collection. How the authorities manage to arrive at the above, or indeed at any, result, so far as the Trafalgar Square galleries are concerned, we cannot tell; for there is there no turnstile, nor any other means of "numbering the people" that we are aware of. Visitors go in and out without any check.

The Report alludes to the acquisition of what was the room—or, as we should term it, cellar—used by the Royal Academy for the exhibition of sculpture. The National Gallery "has acquired by this arrangement a large well-lighted room for the reception, inspection, and repairing of pictures; the former repairing-room has been appropriated for the conservation and special exhibition, on students' days, of that portion of the Turner Drawings and Sketches which is kept in cases; and the former room used for this purpose has, by the sanction of the Treasury, been fitted up with glass book-cases for the library of the late Sir Charles Eastlake, purchased in pursuance of a vote in Parliament in the month of March last" (1870). "The books were arranged and classified on their shelves in the month of November, and a catalogue of them is now in course of preparation."

The country has, we sincerely believe, full reason to be satisfied with the management of its National Gallery; one which is not surpassed in point of the valuable works it contains, by any collection in the world; though other public galleries may boast of a larger number of pictures. They are, for the most part, admirably hung, now the Royal Academy has moved away from Trafalgar Square, and are carefully looked after. Mr. Boxall, the director, is not, as it has been stated, about to leave his post; he had, we believe, purposed to do so, but consents to remain. Sir Walter James has been appointed a trustee in the place of Lord Overstone, the oldest on the list, who has resigned. The others are the Marquis of Northampton, Messrs. T. Baring, W. H. Gregory, A. H. Layard, and W. Russell.

ARTISTS' GENERAL BENEVOLENT INSTITUTION.

THE fifty-sixth annual report of this association has reached us. Like all its predecessors, especially those of many past years, it is a gratifying document, for it speaks of "the increasing prosperity of the Institution, and the appreciation of its merits evinced by the public, in proof of which the Council have been enabled to meet liberally the claims upon the funds during 1870, a larger sum having been bestowed in grants to applicants than in any previous year during the existence of the Charity." This is certainly most satisfactory. The income of the Institution amounted last year to somewhat over £2,470; out of which £1,750 went to the relief of ninety applicants, of whom twelve "urgent cases" received £400; an historical and portrait painter, with six children, and with impaired eye-sight from injury, receiving £70, the largest sum given away. A novel feature appears in the report; but it is one in some measure similar to that we advocated five or six years ago in our columns, and endeavoured to establish; desisting only from the attempt when we found, after much inquiry, that there were really none to derive benefit from our proposition, which was to provide a home, or school, for the orphan children of artists. The Institution has now taken up the case of such destitutes, and proposes at once, "The formation of a separate fund for the support and education of orphan children of artists." Our plan was to erect a building for their special use: that now put forth may best be described in the words of the circular inviting attention to it:—

"The interest of the Fund will be applied in giving both boys and girls a good sound education, by placing them in such Schools or Orphan Asylums as the Committee may select, according to the circumstances of their friends, and the part of the United Kingdom where they reside.

In many cases it will be undesirable to remove the child from the home influence of the surviving parent or other relation, in which case a sum of money will be voted yearly, subject to securing certificates from the head of an approved school, that the child is regular in attendance, &c. In other cases where the child has no surviving parent, or one who could not provide a proper home, existing Institutions would be found ready to take the child on payment of a certain sum yearly.

"By a scheme of this nature, all the heavy expense and responsibility of a building or buildings, with their necessary staff, will be avoided, and the entire annual proceeds of the Fund will be applied to the objects for which it is intended without any deduction; the working expenses will be very slight, as the management will be grafted on the business of the parent Institution."

The plan may be found to work well, and we trust will do so, though we see some objections to it; such, for example, as that the managers, or committee, of this Orphan Fund, will have no direct control of the education, &c., of the child. It is, however, thought by its promoters that—

"Such a scheme, economical and elastic in its operations, easily adapted to the ever-varying wants of children springing from different classes of society, from parents of different religious belief, and of different pecuniary circumstances will, it is believed, be productive of immense usefulness to the destitute orphans of Artists; and is also in harmony with the principles of the Artists' General Benevolent Institution, which knows no distinction of creed, relieves both sexes, and in its administration has earned the reputation, since its establishment in 1814, of being the most efficient, and at the same time, the most economical in its management of all the Charitable Institutions of a similar character."

The subscription-list opens well: it is headed by the munificent gift of £1,000 by Sir W. Tite, M.P., and is followed by a donation of £500 from the Royal Academy. The names of the late P. Hardwick, R.A., and Mr. P. C. Hardwick, appear for £250 each; those of Messrs. R. Ansdell, R.A., F. Leighton, R.A., J. E. Millais, R.A., J. A. Lewis, R.A., G. E. Street, A.R.A., John Murray, and James Reiss, for £100 each; Mr. T. Hyde Hills, and Mr. T. H. A. Poynder, for 50 gs.; Mr. W. C. T. Dobson, A.R.A. £51; Messrs. R. Newsham, G. Plucknett, G. G. Scott, R.A., and T. H. Woods, for £50 each; Lady Chantrey, £41; subscribers of sums more or less below these, are numerous.

The Committee earnestly desires to raise the sum necessary for this Fund in the course of 1871, as there is no intention of renewing the appeal to the public, all its efforts being required to keep up the funds of the parent Institution. We heartily trust the appeal will be answered in such a way as to permit the Committee to carry out their most praiseworthy object. The publicity we now give it may, and we hope, will, aid to effect such result. The Committee, of which Sir Francis Grant, P.R.A., is president, includes the names of artists and other gentlemen whose reputation is a guarantee of success.

His Royal Highness the Prince of Wales has consented to preside at the annual banquet on the 6th of May. The proceeds, it is stated, are to be devoted to the Orphan Fund.

ART IN CONTINENTAL STATES.

CHICAGO.—A statue of Hagar, by Miss Edmonia Lewis, has been erected in Farwell Hall, in this city. The artist, a coloured lady, is said to be the daughter of a Chippewah Indian and an African negro; who, after being educated at Boston, studied in Rome, and has now settled in Chicago.

VIENNA.—The "Kunstwerke und Gerathe," of the Middle Ages and of the Renaissance, published at Vienna, may be regarded rather as an instance of what may be attempted with great success in England than as a triumph of

Austrian photographers. The work is illustrated by photographs, which are for the most part very poor, and very ill mounted. This is the more to be regretted, as many of the subjects are well chosen, and of much intrinsic merit. Such, for example, is a carving in high relief, by Martin Schongauer, of the 'Flight into Egypt.' The Madonna sits on the orthodox donkey, and is riding between a nondescript tree resembling a cactus, and a palm, laden, not only with fruit, but with angels, that bows its head to the grasp of Joseph, who, beside the implements of his craft, has a German pilgrim's bottle slung on his back. The composition recalls one of the oldest, and not the most delicate, of our Christmas carols. Another interesting print is the trophy of arms of Karl IX., König von Frankreich, 1561. The extravagant, almost floriated, style in which the lion on the shield and the greyhound-waisted griffins that support it are delineated, would be charming to the gaze of the glass-painter who sought for heraldic patterns. This style of bearing is by no means peculiar to Germany, as we have many examples of old French bearings that are equally grotesque. But the tremendous crests—one of them a plume of feathers that must be at least a yard high in their stiff fan-like expansion, is thoroughly Teutonic. Two very well executed medallion portraits hanging below, show that crests and bearings were not the work of any but a well-skilled artist. Again we have a marble medallion of Matias Corvinus, King of Hungary, who died in 1490, and a companion relief of Beatrix of Arragon, his queen. These photographs are valuable for their physiognomical truth no less than for the excellence of their workmanship. Again we have the effigies of Frederick the Wise, date 1525: a prince with an under-lip that looks as if he were mighty to give judgment on the different vintages of the Rhine. A ponderous iron chest, architecturally designed, surrounded by columns, and bearing a statuette on its cover, is fastened by the very grandfather of padlocks, so old, that it is hard to tell whether he is pad, or plain, lock. Then we have a drink-beaker in the form of a galley, more fit to circumnavigate the table than to make any acquaintance with water. The cross of Rudolf von Hapsburg, the founder of the Austrian line; and a curious relief showing St. Eloi, the patron saint of goldsmiths, engaged in his mundane occupation, bring us to the end of the most remarkable specimens photographed in this book. A work—or series of works, of the same nature, descriptive of our English museums, public and private, and illustrated by one of the permanent methods of printing from plates obtained by the aid of photography, as mentioned in our recent numbers, would be of very great value to the Art-workmen of this country.—Numerous ornamental fountains, of more or less architectural and sculptural importance, are to be erected in this city, under the instructions and supervision of the Municipal Council. Several of the principal squares and places of public resort have been already mentioned as sites for their reception.—We have seen a recent number of a large serial in course of publication at Vienna, under the title of the *Atlas of Ecclesiastical Monuments of the Austrian Empire, and of the Lombardo-Venetian Kingdom*. There is a strange persistence evinced by this title in regarding as yet alive the policy of the house of Hapsburg, which was definitively overthrown in 1866, in this union of the Austrian provinces with those held under the iron crown. But the work is one of much interest. The decorations of some of the buildings in the late number, half Romanesque, half, it would seem, Saracenic, are quaint and forcible. The work is one well deserving study. Though of more avail to the architect than to the Art-workman, it has its value for both.

WASHINGTON.—The statue, in marble, of Abraham Lincoln, by Miss Vinnie Ream, has been placed in the Rotunda of the Capitol, where it was unveiled, on the 25th of January, before the President and Congress. The opinions of critics seem to differ very widely on the merits of the work.

ST. JAMES'S GALLERY, 17, REGENT STREET.

THE excellence of the pictures constituting this collection, of which Mr. Brooks is the proprietor, merits a longer notice than is usually given in these pages to similar gatherings. We find works here of the highest class, which have never been exhibited—productions by the most eminent painters of our time, which should not be passed by without some slight record of their existence. Here is what we may call an affluence of the works of the elder Linnell, some of which are of a character quite new even to us. These alone, especially the water-colours, are worthy of a much longer description than we have been able to give them. There are examples of foreign Art of the rarest excellence, and a great proportion of those by members of our own school are equally fine.

The most brilliant and careful picture painted by J. Linnell of late years, he has called 'Setting Up,' which refers to disposition of the sheaves in a harvest-field. The concentration of power and finish in this work would argue that Mr. Linnell has but just reached his term of maturity. It is not often that the eye is seduced by the living element in these works from the sublime traits of nature. The resemblance, however, of the colour of the figures in 'The Mountain Shepherds' is similar to that of Mulready, and it must so strike observers generally. This picture has been engraved for the *Art-Journal*, but is not yet published. 'The Woodcutters,' by the same artist, is very rich in colour, but not so much forced in that direction as others he has recently painted. In all his productions the living incident is nothing, the eye being instantly attracted to, and resting on, the present and retiring masses of mellow foliage, presented to the view by a device always practised successfully by Mr. Linnell. By placing us on an eminence we see over the woods intervening between the foreground and the mysterious distance. Although commanding every form and tint of drapery in the skies, he evidently proposes the sylvan landscape as a triumph of colour, and it is so—thus there is no competition in the sky. A smaller picture, 'Redstone Wood,' is a view of another character, showing simply a passage of close wooded scenery, given with more severity and all that enchanting simplicity which is the last excellence attainable in everything. Both these pictures are, we believe, recent; and they are marvellous in taste and power for a man of Mr. Linnell's years. His renown is further sustained by 'The Mountain Track'—a kind of bridge-path or sheep-track, winding through a narrow valley, which separates two lofty backs of land, covered with dense vegetation. We might become weary of the painter's flocks and shepherds, were it not that they are simply introduced to suggest a suspicion of civilisation, and such supplementary passages of animated nature are so subordinated to the main elements of the composition as to appear only when they are sought. Contrasting in a great degree with Mr. Linnell's varied composition and richness of colour, is a very quiet, but irresistibly captivating, picture by Turner—a passage of waterside scenery, 'On the Brent,' and what may be called, considering Turner's long life, an early picture: it is a tranquil surface of water, with sedge banks and a few trees, that is all—and we look in vain for a key to the magic which binds the fascinated sense to the picture. It is because the subject is so simple that we are the more affected by its tone of exaltation. In quite another feeling is Nasmyth's small picture, 'A Summer Day.' We know not whether we should compliment his robust Art by calling him the English Hobbema. His works were not less truisms than those of Hobbema, and he cannot be said to have surpassed the foreigner because he did not paint pictures comparable to those of the latter in size. He was unfortunately extravagant in small things, but in these he surpassed in many points all the Low Country landscape-painters. This is an exquisite picture.

By F. R. Lee, R.A., and T. S. Cooper, R.A., is 'Welsh Mountains and Cattle,' presenting a passage of very grand scenery, with a comple-

ment of rustics with their flocks and herds. This is the first example we remember of this class of subject from the hand of Mr. Lee. The work is highly creditable to both artists. 'The Auld Mare, Maggie,' J. Faed, R.S.A., has a very direct and literal reference to the verse of Burns; we have never seen the subject treated before, but whenever it is again chosen it cannot be rendered with more perfect fidelity. Differing in every thing from the Burns subject, in 'An Old Covenantant,' Mr. Faed breaks a lance with Meissonnier. It is a single figure—an old man in the civil costume of the last century resting on his sheathed sword. In tenderness of finish it is superb. Again, 'The Toilet' exemplifies endless resource in story-telling—it presents a girl in one of the rich figured brocade dresses of the last century. She is viewing herself in a glass, there are consequently two figures. This, with the painter, has been evidently a *con amore* performance. 'The Water Witch,' W. Oliver, is in everything a conception highly original, as showing a young lady temptingly, with the artificial fly, the finny denizens of a trout-pool; the figure is most carefully painted; not less successful are those in 'Hard Lines,' a little boy at his lesson; and 'Counting the Cost,' both by the same hand. There are two very characteristic figures by E. Nicol, A.R.A., both of which tell us their thoughts in very plain language.

Certainly more sparkling and brilliant than the large picture, is the section we see here of 'An Episode of the Happier Days of Charles I.,' painted many years ago by F. Goodall, R.A. It is limited to that part of the barge in which appear the queen and one of the princes, afterwards Charles II., feeding the swans. The lustrous brightness of the colouring throws everything near it into shade. From this we turn to another by Mr. Goodall, 'The Cottage Door,' a glimpse of one of those humble interiors in the realisation of which the artist stands alone. The life of the picture is a girl nursing a child. So sweet is the colour and so gentle is the Art of this little picture, that it looks as if the colour had been magically blown on to the canvas. There is another work bearing the names of F. and E. Goodall; it is a view in Venice, of which the architecture has been painted by the latter, and the figures by the former. 'The Principal Group in the Derby Day' is an elegant extract by Mr. Frith himself, in which we submit he has improved on the original agroupment—certainly in point of brilliancy. Of 'The First Appeal,' by F. Stone, A.R.A., nothing here need be said; it is established in public favour by the engraving. Of 'The Young Musicians,' A. Burr, the centre piece is a boy playing the flute, surrounded by an admiring group of brothers and sisters. Both performer and audience are perfect in expression. The quality of the picture is admirable as a scene in humble life. 'The Gloves, the Secret told,' is another of the works of W. Oliver, and, in our opinion, the most pointed of his productions in this collection. Here the story is told of a maiden of the lower social scale. Her mother produces the glove with a cold impassible look more cutting than words. The poor girl attempts to conceal her confusion by fixing her attention on her work. The unfortunate evidence of the recent visit cannot be gainsayed. 'Happy Moments,' is the title given to one of those romantic episodes which F. R. Pickersgill, R.A., describes in terms so poetic and taste so refined. It presents simply a company of ladies listening to the lay of a troubadour, who may be interesting them in the triumphs of valorous knights or the trials of unhappy lovers. 'The Wedding,' G. E. Hicks, shows the assemblage in the drawing-room before the ceremony. The artist has forgotten nothing which can enhance the graces of the situation. 'The Dame's School,' A. Rankley, is painted with much firmness, and the conceptions respectively of the scholars develop wonderful variety of youthful character. 'The Village Barber,' A. Burr, introduces a woman well stricken in years; she is cutting the hair of a boy who shrinks under the operation, for her practice is remorseless, as is seen in the fixed resolution of her features. The shop is full of youthful customers waiting their turn, and each

is most successfully individualised; indeed, it cannot well be seen how the picture could be improved. In 'A Scene from Sir Walter Scott's Novel, "Woodstock,"' by Holman Hunt, we see Sir Henry Lee reading the evening service, and his daughter Alice, an attentive hearer, seated at his feet. They are interrupted by the entrance of Colonel Everard. The picture is interesting and valuable as an example of Mr. Hunt's method of working before he adopted Pre-Raffaellism. The situations are natural, the impersonations accurately rendered from the text, and it is altogether preferable to many of Mr. Hunt's recent productions.

There are several important works by James Webb, notably a very large view of Brighton from the end of the new pier, certainly the most successful and comprehensive that has ever been painted, as showing the entire sea-front from the Bedford Hotel to the old Chain-Pier. This picture is to be engraved. By the same artist are also 'Cadiz,' 'Seville,' 'Gibraltar,' and 'San Sebastian.' This artist has made great and marked progress of late years; he now holds a very high rank in his profession, and may be safely compared with Clark or Stanfield—whose manner he has adopted, but without subjecting himself to the charge of imitation. 'A Speaking Likeness' and 'Reflection,' are two very charming pictures by Schlesinger; they were in the Demidoff collection. Works also of great power, beauty, and interest, are 'Bedtime,' by E. Frère; 'The Graces,' W. E. Frost, R.A.; several very highly-finished groups of cattle and sheep, by T. S. Cooper, R.A.; 'Sunday Morning,' by M. Anthony, a subject from the "Vicar of Wakefield;" 'View in the Highlands,' T. Creswick, R.A. 'Windsor Castle from the Thames,' by Callcott, would form an admirable pendant to Turner's 'View on the Brent.' 'Near Newcastle,' T. M. Richardson, is the only oil-picture we have seen by this artist. 'The Harvest Field,' by James Linnell, is a large landscape, and assuredly the most complete and masterly he has produced. A 'View in Surrey,' is by the same artist, and equally fine. To these we must add 'The Priest's Visit,' J. B. Burgess; 'Dressing the Bride,' A. Solomon; 'The Ferry Boat,' Veyrassat; 'The Three Fishermen,' from Kingsley's Poems; 'A Visit from the Pastor's Daughter,' W. P. Knight; 'The Altar-piece of the Cathedral at Seville,' Dauzats; 'The Page,' 'Household Cares,' and 'The Rustic Toilet,' W. Fyfe; and a theme in a higher key than any of the last named, 'The Child of Elle,' A. F. Payne, a noble agroupment from the old ballad of the same title. Mr. Fyfe has sustained his claim to high professional rank; he will take the place of Phillip, and is even now among the foremost artists of the time. Mr. Payne, too, is justly prominent among the most promising of the modern British school. Although as yet comparatively little known, he is destined to take rank among the best of our English artists.

The water-colour drawings here are perhaps more uniform in their rare quality than even the oil-pictures. They are not very numerous, but are unexceptionably select; and it is only necessary to mention such names as Copley Fielding, J. Linnell, D. Roberts, R.A., C. Stanfield, R.A., Meissonnier, Rosa Bonheur, &c., in confirmation of their worth and beauty. When we mention Linnell it is not in reference to some accidental offshot of bygone years, the memory of which is lost in the deep twilight of their very remoteness; but with reference to others, dating, we may say, only from last week, by which every Art-lover is surprised into rapture.

These drawings may be examined to discover some natural failing of the eyesight after a man has lived beyond the allotted span; but there is no such evidence. From what is here said it will be understood that they are among the most exciting of Linnell's labours. We are only too happy to preserve a record of them as we see them here, for they may never appear thus collectively on the walls of an exhibition. We can only briefly describe them to assist future recognition. There is a pen sketch for the picture, 'Mountain Shepherds,' and a similar memorandum for 'The Woodcutters,' 'Bringing Home the Flock,' 'North End—Hamp-

stead,' 'Going Milking,' a composition of trees and distance, and a section of roadside with a glimpse of distance. These being exceptional works, it was found on inquiry that they were executed expressly for Mr. Brooks.

There is by Meissonnier an extraordinary drawing made by Imperial command, and representing the Ex-Empress of the French and the Prince Imperial receiving a deputation at Nancy. It would seem absurd to attempt likenesses in figures so minute, but we recognise at once General Fleury; and the portraits of the Empress and the Prince are unmistakable. The drawing to ordinary eyes would seem to have been made for engraving, and through a microscope, and by similar means alone, could it be translated on copper. 'Fontainebleau—Twilight,' is a very fine drawing by Rosa Bonheur, wherein is a family of deer listening to the last sounds of the closing day, to determine whether they may confidently betake themselves to rest for the night. By Guido Bach, another foreign artist, there is 'A Shepherd Boy,' a study of much sweetness, and two guard-room subjects by Louis Haghe, of which it is enough to say that they are in everything up to the quality of his best works. Also by Haghe is 'An Incident in the late War,' which comes home to us with a force more immediate than the preceding: it would tell effectively as an engraving.

Of the many new versions we have seen of Little Red Riding Hood there is one here by H. Le Jeune, A.R.A., the high merits of which will be sufficiently understood, when it is said that it is in no wise inferior in feeling to the studies of Reynolds, who characterised children with more of youthful emphasis than has been given to them since his time. By W. Hough are two or three drawings which merit especial notice. One is a fruit-piece—a pine, white and black grapes, plums, &c.—of a brilliancy in colour, tenderness of surface, and delicacy of finish, not surpassed even in W. Hunt's most careful works. The other two are pendants, the one being a chaffinch leaving its nest, the other, the same bird returning. The requirements in water-colour Art cannot be carried farther than in these brilliant drawings. 'Out of Breath' and 'Summer' are two works by Birket Foster, containing more of landscape-perspective than he usually gives, together with all his delicacy of sky-painting, and spirit in the presentation of rustic children. 'The Encampment at Jericho' must not be forgotten: it is one of the gems of the Oriental series by David Roberts, R.A. By C. Stanfield, R.A., 'Broadstairs Pier,' must be noted; and a work by Copley Fielding, 'Windsor Castle from the Home Park.'

Besides the works already mentioned is a selection from the elder schools of which we heard only when too late to describe. There is the famous 'Flora,' by Greuze, from the Demidoff collection; which in chastity, sweetness of manipulation, and other points, may be safely accounted a *chef-d'œuvre*. This picture is, we are informed, about to be described in a supplement to Smith's 'Catalogue.' Besides this are three others by this fascinating painter. By Berchem are two high-class works; by Richard Wilson several; and a grand landscape by Salvator Rosa; three by Sir Joshua Reynolds, one of them, 'Master Coke, as young Hannibal,' the engraved picture; two by Rubens, one by Murillo, one by Claude, and very important pictures by Morland; among them one of the most careful and successful productions of his best time; and others by Van Tol, Wynants, Old Crome, Both, &c. All these have, we believe, at one time or another found places among the attractions of select private galleries.

The pictures arranged in this gallery form an exhibition attractive and instructive; one that will amply repay a careful inspection.

[Since this notice was written, Mr. Brooks has announced his intention to dispose of his collection (at Christie and Manson's), on the 29th April and the 1st May. We see no reason, however, why we should not allow this notice to "stand;" it is now the collection of a dealer: it will soon be distributed among the best collections of the Kingdom.]

THE PROSPECTS
OF THE
INTERNATIONAL EXHIBITION,
1871.

At the period at which we are compelled to write, it is difficult to give a very clear idea of the position of affairs in the various portions of the buildings to be devoted to the International gathering intended to be inaugurated on the 1st of May. In some respects the prospects are very satisfactory, and in the class of pottery, which forms one of the special features of the Exhibition, the English contributions sent for inspection by the committee of selection are numerous and cover nearly the whole ground of this important Art-industry. The products of the leading manufacturers appear to be fairly represented—not so much, however, by extravagant special efforts, or *tours de force*, as by exceptional combinations of Art-skill in relation to the every-day demands of their trade. This is a healthy symptom, and one on which the public may be congratulated. The whole of the pottery, porcelain, and kindred products will be arranged and exhibited in the ground-floor of the eastern wing of the erections on the sides of the Royal Horticultural Gardens; and the arrangements as to glass-cases, which are provided by the authorities of the Exhibition, and more important still, the character of light, promises to be all that can be desired.

The woollen manufactures, mixed fabrics, &c., which is the second special class of this year, appear at present to be in a somewhat problematical condition, alike as regards the extent to which these important national industries will be illustrated, as also as to the arrangements for the display of the goods. Manufacturers complain to us that they do not know what course is really best to take. Each speciality of the woollen and worsted trades requires distinct consideration, whilst the mixed fabrics are so varied in character, alike as regards the materials in mixture and the character and size of the patterns when decorated, that the arbitrary regulations of the Royal Commission have no practical bearing upon the necessities of the case.

The education-class seems likely to have a thoroughly good and useful series of exhibits. The present is an important period for all connected with the manufacture and production of material aids to education; therefore it is of the greatest moment to them that no effort should be spared to bring the best and most carefully considered means for facilitating the primary instruction of the people before those whose duty it is to see that education is not carried on in the hap-hazard fashion that too frequently prevails.

The department of machinery does not present any striking results, so far as the contributions sent in are concerned.

The section of the Fine Arts is essentially the most promising as regards quantity; and no doubt quality will be secured, so far as the oil-paintings and water-colour drawings are concerned, by an extensive weeding out. This is inevitable, as at least three times as many British pictures have been sent as can possibly be hung. Sculpture, too, appears likely to be fairly represented, from the works which have already made their appearance.

It is pretty well known, and therefore needs no special explanation here, that the Fine Art section is very comprehensive in its character, and that every kind of manufacture into which Decorative Art enters, will be received equally with pictures and statuary. Therefore we may expect that a most miscellaneous series of productions will find exhibiting space under the general head of ART-MANUFACTURE: lace and jewellery, bronze-work and damask silks, embroidery and decorated iron-work, stained-glass and goldsmith's work, electro-metallic productions and carved-furniture: in short, this industrial portion of the Fine Art section is a species of safety-valve in the arrangement; for while the varied and opposite objects thus detailed are excluded as manufactures, if up to the mark in the matter of design and artistic quality, they are admissible for their Art-merit.

How far the system of selection by *dilettanti* committees will facilitate the work remains to be seen. A congregation of personages with great names looks ornamental on paper, as adjudicators on the merits and demerits of the objects submitted for the honour of admission; but we think that by this time the manufacturers of Great Britain are quite capable of taking care of their own reputation, and that a little exercise of common sense, and the possession of the requisite technical knowledge on the part of the various officials deputed to superintend the arrangements, would work better and give infinitely more satisfaction.

Nor has the extreme length of time at which objects are required to be sent in prior to the period of the exhibition, which of course grows out of the system of committees of selection, been more satisfactory. Many of the objects require extreme care to preserve them from dust, unskilful handling, and unnecessary exposure, before being finally arranged for exhibition; and manufacturers of such articles naturally complain of the risks of deterioration thus incurred, for which no official responsibility is taken by the Royal Commission. In fact, to treat objects of, say porcelain and woollen manufacture, in a similar manner to pictures, which is the basis of the theory adopted on this occasion, is to commit a grave technical blunder, which official ignorance of the real requirements of the individual cases can alone excuse.

So far we have simply dealt with the prospects of the British portion of the Exhibition. The foreign contributors have scarcely presented any appearance at the date at which we write (the middle of March). The building erected by the French, and the elegant looking courtyard, in front, are at present silent. The new government has issued notices to all concerned to prepare for the Exhibition, and we trust that in due course such a display will be made of French works of Art and objects of manufacture as will give an earnest of reviving industrial life among a people which has passed through the fiery ordeal of the last seven months.

The promises generally from the Continent have been so far stated to be tolerably satisfactory, but our own information leads us to believe that a very large number of the most distinguished producers of objects of Art on the Continent will be rather conspicuous by their absence than otherwise; but we trust that as the work advances a reconsideration of the stated decision will take place, and that a decided effort will be made to secure the co-operation of producers, without whom an international exhibition loses half its significance and utility.

In England little has been done to give direct information respecting the character of the Exhibition. Our own fear is that as the interests of certain localities are alone concerned—or rather appear to be alone concerned—in the leading specialities of the Exhibition, that the interest will also be localised, which will be both a misfortune and loss. Take for instance Birmingham, Sheffield, and Manchester, as having little or no direct interest in the work, beyond the Fine-Art section; it is to be feared that the success of the undertaking will suffer in proportion. We trust not, but certainly little or nothing appears to have been done to remedy such a deficiency as that which it would be mere affectation to overlook; and the time is now becoming very short within which it would be possible to make up for the oversight. The success of the Exhibition as regards its collective character, as a display of international Art and Industry, will doubtless best compensate for all this; and certainly we trust it will be as successful as it ought to be, with the facilities which exist at Kensington.

In conclusion, we may remark that the character of the buildings erected is admirable for simplicity of arrangement and adaptation to use, as regards space and light; but we fear the distance of one section from another, the length of the galleries &c., will be too suggestive of the poet's description of music—

"Linked sweetness, long drawn out,"

and that visitors will find the examination and inspection of the varied objects congregated together a very fatiguing process.

MINOR TOPICS OF THE MONTH.

ILLUSTRATED CATALOGUE OF THE INTERNATIONAL EXHIBITION.—With the May number of the *Art-Journal* will be issued the first part of an ILLUSTRATED CATALOGUE of the leading contents of the Art-industries of the Exhibition, which, on the 1st of May, will be opened at South Kensington: it will be paged separately and be printed on "toned" paper, and be continued monthly to the end of the year 1871. We trust to render this publication not only agreeable, but practically useful. The frequent issue of works of the kind have, there can be no doubt, greatly contributed to the right progress of British Art-manufacture—the suggestive examples having been continually resorted to by the principal manufacturers of the Kingdom. These reports have been almost alone; to produce them demanded large capital, much experience, and indefatigable industry; and in none of the cities of Europe have these been found in combination sufficiently strong to justify any attempt at competition. Consequently, these Illustrated Catalogues have obtained wide circulation on the Continent and in America, as well as in Great Britain. We are justified in the belief that we shall again be the means of extending knowledge by the lessons that Comparison teaches. It cannot be necessary to state that earnest efforts will be exerted to render this Illustrated Report at least as attractive, interesting, and instructive, as those by which it has been preceded.

THE HANGERS AT THE ROYAL ACADEMY EXHIBITION this year will be Messrs. Cope, Redgrave, Ansdell, Sant, and Wells—five instead of three, as heretofore. The change is unquestionably an improvement.

THE ENGRAVINGS OF 'THE SPRING OF LIFE' and 'THE PETS,' in the parts for February and March, are from pictures in the collection of Joseph Harris, Esq., of Derwent Lodge, Cockermouth, and not that of Mr. Cottrill, of Higher Broughton. We regret exceedingly to have made this mistake: it arose out of circumstances, with which it is needless to trouble the reader, that have been more annoying to the editor of the work than to the gentleman who generously lent us the two very charming paintings. Unhappily, the error was not discovered until too late to amend it in either case; and we can now do no more than lament its occurrence, while expressing to Mr. J. Harris our grateful acknowledgments and thanks.

NATIONAL PORTRAIT GALLERY.—At the sale of the pictures belonging to Mr. Robert Nasmyth, of Edinburgh, by Messrs. Christie and Co., at their rooms in King Street, St. James's, Sir. W. Allan's portrait of Sir Walter Scott was purchased by Mr. Scarfe, for the National Portrait Gallery, at the price of 350 guineas. The picture represents Sir Walter in his study at Abbotsford, reading the proclamation of Mary, Queen of Scots, previously to her marriage with Lord Darnley. It is the last portrait for which the great novelist sat, and was engraved by John Burnet.

THE WELLINGTON MONUMENT.—In the House of Lords, on the 10th of March, the Marquis of Lansdowne moved for "the production of all further correspondence, relative to this work, which had passed between Mr. Penrose and Mr. Stevens with any department of her Majesty's Government up to the present time." The motion was carried, and then the Earl of Cadogan stated that after the correspondence had been laid on the table of the house, he

should call attention to the subject. Lord Overstone subsequently remarked, as we saw it reported, that "the history of this transaction was a very curious one, and it was necessary that public attention should be called to it without delay. When the House of Commons voted a sum of money for the erection of a monument to the late Duke of Wellington in St. Paul's Cathedral he formed one of the committee who selected the designs. After that, the Government determined to change the site, and they chose another design. The sum voted had been spent, and all the country had got for its money was the fragment of a monument in St. Paul's Cathedral, and certain other fragments now lying in the artist's studio. He had been informed that the Government had made an effort to enter into an arrangement whereby they would have greater control over the artist than they had at present, so as to be able to give an assurance to the country that the work would be speedily completed. He hoped that would be the case, but he was by no means confident of it." The correspondence, when it is made public, is expected to reveal some curious features respecting the whole transaction.*

THE INSTITUTE OF ARCHITECTS has this year awarded the "Royal Gold Medal" to Mr. James Fergusson; the "Soane Medallion" to Mr. W. Galsworthy Davie, for a design for royal stables, &c.; the "Institute Silver Medal" with five guineas, to Mr. S. Wyborn, for drawings illustrative of St. George's Chapel, Windsor; the "Student's Prize of Books," to Mr. John Sulman, for a design for a drinking-fountain; and an "Institute Silver Medal" to Mr. Alfred Jowers, Associate of the Institute, for an essay on "The Decoration of a Suite of Apartments in a First-class Mansion." In the competition for Royal Stables, the designs of Messrs. A Hill and B. E. Assoc received "honourable mention."

INTERNATIONAL EXHIBITION.—The Committee to whom has been entrusted the selection, &c., of engravings consists of Messrs. J. H. Robinson, R.A.; R. Fisher, and W. Smith, Deputy-chairman of the National Portrait Gallery.

THE ART-UNION OF LONDON will have distributed the prizes before our Journal is issued: the Report describes the results of the year as, on the whole, satisfactory; and it is certain that the progress of the Society has received the marked approval of the subscribers.

DESTRUCTION OF PICTURES BY FIRE.—Holker Hall, near Morecambe Bay, one of the fine mansions of the Duke of Devonshire, has been almost totally consumed by fire—the conflagration destroying numerous valuable portraits, including, as is reported, those of Queen Mary, wife of William III.; Lords Coventry, Lonsdale, and Douglas, Sir John Lowther, Admiral Penn, Lord Russell, and Lady Rachel Russell; the second Duke of Devonshire, by Kneller; Louis XIV., James I., Thomas Hobbes, Charles II., by Riley; Sir P. Lely's Nell Gwynne, James II. By extraordinary exertions the following were happily rescued in time:—Claude's 'Repose in Egypt,' and 'The Temple of the Muses'; Joseph Vernet's 'Storm' and 'Calm'; Cigoli's 'St. Francis'; 'Shipping,' by W. Van de Velde; 'A Venetian Nobleman,' by Tintoretto; and some fine landscapes by Rubens, Hobbema, and Wouwerman.—A later report, to which we cannot now refer, speaks of far heavier losses than those we have indicated.

* Since the above was written the correspondence has made its appearance: the result, according to the *Times*, is "a disclosure which deserves to be called shameful: . . . a scandalous waste of time and money."

MARRIAGE OF THE PRINCESS LOUISE.—It is reported that the Queen has given a commission to Mr. John O'Connor and Mr. E. C. Barnes, to paint a picture of this ceremony. The statement, if true, is singular. We know Mr. Barnes as a pleasing *genre*-painter in the exhibition-rooms of the Society of British Artists; but Mr. O'Connor's name is quite strange to us; unless he is the painter of 'Hungerford Market,' a picture exhibited at the Academy in 1869; and a subject which certainly would not be considered a suitable and commendatory introduction to the illustration of a royal wedding.

SOCIETY FOR THE ENCOURAGEMENT OF THE FINE ARTS.—On the evening of March 2nd, Dr. Hyde Clarke delivered a lecture in the Society's rooms, 9, Conduit Street, on the "Common Elements of Beauty in Race in Georgia, Circassia, the Holy Land, and Britain," wherein the lecturer brought forward a new theory of the principle on which a general standard of beauty in Art has been accepted in classic times and in the modern age.

THE CERAMIC ART-UNION.—This good and very useful Society does not close its "books" until the end of June, when a meeting will be held for the distribution of prizes. It cannot be necessary for us to add that a very charming example of Ceramic Art is issued to each subscriber "at the time of subscribing"—each example having previously received the approval of the Council, all of whom are gentlemen of note and position.

CARVED FRAMES OF FLORENCE.—A visit to the branch establishment of a famous maker of carved frames at Florence has resulted in so much satisfaction, that we strongly recommend it to our readers. In few Art-matters has there been so marked a decadence in later times; the old designers of frames for pictures and mirrors were artists; they studied how best to combine elegance with durability; and many of their productions have descended to us as works to be valued almost at the worth of the paintings they enclose. If we examine any modern collection of pictures, we shall find nearly all the frames have a common type; stucco, *papier maché*, and "composition" give to them a family resemblance that rather deteriorates than embellishes the work of the painter. No doubt the carved frame must be costly; it is solely "hand-work," and must be paid for accordingly. There are few who in England can design and execute such objects at all; and these few produce them at prices that place them beyond the reach of persons not rich. It is a grand boon to supply us with carved, in lieu of composition, frames; the latter easily injured, soon tarnish, and seldom convey an idea of Art. It is, therefore, with much pleasure we note a flourishing revival of the old adaptation of wood-carving to picture-frames at Florence, a revival of so high a nature too, as to reflect honour upon that ancient and noble seat of the Fine Arts. The wood used is the white pine. The specimens we have inspected are remarkably beautiful. They are principally foliage and floral designs, treated with extreme truthfulness to nature, but, at the same time, with masterly freedom. The absence of hackneyed conventionalism in the treatment displayed of acanthus, ivy, or oak, is singularly striking. The designs in fruits and grotesques are equally varied and admirable. These frames are made large enough to enclose a large picture, and sufficiently small to clasp an ordinary *carte-de-visite*. But we must not omit mention of two further good qualities

distinguishing these Florentine importations. The gilding upon their clean wood surface continues fresh and untarnished for an indefinitely long period. The proprietor of the "Florentine Cabinet of Art," 3, Garrick Street, showed us specimens which he informed us had been exposed for years; but which had all the glittering brilliancy of their first day. And yet again, in respect of price, they are not more expensive than the present style of *compo* frame. For grace of design, brilliancy of gilding and cheapness of cost, they are certainly calculated to put aside the "manufactured" productions that seldom or never content the artist, and are too generally blots on the walls they profess to decorate. A visit to the establishment in Garrick Street will confirm the justice of our remarks.

THE VAST AREA OF THE ROYAL ALBERT HALL will be covered with cocoa-nut matting of the finest description. The arena and the amphitheatre are to be covered with this material, dyed crimson, which will add to the effect considerably. The building being in an elliptic form, there was much difficulty in fitting the matting to the different floors. Mr. Treloar has, however, completely and successfully overcome it, by weaving the matting into the form of a simple gusset for the corridors. With regard to the arena and the amphitheatre, the crimson matting has been woven quite in a circle, and this also answers the purpose admirably. It was done in the manner adopted by Mr. Treloar in covering the floor under the dome of St. Paul's Cathedral; *i.e.*, by weaving the matting exactly to fit each step, and curving each piece in the loom instead of weaving it straight.

DRAWINGS AT THE CRYSTAL PALACE.—A series of deeply-interesting water-colour drawings may now be seen, and will no doubt be seen by tens of thousands, at the Crystal Palace, in the room that branches off from the picture-galleries. They are the productions of Mr. Walsh, one of the artists who risked his life often to obtain them, and manifested greater heroism than many a soldier who fought in the ranks on either side during the lamentable and most disastrous war in France. The incidents the artist pictures are chiefly those that occurred within the walls of beleaguered Paris—often comic, sometimes serious, and always presenting subject-matter novel, exciting, and valuable. There is in this collection a singular mixture of the amusing and the pathetic. They illustrate the painful stories that have been told in print, and bring palpably before us the sad scenes, for details of which we have been so long and so much indebted to the newspapers. Mr. Wass, the indefatigable director of the picture-collections, has been fortunate in obtaining such an attraction for the Crystal Palace galleries.

THE LAST PAINTINGS OF THOMAS BOTT, the artist who added renown to the famous works at Worcester, were copies from some of the prints of the Norman conquest by D. Maclise, issued as a series by the Art-Union of London. The vases thus decorated will be seen at the International Exhibition. It is to the credit of Mr. Binns, the director of the works, that he made this selection. Our object is, however, to congratulate the Art-Union that it has thus, almost for the first time, aided the Art-manufacture of the country. We trust a procedure so auspiciously commenced will be continued; and that, hereafter, they will be guided, when selecting subjects for circulation, by the hope that manufacturers will take advantage of their labours to obtain another means of public instruction in Art.

MR. T. O. FARRER, an American artist, who obtained "golden opinions," and something more, during a temporary residence in England, has been greeted by a hearty welcome on returning to his native country with portfolios richly stored with treasures gathered in the green lands, fertile valleys, and clear rivers, of the Old Home. It was not only England he visited; time was spent, and studies were made, in many picturesque cities of the Continent. We are not surprised to learn that this skilful artist finds the Art-lovers of the States able and willing to appreciate his labours. He may take high professional rank anywhere; and, although young, he has already achieved a reputation that cannot fail to place him foremost among the painters of whom America is rightly proud.

"VENETIAN SILVERING."—Some time ago we directed attention to a process by which M. Septimus Furse, of Hanway Street, obtained very brilliant results in silvering various articles of furniture, more especially mirrors and picture-frames. The only question was whether it would "stand," exposed to dust, gas, and London atmosphere; it has stood the test of time. Many of the objects subjected to treatment have been placed in positions for three or four years, in rooms, often crowded, and sometimes at public halls. They have undergone no change whatever. The fact is scarcely to be credited, but is capable of easy proof, not only with regard to objects that are occasionally dusted, but with reference to cornices and other matters out of reach. The consequence is, that Mr. Furse has applied his invention to very many articles; indeed, in almost all the ways in which it can be used with advantage.

FREEMASONS' HALL.—The ceremony of unveiling the Memorial erected in honour of the Building Committee of this new edifice, took place on the 1st of March. It consists of a bust of the chairman, Mr. Wavers, and medallions of the other members of the Committee—Messrs. L. Evans, Grissell, Stebbing, Plucknett, and Hervey: the medallions surround a tablet on which are inscribed an account of the circumstances attending the erection of the building. The whole is the work of Mr. Joseph Durham, A.R.A.; and is executed in white marble. In this work the sculptor has achieved a triumph of no common order: the difficulties seemed insurmountable: the Memorial had to be placed in a narrow corridor off the staircase; a large space had to be divided into three compartments; pilasters of a fixed form had to separate them; while seven portraits (all of living men) had to be arranged in a given order: they were not fanciful portraits, but likenesses of men who are seen frequently at the Hall—being "free and accepted masons" of lofty rank. We can ourselves testify to the accuracy of the medallion resemblances. Each will be recognised at once—a pleasant copy of a distinguished "brother." The sculptor must have been terribly perplexed how and where to arrange his materials: that he has done so with harmony, and not confusion, is perhaps a stronger proof of his ability than even the admirable execution of the work.

MOSAIC.—There is at present exhibited at No. 9, Conduit Street, a large mosaic composition of much beauty, executed by Messrs. Salvati and Co. It is intended as a memorial to Bishop Lucy, who lived in the time of Charles II.; a distinguished scholar, and an ancestor of the Lucys of Hampton Lucy, in the county of Warwick. It is intended to be placed in St. David's Cathedral, a fine old Norman structure, now undergoing restoration by Mr. G.

Gilbert Scott, R.A. The work is large, consisting of a centre and two wings. The subject of the principal picture is the Crucifixion, with complementary figures: one on each side of the cross, and one at the foot. Those on the right and left represent St. John and the Virgin; and that at the foot, Mary Magdalen. The allusion conveyed by the attributes points less immediately to the Passion than to the Atonement and the Heavenly Kingdom. The crown of thorns is removed, and a golden crown substituted. A stream of blood issues from each hand, and falls into a cup: a similar stream flows from the feet into a cup held by the figure at the foot of the cross. The general tone of the work is high, broad, and luminous, worked apparently with a view to a situation in which the light may not be very favourable. Certain of the markings also are very decided; as, for instance, the outline of the figure of the Saviour, which is very firmly drawn in black outline. The centre-piece, more than the wings, has the character of early Art. The background is gold, and all the draperies are white, dispositions well calculated to assist the picture in a low light. The draperies of the side-figures are most elaborate, no difficulty has stood in the way of carrying out the design. The wings contain two figures representing respectively 'Synagoga' and 'Ecclesia,' bearing the vestments and emblems of the Jewish ritual and the Lord's Supper. The female figure representing the Synagogue has a bandage over her eyes, allusive to the non-acceptance of the Saviour. The crown is falling from her head, and the wand symbolising her power is broken, according to the prophecy of Jacob in the 49th chapter of Genesis—"The sceptre shall not depart from Judah, nor a lawgiver from between his feet, until Shiloh come." The other is really a charming figure: she holds the sacramental cup in the left hand, and the cross in the right, and looks, we may say, tidings of great joy. There are other supplementary designs, and the whole is finished with a border of ribbon and emblematical flowers, &c.

A STATUE OF THE SULTAN.—We learn with much surprise that the Sultan has actually given sittings for a statue of himself, to Mr. C. F. Fuller, the accomplished sculptor, now resident at Florence. Hitherto, the Turks have construed literally a command in the Koran equivalent to that which was issued from Mount Sinai—"Thou shalt not make to thyself any graven image, nor the likeness of anything," &c. The innovation will make many of the Sultan's older subjects shudder. It would be difficult to overrate the horror with which such an act would have been received half a century ago; as much so as an attempt to house a herd of swine in Santa Sophia, and would certainly have caused a revolution in Constantinople. The Turks are, however, rapidly approximating to the habits of Christian states, of which this is the latest and the strongest proof.

M. GAMBART has relinquished business as a picture-dealer and print-publisher in favour of his nephew, M. Lefèvre and M. Pilgeram, the latter of whom has been for some years his principal manager. The establishment will, consequently, be carried on in future under the joint names of MM. Pilgeram and Lefèvre, at King Street, St. James's Square. They are gentlemen of much experience, enterprise, and energy. As publishers of prints they are greatly needed in England, for that department of Fine Art is in a sad state of inefficiency with us. We understand they are preparing

several works of high class and of much importance. We cannot take leave of M. Gambart without a word of grateful comment on his long services to artists and Art; he has been a liberal supporter of both, and as a "dealer" is more than popular among the painters of all schools. To him, in a great measure, appertains the merit of introducing into England works by the leading masters of Belgium, of which country he is a native. No doubt he has had a prosperous career, but his transactions have been beneficial to others while profitable to himself.

MR. WEEKES'S statue of Charles II., for Westminster Hall, is completed in the marble, and will shortly be erected. As our readers are familiar with the cast for this figure, by its previous exhibition, we can only notice how admirably the fine qualities of the model are realised in the finished work.

WE are glad to state that Mr. Foley, R.A., has so far approached convalescence as to be able to bear removal to the seaside, where we trust he will speedily regain health and strength.

A BUST OF SIR RODERICK MURCHISON is now in course of execution by Mr. Weekes, R.A., for the Royal Society: for the Jermyn Street Museum the same artist is also commissioned to prepare a similar work.

F. WALKER, A.R.A.—By a sufficiently obvious error—which, however, we hasten to correct—we printed the name of this gentleman, who was elected an associate of the Royal Academy in January, as "F. Watson." Such mistakes do not often occur to us, but in spite of the utmost care they will happen sometimes.

MAPS OF THE NEW FRENCH FRONTIER.—It is stated that maps of the frontier now determined between France and Germany were prepared by the German staff so far back as September last. They have only just made their appearance in London. It is, of course, by the mere addition of a wash of colour that the change in nationality is indicated. The huge fragment added to the Germanic Empire is in the shape of the Hebrew letter Daleth, or a very wide-spread and thick-limbed inverted V, giving a symmetrical line of division between Empire and, *pro tempore*, Republic. To the north-east of this line bristles the long chain of fortresses, lately the pride and guardians of France.

ENAMEL IN ENGLAND.—The want of any school of workmen in enamel in this country is one that is most marked and lamentable. A disproportionately high prize was given, on a recent occasion, by the Society of Arts, for the encouragement of this beautiful art; but the one highly-rewarded specimen has found none to imitate it. It is true that we have abundance of that inferior kind of glazing known as Clerkenwell enamel, which is applied to the decoration of those objects of sham and tawdry jewellery that now fill the windows of a certain class of shops. But for real Art in this permanent and noble style we have to look abroad. The famous enamels of Limoges, which have only been of comparatively late years known in this country, are now imitated in France with a fidelity not unworthy of the old masters. The *cloisonnés* enamels of China and Japan form elegant articles of dress and of ornament, which might be very advantageously imitated by our workmen. Is there no manufacturer who will secure the lead in this favourite branch of industry, by a bold and enlightened application of his capital to its development? He would no doubt reap a rich reward.

REVIEWS.

THE AUTOBIOGRAPHY OF AN OCTOGENARIAN ARCHITECT. By GEORGE LEDWELL TAYLOR. Vol. I. Published by LONGMANS.

THE experiences of a man who has passed considerably more than half a century in the practice of his profession have some title to attention; though it is often undeniable that, in committing them to paper after a long lapse of time, there is a tendency to dwell too much on what in earlier days might be thought of importance, but which now can only be regarded as comparative trifles; and thus the author becomes dry and tedious. Moreover, information that two or three generations since was only in the reach of the few, has, in these days, become open to all; while recent investigations and modern science have done much to change the condition of things and to turn thoughts and ideas into channels of a new character.

The title-page of Mr. Taylor's large quarto volume—a second is in the press, he tells us—indicates, at some length, its contents. The book is “a record of his studies at home and abroad, during sixty-five years, comprising among the subjects the cathedrals of England, France, and Italy, the temples of Rome, Greece, and Sicily, with explanations of their various styles—and plans, from measurement; also incidents of travel, and sketches of other buildings and objects on his route, from notes and measurements during tours through England, France, Italy, Greece, and Sicily, in 1816 to 1819 (principally on foot), with revisits in 1857 to 1868.”

It appears that the author was accustomed to keep a diary of his travels, &c., from an early period, and this it is which forms the staple of his book. Mr. Taylor was very intimate with the late Mr. Cressy, the architect; and the first entry in the diary, dated Tuesday, August 27th, 1816, runs thus:—“Left London by coach for York to meet my friend Cressy, there, and proceed with him to see whatever may be worthy the attention of the architect in that city and its vicinity, and proceed with the same view through Lincolnshire and other counties towards London. Arrived at York on Wednesday evening.” There were two days and a night occupied in a journey which is now only the loss of five or six hours. The difference justifies the remarks in Mr. Taylor's preface—“The difficulties which lay in the way of obtaining that knowledge,” (architecture), “in our time, will strikingly appear: access to all parts of the Continent and England being now easy, through the means of railroads, and the reference to early documents of all kinds being brought within the reach of all.”

From the date of the foregoing entry down to the time of the author's return from his travels in 1819, these extracts are continued. They supply abundant and pleasant evidence of the writer's labours in the study of objects associated with his profession; and his descriptions and observations show much technical knowledge. His object, he says, “has been Architecture, and I shall give the details of my studies of that interesting science during a period of SIXTY-FIVE YEARS.” Notwithstanding much diffuseness, and not a little self-gratulation, the record will prove instructive to the rising members of the profession. The volume is profusely illustrated with fac-similes of Mr. Taylor's sketches made on his travels: these are exceedingly bold in execution, showing more of the artist than of the architect's minute drawing.

THE POTTERY AND PORCELAIN OF DERBYSHIRE. By ALFRED WALLIS and WILLIAM BEMROSE, JUN. Second Edition. Published by BEMROSE & CO.

Our knowledge of the potter's art has of late years become so extensive, that each manufacturer requires a separate monograph. This valuable little manual, which treats of the once celebrated fabric at Derby, is the result of the late Midland Fine Arts and Industrial Exhibition, where so large an assemblage of Derby china was brought together, as to afford the student an unprecedented opportunity of com-

paring the productions of each period, and of determining the relative age of the different marks by pieces of known dates to which they are affixed. From these data the authors show that the earliest mark connected with the elder Duesbury is the well-known anchor conjoined with a capital italic *D*, invariably in gold, adopted by him on his purchase, in 1769, of the Chelsea works, which he carried on continuously with those of Derby, until 1784, when the Chelsea works were totally discontinued. Duesbury used this mark indifferently for both establishments, until, *cir.* 1773, royal patronage was extended to the manufactures, and he then changed his mark and ensigned with a crown the anchor for pieces made and decorated at Chelsea, and the *D* for the productions of the Derby Works. This crowned *D* is the true “Crown Derby,” the earliest distinctive Derby mark authenticated. It is usually painted in blue, more rarely in gold or puce. This mark continued to 1788. In 1776 the elder Duesbury died, and his son and successor subsequently adopted the cross *bâtons* with three dots at the intersections; the jewelled arched crown above, and the letter *D* beneath. It occurs in gold, blue, and puce or lilac. In gold it is rare, the puce appears to be of the earlier date, and bears an unmistakable Chelsea character, the paste of the finest quality, the decorations delicate and elegant. On Derby pieces from 1774—85 may be recognised the paintings of the ubiquitous Billingsley, who wandered from Derby to Pinxton, Bristol, Worcester, Nantgarrow and Coalport. His skill in flower-painting was unequalled. At the Derby Exhibition was shown his “prentice plate,” on which was represented a wreath of roses in every form, painted with the delicacy and softness alone could give, and which he effected by the process called “washing out.” A uniform shade of colour was laid upon the leaf or flower, and the lighter shades produced by washing or wiping out with a colourless brush. The flowers of Billingsley, wherever painted, may be recognised by this mode of manipulation. At a later period, the Derby mark was executed in vermilion, and so continued under the third Duesbury, and his successor, Michael Kean, who married Duesbury's widow. In 1809, the works were bought by Mr. Bloor, to whose period belongs the “Japan” style of decoration used especially for tea and dinner services, gorgeous in red, blue, and gold. The vermilion mark was less carefully finished, the bows of the crown no longer jewelled, the cross-sticks of greater length. From 1825—30, Bloor used his own name and “Derby,” surmounted by a crown; but afterwards to secure a uniform trade-mark he adopted the “thumb-printing.” Instead of being painted with a brush, the impression was taken off upon the thumb from a copper-plate charged with vermilion, and thence affixed to the paste. The work concludes with a notice of the principal artists of Derby, including the modellers who gave to the biscuit figures their unrivalled reputation for beauty and delicacy. But we must refer the collector to the book itself for further interesting details relative to the manufacture.

THE CHRISTIAN'S ARMOURY. By CAROLINE R. DEANE. Published by BERRIDGE & CO.

This is a very beautiful volume, a charming example of chromo-lithography, bound with much elegance, admirably printed, and forming altogether a most attractive gift-book for any season.

The accomplished lady who has produced it is both author and artist; the sacred theme is treated in several short poems, good as compositions, and manifesting true Christian piety. The manner is indicated by the subject; the “whole armour” of the Christian, as the apostle explains it, is considered as a whole, and in detail,—the shield of faith, the sword of the spirit, the helmet of salvation, and the several other arms of the hero who fights the good Fight of Faith. The poems may be read with pleasure and with profit. It is to the book as a work of Art, however, that we mainly direct the attention of our readers. Without borrowing more than an idea from the old illumina-

tors, the lady has followed their guidance in the arrangement of her pages: each contains a miniature picture, highly wrought, while the verses are surrounded by emblematic flowers; thus, the explanation is given of one of them:—

“Righteousness; the name, the passion-flower (*passiflora*), is derived from a fancy likeness of the different parts of the flower and plant to the instruments of the Saviour's sufferings. This flower has, therefore, been chosen as a suitable emblem of the righteousness imputed to us through the sufferings of the Redeemer.”

The miniature pictures our Lord bearing the cross onward to Calvary.

Besides the prints which show the Christian's armoury there are others that illustrate “The Watcher,” “Truth,” “Faith,” “Prayer”—themes that have been a thousand times represented in sacred Art, but are always capable of novel treatment; which touch the heart and impress upon the mind the holy truths of the Gospel.

Mrs. Deane has thus laboured with a twofold object; she has worked as a teacher and also as a preacher, impressive with the pen and with the pencil, giving force to thought and substance to faith.

She has produced a very beautiful, and, at the same time, a very instructive, book, for which she will receive the thanks of all who may be so fortunate as to obtain it.

VERE FOSTER'S DRAWING-BOOK. Published by MARCUS WARD & CO.

This singularly comprehensive work is now completed. Its issue in numbers has been very successful, yet not more than it deserved. Each part was attainable for threepence, yet it contains eight pages of model drawings, some simple, some elaborate; and all sources of profitable instruction to the student, whether he is barely commencing to “learn” Art, or has made much progress towards its attainment. The volume, as now completed, of course begins with the beginning; the “pothooks and hangers” of the artist, straight and curved lines; proceeding through leaves, trees, cottages, mountains, rivers, boats, animals, birds, to the human figure in all its “branches;” ending with an illustrated treatise on practical geometry.

It would be difficult to overrate the value of this work; a work that is not to be estimated by its cost: one is great, the other very small. Any learner may find in it a huge volume of thought; his studies, rightly directed by a competent practical teacher, who will teach him nothing by which he can be led astray, or that he will have to unlearn when he consults the great Book of Nature.

The pages are of tinted paper, and, generally, spaces are left beside the prints, on which the copies may be made; or blank leaves are given for the purpose. In fact, the parts cost very little more than would so many pages of plain drawing-paper.

THE SACRISTY. A Quarterly Review of Ecclesiastical Art. No. I. Published by J. HODGES.

Notwithstanding the numerous existing publications which—for the most part, indirectly rather than directly—include Ecclesiastical Art in their respective programmes, it is assumed that there is still room for a work which shall take the subject under its special wing; and we are not disposed to question the propriety of the assumption. This is the mission of “The Sacristy,” the first number of which appears with several appropriate papers that form pleasant and instructive reading. Such are those on “The Completion of St. Paul's;” “Christian Symbolical Zoology;” “The Mosaics at Ravenna;” “Colour for Decoration;” “Some Thoughts on Modern Parish Churches,” replete with excellent suggestions; “Art Metal-Work;” “Liturgical Dances;” “The Ancient Colony and Church of Greenland,” &c. The various subjects are discussed in a liberal spirit—that is, without any very manifest leaning to any one of the parties into which our Church is divided.

THE ART-JOURNAL.



LONDON: MAY 1, 1871.

THE MERCHANTS OF THE MIDDLE AGES.

BY THE REV. E. L. CUTTS, B.A.

PART IV.



IT is difficult at first to believe it possible that the internal trade of mediæval England was carried on chiefly at great annual fairs for the wholesale business, at weekly markets for the chief towns, and by means of itinerant traders, of whom the modern pedlar is the degenerate representative, for the length and breadth of the country. In order to understand the possibility, we must recall to our minds how

small comparatively was the population of the country. It was about two millions at the Norman conquest, it had hardly increased to four millions by the end of the fifteenth century, it was only five millions in the time of William III. Nearly every one of our towns and villages then existed, but the London and Bristol and Norwich and York of the fourteenth century, though they were relatively important places in the nation, were not one-tenth of the size of the towns into which they have grown; Manchester and Leeds and Liverpool, and a score of other towns, existed then, but they were mere villages; and the country population was thinly scattered over a half-reclaimed, unenclosed pastoral country.

To begin with the fairs. The king exercised the sole power of granting the right to hold a fair. It was sought by corporations, monasteries, and manorial lords, in order that they might profit, first by the letting of ground to the traders who came to dispose of their wares, next by the tolls which were levied on allmerchandise brought for sale and on the sales themselves; and then indirectly by the convenience of getting a near market for the produce the neighbourhood had to sell, and for the goods it desired to buy.

The annexed woodcut (No. 1) from the MS. Add. 24,189, represents passengers paying toll on landing at a foreign port, and perhaps belongs in strictness to an earlier part of our subject. The reader will notice the picturesque custom-house officers, the landing-places, and the indications of town architecture. The next illustration (No. 2) from painted glass at Tournay (from La Croix and Seré's "Moyen Age et la Renaissance") shows a group of people crossing the bridge into a town, and the collector levying the toll. The oxen and pigs, the country-wife on horseback, with a lamb laid over the front of her saddle, represent the country-people and their farm-produce;

the pack-horse and mule on the left, with their flat-capped attendant, are an interesting illustration of the itinerant trader bringing in his goods; the toll-collector seems to be, from his dress and bearing, a rather dignified official, and the countryman recognises it by touching his hat to him. The river and its wharves, and the boats moored alongside, and the indication of the town-gates and houses, make up a very interesting sketch of mediæval life.

There were certain great fairs to which traders resorted from all parts of the country; the great fair at Nijni Novgorod, and in a lesser degree the fair of Leipsic, remain to help us to realise such gatherings as Bartholomew Fair used to be. Even now the great horse-fair at Horncastle, and the stock-fair at Barnet, may help us to understand how it answered the purpose of buyers and sellers to meet annually at one general rendezvous. The gathering, into one centre, of the whole stock on sale, and the whole

demand for it, was not only in other ways a convenience to buyers and sellers, but especially it regulated the general prices current of all vendibles, and checked the capricious variations which a fluctuating local supply and demand would have created in the then condition of the country and of commerce. The king sometimes, by capricious exercises of his authority in the subject of fairs, seriously interfered with the interests of those who frequented them, e.g., by granting license to hold a new fair which interfered with one already established; by licensing a temporary fair, and forbidding trade to be carried on elsewhere during its continuance. Thus in 1245 A.D. Henry II. proclaimed a fair at Westminster to be held for fifteen days, and required all the London traders to shut up their shops and bring their goods to the fair. It happened that the season was wet: few consequently came to the fair, and the traders' goods were injured by the rain which pene-

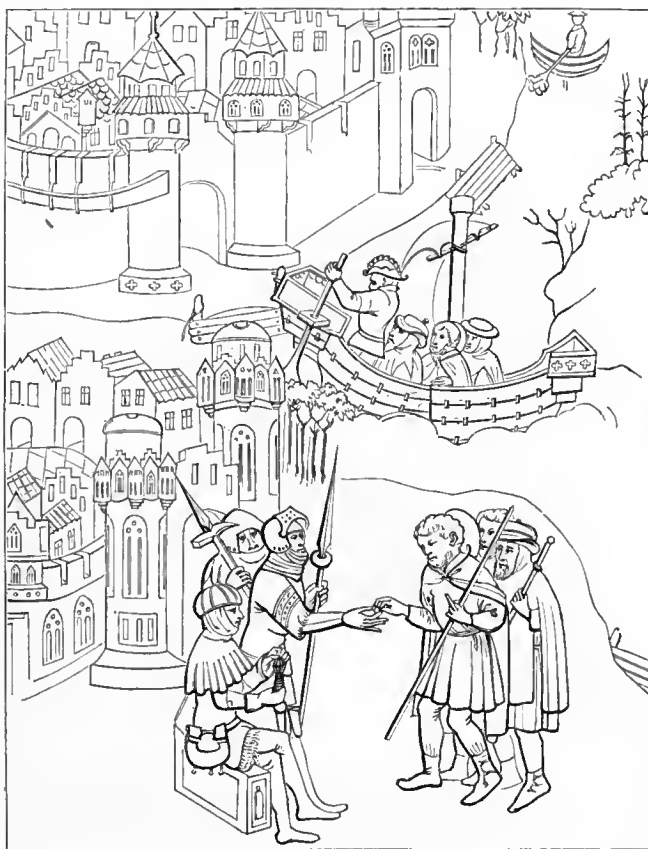

NO. 1. PASSENGERS PAYING TOLL.

trated into their temporary tents and stalls. He repeated the attempt to benefit Westminster four years afterwards, with a similar result. Of course when great crowds were gathered together for days in succession, and money was circulating abundantly, there would be others who would seek a profitable market besides the great dealers in woofels and foreign produce. The sellers of ribbands and cakes would be there, purveyors of food and drink for the hungry and thirsty multitude, caterers for the amusement of the people, minstrels and jugglers, exhibitors of morality-plays and morrice-dancers, and still less reputable people. And so besides the men who came for serious business there would be a mob of pleasure-seekers also. The crowd of people of all ranks and classes from every part of the country, with the consequent variety of costume in material, fashion, and colour—the knight's helm and coat of mail, or em-

broidered *jupon* and plumed bonnet, the lady's furred gown and jewels, the merchant's sober suit of cloth, the minstrel's gay costume and the jester's motley, the monk's robe and cowl, and the peasant's smock-frock, continually in motion up and down the streets of the temporary canvas-town, the music of the minstrels, the cries of the traders, the loud talk and laughter of the crowd—must have made up a picturesque scene, full of animation.

When the real business of the country had found other channels, the fairs still continued—and in many places still continue—as mere "pleasure-fairs;" still the temporary stalls lining the streets, and the drinking-booths and shows preserve something of the old usages and outward aspect, though, it must be confessed, they are dreary, desolate relics, of what the mediæval fairs used to be. The fair was usually proclaimed by sound of trumpet, before which ceremony

it was unlawful to begin traffic, or after the conclusion of the legal term for which the fair was granted. A court of *pie-poudre* held its sittings for the cognizance of offences committed in the fair. Many of our readers will remember the spirited description of such a fair in Sir Walter Scott's novel of "The Betrothed."

In the great towns were shops in which retail trade was daily carried on, but under very different conditions from those of modern times. The various trades seem to have been congregated together, and the trading parts of the town were more concentrated than is now the case; in both respects resembling the bazaars of Eastern towns. Thus in London the tradesmen had shops in the Cheap, which resembled sheds, and many of them were simply stalls; but they did not limit themselves to their dealings there, they travelled about the country also. The mercers dealt in toys, drugs, spices, and small wares generally; their stocks being of the same miscellaneous description as that of a village-shop of the present day. The station of the mercers of London was between Bow Church and Friday Street, and here round the old Cross of Cheap they sold their goods at little standings or stalls, surrounded by those belonging to other trades. The trade of the modern grocer was preceded by that of the pepperer, which was often in the hands of Lombards and Italians, who dealt also in drugs and spices. The drapers were originally manufacturers of cloth; to drape meaning to make cloth. The trade of the fishmonger was divided into two branches, one of which dealt exclusively in dried fish, then a very common article of food. The goldsmiths had their shops in the street of Cheap, but fraudulent traders of their craft, and not members of their guild, set up shops in obscure lanes, where they sold goods of inferior metal. A list of the various trades and handicrafts will afford a general idea of the trade of the town. Before the 50th of Edward III. (1376 A.D.) the "mysteries" or trades of London, who elected the Common Council of the city, were thirty-two in number, but they were increased by an ordinance of that year to forty-eight, which were as follows:—grocers, masons, ironmongers, mercers, brewers, leather-dressers, drapers, fletchers, armourers, fishmongers, bakers, butchers, goldsmiths, skinners, cutlers, vintners, girdlers, spurriers, tailors, stainers, plumbers, saddlers, cloth-measurers, wax-chandlers, webbers, haberdashers, barbers, tapestry-weavers, braziers, painters, leather-sellers, salters, tanners, joiners, cappers, pouch-makers, pewterers, chandlers, hatters, woodmongers, fullers, smiths, pinner, curriers, horners.

As a specimen of a provincial town we may take Colchester. A detailed description of this town in the reign of Edward III., shows that it contained only 359 houses, some built of mud, others of timber; none of the houses had any but latticed windows; the town-hall was of stone with handsome Norman doorway. It had also a royal castle, three or more religious houses—one a great and wealthy abbey—several churches, and was surrounded by the old Roman wall. The number of inhabitants was about 3,000. Yet Colchester was the capital of a large district of country, and there were only about nine towns in England of greater importance. In the year 1301 all the moveable property of the town, including the furniture and clothing of the inhabitants, was estimated, for the purpose of a taxation, to be worth £518, and the details give us a curious picture of the times. The tools of

a carpenter consisted of a broad axe value 5*d.*, another 3*d.*, an adze 2*d.*, a square 1*d.*, a *novelyn* (probably spokeshave) 1*d.*, making the total value of his tools 1*s.* The tools and stock of a blacksmith were valued at only a few shillings, the highest being 12*s.* The stock in trade and household goods of a tanner were estimated at £9. 17*s.* 10*d.* A mercer's stock was valued at £3, his

household property at £2. 9*s.* The trades carried on there were the twenty-nine following; baker, barber, blacksmith, bowyer, brewer, butcher, carpenter, carter, cobbler, cook, dyer, fisherman, fuller, furrier, girdler, glass-seller, glover, linen-draper, mercer and spice-seller, miller, mustard and vinegar seller, old clothes-seller, tailor, tanner, tiler, weaver, wood-cutter, and wool-comber. Our

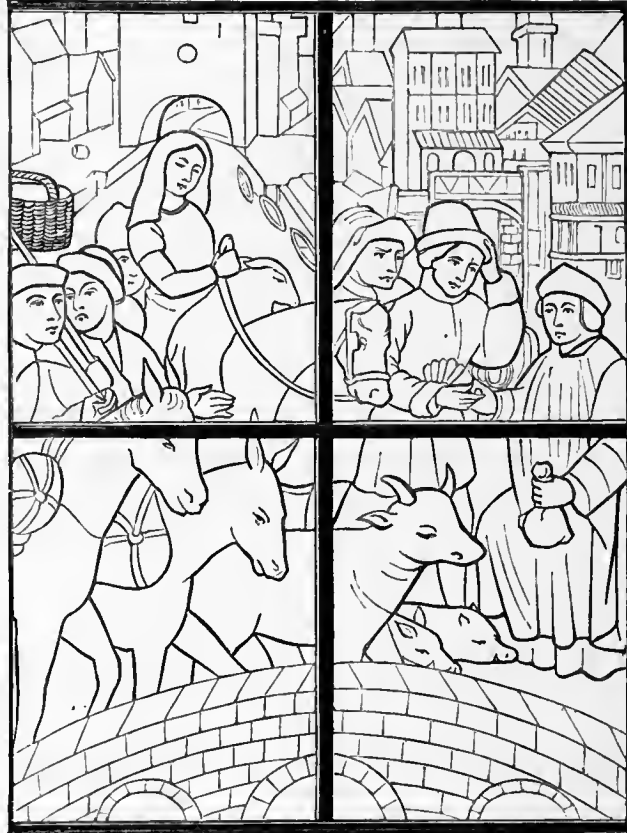

No. 2. TRADERS ENTERING A TOWN.

wood-cut (No. 3), from the MS. Add. 27,695, which has already supplied us with several valuable illustrations, represents a mediæval shop of a high class, probably a goldsmith's. The shopkeeper eagerly bargaining with his customer is easily recognised, the shopkeeper's clerk is making an entry of the transaction, and the customer's servant

stands behind him holding some of his purchases; flagons and cups and dishes seem to be the principal wares, heaps of money lie on the table, which is covered with a handsome tablecloth, and in the background are hung for sale girdles, a hand mirror, a cup, a purse, and sword.

In some provincial towns, as Nottingham,



No. 3. A GOLDSMITH'S SHOP.

the names of several of the streets bear witness to an aggregation of traders of the same calling. Bridlesmith Gate was clearly the street in which the knights and yeomen of the shire resorted for their horse-furniture and trappings, and in the open stalls of Fletcher Gate, sheaves of arrows were hung up for sale to the green-coated foresters of neighbouring Sherwood. The only trace of

the custom we have left is in the butcheries and shambles which exist in many of our towns, where the butchers' stalls are still gathered together in one street or building.

But the greater part of the trade of the towns was transacted on market-days. Then the whole neighbourhood flocked in, the farmers to sell their farm-produce, their wives and daughters with their poultry and

butter and eggs for the week's consumption of the citizens, and to carry back with them their town-purchases. In every market-town there was usually a wide open space—the market-place—for the accommodation of this weekly traffic; in the principal towns were several market-places appropriated to different kinds of produce; e.g., at Nottingham, besides the principal market-place—a vast open space in the middle of the town, surrounded by overhanging houses supported on pillars, making open colonnades like those of an Italian town—there was a “poultry” adjoining the great market, and a “butter-cross” in the middle of a small square, in which it is assumed the women displayed their butter. In an old-fashioned provincial market-town, the market-day is still the one day in the week on which the streets are full of bustle, and the shops of business; while on the other days of the week the town stagnates. It must have been still more the case in the old times of which we write. In some instances there seems reason to think a weekly market was held in places which had hardly any claim to be called towns—mere villages, on whose green the neighbourhood assembled for the weekly market; round the green perhaps a few stalls and booths were erected for the day; pedlars probably supplied the shop-element; and artificers from neighbouring towns came in for the day, as in some of our villages now the saddler and the shoemaker and the watchmaker attend once a week to do the makings and mendings which are required. There are still to be seen in a few old-fashioned towns and remote country-places, market-crosses in the market-places or on the village-green. They usually consist of a tall cross of stone, round the lower part of whose shaft a penthouse of stone or wood has been erected to shelter the market-folks from rain and sun. There is such a cross at Salisbury; a good example of a village market-cross at Castle Camp, in Gloucestershire, one of wood at Shelford, in Cambridgeshire, and many others up and down the country, well worthy of being collected and illustrated by the antiquary before they are swept away. Our illustration (No. 4), from the painted glass at Tournay, represents a Market-Scene; the women sitting on their low stools with their baskets of goods displayed on the ground before them; the female on the left seems to be filling up her time by knitting; the woman on the right is paying her market-dues to the collector, who is habited as an ecclesiastical officer. The background appears to represent a warehouse where transactions of a larger kind are going on.

But the inhabitants of rural districts were not altogether dependent on a visit to the nearest market for their purchases. The pursuit of gain enlisted the services of numerous itinerant traders, who traversed the land in all directions, calling at castle and manor house, monastery, grange, and cottage, and by the tempting display of pretty objects, and the handy supply of little wants, brought into healthy circulation many a silver penny which would otherwise have jingled longer in the owner's *gypaire*, or rested in the hoard in the homely stocking-foot. An entry in that mine of curious information, the York Fabric Rolls, reveals an incident in the pedlars' mode of dealing. It is a presentation, that is, a complaint made to the Archbishop, by the Churchwardens of the Parish of Ricale, in Yorkshire, under the date 1519 A.D. They represent, in the dog-Latin of the time: “*Item, quod Calatharii (Anglice Pedlars), veniunt diebus festis in porticum ecclesie et ibidem vendunt mercimonium suum.*”

That *Calatharii*—that is to say, Pedlars—come into the church-porch on feast-days, and there sell their merchandise. From another entry in the same records it seems that sometimes the chapmen congregated in such numbers that the gathering assumed the proportions of an irregular weekly market. Thus among the presentations in 1416, is one from St. Michael de Berefredo, St. Michael-le-Belfry, in the city of York, which states, “The parishioners say that a common market of vendibles is held in the churchyard on Sundays and holidays, and divers things and goods and rushes are exposed there for sale.” The complaint is as early as the fourth century; for we find St. Basil mentioning as one abuse of the great church-festivals, that men kept markets at these times and places under colour of making better provision for the feasts which were kept thereat.

The presentation from Ricale carries us back into the old times, and enables us

to realise a picturesque and curious incident in their primitive mode of life. A little consideration will enable us to see how such a practice arose, and how it could be tolerated by people who had at least so much respect for religion as to come to church on Sundays and holidays. When we call to mind the state of the country districts, half reclaimed, half covered with forest and marsh and common, traversed chiefly by footpaths and bridle-roads, we shall understand how isolated a life was led by the inhabitants of the country villages and hamlets, and farmhouses and out-lying cottages. It was only on Sundays and holidays that neighbours met together. On those days the goodman mounted one of his farm-horses, put his dame behind him on a pillion, and jogged through deep and miry ways to church, while the younger and poorer came sauntering along the footpaths. One may now stand in country churchyards on a Sunday afternoon, and watch the people



NO. 4. A MARKET-SCENE.

coming in all directions, across the fields, under copse, and over common, climbing the rustic stiles, crossing the rude bridge formed by a tree-trunk thrown over the sparkling trout-stream, till all the lines converge at the church porch. And one has felt that those paths—many of them ploughed up every year and made every year afresh by the feet of the wayfarer—are among the most venerable relics of ancient times. And here among the ancient laws of Wales is one which assures us that our conjecture is true: “Every habitation,” it says, “ought to have two good paths (convenient right of road), one to its church, and one to its watering-place.” Very pleasant in summer these church-paths to the young folks who saunter along them in couples or in groups, but very disagreeable in wet wintry weather, and difficult at all times to the old and infirm. Another presentation out of the York Fabric Rolls, gives us a

contemporary picture of these church-paths, seen under a gloomy aspect: In A.D. 1472, the people of Haxley complain to the Archdeacon that they “inhabit so unreasonable fer from ther parish cherche that the substance (majority) of the said inhabitants for impotensaye and feblenes, farrenes (farness = distance) of the way, and also for grete abundance of waters and perlose passages at small brigges for people in age and unweldyc, between them and ther next parische cherche, they may not come with ese or in seasonable tyme at ther saide parische cherche as Cristen people should, and as they wold,” and so they pray for leave and help for a chaplain of their own.

We must remember too, that our ante-Reformation forefathers did not hold modern doctrines concerning the proper mode of observing Sundays and holydays. They observed them more in the way which

makes us still call a day of leisure and recreation a "holiday;" they observed them all in much the same spirit as we still observe some of them, such as Christmas-day and Whitsuntide. When they had duly served God at *matins* and mass, they thought it no sin to spend the rest of the day in lawful occupations, and rather laudable than otherwise to spend it in innocent recreations. The Ricale presentation gives us a picture which, no doubt, might have been seen in many another country-place,

on a Sunday or saint-day. The pedlar lays down his pack in the church-porch—and we will charitably suppose assists at the service—and then after service he is ready to spread out his wares on the bench of the porch before the eyes of the assembled villagers and make his traffickings, ecclesiastical canons to the contrary notwithstanding, and so save himself many a weary journey along the devious ways by which his customers have to return in the evening to their scattered homes. The complaint

of the churchwardens does not seem to be directed against the traffic so much as against its being conducted in the consecrated precincts. Let the pedlar transfer his wares to the steps of the village-cross, and probably no one would have complained; but then, though those who wanted anything might have sought him there, he would have lost the chance of catching the eye of those who did not want anything, and tempting them to want and buy—a course for which we must not blame our pedlar too



NO. 5. ITINERANT TRAVELLERS.

much, since we are told it is the essence of commerce, on a large as on a small scale, to create artificial wants and supply them.

A former illustration has shown us a pack-horse and mule, the means by which those itinerant traders chiefly carried their merchandise over the country. But some kinds of goods would not bear packing into ordinary bundles of the kind there shown; for such goods, boxes or trunks, slung on each side of a pack-saddle, were used. We are able to give an illustration of them (No. 5) from

an ancient tapestry figured in the fine work on "Anciennes Tapisseries" by Achille Jubinal. It is only a minor incident in the background of the picture, but is represented with sufficient clearness. Another mode of carrying personal baggage is represented in the fifteenth cent. MS. Royal, 15 Ed. V., where a gentleman travelling on horseback is followed by two servants, each with a large roll of baggage strapped to the croupe of his saddle. The use of pack-horses has not even yet (or had not a few

years ago) utterly died out of England. The writer saw a string of them in the Peak of Derbyshire, employed in carrying ore from the mines. The occasional occurrence of the pack-horse as the sign of a roadside inn, also helps to keep alive the remembrance of this primitive form of "luggage-train." Many of our readers may have travelled with a valise at their saddle-bow and a cloak strapped to the croupe; the fashion, even now, is not quite out of date.

THE ARTISTS IN FLORENCE.

HERE, as elsewhere, the war has had an adverse influence on the Fine Arts. Italy may be said to have benefited in a material point of view by the temporary shutting of the great shop, Paris; many small sorts of industry have received a stimulus, and money has in various ways flowed into Florence; yet little of it has been expended on Fine Art purchases, and the absorbing pressure of the tragedy which has been going on so near has had a deadening effect on all works of the imagination. Now that people can breathe again, something better may be expected. Two years ago we gave a notice of some of the studios here, and especially of the cluster of them placed just beyond the Porto Romano. Since then the noble drive from the Porto Romano to the Porto S. Niccolo has been completed. It would be difficult to imagine any thing more beautiful than the views it commands, as it gently winds up the hill in easy curves, along-side the straight old cypress and ilex avenue of the Poggio Imperiale. Now the eye rests on olive-gardens, and *podere* carpeted with red and purple anemones; then a turn of the road, and Giotto's Campanile, and Brunelleschi's Duomo lie below, and Florence with its many towers and names so suggestive of Art and ancient story. Leaving the Poggio Imperiale the road follows the sweep of the hill, and passes under Galileo's tower, and close by the Church of S. Miniato, where the coachman pauses of his own accord, that we may enjoy a view, with the glories of which no one can be satiated. From this point the descent to the somewhat ugly suburb at Porto S. Niccolo is almost rural, and the road passes near a conspicuous building, "Villa Trollope," a name nearly as much associated with Florence as that of Browning.

To return to the Porto Romano where the studios stand: Powers's, which we mentioned as being in progress, is now completed, and the garden luxuriant with foliage. The 'Indian Woman flying before the Approach of Civilisation' is under one of the sheds, imprisoned in a block of marble, and hardly yet rough-hewn. Powers himself seems well and hearty, with his grand head and inspired-looking eyes; he has just finished a bust of General Sheridan, and his portrait-gallery of American celebrities increases, and will be very valuable to his countrymen a generation hence. The Americans are lavish, if not very discriminating, patrons of Art. They are justly proud of Powers; and at Rome, too (Gibson being departed), an American stands at the head of the profession.* Powers's 'Eve' we consider his masterpiece, and as far excelling his well-known 'Greek Slave'; but we confess a longing for something else than modern Greek Art; these constant repetitions of the antique, these innumerable figures who seem to have just put off their garments, are a weariness to the spirit, and never for a moment cheat one into the feeling with which we regard the frank and pure simplicity of the Greek nude.

Just above his father's villa young Mr. Powers has a photographic studio, which is at present enriched by a collection of the most artistic landscape photographs it has ever been our good fortune to see, taken in the Holy Land, and in Greece, by Baron des Granges:—the Mosque of Omar, the tomb of Absalom, the Place of Weeping, the Mount of Olives, and all the sacred spots round about Jerusalem; the Plain of Troy,—where,

"From the strand of Dardan, where they fought,
To Simois' reedy banks the red blood ran,"—

and other classic ground in Asia Minor; also in Greece, not only the well-known gate of Lions at Mycenæ, and other Cyclopean remains, and all that is best near Athens, where the artist lived, but scenes in the wilds of Arcadia and by the shores of the far-famed Styx. Mr. Ball, an American sculptor, has his studio near; and immediately opposite Powers's stands Mr. Ful-

* In Rome, we understand, Mr. Story is at present occupied with a statue of 'Jerusalem.'

ler's studio, which we formerly described. The 'Peri,' which enchanted us in clay, is now in marble, and has been sent to the Royal Academy. It is the property of Lord Dudley. Mr. Fuller has just returned from Constantinople, where he has been making a portrait of the Sultan. It is not fair to comment on a work which is only in progress of being modelled in clay; but whatever may be thought of the Sultan, a middle-aged, self-indulged looking man, whose face, but for its sensual expression, might be handsome, we predict that the Arab steed will satisfy the most critical. To evade the scruples of the religious party in Turkey, and the command against graven images, the equestrian statue is to be made under the size of life. We refrain from saying more about this studio, both because we described it at some length before, and because our readers by a visit to the Royal Academy may satisfy themselves if we have said too much about the 'Peri,'—an engraving of which, from an excellent drawing by Trica, will at no distant period adorn this work.

Mr. Conolly, in the Via Nazionale, has been very busy since we mentioned him last; he has shown his talent for catching the likeness and character of the face in numerous busts, and has completed a large sitting-figure of the Duchess of Northumberland, and is about to commence another large statue-portrait, of an American lady. He has also made an ideal figure of 'Desdemona,' exceedingly lovely; he has seized the moment when the first thought of guilt is suggested to her, which her innocent mind cannot understand. Nothing can be more sweet and pure than the whole composition, or more dramatic; the action of the hand and the expression of the face are admirable; but while we admire so freely, we must ask why did not Mr. Conolly use a model? the lower part of the figure is far too meagre in its proportions to be true to nature. Mr. Conolly is young, and the fear with him, is not having too little, but possibly too much, talent and facility.

Among the Italian studios we find little originality; though there seems a constant demand for monumental groups and statues. We were at Duprè's studio to-day. Every one who has visited the Pitti knows his 'Abel,' of exquisite proportions, about which so much has been said. Nor is it easy to forget his 'Cain,' a work as striking and as unhealthy as a sensational novel. Since then he has produced nothing with any individual stamp, but has been busy with *bas-reliefs* for the front of Santa Croce, and monuments of all sorts. One in honour of Cavour, and destined for Turin, is strangely inappropriate to that shrewd and practical statesman; though he does seem amused at the allegorical lady in scant Greek drapery kneeling at his feet, whom we suppose is intended to represent Italy. What pleased us most in the place was a very simple figure of a little boy tracing on the ground with a bit of charcoal, called 'Giotto,' and said to be the work of the sculptor's daughter.

The grave has closed upon Bastianini, and his wonderful talent. The sad story of his forgeries, as celebrated in Art as the Ireland forgeries were in literature, has been too recently discussed to be repeated here; yet it is still doubtful how far he intentionally deceived, or allowed others to deceive for him; one thing alone is certain, his great ability: his bust in *terra-cotta* of Savonarola in St. Mark's, would itself be enough to prove him a man of genius.

Fedi's group of Pyrrhus and Polyxæna has long found its place in the Loggia de Lanzi, near John of Bologna and Benvenuto Cellini, and within a stone's cast of Michael Angelo; it is worthy of the noble company; but we protest again against modern Greek, and till painting and sculpture are brought to express the real feeling of the age they must be somewhat "furniture" and not Art. It seems as impossible now to produce an Antinous or an Apollo Belvedere, as it would be to write Homer. One foreign studio has been nearly closed, which we cannot wholly pass; no works, by Felicie de Fauveau, remain in it for us to criticise, but she herself in her honoured old age lingers in Florence, a relic of former times, and of a former school of thought, with the odour of chivalry about her grey hair.

A good deal has been done lately in the way of arranging the Art-treasures of Florence. Statues by Donatello, John of Bologna, Verrocchio, and others, have been removed from the crowded corridor of the Uffizi to the Bargello, where they may now be seen, along with some splendid examples by Luca della Robbia and other Tuscans. In 1865, at the time of the Dante fêtes, the Bargello, which had been used as a prison, was appropriated for the reception of everything which could in any way illustrate the life and times of the poet. The result was a most splendid loan collection, embracing both the intellectual and domestic life of the period; harmonising well with Giotto's fresco of Dante on the walls. This interesting collection was soon dispersed, and has been replaced by a mediæval museum, containing splendid specimens of majolica, bronzes, ancient armour, and such like, to which loan contributions are added, on the same principle as in our South Kensington Museum.

Some years ago, there was a small collection of water-colour copies by Mr. Wheelwright, exhibited in Burlington Street. They were mostly from old Tuscan masters, and showed with what perfection the soul and spirit of the ancient masters may be given in a translation from *tempera* or oil to water-colour; such copies as these are rare treasures. Mr. Wheelwright no longer has a studio in Florence, but he may be seen sometimes in the Uffizi busy at a Botticelli. Marionecchi has a most attractive studio of water-colour copies, with many of which we are familiar through the Arundel Society, and Rocchi's imitations of Fra Angelico are worth a visit. In all large towns there will always be a certain number of tolerable portrait-painters. Gordigiani has made a beautiful likeness of the Princess Margaret, and has all the royal family with more or less success upon the walls of his studio. There is a whole family of Markos here, who have been esteemed good landscape-painters; the father, who is dead, really was a distinguished artist. Cumbo Borgia's landscapes are known in London, every year one or two of his faithful studies from nature are to be found in our Academy; their sober tone, and the total absence of clap-trap or struggle for effect, may make them unobserved at first, but the more they are seen the more they will win upon the taste. Some encouragement for the future may be drawn from looking over the prize pictures of the Art-scholars, which are kept in an upper room in the Belle Arti, in the Via Ricasoli, where we may see how short a time it is since the baneful influence of David reigned paramount. In the collection of modern pictures, belonging to the government, in this same building, we can note that that school has at length vanished. If there is little that can be said artistically favourable, yet the evident attempt to express the national life is interesting in its way. There are battle-pieces of all sorts; incidents of the middle ages, and still more modern Italian victories; and there are large commemorative posthumous portraits of Silvio Pellico, Guisti, and other patriots who hardly need have been condemned to such a martyrdom. One little picture pleased us very much, a group of Italian Bersagliere conducting in triumph one or two Austrian prisoners; well painted and very naïve and spirited. It is somewhat significant that the best bit of painting in the room, as far as mechanism goes, is the yellow satin dress of a *demi-monde* beauty.

The studios in the Via delle Belle Donne, where Holman Hunt painted a few years ago, are always occupied. At present a sort of private exhibition is going on of some water-colour drawings by an English artist, a Mr. Bradley. In another room, Professor Schmidt exhibits his enormous picture of 'The Temptation of Our Lord.' The frame of mind in which people find it possible to attempt such subjects is a mystery to us, and reminds one of the criticism of Dr. Johnson, who, when he was assured that a long piece of music to which he had been compelled to listen, was "very admirable, very beautiful, very difficult," replied: "Sir, I would it were impossible."

Florence.

G. F.

THE STATELY HOMES OF ENGLAND.
(OCCASIONALLY OPEN TO THE PEOPLE.)

"The stately homes of England,
How beautiful they stand!
Amidst their tall ancestral trees,
O'er all the pleasant land."
MRS. HEMANS.

By S. C. HALL, F.S.A.
THE ANTIQUARIAN NOTES AND DETAILS
By LLEWELLYN JEWITT, F.S.A.

HADDON HALL.

THE several engravings that appear on these pages—the concluding pages of our history of picturesque and venerable Haddon—have been described in preceding chapters: it was difficult to introduce them in their "proper places:" the reader will not however, we trust, miss the requisite references to the text. Our plan has been to illustrate the fine old structure fully; first, because it is foremost among the many interesting mansions of the Kingdom—very little changed externally, and not much internally, from what it was nearly three centuries back; but chiefly because there is no glory of the olden time in England to which so many make pilgrimage, tempted not only by the grand Baronial Hall, but by the sublime and beautiful scenery—of hill and river, mountain and valley, wood and mead—by which it is environed, and by the historic memorials that abound in its vicinity, of the times when Briton, Roman, Saxon, Dane, and Norman, held alternate sway over the fair and fertile Shire. Derbyshire



"DOROTHY VERNON'S PORRIDGE POT."

is to-day, as it was twelve hundred years ago, the most seductive of all the counties of England; and it is no wonder that its varied and manifold charms have induced visits of tourists from all parts of the world.

But it is not now, as it was in the days even of our fathers, a district difficult to reach and costly to examine; within four hours of London, and not two hours distant from the busiest marts of the kingdom—Manchester, Liverpool, Leeds, Birmingham, Macclesfield, and a score of other places largely populated, especially by hives of busy workers—it supplies abundant sources of health and enjoyment; while the most popular of our "Wells," Buxton and Matlock, are almost "within a stone's-throw," and from either of them Haddon may be reached at the cost only of a few shillings by railway, and a pleasant stroll from either of the Stations.

But it is not Haddon alone that can be thus so easily visited; the whole neighbourhood is one rich mine of beauty in which all may revel, and from which none can depart without conveying with them pleasant memories and fresh-awakened interest. In one day both Haddon and Chatsworth, with Bakewell and the glorious scenery that intervenes, may, by those who are "tied to time," be seen and examined, and thoroughly enjoyed, from either Matlock or Buxton; or if one day be devoted to each, then many lovely spots in their neighbourhood may be seen, and the toil made lighter.

At the close of our last chapter we left the tourist at Bakewell, but we did not quite dismiss him, for we had not space at our command to point out some of the curious epitaphs that may be found in the church and churchyard. One or two of these he will, no doubt, wish to copy, for their quaintness; so, to save him trouble, we here transcribe them.

One of these, to the memory of a former parish clerk and leader of the choir, reads as follows:—

"ERECTED TO THE MEMORY OF PHILIP ROE, WHO DIED 12TH SEPTEMBER, 1815, AGED 52 YEARS.
"The vocal Powers, here let us mark,
Of PHILIP, our late Parish Clerk
In church, none ever heard a Layman
With a clearer Voice say Amen!
Oh! now with Hallelujah's Sound,
Like Him can make the Roofs resound.
The Choir lament his Choral Tones,
The Town—so soon here lie his Bones.
Sleep undisturbed, within thy peaceful shrine,
Till angels wake thee with such tones as thine."

Another long inscription to the memory of John Dale, barber-surgeon, of Bakewell, and his two wives Elizabeth Foljambe and Sarah Bloodworth, 1737, thus curiously ends:—

"Know, posterity, that on the 8th of April, in

the year of grace, 1757, the rambling remains of the above said John Dale were, in the 86th year of his pilgrimage, laid upon his two wives.

"This thing in life might raise some jealousy,
Here all three lie together lovingly,
But from embraces here no pleasure flows,
Alike are here all human joys and woes;
Here Sarah's chiding John no longer hears,
And old John's rambling Sarah no more fears;
A period's come to all their toilsome lives,
The good man's quiet; still are both his wives."

Another reads as follows:—

"These lines, I with watery eye,
For my dear friend indite,
Who for his worth, none such on earth,
Heaven crown him with true light.
"A lawyer just, a steward most just,
As ever sate in court,
Who lived beloved, with tears interred,
This is his true report."



RING FOUND AT HADDON HALL.

Another, locally said to have been written by Charles Wesley, brother to the founder of Methodism, reads as follows:—

"Beneath, a sleeping infant lies,
To earth whose body lent,
More glorious shall hereafter rise,
Though not more innocent;
When the Archangel's trump shall blow,
And souls to bodies join,
Thousands shall wish their lives below
Had been as short as thine."

It may be as well to note that the principal inn at Bakewell is the Rutland Arms: it is

a family hotel, but there are other comfortable inns in the place. Opposite the Rutland Arms are the baths and bath-gardens: the baths, which were known to the Romans, have the reputation of being efficacious in rheumatism.

Having in our first chapter very briefly alluded to the routes by which Haddon Hall may be visited both from Buxton on the one hand, and from Derby on the other, and having then spoken of some of the attractions of Buxton, it may be well now to say a few words regarding Matlock Bath, through which the

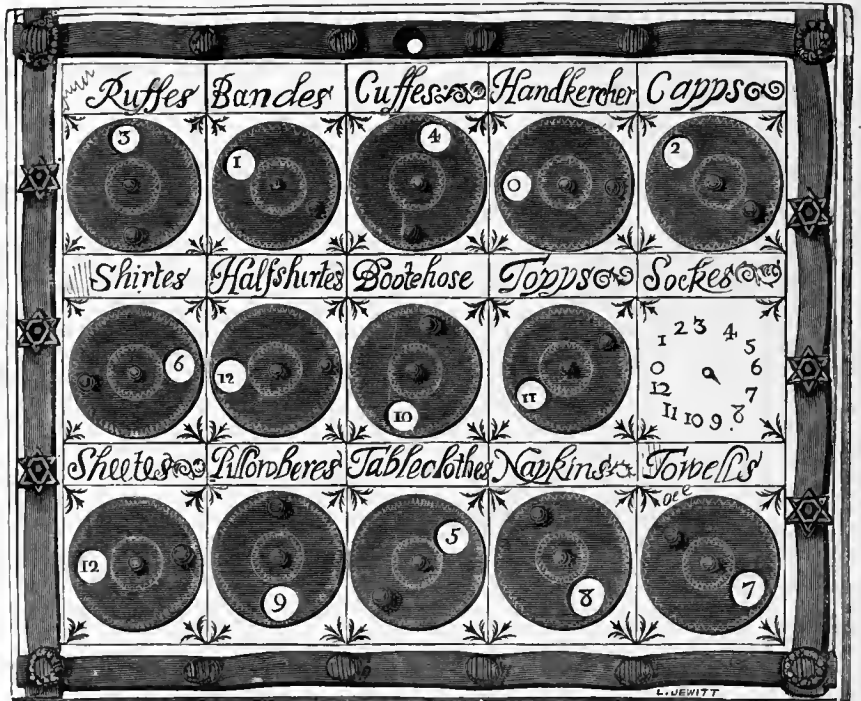

WASHING-TALLY FOUND AT HADDON HALL.

visitor will pass by rail on his journey from London, from Derby, or from the North.

Matlock Bath is about seven miles from Haddon Hall; and, exclusive of its baths, which are as famous as those of Buxton, and for the benefit of which the invalid may pass the season pleasantly and profitably, it has attractions of scenery which no other inland watering-place can boast. Its "High Tor" rising almost perpendicularly to a height of about 400 feet above the river Derwent, which flows at its base; its "Lovers' Walks," winding along by the side of the river, and zig-zagging up the mountain side; its "Heights of Abraham" and "Masson" towering over the valley; its

"romantic rocks," and its many caverns; its petrifying wells, its "grottoes," and its other attractions, render Matlock Bath a place of delight to the tourist; while the surrounding district, rich in minerals, in ferns, and in other botanical specimens, and full of gorgeous scenery, is "passing beautiful," and will amply repay the pleasant labour of exploring.

At Matlock Bath the principal hotels are the "New Bath," "Walker's Terrace Hotel," "The Temple," and "Hodgkinson's," and the place swarms with lodging-houses and all things to attract and to keep the tourist. From Matlock, delightful day-trips may be made to Haddon Hall, to Hardwick Hall, to Chatsworth, the

“Palace of the Peak”—the princely seat of the Duke of Devonshire; to Dovedale, with its glorious scenery, and its pleasant associations with old Isaac Walton and Charles Cotton; to the Via Gellia and its surroundings; to Lea Hurst, the early home of Florence Nightingale; and to numberless other places of interest—all easily attainable by railroad or carriage.

And now, may not a visit to this grand old Hall be productive of thought? First, let us give thanks to the noble owner—the Duke of Rutland—that he freely opens its gate to all comers, keeps it in a state of neatness and order, and takes special care that Time shall make no farther inroads on the mansion of his ancestors, preserving it for the enjoyment of all who seek instruction and pleasure there; permitting them, indeed, to make of one of its rooms a dinner-room for the day; rendering it, in fact, the common property of the public, and by his occasional presence ascertaining that all is done that can be done for their happiness while in its gardens or within its walls; thus practically commenting on the exhortation and protest of the Poet-laureate—

“Why don't those aced sirs
Throw up their parks some dozen times a year,
And let the people breathe?”

In the series—“Stately Homes of England,” published in the *Art-Journal*, we have shown



ANCIENT CROSS, BAKEWELL CHURCHYARD.

not that Haddon is the exception, but that a very large majority of the “parks” in England, Scotland, and Wales are freely opened—not a dozen times a year, but every day of every year; and that, usually once a week, the state rooms are also “shown” to all applicants—often when the family is “at home.”

It is thus of ALTON-TOWERS, ALNWICK CASTLE, CASTLE HOWARD, COBHAM HALL, KNOLE HOUSE, MOUNT EDGCUMBE, ARUNDEL CASTLE, HARDWICK HALL, WARWICK CASTLE, PENSHURST, and WILTON HOUSE, illustrated and described in that series, and of KNEBORTH, HATFIELD, CASSIOBJURY, and SUMMER-LEIGHTON, which hereafter it will be our pleasant task to describe and illustrate, as well as princely CHATSWORTH. It is thus indeed of a hundred other places we could name in every shire of the kingdom.

It is difficult to overrate the value of this “license.” Not only are the people thus “let breathe”—it removes the barriers that separate the rich from the poor, the peer from the peasant, the magnate from the labourer, and contributes largely to propagate and confirm the true patriotism that arises from holy love of country. Generosity, like mercy, is twice blessed:

“it blesseth him that gives and him that takes,” and the surest way to be happy is to make others happy. All honour to the “aced sirs,” who seek to share with “the many” the boons that Providence has given them. Let us then seat ourselves—anywhere—and

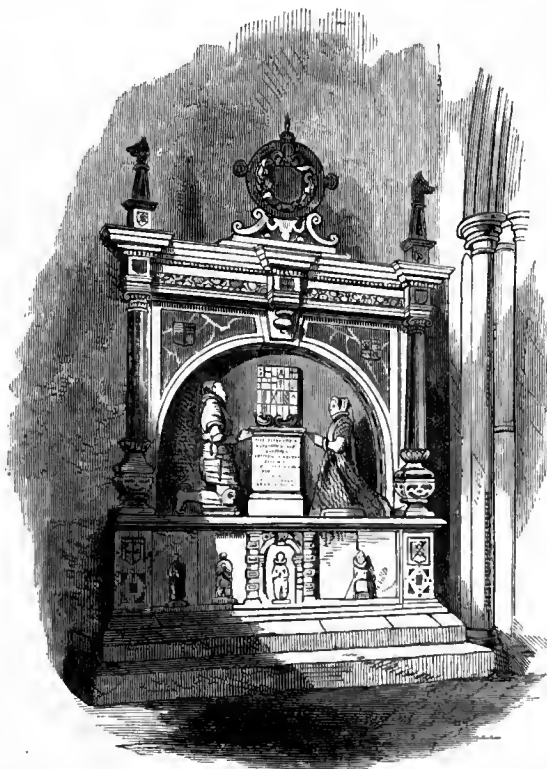

MONUMENT OF SIR JOHN MANNERS AND HIS WIFE, DOROTHY VERNON.

think, before we leave glorious old Haddon; it may be on one of the green slopes of the hill—side, underneath one of the fine groups of trees that look from the valley up to the mansion, or



BAKEWELL CHURCH.

down upon it from some adjacent steep; or on the bank of the gracefully winding Wye; or, better still, from a nook of the far-famed “Terrace;” or, alone in one of the many chambers, hung with tapestry, musing at an oriel window, and gazing over the bountiful river, recalling the

knights and dames of heroic ages long gone by, but who have left their impress for all time.

They must have shrivelled imaginations, and contracted minds, who can visit the noble hall of Haddon without obtaining a Memory that will last for a life.

SELECTED PICTURES.

FROM THE PICTURE IN THE COLLECTION
OF R. P. HARDING, ESQ., WOOD HALL,
EAST DULWICH.

LE MALADE IMAGINAIRE.

A. Solomon, Painter. H. Bourne, Engraver.

THE late Abraham Solomon, who died in 1862, painted many pictures which rendered his works very popular with those who look for striking incident and individual character. His Art was certainly not refined as a rule, but it told a story effectively, and this will always invite attention. Witness his 'Drowned! Drowned!' engraved in our Journal shortly before the painter's death, a picture which, for the narrative it illustrates, attracted marked notice when it appeared in the Academy, and subsequently found more than one imitator.

'Le Malade Imaginaire' is almost the last work he produced; and is unquestionably the most humorous, as it is also one, in every respect, the most clever in delineation of character; for there is point in every figure. The subject is borrowed from Molière's comedy bearing the same title, and the scene lies in the bed-chamber of the hypochondriac, M. Argan, who is visited by his physician, Diafoirus, and the son of the latter, who is training for the profession: the following dialogue takes place:—

Argan. Voilà une femme qui m'aime. . . Cela n'est pas croyable.

Diafoirus. Nous allons, monsieur, prendre congé de vous.

Argan. Je vous prie, monsieur, de me dire un peu comment je suis.

Diafoirus. (tâtant le pouls d'Argan). Allons, Thomas, prenez l'autre bras de monsieur, pour voir si vous saurez porter un bon jugement de son pouls. Quid dicit?

Th. Diafoirus. Dico que le pouls de monsieur est le pouls d'un homme qui ne se porte pas bien.

Diafoirus. Bon!

Propped up and pillowed in his easy chair, no wonder the invalid looks up aghast when the young oracle has spoken such ominous words, and he finds them confirmed by the elder man of physic, who, watch in hand, times the beating of the patient's pulse as his jewelled fingers press lightly on Argan's wrist. There is something irresistibly droll in the trio; in the pompous attitude and whole bearing of the physician, who is evidently not inclined to thwart the fancy of his patient, though we can detect a degree of humour in his countenance. And then the dismayed expression of Argan's face, as if he were already doomed to death; while young Diafoirus delivers the sentence with an emphatic upraising of the hand to enforce it: his father, no doubt, had given him suitable instructions what to say.

Toinette, the "*femme qui m'aime*," makes no secret of the opinion she entertains regarding the sick man's state of health: she is busy mixing a compound of some kind or other for the invalid, who is always requiring a stimulant "to keep up the tabernacle," as we once heard an old Scotch physician remark to one under his care; but the dialogue of the two doctors amuses her much, and she looks towards Diafoirus as perfectly comprehending its raillery, and also as quite ready to carry on the delusion after he and his son have taken leave.

Every part of this most humorous picture is painted with scrupulous care and attention to details: the costumes of the figures are rich in colour, and the arrangement of light and shade is very effective.

This painter was much accustomed to rely on gorgeous draperies and splendid accessories of every kind to give value to his compositions.

A GENUINE ARTISTIC RACE.

PART III.

THE immediate effect of cheap books in Europe has been to deprive Art of its intellectual supremacy by giving the mental lead to the reasoning faculties. Ungracious as is this temporary suppression of the æsthetic disposition, it is an actual step forward in national progress. At first, as with children, the imagination takes precedence in the civilising process, giving rise to distinctive religious and artistic phases, which, however, owing to their æsthetic temperaments, become liable to constant fluctuations and premature decay. The world has yet to demonstrate if the scientific and æsthetic faculties can be so harmoniously balanced in a people as to become the foundation of a perfect civilisation. It suffices for our purpose just now to get a vivid view of what must have been a universal passion for Ornamental Art during the Middle Ages, by looking at Japan, where feudalism is still dominant, and the general constitution of society in its division into castes, guilds, and ranks, with their average instruction, is in principle much like that which existed in Europe previous to the Reformation. Japan has cheap books, but no system of common education, tending to the development of the logical powers and spread of useful knowledge. On the contrary, there are distinct alphabets, or modes of writing, regulated by the social condition or the sex of the learner. Women and the inferior orders are taught only the Hirakana alphabet, which is the vulgar one, and used only for ordinary purposes. A man of quality, knowing this, can read his wife's or daughter's letters, but they cannot decipher his, or the books he buys, if the Katakana alphabet, which is restricted to the higher classes of his sex and to superior scholarship, be employed.

But the most current literature, intelligible to every one, vastly diffused, and forming the real mental diet of the multitude, is a system of pictorial books, the most artistic series of which is by a school of associated artists, with Hofksai for their chief. These are printed in colours or plain, at a single impression, on one side of a light tinted paper, which doubles to form a leaf, and very often divides the print, cutting in halves the figures, to which accident the artists are indifferent. The exquisite delicacy of touch of these impressions, partly due to the softness of the material, seems like the handiwork of nature itself in a tender poetical mood. Europeans have no process by which the vital qualities of things can be given with equal facility, precision of design, and thoroughness of spirit. These sketch-books and coloured albums embody the history, poetry, legends, mythology, myths, arts, trades, customs, jugglery, magic, science, and natural history, in fine, the whole life of the people in a cheap form, and keep alive their artistic sensitiveness. They are taught by the pictorial representations or images of things rather than by literary descriptions. Hence to them the style of the design has the same relative importance that the style of writing has with us. All that is best and worst in their taste, true and false in their lives, is garnered into these picture-books, which ardently evoke the sympathies of a highly-impressible race, passionately fond of nature. Although there are marked differences of style in them, betraying the distance between a pupil's and a master's hand, yet there is a similarity of spirit and execution in all, indicative of a common fountain-head of national skill and feeling.

As the motives of the figure-Art already examined appertain chiefly to their religious ideas, our enjoyment of it cannot be so hearty and complete as of that based on the social life, natural history, and the landscape of Japan. There are fewer drawbacks from imperfect comprehension or lack of sympathy with the theme. Indeed, we are let into an artistic paradise of an original character, which Europe cannot rival. This is specially true of their strictly Decorative Art. No other race understands so well the vital exigencies of ornamentation, or is equally skilful in manual practice. Here the Japanese have obtained as decisive a mastery as the Greeks in treating the human form. Outside of plastic

Art, in their own limits, the Japanese even succeed in this. There are two principal schools of the figure: that of Kiōto, the spiritual capital of the Mikados, being the oldest. It is imbued, as was the early Italian, with Byzantine feeling, with the Chinese love of repose and richness of decoration, tending to laborious minute conventionalism more than to strictly artistic invention. Nevertheless, it displays superlative delicacy and brilliancy of illumination, pictorial skill in composition, and a felicitous balancing and tempering of masses of colour and gold. It devotes itself chiefly to sacred and historical topics and those favoured by the aristocratic susceptibilities of the imperial family. Like the Art of the miniaturists of mediæval Europe, with which it was contemporary in origin, it forms a religious school partial to gold backgrounds and magnificence of decoration, under the direction of Bouddhist monks. These had acquired the art of clouding the page on which they wrote with gold powder and leaf of varied tints and brilliancy, intermixing figures and text with golden masses and suggestions of forms, so as to illumine the page and give the effect of dissolving views, not unlike the softened splendour of the sun's rays in the landscape as they pass through mists. Their quiet, though somewhat monotonous, refinement of design, and their harmonious elegance of colouring, without obscuring the story, seduce the senses into a languid forgetfulness of it, as the ear often drinks in the music of an opera while the eye is unmindful of the stage-scenery. This fascination belongs to the best Decorative Art of the Orient everywhere. But the Japanese miniatures are wanting in the intense realistic characterisation and vivid action which constitute the prominent traits of the more decidedly indigenous school as represented by the pencil of Hofksai.

The antithesis of Grecian design is the rule of Japanese. Mobility and flexibility of body and features; moments of liveliest action and surprise, real, homely, often exaggerated, but as the Greeks intensify repose; and, above all, absolute distinct individualism in every figure, each one a *character*, as we say: these are emphatic points. There is no *nirvana* in the true Japanese school. Although Bouddhism has converted the nation, its indigenous traits and ideas remodel the imported rites to suit themselves. Hence it is that the mobile restlessness of its Art overcomes the contemplative tendency of its popular faith. Besides, there is diffused throughout it a latent objective humour or nice irony, which, without caricaturing, emphasises the motive, and gives it a pungent flavour, like wit to conversation. Sometimes the joke is broad, but invariably comical. Hofksai's drawings are diversified, original, and spontaneous; seemingly blossoming in his brain as shrubs flower, although actually the results of detective analysis and consummate study. A limited Art in the cosmopolitan sense it is, but in its own national compass as wide and deep as the entire circle of Japanese civilisation, while surpassed by none in truthful expression. Even if it is careless of much that the æsthetic science of Europe exacts in colour, modelling, and anatomical detail, in other ways it displays profoundness of execution, guided by quite as subtle principles, or rather instincts. Neither the divine idea of the human body as conceived by the Greeks, nor the spiritual idea of the Italian mediævalists, is recognised by it. But in compensation, we are secured from the conventional figures of the pretty and inane types which abound in modern European Art. In their place we have a sturdy versatile realism of common and aristocratic life, bestowing a definite form and character in unity on each individual, appropriate to his social position, and spiced with the prevalent humour.

Somewhat of the Japanese facility of pencil is undoubtedly caught in its elementary phase in learning to write the two alphabets most in vogue. A delicate brush and dexterous handling are needed to make their bold incisive strokes, which are just such as come most aptly into their system of drawing. Indeed, the *Katakana*, or aristocratic letters, are combined into the guise of a learned doctor, with a perfect rendering of his dignified pose and scholastic costume, while the plebeian *Hirakana* is alle-

gorised into a beggar, equally graphically done. Learning to write becomes in Japan the first step in learning to draw, for it gives the same flexibility of stroke to the fingers that fingering the piano does to the musician's touch. A glance at any one of Hofksai's albums shows the analogy between Japanese writing and drawing at once.

The arbitrary signs of the alphabets can readily be expanded into vigorous suggestions of human forms and drapery, and as facily decomposed into their abstract elements again. But the informing spirit which gives such intense life to their personages can be got only by a most sedulous observation of nature objectively and introspectively. A Japanese draughtsman is not less successful in delineating natural than in constructing unnatural forms. None are more happy in hitting the exact limit in the ridiculous where the action stops short of the inane caricature, so common in Europe. He makes the position droll because of its adroit combination of probabilities, rather than possibilities, under conditions which he himself creates. We are all familiar with French plates of the effects of a high wind on pedestrians of both sexes who make a prurient display of limbs and personal encounters, forming a picture nasty alike to eye and fancy. Hofksai takes a similar event—sends drapery wildly flying, entangling arms and legs, blinding eyes, and getting its owners into a funny turmoil without indecency of drawing, or exciting other emotion than honest laughter.

What a nice sense of humour, too, there is in his plate of a tired porter asleep on the ground with his brawny legs across one another, only to see himself in his dreams working harder than ever. Where do we find his superior in depicting gymnasts, fencers, wrestlers, and scenes that call for the utmost muscular exertion and dexterity? He is as felicitous in limning steady industry of all sorts—perpetrating on occasion the inevitable joke—each person doing his heartiest, and making the spectator *feel* that he is, without the consciousness of self-exhibition and of the impotent model, which so obtrude on the sight in European Art nowadays. If it be a woman scrubbing herself or resisting urchin in a tub of water, a fine lady at her toilette, a family quarrel, pleasure party, a physician examining the tongue of a patient half-choked in forcing it out of his mouth, a musical critic tortured by an unwelcome serenade, blind men leading one another astray in crossing a river; in fine, whatever the topic, and however complicated the scrape, it is executed with a realistic swing of pencil and *naïveté* of expression that commends it to the sight as actual life itself. So simply too, with so few strokes and touches, so much reserved power and so little artifice, is the occult mechanism of humanity revealed to us, that we seem to have a clairvoyant insight into the consciousness of the actors. This inner being of the object shown constitutes its chiefest identity. It is evoked by such slight technical means that at first we overlook its wonderful æsthetic simplicity in admiration of the spirit of the composition in the whole.

The skilful manner, hiding, if I may so term it, the manual means with which Japanese artists bring vividly in view the animating idea of their works, is also wonderful. It may be done by a few lines, dots, blotches of light, shade, or colour; always simply and sparsely; with no unnecessary labour, and certain to stop at the precise point the idea is reached, without elaborating any detail not absolutely required to complete the unity and emphasise the meaning of the composition; doing too little rather than too much technically; concentrating the attention on the artistic aim; with slight perceptible effort hinting a whole biography of an individual, or the complete habits and instincts of an animal, the nature of a plant, and the sentiment of a season; explicit force of design for the eye and unlimited suggestion for the mind; economy of labour, luxury of idea, æsthetic seriousness, solidarity, conciseness, and drollery, devoid of Gallic levity, license, and littleness of purpose: such are some of the elements I recognise in this unique school, rendering it an example to those academies which do so much and express so little; and, immersed in the

sensualisms and superficialities of their systems, lose sight of the real intent and substance of Art. Although the predilection for action is most conspicuous, the Japanese understand full well how to render contemplative repose, as in the figures of gentlemen on their balconies overlooking a wide landscape in passive enjoyment of moonlight, or rapt in thought. These are simply perfect in pose and feeling. So also, poets meditating by the sea; harsh-featured men on the brink of precipices, so absorbed in gloomy reverie as to seem to form a part of the wild, speechless world around them, their passion-lit faces indicative of inward storm; a momentary lull in a stormy life to gather fresh momentum of action. Opposed in sentiment and attitude, with relaxed tension of limb and nerveless looks, are the numerous Boudhist images of ecstatic saints and holy men enjoying incipient beatitude.

The artistic sway over animal and vegetable life is as thorough as over the human. Indeed there seems frequently to be a more poetical choice and treatment in these motives than the others. Japanese of all classes are trained from infancy to familiar relations with nature. It is a national custom during spring-time to make family excursions into the distant country in order to enjoy the sakura or mountain cherry-trees when the wild blossoms are fullest and colour the deepest. One of their old poets thus alludes to them:—

"The dark-massed shadows flecked,
By the mountain-cherry's bloom."

Again,

"Should the mountain-cherry cease
In the spring-time of the year,
With its mass of new-horn bloom,
Mortal men to cheer; alas
Would the heart of spring be gone,
And its brightness fade away."

This habit engenders a passionate fondness for outdoor existence, and a hearty appreciation of whatever is beautiful in landscape. Their houses are constructed to admit ample views of the country, while, as compared with European homes, there is much less to attach life very fixedly to their interiors. They are singularly bare of furniture and household utensils, because their requirements for housekeeping are few and of the simplest sort. Instead of framed landscapes hung on their walls the *daimios* make their apartments scrupulously clean, airy, and spacious, with movable mats or screens to divide them, which can be arranged so as to leave open, as if enclosed in a frame, vistas of fine scenery. In this matter the people manifest an æsthetic conscience. Believing in nature as a means of pure enjoyment, they study to secure her best. It is this wholesome habit of mind which has prevented them from stagnating like the Chinese, despite kindred faiths and equally changeless codes and customs. Their love of nature is at the bottom of their love of Art. The two are so mingled as to save them from the gross materialism of their neighbours, and to preserve in them a perpetual juvenescence of feeling, elasticity of temperament, quickness of intellect, almost Arcadian simplicity of life, and general goodness of disposition. Sites for tea-houses, inns, temples, and shrines, are chosen in reference to the prospect. As regards fine architecture, Japan is peculiarly barren. The charm of its towns chiefly lies in their beautiful positions, lovely gardens, stately groves, and rural interminglings. Picturesque solitudes abound in the centres of the densest populations. These waifs of far-off wildernesses are devoted to offices of religion and rustic pleasures, which have much in common. They further serve as bountiful reservoirs of health, distributing to each city threshold the pure air of the dearly beloved country. This appreciation of nature extends to all her gifts. A European can hardly take in the passionate joy of a Yedoite in his darling Fousi-yama, the "peerless" mountain, whose volcanic cone, clothed in eternal snow, lifting itself high into the intensely blue azure of his native skies, in magnificent silence, is his climax of sublimity in the material world, a symbol of imperishable patriotism, and a celestial paradise. Neither can he share his knowledge of the animal world and its varied instincts. The wondrous ethereality of the atmosphere, defining

distant places as sharply as the lines of an engraving, and revealing their secrets, gives an additional charm to the landscape. When weird in aspect, his fancy peoples it with spirits thin as air, strange in form and hue, wishing him weal or woe according to their disposition. With a more materialistic sense he delights in his wild camelias in full blossom, fifty feet tall; the songless birds of bright plumage that add to the deep hush of the forests; and favourite picnic grounds, with their running waters and enamel of wild flowers. These are some of the scenes that keep him in a more cheerful mood and his æsthetic perceptions keener than those of most other civilised peoples.

Unlike Greek poetry, that of Japan is full of descriptions of the landscape. The popular feeling finds vent almost as much in song as in painting and design. In general it is plaintive, and sung to the accompaniment of a *sammishen*, a sort of banjo or guitar: or a *koto*, a kind of clavecin, and any other wind-instrument. Some of the impromptu stanzas of their poets, expressive of their intense sympathy with nature, are very sweet and touching, while their similes are as beautiful as true. I extract examples from the collection of ancient and modern poems, known as the *Kokinshin*, first quoted by the Portuguese Père Rodriguez, A.D. 1604, in his treatise on the Japanese language, and cited in the *Westminster Review* for Oct., 1870.

"Icy flakes are falling fast
Thro' the chilly air, and now
Yonder trees with snow-bloom laden,
Do assume the wild plum's guise,
With their mass of snowy flowers,
Gladd'ning winter's dreary time."

"Darkening the wintry air,
Clouds are gathering in the sky,
Rain-drops sparsely patter down,
And the frozen tears melting
Drop from yonder willow tree,
Through the chilly vapours seen,
Sadly bending o'er the stream."

"There the dizzy water-fall,
Flashes mid the hill-side bowers,
Never shall the sacred child,
Weary of the pleasing murmur."

"Nor of gentler beaming moon
Hail the shadow-fringing shimmer."
"Vaguely erring smoke."

"Bright i'th' sun gleams Suka's peak,
Cloud-veiled Sudska's summit bleak,
Tseuchi's top between doth lie,
Rain-dimmed, hid from traveller's eye."

There is no false sickly sentiment in these effusions, but the same sincerity of feeling, delicacy of touch, and truth of observation that are to be observed in the sister-Arts. As a specimen of kindred metrical realism of a corresponding vigour, the following stanza, from a dramatic romance, is noteworthy. It represents a girl hastening to meet her lover by water—

"Ha! Atsuta's shrine desery yonder; yes—
Full seven leagues across the bay.
Haul tant the sail, bend, mother, to th' oar,
With measured stroke—away, away—
Haste, mother, haste, far yet the farther shore—
O mother, every nerve be strained."

"How fierce the hail drives through the windy air,
We cover from the storm our heads;
Now side by side our barges thro' the waters tear—
Now me the laggard other leads."

Notwithstanding his fine sentiment, both religious and naturalistic, the Japanese artist jokes on natural history as he jokes with his gods and rulers; not, however, very often, as his taste is too honest to tolerate the horticultural outrages which the Chinese, French, and Dutch are prone to commit in their systems of trying to help nature to adorn herself. More circumspect in dealing with her, he confines his ingenuity to dwarfing trees and rearing mammoth flowers. These traits in all their variety of individual characterisation are to be found in their picture-books.*

J. JACKSON JARVES.

Florence.

[We are compelled to break off rather abruptly here, in the division of this series of interesting papers: the demand on our ordinary space caused by the introduction of the Illustrated Catalogue of the International Exhibition must be our apology.—ED. A.-J.]

* To be continued.

THE ROYAL ALBERT HALL.

THE newspapers have been so full of descriptions of this marvellous structure, and of details concerning the ceremony of its inauguration by her Most Gracious Majesty the Queen, on Wednesday, March 29th, that we may assume every reader of the *Art-Journal* to be sufficiently acquainted with them. Our duty is, therefore, limited to a record of the auspicious event; yet when the building is entirely finished, we may be called upon to subject it to criticism.

Although "music" seems its first and principal object, Art is by no means to be omitted from its programme of the future; indeed, both the address of the Prince of Wales and the reply of her Majesty are conclusive on that head. The prince said:—

"Your Majesty's Commissioners for the Exhibition of 1851, in further prosecution of my father's design for the encouragement of the Arts and Sciences, an object which he always had warmly at heart, are about to commence a series of annual international exhibitions, to the success of which this Hall will greatly contribute, by the facilities which it will afford for the display of objects and for the meeting of bodies interested in the industries which will form the subjects of successive exhibitions."

And the Queen in answer thus spoke:—

"I cordially concur in the hope you have expressed, that this Hall, forming as it does part of a plan in which I must ever take a deep and personal interest, may largely and permanently contribute to the promotion among my people of the love of Art, as well as to the success of the annual exhibitions, which will bring successively into instructive competition the choicest products of the industries of all nations. These objects could not fail to commend themselves at all times and all places to my sympathy and interest, fraught as they are with recollections of him to whose memory this Hall is dedicated, and whose dearest aim was to inspire my people with a love of all that is good and noble, and, by closer knowledge and juster appreciation of each other, to cultivate a spirit of goodwill and concord among the inhabitants of all regions."

How the plans are to be carried out, of what nature they will be, and who are to be the Art-managers, are facts upon which we presume the public will be, in due course, informed. It will be, we take for granted, in no sense a museum: "the Department" is in that way amply provided. A gallery, at the top of the building, is, we understand, to contain pictures; but under what circumstances who can as yet say?

The ceremonial on the 29th was successful without any drawback. The light was happily subdued: the interior was imposing although simple: grandeur was obtained from size, yet grace seemed the predominating feature; and the conviction was that London had obtained an acquisition to which there was no rival in the world.

Whether it be or be not what is called "a commercial success" matters very little: it is the "speculation" of those who desire enjoyment, and to share it with thousands, rather than interest for money spent; and there can be no feeling of regret if this be the only revenue derived from a magnificent boon to the Nation.

If its proximity to the Horticultural Gardens be taken into account, and its neighbourhood to Hyde Park, its direct union with the Art-galleries of the Exhibition, and its close connection with the Museum of the Department of Science and Art, it presents advantages incalculable, and such as the people of no other country of the world can enjoy.

EXHIBITION OF PORTRAITS,

168, NEW BOND STREET.

AMONG the exhibitions of this season is one situated as above, which is interesting to those who may have watched the fitful phases of the Art, especially among ourselves. It is a collection of likenesses of celebrities and notorieties, and has been formed during, we believe, a lengthened course of years, by Mr. Charles B. Braham, from numerous sources at home and abroad. Among them are portraits which, it may be presumed, ought to grace the national collection, for it possesses none of the persons represented, although, when living, they were of sufficient distinction to command admission to any company of notabilities. In our National Portrait Gallery are pictures indifferent enough, but their pedigree of possession is worthily authenticated—they come with traditions indisputable to claim admission in that very mixed society. It is precisely the insoluble question of authenticity which prevents the addition of many a well-painted, but ill-warranted work to the National collection.

But to turn to Mr. Braham's pictures; the visitor is struck at once by two portraits marked as by Wilkie—they are of Tom Moore, and the Earl of Derby when a student at Eton. We submit that some little account of these portraits would have been interesting—at least acceptable. The Marchioness of Westminster—and Miss Murray as a flower girl, by Lawrence, are indisputable. They seem to be small *replicas* made for the engraver. 'Cesar de Medici,' by Bronzino, a profile, presents a strong family likeness to Giovanni de Medici. By Lucas de Heere is a portrait of Lady Jane Grey wearing the crown. 'Mrs. Billington as St. Cecilia,' by Reynolds, is one of Reynolds's loohest performances; while 'La Belle Hamilton,' and 'Mary of Orange,' are good examples of the manner of the unmistakable feeling of Lely. 'The Churchill Family,' by Kneller, is careful and skillfully arranged, but very cold in colour, and reminds us of the Queen Anne period, when all women were painted like the Sovereign. 'Sir Edward Parry, the Arctic Voyager,' by W. Hilton, R.A., is a fine work. There are also, 'Catherine Empress of Russia, wife of Peter III,' by Mignard; 'Peter the Great,' by Philip Vanduyck; 'Washington, in the uniform of the British Service,' Keale; 'The Margravine of Anspach,' Cosway; 'Madame de Pompadour,' Le Brun; 'Lady Mary Wortley Montague,' Hudson; 'Charles Incedon, the celebrated tenor, as Captain Macheath,' T. Clater; this small picture is very curious. Gainsborough occurs in the catalogue as the painter of Mrs. Thomas Sheridan, mother of Brinsley Sheridan; Mr. Thomas Sheridan, George Morland when a boy, and Lady Beauchamp; and Reynolds as the author of several. John Wilkes, M.P., by R. E. Pine, is not to be mistaken; nor is David Garrick, by G. Dance. 'John Duke of Marlborough,' by William Aikman, is an excellent head; but Sir David Wilkie, by himself, does not come quite home to us as we know him in the pictures wherein he painted himself so often. In 'A Study for Ariadne,' Reynolds, there is no poetic taste or personal grace; but 'Sarah Jennings, Duchess of Marlborough,' is a very favourable instance of the Art of Sir G. Kneller. The expression given to the features of Mrs. Inchbald, by Drummond, is life-like and agreeable. The Marquis of Bute, by Opie, presents a somewhat extravagant taste for costume, which may be termed theatrical. Besides the portraits mentioned there are Mrs. Hogarth, by W. Hogarth; and by the same, Sir Richard Steele. Rogers, the poet, by Sir David Wilkie; Angelica Kauffmann, by Richard Cosway; Sir Robert Walpole, by Hogarth; Horace Walpole, by F. Hayman, &c. We have limited our observations to the portraits, but there are interspersed with them pictures and drawings by many artists of eminence.

To the reflective querist this exhibition is really a most interesting study; it leads him back to the pre-historic vestiges of our school, and shows in many instances the slight pretensions on which in bygone days the reputation of a portrait-painter was founded.

THE FEMALE SCHOOL OF ART.

LORD ELCHO presided at a meeting held, on the 25th of March, in the theatre of the London University to distribute the prizes to students, in this prosperous and admirably-conducted school; which, under the able and judicious management of Miss Gann, has progressed from year to year until it has made good its claim to be considered among the most valuable institutions of the kingdom.

Mr. Rowe Valpy read the annual report; from which it appeared that during the summer session of 1870 the pupils in attendance numbered 155; and in the winter session 139, as against 141 and 122 respectively of the year before. In the award of premiums to head masters and mistresses of Art-schools by the Art-Department of the Privy Council the name of Miss Gann, head mistress of this school, stood second on the list, and the year before it stood third. The relative value of the position thus attained was to be seen when it is considered that this was the only exclusively *Female* school of Art in the kingdom, and that it was conducted entirely by female teachers. In the competitions open to all schools of Art in the kingdom, the school last year had 28 students who reached the standard of third grade prizes, as against 23 the year before; and these had obtained two silver medals as against one in 1869, three bronze as against none in the corresponding period, and five Queen's prizes. Five students, too, obtained "Art Masters'" certificates of competency in special groups of subjects. In the national competition for fan-designs two prizes had been obtained by students of this school, and a third design commended. The Queen's gold medal awards had been adjudged by a committee of artists, to Miss Emily Selous. The gold medalist of last year, Miss Julia Pocock, maintained a high position in the several classes, and Miss Eliza Toulmin Smith, who has distinguished herself in previous years, won the prize of £5 offered by Sir Stafford Northcote, M.P., for the best essay on the use of plants in ornamentation. Annie Elizabeth Hopkinson, Alice Locke, Ellen Isabella Hancock, Jeannie Moore, Christiana Powell, Ellen Ashwell, Jane Gibbons (the daughter of Alderman Gibbons), and Charlotte Austen were among the young ladies who were presented at the *dais* for rewards of merit.

The report then gave other details more particularly connected with the competitions among the students for prizes presented by friends of the school; and the list showed that trading firms were coming forward with offers of prizes for designs, among them being chromo-lithographers, oil-cloth makers, silk weavers, and carpetmakers; thus testifying to the value of these schools, as "a means of infusing correct appreciation of that which is true according to pure taste."

The report and the whole of the proceedings at the meeting are calculated to give exceeding satisfaction to the many who have cherished hope in the well-being and well-doing of the institution: who have indeed been sanguine as to ultimate results from its commencement up to the year 1871; and who continue in the belief that by its means many useful and profitable employments will be found for women.

We have no desire to render this Journal ground on which to carry on a contest as to what is really meant by the "Rights of Women;" but, of a surety, Art will never take her out of her natural sphere, tempt her to slight or abandon the enjoyments of home, or interfere with the household duties which are, as they ought to be, woman's privilege, pride, and reward.

The ways in which Art can provide "helps" to women of all classes are very numerous; and we know that a large proportion of them are considered with a view to results at the Female School of Art. "Agitation," wherever men are employed at occupations for which women are as well qualified, would be judicious and just, and we should rejoice to aid it.

Unhappily, the advocates for what they term "Women's Rights" are so lofty in their aims that they will not condescend to inquire concerning reforms practicable as well as wise.

OBITUARY.

JOSEPH LOCKETT.

THIS gentleman, so long and honourably connected with the artistic and scientific development of calico-printing, as one of our national industries, died at his residence, Sgor Bheann, Dunoon, on the Clyde, on the 5th of February last.

Mr. Lockett was born at Manchester, in 1803, and was educated at the Grammar School of that city. He went early in life to business, and was apprenticed to his father, who, in the beginning of the present century, laid the foundation of the engraving establishment which subsequently became famous under the name of "Joseph Lockett and Son." Mr. Lockett, Sen., was one of the first engravers of copper-rollers for calico-printers, the work being done entirely by hand; but in the early attempts to supersede block-printing, plates were used for printing the cloth, and the results were known in the trade as "plate-patterns." Indeed, the phrase is still used to describe a certain class of calico-prints. The introduction of machine-printing by means of copper-rollers, induced mechanical improvements in the method of engraving, and the "die" and "mill" system was gradually developed. To this Mr. Lockett, Sen., paid great attention, and steadily improved it. Subsequently the method of tracing and etching the rollers by machinery was introduced, by which the patterns known as "eccentrics" were executed and brought to great perfection, especially as "covers" or grounds.

As a matter of course the subject of our notice grew up amidst these varied improvements, and the gradual development of an interesting industry. His natural love of Art, literature, and science, tended to refine his taste in the application of design to his business; while a strong mechanical bias, in combination with a love of scientific experiment, eminently qualified him for directing and improving the various contrivances and operations necessary to the success of machine-engraving, which he carried to great perfection. Always ready to seize upon any discovery bearing upon his art, he paid early and assiduous attention to the electro-deposition of metals, as also to photography; and an essential portion of his extensive works were the laboratories in which the necessary experiments and final processes in these modern applications of science were carried out. The late Mr. John Parry, an active member of the Manchester Philosophical Society, and the friend of the eminent chemist, Dr. John Dalton, was associated with Mr. Lockett's business-operations for many years, and died in the employment of the present firm. The intelligence, taste, and enterprise with which Mr. Lockett carried on his business after his father's death, placed it immeasurably in front of all other establishments of the kind in England, or on the Continent. It supplied copper-rollers to the printers of Mulhouse and Rouen, to Russia, and various parts of Germany and Switzerland, as also to the United States. In fact, wherever fabric-printing by copper-rollers had been established as an industry, there Lockett's cylinders were a necessity; until following the example set them at Manchester, foreigners could in some measure engrave rollers on their own account.

On the establishment of a School of Design at Manchester, in 1841-2, Mr. Lockett became a member of the Council, and took a deep interest in the promotion of the institution. His was no nominal or

perfunctory association. He subscribed liberally, attended the meetings for business, sent the young people in his employment to the school, gave them time to attend even the morning-classes, when they were sufficiently advanced to paint from nature, and paid their school-fees. He never croaked about the non-practical character of sound artistic instruction, provided it was "sound;" and expected, if his apprentices were taught Art in the school, to make them Art-workmen himself in the manufactory.

Mr. Lockett retired from business about fifteen years ago to a charming retreat, which he had gradually reclaimed from a semi-wilderness on the banks of the Clyde. Here, surrounded by his books, and the works of Art which he loved, he exercised a genial hospitality, with the freedom of a kindly-natured gentleman. His yacht was kept quite as much for the pleasure it gave him to take his artist-friends to the varied scenes of the Western Highlands, as for his own use as an amateur sketcher of no mean skill; and every one privileged to enjoy his friendship felt the comfort and ease of a second home when in his house.

We regret to add that his widow survived him but a month: her death took place on the 5th of March, at Sgor Bheann.

WILLIAM BENNETT.

The Institute of Water-Colour Painters is deprived of one of its most efficient supports in landscape, by the death, on the 16th of March, of Mr. Bennett. He began his Art-career rather late in life, and was, we believe, a pupil of David Cox, whose style he adopted as the groundwork on which to form his own. A few years ago his drawings bore far greater similarity to those of his master than his later works show; especially in the treatment of foliage. His works of all periods bear evidence of close study of nature, and, consequently, of truthfulness. Mr. Bennett had reached the age of sixty.

GEORGE NICOL.

A record in our columns is due to the memory of this gentleman, who died, on the 24th of March, in his sixty-third year. He succeeded the late Mr. Barnard as Secretary to the now defunct British Institution, a post which he held many years; and, it may be added, with satisfaction to the large body of artists accustomed to exhibit at the old gallery in Pall Mall. We can ourselves testify to his courtesy and attention whenever we had occasion to ask his services.

ADOLPH VOGT.

We regret to have to announce the death of Adolph Vogt, the promising Canadian artist. He received his first lessons in Art at Philadelphia, and subsequently worked in Munich, and in Zurich under Kohler, the eminent animal-painter. In 1866 he went to Paris, where he studied some time, and having seen the paintings of the Exposition of 1867, formed his style on the French School. His principal works, and those by which he will be best remembered, were executed in Montreal. Among these may be mentioned: 'Harvest Scene in a Storm,' 'The Grey Battery,' 'The Forge,' 'The Falls of Niagara,' &c.

PIERRE PUVIS DE CHAVANNES.

Still another name is to be added to the register of painters whom the late war in France has cut off. This artist is reported

to have died, in the month of March, from wounds received in the defence of Paris. He had somewhat latterly attracted considerable attention in the Art-world of that city by several large pictures: last year he exhibited in the *Salon* the 'Beheading of John the Baptist,' and another painting; both of which received favourable notice from writers in the French journals.

THE CRYSTAL PALACE.

ONE important feature of the Exhibition of pictures in the Crystal Palace Gallery, will be found to be an especially complete representation of foreign contemporary schools. This is the first pictorial display at the Crystal Palace at which awards for merit have been made by a committee of artists and patrons—substantial money-prizes, as well as medals of honour, as we at the time announced. Notwithstanding the fact that the Royal Academy, the International Exhibition, and the Exhibitions of the two Water-Colour Societies, to name no more, open their collections to the public nearly at the same time as the Crystal Palace, an ample display of high-class British pictures is forthcoming this season at Sydenham; while of works by foreigners there will be an unusually fine exhibition. The Crystal Palace Gallery has always been a favourite one with continental artists. Recent events, in France particularly, have driven many of these gentlemen to our shores, and they are our welcome guests; but besides what comes from these contributors, the continental exhibitions being in great degree disturbed, or closed this year, the opportunities offered this season by England have been eagerly responded to, and we shall probably witness an exceptionally good display of continental Art this spring, particularly at the International Exhibition; and in the Crystal Palace Gallery, Mr. Wass has received numerous pictures direct from abroad, and many more from artists already in this country. A vast number of works, greatly exceeding the number that could possibly be hung, whatever their merit, were sent into the new building at South Kensington: most of those that could not be accommodated there have been, there is reason to believe—for the date of reception admitted of it—forwarded to the Crystal Palace Gallery. There is every reason to suppose that the exhibition, both as to native and foreign works, will be a satisfactory one. The gallery at the Crystal Palace is seen by thousands daily; the "sales" are, all things considered, numerous. Artists will do wisely to give it more thought than they have heretofore given, for it may be a powerful auxiliary to Art.

At length the beautiful Alhambra Court of Mr. Owen Jones, and the Byzantine and Romanesque Court which was raised by Sir Matthew Digby Wyatt, are being restored—and in a satisfactory manner. By this is meant that they will, it seems, exist again in their pristine beauty as Art-examples; not be re-decorated in merely house-painter's fashion, as gaudy show-places, more or less beautiful. This is very creditable to the new general management, and is to be welcomed as of good augury that there will be, as was expected, sensitive watchfulness and appreciation for the preservation, at least, of the Art-works. The Alhambra and the Byzantine were the courts of each series nearest to the north or tropical end of the Palace where the calamitous fire broke out, and were most exposed to its ravages: the Byzantine especially. The present works in the Alhambra Court might afford Mr. Grove an opportunity of making an alteration in the mode of lighting the Hall of the Abencerrages, which would develop the exquisite beauty of artistic resource in the decoration of its dome-shaped roof, as the Eastern ornamentist intended. The structural form of the decoration, and the colouring, are designed to give effect to illumination from below—not to receive artificial light from the exterior. The tempered daylight through the small windows of fretwork, and

shining through stained glass, is rich and appropriate. But when the chamber is illuminated it should be from a large lantern, glazed with coloured tints; such a lantern as those still common in Constantinople and the East. This should be suspended sufficiently low from the centre of the dome. Then the cavities in the roof, which the artist has designed and coloured and gilded to be reflectors for the rays, would have their proper usefulness, and show the quiet splendour of richly-toned luxurious light, with its mystery of beauty, of which the Arabian artist sought to achieve the expression.

PICTURE SALES.

A COLLECTION of miniatures, pictures, and other works of Art, the property of a French nobleman who had sent them to London from Paris before the siege of the latter city, was sold, on the 9th and 10th of March, by Messrs. Robinson, Son, and Fisher, at their rooms in Old Bond Street. The most prominent objects were:—A *Carnet-de-poches*, 'beautifully chased, with portraits of Marie Antoinette and La Comtesse d'Artois; presented to the Marquis de Cammont by Marie Antoinette, on the 12th of July, 1781, with writing by the unfortunate Queen, £460 (Durlacher); Portrait of Mlle. Doré, by Greuze, 96 gs. (King); 'L'Épicier,' a domestic scene, also by Greuze, 95 gs. (James); 'The Battle of Val,' a very beautiful drawing in water-colours containing many thousand minute figures; and its companion, 'The Siege of Brussels,'—a winter-scene showing the besieging commander and his staff in the foreground, the city in the distance,—by Van Blarenbergh the Younger, 880 gs. (Durlacher); 'The Port of Toulon,' and 'The Port of Brest,' a pair of oil-paintings by Van Blarenbergh the Elder, 560 gs. (Durlacher). The former picture once ornamented the Palace of Versailles.

Messrs. Christie, Manson, and Woods sold, on the 11th of March, at their galleries, in King Street, St. James's, the following works, with others:—A Group of Implements of the Chase, with a dead Cock and a Brace of Partridges,' W. Vander Helst, £106 (Tooth); 'Interior of a Kitchen,' P. de Bloot, £73 (Tooth); 'Landscape,' J. Wynants, with figures by A. Van de Velde, 100 gs. (Seguier); 'A Fête-Champêtre,' Watteau, a fine example of the master; it includes a large number of figures, 700 gs. (Rutter); 'Portrait of Sir Walter Scott,' Sir W. Allan: this picture we spoke of last month as purchased for the National Portrait Gallery, by Mr. G. Scharf, for the sum of £367.

Messrs. Christie, Manson, and Woods sold, on the 18th of March, the collection of beautiful water-colour drawings formed by Mr. E. Heritage, of Denmark Hill, Camberwell. It contained about one hundred and thirty examples, of which the more important were:—'Crossing the Stream,' a specimen of D. Cox, 141 gs. (Seddon); fine 'Mountain Scenery,' with a flock of sheep, D. Cox, equally fine, 195 gs. (Jones); 'Morning after a Wreck—off the Mumbles,' 'Ships off Portsea,' and 'The Windmill—Evening,' three drawings by E. Duncan, 180 gs. (Agnew); 'A Homestead,' and 'Windmill, Harvesting in the North,' both by P. De Wint, 124 gs. (Seddon); 'View on the Thames near Windsor,' 170 gs. (Permain); 'Resting in the Wood,' 155 gs. (Castle); 'The Ford at Windermere,' and 'Barley Harvesting,' 86 gs. (McLean); these four are by Birket Foster; 'The Little Domestic,' and 'See-Saw,' a pair by E. Frère, 78 gs. (Permain); 'Ulleswater,' G. A. Fripp, 170 gs. (Seddon); 'The Young Anglers,' and 'The Petted Calf,' both by A. Fripp, 135 gs. (Jones); 'The Piazzì Signori, Verona,' 'Genoa,' and 'The Rialto, Venice,' three drawings also by A. Fripp, 145 gs. (Jones); 'The Rabbit-hutch,' 'Grapes, Plums, and Cherries,' and 'The Young Smuggler,' W. Hunt, 145 gs. (Jones); 'The Rustic Artist,' W. Hunt, a rare example, 260 gs. (Gurney); 'St. Martin's Church,' W. Hunt, 140 gs. (Gurney); 'David

Slaying the Lion,' John Linnell, Sen., 125 gs. (McLean); 'Haling on the Road,' 100 gs. (White); 'The Peat Gatherers,' 196 gs. (White); and 'Rustic Life,' 100 gs. (White); 'The Milkmaid,' 55 gs. (Vokins). These four are by F. Taylor. The whole collection realised upwards of £7,000.

The "stock" of Mr. Henry Wallis, who is retiring from business in favour of his son, was sold by Messrs. Christie and Co., on the 24th and 25th of March. The pictures numbered rather more than 250, very many of which are by foreign artists of high repute: our own school was also strongly represented. The more prominent examples were:—'The Tower, ay, the Tower!' Mrs. E. M. Ward, 120 gs.; 'Which Hand will you have?' M. Heeren, 92 gs.; 'Troubles in the Church,' J. B. Burgess, 155 gs.; 'A Fleecy Charge,' J. Braith, 110 gs.; 'A Maronite Girl,' V. Lecomte, 140 gs.; 'Marguerite,' H. Merle, 208 gs.; 'The Visit,' G. Koller, 200 gs.; 'Sheep Leys, near Ripley, Surrey,' F. W. Hulme, a large and excellent specimen of this painter, 135 gs.; 'Phryne,' and 'Penelope,' a pair by C. Marchal, 275 gs.; 'Raising a Church-Rate,' J. Morgan, 155 gs.; 'Fishing-Boats off Hastings,' C. E. Johnson, 105 gs.; 'A Halt near Cairo,' A. Schreyer, 124 gs.; 'Bed-time,' W. P. Frith, R.A., 160 gs.; 'Contemplation,' A. Toulmouche, 100 gs.; 'Serenading,' J. Bertrand, 105 gs.; 'An Island on the Llugwy,' B. W. Leader, a fine landscape, 220 gs.; 'The Windings of the Wye,' J. M. W. Turner, R.A., 115 gs.; 'The Sick Chamber,' W. Q. Orchardson, A.R.A., 138 gs.; 'Lady Macbeth,' T. F. Dicksee, 150 gs.; 'Heron and Setter,' R. Ansell, R.A., 102 gs.; 'Esther imploring Pardon of her People from Ahasuerus,' a large and important work by J. Portaels, 300 gs.; 'Ancient Roman Wine-Merchants,' Alma Tadema, 235 gs.; 'En Deshabille,' J. Phillip, R.A., 135 gs.; 'A Summer's Day on the Rhine—Mayence,' J. Webb, 130 gs.; 'The First Sitting,' H. Schlesinger, 155 gs.; 'Caught Napping,' J. C. Horsley, R.A., 125 gs.; 'A Mother's Care,' T. Faed, R.A., a beautiful cabinet example, 435 gs.; 'Collecting Alms,' J. L. Gerome, 135 gs.; 'Scene in North Wales,' T. Creswick, R.A., 110 gs.; 'Motherless,' W. C. T. Dobson, A.R.A., 135 gs.; 'A Calm Day on the Scheldt,' P. J. Clays, 210 gs.; 'The Ferry,' C. Troyon, perhaps the finest work of its class in the whole collection, 550 gs.; 'A Coptic Woman,' F. Goodall, R.A., 100 gs.; 'Playmates,' L. Perrault, 225 gs.; 'Logarno, Lake Maggiore,' G. E. Hering, the figures by F. Goodall, R.A., 125 gs.; 'On the Thames,' G. D. Leslie, A.R.A., 102 gs.; 'Maternal Solitude—This Sickness is not unto Death,' W. Bouguereau, one of this artist's best works, 510 gs. The entire collection realised £15,000. The names of the purchasers did not reach us.

The retirement of Mr. Gambart from business brought into the sale-rooms of Messrs. Christie and Co. his valuable stock of paintings and water-colour drawings, comprising nearly 300 works, which were sold on the 31st of March and the 1st of April. The following examples may be recorded as the most important:—'The Fisherman's Home,' E. Frère, 125 gs. (Everard); 'Sweet Anne Page,' W. P. Frith, R.A., 112 gs. (Cox); 'A Sprig of Shillelah,' T. Faed, R.A., 405 gs. (Permain); 'The Attempted Escape of Mary, Queen of Scots, from Lochleven Castle,' P. H. Calderon, R.A., 180 gs. (Agnew); 'Christ and his Disciples at Capernaum,' C. R. Leslie, R.A., 195 gs. (Permain); 'A Surrey Lane,' Birket Foster, 250 gs. (Cubitt); 'John Anderson, my Joe,' J. Faed, R.S.A., 435 gs. (Rutley); 'The Golden Age,' W. Etty, R.A., 175 gs. (Pilgeram); 'The Prison Door,' L. Gallait, 126 gs. (Everard); 'Mother and Child,' L. Gallait, 278 gs. (Vokins); 'Finding of the Saviour in the Temple,' the drawing executed by Moselli for the engraving of Holman Hunt's picture, 120 gs. (Cox); 'The Elixir of Love,' G. J. Pinwell, 250 gs. (Tooth); 'Gipsy Fortune-Teller,' F. Taylor, 178 gs. (Poeock); 'Gentle Spring,' F. Sandys, 335 gs. (McLean); 'Bianca,' from *Taming the Shrew*, W. Holman Hunt, 305 gs. (Pilgeram);

'The Artist's Studio,' W. P. Frith, R.A., 185 gs. (Cox); 'The Siesta,' Alma Tadema, 260 gs. (Griffiths); 'Our Street,' F. Goodall, R.A., 375 gs. (Gaskell); 'Exterior of a Coffee-Shop,' F. Goodall, R.A., 135 gs. (Permain); 'A Merchant from Mecca, and a Dervish,' F. Goodall, R.A., 170 gs. (Morby); 'Dunstanburgh Castle,' Birket Foster, 275 gs. (Tooth); 'How the Egyptians Enjoyed themselves 3000 years ago,' Alma Tadema, 200 gs. (Everard); 'Horses frightened by Fire,' A. Schreyer, 230 gs. (Morby); 'Alas, poor Yorick!' P. N. Calderon, R.A., 360 gs. (Agnew); 'Calvin,' Ary Scheffer, 290 gs. (Everard); 'Scene in the Pyrenees,' Mlle. Rosa Bonheur, 910 gs. (Cox); 'When the day is Done,' the fine picture by T. Faed, R.A., exhibited last year at the Royal Academy, 1,300 gs. (White).

Included in the sale was the extensive series of Egyptian sketches, by F. Goodall, R.A., exhibited at the Academy in 1869; a few of these are noticed in the above list; the majority of them, however, was disposed of in pairs, or trios, or quaternions; and although the "lots" sold remarkably well, it would occupy too much of our space to give them in detail. The aggregate amount these sketches realised was £3,415. Mr. Gambart's entire collection reached the large sum of £18,250.

We are pleased to find that private collectors are not bringing their pictures into the market this season: the announcements of such sales are, hitherto, very few.

SELECTED PICTURES.

FROM THE PICTURE IN THE COLLECTION OF FREDERICK CRAVEN, ESQ., HOPE LODGE, MANCHESTER.

"A BABY WAS SLEEPING."

F. W. Topham, Painter. C. W. Sharpe, Engraver.

FEW, if any, of our artists have been more successful in delineating Irish domestic life than Mr. Topham, whose pictures of this class have for very many years been exhibited in the gallery of the Water-Colour Society, of which he has long been a member. He does not limit his practice to such subjects, but a "picture-season," without one of Topham's Irish scenes would be almost unprecedented. Hence have appeared his 'Irish Courtship,' 'The Holy Well,' and 'Ballinasloe Peasants,' with a host of others it is needless to point out. He is familiar with the sports and pastimes of the country—the lawful and inoffensive sports, not the orgies, and quarrels, and uproar of an Irish fair—and with the home-life of the peasantry, whose character he depicts in its most inviting and agreeable forms.

Of such is the composition which has received its title from the opening line of a well-known and popular ballad. It reveals the interior of an Irish cabin, scantily furnished, as these dwellings usually are: in fact there is not a piece of furniture visible, except the rude cot, in which the infant sleeps as sweetly as if lying on a pillow of down, and the spinning-wheel of the child's mother, who kneels by the side of the child, praying to the Virgin for a blessing on her offspring; for the rosary of beads with the pendent cross, shows her to be a disciple of the "old faith." There is an earnestness in the woman's attitude and countenance that expresses entire belief in the efficacy of her supplications. Behind her is an elderly female, who is possibly reading the prayers in which the younger silently joins: and on the wall hangs a representation of the Virgin and Infant Jesus. It is a pleasant picture of ordinary Irish life; in it truthfulness prevails over the poetry of Art.





ROYAL BIRMINGHAM SOCIETY OF ARTISTS.

THE spring exhibition of this Society (chiefly composed of Water-colour drawings) was opened to the public on the 24th of March. It includes not fewer than 600 works. The liberality of well-known local and other collectors has materially aided the interest of the display. There are fine examples by Turner, R.A., William Hunt, F. W. Topham, Wehnert, G. Chambers, Copley Fielding, Tayler, Barrett, F. Roberts, Catermole, P. F. Poole, R.A.; L. Haghe, G. Fripp, S. Prout, T. Danby, D. Cox, and others. It will, however, be understood that the interest of the exhibition is not wholly dependent for its attractions to works on loan, when it is stated that there are important examples by Birket Foster, Collingwood Smith, Harry Johnson, S. Bough, R.S.A., H. Moore, Carl Haag, T. M. Richardson, F. Nash, C. J. Lewis, R. S. Bond, A. and J. Bouvier, G. Barnard, S. Rayner, E. Walton, F. Walker, W. Callow, W. C. T. Dobson, W. J. Mückley, &c.; and by female artists from a distance, are works by Mrs. W. Oliver, and Misses M. and L. Rayner, Constance Phillott, Bouvier, and Coleman, &c., (the works of the last named rivalling those of William Hunt in delicacy, beauty, and minute finish). Want of space must form our apology for merely indicating the names of contributors from a distance, as it must also serve for an almost equally brief notice of the works of local artists, &c.

Pleasant as ever is F. H. Henshaw, in his sunny glimpses of the architecture and scenery of our own and other countries; equally so in his tree-embowered, ferny and shady nooks. C. J. Burt's landscapes, truly, broadly, and freely painted, ever tell of nature and out-of-door influences. Some regret may be expressed that R. S. Chattock has, for the present, abandoned the brush for the etching-needle; he contributes only "proofs" of etchings instead of the results of his pencil dipped in colour. W. Hall contributes but one work—like those of C. J. Burt, in oils. Something more than a word of praise is due to S. H. Baker, whose great advance is very apparent in his 'Mountain Road in Wales.' Hereditary talent and equal progress is very apparent in the bold and clever landscapes contributed by his two sons Harry and Alfred, (who have evidently chalked out a path for themselves). C. R. Aston is as careful as ever. The pictures of F. H. H. Harris have original features in them. J. Steeple is most successful in his works executed in two colours, a brown and neutral tint. There are contributions of merit by C. W. Radcliffe, W. H. Vernon, J. H. Munns, F. Green, E. Taylor, H. H. Lines, and the honorary secretary, A. E. Everitt, always finds time to furnish his quota of works to the exhibition. F. Hinkley takes the lead in figure-subjects; his works attract attention by their artistic treatment, breadth, and colour. J. Pratt and W. T. Rodens contribute works worthy of notice. T. Worsley, in floral subjects, is still at the head of his speciality. We leave, from want of space, any allusion to the works contributed by male amateurs, many of which are very creditable. Miss Aston sends a couple of carefully-painted miniatures; with a word of commendation to Miss Steeple, we must leave unnamed other lady-aspirants for artistic honours, with the remark that Art in Water-colour, it is evident, is not entirely monopolised in the locality by artists of the sterner sex.

Our notice, for reasons already given, is inadequate to convey even an approximate of the value of the exhibition in its artistic wealth. The success of the exhibitions of this Society of Artists are due to the presence in its body of earnest, energetic, and hard-working men, who have thereby secured the confidence alike of collectors and artists; they are thus enabled to bring together by their exertions two exhibitions in the year. To these are added courses of lectures on Art—one, on Artistic Anatomy, is now being delivered by the Society's Professor of Anatomy, Mr. Furneaux Jordan, F.R.C.S.

ART IN SCOTLAND, IRELAND, AND THE PROVINCES.

EDINBURGH.—A fine allegorical painting, the latest from the easel of Sir J. Noel Paton, R.S.A., is at present being exhibited in Edinburgh. It bears the title of 'Faith and Reason—a Thought for the Times.' Some years ago the artist executed a sketch of a similar subject—yet differing in several of the main features. The work, as now completed, is striking and original. The power of Reason is represented under the form of a warrior, resolutely toiling his way amid the rocks and briers of a misty mountain-range. His face is furrowed with the long mental struggle, his eye is earnest almost to sadness: and while with one hand he probes the ground with his sword to ensure a safe footing, the other is laid on the shoulder of a wondrous being close beside him. The principle of Faith is embodied in a beautiful female figure. Half human, half divine, she is seen ascending with outspread wings from the clouds and shadows of earth up to the grand empyrean beyond. Her countenance is eloquent of that childlike trust peculiar to such as are of the heavenly kingdom. The tender light of her uplifted eyes tells of the beatific vision on which she is gazing: her golden hair streams behind, her hands are clasped devoutly, her vesture is the spotless robe of the saints, a zone of pearl and diamond encircles her waist, and her whole soul is wrapt in awe and adoration. The contrast between the steel mail of the dusky-visaged soldier, and the ethereal transparency of his companion, is the finest point in the picture.

DUBLIN.—Art must be at a low ebb in Ireland—the country that has produced so many great artists—when the members of the Royal Hibernian Academy prefer a petition to the legislature to repair the roof of their exhibition-room. The society is the only one in the kingdom that receives an annual grant from Parliament; it is but £300 a-year, sufficient to do much mischief and no good, for it undoubtedly deprives the body of that self-dependence out of which only can come success. Their rooms were a free gift from a generous citizen; their annual exhibition produces some income; and their expenses cannot be large, for we do not hear that much cost is incurred by schools. The truth is—and it is a very unhappy truth—that Art obtains but little patronage—direct or indirect—in Ireland. Dublin is the only city in which an exhibition of modern pictures takes place, excepting Belfast, where there is infinitely more public spirit, energy, and enterprise; and where Art, in a degree, prospers, although as yet, we believe, a school of Art has not been established, notwithstanding the patriotic zeal of Marcus Ward and a few other liberal gentlemen of that active, industrious, and thoroughly "thriving" town of "the black north."

GRINLEY-ON-THE-HILL.—The ancient parish-church of this small village, situated near Bawtry, Yorkshire, has somewhat recently been adorned with a stone-pulpit, designed and sculptured by the Rev. G. Hopton Scott, Vicar, in harmony with the architecture of the church, which belongs to the Transition period. It shows circular pillars supporting panels of pointed arched open-work, with a line of "dog-tooth" ornament at their base. We have seen some photographs of these panels; they testify to the graceful proportions of the design and to the delicacy of the carving. Among numerous other ornamental additions to the sacred edifice a stained-glass memorial window has been lately placed in the walls: this was also designed by the vicar; the glass being supplied by Messrs. Powell, of Whitefriars. The parish, we understand, is comparatively poor, with a majority of Nonconformists among the inhabitants; and yet the latter equally with churchmen, have aided the incumbent in restoring and beautifying the church during the last few years: the fact is most creditable to all. We are glad to recognise the services of the clergy in matters of Art: it is well for a parish when its minister is both willing and able, like Mr. Scott, not only to institute, but also to aid in carrying out, such works as have been done at Grinley during his officiate.

THE EXHIBITION OF THE SOCIETY OF BRITISH ARTISTS.

If the degree of progress shown in these rooms be maintained and advanced, the future exhibitions of the body will be looked forward to with a greater measure of interest than heretofore. We speak, it need scarcely be said, in reference to works of a certain class. There is on the walls an endless variety of subject, and if there be some want of reading the fault is rather with the public than the profession. This is the second year that members of the Royal Academy have sent pictures to these rooms, but it must be remarked that in what they contribute they are careless of doing themselves justice. The recognition, though tardy, should at least be worthy of themselves. The number of small pictures of excellent quality now exhibited is remarkable; they comprehend every class of subject, and much of the philosophy of Art is to be learned by an analytical comparison of these small things with greater. But to particularize some of the most prominent examples in the rooms.

'The Warrior's Cradle' (146), by the late D. Maclise, R.A., is known to our readers by the engraving of it which appeared some time since in our work. No. 126, which, in default of a title, we may call the Capture of Gaveston, by V. W. Bromley, abounds with good and sound work, and great attention to the costumes and equipments of the time; but the incident is thin, and in this version has but little to say for itself. Mr. Bromley has here another very well-painted picture from the "Fortunes of Nigel" (136), but it also loses much of its real value by its own reticence. A long story must be told to develop its point. 'A Nymph and Bacchanal' (139), W. Salter, is the most successful essay in the poetic vein that this painter has exhibited. It is harmonious and brilliant in colour, and evidently a result of great labour. 'Ye most worshippfulle ye Maire' (148), W. H. Weatherhead, scarcely deserves to be set down as a practice-study: the figure is very carefully worked—seated in municipal state (*temp.* Hen. VIII.). In 'Richard Hooker writing his great Work, Ecclesiastical Polity' (168), the artist, R. Clothier, does not show us the good man exclusively oppressed with literary cares, but, according to the familiar story, in the act of upsetting the infant in its cradle, which his wife had committed to his charge. 'Carmela,' A. Ludovici (17), is an Italian girl knitting; in this the simple daylight breadth is not accepted, but the lighting is such as to render the study more than merely characteristic nationally. 'The Echo' (46), C. Baxter, diverges from the presentments of this painter as we have known them for years, as having more of the salt than the sweetness of Art. Mr. Baxter exhibits other works in which he is not ashamed to show persistent efforts of studentship. To 'The Cottage Door' (47), E. J. Cobbett, the spirit of the same remarks will apply. When time, which deals so much more tenderly with pictures than it does with men, has passed over this example with its harmonizing glaze, then will the full relish of its quality be acknowledged. Mr. Cobbett exhibits other works of various degrees of excellence. To the number 61, W. P. Frith, R.A., are appended the following lines in the place of title:—

"She gives a side-glance and looks down,
Beware! Beware!
Trust her not!
She is fooling thee."

From the verse it might be inferred that two persons were present, but there is only one—that of a tall and handsome girl endowed with as much natural grace as can be imparted to such an impersonation. It is an elegant figure in modern dress. 'The Arrival of the Pigeon Post' (87), T. Roberts, is of course an allusion to the recent state of things in Paris. The picture represents a French woman in provincial dress caressing a pigeon that has brought her news from Paris, or elsewhere. The incident, which is well painted, is so treated as to be interesting when the present political crisis in France is matter of history. 'Portrait of a Lady' (111), Sir F. Grant, P.R.A., is a small life-

sized figure in a black dress, extremely simple. 'Daphnis and Chloe' (186), A. Ludovici, Jun., carries us into classic poetry. The subject is ambitious, but the adjustments present undue angularity, and in the drawing there is somewhat of the poverty of the model. The point of 'Hard Pressed' (190), Valentine W. Bromley, is so well made out that it is worth a little more auxiliary accessory and careful working. There is but one figure, that of a man standing in an expectant attitude at a door about to be broken open. 'A Fruit-Seller' (195), J. H. S. Mann, is perfect in drawing, and highly successful as a study of colour. Mr. Mann exhibits also 'Morning' (130), 'Reflection' (246), and another; all are distinguished by much beauty of colour and great manual *finesse*. 'Columbus' (298), H. T. Munns, is a well-painted profile, but endowed with more grandeur of expression than appears in the recognised portraits of Columbus. By W. E. Frost, R.A., there are, under the title of 'L'Allegro,' some elegant sketches in water-colour for a large picture. In 'Isaac Walton Fishing in the Colne' we meet E. M. Ward, R.A., in a new character. In the river-side scenery is a studious avoidance of the vulgarity and commonplace of such subjects: in this Mr. Ward separates himself from the mass, and classes himself as an old master. The figure representing "dear old Isaac" is intensely piscatorial, and his fixed attention to his float has its reward, for he is taking perch of a size which are rarely met with in these days. 'A Lassie from the Land of Burns,' T. Faed, R.A. (62), is a miniature in oil of rare texture and finish: a suggestion, of course, as to size, from the French, and though very different in character, yet rivalling the small French works in completeness. In 'King Edward V.' (15), the painter, A. B. Donaldson, seems to read for himself. The spirit of the picture may be gathered from the lines from *Richard the Third*:—

"I do not like the tower of any place.
Did Julius Cæsar build that place, my lord?"

A similar remark applies to 'The Princess and her seven Swan Brothers' (163), by the same hand. 'A Syrian—Sketch from Nature' (120), W. Gale, is more than a sketch, being a study of a head painted with remarkable care; and in 'La Bella Caprese' (124), (why an Italian title?) there is much more taste than in the works usually exhibited under this name. 'The Rose' (363), J. J. Hill, is a careful study of a very fair girl, wanting perhaps the delicacy intended in the roundness and substance which usually mark the impersonations of this artist. 'Hircell' (281), Miss L. Romer, is a successful study of a female head and bust. 'The Bracelet' (245), A. G. Woolmer, is a charming figure, and other pictures by the same hand have not less merit; as 'The Sister of Viola' (232), 'Come into the Garden, Maud' (260); there is also by Mr. Woolmer a version of the 'Terrace at Haddon,' one of those *cari luoghi* from which, like the Palace at Venice, no painter can part without a reminiscence. We cannot but think that, if the mood of Mr. Woolmer's execution were less sportive, his works would be more valuable. 'The Penitent' (255), J. T. Peele, has often been painted before, but seldom with a power of description so accurate as we find here. The figure has a common fault—the hands are too large. 'Stella' (336), G. Pope, like all single, especially female, quiescent figures, depends on the sentiment implied; and here this is sufficiently legible. 'Yarn Spinning' (387), W. H. Midwood, is an agroupment of a sailor and a girl, to the former of whom is allotted the task of spinning, while the latter is not an unwilling listener. The scene is a well-painted cottage-interior. 'At Peep of Day' (446), J. Hayllar, shows a little boy sitting up in bed at the time designated in the title, and amusing himself with a new toy—a drum—much of course to the delectation of the whole family. The little figure is bright in colour, and substantially painted. 'The Esmeralda' (473), G. Innocenti, is on the other hand a thin and shadowy semi-nude figure, dipping her feet in a stream. The very extravagance of this character has made it a favourite with young French painters, and the more so that it is readily identified by those peculiar properties the goat

and the tambourine. 'Hush!' (479), A. Provis, is a small cottage interior with figures extremely well coloured and otherwise unexceptionable. 'Rival Pets' (515), G. Bonavia, is skilful in its mechanism—a lady is reclining in her chair, her attention divided between the baby on the floor and a pet dog by her side.

'Parting Day' (12), A. Clint. It requires the study and experience of a life-time to paint locality up to the full measure of a proposed sentiment. The observation we have now to make is, that Mr. Clint succeeds in this, which is no small praise. He has always kept up wonderfully the bone and muscle of his subject, but this he now animates with a breathing spirit. He has worked through a long course of years obstinately true to himself, inasmuch that in his work is no leaven of any other manner. 'Parting Day' is a twilight coast-scene of great power. Mr. Clint exhibits other works, as 'Evening—Coast Scene' (206), 'Lake Scene—Sunset' (310), 'Coast of North Wales' (278), &c. J. Tennant, another old and valuable member of this society, has sent a 'Distant View of the Pass of Nant Frangon, the Valley of the Ogwin, and Village of Bethesda—the Lull before the Storm' (29). The scene is enclosed by hills, and the object has been to keep the far and nearer distances clear, and to describe the rapid approach of a thunder-storm, which already throws its black mantle over the remote hills. Mr. Tennant declares himself keenly alive to the great fact that the sky should play a very important part in a landscape; but the phases of the sky constitute a study so subtle that the endowment of this part of the picture with descriptive language is too often abandoned in despair. Mr. Tennant has also painted 'Scene near Wateringbury, Kent' (259), 'Glen Scene near Llangwydr,' &c. 'Harvesting' (41), by G. Cole, is a large and very conscientious essay, with a piece of very effectively painted distance. By the same hand are 'St. Michael's Mount from Marazion' (140), 'A Passing Shower' (213), &c. 'The Transept and Choir of St. Madeline, Troyes' (50), Wyke Bayliss, is full of the most embarrassing fret-work, and though thoroughly lighted, is by no means weak. By H. Johnson is an excellent work (397), which in the place of title is accompanied in the catalogue by Byron's lines, 'The Isles of Greece, the Isles of Greece,' &c. It is treated with considerable license, indeed, were it not so it would not be so pleasing as it is.

'A Summer Afternoon' (82), J. Peel, is a small piece of rough landscape, firmly painted and bright in colour. A 'Fishing Smack leaving the Harbour of Great Yarmouth—Storm coming on' (184), E. Hayes, is the result of acute observation and extensive knowledge. A view of 'Sisot' (59), and 'Sunrise at Longsor' (63), are two very masterly sketches by F. Leighton, R.A. Other noteworthy pictures are three or four landscapes by H. Moore, each with a peculiarity of its own; 'Moonlight on the Seashore' (88), A. Gilbert; 'Fort d'Ambleteuse—Fishing Lugger Putting to Sea' (105), J. J. Wilson; 'On Loch Etive—Twilight' (109), G. F. Teniswood; 'Oyster Boats going out—Swansea Bay' (129), G. S. Walters; 'An Autumn Afternoon' (143), J. Syer; 'A Still Autumnal Day' (150), W. W. Gosling; 'Under the Hedge' (158), Thomas Worsey; 'Fruit and Still Life' (164), C. T. Bale; 'Llantrassen Castle, South Wales' (469), J. P. Pettitt; 'Welsh River Scene, Montgomeryshire' (493), J. C. Ward; 'Bubbles' (54), and others, by W. Hemsley; 'The Forge' (60), M. Wyllie; 'Evening' (55), J. Danby; 'Moonlight' (433), L. C. Miles; 'A Cloudy Day on the Heath' (447); W. S. Rose, &c. Among the water-colour works a wider range is noticeable in the degrees of quality than in the oil-pictures. Over the fire-place we remark a very admirable study of a head by E. M. Ward, R.A.: elsewhere are others in every variety by S. Rayner, H. A. Harper, T. J. Watson, W. W. May, G. S. Walters, W. P. Burton, B. E. Warren, E. Radford, W. W. Gosling, R. Nottingham, G. Wolfe, B. Rudge, E. M. Wimperis, T. F. Wainwright, H. Baker, J. L. Williams, &c.

Of the exhibition as a whole, it will be felt, that whatever degree of advancement may be

claimed for figure-painting, the department of landscape shows a much more marked progress; and if the prospects of the society were bright before, they are now yet more inspiring.

SCHOOLS OF ART.

CHELTENHAM.—This school, which has recently removed from somewhat inconvenient premises in Winchcomb Street, to a more commodious and central place in Clarence Parade, held its eighteenth annual meeting for the distribution of prizes on the 14th of March. The institution is in a sound and healthy condition, and the morning classes are well attended; but Mr. Knight, the master, wanted, he said, to gain a further hold upon the evening classes; that is, on those who are engaged in trading and industrial pursuits: to attract such it was proposed to make a reduction in the fees.

CORK.—In December last Mr. W. Barton, of Boston, Lincolnshire, offered two prizes of £5 and £3 respectively for the best designs for encaustic tiles for ornamenting the sides of stoves. The competition was open to thirty-six schools of Art; the result is that the first prize was awarded to Miss Annie Baker, of the Cork school; and Mr. H. Barton has purchased the designs sent in by Mrs. Henry Hill, of the same institution, and has stated his opinion that the second prize should also have gone to Cork.

HANLEY.—One of the five prizes of £10 each offered by Mr. Edward T. Dresden, through the Department of Science and Art, for designs in pottery and for porcelain-painting, has been awarded to Mr. Joseph Ellis of the school in this town, for an oviform vase, the general design being that of the Renaissance period. On one side is a *bas-relief* of a draped female figure dancing, and on the opposite side the same figure in repose. It has two floriated handles, round each of which is entwined a snake; while near the lower end of the handle is a Cupid clambering upwards, and blowing a horn with the intention of frightening away the reptile. There are subordinate enrichments both of a natural and conventional description. The work was produced under the supervision of Mr. Bradbury, the recently-appointed headmaster. The vase will, we understand, be on view at the International Exhibition now open.

RYDE.—Through the strenuous exertions of many of the most influential inhabitants of the town, a school has at length been opened here, under the presidency of Mr. Vivian A. Webber, a gentleman who has always shown much interest in matters of Art of every kind; in proof of which he presented, some time since, to the Corporation, two large and excellent oil-pictures, marine-subjects, painted by a clever artist resident in the island: these works now adorn the great room of the Town Hall. Prior to the opening of the school, a public meeting was held in the Hall, when Mr. Webber delivered an inaugural address, on "Art, in its Relations to the Community," with some observations on its Study. For the present the school is located in a commodious room belonging to the Ryde Literary and Scientific Society, which has been lent for the purpose: the number of pupils on the roll already amounts to fifty: the master appointed to direct their studies is Mr. W. S. Crosbie. The school being now fairly launched, and with every prospect of success, we hope to record hereafter its progress and prosperity. The president intimated his intention to give one or more prizes annually, as soon as a certain degree of proficiency had been attained by the students.

SWANSEA.—The annual distribution of prizes and certificates in connection with what may be called the amalgamated Schools of Science and Art and the Oxford Local Examinations, has been held, when Mr. H. P. Vivian, M.P., presided, and Mrs. Vivian presented the prizes. The school was only opened in January, 1870; and the number of pupils that have attended the evening classes had reached 109, of whom all except eighteen were artisans; the classes held in the day-time numbered 166 pupils. The instruction given by the masters extends to the collegiate and other private schools, as they may be termed.

MR. PRITCHETT'S DRAWINGS.

THE works recently exhibited by this artist at Messrs. Agnew's Gallery, in Regent Street, present a striking contrast to those which were seen by the public last season. The latter appealed to the eye as the productions of some select resuscitated member of our water-colour Art in its infancy; of one who had been a sketcher for a life-time, and who knew how to exercise the power that was in him: the former show a colour, delicacy, and precision which can result only from laborious and careful experience. Mr. Pritchett breaks ground in the north of Europe: he takes us to Denmark and Sweden, and we are the more impressed with the gallantry of his enterprise as the world was all before him where to choose. In his 'Copenhagen Port—the Entrance' (30), we look directly into the harbour, the shores of the passage being covered with warehouses and other buildings, and the harbour itself presenting a throng of vessels of various denominations. This drawing has been most carefully worked, and is, we believe, the property of the Queen. Other subjects from Copenhagen are, 'Copenhagen—the Port,' and 'The Market-place' (2). 'The Kronborg looking down the Sound' (26), is made out with equal care. This drawing shows in its foreground much of the facile resource of the artist. 'Maasluis, Holland' (31), is entirely Dutch—flat, with masses of water threatening the land.

'Malmo—Bathing Place, Sweden' (36), presents a quadrilateral building very much resembling a fort. Although the structure would tell as a principal in any drawing, yet there is more than ordinary prominence given to it by its successful treatment. 'Domberg' (43) is a grey drawing, such as one of the ancient Dutchmen might have made while working in nature's studio, and undistracted by any of the factious outpourings about systems of colour. In 'The Wives Watching' (47), two or three figures are dimly seen straining their eyes over the wide and lonely sea, but their constancy is not rewarded by the sight of even one sail ever so distant. Mr. Pritchett is evidently an effective story-teller; there is but little here, yet we have a copious detail of the joys and sorrows of the fishermen of the Dutch coast. 'The Well at Scheveningen' (50) is one of those subjects which would escape the attention of a native artist; but as we see it here, it would make a very interesting oil-picture, and with much of novelty to us—Teniers, Ostade, and Jan Steen, notwithstanding. The 'Sand Storm' is a feature only of a coast with low-lying sandy dunes: the gale is off the sea, and the description of the attendant confusion is so literal that the situation is at once understood. Very different from all these is a study made at Aldershot for the King of the Netherlands. The drawing shows a great expanse of ground, with troops of all arms working out the programme of a grand held-day. There are in the nearest sites of the view a group or two of men—principally a private of, apparently, the 42nd, with a piper of the same regiment, and near them an officer. This drawing is simply in black and white, but is, on the whole, more carefully elaborated than any other of the series. Again, with a high degree of finish, is a distant view of Windsor Castle: instances, however, of home-scenery are few. Some of the minor studies and sketches are very amusing; not that there is anywhere an approach to caricature, but the costumes are curious, and some almost grotesque. Very novel in their character are, 'Head-dresses at Klomperborg, Denmark'; 'The Costume of Amager' (31); 'Troops Marching in, Scavengers Marching out' (49); 'The Carillon Player in Flushing Tower' (29); 'The Kallen in the Cattegat, Sweden,' 'Walcheren on the Bye-road' (16); 'Maria Toots of Scheveningen' (54); 'Roskilde from the Fjord' (57); 'Hirtshall Lighthouse' (46), &c. Thus it may be understood that Mr. Pritchett illustrates the habits and circumstances of the seafaring life of the coasts of the north of Europe; and that he is highly accomplished as an artist in other directions there is abundant evidence here to show.

MARINE ZOOLOGY AT THE CRYSTAL PALACE.

THE preparation of extensive marine-Aquaria as an adjunct to the Crystal Palace has been going forward for several months, and the new department is now nearly completed. It has been constructed by a separate proprietary, under conditions of agreement with the Crystal Palace Company, which may be said to constitute it a joint production; while by its position and purpose it becomes an integral attraction of the great establishment on Sydenham Hill. It bids fair to illustrate permanently and well an attractive branch of science, which to the majority of persons has been hitherto an unknown region. To most ordinary people, marine zoology in books appears to be painfully abstruse, and often repels, rather than attracts. When the aquaria, which have been made ready with so much care at the Crystal Palace, are in real working order, and, being in fit condition, (for which time is indispensable, despite all the clever plans), are teeming with multitudinous life, the most ignorant or careless spectator will feel fascinated by the beauty and curiosity of the wondrous phase of existence laid open to him. Thus to make an attraction while exhibiting, so to speak, a branch of science, and enriching experience, is true policy, and eminently consonant with the original high purpose of the Crystal Palace. If the plan of the directors has all the results they anticipate—to secure which they have taken the most ample care, and established remarkable means—it is probable that the science of Marine Zoology will, by their endeavour, receive the greatest impetus, from opportunity of permanent practical observation, that has yet been given to it in this or any other country. Only in comparatively late years has any successful method been adopted of preserving examples of marine animals alive in captivity. Twenty-five years ago the means were not properly understood, in the sense we understand them now, and an inland marine aquarium was an impossibility. The first successful attempt in London was made, on a very small scale, by Mrs. Thynne, in 1847. Since then much has been done, notably by Mr. P. H. Gosse, to popularise the science, and particularly by Mr. W. A. Lloyd, to give practical bearing to the means of preserving the living creatures. With unwearied assiduity Mr. Lloyd has observed and experimented, applying the closest deductions of science to his task, and he has succeeded, in a greater degree perhaps than any other naturalist, in the preservation of living marine-animals under transferred natural conditions. This gentleman is the manager of the new aquaria, which have been planned in all their details under his direction. There have been several very noteworthy attempts on the Continent to exhibit the world of marine-life on a large scale, but none of them have been so really important as it is hoped the aquaria at Sydenham will prove to be. With one exception they were not of a permanent character, but—as in Paris during the last exposition, and at Havre during the marine exposition—though the displays were most attractive and wonderful, they were essentially of a temporary character; more ornamental than scientifically useful. The most successful has been that at Hamburg, which was managed by Mr. Lloyd.

The present proposition of the directors is "the permanent maintenance of a collection of British marine-animals, ranging from sponges to fishes of all the kinds of every class that can be kept in captivity." The means taken to this end are as follow:—A series of sixty glass and other aquaria have been constructed in a special building, purposely adapted for their attractive display and the permanent well-being of their inhabitants. This building is outside the north end of the palace, between the present wall and the North Tower. It occupies some of the space left bare by the fire, and stands at the terrace level, on the site formerly occupied by the suite of royal apartments. The roof of this long structure is on a level with the floor of the Palace, and has been made so as to form a terrace platform, along which the tower can be

approached. A flight of steps leads by descent to a saloon 320 feet long and 35 feet wide, paved with red and black tiles. The wall next the garden is nearly blank, and has only small windows high up, through which a tempered light is admitted. Along the opposite wall are large panes of thick plate-glass through which are seen the rock-work, sand, and shingle under sea water—the imitated bottom of the ocean. Light from above streams down, in some tanks more than in others, according to the depth of the habitat to be reproduced. There are eighteen tanks along this wall, some of vast dimensions designed for the great vertebrate fishes, such as cod, turbot, skate. In a second gallery at the back of these, but not seen by the public, are twenty-two reserve tanks made of slate, in which will be quietly stored and maintained a stock of the living creatures, which may be necessary to keep up the exhibition in the show-tanks. On the opposite side of the long saloon, next the garden, are two chambers lighted from above more brilliantly than the other parts of the building. Around these are disposed glass tanks, over which the inquirer can bend so as to look down upon the inhabitants, as well as through the front. In these last named will be disposed all the animals whose beauties and habits are to be better displayed under these conditions. All the tanks, sixty in number, are in communication, and sea-water is circulated from a vast reservoir through them all constantly day and night. This reservoir—a veritable little sea—is constructed of slate under the floor of the saloon. It contains 700 tons of sea-water, 150,000 gallons, which has been transported in barrels. The water is raised therefrom by engine power, and poured uninterruptedly through all the tanks, at the rate of between 5,000 to 10,000 gallons hourly. The water flows from tank to tank naturally, for each is constructed on a differing level to admit of this. All the piping is of vulcanite, to avoid the chemical action that would take place with metal. From the lowest tank the water returns to the reservoir, and then is used again. The tanks when full hold 21,000 gallons of water.

It is not designed to arrange the specimens on any rigid scientific system, because such is practically not possible. They are to be exhibited more according to obvious convenience, and the proper display of their beauty and habits. But so far as possible, the examples will be shown to illustrate all the living creatures from the lowest forms to the highest vertebrata, in gradation. Thus commencing with sea-anemones, madrepores, and similar organisms, we shall be led to the highest class of the radiated animals, the *Echinodermata*, or spiny skinned, among which the sea-urchins, sea-eggs, star fishes, and others of a like character, will be shown. From these we shall pass to the *Mollusca*, animals inhabiting, or forming shells, a higher grade, including the *Cephalopoda*, the creatures having feet or tentacula projecting from the head. The British species of these most generally known are the cuttle-fish and the curious octopus. The exquisite nautilus is the highest type, and some day, perhaps, Mr. Lloyd may succeed even in showing us one of these, about whose living habits and organism there was for ages only mystery and fable. Next will come the *Crustacea*, or animals having the skeleton external; and both the short-tailed division, exemplified by the crabs, and the long-tailed, typified by the lobsters, will be numerously exhibited. This is the highest of the invertebrate classes, which will thus be illustrated as distinctively as possible from their lowest forms to their highest development. The vertebrate fishes will be, so far as the arrangement can be carried out, kept apart, excepting when they are supplied with inferior animals for food. They will, where practicable, be shown in groups; for instance, the group of cod, which includes haddocks, whiting, hake, coal fish, &c., will form a conspicuous collection; and others will, as far as convenient, be similarly arranged. The experience of the last twenty years is to be brought to bear on the undertaking in every point; and it is promised that the aquaria at the Crystal Palace will show us more of this class of wonders of the deep than we have ever seen before.

HOLKER HALL.

IN our last number a short paragraph alluded to the fire which recently occurred in this mansion, destroying a number of valuable pictures, &c. The list we then gave was imperfect; for, in fact, the whole damage had not been at the time accurately ascertained. A subsequent report in the *Times* shows the following losses:—

"Of the pictures, exclusive of rare prints, &c., 72 have been destroyed. These were distributed in various parts of the wing which was burnt in the following manner:—In the library, portraits of Sir Thomas More, Sir Isaac Newton, Hobbes, the philosopher, the first Duke of Devonshire, by Sir Godfrey Kneller, and a portrait supposed to be that of the Duchess of Manchester. In the drawing-room, besides some minor pictures, a 'Windmill' by Jacob Ruysdael, a small landscape by Claude, 'Calm at Sea' by Horace Vernet, two sea views by Vandervelde, a very beautiful 'Venice' by Canaletto, 'St. Christopher and the Saviour' by Albert Durer, two pictures by Wouvermanns, three by Zucarelli, and two by Hobbema, as well as a fine portrait of John Bunyan. In the ante-room—'A Gentleman' by Tintoretto, acknowledged to be one of the finest of this master's works; 'Raising the Stones of the Sepulchre' (artist unknown), a portrait of Lady Dorothy, daughter of the Earl of Southampton, with two or three others of less importance. In the front hall, in addition to the magnificent old fireplace of the date of 1614, there were destroyed portraits of Admiral Penn, Mary, Queen of William III., Lady Rachel Russell, Sir William Lowther, the Lord-Keeper Coventry, and one of the Earls of Douglas. In the corridor—'Truth and Daylight,' a fine picture, with portrait of the first Lord George Cavendish, and portraits of Sir James Lowther, William III., Louis XIV., the Duke of Marlborough, James II., Mrs. Knott, Mr. Preston, Mr. Baxter, and the well-known portrait of Nell Gwynne, by Sir P. Lely, with a few more family pictures, principally of the portrait class, burnt. On the grand staircase the following were destroyed:—'St. James's Palace and the Greenpark in the Olden Time,' 'Barrow-in-Furness in 1846 and in 1870,' 'Furness Abbey in the Olden Time,' 'The Artists at Study,' 'Caught in the Act,' 'John the Baptist,' 'Bridge in Naples,' 'The Mistletoe,' 'View in Florence,' a very large picture; portraits of Cardinal Pole, Mary, Queen of England, Elizabeth, Duchess of Devonshire, the Princess Sophia (supposed), Charles I. (a very fine likeness of life-size), the first Duchess of Devonshire (daughter of James, Duke of Ormonde), Henrietta Maria, Queen of Charles I.; Lady Rachel Russell, William second Duke of Devonshire; his son, Lord Charles Cavendish; his daughter, afterwards Lady Betty Lowther; and the two daughters of Lady Rachel Russell, who afterwards became respectively Duchess of Devonshire and Duchess of Rutland; a few small landscapes, 'The Ascension,' magnificently executed in mosaic work, and a fine picture by Gainsborough containing portraits of the duke's father and uncle as children. Besides the pictures, a large quantity of beautiful tapestry brought from Lismore Castle, the duke's seat in Ireland, and some remarkably fine oak carvings removed from the Old Priory Church, Cartmel, at the time of its renovation, have been destroyed, as well as a valuable collection of rare antique china, &c., which was scattered about the staircase and corridor. Among the curiosities burnt was a very remarkable old oaken bedstead, whose curious carving of the finest workmanship had been generally admired."

Unfortunately we are unable to supply the omissions of our daily contemporary by giving the names of the artists who painted the majority of the pictures enumerated.

Holker Hall appears to have escaped the notice of Dr. Waagen, for he makes no mention of it in his "Art-Treasures of Great Britain;" yet he speaks of many private collections scarcely, if at all, more important than this. The loss to the Duke of Devonshire and to Art generally is very great, as must be evident by the conspicuous names attached to several paintings; while it is more than probable that many of the portraits are by artists of high note.

GEORGE MORLAND IN PRISON.

THERE were discovered on the walls of Whitecross Street Prison, about four years ago it is said, at least two paintings, which, according to all circumstantial evidence, can be attributed only to George Morland, who was sometime a prisoner there. The discovery was effected accidentally by a prisoner who was confined during eight years for persistent contempt of the Court of Chancery. The surface-crust by which they had been covered was a lime-wash of perhaps two or more coats, the last covering having been of some black pigment. Some of this compound must have been chipped off so as to show colour beneath, and suggest the removal of the lime-wash. This was undertaken by the gentleman above alluded to, who seems perfectly to have understood the delicacy of the enterprise, which he carried out most carefully with a penknife. After the removal of the lime-wash the paintings must have remained for some time exposed, for they have been wantonly injured. It would seem that they were never intended as finished works, for in Morland's time the wall must have been replastered and left to dry in the rough, in which state the artist worked on it: thus nice finish would have been labour lost. They have been painted in oil, but have not the flat appearance of having been worked on an absorbent ground. The surface seems to have been prepared so as to bear out the superimposed colour. In the larger of the two are two boys, one of whom is swimming in a pool, and the other, who is behind a tree, appears as if in the act of throwing a stone at the swimmer. It is a close scene, being shut in by trees telling against a warm evening sky. In the other painting are also two figures, a woman in a red cloak holding by the hand a little girl in a brown dress. The aspect of the former painting may be said to be that of summer, while this is clearly a winter subject. As a part of the composition there were skaters, but this part of the picture has been unfortunately destroyed: yet a dog which accompanied the two figures has been preserved, and shows the spirit with which it was touched in. These are the relics of the paintings as we have seen them; but while on the wall, and before the removal of the portions described, the compositions were more comprehensive, and contained more figures. In the winter scene one of the two skaters had fallen, the other was advancing towards him; a cottage appeared in the background. It will be understood that from utter neglect these paintings have been much injured, and it is matter of surprise that any portions of them survive. Thus as we show, and it is much to be regretted, they are very imperfect. In the woodland bathing-scene were other figures, an old man and a girl seated, also a boy sitting at the edge of the pool throwing a stone into the water to a dog swimming towards him; there was also a horse in this painting, and on the right a view of an open country. Some pencil sketches and a drawing in crayons were also on the wall.

Of these works no historical record exists of which we know. Both subjects, however, have been engraved. The name of the engraver is E. Scott, and they were published in 1802 by Brown, 4, Crown Street, Soho. It is not probable that the plate can have been worked off from these wall-paintings, but very likely that the paintings were sketches preparatory to more finished studies which could be conveniently worked from by an engraver. The titles borne by the prints are 'The Skaters' and 'The Bathers,' and they repeat very minutely the compositions with all their circumstances. It would be interesting to know whether the pictures on the canvas still exist, and in whose possession they are. The rescue of these wall-paintings is due to the discrimination and exertions of Mr. Ellis, 19, Bolton Road, St. John's Wood, under whose superintendence they have been cut out of the wall, the plaster and brick-work being braced round by an iron girder.

In connection with these works it would be desirable to learn when Morland was a prisoner in Whitecross Street.

ENGINEERING.

FROM THE GROUP BY J. LAWLOR.

IN the commission given to sculptors for the execution of the various groups intended to ornament the Albert Memorial, Hyde Park, the subject of Engineering was confided to Mr. Lawlor: the annexed engraving shows how appropriately and elegantly he has treated it: his aim evidently was to render it simple and intelligible, and to combine harmoniously the ideal and the realistic. The central figure typifies the science itself; she is the directing spirit of those who surround her. The foremost of these, holding a mathematical instrument, and with his face upturned towards the female, exemplifies the designer, unfolding his plan for her approval: in him the creative power is exhibited. The two other figures represent the labour grade; that on the right holds a cog-wheel, typical of the mechanical craftsman: the stalwart "navvy," on the left, with his furry cap, loose neck-tie, and trousers "gartered" and tucked up, is the labourer, who, shovel in hand, looks on, waiting the order to commence operations. In further illustration of the subject some of the greatest of modern triumphs in constructive appliances are introduced as accessories: thus the steam-hammer appears on the left of the principal figure, balanced on the right by the cylinder.

This is one of the smaller groups for the Memorial, but it is, to us, undoubtedly one of the most interesting of them all. We have applied the term "elegant" to it; and the character of the composition certainly justifies it. Each figure is graceful according to its "order," and remarkably easy and truthful in its *pose*, while the whole are combined into well-balanced form. We have never seen from Mr. Lawlor's hand a more pleasing work than this.

ART IN CONTINENTAL STATES.

CANADA.—An interesting ceremony took place recently at the Council House, Tuscarora, on the occasion of the presentation of Lithographic Portraits of the Queen, the late Prince Consort, and Prince Arthur, by whom they were presented, to the chiefs of the tribe. The unveiling of the pictures was the signal for three startling Indian whoops.—Mr. Augustus Lever, well-known in Canada as the designer of the Ottawa Parliamentary buildings, has received the premium of five thousand dollars for the best plan of a new City Hall in San Francisco.—The Society of Canadian Artists (founded 1867, incorporated 1870) held its third annual exhibition in March. Many of the works shown are meritorious, and augur well for the future of Art in Canada.—The distribution of prizes to the successful students in the School of Art and Design in Montreal, took place in March. From the report we learn that the *role* numbered 188 pupils, of whom 120 were regular attendants. They were divided into the Free-hand, the mechanical, and the architectural drawing-classes. There was also a class the pupils of which modelled in clay from casts from the antique, and later productions, furnished by the South Kensington School of Design. The progress made during the year by the pupils of the several classes was deemed highly satisfactory.—M. Couadeau, a Frenchman resident here, has had on exhibition a plan of Paris in zinc, of over 250 superficial feet, containing every point of interest in the city. The houses, &c., are perfectly distinguishable, and the squares, public places, and other points of interest may be readily recognised. The proprietor has, we learn, been engaged upon the plan for upwards of two years.



ENGINEERING.

(THE ALBERT MEMORIAL HYDE PARK.)

ENGRAVED BY G. STODART FROM THE GROUP IN MARBLE BY J. LAWTON



EXHIBITION OF THE WORKS
OF CONTINENTAL PAINTERSAT THE
GALLERY, 121, PALL MALL.

ALTHOUGH contributions from some of the most eminent of the French painters are not to be found this season in the gallery of Mr. Wallis, there are yet works bearing names sufficiently celebrated to form of themselves an exhibition. This, however, is not without its advantage, as but for such default we might not have seen the productions of certain men less known to fame, yet whose works undoubtedly range in this case up to the standard of those by the masters of the profession. Thus, attention is directed first to a very extraordinary picture by Vibert, which has for its subject 'Gulliver securely fastened to the ground and surrounded by the Army' (58). So great have been accounted the difficulties of painting from Dean Swift's grand satire, that it has been very rarely attempted, and never with any measure of success approaching the triumph of this conception. With the view of showing Gulliver as much as possible a man-mount in comparison with the Lilliputians, whose stature equals about the half of Gulliver's foot, he is foreshortened and presented as a mighty mass bound down by tackles and blocks, the ropes of which are of a tenuity a trifle stronger than the threads of a spider's web. The king and the court are walking about and complacently chatting in speculation on their prisoner and his singular equipment and belongings. One party has succeeded in opening his watch, which has been drawn from his pocket by the aid of a crane, and the same mechanical power is employed in removing a pistol from his belt. Every part of the work abounds in evidences of profound thought and appropriate demonstration. Gulliver has never been so illustrated before: it is a picture which once seen can never be forgotten. Of M. Gallait's picture, 'The Vision of St. Hubert' (24), which has been lent by the Queen, it may be asked why the artist, who, in the choice of subject-matter, never moves in beaten path, has selected a theme that may be said to be threadbare, were it not to set forth what he believed to be a more pointed conception of the story than any that had gone before, and to show he was equal to work it out? It is, indeed, a production of much excellence, and more literal in its details than any version we remember. In 'Indecision' (44), J. E. Saintin, the artist has proposed to himself the solution of a difficulty, the occurrence of which has been very rarely met with. The life of the picture is a young lady reflectively putting on her gloves, and hesitating about going out. Behind her is a chest of drawers painted blue, which, but for the skilful treatment of the subject, would step out of the composition, for naturally it is cold and opaque. M. Saintin adduces this as a *tour-de-force*, and he wins. Nos. 28 and 29 are two small pictures by Yvon; the former is entitled 'La dernière Cartouche,' and carries us back to the Russian Campaign of 1812. The figurant is a soldier of the Imperial Guard, ragged, worn, and haggard with the weariness of that awful retreat. He is ramming down his last cartridge; the scene is a wide snow-covered plain, dotted here and there with parties of Cossacks, and the distinct inference is that he will soon be stretched lifeless on the snow. The latter is 'Le Drapeau, 1870,' and is an episode of the late war. Both works are small, but very masterly.

'Poesie' (94), J. Coomans, is a neat example of the taste lately prevailing in the French school, and referring to classic times and authorities more or less successfully. Another similar subject is 'The Last Day of Pompeii,' A. Savini (118). It may be supposed that works of this class reflect in some degree the influence of David and his school—they supplement them with the *genre* of classic Art. Of Gérôme there is but one example; indeed, from the care with which this artist paints, his productions cannot be numerous. This is 'An Eastern Girl' (35), who stands smiling at her own pleasing thoughts and absorbed apparently in an agreeable day-dream. It is generally low in tone, but distin-

guished by all the perfect finish with which this artist works out his subjects. A study from the Greek is called 'In the Temple' (38), by L. Alma Tadema, of which the great merit is the laborious care bestowed on the properties and fittings of the edifice. The artist, it may be, intends the interior as a portion of the temple of Venus at Cyprus, as priestesses only are present, one of whom, holding a pair of cymbals, stands over a tripod with burning incense. 'The Cobbler's Home' (55), J. Maris, is an admirable instance of a breadth of shade, broken only by the least possible number of points of light to rescue the whole from being a mass of dark; and so precious are these relieving points that it is impossible to describe their value. The little picture is a triumph of the subtleties of Art; and had the subject been pitched in a key more aspiring, the work would have been proportionately of greater worth. 'Consoling the Widow' (64), B. Vautier, is another successful low-toned picture, with its point at once legible.

By J. Grunewald are two small figures of historical interest in their reference to the late war. In 'Before the Storm—Anticipating the Profits' (68), we find an Alsatian farmer in one of his corn-fields calculating his gains by the sale of his produce; in 'After the Storm—Realising the Losses' (69), we meet the same man surveying with anguish his down-trodden crops, and estimating, of course, the amount of the loss; these two little pictures should not be separated. W. Bouguereau, in his picture, 'The Mother's Joy' (70), seems to have taken a hint from some antique *bas-relief*, for the situation in the picture, the mother kneeling and holding over her child a bunch of grapes, is not of rare occurrence among the relics that date from the Olympiads. M. Bouguereau is a very agreeable painter, and has invested the incident with a grace novel to what, from the title, might be held to be very ordinary material. A 'Promenade-en-mer' (78) is a very brilliant little picture, by J. Israels, of a girl, with her little sister on her back, sailing a mimic craft on one of the pools left by the retiring tide; it is very harmonious in colour. 'A Present' (80), A. Stevens, tells of the grotesque embarrassment of a girl who has received a gift in the shape of a hideous wide-mouthed leopard in *faïence*, which she examines with much perplexity, but does not touch. 'Soliciting Alms' (83), L. Perrault, presents to us a little beggar-girl, extremely earnest in pressing her suit; and 'Beggars waiting for Alms' (103), E. Melida, is of a similar complexion as to subject, but very different in its dispositions; showing a small company of beggars waiting at a convent or church-door the arrival of their patrons. This picture with admirable tact, but very positively, reverses a generally acknowledged law of composition. The painter seems to be a Spaniard, and the few examples of his school we notice here, exhibit the highest qualities of the class to which they belong. However distinctly they may point to French teaching, they are not of the French school, but refer rather to the Dutch. In 'Coming out of Church' (143), R. Madrazo—a Spaniard also, we believe—there is a large field to fill up, but it is neither thronged with figures nor crowded with impertinent accessories. There is a gathering of beggars; and two showily-dressed country-girls are jauntily issuing from the portal, at the sides of which are statues of St. Peter and St. Paul, and further, on the right-hand wall, a picture of the Virgin, by Murillo. By the same artist is also a brilliant little picture called 'Learning the New Piece' (149); and by Imenez, also, we presume, a Spaniard, a picture of much merit, called 'Interior of a Church on the Day of the Grand Pardon.'

'The Village School' (103), Henriette Brown, differs but little from the usual forms of such subjects, but it stands at once confessed as by an accomplished hand. 'Jeune Fille—Fellah d'Egypte' (105), E. Vermet-Lecompte, is a small life-sized figure, studied apparently very conscientiously from a native. 'The Picture Gallery' (106), L. Bakalowicz, represents two girls looking at paintings; it is a successful example of the "conversation" class of works. Another, similar in kind, is called 'Self Complac-

ency' (107), P. Korle; but it has been very carefully studied as to the lighting and relief of the figure—a young man adjusting his dress before a glass. 'The Historiographer' (114), V. Lagye, impresses the visitor at once as a very elaborate instance of modern German Art. It presents a lady in the costume of the sixteenth century, and very *Düreresque*, sitting at a writing-desk studying an ancient manuscript. The properties and the proposed time are well in accordance, and the stringency of the arrangements must have cost the painter much anxious inquiry. It is a striking peculiarity of a work referring to such a period, that the 'Historiographer' should be a woman. 'Italian Shepherds' (125), C. Pittara, sets forth pastoral life in a light different from what we have seen it in *agroupments* from the Campagna and Abruzzi, and further still from all that reminds us of Tityrus or Menalcas. Of these shepherds there are five all mounted and armed, and having rather the air of a small company of *vedettes* than men given to the quiet tenor of rustic life. As a pastoral the picture is a novelty. 'Faust and Marguerite,' A. Gisbert (129), is the well-known and oft-painted scene in Martha's garden, where when with her lover, Gretchen consults her floral oracle—

"Er liebt mich
Er liebt mich nicht."

The subject must be very tempting, as scarcely a year passes without producing one or more versions of it. 'A Dutch Fishwife' (128), by J. Israels, strikes us as a curiosity, departing, as it does, from his usually fastidious finish. M. Israels has been looking, and not without profit, at Rembrandt. It may be said that much M. Ten Kate has in 'Soldiers in Quarters at a Farm-House' (136), has been greatly influenced by Jan Steen, for the entire company to which he introduces us here is overcome by strong drink: in depth the picture is equal to many of the best Dutch interiors. 'A Corner of my Studio' (142), A. Vollon, is large and very elaborate, rich in every kind of artistic requisite in the way of models. 'The Costumier' (157), J. Worms, is an outfitting shop, either for the studio or the *bal masqué*—as many varieties of costumes may be obtained there: a young man is being equipped in the holiday bravery of a Spanish peasant. There is a smart *demoiselle* in waiting, his companion to the ball.

'Infant Hopes' (155), A. Jourdan, a mother with her infant on her lap, is a charming picture—earnest yet tender, and most successful in the relation established between the mother and child. 'An Eastern Girl' (151), A. Landelle, is a small life-sized figure, showing much taste in the dispositions and beauty in sentiment. It is very difficult in single figures to avoid some approach to portraiture; here, however, the arrangement and prevalent feeling are entirely pictorial. 'A Rustic Interior' (160), Leon Caille, though varying little from the usual run of such themes, is very masterly. In 'Pages Playing Chess' (12), A. Gués, we have an instance very complete of a class of picture most difficult to render interesting. It is effectually a costume-piece, and balancing between the Dutch and the school of Meissonier. It shows a company of idle pages, one or two lying stretched at full length studying the chess-board: this is a liberty seldom taken with tact enough to be forgiven: here, however, it is perfectly acceptable, and pictures the very essence of *idlesse*. It is highly finished. Another illustration of overtaxed humanity appears in 'A Chorister Boy' (16), Henriette Brown—a *petit clerc*, who is charged with the cleaning of the plate of his church, and lounges over his task in such a manner as effectually to show how not to do it—the thought is original, it points a moral, and might adorn many a tale; but it would have been even more interesting as a smaller picture. 'Expectation' (15), E. Richter, is treated for a striking effect, to which we think much is sacrificed. Among the mass of remaining works are many we must be content simply to name; including them are several small pictures, some of great power, others of exquisite sweetness, notably—'Maternal Trouble' (25), J. Grunewald; 'The Twins' (26), E. Verboeckhoven; 'Victorious' (36), J.

Geertz; 'Dressed for the Ball' (40), L. Bakalowicz; 'On the Look Out' (47), V. Chavet; 'Going on Duty' (49), Leon Escosura; 'Discussion on the Infallibility' (53); J. Simo-netti; 'Going to Mass' (62), Jules Breton; 'A Roman Peasant' (86), G. Saintpierre; 'After the Rats' (89), Y. Bochmann; 'An Interior' (123), J. Aufray; and others which would demand more at our hands than the simple title, had we space for comment.

French landscape has maintained and improved its best characteristics, but among artists of this department there is an extraordinary coincidence in the repetition of flat perspective. This, however, compels minute definition of gradation, and reference to the sky for support; and here they follow strictly the Dutch and Flemish painters, who, as a rule, rarely saw anything but flat scenery. Among the works here exhibited, however, we are able to point out some really fascinating instances of the treatment of level landscape, as 'Night' (135), A. Lier; 'Scene in Holland' (141), A. Roelofs; and by the same, 'After a Storm in Holland' (150); 'Harvesting in Bavaria' (152), A. Lier; 'A Surprise in the Forest' (156), L. Wopfner; 'After Sunset' (158), F. Hermes; 'Forest Scene in Belgium' (165), F. Lamorinière; 'Une Plage de Villerville-sur-mer' (7), C. F. Daubigny, remarkable for many reasons; 'On the Coast at Scheveningen' (13), F. H. Kaemmerer; and, by the same, a very pointed fable, or satire, as you will,—a hare in his native snowy plains, recently a battle-field, questioning, as he rears himself on his hind legs, the presence of two great guns; his challenge is 'Friends or Foes?' (19). Prominent also are 'St. Georges-Majeur, Venice' (17), A. Rosier; 'Santa Lucia, Naples' (18), Jules Ruinat; 'A Stormy Day,' (66), W. Lommens; 'A Mountain Pass,' B. C. Koekkoek, a diversion towards Berghem, &c.

The exhibition presents a greater variety of excellence than we have before seen on the same walls.

We have now had many years' experience of the influence that foreign Art has exercised on the Art of England, and we are justified in seeking to ascertain its extent and value. We confess not to see that it has done for our school as much as it might, and we think ought to, have done. The great masters of France, Germany, Belgium, and lately of Italy, to say nothing of those of the north of Europe, have undoubtedly qualities which we have not: we believe we have some *they* may study with advantage: but it is beyond question that the artists of the Continent can teach us much we want to know.

Have we sufficiently availed ourselves of the opportunities supplied to us by Mr. Wallis and others? We should like to know how many British painters visit his gallery during "the season:" how long they remain there: and whether they are, or are not, practical students there. No doubt Mr. Wallis would afford to any English student all possible opportunity for not only seeing, but sketching parts of the pictures he exhibits. And we are very sure the greater and better of the continental masters would be gratified to know they had given "hints" to those of England. In short, means of incalculable benefit are presented to us—do we avail ourselves of them?

MR. McLEAN'S GALLERY.

MR. McLEAN'S rooms at No. 7, in the Haymarket, contain a most interesting exhibition of pictures by foreign and English artists, many of which are equal to the best productions of the artists whose names they bear. They seem to have been selected with a view to the representation of every department of Art. Included in the assemblage is (rarely to be seen elsewhere) an admirable example of what is classed as "historical" Art, in 'Judith,' by A. Elmore, R.A., which stands out in strong contrast with everything he has done hitherto. She is stealthily entering the tent

grasping the knife or fauchion in her left hand, while with the right she raises the drapery. The story is all here, the features express fiendish resolution, and a settled purpose of which the execution is imminent. The figure is altogether so admirably cast that no doubt exists for an instant as to the intentions of the painter. By 'The Odalisque' of L. Perrault, (99), we are in some degree reminded of the Odalisque of Ingres. Besides that both figures present the back, there are other points of resemblance. Here the lower limbs are covered, and she is looking into a glass which reflects the face, and so giving more interest to the picture than if it showed simply the back. It refers directly to the arena of the Academy, and in this direction alone is highly successful.

By Alma Tadema are several works, of which one or two are not the less agreeable for being a little less severely classical than usual: one of these is 'The Nurse—Hush!' (3), a girl tending a child, which sleeps in a basket—the scene being the corridor of a villa: in a strain infinitely higher is 'The Sculptor's Studio,' wherein appears a group of connoisseurs of the *gens togata*, who are criticising a bronze of that well-known statue, which has the drapery drawn into sharp folds round the person. There is a copy of the Laocoon in the studio, but as the artist has not taken us to Rome, we say nothing of this. The picture well sets forth all it may be said to profess, and is a result of laborious research. In 'Backgammon' (7), F. Roybet, two youths are engaged at play. As usual, the one shows that he is victorious, while the other looks vexed and embarrassed; but what impresses the observer more than this is the mechanism of the picture; wherein it resembles a Venetian painting at that period of the school when its issues were more marked than they were in its maturity and decline. By J. Coomans, are a pair of 'Pompeian Ladies' (32), one fair and the other dark; the head and bust of the latter being very carefully worked out. And again, a reminiscence of the desolate city in 'Relics from Pompeii' (33), F. Topham, Jun., wherein a vendor of antique wares offers his curiosities to two girls, who seem doubtful of their genuineness. By L. Perrault is a well-painted group called 'Refugees—1871' (35). In 'The Favourite,' C. Peerus, a savoury dash of the Dutch school is apparent. 'My Lady's Servant' (44), Castres, is a highly successful conception of full-blown flunkeyism and pomposity. By F. P. Poole, R.A., is a study which brings back to us reminiscences of Mr. Poole's early works—it is called 'Going to the Spring' (55). Other interesting productions are 'The Venetian Pedlar' (41), R. Hillingford; 'School Time' (47), A. Gautier; 'The Morning Toilette' (59), A. Toulmonche; 'Resting from Work' (60), Artz; 'Preparing for Market' (65), Joris; 'Nymphs Dancing' (67), W. E. Frost, R.A.; 'The Sleigh' (72), R. Hillingford; 'The May Queen' (74), C. Baxter; 'An Eastern Head' (78), W. Gale; 'Mand Muller,' T. Faed, R.A.; 'Blonde' (84), C. L. Lidderdale; 'The Walk on the Mall' (88), J. C. Horsley, R.A.; 'The Bather' (92), F. Wyburd, &c.

The gathering is comparatively rich in landscape, cattle, and marine subjects, exhibiting every degree of execution from the most fastidiously careful even to a license outside the limits of freedom. By Vicat Cole, A.R.A., and called 'Autumn in Surrey' (30), is a superb landscape, exhibiting passages of scenery found nowhere but in England. By the late Thomas Creswick, R.A., are three landscapes—*one especially early, and of great beauty.* By the American artist Bierstadt, is 'Mount Hood, California,' a large picture very successful as showing the grander features of the mountainous portions of the country. 'On the Seine' (1), L. Caillou, 'A Landscape' (9), Jules Dupré, and others by the same hand are deserving of special note; and other landscapes, &c., by R. Beavis, N. Diaz, E. Van Morcke, C. Smith, M. Collart, Ziem, J. P. Clays, J. Webb, T. Maris, T. S. Cooper, R.A., Verboeckhoven, C. Cottin, B. W. Leader, Corot, Muschamps, E. Lambert, &c., show much taste, being worthy examples of the different departments of Art which they represent.

MINOR TOPICS OF THE MONTH.

THE INTERNATIONAL EXHIBITION, 1871.—The day on which this number of the *Art-Journal* is in the hands of its readers is that on which the Exhibition will be publicly opened, his Royal Highness the Prince of Wales presiding, accompanied by other members of the royal family. As, therefore, all the arrangements for the Exhibition will be then known, it is needless for us to describe them; its advantages and disadvantages will be exposed to the scrutiny and for the estimate of all—all, that is to say, who have paid the large sum of three guineas for a season-ticket. That the evil will prevail over the good, we much fear. Up to a late hour of April, France had contributed little or nothing; other states of the Continent are insufficiently represented; and as we foresaw, but for the aid of Italy, the term "international" might be almost omitted from the programme of 1871. That much of this misfortune is attributable to the unhappy state of a great part of Europe is certain; but some blame must be incurred by "the authorities," by whom the Exhibition has been "managed:" they did not make such efforts as were demanded by the difficulties they knew to be in their way; they seemed to have been content to send out their advertisements and let the affair take its "natural" course. Anything like "coaxing" contributors, at home or abroad, seemed unbecoming and undignified. We believe a little more exertion to meet obstacles half-way would have materially added to the wealth of the collection. Still, notwithstanding, the Exhibition will be regarded as another of the beneficial attractions of the century, and cannot fail to teach valuable lessons to the manufacturers and artisans of Great Britain. If not so good as it might have been, it will be good and, of a surety, instructive. Our remarks apply to Art-manufactures rather than to Art proper. The galleries are hung with a large and grand assemblage of first-class pictures, and of first-class sculpture there is abundance. We commence this month the first part of an Illustrated Catalogue; that as well as the Exhibition will be seen and estimated on the 1st of May.

THE SOCIETY OF WATER-COLOUR PAINTERS has elected to be Associate-members Messrs. A. Goodwin, W. M. Hale, A. B. Houghton, S. W. Marks, A.R.A., R. W. Macbeth, and J. W. North. The Society has long been comparatively weak in figure-painters: five out of the six new members will give it considerable increase of strength. What Mr. Hale's "speciality" may be is unknown to us, for we have no recollection of ever seeing his name as an artist.

THE ROYAL ACADEMY.—A cast of the famous athlete, sometimes called "The Strygil," discovered in Rome several years ago, and esteemed one of the finest examples of antique sculpture in the Vatican, but of which no full-sized copy has hitherto reached this country, has just arrived in London from Italy, and is now in the Antique School of the Royal Academy. The figure is quite perfect, and represents an athlete standing at rest after a contest, the weight of the body thrown on the left leg. Its action is that of removing the perspiration from the right arm, extended in front of the body, by a curved instrument—the *strygil* (hence the name of the figure) held in the left hand. The "style" of the figure is of the highest character of antique Art. At the time of its discovery,

during the progress of some excavations, apprehensions were entertained as to its entirety: a cast was therefore taken *in situ*—and successfully. In justice to Mr. Weekes, Professor of Sculpture at the Academy, we feel bound to state it is through his efforts the cast has been obtained for this country. On a recent visit to Italy he was so impressed by its beauty and power as at once to negotiate for a copy being sent to London.

IN THE ROYAL ALBERT HALL PROGRAMME there occurs a singular mistake. Writing of the site of the Hall, the author describes Gore House, the residence of Lady Blessington; and states that, "just to the east of it resided Count D'Orsay, who married one of her step-daughters, Miss Power." Count D'Orsay married the Lady Harriet Gardiner, daughter of the first wife of Lord Blessington. The house in which Count D'Orsay resided is still standing.

DRAPERS' HALL.—Mr. E. W. Wyon, who executed much of the sculptured work in this new edifice, is engaged on two statues for the principal staircase: one is of Edward III., in whose reign the company received its charter of incorporation; the other is of his brave Queen, Philippa, with whom the manufacture of English cloth is assumed to be identified.

THE SOCIETY OF FEMALE ARTISTS has closed. The year has been successful with reference to admissions and also to "sales." At least, the indefatigable and estimable secretary, Miss Atkinson, states that she is "content."

THE TWO SOCIETIES OF PAINTERS IN WATER-COLOURS are now open in Pall Mall and in Pall Mall East; their session commenced at too late a period of the past month to enable us to review their exhibitions in this number of the *Art-Journal*.

MR. GEORGE LANDSEER is, we hear, engaged in painting the superb scenery of Cashmere, and that of the high valleys of the Himalayas to the North of the Punjab. He is also making a collection of objects of natural history that will, doubtless, prove of great value. The first instalment of what he has already accumulated has just been received in this country, forwarded by Mr. Landseer from Strinagar, early in the month of last September. We understand that any one interested in such matters may inspect them on application where they are for the present deposited, at 49, Wigmore Street, Cavendish Square, the residence of Mr. E. Ward, F.Z.S.

A TRULY GRAND PICTURE, by the famous master, ALMA TADEMA, has been exhibited by Messrs. Pilgeram and Lefèvre, at their rooms in King Street, St. James's. It is not large, but it is, in the best sense of the term, *great*: great in conception, in composition, and in artist-work, full of interest as well as of originality, deep thought, and profound learning; it cannot fail to be regarded as among the most perfect examples of modern Art; indeed, it may be said, of the Art of any period. The theme is a happy one, it pictures the opening of the feast of Bacchus, the priestess, a lovely human divinity; leading the nymphs for the dance; thus to welcome in the first-fruits of the vine—the vintage in ancient Rome. The work is so full of details that we may not accord to it the space it would require to describe them; the period of the month at which we write prevents us from rendering to it merited justice; but it will be our duty to recur to the subject. There can be no doubt that whatever the attractions of the Art-season may be, this grand production will absorb a large portion of public attention. It is to be

placed in the hands of the eminent engraver, M. Blanchard, whose reputation is very high in England as well as in France. He is certain to produce a plate of surpassing merit; for the style and "manner" of the picture is precisely suited to the burin of the master.

M. BLANCHARD is engraving for Messrs. Pilgeram and Lefèvre the well-remembered and very beautiful picture by Maclise, 'The Eve of S. Agnes,' and also 'The Entombment,' by Francia, in the National Gallery. It is satisfactory to know that "at long last," we are likely to find in England a publishing firm that will supply Art-lovers with really good works of Art.

M. YVON has commenced the SCHOOL FOR LADIES, which we notified it was his intention to do some months back. It will be conducted after the manner of the schools at Paris—as Paris was once. The living model will be draped and posed every day, and thrice a week Mr. Yvon will give his personal attendance for some hours; on other days, a lady instructed by him will preside over the studies. Those who desire further information may apply direct to M. Yvon, 9, Lanark Villas, Clifton Road, W. Few such opportunities have ever been attainable by lady students in England; those who desire sound instruction by an artist of the highest order will do wisely and well to avail themselves of this fortunate "chance." The misfortunes of unhappy France have brought other valuable teachers to our country; none, we believe, from whom so much good can be derived as may be obtained from the lessons of M. Yvon.

MR. JOHN FAED'S picture, of which much has been said, and great expectations formed, will be exhibited at what has been named "the Scotch Gallery," 48, Pall Mall. The picture is 'The Statute Fair;' the title gives some idea of the subject.

EASTER EGGS.—Mr. Cremer, Jun., exhibited at Easter an apparently inexhaustible supply of Easter eggs, to the number of, at least, some thousands. They were of all sorts and sizes, ranging from that of the wren to the weight of some pounds—the produce of some hitherto undiscovered bird. They were filled with objects inconceivable to the uninitiated in such mysteries: some contained services of plate, others a whole tea equipage; some had fancy scent-bottles; others were occupied by dolls sleeping on beds of down. Many of them were decorated externally as well as internally; and each had some special recommendation, either to old or young, as gifts at the pleasant and happy season of Easter. But Mr. Cremer has given an Art-character to all his "toys"—making, as well as importing, them in vast variety.

THE LIBELS ON OTTO GOLDSCHMIDT.—The result of the actions for libel instituted against three newspapers, in which verdicts for large damages were obtained, will have given exceeding satisfaction to every rightly-constituted mind in the kingdom, and, indeed, in America and on the Continent. A more baseless slander was never invented or circulated.

("Be thou as chaste as ice, as pure as snow,
Thou shalt not escape calumny!")

There are few men living whose lives have been more entirely blameless. If singularly retiring habits, a rooted love of lofty pursuits, an instinctive sense of probity, and a reverence for the religion that implies duty to neighbour as well as to God—added to intense devotion to all the home-duties of life, to wife, children, and friends—could have secured any man from "viperous slander," it might have been Mr. Gold-

schmidt. There is no one more entirely respected: there is no English home that yields a happier model than that which he and his estimable lady have made at Wimbledon. A few testimonies were given to that effect at the trials: there might have been hundreds; in fact, none knowing Mr. and Madame Goldschmidt who could not have deposed to the high and honourable character of the gentleman so foully assailed. It is the duty of every publication in the kingdom to give currency to this verdict. We presume it has set the matter at rest for ever. How it originated it is impossible to say, for it never had a shadow of foundation.

THE LONDON STEREOSCOPIC COMPANY has been honoured by sittings from THE EMPEROR OF THE FRENCH; and they have been singularly successful. It is a good yet pleasant likeness of one who will occupy a very full page in history; and who, let his countrymen say what they will, advanced and extended the welfare of France during nearly a quarter of a century, and so established peace between that Empire and this Kingdom, as to bring the people of both into close relationship, if not friendship—removing from both the prejudices that had engendered suspicion and dislike almost amounting to hatred; and manifesting to both that their true interests consisted in amity and honourable rivalry. France will, in time, rue the evil day that sent him once again an exile to our shores. In the photograph under notice, the Emperor looks better, fresher, healthier, more "comfortable" than he did in Paris four years ago—in 1867—when, in the zenith of his power, he distributed "honours" to those who had gained them at the Great Exhibition. He has lost the anxious, "troubled look," the aspect careworn, that seemed to "set" his features, and that he now wears induces the belief he may again be happy. Photography is a terrible truth-teller: it cannot deceive; and we may form safe conclusions from this portrait from the life, which no flatterer has touched upon, and which gives so truly the semblance of the inner as well as the outer man. It will be welcome to tens of thousands in this country. The Stereoscopic Company has produced also a portrait of the Prince Imperial: it represents a youth of no strongly-marked character, but one who is of a graceful and kindly nature. The eyes are like those of the mother, wanting, however,—if it be a want—the firm mouth and ponderous jaw of the Emperor. May his be the paths of peace!

ST. THOMAS'S HOSPITAL.—"The Old Students' Gift" to the hall of this new hospital of a marble bust of Cheselden, the surgeon, by Mr. Weekes, R.A., recently recorded in these columns, is to be supplemented by one of the celebrated physician, Dr. Mead, a colleague of Cheselden in that time-honoured charity during a part of the last century. This work is intended as a *pendant* to the former, and is now in course of execution by the same sculptor. The two will happily illustrate the sciences of Medicine and Surgery respectively, in the persons of these distinguished men, both of whom, it may be interesting to note, sat to Roubilliac.

THE GREEK CANON OF PROPORTION.—Dr. H. C. Fook, of Utrecht, writes to us to say that this subject, concerning which a correspondent made inquiry in our February number, is treated in his "Anatomie Canonique, ou, Le Canon de Poly-clite Retrouvé," published by Keminky et Fils, Utrecht; Renouard, Paris; and Weigel, Leipsic. Dr. Fook is a member of the *Academic des Beaux Arts*, Amsterdam.

REVIEWS.

HAND-BOOK FOR YOUNG PAINTERS. By C. R. LESLIE, R.A. Second Edition. Published by J. MURRAY.

WE are glad to see a new edition of this useful work. The first appeared in 1854, and was noticed by us then at some length. We now content ourselves by briefly drawing attention to the second edition. The greater part of this volume consists of lectures delivered by Mr. Leslie at the Royal Academy. More than twenty capital illustrations of celebrated pictures elucidate the text. Though styled a *Handbook for young Painters*, the work teems with information suited to that "now large and increasing class of lovers of Art who adorn their houses with pictures."

Mr. Ruskin thinks a picture should be like a mirror; Sir Charles Eastlake, that "the literal imitation by the painter of many things which, strictly speaking, are not only visible but prominent, would destroy the spell of a well-remembered scene. For there can be no doubt that our memory of nature is composed of general ideas—of a sense of a whole—and Art must be generalised to meet these ideas." The author of the volume before us thus happily combines the two—"In the practice of drawing or painting from nature there can be no doubt that, until correctness of eye and obedience of hand are attained, the closest possible, the most minute imitation is the best. The aim at deception can do no harm until these powers are matured; for, as Fuseli remarks,—'deception is the parent of imitation;' and, till the taste is well advanced, it is in a high degree dangerous to attempt to generalise. We should be able to put everything we see in nature into a picture before we venture to leave anything out. I have known young painters commence with generalisation, affecting a contempt for the attention to *minutiae* of some of their contemporaries and the secret of which lay in their own indolence. But the result of this was always that a vague and uninformed style, in the end, consigned their productions to oblivion."

Mr. Leslie was a great opponent of sectarianism in Art, or "the bigoted admiration of any one school, or any one master, however deserving of admiration, to the exclusion of all the rest. There cannot be a greater mistake; and I have invariably remarked that he who pins his faith wholly on any one style is exactly he who least perceives that in it which is its peculiar charm. All great masters throw light on each other; I am convinced that no mind will thoroughly relish Raphael and Michael Angelo, which does not thoroughly relish Rubens and Rembrandt. Nay, I will say that the simplicity and the purity of feeling of Giotto, Angelico, and others of the early Italian masters, will be best appreciated by the mind that is most visibly alive to every variety of excellence in the Art. The bigoted sectarian generally admires in the wrong place, clings to what is merely accidental, to that which belongs to the time and country in which the painter has lived; and even fails to perceive that which is essential in the style, that which is Catholic, and which therefore connects all the first-rate minds of all ages with each other. It is this essence which is really the Art, all else is but its dress."

Those who admire the pure religious feeling of the early masters, and seek to make it their own, are apt to copy the defects as well as the beauties of the mediæval schools. In his chapter on the Imitation of Art, Mr. Leslie particularly points this out, and quotes the following from a capital letter on the subject by the eminent Art-critic, Dr. Waagen, which appeared in the *Times*, July 13, 1854. He says such men "have sought to transfer to their pictures not only the beauties but the defects of their great models; unmindful of the fact which a general survey of the history of Art does not fail to teach, that those early masters attract us, not on account of their meagre drawing, hard outlines, erroneous perspective, conventional glories, &c., but, on the contrary, in spite of these defects and peculiarities. We overlook these simply and solely because, in the undeveloped state of the scienti-

fic and technical resources of painting at that period, they could not be avoided. But it is quite another thing when under the false impression that the feeling they emulate can be better reared by ignorance than by knowledge, we see these defects and peculiarities transferred to the works of modern artists, who purposely close their eyes to those scientific and technical lights which have now become the common property of Art and retrograde to a state of darkness for which there is no excuse."

Some people speak as if there was a golden road to Art, and that persons who have what is commonly called genius are above the observance of rules. Young painters are especially liable to this error. Let us see what Mr. Leslie has to say on the subject. "The prosperity of Art can only be promoted by the strictest observance of its laws and the proper use of its rules—the first tested by the principles which are unalterable in nature, the last by their admission of exceptions." He tells the young artist "to beware of all rules that promise an easy acquirement of the Art, and to mistrust our own dexterity when we find it saving us the trouble of thought. In the first discourse of Reynolds are some excellent remarks on the specious facility so often injurious to the young artist, and the assurance from him that 'there is no easy way of becoming a good painter'—from him who had mastered, with such apparent ease, so many of the greatest difficulties—should never be forgotten." There is no book of its kind that offers more judicious advice and instruction than this well-written volume.

THE POT OF BASIL. Engraved by BLANCHARD from the Picture by HOLMAN HUNT. Published by MM. PILGERAM AND LEFEVRE (Successors to Gambart).

This is a print of great merit and value: there is no engraver of England now who could have produced a work so perfect, considered as an example of combined delicacy and force; and certainly England has no publisher who would have undertaken it. It is one of the bequests of Mr. Gambart to his successors. When the picture was exhibited, we passed it under review; the engraving is, perhaps, more agreeable than the painting: the one had a "glarish" effect of colour, which impaired the sentiment: the defect is not perceptible in black and white.

Yet the painter was very happy in telling the sad story which the poet Keats has immortalised, and which the great story-teller of Italy had previously made familiar to the world. The mournful damsel mourns over the pot of basil that contains her treasure; moistening the cold clay with her hot tears. It is a very mournful tale; and the artist has ably aided the poet in touching the hearts of those who either see the picture or read the poem.

As an engraving, it is of great excellence. Of late years, indeed, we have rarely seen a print so thoroughly imbued with all the best principles of Art.

MANUAL OF THE SCIENCE OF COLOUR, ON THE TRUE THEORY OF THE COLOUR-SENSATIONS AND THEIR NATURAL SYSTEM. By WILLIAM BENSON, Architect, Author of "Principles of the Science of Colour." Published by CHAPMAN AND HALL.

There is not much in this little manual which the Art-student will find practically useful to him in managing his pigments: the book is rather a scientific treatise on the theory of colours and on colour-vision. There is a chapter, "Harmony of Colour," which he might study to advantage; as well as some remarks on modifications of colours. Thus, though the painter is not supplied with all he requires, he will meet with something; while the student of the laws of light and colour will, with the aid of certain diagrams illustrating the theories laid down, gain much information on a subject of interest and beauty: this, when acquaintance is made with it, will, as Mr. Benson rightly says, "add extremely to the pleasure derived from contemplating natural objects and scenery, as well as pictures and other works of Art."

THE MAD WAR-PLANET, AND OTHER POEMS. By WILLIAM HOWITT. Published by LONGMAN & CO.

This little volume has no engravings; yet every page contains a picture—a painful one, no doubt—and one that any philanthropist would hide away, but for the awful lesson it teaches, and the more awful acts it may help to diminish or avert. The eloquent author of this grand poem—an appeal from the decrees of man to the laws of God—has written much, and always well. There are few living men who have so largely contributed to bring to us peace and good-will. He has never produced aught so well timed, or so likely to achieve the high and holy purpose to which he has devoted his life.

It is eloquent and very beautiful as a composition, with much of youthful fire added to the wisdom begotten by experience—the years that bring knowledge and matured thought; but its main value consists in this—that it impresses with singular force the horrors of war; and the thousands of evils it engenders, without a single compensating good.

We have had much from William Howitt during a period over-passing fifty years; but this, his latest work, is his best, considered either as a poem or a sermon.

REVUE DÉCORATIVE. Edited by EDOUARD LIEVRE, Author of "La Collection Sauvageot, le Musée Universel, et les Arts Décoratifs." Parts I. and II. Published by ASHER & Co.

These are the commencing numbers of a work which will be found specially useful to all engaged in Art-manufactures of every kind, as well as to ornamentists and decorators. Each number contains six well-engraved plates of some beautiful object of ancient or modern design, taken from the original; for example, enamel cups of the sixteenth century, in the museum of the Louvre; a modern porcelain *plaque, jardinières*, gems, decorations of the sixteenth century, leather-hangings, ornamental watches, ironwork, &c. There is no descriptive letter-press, nor does this seem necessary; the engravings speak for themselves as suggestions for practical use.

THE SCHOOLS FOR THE PEOPLE: Containing the History, Development, and Present Working of each Description of English School for the Industrial and Poorer Classes. By GEORGE C. T. BARTLEY, Examiner, Science and Art Department; Author of "The One Square Mile in the East of London," &c. Published by BELL AND DALDY.

At a time when the subject of popular education is exciting so much general attention, Mr. Bartley's volume—one of nearly six hundred pages—comes very opportunely to afford information of what has hitherto been done to bring the masses of the people within the reach of instruction. It was quite evident that the machinery at work proved totally inadequate to the requirements of the country; hence the necessity of the measures which have recently been called into existence for supplying the deficiencies; and which will have the effect of making great alterations in all elementary educational institutions. Mr. Bartley's experience of eleven years in the position he holds under the Science and Art Department, must have given him ample opportunity of judging of the system which has been at work, and of the fruits produced. The results of his investigation are here made known in a regularly classified form; we strongly recommend his book to the diligent perusal of every member of a School Board, and to all who are in the least degree interested in the management and direction of those institutions on which it may fairly be said, the future social condition and welfare of the people must depend. The author "ventures to hope, that in issuing a succinct account of each description of School he may save others many a weary search for information connected with educational matters."

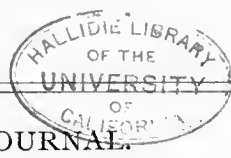

THE ART-JOURNAL.



LONDON: JUNE 1, 1871.

THE ROYAL ACADEMY.

THE ONE HUNDRED AND THIRD EXHIBITION.



HE Exhibition of the Academy scarcely disappoints, though it does not precisely fulfil public expectation. People naturally imagined, when the magnificent galleries were open in Burlington House, that a new era was about to dawn on British Art. But it is more easy to build handsome rooms than to fill them with noble pictures. At all events, after the experience of three years, we find things settling down pretty much to the state in which they were before. The number of Academicians rests at forty as of old, the Associates are practically restricted still to twenty, and the creation of six Honorary Foreign Members has again failed to bring to the constitution of the Academy or to the contents of the Exhibition any marked change. And thus it happens that the 1,338 works, distributed over fourteen rooms, are very much of that order of merit which has long prevailed in the most distinguished and still the most conservative gathering of the year. The Academy, if it have made no marked forward movement, is certainly not in retrogression. On the contrary, its strength, financially, socially, and even artistically, is greater now than at any previous period in its history. And we think it may equally be conceded that the one hundred and third Exhibition, now open, though more exclusive than many people might wish, gives a fair and tolerably full representation to the Art-talent of the country.

The aspect of the walls and the general arrangement of the galleries present little variation on recent Exhibitions. The materials to be dealt with by the hangers, Messrs. Cope, Redgrave, Ansdell, Sant, and Wells, are about the same as in the two previous years. Yet it would seem that the pressure from without—the clamour raised on behalf of rejected addresses—has induced the admission of a larger number of pictures than heretofore. In the last exhibition in Trafalgar Square were hung 925 pictorial works: in the first year in Burlington House 1,141, in the second 1,035, and now in the third Exhibition in the new galleries the total amounts to 1,178, being an excess of 253 on the last year in Trafalgar Square and 37 on the first year in Burlington House. The number of pictures rejected or crowded out continues to be pain-

fully large, as it always must be, just in proportion as the aspirants are many and the standard maintained is high. Talent which meets with disappointment, or which may have to bide its time, cannot but claim our sympathy; yet no more useful duty devolves on a governing body than that of rejection, and the lesson thus given to young artists is often most salutary. Each year, doubtless, mistakes are made, yet we incline to think that errors arise more from favouritism than from neglect. In Art-matters bribery is probably unknown, but intimidation and treating may in some quarters be still deemed legitimate influences. The claims of blood and of friendship are strong all the world over. The Academy would seem but to share in a common infirmity, favouritism is evident on its walls; yet Associations, from time to time started in protest against the Academy, fall into very much the same ways. On the whole the Exhibition shows power and independence as to rejection, with considerable impartiality in the selection. The collection is certainly widely representative.

The hanging of the Exhibition strikes us as fair, though certainly in some places far from judicious. The great gallery must be pronounced a failure, the arrangement shows little taste, the effect is patchy and incongruous. Speaking generally, we may say that the fairness which has for the most part prevailed is proved by the good places accorded to new comers. Academicians would here and there seem to have graciously given way to the rising talent of young men who one day will themselves be within the pale of the Academy, and the number of works which meet the eye by artists till now but little known strikes us as unusually large. The hangers have not materially departed from the precedent of the last two years; the several galleries, as we have said, present successively their habitual aspect. The subjects are of the ordinary routine, though what may be termed the rustic-domestic in general, and the Scotch school in particular, would seem for the moment thrown a little in the shade. At the same time may be observed a preponderance of works of imaginative scope, of subjects which aim, if not at history, at any rate at historic costume. A good time coming seems at hand, at least for pictures painted long ago and lying for years in expectancy; one or two such works we have known, now at length appear. The Council would seem not proof against imposition. As to foreign importations they are distributed freely about and scarcely in excess, though the number of pictures from the Continent seeking places and purchasers is beyond all previous experiences. It is understood that a large number of foreign works have sought entrance in vain, and we are glad to hear of any action taken which may serve to preserve an English Academy for the primary benefit of Englishmen. A survey of the whole Exhibition, wherein the interest is never permitted to flag, will tend to reconcile the visitor to the present condition of our national school. It may be a little unfortunate that memory still dwells with the old masters recently exhibited in these galleries. But it is right to bear in mind that all existing schools, whether at home or abroad, must suffer under comparison with the greatest, which were in fact the exceptional, products of past ages. But it may be truly said that the present Exhibition shows in the latest phases of our school a nearer approach to historic standards.

The contents of the Exhibition may be summed up as follows. Number of pic-

torial works 1,178; number of works in sculpture 160: total 1,338. Of this total 94 are contributed by Academicians; 49 by Associates; 2 by Honorary Foreign Academicians: total contributions from the Academy, 145. Against this total it is interesting to set the 1,193 works from outsiders. In further proof that the Academy is not solely maintained, as some would have us suppose, in the interest of its members, but likewise for the well-being of artists at large, it may be stated that of 790 contributors only 51 belong to the Academy, while 739 are outsiders. Only 29 Academicians are present: the absentees, who are eleven, are as follows: Sir W. Boxall, Messrs. Barry, Foley, Goodall, Hart, Sir E. Landseer, Messrs. Lee, Lewis, Richmond, Robinson, Scott. All the Associates are present with the exception of Mr. O'Neil and Mr. Lane. While, on the other hand, all the Honorary Foreign Academicians are absent save M. Gerome, who, in the present state of France, naturally prefers London to Paris.

GALLERY NO. I.

The first room is so arranged as to make a pleasant prelude to the Exhibition. Following the example of previous years the selection is agreeably varied, so as to give in some degree an epitome of the contents of the whole collection. Again the catalogue commences with a landscape, and though figures and landscapes are balanced and blended, a preponderance is once more given by way of courtesy to that branch of Art which the Academy is supposed in past years to have slighted. The places of honour are assigned, not to historic events, but to trees, rivers, valleys, hills. Among landscapes the principal are, 'Chill October,' by Mr. MILLAIS, 'Autumn Gold,' by Mr. VICAT COLE, 'Blackberry Gatherers,' by Mr. G. SANT, and 'Lake Lucerne,' by Mr. SYER. Among the figure-pictures will be remembered prominently, 'Peace, a Battlefield of the late War, twenty years hence,' by Mr. ARMITAGE, 'The Fortunes of Little Fritz,' by Mrs. WARD, and 'Old Mortality,' by Mr. CROWE. The hanging has been conducted on the sole principle of making things pleasant all round, though the artists who find themselves on the fourth tier can scarcely be satisfied with the result. For the most part, however, the pictures are seen perfectly well, the room is well-balanced, and yet its aspect is the reverse of brilliant. It strikes the eye as heavy. The number of pictures is 70 (three less than last year), of this total 2 are contributed by two Academicians, 4 by three Associates, and 64 by outsiders. Only two foreign artists are present. The number of outsiders is a little in excess of the average; indeed this first gallery may be regarded as a kind of ante-room, wherein outsiders coming on approval await full honours in the large banqueting chamber.

J. E. MILLAIS, R.A., as a landscape-painter, enters the Academy as the greatest novelty of the year. It is true that in the 'Vale of Rest,' 'Sir Isumbras,' and 'The Last of the Romans,' this most versatile of artists has thrown in landscape as an accessory; but here in 'Chill October' (14), for the first time, does he trust entirely to inanimate nature. In every previous picture figures are principal, in the study before us sky, trees, and water, constitute the sole subject. To say that this is the greatest landscape in the Academy would simply prove the want of critical discrimination; it is great in some points and less than great in others. In the first place it is evidently the work of a figure-painter, and the study of the figure, we have often been told, is the best training

for landscape. The advantages and the disadvantages of such academic study are, we think, in the present instance rather equally balanced. 'Chill October' is intelligent in conception, broad in arrangement of masses, definite in plan of light and shade. A bank of willows on the water's brink strikes in dark shade and with sharp serrated edge against the highest light of a grey October sky. The thought is worked out in monotone rather than in colour, and thus, if difficulties be not evaded, the treatment is at any rate simplified. The whole foreground is in possession of thickly-set water-reeds, which, as a multitude of lances, start from ambush. Throughout the artist shows anxiety not to get wrong, and he is wise in knowing at each point where to stop: a professed landscape-painter would have carried the study further, and perhaps might have fared worse. Yet it is observable that the painter is new to the work; the modes of handling are limited, the touches repeat themselves. The relation of details to generals is throughout true, chiefly because the utmost simplicity is studiously preserved. On the whole, this attempt, which beforehand might have been deemed rash—to pass from 'Moses, Aaron, and Hur' (191), in the great gallery, to a flat river scene in England—must be pronounced a success. That a great figure-painter should betake himself to landscape, need excite less surprise when we glance across the channel or extend our vision into historic times. French painters pass freely from figures to trees; and we all know how Titian's 'Peter Martyr' mingled human tragedy with landscape. It has been too much the habit of our English artists to crib and cabin themselves within narrow specialities; they will do well to give larger scope to the universality of genius.

Mr. MACWHIRTER fell upon evil days when the hangers determined to place him in immediate competition with Mr. Millais. 'Into the Depths of the Forest' (15) serves, in fact, by its very depth, to force into relief the picture of a higher key which we have just passed in review. The young landscape school of Scotland, which this year suffers reverse, will do well in future to study delicacy and detail. Among English painters, J. W. Whittaker and J. Syer are severally exiled to the ceiling, because of a rude handling which becomes sublime in distance. Mr. SYER has seldom approached so nearly to nature as in the 'Scene from Fluelen' (69), and Mr. WHITTAKER has only surpassed his 'Rough Road over the Moors' (57), in oils, by similar scenes in water-colours. In common with other members of the water-colour Societies, he is ambitious of the Academy. As a rule, it is easier to descend from oils to water-colours, than to essay the opposite course. Even Mr. Walker has this year met with a fall. This first gallery which, as we have said, is treated as a kind of ante-room where trees and fields come to the very door, contains several landscapes pleasant to look at. The spectator will not object once more to see 'Llanberris Pass' (20), a subject old as the hills, fairly well rendered by R. S. BOND. 'Blackberry Gatherers' (66), we likewise incline to accept as the best work yet produced by G. SANT, though still the style has quite as much of mannerism as of nature. Next in the circuit of the room, two ladies present themselves as worthy of notice and encouragement. 'A Spring Afternoon' (55), by Miss R. BRETT, is a fresh study from nature, and 'A Wotton Glebe,' by Miss F. REDGRAVE, is sparkling, and specially pleasing in the sunny shadow-flecked sward whereon a flock of sheep

reposes. Miss Redgrave has evidently been trained by her father, the Academician. We commenced this list of landscapes with Mr. Millais, we end with Mr. Vicat Cole. The pictures of the Academician and of the Associate occupy, as we have said, the two principal places in this introductory gallery. 'Autumn Gold' (52), is in some respects the finest landscape yet exhibited by Mr. COLE in the Academy. It may be objected that certain faults of the painter are more than ever observable, that the colour is heated, the execution indefinite. Still the conception is grand and imposing, and the artist shows no ordinary skill in the means he takes to lead the eye onward into vast space, each point illumined by light and the whole area filled by colour. Vicat Cole occasionally approaches, save in manipulation, John Linnell. And while his touch has less vigour, and his drawing less definition, his imagination, growing in range and glow, brings compensation.

'Peace, a Battle-field of the late War, twenty years hence' (19), by Mr. ARMITAGE, is the most remarkable among the singularly few subjects which the war has yielded to the Academy. An appropriate and prophetic passage is taken by the painter in elucidation of his meaning from the first book of the Georgics of Virgil:

"Scilicet et tempus veniet, cum finibus illis
Agricola, incurvo terram molitus aratro,
Exesa inveniet scabrâ rubigine pila,
Aut gravibus rastris galeas pulsabit inanes,
Grandiaque effosis mirabitur ossa sepulchris."

It is not unreasonable to imagine the same incident repeated in the nineteenth century; accordingly, men and oxen ploughing upon a battle-field, come across a soldier's grave, and turn up the empty helmet and broken sword. The picture is in style French, indeed, the composition and tone may recall one of the most famous pictures in the gallery of the Luxembourg, 'Cattle Ploughing,' by Rosa Bonheur. The child asleep in the foreground with nine-pins close beside him, is a pretty well-chosen incident: the associations of the past are all of war, but in the unbroken slumber of the young child there is "Peace." In the picture thus named the drawing is firm, in muscle as in drapery; the details, which are few, are chosen for the sake of adding emphasis to character, the execution aims at strength rather than delicacy—the colour is the reverse of decorative. Pictures of this class gain by exhibition; in private houses they may be little in keeping with modern ornate modes of furnishing, but in public galleries the effect is noble.

Mrs. E. M. WARD has chosen a theme well suited to her talent—'The Fortunes of Little Fritz' (27). It is related that when Frederick the Great was only four years old, a remarkable prophecy was made. An officer, looking at the lines on the hand, cast the destiny of the Crown Prince, and foretold various unpleasant circumstances that would befall him in youth: the prophecy ended that, in riper years Frederick would become one of the first princes in Europe. The picture tells the story well. The bright little fellow, unconscious of calamity as of greatness, stands on a chair, his hand held out while his destiny is proclaimed. Eager interest, verging on consternation, is depicted on the face of all present. The composition is thrown together naturally and pleasantly, the picture is as brilliant in colour as skillful in execution, and the dresses are painted with realistic power. The artist, as usual, obtains a place on the line: it is certainly her right.

Among lady-artists Miss OSBORN has long delayed the fulfilment of the exceptional expectations which great talents

raised in her favour long ago. Neither will the noble head 'Isolde' (37), place her in the position she ought to win. She can put forth greater power, if she will but choose a subject to call it into play. Yet this single head is of ideal beauty, the profuse hair with interwoven peacocks' feathers, and the golden necklace gemmed with opals, bring decorative opulence. The manner is evidently foreign. Large, broad, and not solicitous of finish, the style is that of Piloty, the present leader of the Munich school. Miss Osborn, during a protracted residence in Germany, has had rare advantages, and we shall look with interest for proportionate results.

This introductory gallery, as we have suggested, gives intimation of talents yet to appear more conspicuously. We are glad, for instance, to find Mr. CROWE in 'Old Mortality' (39), reviving the expectation raised by earlier works. The old man earnestly cuts away at a gravestone in a churchyard, while Sir Walter Scott looks on at the subject of his well-known story. The figure of the aged man is graphically delineated, and though the central colour be blue, the pictorial effect is good. Indeed, the well-known prejudice against blue has here again been proved to be unfounded. The painting throughout is solid and sound, and the artist for once gains character without falling into the grotesque. E. LONG improves, though we shall expect still better work than 'The Question of Propriety' (43), taken from the annals of the Inquisition in Seville more than two centuries ago. Francesco Patcheco, the monk, laid down rules of Art from the church point of view, and here a conclave of ecclesiastics is held over the moral proprieties of a dancing-girl. The painter himself strives to be within allowed limits, and in his endeavour his picture scarcely escapes heaviness. Yet the characters are delineated with rare insight, and the execution equals the conception. L. J. POTT, in a picture which hangs as a pendant and contrast to the preceding, deals with the dolorous theme 'Mary Queen of Scots led to Execution' (58); "'Allons donc,' said the queen of beauty, 'let us go;'" and passing out, attended by the earls, and leaning on the arm of an officer of the guard, she descended the great staircase of the hall." Mr. Pott, hitherto all but unknown, vaults at one leap into fame. The picture, though not free from defects, has something more than promise, and may be taken in evidence of the amount of latent talent lying comparatively unrecognised. The style pertains to what may be termed conventional history, yet the Queen of Scots marching to execution is a fine conception; strength of resolve is planted in her countenance, and indeed in every nerve and muscle. H. HARDY also surpasses his previous efforts in an effective scene taken from "Barnaby Rudge" (62). The famous raven is alighting on Barnaby's hand, and around are "a score of vagabond dogs belonging to the neighbours." It may be objected that the dogs are not vagabond, they are vastly too smoothly painted for the outcasts of society. Still such defects are but accidents, which the artist may on other occasions avoid. The last picture in the room is by G. A. STOREY: we defer the notice of this artist till we come to a more important work hereafter.

In this gallery is another group, that of artists artificial or sentimental. 'Romeo and Juliet' (5), by T. F. DICKSEE, though a fair example, belongs to a school which should be by this time obsolete. Considering the pressure upon the walls, we can but wonder that this class of work has not been crowded

out. To mention Mr. Thorburn in this category may not be kind: every one remembers the artist in another sphere. Also, perhaps, some apology is due to A. JOHNSTON, when we here throw in 'Isaac Watts and his Mother' (13). From "Christian Classics" the painter is pleased to quote how "on the sunny days the mother of Isaac Watts used to sit on a stone near the window of the prison where her husband lay to expiate his crime as a frequenter of conventicles." It is scarcely a satire on this fancy composition to say that the artist has treated his subject decoratively, that the faces on the canvas belie the story. Still the painter estimates rightly the public to which in these cases appeal is made. The picture is pleasing, and the success which the artist seeks follows in due course.

Naturalistic styles and rustic subjects are somewhat numerous and successful. E. NICOL, A.R.A., produces another strongly-pronounced Irish group—'How it was She was Delayed' (18). J. A. HOUSTON is at his best in 'Buckling' (33). This sturdy knight fastening on his armour is a capital study: the concentration of purpose is striking, the realism of the armour glistening in the high lights is illusive: the picture obtains a good place. Mrs. BRIDELL'S 'Arab Marriage' (36), being hung high, is not so easily appreciated; it evidently, however, is well drawn—the draperies are skilfully cast, and the colouring, as indeed the incident with the accessories, are true to Arab life. Mrs. Bridell's studies in Algeria are usually marked by local character and colour. 'A Capricious Customer' (3), by E. CRAWFORD, is to be commended; also 'The Mid-day Gossip' (28), by S. B. CLARKE. The last is a sunny scene in Venice: the figures are ranged about a picturesque stair against a light background, after a manner which is now affected by a few of our young artists; light, sunshine, summer dazzling heat, and consequent brilliance are sought, and thus attained. The manner, which is of foreign origin, is now fairly naturalised in England. Small but admirable pictures after the Dutch style are contributed by T. Wade, J. M. Barber, A. Stocks, and Edouard Frère. 'Making ready for School' (46), by T. WADE, is remarkably good of its kind: beauty is mingled with humorous character; the quality of *impasto*, execution, and colour, is fine. The future of this artist will be watched with interest. 'Granddad's Darling' (60), by J. M. BARBER, also deserves attention, as one of the many works which nowadays reach almost to an equality with the old Dutch masters.

T. S. COOPER, R.A., in the painting of sheep in a snow-drift has, in past years, in the Academy, proved himself unsurpassed. His sheep are softer in the wool, more expressive in countenance, especially when under suffering, altogether more true to the timid yet sagacious character of sheep, than Mr. Ansdell's fleecy flocks. Mr. Cooper also renders, with truth of line and delicate modulation of light and shade, wide wastes of snow-field undulating from foreground to hazy distance. 'Among the Fells, East Cumberland' (9), must certainly be classed with the artist's best efforts. Snow is not so successfully treated by Mr. OAKES in 'A Winter Morning near Bræmar' (1). The attempt is bold, but the scene almost unpaintable. 'A Combat—scene in the Forest of Glen Tanar' (10), by C. JONES, might have been excluded without serious loss to the Exhibition.

The portraits in this gallery are not very remarkable. 'Colonel Sykes' (35), by J.

ARCHER, R.S.A., is one of the most striking: the likeness is good, the attitude full of character, but the picture lacks colour. Miss STARR paints with refinement and intelligence 'Willie, Son of W. R. Beverley' (32). Also may be commended the head of 'Miss Kitty Ellis' (24), as delineated by F. B. BARWELL. Not so, however, Mr. PEARCE'S wooden effigy, 'The late Rear Admiral Sir James C. Ross, the Arctic and Antarctic Navigator' (26), painted for Greenwich Hospital by desire of several naval officers and scientific men. The picture-gallery of the hospital, which boasts of many renowned works, will have no reason to be proud of this latest addition to its treasury. Somewhat better—indeed, tolerably good—is another large affair painted to order—'The equestrian portrait of Col. Carrick Buchannan, of Drumpellier, accompanied by his huntsman, J. Squires, and favourites of his celebrated pack of foxhounds' (51). The picture will no doubt be appreciated by county people. The painter, Mr. G. STEELE, is a member of the Scottish Academy. The subject naturally suggested emulation of the manner of the president of the English Academy, who, to quote the words of the Duke of Cambridge at the annual dinner, "shines not only with his pencil, but when mounted on his hunter." Hunting-scenes, as a rule, are eminently in-artistic; but Mr. Steele, as we have intimated, deals with the intractable materials skilfully. The famous M. YVON, of the Legion of Honour, one of the many French painters now in London, contributes portraits of a vigour, breadth, decisive character, and strong colour, which contrast both favourably and unfavourably with our English school of portrait-painting. In a wholly opposite style does C. BAUERLE, the German, paint 'Charlie, son of Sir Charles Nicholson' (29). This artist merges his outlines in his backgrounds; his manner, if artificial, is charming, and will doubtless gain popularity in this country the more it becomes known.

GALLERY NO. II.

This is one of the least favoured among the rooms of the Academy. For instance, its wall-spaces are broken by no less than three doors, one whereof leads down to refreshments which emit among the pictures, we must apologize for remarking, anything but æsthetic odours. It is hard upon the Academy that after the lapse of three years it should be still so pressed for space as to be unable to carry out its liberal ideas, if not for Art, at any rate for the creature-comforts of its patrons and its visitors. The failure of the contractors for the erection of rooms for the Royal and other scientific societies, seems to threaten indefinite delay of the time when the Academy shall be able to enter on the extended premises allotted to it. As to the contents of the gallery on which we now enter, we may say that the pictures have been wisely selected and judiciously hung, all circumstances considered. Of a total number of 64 works 8 are contributed by eight Academicians, 4 by four Associates, and 52 by fifty-one outsiders. Of these outsiders three are foreigners. The hangers have carried the pictures three stories high at the utmost; there would be room under pressure for an addition of 50 per cent. on the present admissions. But to hang more works would prejudice the general effect, and lead to no good end. Under the present arrangement each work can be seen fairly well. The Academy being in possession of a handsome architectural interior is careful not to spoil it: the doorways are specially good, hence

the design is not marred by the placing of pictures above the doors—a position which in Trafalgar Square was reserved for revenge.

G. D. LESLIE, A.R.A., furnishes the chief attraction to this gallery in a picture he has never surpassed, 'Nausicaa and her Maids' (103), a subject taken from the Odyssey. The theme is classic in little else save the name. The artist has once more elevated his subject by means of beauty: his models he evidently idealises according to some cherished abstract type. Perhaps this process of idealisation has in this instance been carried rather too far—at any rate the figures lose individuality, they are refined away into generic forms which admit of no variety. The artist aims at tone, unison, tenderness, and seems to fear angularity or abruptness as a musical ear would dread discord. His lines accordingly are harmonious, his colours soft and hazy, his lights evenly diffused. We have said that the work fails of being classic, and yet it is something better than modern. And indeed we incline to think the mind of the artist when designing these graceful figures must have been imbued with the beauty of Greek vases. The cast of the draperies, the pose of the arms, the bend of the wrists and the attitude of the hands are akin to figures in the British Museum and the Vatican. Mr. Leslie, however, does not venture to restrict himself to the profile face, and his style ceases to be strictly classic when it becomes pictorial. The treatment in fact is the reverse of severe, it is romantic. At a time when Art is given to realism and matter-of-fact actualities, pictures of poetic fancy and ideal beauty are grateful to the imagination.

Mr. Frost, after long expectancy, has within the past year received full honours from the Academy. Accordingly he is now enabled to announce 'Musidora' (73) as by "W. E. FROST, R.A. Elect." The new Academician does not ask for much wall-space, indeed this is the smallest of the very many Musidoras it has been our happiness to see, but a decided and marked advance on some of his immediately preceding works. We also incline to think that the good appearance of this gallery is scarcely heightened by a scene from Hood's "Bridge of Sighs," so low in tone that on a dark day the subject is barely visible. Yet Mr. CANTY'S figure as she stands, 'With Amazement, Houseless by Night' (94), is fine in motive, the story is well told, desolation and despair carry the poor girl to the water's brink. It is fortunate a post on the line; could not be spared for Oliver Cromwell as depicted by F. S. CARY. Horace Walpole, in his "Anecdotes of Painters," tells how Cromwell said to the young painter engaged on his portrait, "I desire, Mr. Lely, you would use all your skill to paint my picture truly like me and not flatter me at all, but remark all these roughnesses, pimples, warts, and everything as you see me, otherwise I will never pay a farthing for it." We have seen better works from the hand of this artist. Some years earlier in date, taken in fact from the stormy and eminently pictorial times of the Civil Wars, is a scene which finds a place near to Cromwell. Mr. YEAMES, who loves to tread in the by-paths of history, has this year fallen upon 'Dr. Harvey and the Children of Charles I.' (81). The incident is pretty, and yet the picture is comparatively poor. The subject on examination proves to be an episode in the battle of Edgehill; indeed the fight is seen in the distance. The young princes, under the care of their tutor Dr. Harvey, accompanied the king in his wars with the Parliament, and it would seem that regardless of danger they got within gun-

shot. Curious as to what is going on, they clamber up a bank, and with the glee of childhood see the battle before them. The artist, who in a quiet way is fond of pictorial contrasts, seats Dr. Harvey in the midst of his books. The figures seem awkwardly large for the trees and fields, and the landscape by necessity is dwarfed by the figures: in other words, the picture does not compose, the colour too is far from delicious in harmony. Mr. Yeames will live to paint many better pictures.

Mr. MARCUS STONE and Mr. WYNFIELD are more successful than some of the preceding painters in the way of history. Mr. Wynfield this year seems indeed to be making good lost ground: his two contributions are an advance; and, indeed, we came with some little surprise upon the work here before us—'The Death of Buckingham' (114). The picture is most impressive, as was the historic tragedy depicted. George Villiers, first Duke of Buckingham, has been murdered, and the body "lifted from the ground upon the table, lies there alone." We are told that "the solitude could have lasted only an instant, when out upon the gallery-landing stood two distracted women, whose appalling shrieks rent the air." The treatment of light and shade is eminently dramatic—the death-chamber is in darkness, but bright light, as of morning or noonday, streams in at the open door. How far the artist can reconcile this treatment with historic facts seems doubtful; indeed, the passage he quotes states expressly that one of the ladies was "in her night gear." Yet daylight dawns on the corpse, otherwise it would be invisible. It may be further objected that the murdered duke does not fill his clothes; indeed, already the body is a ghost, and without tailory would be nowhere. The handling throughout is most careful, and yet not masterly. On the whole, the picture is commendable. Mr. Marcus Stone again, with advantage, recurs to the history of Henry VIII., his children, and wives. In the last Exhibition we had the pleasure of recognising with commendation various characters appearing under the title, 'Henry VIII. and Anne Boleyn observed by Queen Katherine.' We have now an analogous subject, 'The Royal Nursery, 1538' (104). If we read the composition rightly, the infant Prince Edward in a go-cart obtains the loving regard of fat King Hal; while the charming little Lady Elizabeth, left in the distance, only receives the favour of the monarch's broad back. The situation would tell on the stage, and by its studied contrast, no less than by careful delineation of individual character, it becomes effective on canvas. Still, as we had occasion to observe a year ago, the picture in its result is scarcely commensurate to the talent brought to bear. The work fails of historic significance, although in execution and technical qualities it is faultless.

This second gallery, which contends, as we have said, with some disadvantages, obtains support from J. C. Horsley, R.A.; E. J. Poynter, A.R.A.; G. S. Harvey, P.R.S.A.; and G. H. Boughton; not to enumerate other figure-painters of scarcely less repute. 'Truant in Hiding' (133) is a small adventure to Mr. HORSLEY'S liking. The idea, which, if not very remarkable, is at all events somewhat entertaining—the Royal Academician carries out with his accustomed ability. G. H. BOUGHTON'S 'Colder than the Snow' (99) obtains, we observe, much attention: firstly, we conceive, because the figures are thrown off from a background of snow; and, secondly, because the incident is spiced by love, rivalry, and jealousy.

The Art-merits of the work are certainly disproportioned to the attention it receives: one or two of the faces are scarcely in drawing, and the forms generally hesitate between severe mediæval definition and a modern soft suavity. The artist cannot stop here; if he do not go forward he will retrograde. By the time, however, we reach Gallery VI. it will become probable that Mr. Boughton may some day enter the Academy. Yet another picture, certainly the fourth we have already encountered, relies on the effect of a snow-white background. 'On the Track' (109), by H. R. ROBERTS, cannot fail of strong pictorial contrast, simply because well-drawn figures, resolute in action, pronounced in expression, strong in shadow as in colour, are thrown against a landscape clothed in whitest snow. This expedient is easy, the effect upon the ignorant certain, and yet to Art-tastes it is tricky.

E. J. POYNTER, A.R.A., is scarcely in the Academy in his full strength, simply because he has been giving his time and his talents in other directions. 'The Suppliant to Venus' (115) is a small canvas, and yet it may be conceded that the motive is large. The suppliant stands in the portico of a classic temple, rapt in devotion before the goddess of beauty. Clothed in leopard-skin, the figure glows in colour; the marble columns, tessellated floor, the blue sea and golden sky, traced with purple clouds, are wrought into a composition of deep expressive harmonies. The work is but minor. Mr. Poynter, we conceive, would do well to reserve sufficient time to complete each year for the Academy a work which should give full expression to his exceptional talents. We will not stop to speak of Mr. Prinsep until in a subsequent room he attains a matured form, in comparison to which previous efforts must appear chaotic. Mr. RANKLEY need not detain us long; 'Benediction' (39) is hung above the line: the best parts of this church interior are the hassocks. 'The Pleasures of Art' (116), by Miss BEALE, may be commended. 'The Fountain of St. Anne, Brittany' (100), by P. MACNAB, is a pleasing example of a certain hazy and dreamy manner imported within recent years from the Continent. The figures blend harmoniously with the landscape in broken colours—tertiary mostly, seldom primary: the whole picture is studious and quiet.

Sir GEORGE HARVEY, President of the Scottish Academy, obtains a central place on the line for a picture not unworthy of Sir David Wilkie. But how it happens that this 'School Dismissing' (87), painted in 1846, has not found its way to the Academy till 1871, is more than we can divine. Still the work is so much better than what now mostly comes to the light, that we should be sorry to raise a mere chronological difficulty. Perhaps it may be objected that this interior is muddled after the manner of Scotch artists, but at all events the eye may seek free outlet into space at the open door: here the 'School Dismissing' finds tumultuous and rapturous exit: the struggle is a feat of genius; we had not given the painter credit for an effort so spirited and juvenile. A. H. BURR, another Scotch artist, goes to Tennyson's "Dora" for a subject. The picture has merit, yet exemplifies the well-known faults of the school, especially when it forsakes rustic nature for more adventurous walks. The forms here want definition, and the colours need to be clarified. C. GREEN, a Member of the Institute, is one of those artists who, with doubtful advantage, betake themselves to oils. In 'Ruin' (125), this painter

attempts a scale beyond his strength. The composition does not hold compactly together, yet some parts are so well painted as to lead to the belief that success may crown some future effort. 'A Children's Party' (126), by G. B. O'NEIL, in the lack of individual character and sharp definition of touch, may be pronounced pretty and refined. The artist does not keep the plan or purpose of his picture very strictly in view; he seems to lose control of his *dramatis personæ*. The old Dutch masters were true to the grammar of Art, and it is obvious that just in proportion as the subject-matter of a picture is unimportant, must its technical qualities be unimpeachable.

Some speaking portraits look out from the walls of this gallery. The worthy Secretary, J. P. KNIGHT, R.A., paints his own animated and intelligent head under the disguise of 'An Old Student' (131). The likeness is admirable. G. F. WATTS, R.A., exhibits 'Lady Isabella Somers Cocks' (75), a head characteristic of the artist's elevated treatment, though rather vaporous in outline, in other words, not thoroughly carried out. The canvas is without varnish. It seems a growing practice to leave paint in a dead mat state, a habit taken from some continental schools. The pigments in consequence may look chalky and crude, and of course proportionably lose transparency. Directly opposed to the work of Mr. Watts is 'The New Picture: (Portraits)' (93), by P. H. CALDERON, R.A. If the style of Mr. Watts be the high Art of portraiture, that of Mr. Calderon is the *genre* of portraiture. The one is higher in kind: the other better in degree. Mr. Calderon's picture is carried out to great completeness, especially in the accessories. The gentleman and his wife are intent in scrutiny of 'The New Picture,' the last addition to a collection already numerous, if we may judge by the multitude of works which crowd the walls. The incident, with the skilfully-painted accessories, makes one of the most interesting portrait-pictures in the Academy. The gentleman, whose name is not entered in the catalogue, is understood to be a liberal patron of Art in the wealthy county of Lancaster. 'Ancient and Modern' (96), is the fancy title given by J. LOBLEY to a well-painted portrait. We have on several occasions commended the work of this clever artist. 'Adam Kennard, Esq.' (86), a sportsman, with gun and dog, seated on a stile, is a characteristic example of the most versatile of our portrait-painters. Mr. WELLS catches an easy attitude just at the moment when a man least expects to be handed down to posterity. His forms are usually well-defined, his colour, though sometimes experimental, is seldom wrong, his incidents and action, though exceptional, are never so eccentric as to shock correct taste or the manners of good society.

Animal-painting, in the absence of Sir Edwin Landseer, has fallen into the hands of R. ANSDELL, R.A. 'Feeding Goats in the Alhambra' (128) is literal rather than artistic. Neither as a picture will be highly esteemed, 'Don't put Trimmer in till the Squire calls the Hounds away' (113), by C. LUTYENS: much good work is here thrown away simply because this artist seems to forget that without composition a picture must fall into confusion. The landscapes proper are not very remarkable. The only Academician present in this department is R. REDGRAVE, R.A. 'The Avenue at Denbies' (122) is a conscientious work, especially in the details. 'On an English River' (82), by F. W. HULME, is the picture of a student, marred somewhat by black, blue, and green.

'Gander's Pool' (129), by F. WALTON, though worthy of the good place it holds, is rather muddled. A. A. GLENDENING has some good tree-study in 'North Wales' (127). J. W. OAKES displays power in 'Linn of Mnick, Aberdeenshire' (105). MARK ANTHONY also is strong as ever in 'Night and Storm and Darkness' (101). In this landscape, which to advantage revives the remembrance of previous pictures remarkable for power,

"An aged oak, that's breasted many a storm,
Whose heart by lightning's fiery glance is torn,
Stands out against the darkened sky."—*Atou.*

When an anonymous poem is entered in the catalogue, we are tempted to surmise that the painter is his own poet. In the present instance we have, at all events, the pleasure of pronouncing the picture a higher effort of genius than the poetry. The best landscape in the gallery is by comparatively an unknown man. 'The Heat of the Day: Loch Achray' (88), ought to make J. SMART a name. The mountains, intermediate distance and foreground, with cattle cooling themselves in the tranquil liquid lake, are admirably studied. The picture is painted firmly and broadly: detail is nowhere allowed to militate against the general effect or sentiment. We here seem to get much that was good in pre-Raphaelitism severed from its flagrant follies.

GALLERY NO. III.

The great gallery, measuring 82 feet long by 43 feet wide, is again hung as a *salle d'honneur*. The number of pictures does not exceed 104, of these 30 are contributed by twenty-four Academicians, 11 by ten Associates, and 63 by sixty-one outsiders. Eight foreigners are present. The gallery certainly is the reverse of crowded; indeed a few more pictures would improve the effect in a decorative sense. The hanging too strikes us as scattered and discordant; the room, it is understood, is hard to deal with, and any difficulties inherent to size or proportion are enhanced by the understood condition that all the Academicians shall be honoured with a place. In fact the only one of exhibiting Academicians hung elsewhere is Mr. H. W. Pickersgill. Thus it will be understood that this magnificent room may be taken as a summary of the efficient forces of the Academy. The three central posts of honour are occupied with good effect by 'Hercules wrestling with Death for the Body of Alcestis,' by Mr. LEIGHTON, 'The Salon d'Or, Homburg,' by Mr. FRITH, and 'Moses,' by Mr. MILLAIS.

The grand work which Mr. Millais after long deliberation at last ventures to submit to the ordeal of public exhibition has scarcely disappointed the expectations raised. The theme is noble. 'Moses, Aaron, and Hur' (191), are on the top of the hill which overlooks the plain wherein Joshua has been all day fighting. "And it came to pass, when Moses held up his hand, that Israel prevailed, and when he let down his hand Amalek prevailed. But Moses' hands were heavy, and Aaron and Hur stayed up his hands, the one on the one side, the other on the other side, and his hands were steady until the going down of the sun." In the picture sunset reddens an angry sky, and light as of the Divine Presence gathers round the venerable lawgiver. The head is noble, the hair tosses in the wind: the type is not entirely foreign to traditions in pagan and Christian Art, yet is it independent of Michael Angelo, and sufficiently distant from modern treatments. The grandly dramatic action finds some parallel in Raphael's 'Vision of Ezekiel.' Mr. Millais, as may be well imagined, environs his con-

ception in the glory of colour, yet, historically speaking, his colour, as indeed the general treatment, is not that of the Roman, Venetian, or Bolognese school. In fact his manner may be said to be simply his own. The costume too is a happy compromise; it is not precisely Bedouin after the manner of Horace Vernet and other French painters, neither is it Raphaellesque or Roman. On the whole the draperies comport with historic dignity. The execution strikes us as rather tentative and timid, as if the artist were treading in untried paths. This ambitious effort if not faultless commands respect.

Mr. LEIGHTON has never put forth so much dramatic intensity as now in 'Hercules wrestling with Death for the Body of Alcestis' (215). The subject has been treated by Euripides, also recently by Mr. Morris in "The Earthly Paradise," it is also glanced at by Milton:—

"Methought I saw my late espoused Saint
Brought to me like Alcestis from the grave,
Whom Jove's great son to her glad husband gave,
Rescued from death by force, though pale and faint."

In the picture before us Alcestis is lying on the bier, pale and cold as marble, but death has touched the form so gently that life may be yet restored. The moment is

"Before decay's effacing fingers
Have swept the lines where beauty lingers."

Opposed to this placitude is on either side convulsive action; Hercules wrestles with Death; the spectators are horror-stricken. In the centre the eye finds needed repose in sea and sky and distant hills. It has been objected that the anatomy, rather ostentatiously displayed, is inaccurate. With little exception, however, the picture is carefully studied throughout, the colour for once exchanges German opacity for Venetian lustre and transparency, gained after the Venetian manner by glazing warm tones over white surfaces. The forms aim at ideal beauty, the style is somewhat Academic, the execution is marked by accustomed subtlety and delicacy.

Mr. FRITH'S 'Salon d'Or, Homburg; Le jeu est fait—rien ne vas plus' (158), if not a sequel to, is in style synonymous with, 'The Derby Day,' 'Margate Sands,' and 'The Railway Station.' That the artist is sure of his public is once more attested by the rail put in front of the picture to protect it from crowds of intelligent and lofty-minded spectators: a precaution certainly not called for by any effort of high Art within the Academy. The public crowd to a picture just as they rush to a criminal court; villainy is stimulating and infectious. And certainly this gambling-table after its kind may be accounted perfect. Mr. Frith's version is more neatly thrown out of hand than Gustave Doré's pictorial narrative. Indeed for brilliant handling, for a sharp and spicy mode of telling a story, for clever cut-throat character, for costumes the admiration of milliners, for realism in the way of gold-chains, diamonds, and other precious stones, this picture has never been surpassed.

'Anne Boleyn at the Queen's Stairs, Tower,' (182), is the chief contribution of E. M. WARD, R.A. The picture sets forth with much power, pronounced colour, and realistic detail, how "Kingston awaited the Queen on the last steps of the stairs, where she was given into his custody. . . . She asked the lieutenant if she were to be taken to a cell. 'No, madam,' replied Kingston, 'but to the apartment which your grace occupied on the day of your coronation.' . . . Throwing herself on the steps, she exclaimed, 'Jesus have mercy on me!' A flood of tears followed this pious ejaculation." Vide

'Life of Henry VIII,' by Antin. Mr. Ward, as usual, is happy in the choice of his subject; he selects commonly some turning-point or climax in the current of history. His collected works in fact would present a vivid pictorial chronicle of English history. The picture is the work of a thorough master, and fully sustains the high reputation of the painter.

'Lenore' (164), by A. ELMORE, R.A., is taken from Bürger's popular ballad translated by Sir Walter Scott.

"Tramp! Tramp! along the land they rode,
Splash! Splash! along the sea;
The surge is white, the spur is bright,
The flashing pebbles flee."

There is no light in heaven save the pale light of stars, a world of shadows is peopled by spectres; among the clouds float fearful forms, across the sky fly strange creatures, sirens with fearful fires burning in hollow eye-sockets swim in the sea, and in the midst the wild black horse tramps and splashes, bearing the lovers to churchyard shades of death. Such is the scene by which Mr. Elmore moves the imagination deeply. The picture is perhaps inevitably artificial and spasmodic. The conception would seem to fall more legitimately within the sphere of poetry than of painting. 'Sabrina' (233), by W. E. FROST, R.A. Elect, is also poetic and imaginative. Mr. CALDERON has fortunately forsaken his modernised classicism to revert once more to what may be called historic costume, represented by a skilfully composed, well-painted scene: 'On her way to the Throne' (167). The picture is a covert satire upon high society; the court hair-dresser gives the last finishing touch to the Queen's head-dress as if the destiny of Europe hung on the set of a curl. The contrast is well struck between the obsequiousness of the menials and the high birth and proud bearing of the ladies of the court.

The Associates are in force; some of the newly-elected especially manifest a vigour and youthful adventure which seldom remain to old stagers in the Academy. 'The Bookworm' (149), by H. S. MARKS, one of the recent elections, is a work well suited for its destination in the library of Crewe Hall. The old fellow, who would appear as much the naturalist as the "bookworm," is lost in profound investigations. The table is crowded with strange-looking skeletons, as if this student were a disciple of Darwin. Quiet satire lurks in the picture, and yet the story is told with as much verisimilitude and circumstantial detail, that the eye seems to rest not on a fiction, but on a grave reality. The composition is well kept together; the execution is even solid; the brush does not show itself: it is not paint or canvas that the spectator looks upon, the very room, as it were, is put within the frame. Mr. POYNTER we have already spoken of in praise: 'Feeding the Sacred Ibis in the Halls of Karnac' (238) is a good example of the archæologic realism to which a certain section in the English school is now tending. Mr. ORCHARDSON, whom we shall meet in the sequel, cannot at all events be accused of realistic elaboration. 'A Hundred Years ago' (196) is almost too sketchy and scratchy to be even suggestive. Mr. PETTIE'S 'Pedlar' (179), clever after its kind, belongs to the same school. Mr. Le Jeune, Mr. Yeames, Mr. Nicol, and Mr. Dobson, the remaining Associates, we shall hope to meet again. Yet a word of welcome is due to Mr. DOBSON'S refined personation of 'Charity' (223). This ideal style, traditional treatment, and stereotyped beauty will not be likely to obtrude overmuch upon us in these realistic times.

Animal-painting, for which our English school has been justly famous, suffers under the much-regretted illness of Sir Edwin Landseer. The gallery again owes obligations to T. S. Cooper, R.A., and R. Ansdell, R.A.; also we observe by Mr. BEAVIS 'Autumn—Ploughing' (180), a picture which more than justifies the expectations of previous years. As chief among flower-pictures, 'The Balcony' (205), by Miss A. F. MUTRIE, occupies the line. J. C. HOOK, R.A., brings from Norway scenes which more than justify our judgment that the country is unpaintable. G. MASON, A.R.A., makes 'Blackberry Gathering' (168) the occasion for that dreamy, hazy, poetic sentiment which, though some years since wholly in disrepute, now finds copious utterance among men of the future. Among the portraits, those of 'J. E. Millais, R.A.' (172), and of 'F. Leighton, R.A.' (177), by Mr. WATTS; also the portrait of 'John Mac Whirter' (190), by Mr. PETTIE, provoked interesting comment at the Academy dinner.

This gallery, arranged as a climax or consummation of talent, is adorned by works which, in almost every department of Art, are worthy of honour. The portraits are as usual numerous—possibly for some too numerous; yet on resuming our notice a month hence, we shall endeavour to show that the art of portrait-painting is, to say the least, not in decadence. Landscape Art is here scarcely strong, chiefly because figures are allowed the precedence. Indeed, since the death of Creswick the best landscapes are not by Academicians but by Associates, or painters beyond the pale. Outsiders, both English and foreign, present themselves in goodly number: we shall recur to this major and specially vital section of contributors as an index of the Arts of the future, as a gauge of the youthful genius now rising through the length and breadth of our land. We propose, then, in our July number to return to the Great Gallery, in order to form a just and worthy estimate of the present phases of our national school. In fine, we may say that this, "the one hundred and third," exhibition, though certainly not above average, gives to the Academy the assurance of a future long, prosperous, and useful.

SELECTED PICTURES.

FROM THE PICTURE IN THE POSSESSION OF THE PUBLISHERS.

TALBOT AND THE COUNTESS OF AUVERGNE.

W. Q. Orchardson, A.R.A., Painter. C. W. Sharpe, Engraver.

OUR readers will, no doubt, remember the wood-cut from this picture we introduced last year, with other illustrations from the works of Mr. Orchardson, in the biographical sketch of this artist. We have been induced to reproduce it on a larger scale, and in another mode of engraving, from a repeatedly expressed desire on the part of numerous subscribers to see it occupy a more important position in the Journal than it had previously.

It may be well to add, for the benefit of those who do not chance to possess our last year's volume, that the subject illustrates the scene in Shakspeare's *Henry VI.*, when the troops of Lord Talbot, the leader of the English in the wars against France, force their way into the presence of the Countess, thus proving to her that he is not the "child, a silly dwarf," which she charged him with being.

SOCIETY OF PAINTERS IN WATER-COLOURS.

SIXTY-SEVENTH EXHIBITION.

THIS Society, notwithstanding the serious secession of two of its distinguished members during the past year, opens its sixty-seventh exhibition stronger than before. It has wisely recruited its forces; removing the limit to the number of its Associates, it elected five artists in a batch, and is still on the search for any outlying talent which may bring further *clat* to the gallery. The policy thus adopted is timely and wise. The competition of the Academy had become serious; painters in water-colours have been taking to oils. Mr. Frederick Walker, for example, who has been captured by the Academy, does not furnish a single drawing to his old society. The new comers, who have been well-selected, are not unknown to fame, at least four of the number, Messrs. Houghton, North, Macbeth, and Goodwin, have been exhibitors in the Dudley Gallery. These repeated raids on a young and struggling society seem rather cruel; no sooner do the Dudleyites bring into notice new talent than a capture is effected by the Council of the Water-Colour Society. Fortunately the country is so prolific in painters of this class that the ranks of each competitive association are no sooner thinned than filled up. The old Society has certainly stolen a march upon its rivals, who will now be at their wits' end what manoeuvres to take next. It is clear that the galleries open in Pall Mall, the Haymarket, Piccadilly, Bond Street, Conduit Street, &c., are in excess of any true Art-interest to be accomplished. The standard of excellence becomes lowered by this facility of exhibition. There has been a danger also that incessant and increasing competition might lead to weakness all round, so that in the end no corporate body, with the exception of the Academy, would be found strong enough to champion the cause of national Art, or to take on great public occasions a widely representative action. We rejoice then all the more to see that the old Water-Colour Society is no longer a clique, that the number of its Associates will be made, from time to time, commensurate with the rising talent of the country. The present exhibition, which opens as a manifesto of the new policy, augurs well. It has, indeed, taken people by surprise: a society, supposed by some to be on the wane, starts into new life.

The space at our disposal being this year considerably curtailed, we must be pardoned if we pass several old favourites with cursory notice. We cannot, however, dismiss without a word of welcome Mr. Palmer's grandly conceived theme, 'The Fall of Empire' (161). "While stands the Coliseum, Rome shall stand," wrote Byron, "and when Rome falls, the world." 'The Fall of Empire' Mr. Palmer, a truly poetic painter, has depicted in the ruin of the Forum, stagnant waters stand in the Appian Way. The treatment, however, is too imaginative for literal truth; like Turner's 'Ancient Italy,' the scene is a romance—a frenzy, indeed,—of fancy. The rising of the moon amid the intense glow of sunset, is an impressive, though somewhat stereotyped performance, which takes place not infrequently on the stage. Carl Haag, in 'Danger in the Desert' (104), may also be said to trust to his imagination for his facts, and to his memory for his poetry. The drawing is artificial and florid. The head of 'An Egyptian Bashi Bazouk' (203) would seem to be taken from the life, and it is accordingly true. Little that is new can be said of T. M. Richardson, C. Branwhite, Collingwood Smith, David Cox, Jun., S. P. Jackson, H. Gastineau, W. Evans, or S. T. G. Evans. Artists who have been for many years before the public get spoiled sometimes by success, and occasionally by disappointment: often they paint with audacity, and occasionally with supineness, as if all spirit had gone out of them. On the whole, perhaps, success does less harm to an artist than failure. 'Deitz, on the River Lahn' (155), by Mr. Richardson, is less disfigured by mannerism than usual. This artist's

brilliant facility has been his snare. The mannerism of Mr. Branwhite, though confirmed, breaks out into new phases; at distant intervals he comes upon a fresh idea which seldom wants grandeur. Certainly few drawings in the gallery are so impressive and powerful as his 'Deserted Mill on the Essex Coast—Sundown,' (51).

John Gilbert's 'Soldiers Retreating' (52), and Mr. Branwhite's 'Deserted Mill,' above noticed, hanging together, suggest comparison. The two artists are not wholly dissimilar in style; in picturesqueness, in force, not to say heaviness of handling, in depth of colour, sometimes inky, in a certain shadowy imagination which carries a subject back into the gloom of the past and the mystery of times remote, the painters are evidently akin. The backgrounds of Mr. Gilbert, which are usually grandly suggestive, are set in a key consonant with the landscapes of Mr. Branwhite. These artists stand out as anomalies in the present phase of modern Art.

Mr. Frederick Tayler, the President, favours the gallery with one great effort, an epitome, so to say, of his genius, a summary of long years, a conglomerate of many drawings. The reader will know then exactly what to expect in 'Cattle Ferry-Boat crossing Loch Alsh from Kyalakin, Isle of Skye' (18). This compilation, this serving up once more of old materials, holds together so loosely, that the drawing is in danger of falling to pieces. Still this is an Art that we all must rejoice to see yet vital. 'Welsh Children' (59), by F. W. Topham, though not materially different from Irish children, and divers other children with which the artist has in previous years favoured a grateful public, serve to make a very pleasing picture. Mr. Topham never fails to encircle his peasants in a halo, or rather mixture, of sunshine and mist; what he means is not always clear; he may possibly amuse the fancy, but he never reaches the intellect. Mr. Lamont, too, labours on without any defined purpose; sometimes he is elegant as when 'In Tune' (102), and again he is lost to beauty while he slides awkwardly into 'A Reverie' (180). He wants a purpose individual and defined, his bane is that he knows no higher motive than to make each and every drawing commendable, after some fashion, to a public quite as indifferent as himself to the means employed for giving momentary pleasure. Mr. Shields is greatly to be commended in that he is now content with an area of square inches in place of many square feet. A few months ago we feared he might require a gallery all to himself. It has been our privilege to enjoy deeply the works of this painter in bygone years, while yet they were instinct with truth and pathos. We trust it may be yet possible for him to return to the ways he has of late forsaken. J. K. Johnson seems to be opening for himself a new career with doubtful results. Hitherto he has been favourably identified with a sparkling character and crisp touch, which evidently held affinity with Meissonier and other brilliant *artistes de société* in the French school. Suddenly *il change tout cela*, he plunges into a 'Midsummer Night' (118), and loses himself in reverie. What sundry young ladies, and especially a certain funny old gentleman, can all be about, it is hard to divine. What is chiefly to the immediate purpose is that the picture is a failure. Much time and talent are simply thrown away on a first conception which evidently is a mistake. Parts of the picture are supremely well painted, for instance the white lilies shadowed under midnight are exquisite. There is no lack of drawing or knowledge in this work; what only is wanted is that the artist should in the first conception bring clear and critical intellect into action. And this is just the want which in the present day is grievously felt. Painters will commit themselves to weeks and months of arduous labour without mental forethought, without counting the cost, or clearly calculating the result. Mr. Watson and his fellow-student, Mr. Marsh, plod on after a wholly different fashion; they are in greater danger of sticking in the mud than of being lost in the clouds of dreamland. 'The Pedlar' (28) by Mr. Marsh cannot be objected to by persons who possibly may fancy pedlars of this sort. The whole scene is distressingly commonplace, without one touch of redeeming



W. PHARES

STANDARD AND THE GUNTER OF THE ANTIQUARIAN

NEW YORK: THE GUNTER OF THE ANTIQUARIAN



Art. 'Farm-Yard Favourites' (86), by Mr. Watson, has unusual tenderness. The drawing has delicacy, the sentiment is not without refinement. 'The Escape' (191), by Miss Gillies, has obtained commendation; and several contributions by Walter Goodall, have a sweetness and softness which appeal pleasantly to a sympathetic public. 'The School in St. Peter's, Rome' (34), by this bland artist, surprises the spectator by individual character. One or two of the boys may actually turn out bad, an occurrence which has never been known to happen to any model from which Mr. Walter Goodall has hitherto painted. Of like innocence are the characters Mr. Dobson commits to canvas, or paper. 'St. Mary Magdalene' (124) is singularly immaculate. Were it not for a certain Greuze-like softness and fulness in contour we might have mistaken the character for St. Agnes, or St. Cecilia, or some other of the virgin saints. Mr. Dobson, we presume, is a spiritualist, and yet he does his best to paint flesh.

Landscape-Art has witnessed less change within the year than figure-painting, the new elections having been all but exclusively in the latter department. We have already mentioned some of the most conspicuous students of out-door nature; but others of note, such as Thomas Danby, claim attention. This artist is distinguished by a certain ideal sense of nature, he delights in what is lovely, trees are by him balanced gracefully on the water's brink as elegantly-draped figures. Indeed, a well-grown tree of noble bearing or graceful mien, when fitly used in a composition, has often the value of a figure. 'The Fisherman's Home' (194), by T. Danby, is suggestive of this line of thought. The fault of this painter is that his forms fail of definition; thus 'The Cloud' (76) is formless, it is not a cloud so much as an evanescent mist. The appropriate lines of Shelley from a well-known poem lose by a misprint their exquisite melody; they ought to run thus:—

"I am the daughter of earth and water,
And the nursling of the sky;
I pass through the pores of the ocean and shores,
I change, but I cannot die."

Holman Hunt again attempts to paint impossibilities. In 'The Pathless Waters' (256), he strives to seize on a lovely phenomenon of sky and sea, familiar to all who have voyaged on the Mediterranean. The moon makes for herself a clear path through clouds which crown, or rather encircle, her head with a halo of iridescent light. The sea beneath shines as burnished silver. This poetic aspect of nature probably cannot be translated into a picture. We may commend then the attempt while we pardon the failure. 'The Interior of the Mosque of Omar' (204) is an equally bold effort in another direction: the difficulty here not being atmospheric, but in realistic rendering of richest marbles, and in a decorative structure resplendent in colour. Mr. Holman Hunt, on a prior occasion, challenged like difficulties in a church in Sicily. That he does not utterly fail is evident on comparison of 'The Mosque of Omar' with Mr. Read's Interior of St. Mark's, Venice' (174). Each structure is ornate with richest materials. Mr. Read has the advantage in linear perspective, in the accuracy of curves and vaulted roofs—a no slight difficulty in St. Mark's,—but in colour he is muddled; whereas Mr. Holman Hunt is altogether resplendent; his drawing is almost a study in mineralogy. We may mention, too, that it possesses no small archaeological interest.

Among faithful, painstaking students of nature, C. Davidson still holds a quiet place. With doubtful success he has gone out of his accustomed beat in 'The Spittal of Glen Shee' (75). But in two careful studies of 'Early Spring' (31 and 111) he is once more unsurpassed in delicate tracery and interwoven network of trees budding into tender leaf against a clear open sky. Mr. Birket Foster's drawings are up to accustomed excellence; indeed, in the treatment of figures set in landscape or by cottage-door, he has never surpassed 'Rabbits' (235) and 'River Scene, with Sheep' (243). P. Nafel continues to be rather dotty, scratchy, and scattered; he is still best in the green lanes of his once island-home, as, for example, in 'Spring—Guernsey' (25). Of the artist's

foreign subjects, the best we have seen is 'Plaza de la Falpa, Seville' (231), a product, we presume, of the recent eclipse expedition. J. W. Whittaker is wise to keep within the United Kingdom; no artist understands so well, or represents more truthfully, a mountain-moor with an angry torrent roaring through the midst. 'The Last Gleam of Sunset on the Glyders' (119) is the best work we have seen by this artist for many a day: we recognise, indeed, the hand of nature in this free bold picture, fresh as the open air and the breezy moorland. And seldom, if ever, have we seen Mr. George Frigg more happy in his inimitable way. He, too, like Mr. Whittaker, goes direct to nature. There is no more truthful study in the gallery than 'Tintagel Castle' (37), whether in faithful drawing of the rock, in varied harmony of colour, or tender play of light and shade. Mr. Powell seems to have a stronger head for the sea than for the land. 'Loch Gail' (30) is feeble and ill-managed. On the other hand, there is nowhere a better study of a tossing sea than in 'Arran, from the Inchmarnock Waters' (98). The water in which Mr. Duncan places some 'Dutch Fishing-Boats' (101) is, in comparison, soapsuds. Mr. Powell's waves are true in form and crisp till they break on the crest; Mr. Duncan's seas are lashed into formless fury.

Architecture, animal-painting, flower-painting, and other miscellanies, fare indifferently well. Neither Mr. Read nor Mr. Deane is at his best. 'North Porch, Chartres Cathedral' (187), by the latter, wants definition and strength; a photographer would say that the subject was out of focus. William Callow has not for long come out so well. 'Posta delle Lettere' (152), a well-known spot in Venice, though rather inky in the shadows, a fault common to the artist, is made into a very effective picture. 'The Cartoon Gallery, Knole' (188) is a favourable example of Mr. Joseph Nash. Mr. Riviere cannot be complimented on his architectural studies in Rome; they want delicate detail and modulation in tone and colour. In animal-painting, Mr. Brittan Willis and Mr. Basil Bradley are, as heretofore, chief exponents; the well-known styles of these several artists are not likely to change for better or for worse.

The new-comers deserve hearty welcome: far from immaculate in manner, they are fresh in the flush of youth, warm in colour as wayward in conception. A. B. Houghton bounds into the gallery as one of the manly yet uncouth Indian chiefs he loves to paint. 'Hiawatha and Minehaha' (138), is weird in imagination, the colour is hot as the action is wild. 'In Captivity' (67) obtains as it deserves a place of honour. These captive Jews by the waters of Babylon are deeply impressive. Mr. Houghton displays that audacity which is the prerogative of genius. In manipulation he is absolutely reckless in the use of opaque pigments. We regard with utmost curiosity his future developments. R. W. Macbeth, son, if we mistake not, of the well-esteemed Scotch portrait-painter, entered the Dudley Gallery only the other day absolutely unknown in London. When his first work, hung on a screen, obtained in our columns the notice it deserved, we little thought that the young artist would so soon obtain the honour of election in this old society. 'Frozen in' (236), and 'Gipsies' (223), justify the council. Mr. Macbeth, like other rising men, is free from conventionalism, he will strike out into paths original, possibly eccentric. He is bold, and yet knowledge will save him from being rash. The two men we have just named are distinguished for character; the three remaining elections are commended by colour. W. M. Hale comes from the west country, and his drawings on the Avon and the Bristol Channel are conspicuous for the deep russet hues of Charles Branwhite, also dwelling on western confines. Mr. Hale promises fairly; whether his art be original or derived we must await to see. Albert Goodwin may certainly take to himself the somewhat questionable glory of the style he has made his own. His drawings commanded good places in the Dudley, and here they will not fail to obtain thoughtful though hesitating appreciation. 'Sunset' (43) is the most subtle product of the artist's plodding pencil;—his colours are pearly,

his lights silvery, the picture is altogether delicate and delicious. Lastly, in these new elections, we come to J. W. North—an artist also brought into notice by the Dudley Committee. 'The Timber Waggon' (158), and 'The Village' (164), show that the artist was determined to enter on his new honours in flaming colours. Mr. North is one of the men who gem or accentuate landscape by brilliant and well-set figures. We have always thought most highly of his works, and success seems to have put him on his metal. The old society has lost, as every one knows, Mr. Burton and Mr. Burne Jones. The men elected to recruit waning strength stand at the antipodes of the two receding artists.

The school now dominant in the gallery is a school of colour. Mr. Walker, and his representative on the present occasion, Mr. Pinwell, could not be content with form if colourless. 'Away from Town' (130), the latest of Mr. Pinwell's strange achievements, is clever as strange. The artist cannot be accused of carelessness, haste, or immaturity, and yet to tastes uninitiated the result is not wholly agreeable. In addition to a colour fiery as the equator, it may be objected that the subjects served up are forced and tortured into pictorial composition after a method just the reverse of nature's spontaneous growth and action. Among the colourists in this gallery, diverse as they are numerous, must be mentioned lastly though not least, G. P. Boyce and Alfred W. Hunt. Mr. Boyce is the more meditative and sedate, Mr. Hunt, the more joyous and ecstatic. 'The Abbey Church' (208) is sober as Gray's elegy, while the 'Land of Antique Slate' (63) is dazzling as a rainbow, resonant as orchestral music. There is eloquence in such colour, it fires the imagination and carries the mind captive. Other drawings remain upon which we could with pleasure dwell, did space permit. Visitors will regret, with us, bidding farewell to a collection so excellent.

INSTITUTE OF PAINTERS IN WATER-COLOURS.

THE THIRTY-SEVENTH EXHIBITION.

THE present exhibition, though scarcely of average merit, is not without interest. The visitor who makes a careful circuit of the Gallery cannot fail to discover some dozen or more works which show the art of water-colour painting at a point of perfection seldom surpassed. And so long as the public are sure to find in this room what they would not willingly miss, "the Institute" may reckon on obtaining its fair share of success. Still we have once more to deplore the vast mass of indifferent works which obtain a place on these walls; thus the gems have to be sought out as scattered grains of wheat in bushels of chaff. It is a pity the members will not submit their contributions to the process of winnowing; but it is too much to expect of human nature such self-denying ordinance. Furthermore, it would seem that the Institute suffers under competition with the many galleries now open: there is a falling off even in the number of drawings contributed. On referring to the catalogue we find fifty fewer works this year than last, and in consequence one screen has been suppressed and the inner room closed. However, 233 drawings will tax patience sufficiently. To add to the trials of the Institute, the well-meant scheme of honorary membership has all but broken down: Mr. Herbert, out of eight, is the only contributor. The rest are practically defunct, and indeed, Maclise is absolutely dead, though his name still lives in the list of members. Since the last spring gathering William Bennett, called sometimes the David Cox of the Institute, has also been taken from his labours into rest. 'Rosenlaur, Switzerland' (43), the last work on which he was engaged before his death, hangs on the walls in memory of a man we can ill afford to miss, an artist gifted with that simple love of nature which in these artificial days is growing rare. Those who may have watched

William Bennett's later works in this Gallery will have been pained to see a faltering hand, the prelude to decay. But we have a memory long enough to recall upon these walls scenes in Windsor Forest and the like, noble oak-trees of gnarled trunks, broken foregrounds of jagged ferns, picturesque to the last degree, and painted with firm hand and broad transparent touch. The eleven drawings here collected will serve to indicate a style which has often found commendation in our columns.

Great changes, mostly for the better, have come over the Institute of late years. In particular it is pleasing to observe how the artificial school is giving place to simple naturalism. Indeed, the truthful figure-studies contributed by C. Green, A. C. Gow, G. G. Kilburne, and W. Small, constitute the chief attraction to the exhibition. No more fortunate election has been made of late in any society than that of Mr. Small; 'Frozen Out' (82), by this vigorous, though somewhat eccentric, artist, is marked by unmistakable talent. The story is well told, a deep snow has brought to starvation-point sheep, rooks, and small birds, who all rush, hunger-driven, towards the proffered provender. The execution is quite equal to the conception: indeed, certain passages could not be better painted. Another picture termed 'Potatoes' (156), presents Mr. Small before us as the disciple, if not the imitator, of Mr. Walker. He will do well to preserve his talents intact, his originality is sufficient to protect his Art from subserviency. C. Green maintains his previous credit by a figure capital in character as in workmanship. 'The Last Glass' (175), is that of Meissonier with the not unimportant difference that the perspective is somewhat untrue, and the drawing of the figure careless. Andrew C. Gow has also looked closely at Meissonier: he seems likewise to have an eye for the humour of Hogarth, an artist whose influence over modern exhibitions is unaccountably slight. 'Plucking a Pigeon'—the pigeon being not a bird but a human dupe at cards—is perhaps the most mature work in the exhibition. The subject is well thought out in its chief action and by-play, the several parts are composed into a compact whole, the details have a purpose, the touches a sparkle. As to the *technique*, the artist shows skill in combining opaque with transparent colours: he is correct in the principle which governs his practice—that of making, as in nature, the lights opaque, the shadows transparent.

H. B. Roberts, an artist whom we have before had occasion to commend, exhibits 'Returning from the Garden' (188), a true study from the life, emulating the manner of the late William Hunt. W. Lucas seems to be aiming at a higher sphere of society than heretofore: and yet 'The Squire's Daughter' (89), does not quite throw off the rustic. G. G. Kilburne is not successful in the enlarged scale attempted in 'The Chess-Players' (20); 'La Bonne' (93), however, is quite at his best. The subject is one of the many war-incidents which now continually show themselves in our picture-galleries. During the present Art-season several of our London Galleries tell of the flight of painters from Paris. The loss of our neighbours has been in some measure our gain: our picture-galleries are enriched, and in friendly intercourse is learnt the brotherhood of genius. The Institute has long been a neutral ground whereon foreign and English artists meet in generous rivalry. In the Society are two German, three French, also three Belgian artists, while the names of several English members and associates indicate foreign origin.

Guido Bach, Henry Corbould, and Augustus Bonvier, are known for a certain showy and artificial manner which, though successful for a season, in the long-run suffers collapse. We could scarcely, indeed, have believed it possible for Guido Bach so speedily and utterly to have fallen from the eminence he reached but a few years since in this very gallery, as in the weak and flanneting work now before us, 'A Tempting Offer' (40). Mr. Corbould's ambitious efforts in another quarter have apparently precluded him from giving to this gallery more than one small drawing, 'The War-Horse' (225). Mr. Corbould's studies of war-horses have

evidently been limited to Astley's Theatre. Mr. Bonvier depicts with his accustomed grace 'First Arrivals'—at a Pompeian Theatre in the time of the Romans. It is too late to ask the artist to go to nature: his style now is beyond the possibility of change. 'Flowers of the Forest' (199) by Mr. Tidey are lovely in form, refined in motive, and nicely balanced in composition. The colour, however, as in other drawings by the same hand, is not so satisfactory. The style of John Absolon has likewise fallen into mannerism; among five contributions, however, one or two, as for example, 'A Suffolk Well' (131), and 'Metal more attractive' (209), show the artist in his happiest moods. Mr. Absolon is specially felicitous in flirtation and love-making.

J. R. Herbert, R.A., is the only Academician in the list of honorary members who favours the present exhibition. Mr. Millais and Mr. Goodall are both among the absentees. 'St. Mary Magdalen crossing Golgotha to the Tomb of Our Lord' (34), is of that phase of spiritual Art with which Mr. Herbert has long made us familiar. There is a thinness and poverty about the manner; the colour is pallid. The Venetians, and the old masters of other Italian schools, would have thrown deep solemn harmonies even into moonlight on Golgotha. Mr. James Linton, in four contributions, maintains his position, though he does not yet quite realise the expectations he has raised. 'The Lover's Disguise' (60), has a certain awkwardness of composition which may result either from the artist's mediævalism, or what would be more fatal to his future, from an innate inability to see harmony in line, and symmetry in grouping. Yet awkwardness is here reconciled with dignity, and one advantage which may be consequent on stiffness in gait and strange fantasy in costume, is that even the smallest incident in life, such as 'The Reproof' (120), of a little child, gains a certain historic import and solemnity. The same line of criticism may be adopted as to Mr. Bromley's mediæval performances. Thus, merely beating 'Dust' (74), from a carpet is made a momentous operation. It is to be hoped that this clever artist will not undertake more work than he can get through with credit; the drawing before us shows carelessness, especially in accessories, which are slighted as if of no consequence. Mr. Jopling has done more than ordinary justice to his talents in a figure much to his liking, with

"Sweet eyes of starry tenderness,
Through which the soul of some
Immortal sorrow looks."

We fear the lady's immortality rests less in her soul than in her millinery. The picture is as usual decorative, if not frivolous. Still, this artist has a good eye for pictorial effect; he gains amazing force of colour, and through utmost depths of shadow the eye seems to look into deeper depths beyond. Mr. Jopling never fails to arrest the spectator, he works out interesting problems in colour, his textures are varied and true.

The architectural studies and interiors are not very remarkable. Mr. Deane, who has seceded to the old society, is missed, and Mr. Skinner Prout is not prolific. Yet 'Ypres' (67) has that inimitable quality of crumbling age which pertained to the drawings of the elder Prout. Also we may point to 'Salle d'Armes' (139), as in the happiest manner of Louis Haghe. We are likewise carried back to days long ago by C. Cattermole's 'Knights of Branksome' (134). The subject and the manner belong to old Cattermole, with this difference, that the drawing wants firmness: the armour-clad men are in danger of falling to pieces. Sadly wanting in force, too, are the ghosts of Egyptian temples as faintly shadowed forth by C. Vacher. Structures on the Nile when we knew them twenty years ago were remarkable for solidity and stability. Carl Werner is also on the wane; like his countryman Guido Bach he seems to have passed his zenith. Certainly, 'The Great Khan at Kennéh' (167) shows a falling away in strength and truth.

Flowers and fruits are nowhere better painted than in the Institute, indeed it may be said, that J. Sherrin is the best living representative of the late William Hunt: as witness 'Nest and Plum

Blossom,' (45) and 'The Branch of Plums' (231). Also in passing may be commended 'Flowers and Fruit,' (83) by Mrs. William Duffield and 'Clematis, Gladiolus, &c.' (105) by Fanny Harris.

The landscapes in the Institute may, like the figure-subjects, be divided into two schools, the artificial and the simple, the imaginative and the matter of fact. T. L. Rowbotham romances as heretofore about Italy, laying on blues and yellows mercilessly and madly. Mr. Leitch too on 'Ben Lomond' (155), reaches Byronic sublimity. 'North Sannox, Isle of Arran' (126), by Mr. Reed, is also a favourable example in a similar school. The style of Edward Hargitt if of less vigour retains more delicacy. 'Castle Eilan Donan, Loch Duich' (96), is a scene encompassed with atmosphere, light and colour. Mountain-regions are as a rule endowed with grandeur, massiveness, and gloom by the members of the Institute. Yet we regret to find that Mr. Edmund Warren has failed in his virtuous attempt to extend pictorial vision beyond beech woods to wide-stretching mountains and moorlands. 'Harvest time' (182), after his first manner, remains a success; on the contrary 'Killarney' (125), is confused and chaotic, and 'The Eagle's Nest Mountain' (68), on the same lake, is in a state which artists term rotten. But a painter possessed of Mr. Warren's proved talent need not feel discouraged. Let him try again. Only he must beware of excess of opaque colour and stipple touch. Mountains cannot be thus painted; the labour expended is misapplied and thrown away.

Rosa Bonheur, who heretofore has favoured the Institute, happens on the present occasion to be absent. Animal-painters are not in force. Mr. Shalders drives into the Gallery the self-same flock of sheep which time out of mind has found shelter on the premises. Yet a scene 'Near Petworth' (129), by this artist may be greeted as agreeable. R. Beavis distends in scale: 'Qui va là,' (86), is a large and important effort. This artist has talent, and yet his works bring disappointment; the horse and the rider who make themselves conspicuous in this room fail in effect only from want of study.

The Institute has of late years gathered strength from its newly elected associates, among whom T. Collier stands conspicuous, not by ostentation but by modest approach to nature. In a study on 'Eskdale Fells' (29), we are reminded of Cox and Whittaker: again in 'a Westerly Wind' (138), the transparent treatment is in happy contrast with the laboured opacity which for the most part prevails in the Institute. Mr. Collier in making a sketch or a study knows the point at which to leave off; he represents a style which now unfortunately is threatened with extinction. Mr. Mole has long gone in the opposite tack, 'Cockle Gatherers' (147), one of the artist's best products, is cooked to exhibition point. Also for pains-taking, without commensurate Art-result, may be commended, 'Aber Sands' (79), and some other small attempts by Mr. Orrock. Superior for breadth, power, and impressiveness is 'A Sand-pit' (44) by R. K. Penson. The treatment is quiet and sombre, and the picture has the merit,—for a merit by many it is accounted—of being made out of nothing. For some time past there has been a tendency towards low-toned pictures, a national reaction after the passion which previously prevailed for white paint. Mr. Fahey exhibits drawings in a half-shade and quiet monotone according to a style prevalent in the Dudley Gallery. 'The New Place, Pulborough,' (113) and 'Part of the Cappuccini Convent, Rome,' (142), are solemn and subdued; grey in the gloaming, at the hour when memories wake and nature seeks repose. Mr. Hine and Mr. D'Egville also dwell in tranquil moods; the former revives associations in the history of water-colour painting. 'Wilmington Holt, Sussex,' (164), is, in its delicious and transitional greens, quiet greys, and white chalk peeping through the mossy sward, a drawing not unworthy of Copley Fielding. In fine, the Institute, though not at its best, contains, as we have shown, a fair percentage of works which cannot fail to interest observers watchful of the changes which from time to time come over the essentially national Art of water-colour painting.

BRITISH ARTISTS:
THEIR STYLE AND CHARACTER.

WITH ENGRAVED ILLUSTRATIONS.

No. XCIX.—BIRKET FOSTER.

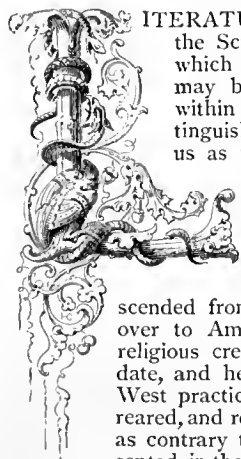

LITERATURE, in its almost infinity of phases, and the Sciences, in the numerous branches under which they may be classified, or into which they may be divided, are found to have included within their respective spheres not a few distinguished names of the community known among us as the Society of Friends, or Quakers. Art has achieved less success by their aid, though drawing and painting are recognised as accomplishments not expunged from their lawful canons. Benjamin West, who succeeded Reynolds as President of the Royal Academy, was descended from a family of "Friends" who either went over to America with William Penn, of the same religious creed, or followed him thither at an early date, and helped to form the State of Pennsylvania. West practically adhered to the faith in which he was reared, and refused to accept the honour of knighthood, as contrary to his principles. He is generally represented, in the portraits of him, habited in the costume universally worn by the males of the community in former times, but now nearly renounced by all but veteran members, or those of the "stricter sect,"—the broad-brimmed hat, long and loose coats with deep lappets, knee-breeches, and grey stockings. John Opie, also a member of the Royal Academy, was, if I am not mistaken, another artistic member of the Society of Friends; and there is more than one living painter—Jacob Thompson and Birket Foster, for example—who comes under the same category. I cannot call to mind any sculptor, living or dead, among them; but engraving has its representative—notably in William Miller, of Edinburgh, unquestionably one of the best landscape-engravers of our time.

BIRKET FOSTER was born on the 4th of February, 1825, at North Shields, as stated in a biographical work which has supplied me with much of the following personal narrative.* His parents were members of the Society of Friends, and they took rank, as did their ancestors for several generations, among the aristocracy of the community; one Sarah Forster,—as the name appears to have been originally written, and is now sometimes—who lived in 1701, married a descendant of Margaret Fell, of Swathmoor Hall, who, after the death of her first husband, Judge Fell, was united to George Fox, founder of the Quakers. The grandfather of Mr. Birket Foster went to sea when about eighteen years of age, and, after making three voyages to the West Indies, was appointed store-keeper in Antigua by some relatives settled there as merchants. In 1776 the young man entered on board an English vessel of war then fitting out at that place to cruise against American privateers. Two years afterwards he left the ship, at Spithead, and joined the *Defiance*, of sixty-four guns, from which he was transferred a few days afterwards to the *Jupiter*, of fifty guns, as master's mate. In October of the same year, the *Jupiter* engaged the *Triton*, a French ship of sixty-four guns; when the master of the English vessel was so severely wounded that he died the day following, and Robert Foster succeeded to his post. In 1779 he was appointed acting-lieutenant of the *Pelican*, of twenty-four guns. The young officer is said to have created quite a sensation in the Friends' meeting-house in Leicester, by his appearing there one Sunday in the uniform of his naval rank. He did not, however, remain long in the service after visiting his relatives, whose peace principles must have been somewhat scandalised by one of their order becoming a "man of war;" and they doubtless succeeded in weaning him from the profession, which he soon left. "A wonderful change," writes his son, "appears to have been wrought in this young officer. He became a man of peace, and in after-life avoided conversation about his naval career, and certainly never gloried in his former exploits;" his later years abounded with acts of love and mercy.

Southey appears to have made his acquaintance at one time; for he says in a characteristic letter to Richard Dupper, dated Feb. 23rd, 1806:—"Oh! Wordsworth sent me a man the other day, who was worth seeing; he looked like a first assassin in

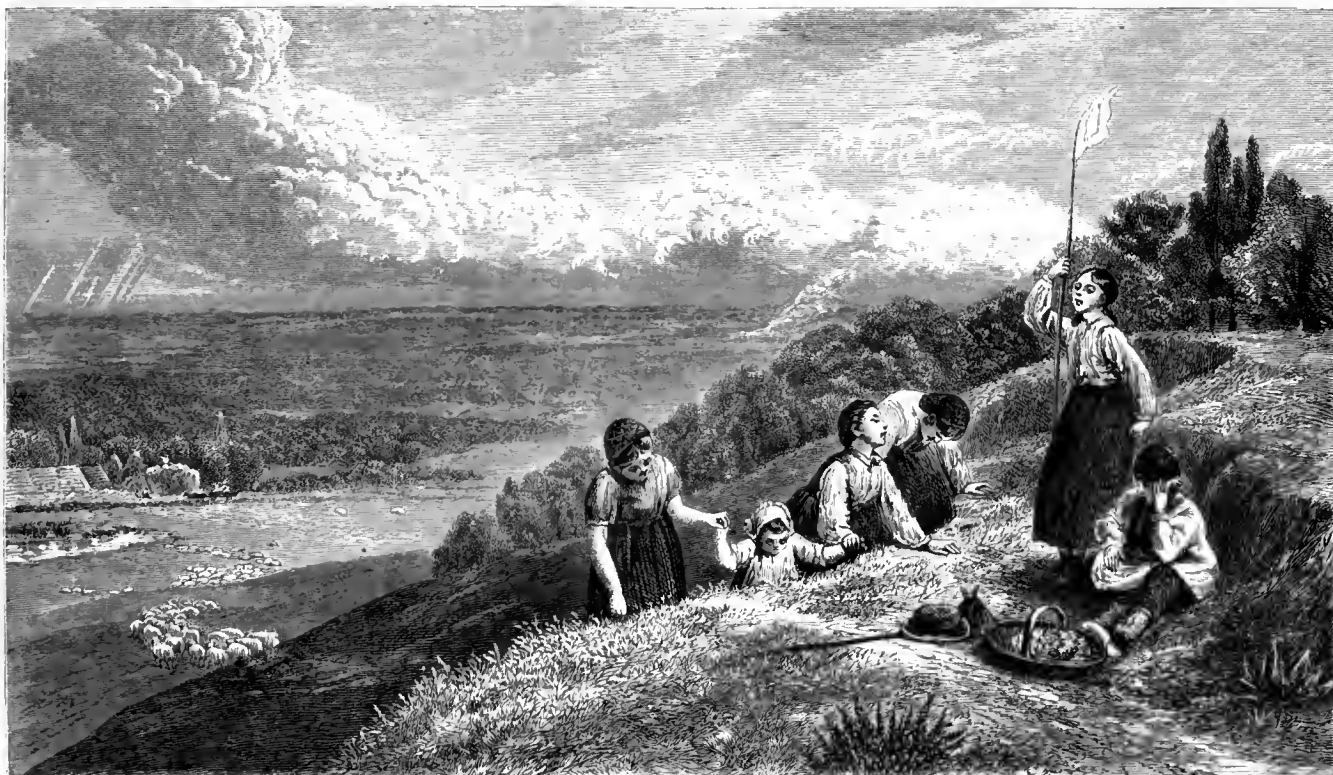

Drawn by W. J. Allen.]

“THE RACE UP—OUT OF BREATH.”

[Engraved by J. and G. P. Nicholls.

Macbeth, as to costume,—but he was a rare man. He had been a lieutenant in the navy; was scholar enough to quote Virgil aptly; had turned Quaker, or semi-Quaker, and was now a dealer in wool somewhere about twenty miles off. He had seen much, and thought much; his head was well-stored, and his heart in the right place.” He died, in 1827, much respected and regretted by those among whom he lived, having reached a good old age.

His son, Mr. Miles Birket Foster, left North Shields with his family for London, when the subject of this notice was about five

years of age, who had already given indications of a love of Art; it is a tradition in the family that the child Birket could draw before he could speak; and it is said that he made a clever copy of a tail-piece in Bewick's "Natural History" when only seven years old. It is assumed, and not without probability, that the local renown, and the tradition afloat in the north, regarding

* PHOTOGRAPHIC PORTRAITS OF MEN OF EMINENCE IN LITERATURE, SCIENCE, AND ART, With Biographical Memoirs. Edited by EDMUND WALFORD, M.A. Published by A. W. Bennett.

Bewick, who is generally recognised as the father of English wood-engraving, "influenced, in no small degree, the budding aspirations of his young copyist, who was destined in so distinguished a manner to render popular, and carry forward into greater perfection, at a future day, the Art which Bewick had first made familiar in England."

The first few years of the boy's life, after arriving in London, were, of course, devoted to ordinary education,—in a school at Tottenham, a locality in which the Friends still abound, more, perhaps, than in any other neighbourhood of the metropolis. The school was conducted by three ladies, who, among other accomplishments, possessed considerable knowledge of drawing; under their judicious instruction young Birket Foster, whose love of Art increased, rather than abated, with advancing years, made much progress. At the age of sixteen it was necessary for him to make choice of some business or profession: his desire was to become a landscape-painter, but his father, thinking that the career of an engraver offered more advantageous prospects, arranged with a seal-engraver of some eminence to take him as a pupil; but the sudden death of his intended master before the

contract was completed put an effectual stop to the project. In this extremity, the youth himself applied to Mr. Landells, the well-known wood-engraver, who had studied the Art under Bewick; and he agreed to accept him as pupil for a term of years. But his master had the discernment to find out in a short time that Birket Foster possessed the talents of an artist; and that, in the capacity of a draftsman on wood, he would render him more efficient service, while promoting his own interests, than in handling the tools of the engraver. Henceforth his pupil employed himself in designing, and drawing upon wood, and during the five years he remained with Mr. Landells he produced a very large number of subjects for wood-cuts; the earliest of which were for the volumes of Mr. and Mrs. S. C. Hall's "Ireland:" these were followed by many for the *Illustrated London News*, and other pictorial publications.

An accident which happened during one of his holiday-trips ere his apprenticeship had expired, threatened to deprive the public of the services of one who had already found much favour with the lovers of Art. While travelling in the Highlands the carriage occupied by him was unfortunately overturned; his right arm was

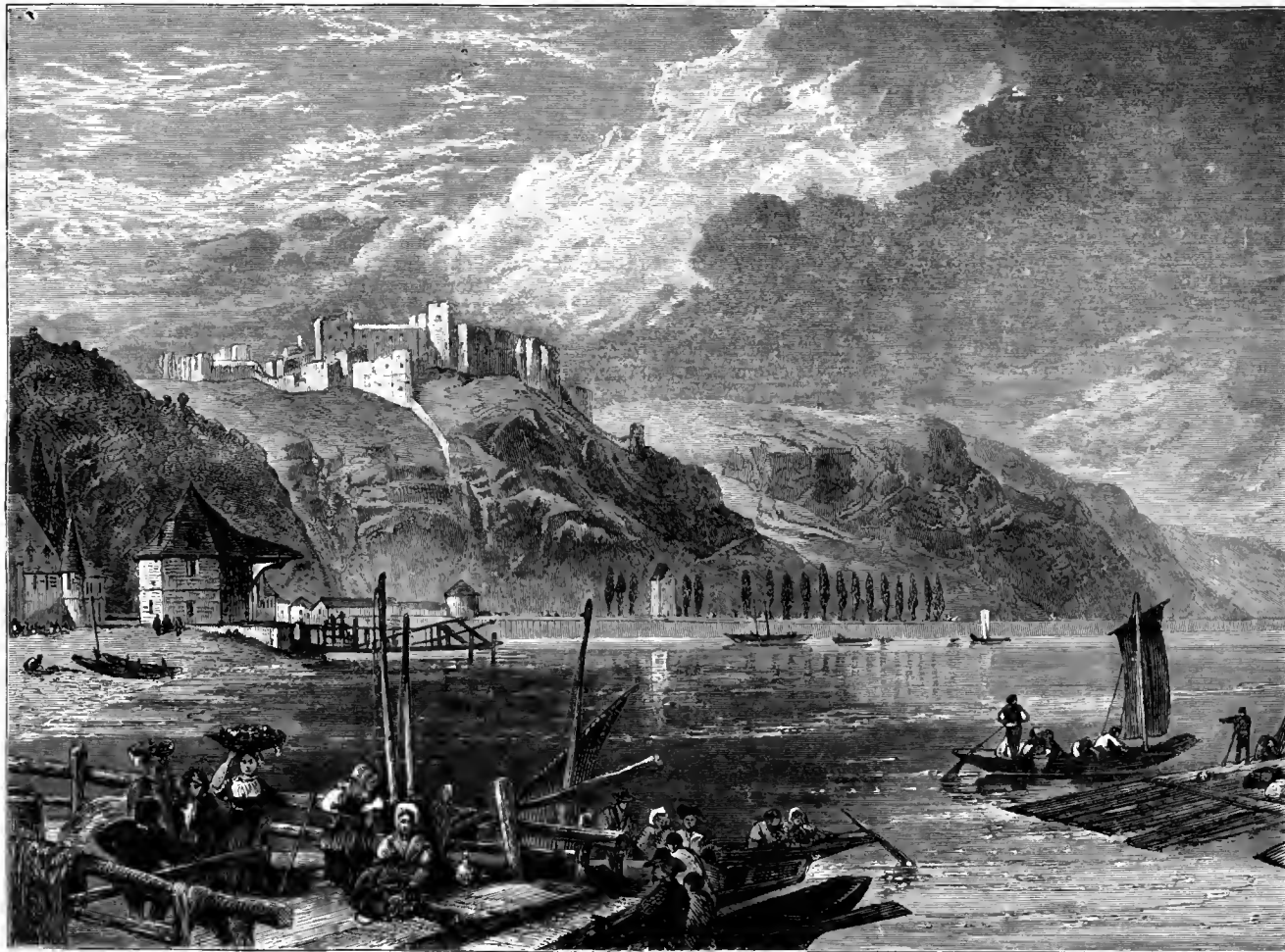

Drawn by W. J. Allen.]

CASTLE OF RHEINFELS, ST. GOAR—ON THE RHINE.

[Engraved by J. and G. P. Nicholls.

broken in two places, and he received some injury in the back. The use of the arm was, happily, restored in a comparatively short time; but for seven months he was confined to his bed or his couch by the other affliction. Grievous as this cessation from labour must have been, yet it afforded him opportunity for thought and mental study—to analyse his own ideas about Art, to ponder over his shortcomings, and to see in what way he could best advance his practice, when restored health and strength permitted him to use the pencil again. He has remarked with reference to this period of involuntary idleness, "that a season of entire rest from the practice of his own defects in Art, is a most beneficial time for an artist."

As soon as his term of apprenticeship had expired, and Mr. Birket Foster was free to work on his own account, his services were largely in demand by publishers of illustrated books, and he continued to draw for wood-engraving with the greatest success. In conjunction with Mr. John Gilbert and Miss Jane Benham, now Mrs. Benham Hay, he illustrated an edition of Longfellow's "Evangeline;" this became so great a favourite with the public

that he was employed the two following years upon drawings which may be counted by hundreds. The "Evangeline" was published in 1850, the year in which Mr. Foster made a beautiful drawing to illustrate one of the "Passages from the Poets," then being published in the *Art-Journal*: the subject is taken from Thomson's "Seasons," and is designated 'Morning.' In the enumeration of only a few of the books which his graceful pencil ornamented during the period between the appearance of the "Evangeline" and the year 1860, when he relinquished almost, if not quite, entirely the practice of drawing on wood, we may point out as the more prominent, Cowper's "Task," George Herbert's Poems, Goldsmith's Poems, Gray's "Elegy," Graham's "Sabbath," Wordsworth's Poems, and Beattie's "Minstrel." To these must be added the illustrations to "The Poets of the Nineteenth Century," to Campbell's "Pleasures of Hope," "Christmas with the Poets," "Pictures of English Landscape," "Old English Ballads," Coleridge's "Ancient Mariner," "Poetry of the Year," Warton's "The Hamlet." In these, and in a multitude of other works to which he contributed pictorial designs, one sees the poetry of the

writers carried by the artist to the perfection of sympathetic feeling and truthful representation.

Such works were, however, only the prelude to others of a far more important character, yet important only in another direction. In these exquisite little drawings upon blocks of wood which charmed everybody who saw them, the artist was training himself for a course of labour the public could not possibly have foreseen, and which ultimately surprised the world of Art-lovers. It was scarcely to be expected that Mr. Foster would rest content with the well-earned laurels he had won in his early practice; moreover, there must be a certain monotony—doubtless often found wearisome—in working upon wood with a single instrument—the black-lead pencil—from which an artist, conscious of his strength and ability, would naturally be disposed to extricate himself as soon as he could. Colour has greater charms than black and white, which may represent it, but are not adequate equivalents for its absence. In 1859 he sent to the exhibition of the Royal Academy a water-colour picture entitled 'A Farm—Arundel Park in the Distance.' In the following year he was elected Associate of the Water-colour Society, and exhibited some drawings the same year in the gallery of the Society. One of them, 'Feeding the Ducks,' received the following notice in our columns,—“We have observed

that if drawing upon wood leads to any power at all in painting, that power is characterised by originality. This drawing is very beautiful in its minute manipulation; every leaf of the willows is given, and every blade of grass at the brink of the pool has its place, and asserts its individuality, but effect is forgotten; when the drawing is removed from immediately before the eye, we feel that it wants force.” But this weakness was only the natural result of comparative inexperience in the use of colours, the full power of which can only result from knowledge acquired by practice and observation: and this Mr. Foster soon gained.

In 1861 he was elected a Member of the Water-colour Society, whose annual exhibitions have been enriched from that time with a multitude of pictures, of which it may be said generally, that English landscape has never been painted with purer feeling, greater truth, or a higher perception of the beauty of nature. And it is not alone in its charming realisations of scenery that the pencil of Birket Foster makes such a vivid and agreeable impression on the spectator; the rustic figures that give additional life to the landscape are just of that order which chimes in with all our associations of the country; children gathering primroses, or making bouquets of wild-flowers, catching minnows in the brook, romping in hay-fields, nutting, &c.; in fact, engaged in all the



Drawn by W. J. Allen.

SAILING THE BOAT.

[Engraved by J. and G. P. Nicholls.]

amusements and recreations indigenous to rural and sea-side life: the youngsters are assuredly his favourites, the elders, as a rule, he leaves to other hands; but it is impossible to look at any one of his works without a satisfying conviction that he is not only a diligent student of the peculiarities and varied beauties of English landscape, but an ardent lover of everything which appertains to it. We may point out among his more prominent works exhibited in the gallery of the Water-colour Society,—‘Holmwood Common;’ ‘The River Mole;’ ‘Feeding the Ducks;’ ‘The Race down Hill;’ ‘Warksburn, Northumberland;’ ‘On the Shore, Bonchurch;’ ‘The Lock—Evening;’ ‘The Ferry;’ ‘The Donkey-Ride;’ ‘The Kite;’ ‘Arundel Mill;’ ‘The Beach, Hastings;’ ‘The Swing;’ ‘To gather Kingcups in the Yellow Mead;’ ‘Bellario;’ ‘The Meet;’ ‘The Weald of Surrey;’ and ‘Primrose-Gatherers,’ a very charming drawing engraved as one of our large plates in last year’s volume. Recently Mr. Foster has directed his attention to oil-painting, and with a success that bids fair to ensure for his works in this medium as high a reputation as his water-colour pictures have attained. In the present exhibition of the Royal Academy hang two of his oil-paintings, ‘The Thames, near Eton,’ very beautiful in feeling and careful in execution, and ‘The Bass Rock.’

No greater proof of the popularity of this artist could be afforded

than is shown in the large number of chromo-lithographs of his works which have made their appearance. It is quite possible Mr. Foster would be better pleased to see them less numerous; still, he must accept this multiplicity of reproduction as a high compliment to his talents, inasmuch as it is significant of a desire on the part of those who are unable to purchase his original works to possess such copies as are within their reach: and some of these chromo-lithographs are so well executed that they convey no inadequate idea of the artist’s own handiwork. The estimation of his pictures formed by collectors is proved by the very large sums paid for them.

In the three examples here engraved we have a respective illustration of three almost distinct kinds of subject. ‘THE RACE UP’ may be accepted as a pure landscape, to which the children who have raced up to the high ground, and are ‘out of breath,’ give life and motion. The ancient ‘CASTLE OF RHEINFELS,’ towering above the town of St. Goar amid the glories of the Rhine, claims to be architectural in a degree, and is one of the few continental scenes delineated by Mr. Foster’s pencil; the drawing was kindly lent us by its owner, W. Quilter, Esq., of Norwood. ‘SAILING THE BOAT’—the property of James Jardine, Esq., of Alderley—is far more of a *genre* subject than a landscape.

JAMES DAFFORNE.

JAPANESE LITERATURE AND ART.*

THESE volumes come very opportunely to supplement, if such a term may be used, the series of interesting papers on Japanese Art, by Mr. J. Jackson Jarves, now appearing in our Journal. Till within a very few years little has been known of the inner life of the singular yet intelligent race—the inhabitants of Japan; and that little was gathered from sources which left comparatively untouched very much of a most interesting and instructive character: in fact, according to Mr. Mitford's report, every means were employed to keep foreigners in ignorance of the true history and social condition of the country. But "the recent revolution in Japan has wrought changes social as well as political; and it may be that when, in addition to the advance which has already been made, railways and telegraphs shall have connected the principal points of the Land of Sunrise, the old Japanese, such as he was and had been for centuries when we found him eleven short years ago, will have become extinct. It has appeared to me that no better means could be chosen of preserving a record of a curious and fast disappearing civilization, than the translation of some of the most interesting national legends and histories, together with other specimens of literature bearing upon the same subject."

The contents of the book may be summarised as familiar stories, fairy tales, stories about ghosts and superstitions, and Japanese theology set forth in sermons; of one of these last, Mr. Mitford took notes. But besides these subjects we find much information concerning Japanese society generally: as, for example, in his remarks descriptive of the first illustration introduced on this page,—'The Deputation of

Peasants' in their green rain-coats, and carrying sickles and bamboo-poles in their hands, assemble before the gate of their lord's palace at the capital, and represent their grievance, imploring the intercession of the retainers, and even of the womankind who may chance to go forth. Sometimes they pay for their temerity with their lives; but, at any rate, they have the satisfaction of bringing shame upon their persecutor, in the eyes of his neighbours and of the populace."



THE DEPUTATION OF PEASANTS AT THEIR LORD'S GATE.

Peasants.' The landlords of the country seem to have great power over their tenants, and can demand rents which are not due, or loans of money, repaying them when it suits their convenience. "But it too often happens that unjust and merciless lords do not repay such loans, but, on the contrary, press for further advances. Then it is that the farmers, dressed

in their green rain-coats, and carrying sickles and bamboo-poles in their hands, assemble before the gate of their lord's palace at the capital, and represent their grievance, imploring the intercession of the retainers, and even of the womankind who may chance to go forth. Sometimes they pay for their temerity with their lives; but, at any rate, they have the satisfaction of bringing shame upon their persecutor, in the eyes of his neighbours and of the populace." In the illustration, the lord is unquestionably disposed to turn a deaf ear to the appeal of his tenants, and to dismiss them summarily from his presence. The humour—amounting to caricature, though it is not so intended—of Japanese artists is manifest in this design; yet even more so in the next, which illustrates the story of 'The Eta Maiden and the Hatamoto.' The Etas are the most degraded caste of the Japanese; the Hatamotos rank as nobles. The story relates the loves of Genzaburō, one of the latter, and an Etan damsel. Genzaburō is described as a youth of "extraordinary personal beauty." Walking out one day, the thong of his sandal broke, and he stopped to have it repaired by a way-side cobbler. The work being done, he left to return home, when two wandering singing-girls, Etas, came over a bridge to speak to the cobbler; "one was a woman of some twenty years of age, and the other was a peerlessly beautiful girl of sixteen," whose personal attractions are described in detail



GENZABURO'S MEETING WITH THE ETA MAIDEN.

by the writer of the story, and of whom the handsome Genzaburō became desperately enamoured. Surely the force of caricature could go

no farther than in these specimens of Japanese portraiture. Similar illustrations abound in the volumes: "they were drawn," says Mr. Mitford, "in the first instance, by one Odaké, an artist in my employ, and were cut on wood by a famous wood-engraver at Yedo, and are therefore genuine specimens of Japanese Art."

These "Tales of Old Japan" possess a three-fold interest,—in the stories related, in the general information they supply, and in the examples of an art curious and original in its development. They are books to be inquired for by the novel-reader, as doubtless they are, and will long continue to be.

* TALES OF OLD JAPAN. By A. B. MITFORD, Second Secretary to the British Legation in Japan. With Illustrations drawn and cut on wood by Japanese artists. Two Vols. Published by MACMILLAN & Co.

A GENUINE ARTISTIC RACE.

PART IV.

I HAVE before me a bunch of tall bamboos sketched in india-ink, the aerial perspective being rendered by gradations in the tinting. The joints of the canes are simply interstices in the drawing, through which the delicate india-paper shows, while the leaves, all disconnected from the parent stalks, would tumble to the ground, were they real. No two of the indicating strokes are alike. A looser, freer manner of design could not be imagined. Yet each leaf has its own physiognomy; its physiology is perfect and action complete—alone, as in the mass. No Art could be more artless in execution or with less of what Pre-Raphaelites call truth of detail: and yet no individual has seen it but has involuntarily exclaimed "What a perfect study of nature!" In sparing himself the artist has spared the spectator, and still realised to him a real plant swaying in the breezy sunlight, free as nature, and imbued with the poetry of her growth.

This supreme facility of expression is as common in Japanese Art as is the reverse in ours. Immensely painstaking in the purpose of representing material substance, we are apt to be successful only in making a counterfeit and labelling it as one.

If that be the profoundest Art which suggests—not imitates—the most of a fact with the least perceptible effect, then the Japanese are our teachers. Our Art tends to destroy itself by fruitless rivalry with nature, just as Marsyas was slain by Apollo for his presumption in vying with a god. The gist of Art lies in going to nature, not to imitate, but to study her methods, facts, laws, and principles, by the help of which the artist should compose independent works by exercising an independent will, himself a *creator*.

We find this active principle in all sound Japanese work. Be the object a flower, insect, animal, bird, or reptile, a dragon or genii, a ghost or demi-god, it exists in virtue of the will and handicraft of the artist, who has acquired a dominion over nature by obeying her laws. Sagaciously comprehending his own position in respect to nature, he succeeds in making Art an organic force in civilisation, and a prophetic interpreter of human possibilities.

Japanese pictorial Art has a fragmentary aspect in the mass. It is better pleased with strong bits than whole pictures. These are, however, largely treated, although seldom put together so as to form perfect unity of composition designed in reference to a central idea and point of view. We are furnished with connected series of panoramic views, but each figure may stand independent of others. Thus they assume no perspective of converging lines; instead, flat surfaces, flat outlines, and flat tints. There is no *chiar-oscuro*, or modelling by gradations of light and shade. Yet by local massing of their colours, an adroit management of horizontal lines, and skilful zig-zag approaches, they contrive to lay out before us vast reaches of country and sea receding in the distance and expanding into space in the most natural manner. Moreover, they are clever in securing atmospherical tone, indicating the time of day or night, season, or state of the elements, by a nicely-graduated harmony of tinting. The local and transitory effect is enhanced by contrasts and combinations of positive brilliant colouring, such as the blossoms of trees and costumes of the period of the year afford. Snow-scenes, expanses of blue water, far-off mountains bounding wide intervals of lowland, valleys running sharply and tortuously into precipices, large flats of vegetation, with relative distances accentuated by living objects, bridges, boats, and villages, the whole having a high line of horizon illuminated by broad *strata* of varied warm lights, or broken by vapours which mystify the scene; all these features are so combined, varied, and balanced, as to merit the designation of a distinct school of landscape of charming refinement in all respects.

I am now looking at an extremely simple sketch: it is a mere tender wash of india-ink

representing the ocean with junks at anchor off a forest-clad point, under the shadow of which, embowered in orchards, nestles a small village, whose windows are aglow with inside lights. Distant hills darken the horizon on the right, over which the full moon pours its limpid rays, fusing the scene into a poetical indistinctness of shape and outline. Much of the indescribable delicacy is due to the quality of paper, which is unsurpassed in tone and texture for the nicest uses of Art.

The Japanese are not happy in abrupt heights, because their system of successive planes of horizon is adverse to such illusions. They are felicitous in storm effects, alternating torrents of rain, wind-driven over vast surfaces, with sparkle of sunbeams, or half disguising the scene in grey fog broken by tree and house-tops and ranges of hills; a vapoury moon or cloudy sun deepening the gloom, and episodes like the flicker of a bat's wing in the faint twilight, birds passing athwart the moon seen as fitting dark spots; men in the vagueness of night as phantoms abroad, oppositions of moonbeam and torch-light with magic twitter of shadow, volumes of rolling mists and abrupt disclosures of form and hues dissolving instantly in fresh obscurity; a dash of poetry in everything, and a keen choice of best aesthetic conditions: these form a part of their machinery to deepen the stress of the general motive.

It is noteworthy that the Japanese reverse the practice of our own scenic landscapists, who try to pass off general effects done in a superficial manner filled in with numerous accessories more accurately drawn. The Orientals add but sparsely minor objects to the general features, and either faintly suggest them, or carefully draw in a few well-chosen details, while relying in the main on the imagination of the spectator to spontaneously complete his work—an agreeable task, of which his European rival too frequently deprives us. They have also a charming manner of doing strictly conventional forms, like their waves and rocks, arising out of their absolute sincerity of work. The tone and spirit of the scene are sure to be largely manifested, free of any artistic conceit and legerdemain shirking of the true thing to gull the spectator's fancy. Personal idiosyncracies do not crowd out the legitimate feeling of the topic. Everywhere we notice frankness of means and fidelity to the motive. This absorption of the artist in his object communicates itself to the spectator. Be it merely a blade of grass, bit of vine, bunch of blossoms, jagged plantain leaf, shrub bowed by the wind dimly seen through a rain-gust, bird pluming itself or swooping on its prey; in short, whatever a natural object, under any of its conditions of existence—can do, that a Japanese draughtsman makes us perceive, with the liveliest action, thorough truth of design, and most telling characterisation, and, it should be added, with appropriate grace and beauty. Consummate Art like this can only spring from a corresponding sympathy, comprehension, and taste, in the people at large.

The aesthetic temperament of the nation is most felt in the use of colour. Design often is circumscribed by particular exigencies of the parent-motive apart from the purely artistic. But in dealing with colour the artist can employ it either as an accessory to form or wholly independent of it. He has only to consult its relation to his ideal conception as how best to oppose, balance, graduate, heighten, subdue, or tone its qualities in order to produce certain effects, which may be originated in his own mind or borrowed from natural objects. Viewed in a certain aspect, colour may be said to have an intellectual meaning responding to mental conditions, the manner of its use or enjoyment indicating spiritual, sensuous, or sensual proclivities of thought. Alone, all colours are morally negative, like notes of music. But there are tones in both which conform to states of mind. Purity, coldness, sensuality, and brightness of tints are significant terms, whose roots penetrate into the spiritual element of humanity—I would say religious, were it not that existing religions possess a large alloy of sensualism, founded on a mean dread of physical suffering, and an equally base hope of corporeal happiness. By spirituality in colour I mean the clearness and

harmony of simple unmixed tints, as shown in the sacred Art of Italy in its best estate, portraying, as with clairvoyant insight, the joy of the redeemed. Europe has passed from this psychological extreme to another of absolute materialism in Art, going through a colourless period, or one of barren intellectuality. These three are conditions representing mental phases rather than independent artistic periods, the fruit of passionate aesthetic temperaments, such as exist throughout the Orient, but profoundest in Japan. Here the love of colour resolves itself into a distinct faculty free of extraneous influences; never, however, soaring above refined sensuousness, although most delicate in its harmonies, and displaying a fulness of splendour unsurpassed anywhere. The Orientals solve problems of colour which, with our enfeebled senses, we never dare consider. Their combinations, oppositions, balancing of masses, fineness of gradations, breadth, variety, depth, directness, dexterity, boldness, knowledge of the secrets of nature, reliance of their own devices, heedless whether or not it makes the structural design itself play a secondary part, especially as concerns the human figure—a practice so contrary to the European,—all this is calculated to startle eyes accustomed to view the organic form as of primary importance in an aesthetic composition. At the same time, no people know better how to illustrate natural history and atmospherical phenomena. Their prints of birds, fishes, animals, plants, and insects possess an indisputable vivacity and verity of colouring and drawing. But the acme of their sentiment for colour is to be seen in those highly-decorated albums which reveal the mysteries of fashionable life in Japan.

Here is one printed on fine crape, the crimped texture helping out its tender tone and softness of surface, agreeably subduing tints which otherwise might seem too much accentuated. Invariably the first surprise is the intensity of the colours and the variety of the decorative designs which distinguish the awkward-fitting, cumbersome costumes of the ladies and gentlemen, with attendants only a shade more soberly attired. The designs in the dresses are chiefly taken from the gayest specimens of the animal and vegetable kingdoms, mostly birds and flowers, although geometrical arabesques and patterns not unlike those in Persian carpets and Cashmere shawls are common. They please themselves, too, with marked contrasts of drapery in the mass. Extreme depth of richest colouring—no toilette tints, thin and evanescent as hues of candies, but got direct by alchemy of their own fadeless dyeing, from flowers and feathers, whose sheen they rival—distributed so as to give equal repose and harmonious sparkle throughout; each figure a complete picture in itself, and in accord with its neighbours; the whole forming a tableau of richest effect, as might as many birds of Paradise or beds of blending and contrasting flowers: all this emphasised by backgrounds redolent with the perfume of pink blossoms, the sweetness of young grass, or elaborately decorated wall-screens and draperies of embroidered satins descending close to beautifully-tempered matings of uniform hues, but pitched in the same high key as the remainder of the picture; colour eloquent, sense exciting, like a grand overture to an opera; story and detail overborne by a passionate burst of harmony: such is the immediate impression of compositions made only to give vent to an ecstatic sensuous pleasure in colour.

Words are as futile to describe the effects of colour as of music. Some inkling of the Japanese methods is all one can hope to give. There is a delicate gradation to the bright tints which conventionally represent sky, water, land, or vegetation, which is very frank and genuine, recalling the best work of our mediæval miniaturists, all the more wonderful from being printed, and which put to blush our crude chromographs. Forms are outlined with structural correctness. The generic anatomy of plants and trees is largely and accurately indicated, the colours of fruits and blossoms being grouped like notes of music, to produce visual melody, while the sharper contrasts and profound oppositions in costumes serve to complete the likeness, as a whole, to a brilliant orchestral per-

formance. What we make of highest importance is the least to them. Besides being featureless and colourless, flat in drawing, monotonous in type, the human form serves only as a lay-figure to pose and dress to suit the artist's wishes; but, owing to his mastery over action, he endows it with abundant character. Inelegant and inaccurate in modelling, it expresses lively emotions, and supports accessories done with graphic truth. Look at the aged servant in livery on all fours, whose spine is used as a foot-stool by an elegant lady on tiptoe, stretching herself to her utmost to pluck some blossoms from an overhanging bough. The crimson blush of the flowers is surpassed by the deeper glow of the horizon behind green hills, which rise behind crystalline waters, while the deep blue, orange, and red patterns of vines and armorial designs or checkered figures in her rich purple dress are repeated in various, and equally splendid, colouring in the gala costumes of women menials: one of whom is holding up a beautiful tea-service of egg-shell porcelain, and the other presenting a visitor's card on a lacquer plate. As respects drawing, the upturned head of the old servant is all awry, but his firm-set lips, compressed eyes and nostrils, painful curve of back, and firm planting of wrists on the ground, showing violent tension of muscles, indicate, in naïve manner, the weight of his mistress, who, absorbed in her own action, regards him no more than if he were literally a bit of furniture. Her unsteadiness of balance is ludicrously perceptible, echoed in the half-alarmed and half-smiling watchful looks of the women, who evidently expect her to tumble. At first the brilliancy of colouring of the whole picture obscures the drollery and intensified action of the actors; but as soon as these delightful qualities are noticed, they form a sufficient compensation for defects in other particulars, and force the colouring to assume its relative position in the story.

The same album introduces us to musical soirées, literary and artistic reunions,—Japanese ladies, be it known, sketch and paint exceedingly well,—calls of etiquette, games, moon-lit walks, coteries of scandalmongers, whose finesse of pantomime is worthy of the best comic acting; tea-festivities, and the chivalric rescue of two ladies at night, attacked by an armed ruffian bribed by a rival to maltreat them; the whole forming an epitome of high-life in Japan. The short descriptive text is printed in the illustrated page in colour, and forms an ornamental detail in keeping with it. The artist further violates our rules by omitting all shadows. Whenever he attempts anything on our system, he loses the fascination of his own. We may smile on looking out of one of his brilliantly-lighted rooms—for example, that of the musical-party—into the dark night outside to see the blossoms on the trees as distinctly outlined and coloured as if the sun shone on them. But he is no fool for all this. He knows as well as any one how much of them he could see under the circumstances, but he wants us to know that the air of that room is filled with their fragrance. To the concert of sweet sounds he adds a concert of sweet odours, and doubles our sensuous imaginative enjoyment at the expense of an unimportant material fact. This is a duty of the artist founded on an æsthetic consciousness of a far higher quality than any possible fidelity of literal draughtsmanship. In the rescue-scene the branches of the tree partaking of the spirit of the spectacle look weird and threatening, and its blossoms gleam in the dark like the sinister eyes of an animal of prey. This sort of occult sympathy between the artist and nature is a striking feature in Japanese work.

Although the elementary principles and practice are so fundamentally sound, they belong to a primary stage of civilisation; right as far as they go, but not going far enough. We must admit they are successful in imparting that refined pleasure which is the end and aim of true Art. Two things they teach us: first, to see the selected fact characteristically always, and often beautifully even if it be not beautiful in choice; secondly, either to enter cordially and intelligently into its proper life, or by the cunning of an inventive will to transform it into another quite distinct from its native sphere.

No people more thoroughly understand the respective offices of Art and nature and where to draw the boundary between them. They fully comprehend that Art has an independent aim; that it exists in virtue of its own being, untrammelled by theories of ethics, political economy, or natural science; and that while it culls its principles and methods from nature, it has no call to be her servile imitator, or to defer to the prosaic requirements of a merely industrial existence. True, Japanese Art has never learned the use of shadow in relief, or to know that each positive colour is relatively dark or light to some other of a higher or lower shade of brightness with which it is placed in connection. Neither are they familiar with those subtle glazings and luminous gradations of mingled tints which give perfection to modelling in colour and spread a warm transparent atmosphere over a picture. But they excel in outlining and tinting spaces, matching them by the eye after nature, correct in general tone, and so opposed, as to imbue the scene with an aerial perspective and the proper sentiment of the season or hour. In this way we get an objective consciousness of a lowering day in winter, the air full of latent snow-flakes, or sparkling with bewildering sunlight; the warm haze or cloudless sky of summer; twilight mystery, starlit gloom of darkest night, cold rays of moon tripping over still waters; midnight welcome to weird visitors from the spirit-world, and the noisy tug of noontide life. Each and all of these conditions they make so clearly manifest as to cause one to pause before abjuring them to change a system which serves their Art so well for the technics which serve ours so indifferently. Ruskiu's axiom that no Art is vital and beautiful which does not represent the "facts of things," a vague phrase, but meaning I suppose their literal likeness, is often confuted by the Japanese; for they do produce much that is vitally beautiful without being an exact fact in nature. Carried to extremes this disposition furnishes the world with those ingeniously constructed mermaids which have puzzled prosaic brains and amused the imaginative. Their rule is not to imitate nature as a girl counts stitches in her worsted work, but to make the most of the impressions she leaves on the mind in the whole. Their artistic supremacy mainly rests on their ability to vary at will the forms and combinations of nature, and invent new.

This trait is particularly to be noted in that branch of Art over which they still reign as supreme as ever were the Greeks over the human form. In the several phases already reviewed there has been something which fell short of perfection; somewhat to qualify eulogium. But in Ornamental Art there are no drawbacks to complete satisfaction. All the commendation bestowed on other forms applies equally to it, and the exceptions carry no weight, because the articles are made without any imperative regard for natural truth, serviceableness, or illustration, but purely as things to cheer rather than instruct life, after the fashion of the Creator in the ordering of the warbling of a bird or of an opalescent sunset.

Greece alone offers anything like a parallel to the liberty given to Art in a very essential point in Japan. Swayed by its ethics, the immediate effect of the Reformation in Europe was to weaken and destroy Art. But after debarring it from those religious motives which had given it so powerful a hold in the human conscience, it was left to lead a domestic and dubious existence of too little significance any way to cause any alarm to the more austere principles which ruled the Protestant churches. Whilst no similar ascetic caution has obtained in Japan, its statecraft has been firm in hindering priestcraft from making Art an instrument of its specific ambitions. Too sagacious to attack Art itself, the rulers put no restrictions to its illustrating popular beliefs; but, after the policy of the old Greeks, required it to operate solely on its own æsthetic principles, independent of a dogmatic propagandism to the intent to control the civic destinies of men by lording it over their souls. There was no question about idolatry if the authority of the state was left intact. A like jealous watch was kept over all ecclesiastical functions. None of those monopolising, un-

assailable privileges in regard to burials, baptisms, marriages, and other rites, and even teachings, were permitted, by means of which, upheld by fears of sacrilege, the Roman Catholic clergy obtain such a dominion over their flocks as to endanger the secular authority whenever ideas and interests clash. Instead, the idolatry of Japan strengthens rather than weakens loyalty in the people. The genealogy of the deities and Mikados is one and the same. Legitimacy in the latter rested on their presumed sacred descent. Any attempt to disturb this tie between the emperors and the gods was nipped in the bud; how pitilessly and effectively, the extermination of the native converts to Romanism witnesses. Not to wholly lose their hold on the populace, the priests circumscribed their functions to such fêtes and ceremonies as would entertain the people and cause no alarm to the government. Hence one cause of the familiar treatment of the common deities and the pantheistic views of nature by all classes. In this way, bereft, it is true, of lofty spiritual motives, Art in Japan took a prominent part in social and religious life on the basis of affording pleasure to the people and being ruled solely by its own laws.

The wide-spread existence of this independent Art, despite the depressing and stagnating influences of the chief tenet of Buddha, shows how profoundly it enters into the daily life of the population. When we consider the infinite variety, perfection, and originality of their ornamental objects, their *unserviceableness* as opposed to the principle of homely utility, which is the basis of similar things elsewhere, we must acknowledge that the Japanese are the only thoroughly artistic people now living. Europe is too much hampered by its industrial code and prosaic notions to invent purely æsthetic designs and forms. Her taste is either distorted by trade-calculations, chilled by the public indifference to beauty, or coolly set aside by the one-sided common-sense theory of political economy. With us houses are *furnished*; that is, furniture is absolute in domestic life. We require a multitude of convenient and luxurious objects, produced by machinery, each workman the lifelong slave of a single fraction of a mechanical whole, the perfection of which consists in its cheap production and exact resemblance to numberless similar wholes; a system of labour which deadens the mental faculties, power of enjoyment, and manual capacity of the worker, and effectually hinders any wholesome development of taste in the buyer.*

J. JACKSON JARVES.

VISITS TO THE STUDIOS OF ROME.

CERTAIN parts of Rome seem devoted to Art, large blocks of building furnishing here nests, as it were, of studios, story above story, where the artist arrives earlier or later in the morning, working till afternoon and receiving visitors—a practice which, were it not the habit of their lives thus to divide their time, would be a serious interruption to work and quiet thought. But it is the custom of the place; and, indeed, considering that there are no important public exhibitions here, no galleries in which works of Art, as they are completed, can be brought under the eye of the many strangers who visit Rome during the winter, and who are the principal purchasers of these works, it is perhaps the best means that can be adopted to make them familiar to the public, or to bring them under the eye of those willing and able to purchase them.

In the localities whereof we speak, which seem peculiarly to be the gathering points of Art, we find ourselves in the midst of sculptors and painters, men and women of various nations—English, American, German, French, Scandinavian, and Italian. For instance, the neighbourhood of the Piazza Barberini is one of these, behind which lie a little group of streets—the Nicolo da Tolentino, the Via di San Basilio, and others, full of studios.

* To be concluded in our next.

Let us first visit that of Mr. Healy, the well-known clever American portrait-painter. Here we find life-size portraits of Longfellow and his young golden-haired daughter: a fine portrait of Abraham Lincoln, seated; Liszt, the composer, in his priestly garb, seated at the piano; the American Generals Sherman and Sheridan, with numerous handsome ladies and lovely children.

And here let us remark that, as we have said before, these daily visits, being the order of artistic life, bring you agreeably acquainted with the artist himself, who may and probably will receive you, with his brush and palette or his modelling stick in hand, in some appropriate and often picturesque costume, whereby he often forms a very striking feature in his own studio. But to proceed.

Our next visit shall be to the studio of Mr. Story, who, like the great masters of old, embodies in his own person the author and the poet with that of the sculptor. He is also to be found in the same quarter. Mr. Story is already well known in England from his 'Cleopatra' and his 'Libyan Sibyl,' which, exhibited there in the International Exhibition of 1862, became the property of Mr. Morrison. The various rooms of his studio are full of works of great beauty and power. Of these we may simply enumerate in marble 'Dalilah,' 'Medea,' 'Sappho,' and a beautiful fully-draped 'Vesta,' intended to embody his idea of the domestic virtues; a copy of the 'Cleopatra' in marble and also of the 'Libyan Sibyl.' In the inner sanctuary is his greatest and most powerful work, in clay, the last touches to which are now being given. This is one of his first allegorical statues—'Jerusalem in Desolation, from the First Chapter of the Lamentations.' Jerusalem sits as a solitary widow, yet all the beauty hath not departed from her. See the pathos of her deeply-speaking eyes, which have wept so much, and of her mournful mouth, which silently utters to you as you gaze on her—"Behold, and see if there be any sorrow like unto my sorrow." She sits a beautiful and grand draped figure on a broken wall—a very wailing place—the philactery round her brows, with no other ornament on her person, the plastic clay having as yet to receive on the hem of her garments the mystic bells and pomegranates.

Turning into the studio of the deceased Tenerani, who scarcely more than twelve months ago was considered one of the leaders of the Italian school of sculpture, we find duplicate copies in marble of his 'Psyche swooning away after the Fatal Gift of Proserpine;' a group of little figures representing various occupations—Agriculture, Commerce, Fishing, and Hunting—all in marble. Two colossal statues, casts afterwards executed in marble, of Ferdinand II.; also a cast of the 'Angel of the Resurrection'—a magnificent figure, which was executed by him, in marble, for the Church of S. Maria sopra Minerva.

Mr. Ball, a young English sculptor, has been fortunate in receiving the patronage of Miss Burdett Coutts, though as yet none of his designs executed for her are in London. He has just finished the design of a large panel-decoration, in *bas-relief*, for an entrance-hall, the subject of which may have been suggested by Shakespere's words:—

"There is a tide in the affairs of men,
Which, taken at the full, leads on to fortune;
Omitted, all the sequel of our lives
Is bound in shallows and in miseries."

His exemplification of which is one figure grasping opportunity, while another, fast asleep, loses it.

In the studio of Mr. Macdonald, from his age and standing one of the chief British sculptors in Rome, may be seen casts—all of which have been executed in marble—of no fewer than 400 busts, chiefly of the English nobility. His son, Mr. Alexander Macdonald, now working in his father's studio, has a 'Neapolitan Fisherman,' a spirited conception; and 'Æneas bearing his Father Anchises on his Shoulders,' in plaster; with a graceful 'Hebe and Eagle,' in marble, the lady pouring nectar into a cup. He is now modelling in clay a huntress caressing a greyhound which has just laid a dead hare at her feet. He is also copying, in marble, his father's

busts of the late Duke, and the present Duchess Dowager, of Northumberland, for the latter, who spent last winter in Rome.

As Mr. Macdonald is one of the patriarchs of British Art in Rome, so is Herr Wolff that of the German. He has been a resident here for eight-and-forty years, and, once the pupil of Thorwaldsen, is now the vice-president of the Academy of St. Luke. The various apartments of his studio are full of his works, several in marble, and many the casts of sculpture long since executed. Of these we may mention, 'The Meeting of the Daughter of Jephthah with her Father;' busts of Prince Albert before and after his marriage; of the Crown Princess of Prussia, as a baby, done by Herr Wolff at Windsor; of Bunsen, and Sir Fowell Buxton.

Herr Wolff is, at the present time, engaged in modelling a statue of 'Day,' which is to be accompanied by 'Night' as a shrouded female figure. His groups of the 'Seasons,' represented by children; and his 'Silent Love,'—Cupid with his finger to his lips—are noteworthy. Also is a 'Wounded Amazon,' as being the work of a young Greek, a pupil of Herr Wolff's, now returned to Athens, where, let us hope, in the midst of its mountains of marble, a new era of Art may eventually recommence not unworthy of the land of Phidias.

Before quitting the Barberini quarter of Rome, we would mention the studio of Mr. Tilton, its walls hung with glowing Italian landscapes, temples in Sicily, picturesque fishing-boats at Venice; and enriched with a portfolio of Egyptian sketches of great beauty and fidelity, his work this winter on the Nile.

Miss Edmonia-Lewis, a coloured lady—partly of negro, partly of Indian parentage—who, after devoting herself to the plastic art for seven years, and producing various groups and busts, among others an excellent likeness of Charlotte Cushman, has met with great encouragement in America through her little Indian groups, illustrative of Hiawatha.

Walter Runeberg, the son of a great living Scandinavian poet, and regarded by Finland as her best sculptor, is engaged on a group of 'Psyche led by Zephyrs.' He represents her without wings, as being human, not divine, at the moment when left alone by her parents on the mount, she is rescued by the zephyrs—boyish figures—one of whom holds her hand, and, with a hopeful, joyous glance into her beautiful but wistful face, encourages her forward; the other, stooping, gently tries to move her reluctant foot. His 'Sleeping Cupid,' in marble, is an embodiment of pure innocent love in an unconscious state.

Miss Whitney, an American sculptor, has just completed, in marble, a small seated allegorical figure, representing Rome. *Roma*, an aged woman of a large heroic type, sits by the wayside and begs: her drooping head inclines eagerly forward, her open palms rest on her knee soliciting alms, her ample drapery is ragged on the edge with long wear, but it still bears tracery of the rich embroidery of its hem, as her countenance also bears the stamp of the illustrious race from which she sprang. Altogether the figure is noble and beautiful. This statuette has been sent to London, where it may probably be seen on its way to America.

Passing along the Via Felice we come to Mr. Coleman's studio, where he has lately had an exhibition of his pictures, together with those of his son. This gentleman has already obtained a reputation for his faithful and spirited delineations of animals, such as the buffaloes and the wild cattle of the Campagna. On this occasion the pictures amounted probably to fifty, several of which we were glad to see marked as sold.

A little farther on we visit the studio of Mr. Freeman, one of the oldest American *genre*-painters of Rome. Among his other pictures we may mention his 'Recording Angel,' and 'The Duchess,' a peasant-girl, one of Nature's nobility. Under the same roof is the studio of his wife, who is justly celebrated for her modelling of children. She is engaged at this moment in designing an elegant fender, to be cast in bronze, in which the Lares and Penates of domestic life are represented by charming life-like children, who denote by musical instru-

ments, palette or other symbol, the pursuits which beautify a home.

Mr. Rinehart, in the Via Sistina, one of the rising American sculptors in this focus of Art, and who wars against the Milan school, which loves to employ marble for the representation of lace and delicate veils, rather than the beautiful or the stern and strong realities of the human form, has just finished his vigorous colossal statue of Chief Justice Taney; to be sent to Baltimore. His 'Woman of Samaria' and his 'Sleeping Children' are worthy of his reputation.

His near neighbour, the highly-promising young English sculptor, Mr. Warrington Wood, has a beautiful group, in marble, entitled 'The Sisters of Bethany.' Martha is saying to her sister, "The Master is come and calleth for thee," the joy of which intelligence awakens Mary out of her sorrow, and we see her about to arise and hasten to Him. Mr. Wood has now, after executing several sacred groups, turned his attention to classical subjects, and is modelling a 'Hector and Helen.' She, a beautiful Greek, in the act of unbuckling his sword, is gazing upwards to him, while his thoughts are evidently far away. The group is at present under life-size, but the artist intends another year very properly to re-model it in heroic style, after which he will proceed to put it into marble.

Descending from the Pincian Hill into the neighbourhood of the Piazza di Spagna, we may visit the studios of various well-known painters. First, that of Mr. Penry Williams, who has for so many years carried Italy into England, by means of his elegant pictures of Italian peasants on the Campagna, by way-side shrines, or on the shores of the Mediterranean. Here we find on his easel a picture just executed for Mr. Sandbach, the friend and patron of Gibson, depicting Neapolitan peasants resting at noon on a pilgrimage. A woman holds a merry dancing child by the hand, a second plays upon a tambourine, while the father rests against an olive-tree, after a simple repast, the remains of which are seen in the foreground—golden oranges, and red wine in clear globular bottles, which are corked Italian fashion with a twisted vine-leaf.

Mr. Arthur Strutt has just sent a portfolio of sketches of Roman and Neapolitan scenery to England for Lady Crossley, of Halifax. They are also to be seen on canvas in the studio of Herr Corrodj and his sons; of Herr Lindermann Frommel, where we must stop to notice his large picture of the Greek temples at Paestum, standing forth grand and melancholy against a sunset of torn crimson and golden clouds; of the admirable Italian painter, Signor Vertunni, whose beautiful *atelier* is enriched with landscapes of the highest class.

Signor Vertunni occupies one of a group of studios in the Via Margutta, a region which, of all others in Rome, is perhaps most devoted to Art. In this same block of building, among others, are those of Signor Marianecci, well deserving much commendation through his services to the Arundel Society; Mr. Buchanan Read, Miss Foley. Mr. Randolph Rogers, and that of the late Mr. Mozier, where Mr. Harnisch, a young American sculptor, who has met with considerable success during an unprecedentedly bad season for artists, is now working.

Mr. Buchanan Read is equally a portrait-painter and a delineator of poetic subjects, and in either department is rapid and effective. His studio at the present moment contains of the latter class, 'The Angel of Good Tidings appearing to the Shepherds of Bethlehem,' 'The Dream of Abou Ben Hassan,' and 'Will o' the Wisp,' a new representation of this impish sprite, as a beautiful star-lit maiden. The portrait most noteworthy is, perhaps, that of General Sheridan, seated on his war-horse, flying along on his famous ride which won a battle for the Northern States, and inspired Mr. Buchanan Read, who is also a poet, to write a war-ode, which is an excellent pendant to his picture.

Mr. Rogers, celebrated for his 'Blind Girl of Pompeii' and other meritorious works, has just sent off his fourth great President Lincoln monument to Munich to be cast.

Miss Foley is deservedly known for her medallion-portraits, which are modelled not only with fidelity, but with great taste, purity, and tenderness. But she does not confine herself to this class of subjects. Her model for a fountain, of three children under the shade of acanthus rising from the centre of the basin, filled with water-plants, is fresh and extremely elegant. We are glad to learn that this graceful design will, in all probability, be executed in bronze for some purpose not yet specified. A statue of a boy and kid, the boy carrying a vine branch on his shoulder, which the playful animal is attempting to rob of its leaves, is a pleasing group. Besides these we find a head and bust of Cleopatra, and a large head for a statue of Jeremiah, grand and melancholy. The burden of the affliction of his people is upon him, and the whole countenance is stamped by the greatness of his woe. This is the only portion as yet completed of four statues of the great prophets Isaiah, Daniel, Ezekiel, and Jeremiah, which this lady intends to produce, if a commission for so grand an undertaking were given. Let us hope, therefore, that some of the Protestant churches, about to be erected or opened, in the new order of things, within the walls of Rome, will not deem it an anomaly to introduce into their new places of worship in this city of Art such decorations.

Miss Florence Freeman has had a reception at her studio, also in the Via Margutta, when she exhibited several excellent works of Art, especially a clever and well-executed design for a fire-place—children bringing in the Yule-log.

Miss Hosmer's celebrated studio, in the same street, may probably be opened to the public next month, when, with those of Mr. Welsch and others, we hope to pay it the attention it deserves.

Signor Rosetti is busily employed.

Mr. H. Cardwell, an English sculptor, has been one of the many sufferers by the dreadful inundation in the Christmas week of 1870. The waters rose many feet in his studio, which is near the Tiber. He himself escaped by a ladder, but his creations were unavoidably left to the mercy of the flood, which completely destroyed his sketches, broke and covered his casts with mud, and possessed force sufficient to float his marble busts, 'A Roman Girl, from Memory,' and others, from their pedestals. His fine group of 'The Good Samaritan,' in plaster, was dashed down and broken in several pieces. The studio, in which large fires are kept constantly burning, is again restored to a certain degree of order. 'The Good Samaritan' renews his merciful offices to the wayfarer man who fell among thieves. Master Crichtley, a lad in Highland costume, sits with his faithful dog by his side, perfectly spotless, as if he had never been engulfed in the muddy seething waters; and 'The Wounded Stag,' 'The Greyhounds at Play,' and 'The Hunter,' who is blowing his horn at the death—three wonderfully-living groups in bronze—are also scathless.

ART-UNION OF LONDON.

THE Report read at the thirty-fifth annual meeting of the Society, on the 25th of April, shows a small diminution in the number of subscribers during the year. This is possibly attributable to the general unsettled state of political and commercial affairs consequent on the war in France, which, originating with opposing nations, seems now to have become a protracted internecine strife, fatal to the land wherein it rages.

We have no space, so many subjects are pressing upon our pages this month, to give any detailed notice of the various topics mentioned in the Report; we find, however, the receipts and expenditure of the year to be:—

Amount of subscriptions.....	£10,171	7	0
Allotted for prizes	£5,040	0	0
For print of the year, almanack, report, &c., and reserve	2,681	2	10
		7,721	2
Agents, commission, and charges, adver- tisements, postage, &c.....	2,450	4	2
		£10,171	7

The sum available for the purchase of works of Art was thus allotted:—22 works at £10 each; 20 at £15 each; 13 at £20 each; 12 at £25 each; 10 at £30 each; 10 at £35 each; 6 at £40 each; 6 at £45 each; 4 at £50 each; 3 at £60 each; 2 at £75 each; 2 at £100 each; 2 at £150 each; 1 work at £200. There were distributed: 10 bronze vases; 300 chromolithographs of 'Bellagio,' after Birket Foster; 150 chromolithographs, 'Kite-flying,' also from a drawing by the same artist; 100 busts of the Princess Louise; 30 silver medals of C. R. Leslie, R.A. Thus, with the parian busts given to all who have subscribed for ten years consecutively without gaining a prize, the total number of prizes was 853, in addition to the engraving given to every member.

There have been since the last annual meeting some changes in the governing body of the Society. The death of Dr. Alford, Dean of Canterbury, created a vacancy in the list of vice-presidents: this has been filled by the election of Dr. Stanley, Dean of Westminster. The death of Mr. T. G. Sambrooke, and the retirement of Alderman Wilson and Mr. J. Henderson, left three vacancies in the council: two of these have been supplied by the nomination of Messrs. C. J. Leaf and R. N. Wornum.

At the drawing for the prizes, that of the value of £200 fell to Mr. H. Stewart, of Hendon; those of £150 each respectively to Mr. W. Reeve, Douglas Street, Vincent Square, and Mr. F. L. James, of Yokohama; those of £100 each to Mrs. Bushby, Oxford Street, and Mr. R. J. Hodgson, Gray's Inn Road; and those of £75 each to Captain Lawrence, Great St. Helens, and Mr. J. Nobes, of Merton. As on former occasions, so also on this, it is interesting to see how British Art, by means of the Art-Union of London, finds its way into almost every quarter of the world, however remote. One of the great prizes, as just stated, goes to Yokohama; others will have to be transmitted to a variety of places in the United States and Canada, to Port Madoc, Geelong, Adelaide, Melbourne, Porto Rico, Port Elizabeth, Victoria, 'Christiania, Smyrna, Bangalore, Barcelona, Peru, Constantinople, Canterbury, N.Z., Ballarat, &c., &c.

SELECTED PICTURES.

FROM THE PICTURE IN THE POSSESSION OF THE PUBLISHERS.

THE CHILDREN'S OFFERING. =

Gabe, Painter.

S. S. Smith, Engraver.

THIS is the work of a foreign painter, concerning whom we have been quite unable to glean any tidings, except to learn that he is not now living. There is evidence of much true taste and poetic feeling in this simple composition: seated on the shaft of a large fluted column, which, with the massive Corinthian capital, might have been, in long past ages, a portion of a magnificent temple, is a young girl who has woven a chaplet of flowers to do honour to the Virgin, whose figure, it may be supposed, is visible in the wayside cross. Her brother, a juvenile *pifferaro* of the genuine Savoyard type, is playing a hymn on his shrill pipe, while his companion seems to be silently uttering an *Ave Maria*. We have often seen what may be called "wayside devotion" treated by painters of most countries, but never more pleasantly and poetically than we find it here; and certainly, never with so great originality: even the grand fragments of old architecture are made striking accessories in the composition.

The picture, as the manner in which it is engraved shows, is painted in a broad and somewhat dashing manner: it is very rich in colour; the warm hues of an Italian evening being heightened by the brilliant tints of the groups of flowers.

THE WORKS OF OLD MASTERS EXHIBITED BY THE BURLINGTON FINE ARTS CLUB.

AN interesting and valuable contribution to the season's exhibitions has been made by the Burlington Fine Arts Club, at their house in Saville Row. The catalogue numbers only eighty-two pictures, which represent certain schools as satisfactorily as can be expected by a collection so limited. The contributors are, the Marquis of Westminster, Lady Eastlake, Mr. Seymour Haden, Mr. Wynn Ellis, Mr. H. Vaughan, Mr. Alexander Barker, Mr. Alfred Morrison, &c. At the west end of the gallery hangs a well-known 'Holy Family,' by Raffaele, from the Westminster collection, which it would have been desirable to see hung lower and better lighted. Below this is a very remarkable work, by Giovanni Bellini, called 'The Virgin and Child surrounded by Four Saints with the Donator,' a fine example of both the labour and the spirit of that early period. Another 'Virgin and Child with St. Catherine,' by Van Dyck, suggests a course of thought entirely different from the promptings of the two just mentioned. It would almost seem by the rich *impasto* of the child, that Rubens had worked on this picture; the St. Catherine is that lady whom we all know so well as prominent in Rubens' large pictures in the National Gallery.

By Rembrandt are two admirable figures—'Portrait of a Man with a Hawk' and 'Portrait of a Lady with a Fan,' in reference to which, and to the works of Rembrandt generally, we suggest that the word *portrait* be entirely dismissed in cases where the names of the persons represented are unknown, because the exalted pictorial qualities of these works remove them beyond the pale of portraiture. Between these pictures is a noble 'Landscape—Cleves in the distance,' by P. de Koning; and facing that is the yet grander 'Hay-Wain,' by Constable, for which he received the French gold medal in 1825.

Apropos of wooded scenery, is by rare Mindert Hobbema 'A Forest-Scene,' the figures by John Linglebach; also a 'Forest-Scene, with Cottages,' produced under the same bond of partnership. Consorting with these are two pictures by Old Crome, who is not sufficiently esteemed as one of the originators of our school.

We turn to a 'Landscape—Morning—Shepherds with their Flocks,' by Claude Lorraine, a grand composition, which he committed a grave error in associating with anything pastoral—the material being epic. Other works by Claude are, 'Landscape,' 'The Israelites worshipping the Golden Calf,' 'Landscape—Evening,' 'The Decline of the Roman Empire,' &c. A 'Portrait of Lady Ormonde and Child,' by Sir Joshua Reynolds, is a charming group; and let us hasten to signalise the fact, in admirable preservation. But more brilliant than this is 'Henrietta, Countess of Grosvenor,' by Gainsborough, not unworthy of being esteemed perhaps the brightest gem in Gainsborough's starry diadem. In the gallery also are 'St. Mark' and 'St. Sebastian,' by Giovanni Battista Cima; 'Virgin and Child,' Van Eyck; a 'Holy Family,' Paul Veronese; 'St. John with the Lamb,' Murillo; 'Two Boy-Angels,' and 'The Dismissal of Hagar,' Rubens; 'The Distressed Poet,' Hogarth; 'Landscape with Cattle,' and 'Horses and Dog,' Cuypp; 'An Interior,' Gerard Douw; 'The Mouth of the Thames,' Turner, &c. In one of the other rooms are two portraits by Reynolds—the somewhat undignified likeness of Colonel Tarleton, and that of Mrs. Matthews; the draperies of which are very carefully painted, and do not look like Sir Joshua's work. By Guido, is 'The Daughter of Herodias,' a pale, sibil-like head and bust, with the head of the Baptist in the charger. The selection is not without instances of the curiosities of Art, as 'The Five Wise Virgins' and 'The Five Foolish Virgins,' by Carmona, as also other examples of different schools and periods by Lorenzo di Credi, Canaletti, Berghem, Prout, Nasmyth, Botticelli (several very interesting, and in excellent condition), Raeburn, Poussin, &c. So choice are the pictures generally that they constitute the selection a desirable study.





THE WORKS OF MADAME
JERICHAU.

THE paintings of this lady command attention, as they are marked by characteristics which are by no means common to woman's work. They are exhibited at 142, New Bond Street, and are few in number. A single glance at them, nay, even at one of them, teaches us that Madame Jerichau thinks and moves only in obedience to the purest strain of academic inspiration. The high and low life of her country, Denmark, are as rich in social situations and picturesque costume as those of any other European nation; but she does not yield to fascinations against which the majority of female artists are not proof. We do not therefore find any of the common episodes of social life—no allusions to tender relations between the sexes—little to stir the emotions in sympathetic accord with distress, or touch the heart by a narrative of affliction. This lady is impelled upwards into the epic vein by her tastes and feelings, and, at the same time, is more pronouncedly ethnological than perhaps any artist of the day. There is, however, one tie which her woman's heart acknowledges, and that is a love of children; at least we thus read the many studies she has so successfully endowed with the natural graces of childhood. Notwithstanding, however, the element that gives a masculine quality to Madame Jerichau's works, there are yet examples which show us she has the power of working up to the utmost refinement of feminine beauty. We instance her portrait of the Queen of Greece, wherein appear the utmost delicacy of treatment and brilliancy of colour. It is a head and bust, very simple and without any type of royalty, but so entirely different from all else around it, that its execution would never be assigned to the same hand as the others.

The most important of this lady's works, as seen here, is a design for a large oil-picture, or fresco. It is called 'The Valkyrie,' and is founded on one of the wild legends of the Norse mythology. The Valkyries were the tutelary spirits of the Norse warriors, each of whom was attended in battle by a Valkyrie, who, although invisible during the conflict, was constantly by his side, prepared to transport him to Valhalla the moment he fell, and there to act as his cup-bearer for ever. The cartoon represents a battle-scene, with Valkyries mounted on horses wild and weird, and well-befitting such a scene and such a story. The drawing is wonderfully spirited, and the composition would tell powerfully as a fresco. 'The Favourite of the Harem,' an oil-picture, declares itself at once a veritable study from Oriental life. All attempts at the improvisation of Harem beauty by painters and poets have been very wide of the truth, as we learn from this and all other genuine representations of so-called eastern beauty. There are several pictures of eastern women: what is most valuable in them is their indisputable nationality, which is brought forward without any modification or dalliance with conventional prettiness of feature. The subjects principally are of the size of life. 'La Penserosa,' a tambourine-girl of Italian characteristics, is resting in a reflective attitude, which, together with the expression of the face, sustains well the title. 'Homeless,' another single figure, shows a girl exposed to the inclemency of the winter sky; and the diverse and appropriate language of the features in these two pictures is the result of study in that direction which yields the veritable triumphs of painting. Again 'Helena, a young maiden from Hymetos,' affords evidence of independent thought. In this figure the artist might have yielded to the fascinations of the Greek facial line supported by classic and Academic authority, but she proposes nothing less than a Helen of a type distinctly modern and individual. In the background is the eastern side of the Acropolis, and one of the thirteen pillars of the temple of Jupiter. There are also one or two female studies of Fellaheen, in which truth and genuine nationality prevail over poets' dreams of matchless hours and peerless Egyptian maids. But Madame Jerichau's love of children as shown in her works is remarkable—she

paints them as she loves them, that is, with an earnest and warm devotion, as appears in 'O Sanctissima!' 'Corn Flowers,' 'Little Carin,' and others.

In addition to these are works which we cannot find room even to name here; but we cannot avoid mentioning two charming sculptures by Professor Jerichau, one called 'Love Triumphant,' a figure worked out in the round; the other a group of three nymphs dancing—a composition in high relief, to which the highest compliment that can be paid is to say that it has so much grace and beauty as not to be unworthy of Thorwaldsen, his master.

RAFFAELLE'S
'MADONNA DEL LIBRO.'

A CURIOUS story relative to this famous picture is reported from Florence. The work received its title from the Virgin holding a book in her hand, which the infant Jesus, who is seated in her lap, also holds, as if in the act of reading it: an outline engraving of the picture is given, with many others from Raffaele's designs, in Kugler's "Handbook of Schools of Painting in Italy." It is a comparatively small circular work, which has long been in the family of Count Conestabile of Perugia. Rumours lately became current that negotiations were on foot for its disposal, and that it was destined to leave the country. The Italians appear now to have become sensible of the importance of retaining in their possession the works of their great painters, and public opinion was greatly excited by the prospect of losing so valuable a gem as this. Signor Massari, a member of the Italian Chamber, undertook to bring the matter before the assembly; and Signor Correnti, Minister of Public Instruction, taking advantage, as he frankly admitted, of some old Papal law still remaining unrepealed, laid an embargo on the picture, as soon as he heard it was to be removed to Rome to be sold, with others. Its owner, the present Count Conestabile, assuming, as he naturally would, that he had a right to do as he pleased with his own property, brought an action against the government, and obtained a verdict in his favour. The minister carried the case into a higher court, and lost it again: he then lodged an appeal against the sentence, and was once more nonsuited. His next step was to procure from the Count a promise that he would not absolutely sell the picture without first informing the government. The promise was kept, for as soon as he received an offer of the large sum of £12,400 for it, from a Russian agent, he made the minister acquainted with it. Signor Correnti called his colleagues together, and asked them to help him out of the difficulty at once, for the bargain with the agent was to be accepted or rejected by the Count within twenty-four hours. The object of the deliberation was, of course, to outbid the former, but after an inspection of the coffers from which the required sum was, as they hoped, to be supplied, the idea was given up in despair, and the 'Madonna del Libro' is reported to be now in St. Petersburg; a present, it is said, from the Empress of Prussia, the real purchaser, to the Emperor. Such is the story as it reaches us through one of the daily journals, whose correspondent in Florence intimates that Signor Correnti has announced his intention of bringing forward a bill to compel, in the future, owners of works of Art desirous of parting with them, to give the government the right of purchase in the first instance.

OBITUARY.

FELIX CLAUDE THEODORE ALIGNY.

WE find in our contemporary the *Athenæum* a report of the death of this painter, on the 25th of February, at Lyons, where he held the office of Director of the *Ecole des Beaux Arts*. The notice states that M. Aligny was born at Chaumes, in La Nièvre, in January, 1798: ten years afterwards he arrived in Paris, and, though very young, was placed in the studio of Jean Baptiste Regnault, the historical painter. He must, however, have continued there but a short time, for Regnault died in 1809. It is possible that the decease of the latter may have changed the character of Aligny's Art-tendencies, if at that early age they can be said to have had any fixed determination; but the *Athenæum* says,—“Finding his powers more happily directed to studies of landscape than to those of figures, he took lessons of Watelet, from whose instruction he profited greatly, but whose influence was not marked on his Art except, it may be, by the production of an opposite. Watelet was a naturalist, as then understood, which is not quite the same thing as what we now call a realistic painter, while Aligny affected the *grandiose* modes of Poussin, and the *quasi*-classical phase of Art which obtained such great but short-lived favour in his hands. Aligny was no copyist of Poussin, but a very noble and expressive artist, working in the vein Poussin may be said to have discovered. His first picture, 'Daphnis and Chloe,' was exhibited in 1822. The *Salons* of 1828, 1831, ('Massacre of the Druids'), 1833, 1834, and following years, attracted great attention in Europe, and especially in France, then living under the Art-influence of a severe school. In 1837 appeared his 'Prometheus,' which is now in the Luxembourg, and recalls the magnificent 'Polyphemus' of Poussin." Aligny's subsequent works were 'The Roman Campagna,' (1839); 'The Good Samaritan,' (1846); 'Saul Consulting the Witch of Endor,' 'Magdalene in the Desert,' 'The Shepherds of Virgil,' (1841); 'Hercules with the Lernean Hydra,' (1842); 'Tivoli,' 'La Riccia,' 'Civitella,' 'The Gulf of Naples,' 'Salerno,' 'Solitude,' 'The Infant Bacchus,' (1848); 'Episode in the Revolt of the Gauls,' (1855); and 'The Defeat of Duguesclin,' painted in 1841, and now in the gallery of Versailles.

Aligny painted many of the well-beloved and romantic scenes in the Forest of Fontainebleau; for example, 'La Gorge aux Loups,' and 'Le Long Rocher.' His 'View of Genazzano, Environs of Rome,' and 'View of Royat, France,' both belonging to the French government, were sent over to our International Exhibition of 1862 by the ex-Emperor Louis Napoleon; they appear in the catalogue under the name of Théodore Carnelle d'Aligny, that by which he was generally known.

As a designer his compositions, "apart from those he painted, are very grand in their motives, dignified in their expression, firmly and severely executed." He etched numerous plates, the chief being a series of ten views of historic sites in Greece, published in 1845. He obtained a medal of the second class in 1831, one of the first class in 1837, and the decoration of the Legion of Honour in 1842.

ANTONIO PORCELLI.

The death of Antonio Porcelli has deprived Rome of one of her most original and animated painters. He distinguished

himself equally in landscape and in figures, emulating in the latter the Flemish painters—whom, however, he surpassed in ideality. Among his more notable works may be mentioned one in the possession of M. Rothschild; it represents the concourse of people at the fountain 'Dell' Aqua Autosa' close to the Flamminian Way; 'The Cobbler's Monday,' purchased by the Emperor of Russia ere he came to the throne, reproduces with the most sparkling vivacity a scene of common life peculiar to Rome. The picture of the Carnival of Rome, as seen in the Piazza Colonna, is an equally interesting representation of Roman life: its numerous figures in endless variety of costume, and disposed in charming groups, bring before the eyes the animated scene, with its merry crowd listening to the delicate allusions and sportive wit by which the Roman masqueraders are distinguished. 'The White Lady,' 'The Scottish Puritans,' and 'The Black Dwarf,' of Sir Walter Scott; the 'Scribe of Piazza Montanara,' 'The Return from the Chase,' 'The Topers,' 'The Sepulchre of the Vice-Regents, in the Pine-Wood at Ravenna,' and many other oil-paintings, besides numerous water-colours and drawings, display a mind wholly absorbed in the loveliness of Nature, and the sublimity of Art. In the International Exhibition of 1862 were two oil-pictures by this artist,—'The Pine Forest of Ravenna,' and 'Reminiscences of the Flemish School.'

Signor Porcellidied on the 13th December, 1870, at the age of seventy.

FREDERICK TREVELYAN GOODALL.

The unfortunate circumstance that caused the death of this young artist, at Capri, on the 11th of April, has been made known to the public through the daily papers; and we need not dilate upon it. The eldest son of Mr. F. Goodall, R.A., he had already given ample proof of talents that promised, in a remarkable manner, to sustain the reputation which this family of artists has so long enjoyed. The works exhibited by him at the Royal Academy during the last three years, and especially 'The Return of Ulysses,' one of the pictures of 1870, led us to regard him among the rising young men whom time and study must eventually have elevated to a high position. His premature death, at the early age of twenty-three, is not only a heavy affliction to his family, but a loss to Art.

MRS. PEARSON.

This lady, who died on the 15th of April, at the age of seventy-two, had also long since passed away, as an artist, from the memory of the present generation; but there was a time when her portrait-painting was held in high esteem both for its fidelity and execution. Her maiden name was Dutton, but in the Art-world she was known as Mrs. Pearson. She survived her husband, the late Mr. Charles Pearson, M.P. and City Solicitor, several years. We look back to the long-ago time when this accomplished lady was admired for her personal loveliness, as much as for her talent and winning sweetness of manner; the latter remained with her to the end of her gentle life: she was loved and respected not only by her home-circle, but by all who knew her. Mrs. Pearson's latter years were passed at the residence of her son-in-law, Sir Thomas Gabriel, whose year of office, when Lord Mayor of London, was marked by unwonted courtesies shown to artists and men of literature and science.

ALMA TADEMA'S 'VINTAGE.'

ALTHOUGH we have already noticed this remarkable work, now being exhibited at Messrs. Pilgeram and Lefevre, at 1a, King Street, St. James's, it is our duty to recur to it. It is a picture, of which the title would lead one to imagine the portrayal of vine-clad slopes, with picturesque semi-nudities plucking the purple fruit, but in M. Tadema's 'Vintage' we have a very different scene. We see a scholarly and graphic representation of heathen thanksgivings for a successful wine-making season. The scene is laid in a sumptuous Bacchic Temple in ancient Rome. An altar dedicated to the God of Wine occupies the centre of the composition, past which is moving a procession. It is led by a beautiful priestess, wearing the auburn tresses that we have so much reason to believe the dark-browed Roman ladies peculiarly affected; next come the minstrels, three graceful and elegantly clad maidens playing the double pipe; a bevy of laughing dancing-girls follow, wildly beating their timbrels; then priests stalk along, bearing in their brawny arms earthenware jars filled with the year's vintage; the remainder of the procession is as yet *behind the scenes*. In the court of the temple are seen more dancers and timbrel-players of both sexes, who seem very decidedly inspired by the god they have come to honour.

The picture is throughout indescribably beautiful and interesting; the drawing, save in the case of one or two hands and wrists, almost faultless; the composition also is most masterly; but the chief, the overpowering quality of the work—the quality that throws into the background all others—is its intense realism, a realism that we cannot believe to be *merely* the result of the diligent perusal of the pages of Tacitus and other authors of Cæsarean times, or researches in architectural and other antiquities; although all this is, of course, absolutely necessary to convey the appearance of truth, to show "the very age and body of the time, its form and pressure;" yet the realistic feature of M. Tadema's Art seems the outward and visible sign of a similarity in mind, a congeniality in spirit with those who led the taste of Imperial Rome. As Mr. Poynter is imbued with the prevailing characteristics of the ancient worshippers of Isis and Osiris, their manners and customs, their dwellings and temples; as Mr. Marks is with regard to mediævalism; so is M. Tadema with the now faded glories of the city on the seven hills. The English painters just named are so one in thought with the particular periods they have chosen to illustrate, that they can hardly go very far wrong in any accessories they may introduce in cases where it would be perhaps impossible to find historical or antiquarian warrant for the introduction of a certain vessel or article of furniture, yet it will generally be proved that such is in strict *character* for their period. Thus M. Tadema in the matter, for instance, of the woollen and other fabrics of diverse and eccentrically figured patterns delineated in the subject of this notice, must necessarily have drawn upon his imagination to supply the want of actual authorities in this respect; yet what an utter absence of incongruity! the most fastidious classicist, we think, would be at a loss to find a point that is out of harmony with the rest. This realism is by no means confined to particular objects, it pervades the entire composition, the very atmosphere seems charged with the luxuries, the vices, the extravagance, and the heartlessness of the capital of the world. It is, perhaps, a question whether the ornamental and antiquarian elements are not brought rather too prominently forward; we feel inclined more to study the bronze tripod on the altar, the richly chased silver cups, &c., than the main business of the picture. What says a celebrated English authority on this subject? "The ornamental style will be used with far better effect if its principles are employed in softening the harshness and mitigating the rigour of the great style, than if it attempt to stand forward with any pretensions of its own to positive and original excellence."

We observe in this picture some really marvelous bits of painting: witness the large jar of red

earthenware in front of the altar, and the two smaller *amphoræ* borne by the priests; these are rendered with a fidelity that is absolutely startling. But M. Tadema is pre-eminently the painter of marble; the marble pavement and the ornate veined columns would almost put to shame the substance simulated; in fact the soft creamy tone that this practice begets has operated rather unfavourably on his figures, which bear too much the appearance of tinted marble statues, magnificently carved, but still statues; and, moreover, we fear that this effect is not counteracted by sufficient evidence of that indescribable essence of real breathing life that M. Gérôme knows so well how to convey.

The picture is to be engraved by Auguste Blanchard, and we wish every success to the undertaking. If the print shows a favourable comparison with the painting, and there can be but little doubt of this, the possessor of the engraving will have ample reason to be satisfied with what he has acquired.

PICTURE SALES.

THE fine collection of water-colour drawings, and of oil-pictures both ancient and modern, belonging to Mr. Brooks, of the St. James's Gallery, Regent Street, was sold by Messrs. Christie, Manson, and Woods, on the 29th of April and the 1st of May. We gave a description of the major part of these works in our number for April last.

The modern drawings and oil-paintings, 135 in number, were sold on the first day, and realised £20,750. Of the former may be noted,—'The Challenge,' and 'The Match,' a pair, by L. Haghe, representing the interior of an ancient guard-house, with soldiers at cards, 200 gs. (Permain); 'North End, Hampstead,' going milking, and 'Returning from Milking,' a pair by J. Linnell, Sen., 210 gs. (Baker); 'Morning,' and 'Evening,' also a pair by the same artist, 445 gs. (Wetherell); 'The Empress Eugenie receiving a Deputation in front of the Town Hall at Nancy,' Meissonier, a comparatively small drawing in Indian ink, executed by command of the Emperor Napoleon III., fetched the enormous sum of 440 gs. (Martin).

The oil-pictures included,—'A River Scene,' with a peasant and a cow, and 'A woody Landscape,' both by P. Nasmyth, 200 gs. (Agnew); 'The Wood-cutters,' J. Linnell, Sen., 750 gs. (Morby); 'Scene from the *Vicar of Wakefield*,' M. Anthony, 250 gs. (Marks); 'The Mountain-Track,' J. Linnell, Sen., 800 gs. (Walter); 'The Gamekeeper's Daughter,' J. Faed, R.S.A., 330 gs. (Wilson); 'The Reapers,' James T. Linnell, 640 gs. (Bennett); 'A Scene in North Wales,' F. R. Lee, R.A., with animals by T. S. Cooper, R.A., 280 gs. (Eastwood); 'Mountain Shepherds,' J. Linnell, Sen., 850 gs. (Paget); this fine picture has been engraved for the *Art-Journal*, and will be published ere very long; 'The Old Brocade,' J. Faed, R.S.A., 380 gs. (White); 'A Scene from *Woodstock*,' W. Holman Hunt, 185 gs. (Eastwood); 'Counting the Cost,' W. Oliver, 185 gs. (Morrison); 'Redstone Wood,' J. Linnell, Sen., 410 gs. (Cox); 'Bothered with the Change,' and 'Something to Keep the Cold out,' both by E. Nicol, A.R.A., 280 gs. (Wetherell); 'The Timber Waggon,' J. Linnell, Sen., 850 gs. (Lewis); 'On the River Brent,' J. M. W. Turner, R.A., an early and comparatively small picture, but of exquisite feeling, 580 gs. (Cox); 'The First Introduction of Christianity among the Welsh, by Bran, the Cymric Bard,' W. Linnell, 460 gs. (Ellis); 'Brighton in the Season,' J. Webb, a picture of very large dimensions, now being engraved, 475 gs. (Murray); 'Open Country,' James T. Linnell, 705 gs. (Eastwood); 'Auld Mare Maggie,' J. Faed, R.S.A., 750 gs. (Eastwood); 'The Happy Days of Charles I.,' F. Goodall, R.A., a small *replica* of the well-known large picture, 275 gs. (Eastwood); 'Setting up'—sheaves, J. Linnell, Sen., 890 gs. (Miller); 'Christ bearing the Cross,' Sir J. Noel Paton, R.S.A., the fine gallery-picture for which, in conjunction with his 'Reconciliation of Oberon and Titania'—purchased at the time

by the Royal Scottish Academy,—the artist received the prize of 300 guineas when exhibited in Westminster Hall, in 1847, 900 gs. (Wright).

It will be observed that the collection was very rich in works by the Linnells, father and sons, and that they realised large prices: most of them were painted expressly for Mr. Brooks.

The pictures by old masters, including three or four by painters of the early English school, numbered 44; they were sold on the second day. Of these the principal were:—'The Madonna and Child,' Murillo, 100 gs. (Radclyffe); 'The Melton Oak,' Crome, 175 gs. (Daniell); 'Psyche,' and 'Head of a Girl,' a pair by Greuze, 375 gs. (Wilson); 'Master Coke as Young Hannibal,' Sir J. Reynolds, 380 gs. (Cassells); 'Interior—the Duet,' Gonzales Coques, 240 gs. (Wardell); 'Italian Landscape,' with Muleteers on a road, J. and A. Both, 475 gs. (Nicholls); 'Italian Landscape,' with a shepherdess, a hurdy-gurdy player, and cattle, P. Berghem, 455 gs. (Nicholls); 'Flora,' the celebrated engraved picture by Greuze, formerly in the Demidoff Collection, at the sale of which in Paris last year, it was knocked down for £720, now realised 770 gs. (T. Davis); 'Sportsmen halting at a Village-Inn, a scene in the Isle of Wight,' G. Morland, 375 gs. (Matthews). The second day's sale reached the amount of £6,195: the total sum realised being £26,945.

On the 6th of May Messrs. Christie and Co. sold a number of water-colour drawings and paintings in oil, the property of the late Mr. T. Agnew, of Manchester, and of other owners. The following works may be noted as of primary importance. *Water-colours*:—'Black Grapes and Plums,' W. Hunt, £43 (Bale); 'Peaches, Muscats, and Strawberries,' W. Hunt, £43 (Kirlaw); an album containing ninety-three drawings by early water-colour painters, D. Cox, Cristall, Edridge, Prout, Varley, and others, £96 (Grindlay); 'Llangollen,' D. Cox, £54 (Fuller); 'Interior of a Gothic Church,' S. Prout, £48, (Tooth); 'Old Buildings on the Moselle,' £53 (White); 'Mendicants at a Church Porch, Seville,' E. Lundgren, £48 (Tooth); 'Harvest,' J. Linnell, £111 (Mendoza).

Oil Pictures:—'Lago Maggiore,' J. B. Pyne, £106 (Pocock); 'Windermere,' J. B. Pyne, £127 (James); 'Lago Maggiore, with the Borommean Islands,' J. B. Pyne, £122 (Mendoza); 'Council of War in the Crimea,' containing portraits of Lord Raglan, Marshal Pelissier, and Omar Pasha, by A. L. Egg, R.A., £96 (Sir W. Codrington); 'The Disenchantment of Bottom,' and 'The Reconciliation of Oberon with Titania,' D. Maclise, R.A., £162 (Ward); 'Bohemian Gipsies,' D. Maclise, R.A., £420 (Muirhead); 'Innocence,' Gainsborough, £31 (Trant); 'The Burial of John Hampden,' P. H. Calderon, R.A., engraved in the *Art-Journal* of last year, £252 (James); 'Moorland Shepherds,' W. Linnell, £189 (Bourne); 'A Shooting Pony,' £157 (Agnew); 'A Favourite Hack,' £157 (Agnew); 'Scene in the Highlands,' with portraits of the Duchess of Bedford, Duke of Gordon, and Lord A. Russell, £1,333 (Ward); these three pictures are by Sir E. Landseer, R.A., and were painted for the late Duke of Gordon; the first and second in 1825, the third in 1828. 'Ophelia,' E. Delacroix, £420 (Maclean); 'An Italian Pifferaro,' Gérôme, £127 (Agnew); 'Peasant-Women of the Campagna,' Gerome, £127 (Agnew); 'La Petite Laitière,' E. Frere, £73 (Agnew); 'Light and Darkness,' G. Smith, £253 (Tooth); 'Portrait of Admiral Lord Anson,' Sir J. Reynolds, engraved, £199 (Graves); 'Scene from Sterne's *Sentimental Journey*,' W. P. Frith, R.A., £562 (Ward); 'The Rape of Europa,' J. M. W. Turner, R.A., £309 (Cassells); 'Falls of the Clyde,' J. M. W. Turner, R.A., £357 (Campbell); 'The Empty Sleeve,' G. D. Leslie, A.R.A., £222 (Mendoza); 'The Zuyder Zee—Fishing-boats returning to Port,' £92 (Permain); 'The Battle of Naseby,' J. Gilbert, £126 (Agnew); 'In Memoriam,' W. T. C. Dobson, A.R.A., £162 (Bourne); 'Christ disputing with the Doctors,' W. J. C. Dobson, £262 (Bourne); 'The Gentle Student,' J. Phillip, R.A., £199 (Vokins); 'A Snow Scene,' W. Müller, £73. (Mendoza).

ART IN SCOTLAND, IRELAND, AND THE PROVINCES.

EDINBURGH.—*Scottish National Prince Consort Memorial*. This work is now rapidly approaching completion; the equestrian statue of the Prince is receiving the final touches from Mr. Steel, and the last of the representative groups is at present being cast in bronze at Mr. Steel's own foundry. This group is intended to represent "Literature and the Fine Arts," and is the second group that has been executed by the same sculptor, Mr. D. W. Stevenson, the first being representative of "Labour," a notice of which appeared in the *Art-Journal* about a year ago. "Literature" is represented by a venerable professor in academic robes, who, pointing with one hand to the prince, with the other leads forward a youth to pay homage to one who has done so much for both Literature and the Fine Arts; the youth bears a wreath in his hand, and is so absorbed in the story which has been told, and in looking at the prince, that he has not placed the tribute, as the "artist"—the companion-figure on the opposite side—has done. The action of these two figures is lifelike, and the skilful manipulation of the drapery is especially noticeable. The "Fine Arts" is represented by a young artist who carries in one hand a portfolio, with other artists' insignia, while with the other he places a wreath of olive on the monument. The action of the artist is at once easy and dignified, and expresses the spontaneity of feeling by which he is apparently actuated. If the Committee of Management could only agree about the site, the inauguration of the memorial might be looked for at no distant date.

DUBLIN.—Mr. James Butler Brennan, of Cork, has been elected a member of the Royal Hibernian Academy, of which he had for some time been an associate. Mr. Brennan is a painter of portraits and *genre* subjects, which find much favour with the Art-critics of Ireland.

BIRMINGHAM.—It is reported that a gentleman of this large and wealthy borough, desirous to promote the intellectual culture and enjoyment of the inhabitants, has offered to give the liberal sum of £3,000, as the nucleus of a fund for investment to purchase pictures for public exhibition in Birmingham. The announcement, as we read it, leaves a doubt as to whether these pictures are to become the property of the town, as it may reasonably be presumed they are intended to be, forming a local picture-gallery.

LICHFIELD.—A recent number of the *Builder* notices the discovery of an ancient wall-painting in the Cathedral of this city,—at the east end of the south side of the choral aisle, a portion of the edifice which is presumed to have been a chapel dedicated to St. Chad. "The existence of other illuminations in the immediate vicinity of the picture would fix it as a specimen of the art of the thirteenth century. The subject is the Crucifixion, the centre figure being Christ upon the Cross. The groundwork is of a greenish tint, studded with white stars. The predominating colour of the drapery of the figures is a lightish red, the Cross also being of that colour. In some of its details the painting is curious, if not grotesque. An inscription in doubtful characters can be traced on the wreath."

LIVERPOOL.—At a somewhat recent meeting of the Liverpool Architectural and Archaeological Society, Mr. S. Huggins read a paper on "The so-called Restoration of our Cathedral and Abbey Churches," in which he strongly denounced the practices generally employed in such works, and more especially that which deprives the edifices of their ancient picturesque character. "I would protest," he says, "against any kind of restoration that removes the old face, which, in every instance in our climate, must be more beautiful by the cosmetics of nature than it ever was in its prime." Mr. Huggins does not, however, object to supply in partially ruinous buildings the features or parts absolutely destroyed, nor to repair mutilations produced by accident or violence; but if more than these are required, he would "let them alone," to stand, in their gradual decay, as monuments of the

glories of the old builders—"the architectural embodiments of a form of worship of other days;" and would transfer the services of our church to new edifices, "exactly adapted to the Protestant worship; a course by which we should have, in each case, two cathedrals." From an æsthetic point of view the alternative is favourable: but we expect these are not the times when utility can afford to give place to the demands of the mere picturesque.

NORWICH.—The exhibition of the Norwich Fine Arts Association will this year be held in connection with the Norfolk Industrial Exhibition in St. Andrew's Hall, Norwich.

SCHOOLS OF ART.

FARNHAM.—A school was opened in this town on the 18th of April, when Mr. W. Cave Thomas delivered an address on subjects entitled, "To what end should we study Art?" and "The Importance of Drawing and Music in Education." The establishment of the school is, we understand, chiefly due to the exertions of Colonel and Miss Luard, residents in the neighbourhood.

GREAT YARMOUTH.—An exhibition of the drawings executed by the pupils in this school, was opened a short time since in their rooms on South Quay. The number of works was not large, but it included several of good promise.

ART IN CONTINENTAL STATES.

CHILE.—The subscriptions for a statue in honour of the late Earl of Dundonald, more popularly known as Lord Cochrane, and to which we referred more than a year ago, have now reached the sum of two thousand pounds. The work is to be executed in England: both Santiago and Valparaiso have been named as the city in which it is to be erected. This point, however, is not yet determined, we believe.

FANO.—A famous picture by Domenichino, called 'David, the Conqueror of Goliath,' that hung in the gallery of the Collegio Nolfi, is reported to have been cut out of its frame, on the 25th of March, and carried away: no trace of it has yet been discovered.

FLORENCE.—The Etruscan vases, and the collection of Roman remains, small sarcophagi and inscriptions, have been removed from the passages between the Galleries to the Egyptian Museum (the suppressed convent of St. Onofrio, which contains the Cenacolo ascribed to Raffaele), and the walls are being covered with the finest old engravings and etchings of the Italian and German schools. Criticism is premature. Mark Antonio and Albert Durer are already there, and others of equal note will soon follow; but the first thing which strikes the eye is a bold design by Beccafumi, 'The Sacrifice of Isaac,' for his very original work, the pavement of the cathedral of Siena.—M. Cabanel, the distinguished French painter, has sought a temporary refuge in Florence from the troubles in Paris, and has a villa and studio overlooking the town.

MADRAS.—The government of India has sanctioned the outlay of about 9,000 rupees to enable Dr. Hunter, Principal of the School of Art in Madras, to take castings, mouldings, and photographs of objects of antiquity in this Presidency.—The premium of 1,000 rupees, offered for the best design for a Memorial Fountain, in honour of the late Sir Herbert Edwardes, has been awarded to Mr. De Rebeck, Head-master of the School of Art at Jaipore, who had several competitors, some of whom sent in very meritorious designs. The one selected takes the form of a cupola, resting on traceried arches, which covers a white marble basin that receives a jet of water. The whole is surrounded by an open building of octagon shape.

MADRID.—The Spanish Government is reported to have decreed that an exhibition shall be held annually, in the month of October, of objects from which a selection is to be made for our International Exhibitions in London.

THE STATUTE FAIR, BY JOHN FAED, R.S.A.

THE statute fair for the hiring of agricultural and other servants held periodically in Scotland, forms the subject of a picture by the above-named accomplished painter, which was, it appears, too late for reception at the Royal Academy, and is consequently exhibited at Mr. Brooks's Scotch Gallery, 48, Pall Mall. This is an important work, and we accept it in all its ethical significance, deeply impressed with the facts it sets before us, and those which present themselves inferentially. Mr. Faed has painted what he has seen, and hence all that he introduces assists his searching commentary on the rural statistics of Scotland. We cannot go minutely into the details of the work, we cannot accompany the painter through his discourse on progress and improvement, but we can glance down the vista of Scottish social literature during the last century, and acknowledge in its full force this protest against the reputed dominion of whisky at all popular assemblages.

But to turn to the immediate matter: the hideous feature of the past is represented only by a meagre and obscure allusion. On the extreme left of the picture is a burly female stall-keeper, with a display of fruit and sweets but who, at the instance of a customer in search of a dram, produces a small bottle, much apparently to the annoyance of the man's wife or sweetheart, who remonstrates against this beginning, or continuance, of indulgence. The small size of the bottle is significant of the limited demand; moreover that which was formerly the towering spirit of these so-called merry-meetings has now become a hole-and-corner affair. In counterpoint to this, and prominently in the foreground, appears a comely and kindly old woman washing up her dinner-service of coques, luggies, and wooden spoons, after the full dispensation of, it may be, the contents of her kail-pot or her cockie leekie, or sheep's head broth, a form of the barley bree very different from that brewed from the famous peck of malt celebrated in one of Scotland's most popular songs. And do these wooden spoons mean nothing? Indeed they go largely into the account of progress, although they do not appear as a considerable item in national statistics illustrating a step in civilisation. Beside the old woman sits an aged man, representing a helpmate of many years gone by; and the relation of the venerable pair suggests that the artist has been working not merely from the prose of his country's history, but that, throughout, the characters appeal directly to impressive situations in Scottish song or sonnet. Near these are groups of girls come to be engaged, and looking very confident of good fortune; and near and around them are masters of different degrees of social standing, from those who themselves whistle at the plough to lairds of many broad acres—men whose faultless personal appointments would pass parade to-day in Pall Mall, who might enter White's or the Travellers unquestioned by a new porter—who look gravely impressed with the rise of wages and other mischiefs brought about by recent emigration.

Again, on the right, and standing with his back to us, is an admirable figure who may be a factor or a small agriculturist on his own account. He has evidently ridden some distance to the fair, having been pronounced "uncow braw" by his wife, and so dismissed for the day. He wears an upper covering of the May-fly tint, and netherwards a pair of black long shorts, buttoning about mid-leg, almost met by a pair of tight-laced ancle-boots finished with a pair of spurs. He evidently means business, and is talking to a girl like a domestic servant, who replies by banter to his offers of employment. The right is closed by show-vans, where the principal figurants are a clown and one or two musicians with trombones and trumpets, who invite us to ask the departing audience the character of the performance. These gentlemen issued on their provincial tour some months ago from the New Cut, Lambeth, the head quarters of open-air comedians, acrobats, nigger singers, punch-vaudevillians, and all kinds of

professors of muscular Art. Indeed, look where we may, the supplementary element of the composition is thoughtfully and aptly administered; the by-play is wanting in nothing, and what we conceive to be the argument of the picture is never lost sight of; that is, the present condition of the bone and muscle of Scotland in comparison with the state of the same fifty years ago. None of the minor incidents of the picture escape us, they are numerous and interesting, but we have not space to describe them. All that can be said is that the picture is a well-considered and valuable essay on the present state of agricultural Scotland, and thus taking rank with the essays of Wilkie and John Phillip. It is proposed to reproduce the picture in Oleograph.

ASIA.

FROM THE GROUP OF SCULPTURE BY
J. H. FOLEY, R.A.

IN apportioning the various colossal groups of Sculpture, emblematic of the four quarters of the works, which are destined to adorn the Albert Memorial in Hyde Park, that of Asia was assigned to Mr. Foley, whose name is a guarantee for a work of genius whatever the nature of the subject he takes in hand: a noble group is the result.

The leading figure represents Asia, a beautiful female seated on a kneeling elephant, which appears to be in the act of rising, as the rider, with her jewelled armlets and necklace, throws off the veil that concealed her form, and holds it lightly in her fingers. The action and general *pose* of this figure are as true to nature as each is very elegant. The docility of the huge animal that bears her may be accepted as typifying the subjection of brute force to human intelligence. The supplementary figures, as they may be termed, are four, representative of those nations of the far east which contributed liberally to the first of our great International Exhibitions; namely, China, Persia, India, and Asiatic Turkey. The first of these appears on the left of the elephant's head; the characteristic type of his race is unmistakable in his features, while the jar he holds and that by his side indicate him an art-manufacturer, a producer of ceramic works. The Persian stands on the right: the pen in his hand and the volumes at his feet symbolise his occupation or profession—that of a poet, a phase of literature which has long held a conspicuous place in the traditions of the country. The other two figures, only partially visible in the engraving, represent respectively Asiatic Turkey, in the character of a merchant, who is surrounded by an accompaniment of attributes telling of barter and sale in Oriental bazaars; and India, who is also supplied with appropriate national emblems.

It is obviously apparent that the sculptor has studiously avoided allegory in his design, unless the dominant figure may be considered in this light, which it can scarcely be; all the others must be regarded as national portraits of living races, each being a representative man. As a whole the composition is fine, approaching to grandeur; while each portion would in itself take rank as a striking example of sculptured Art.

We are glad to be able to state that under the genial air and spring sunshine of the southern coast the health of Mr. Foley, the sculptor of this imposing group, is gradually improving. Our readers are aware that to him is entrusted the statue of the Prince Consort, of which a model was prepared some time ago; but Mr. Foley's long-continued illness has prevented him from proceeding with the work.

INTERNATIONAL EXHIBITION. THE BELGIAN PICTURES.

THE number of works catalogued, as of the Fine Art Department, amounts to more than 4,000; comprehending, besides Fine Art proper, decorative Art, fans, metal-work, carving in ivory, photography, tapestry, electrotypes, mosaics, &c. Of the vast aggregation of labour thus represented, we now select for brief notice those pictures of the Belgian school which, as types of their class, mark progress or decadence; the latter state being as well worthy of consideration as the former, since we see daily that Fine Art is of a constitution so delicate as never to survive abuse. It is proposed to distribute our notices of the picture-galleries through several consecutive numbers of the *Art-Journal*, dwelling scarcely more than inferentially on those works which present themselves either as worthy examples of a recognised class, or as scintillations of genius shedding new lights around them. But the fulfilment of even this very moderate proposition is sorely obstructed by the method adopted in numbering the pictures. What we mean is this—Of such a mass of material it is impossible that the visitor can even look at any considerable portion; he therefore marks in his catalogue the names of men whom, as a simple amateur, he knows by reputation; or, with a more extended knowledge, those whom he believes cannot paint an essentially bad picture; and here his facilities end. If he desire to see, say, for instance, No. 845, he will find it after a diligent search; and, if, having examined it, he wishes to see No. 850, which he hopes may be only a few removes distant, he discovers it, only after a careful inspection of the four walls, hanging on the other side, and at the further end of the room. Thus, of three hours passed in any given room, one half is spent in searching for the works we may wish to see first, our inquiry being considerably retarded by the extreme minuteness of the figures numbering the pictures. This is a serious grievance, and a source of vexation and weariness to those who visit the Exhibition for any specific purpose. It is useless to tell us that the arrangement is similar to the numbering and distribution of this or that exhibition. All that can be said in answer to this is, that every assemblage of works publicly exhibited should be catalogued in such a way as to cause the visitor no inconvenience and loss of time.

Among the contributors of paintings to the Belgian collection are the Prince of Wales, the King of the Belgians, and the Belgian National Gallery; but the selection represents the school only imperfectly. It may be that we have already had brilliant gatherings of Belgian works, but still this is an occasion on which the character of the school should be maintained *à fortiori*—that there are splendid pictures which have not been seen in this country; and again, that the interval since the last Exhibition has not been unproductive. It must, however, be said that the selection has been so made from the different classes, as to represent them severally with perfect justice, according to the means at hand, and to include some productions of rare excellence. To these we proceed to point attention, and to signalise the merits or demerits whereby they are rendered conspicuous. We turn to a picture (876), by E. WAUTERS, 'Mary of Burgundy vainly entreating the Sheriffs of Ghent to pardon her councillors, Hugonet and Humbercourt.' There is much to be learnt from this re-



ASIA

(THE ALBERT MEMORIAL, HYDE PARK)

ENGRAVED BY R A ARTLETT, FROM THE GROUP IN MARBLE BY J H FOLEY, F. A.



markable picture: it impresses us at once with the fact that the artist has been earnest in clearing away all state-ceremony from his version of the scene; but how far this is commendable in a state-enactment is a nice point to settle. He reads his history as a dry fact, asserts himself in preference to his detail, and supersedes history by the interest of Art. The princess wrings her hands in the earnestness of her supplication. Her two councillors are seated at the end of a small table, and the citizens of Ghent stand assembled on the right. Few things in its way are more masterly than the grouping, lighting, and character of the citizens, among whom there is more of the essence of the trade-guild than the odour of nobility. It is a work of great power, wherein the artist dismisses all the paraphernalia of false effect—indeed, a conception which few men would venture to attempt to realise, without a well-grounded consciousness of power to carry it out in its full force. No. 803, by J. DE VRIENDT, is 'Alain the Minstrel and Margaret of Scotland,' in which the lady is represented as having kissed the sleeping bard; and, in answer to the astonished looks of her attendants, says that "it is not the man she kisses, but the mouth from which have issued so many good words." This and the preceding are brought into direct comparison, not so much on account of the pictures themselves, as the diversity of manner they represent, and the influence the two styles exercise on men who are not morally strong enough to decide for themselves. M. Wauters' picture without the figures would be a blank; M. De Vriendt's work without the figures would still be a curious achievement, because every leaf and every brick is an individuality. Also by De Vriendt is 802—'An Offering to the Virgin,' it is, however, superior to the other in arrangement and effect, and much more successful as a study altogether.

Likewise in the same taste, 863, by F. VINCK, has for its subject 'The Confederates before Margaret of Parma, Ruler of the Low Countries,' it presents a spacious hall of ceremony, wherein the lady-viceroy, seated on a chair of state, and surrounded by her attendants, receives the Confederates, who are arrayed in every variety of civil and military costume. The whole is most elaborate in execution, and otherwise highly successful; but the effort of the painter in setting forth the probabilities of the situation is too conspicuous. There is, for instance, a certain awkwardness in the fit of the properties and appointments which is intended to show on the part of the painter a contempt for the pedantry of form and beauty of line. These works exemplify what is becoming a feature in Belgian Art, and must ever be distinguished by a certain amount of hardness inseparable from that method of work. Differing in everything from these is 828, by J. PORTAELS, 'A Box in the Theatre at Pesth,' occupied by three ladies who are painted according to rules conventional and accepted. There are many masterly points in the adjustments which could be realised only by the hand of an accomplished artist. The expression of the faces reflects the nature of a passing scene—one of moving interest; but the high merit of the painting is the breadth of middle tone in which the whole is worked. The artist has yielded to no temptation of the play of light which would have been fatal to the deep sentiment of the picture. 'The First Proof' (850), L. SOMERS, suggests, as a title, the working of a printing-press, but the conception propounds to us ideas and associations far beyond that

simple fact. Two monks have just drawn forth the proof of an engraving, which one of them contemplates with great interest. The picture is kept low in tone, but it is very effective. It is not often that we now meet with Madonnas, proposing in feeling and manner, to range up to the brightness and purity of the old masters; we have here, however, by C. VERLAT, a work of that class (860) by no means unworthy to take place by the side of even some of the most remarkable of the ancient pictures. It is almost impossible to conceive an agroupment of this subject, which has not already been utilised. M. Verlat, therefore, affects nothing new: the Infant Saviour is on the lap of the Virgin, and St. John is by her side. The features of the Virgin are somewhat heavy. 'Philippa of Hainault, wife of Edward III., gathering the Poor in the streets of London' (829), F. PAUWELS, shows very properly the queen in the exercise of her charity without the slightest allusion to her exalted position. As a study the merits of the work are conspicuous, but the subject is one of extreme difficulty, and the artist has not made enough of it. With this contrasts most favourably another work by the same artist (830), 'Return to Antwerp of Persons exiled by the Duke of Alva,' wherein is seen the crowd of exiles landing at one of the quays on the Scheldt, greeted lovingly by their friends, and overwhelmed by their own emotions on again entering their native city. The mass is very judiciously relieved by the sky and distance, for we look up the right shore of the river, where rise the spires and remoter buildings of the city. The subject is carried out with greater distinctness than the preceding; but it must be said of M. Pauwels, that though he exercises much taste in the selection of his themes, he does not sit down to them with a perfect apprehension of their difficulties, or with patience sufficient to exhaust the vein of their richness. In the attire of these exiles there is an unbecoming comfort and completeness which does not bespeak years of absence and privation. 'Retaliation' (867), J. VANKEIRSBIJCK, with the extract: "He said that the Spaniards will bathe themselves in the blood of the citizens"—an incident supposed to have taken place at Brussels in 1576—describes an attack made on a Spanish gentleman by a party of burghers. The Spaniard is attempting to strike with his dagger, but his arm is held, and he is borne down by the citizens, who are unarmed and in their working dress. This material would have borne treatment either as a large or small picture with full-length figures, but the painter has limited himself to half-length. In the drawing and painting of the burghers is a power and a substance worthy of all commendation, but there are two or three points which sensibly detract from the merits of the other portions. It has been the purpose of the painter to endue the features of the Spaniard with an expression of the most painful terror, but in this he has failed, and has left the face pale, insignificant—in short, entirely wanting in interest. Again, on the right, there is a bright yellow silk sleeve entirely unsupported in the composition, and, hence, what may be called a spot disturbing the general tone of the work. 'Field-Labourers—a recollection of Italy' (809), by A. HENNEBICQ, we instance as outraging all those canons of Art which have come down to us traditionally as articles of faith from those whom we recognise as the "old masters." We are now painting objects as we see them—accidents as they fall out—and are disposed to yield

to the *quattro* and *cinque centists* a better feeling for natural presentments than has ever before been accorded to them. The arrangement here is simple enough, as consisting of only a row of figures penetrating perspectively into the picture and on one side, without the slightest show of compensation on the other. The figures represent Italian husbandmen listlessly engaged in turning up the soil with little mattocks. The principle which we instance here is not at all peculiar to Belgian Art, but obtains now by universal consent. 'A Belgian Family under the Empire' (790), DE GRONCKEL, is the title given to a group consisting of two persons, an aged man and woman, evidently in misfortune. They cling to each other, hastening onward for better for worse, the empire being for them evidently a cruel reverse. The old man looks a gentleman, and his partner is his equal in position. The picture is eminently successful in its personalities, and particularly so in the lighting or rather shading of the figures, but there is yet much that is inexplicable, arising from the indefiniteness of the title. Were it not that the old gentleman wears a three-cornered hat of the Egham, Staines, and Windsor fashion, he might well be challenged with, "Which King—Bezonian?" but the hat hails from the first empire; yet why the pair should be described as a Belgian family remains to be accounted for, and hence it is permissible to ask if the title be correct. 'Punch' (808), T. GERARD, is a small domestic scene of surpassing brilliancy, admirable in *chiaroscuro*, and of unusual force in its lighted passages. There is a great array, but no confusion, of objects. We feel that the constituency is overdone, but the whole fits in like a well-adjusted puzzle, no single piece can be removed without injury to the whole. This is the result of elaborate and mature study, but such results sometimes transcend the limit of sound taste. The argument is of course the amusement of the children at the antics of Punch. 'Salambo' (761), E. AGNESENS, is a study of the head of a mulatto boy, really admirable in posing and life-like character. There is no striving after novelty, but there is novelty without effort which imparts much real interest to the picture. 'Cromwell at Lady Claypole's, Hampton Court, 1658,' (822), A. P. J. MARKELBACH, is the death-bed scene, the solemnity of which is much enfeebled by the presence of other parties in the room, introduced with a view to an expression of space. But that the artist has not dwelt on the moving circumstance of the interview, it is as a composition very effective. 'Roma' (848), E. SMITS, is a large picture intended, as we read it, to present examples of the various conditions of the inhabitants of Rome, and also specimens of its visitors. Beyond this there is no story, but up to this point the picture is unexceptionable. The arena of display we presume to be the Monte Pincio, and we have accordingly a youth in the costume which painters love so much, and one or two presumed *contadine*, representing rustic Italy, a *bonne* and her charge look with longing at a basket of oranges in the possession of a street vendor. Beyond these are two priests, also a small party of English tourists, who are introduced with a touch of caricature according to the vulgar taste of continental artists when representing our countrywomen. In the background is a cardinal, attended by two lacqueys in the usual expansive livery of the princes of the Roman church.*

* To be continued.

MINOR TOPICS OF THE MONTH.

THE INTERNATIONAL EXHIBITION was opened on Monday, the 1st of May, his Royal Highness the Prince of Wales presiding. It was a very brilliant scene—that which the great Conservatory presented, made gay by the presence of “rank and fashion,” by men and women of eminence in science, literature, and Art, and by the representatives of nearly all the leading cities and towns of Great Britain and Ireland. Certainly, it was a success, so far as the “gathering” went; the arrangements to make it “imposing” were admirable. The staff assembled in strength—decorated, of course, and the prince was surrounded by court dresses, which, we presume, are taken out of lavender, once in a decade. It was exciting, but also very pleasant, to follow the *cortège* through the several galleries—a state walk—and to witness another triumph of peace, saddened though the minds of many must have been, by a knowledge that war had shorn the occasion of the glories that might have triumphed there.

HER MAJESTY THE QUEEN has twice visited the International Exhibition, not merely as a formal visitor, but as a careful examiner of the pictures, sculptures, and objects in Art-manufacture it contains; and making minute inquiries in reference to some of them.

THE BANQUET OF THE ROYAL ACADEMY was, as heretofore, a grand affair. Princes and statesmen were the guests of artists; and their “Patrons” mustered strong. Of course, the usual toasts being given, the usual compliments were paid: the President received a large share of them. The proceedings, however, this year were by no means without interest. The profession and the public will be grateful for the improvements announced by Sir Francis Grant as in preparation; more especially for that which informs us of the intention to appoint a Professor of Chemistry: the chemist may be a powerful auxiliary to the painter in many ways, and help to do that for which posterity will be his debtor—preserve the value of his works, and retain their beauty and worth when he is an “old master.” That is something: but he may also enlighten artists in matters concerning which they are now utterly ignorant—causes as well as effects. That was not the only piece of good news the President communicated: the schools have been greatly improved. He said:—

“I may mention that whereas, taking the average of the last nine years, the school formerly cost the Academy £2,500 per annum, the expenditure last year amounted to £4,500, and when all our arrangements are completed, I am assured that they will not cost less than £5,000 per annum, paid solely from the funds of the Royal Academy for the gratuitous education of our numerous students.”

It is also to be noted that the cause of charity has not been neglected by the Academy; the monies obtained by the exhibition of ancient and deceased masters were thus expended. Last year the Academy bestowed on different charitable institutions connected with Art, the sum of £750, and this year they have voted £1,200 for the same object and also £150 towards the construction of a museum of architecture for the benefit of young students in architecture.” These are truly “important reforms and improvements,” and we thank the Academy for them. A little more advance, and the Institution will become as popular as it has been hitherto the reverse of that vast good.

THE NATIONAL GALLERY has received the collection of pictures purchased from Sir Robert Peel. They occupy the last room but one in that wing of the building which formerly was held by the Royal Academy, and are very judiciously hung; and, as it seems to us, they have been as judiciously cleansed from whatever impurities time may have gathered on their faces. Most of them are in new frames, or in those which have been regilded; when the glitter of this new dress is somewhat subdued, the pictures will gain by it a greater degree of harmony. We recommend our friends to pay an early visit to the “Peel” room, and can promise them a treat of no ordinary kind in this rich store of paintings by the old masters of the Low Countries. If the Chancellor of the Exchequer prompted, or at once acceded to, the purchase of these works, he has almost condoned in our opinion whatever offences have arisen out of his late budget; and even the match-makers of London, should any of them find their way into the room, might almost be disposed to forgive the right honourable gentleman his attempted trespass upon their industry.

MR. HENRY DUKE has nearly completed a commission given to him, at the instance of Sir William Boxall, R.A., by the Bishop of Cape Town, for a copy of Bramantino's large and fine picture, in the National Gallery, of ‘The Adoration of the Magi.’ We have had an opportunity of examining the copy, of which we can speak very favourably so far as we saw it in its comparatively unfinished state. It is intended for an altar-piece in the cathedral now being erected at Cape Town, from the designs of Mr. W. Butterfield, of the Adelphi.

MESSRS. AGNEW AND SONS, whose enterprise seems almost to be without limits, have recently purchased from the executors of the late William Bashall, Esq., of Farington Lodge, near Preston, his splendid collection of English pictures, eighty-five in number, of which we gave an account so far back as 1857. Among the works which have become the property of the purchasers may be pointed out F. Goodall's ‘Episode in the Happier Days of Charles I.’; Sir E. Landseer's ‘Red Deer’; E. M. Ward's ‘Josephine signing the Articles of her Divorce’; W. Collins's ‘Minnow-catchers’; P. F. Poole's ‘Crossing the Brook’; ‘Marina playing to Pericles’; and ‘Ferdinand and Miranda playing Chess in the Cave’; Sir C. L. Eastlake's ‘Gaston de Foix taking leave of his Wife’; Hilton's ‘Cupid disarmed by Venus’; Sant's ‘Infant Samuel’; and ‘Child Timothy’; a pair; and his ‘Soldier's Home’; C. Stanfield's ‘Arona,’ and ‘Edinburgh, from the Leith Roads’; D. Roberts's ‘Interior of St. Jacques, Antwerp’; and ‘Bethlehem, looking towards the Dead Sea’; F. R. Pickersgill's ‘Capture of Carrara’; A. Elmore's ‘Novice’; J. C. Horsley's ‘Madrigal Party’; and ‘The Administration of the Holy Communion’; T. Creswick's ‘Over the Hills and far away’; J. Linnell's ‘Summer Eve’; and ‘The Flock,’ &c. &c.: a list which, if no more were to be added to it, would convey no inadequate idea of the value of the collection. Several of the above pictures, as well as others from the gallery, have appeared in the *Art-Journal*, through the courtesy of their late owner, as engravings either on steel or on wood.

MESSRS. NEGRETTI AND ZAMBRA, who have done so much for Stereoscopic Art,—indeed, for Art in many other ways,—have recently produced a series of coloured photographs on glass of very great interest and merit, which cannot but add largely to the delight experienced by all who resort for it

to the stereoscope. The main purpose in colouring these views was to remove the “snowy” appearance which materially impairs their effect, yet is a fault common to all landscape photographs, whether on paper or on glass. By a method of “atmospheric tinting” which the artist in these improvements adopts, the defect is entirely got rid of. The object is seen as it is seen in Nature—Nature at its brightest. The views thus coloured are applied not only to the ordinary stereoscope, but to the magnifying stereoscope and the oxy-hydrogen lantern, two renowned issues of this famous firm; the latter magnifies an object to 40 feet in diameter. Of the effect thus produced we cannot speak; but the views are deeply interesting and very beautiful, seen by the common instrument—so interesting and so beautiful that, if brought within reasonable cost, they cannot fail to take the place of all others—those on glass as well as those on paper.

MR. ALDERMAN BESLEY, who, as Lord Mayor of London in 1870, gave so much satisfaction to the citizens, and whose official year was famous for hospitality, has had a marked compliment paid to him. MR. J. E. WILLIAMS, the eminent and accomplished artist, was commissioned to paint a portrait of his (then) Lordship—“A splendid annual” as Theodore Hook termed the Lord Mayor for the time being—and the portrait was presented to the Alderman by the subscribers. It is excellent as a likeness, and admirable as a work of Art. The gift was accompanied by a warm and cordial address, and Mr. Besley responded with his usual eloquence: for that is true eloquence which expresses, in few and apt words, exactly what a speaker desires to say, and an audience wishes to hear.

THE ARTISTS' AND AMATEURS' SOCIETY held its last *conversazione* for the season on the 4th of May, with a large and attractive exhibition of oil-pictures, water-colour drawings, portfolios of sketches, &c. &c. These *réunions* are most pleasant and profitable gatherings.

THE BRITISH ARCHÆOLOGICAL ASSOCIATION will hold its congress this year at Weymouth, under the Presidency of Sir W. C. Medlycott, Bart., D.C.L.

THE BURLINGTON FINE ARTS CLUB is making arrangements to have an exhibition of early examples of English water-colour drawings.

A STATUE OF GENERAL SIR JAMES OUTRAM, the funds for which have been subscribed by the friends and admirers of the late distinguished officer, is to be placed on the Thames Embankment, near Hungerford Bridge.

MESSRS. ANDREW HANDYSIDE & Co., the eminent and extensive iron-founders, of Derby, have issued a “trade volume” of engravings of vases, fountains, and other objects for gardens, lawns and conservatories. We have engravings of more than one hundred: some are from recognised models, such as the Warwick and Townley vases; the greater part, however, are from original designs, furnished by accomplished artists, some of whom are retained at the establishment. In so large a variety there is, therefore, ample room for choice; indeed, the only danger is from an *embarras des richesses*. They are charming ornaments, placed anywhere about “grounds.” They will bear the severest test of light; for as castings they are admirable, sharp and clear as marble, while as objects of Art their excellence will satisfy the most advanced amateurs and severest critics. It is of much importance to many to know where such productions are to be obtained. This is by

no means the only cast-iron work the firm produces: in the list will be found examples of railings, decorated tanks, pedestals, fountain-jets, and a score of other matters essential to the garden and conservatory.

ARTISTS' ORPHAN FUND.—His Royal Highness the Prince of Wales presided at a dinner (in Association with the Artists' General Benevolent Fund), the object of which was to augment "The Artists' Orphan Fund," towards which large sums have been already contributed; the total amount now exceeding £12,000. We have frequently referred to this project: the precise nature of which we are even now unable to comprehend. It is not, we believe, intended to form an Institution; but rather to place applicants, being orphans of artists, in some one or other of the Orphan Institutions already existing. We have strong doubts as to the policy of this plan. How will it be if *there are no artists' orphans to be found?* Such we more than think will be the result of the search the committee has undertaken to make. Matters may be changed for the worse since 1859; if there were no orphans then, there may be many orphans now: such, however, we believe, is not the fact. In that year (1859), Mr. S. C. Hall conceived the idea of establishing an Asylum for the orphans of artists, and transmitted to artists and Art-lovers some 300 or 400 circulars of which the following is a copy:—

"If an asylum for the orphans of artists be formed to my satisfaction—under circumstances of which I approve—and under such auspices as I believe will ensure its success, I am willing to present the sum of _____ to such Institution, or to contribute annually the sum of _____ to its support."

In answer to this appeal Mr. Hall obtained promises of gifts to the extent of £300, and of annual subscriptions to about the same amount. But he soon ascertained that he had commenced the work at the wrong end: that *no orphans of artists were to be found*, in England, Ireland, Scotland, or Wales; consequently the project was abandoned. It is hardly necessary to add that Mr. Hall took all possible means to ascertain that fact, before he relinquished the undertaking; writing first to the secretaries of the two Artists' Benevolent Funds in London and then to the secretaries of the several Art-societies throughout the kingdom: *there were no orphans of artists in need of help.* There may be some now; an eminent engraver, recently dead, has, we understand, left seven or eight children unprovided for; probably there are others: they must be sought out. We very much doubt, however, if this new charity be at all wanted, and are strongly of opinion that the plea so ably made by His Royal Highness, and the very large subscriptions that resulted from the appeal, will be of "none avail," on the ground that what would be freely given there are none to ask for!

MR. CHEVALIER, an artist of very great ability, who has been during many years travelling in Australia and New Zealand—exploring many intricate parts of these countries, dwelling for months together in "the bush," alone with his Art—is about to show the results of his brave and perilous journeyings, by exhibiting his drawings and sketches at the Crystal Palace. It will be a free exhibition; but one of deep interest and of great value. Probably it will consist exclusively of views in New Zealand—a vast country now very closely associated with Great Britain; more so, perhaps, than any other part of the world: yet, of which at present we know little or nothing. There are few who can conceive the stupendous

grandeur and the surpassing beauty of the scenery. Thousands will be astounded when they see these "portraits" of mighty mountains and delicious valleys: no doubt, the result will be to send many tourists to New Zealand—not so very far off, in days when steam annihilates space. Mr. Chevalier travelled part of the time in the suite of His Royal Highness Prince Alfred; and for him a large proportion of the drawings and sketches were made. The Crystal Palace is to be congratulated on this addition to its attractions.

THREE VERY CURIOUS AND INTERESTING PICTURES have been recently brought to England by Dr. De Plongeon, who obtained them in the interior of Peru, from an ancient church where they had been, almost literally, buried for centuries. There is no doubt whatever of the fact; Dr. Plongeon is a well-known and highly-respected man of letters, whose travels in Lima and Peru have been published in New York, and he is furnished with credentials of conclusive character. The principal of the three pictures is a painting of 'The Purissima,' evidently by Guido, which, however, contains the monogram of Murillo: it is a work of refined beauty, and worthy of the master to whom it may be safely attributed. Another picture, "attributed to Murillo," and obviously of the Spanish school, is a portrait of a young monk, St. Antonio, to whom the Saviour appeared as an infant while he was at prayer. The third is of undoubted authenticity—the work of the painter whose name it bears, Juan de Castillo, the first master of Murillo. It represents St. Augustin, Bishop of Hipona. The bishop is represented leaning on two large volumes lying upon the table, with their backs towards us, upon which we read these titles, "De Trinitate." He wears his mitre and robes; his head is raised as if in prayer. The face is singularly expressive, the eyes especially. Behind him, seen indistinctly in the depth of shadow, is the figure of a child, who seems as if about to interrupt him. This subject, we have no doubt, was suggested to the painter by the following legend of the church:

"One day, when the saint was engaged upon his great work on the Trinity, he went down to the seaside to meditate. Walking along the beach his attention was drawn to a child apparently at play, and he went towards him. The child had made a hollow place in the sand, to which he was carrying water in the palms of his hands, repeating the journey again and again. The Bishop said, 'My child, why do you do this?' to which the reply was, 'I wish to put all the water of the sea in the hollow I have made.' The Bishop smiled at the child's simplicity, and said, 'Nay, but you can never do this thing; it is impossible!' The child arose, and, looking up into the bishop's eyes, replied, 'And yet it is easier for me to do this than for you to comprehend the Trinity,' and vanished."

An examination of these curious pictures will amply repay a visit to the rooms of Dr. De Plongeon, at 25, Montague Street, Russell Square.

ΑΙΘΟΡΗΚΗ ΟΦΘΑΙΜΩΝ ΓΝΩΣΕΩΝ.—Such is the title of a monthly Greek illustrated magazine, of which the first two numbers have reached us. Proposed as an advertising medium for foreign merchants, it eschews the current politics of the day and devotes its pages to classic and modern scientific literature: as an illustrated periodical therefore it does not deal with incidents of every-day life. One of the papers in the first number is headed *Ιστορία του οφθαλμού*, another *Βιβλιοκρισία*, and a third is an article on Socrates. The illustrations in the two numbers are engravings from Turner's

classic pictures;—'Dido and Æneas,' 'Ulysses deriding Polyphemus,' 'Ancient Italy,' 'Venice,' and 'The Temple of Jupiter, in the Island of Ægina.' The second number has an engraving from MacDowell's sculpture-group, 'Love Triumphant.' The agencies established for the circulation of the magazine are numerous, comprehending every important town in Greece, also Constantinople, Vienna, and Manchester. It is published, in London, under the editorship of Mr. S. A. Parasyrakes.

COUNT D'ORSAY.—At a *conversazione*, held somewhat recently at the London Institution, some drawings by the late Mr. Nicholson were exhibited by Mr. Draper, who expressed a belief that the sculptured works especially, which passed as those by Count D'Orsay, were done by Nicholson. In our notice, last year, of the death of the latter, indisputable evidence was adduced in proof of the fact.

THE COUNCIL OF UNIVERSITY COLLEGE has paid Mr. W. Cave Thomas the compliment of electing him a Life-governor, in recognition of his services in the cause of education and Art.

THE SOCIETY FOR THE ENCOURAGEMENT OF THE FINE ARTS is making arrangements to open, in the autumn, an Art-college for students of both sexes, chiefly by means of lectures. It is proposed to commence the session with lectures on Æsthetics and the History of the Fine Arts, by Dr. Heinemann; on Anatomy, with a special class for ladies, by Mr. J. W. Walton; Light and Shade and Composition, by Mr. J. R. Dicksee; Perspective, by Mr. J. Saddler; and on Music, by Mr. A. Gilbert. Other lectures are in contemplation on Architecture, Geology, and Meteorology as applied to Landscape-painting, Modelling, Painting, &c.

A MÆDIEVAL SIDEBOARD of very great merit has been recently manufactured by Messrs. FRANK SMITH & Co., of Southampton Street, Strand, which we regret not to find in the International Exhibition, so as to have enabled us to engrave it. It is from the design of Mr. H. W. LONSDALE, a young architect of great promise, to whom has been awarded the "travelling prize" of the Royal Academy. The sideboard is in the mediæval style, is made of walnut-wood, and has a high back to it, surmounted by a cove in which are painted, on gold grounds, various fruits of the earth. Below the cove is a shelf for the display of old glass and china, &c., and, immediately underneath, there are small lockers, in the panels of which are painted the emblems of the seasons—four charmingly-designed heads. And again, in the centre of the panels of the lower cupboard of the sideboard, are depicted birds and beasts, fishes and insects. The metal hinges and locks, &c., are also worthy of note, which are made of highly-finished wrought-iron work, and being "tinned," form an excellent contrast to the dark colour of the wood. The work does great credit to all concerned in its production—Mr. Lonsdale, the designer, Mr. Hart, who painted the figures and emblems, and Messrs. Smith, the manufacturers. Messrs. Smith have obtained large and sound reputation as producers of ecclesiastic decorations and furniture. They are now, and with equal success, directing their attention to the manufacture of house-furniture of mediæval character—some examples may be seen at their establishment, and photographs of many they have executed. These will carry conviction of their capabilities to issue truly good things under the guidance of accomplished and experienced artists.

BRISTOL CHINA.—At a sale, in April, at Sotheby's, a tea-service of Bristol china fetched a most extraordinary price. The tea-pot was knocked down at £190, and was afterwards re-sold in the room for £210. The cream-jug sold for £115. A chocolate-cup and saucer, damaged, for £90, and other tea-cups and saucers at the respective prices of £70 and £40. The slop-basin, also damaged, fetched £60, and has since been resold for £75. True, the quality of the porcelain was exquisite, and the service had the additional value of the historic interest attached to it, for it was a present from Champion, the manufacturer, to Jane, wife of Edmund Burke, who that year, 1774, had been elected member for Bristol. The enthusiasm displayed on the occasion was unprecedented, and it appears, as related in Marryat's "Pottery and Porcelain," that Burke himself having stayed with Mr. Smith of Clifton during the election, ordered a service from Champion, which he gave to the wife of his host. Her initials S. S. are inscribed upon each piece of the service, which is carefully preserved in the family. The teapot that has now attained this unheard of price, is white and edged with a coloured decoration. It is enriched on each side with a central design representing Cupid standing on an altar, between Britannia who holds a cup of Liberty, and Plenty with his *cornucopia*. On the side of the altar is an escutcheon, bearing the arms of Burke-Nugent, and beneath, on the plinth, a Latin inscription setting forth that "Richard and Judith Champion gave this, as a token of friendship, to Jane Burke, the best of British women, on the 3rd November, 1774." The cover of the teapot is surmounted by a wreath of biscuit flowers. The decoration of the service is attributed to the enameller, Henry Bone, R.A., at that period an apprentice to the Bristol Porcelain Manufactory. At the same sale, one of those biscuit-plaques with a wreath of flowers in relief, for which Bristol was so celebrated, having the Burke arms, sold for £99, and a similar specimen, with the initials J. B. (Jane Burke), for £53. Who will not admit that Bristol china is literally worth its weight in gold.*

MESSRS. LIAS AND SON have exhibited, privately, a chalice and paten, silver, richly gilt, made by them for the Rev. W. Sparrow Simpson, to be presented by him to the Cathedral of St. Paul, of which he is a minor canon. The chalice is in the style of the Renaissance: its height is 10½ inches, the bowl engraved with wheat and grapes, and enriched with six medallions of the symbols of the Passion—viz., the cross, the open book, the Agnus Dei, the three nails, the crown of thorns, and the sponge and spear—all in high relief. The ornamented stem is relieved with bright flutes, and the principal boss enriched with six medallions of the Greek cross. The whole of the base is elaborately chased (*repoussé*) with wheat and grapes, and enriched with six medallions containing the Latin cross and sacred monogram; the *chiro*, the arms of the cathedral, and the arms of the donor. Underneath the base is a suitable inscription, having reference to the giver. The paten measures 8 inches in diameter: the centre is quite plain, the edge being engraved with wheat and grapes, and enriched with six medallions—the symbols of the passion—to correspond with the bowl of the chalice. Both are admirably made—fine examples of sound and graceful workmanship.

* The chocolate-cup and saucers, which sold for £90, would weigh about 6 oz. This would be four times more valuable than an equal weight of gold.

REVIEWS.

A MEMOIR OF DANIEL MACLISE, R.A. By W. JUSTIN O'DRISCOLL, M.R.I.A., Barrister-at-Law. Published by LONGMANS & Co.

WE are not in the least disposed to scan too closely the claims of this little volume as an adequate tribute to the memory of a distinguished artist, for its author entirely repudiates any such pretension; and there is no attempt to analyse the character of the works of Daniel Maclise, or to pass judgment upon them. Mr. O'Driscoll's sole object appears to have been, as the intimate friend of the lamented painter from his boyhood, to put on record some recollections of his earlier years, and to associate with these such events of his after-life as his correspondence and works give rise to.

The late Mr. Sainthill, of Cork, and Crofton Croker were the first to recognise Maclise's talents when he was a young boy studying in the School of Art in that city. A sketch he made of Sir Walter Scott, when the great novelist and the lad happened to be together in a bookseller's shop in Cork, brought him great notice, and soon after he commenced practice as a portrait-draughtsman, in which he found full employment. "As his marvellous skill of hand," writes his biographer, "became every day more extensively known and conspicuous, men of genius, wealth, and eminence were to be found in his *atelier* sitting for their portraits, or glancing over the last creations of his magical pencil. . . . He was then a singularly fine and muscular lad, and rather famous for feats of agility and strength." In 1827 he was in a position to accomplish a long-cherished wish—that of coming to London, and entering the schools of the Royal Academy. Crofton Croker exerted himself at this important epoch of the artist's career to make his talents known to those who were able to promote his interests—men and women of literary fame, of whom Mr. O'Driscoll gives a rather extensive list. The award to him of the gold medal by the Academy, in 1829, for the best historical picture from a given subject, 'The Choice of Hercules,' was a triumph that naturally filled the young painter's mind with unmeasured delight; and he pours forth all his exuberance of feeling in a characteristic letter to a friend, Mr. (afterwards Dr.) Mac Evers: "The *Times*, *Morning Herald*, *Post*, and all the evening papers," he writes, "noticed me, and I shall be puffed outright, I think, in the literary papers. I have notes from all quarters; this moment, one from L.E.L.," (Letitia Landon)—"Your well-merited success gave me every pleasure but surprise."

The most attractive part of the volume will be found in Maclise's letters, especially such as passed between him and his intimate friends, Mr. John Forster and Charles Dickens. None of them throw any, or at least much, light upon his Art; they are little else than personal narratives, descriptions or places he visited—Paris, for example. The correspondence respecting the works executed by the painter for the Houses of Parliament occupies many pages, but we learn from it nothing more than what at various times has been discussed and animadverted upon in our own columns. It is evident Maclise felt most deeply what his biographer calls "the injustice with which he was treated by the Fine Art Commissioners"—treatment "well calculated to wound his feelings and depress his energies. On the other hand, he must have derived some satisfaction from the sympathy of those whose prominent position in the Art-department of literature made it more than ordinarily acceptable. Intrepid remonstrances, addressed to the Palace authorities, appeared in the columns of the *Art-Journal*, *Athenaeum*, &c., but without the slightest effect."

From the Art-point of view, this memoir of the painter from the pen of his friend, may not be all one would desire to see; yet we by no means regret that Mr. O'Driscoll undertook the task. He says he presents his book to the public with "unaffected diffidence;" this he need not to have remarked; his story of the artist's *life*, so far as it extends, is very pleasant reading; it is written in a frank and genial spirit, by one

whose taste and judgment have led him to know where to stop in matters of personal interest, so as not to intrude the feelings of private friendship into a narrative that concerns only the painter in relation to the public. Maclise's labours in the studio tell their own tale.

HANDBUCK FÜR KUPFERSTICHSAMMLER. Von Dr. ANDREAS ANDERSEN. Published by T. O. WEIGEL, Leipzig.

Although based upon Heller's handbook, we do not hesitate to record Dr. Andersen as the author of this work; for he has made it, as it were, his own by very careful revision and laborious and extensive additions. Heller's book notes none of the artists of the last twenty years—indeed, a compilation of this kind, to be perfectly useful, must keep pace with the times; and even a few years hence Dr. Andersen's work will require a new edition. The portion now published extends only to Dürer, the multiplicity and variety of whose works thus catalogued and described enhance in the estimation of the artist the already brilliant reputation of this man. We recommend the work conscientiously as indispensable to the print-collector, and as a valuable auxiliary to the Art-student and essayist.

THE PEARL PHOTOGRAPHIC ALBUM. Designed by MRS. BARRINGTON. Published by A. SHAPCOTT, Rathbone Place.

This very admirably-bound and beautifully "got-up" album has nearly 200 designs for enclosing photographs, of various sizes, ranging from a square inch to six or eight square inches, some of the pages containing spaces for half-a-dozen. Many of the designs are novel and beautiful; the artist has resorted for suggestions to all imaginable sources, some of which are hardly within the sphere of Art. Leaves and flowers naturally give here the best supply, and of these she makes judicious use.

The book, therefore, either nude or fully clad in photographic graces, will be accepted as a desirable acquisition to the drawing-room; and to fill it may be a pleasant task to the circle in any home. The prints are in outline, and fair hands may fill them up; colouring the designs and, it may be, putting drawings into the frames: indeed, suggestions are made for such drawings, and taste and ingenuity as well as Art may be exercised in making of them memorial pictures.

The publisher has done his part with great liberality—in binding, printing, and paper.

AN ILLUSTRATED NATURAL HISTORY OF BRITISH BUTTERFLIES. By EDWARD NEWMAN, F.L.S., F.Z.S., &c. The Figures Drawn by George Willis, and Engraved by John Kirchner. Published by W. TWEEDIE.

Premising that we have not the least sympathy with the pastime of butterfly-hunting—for which boys of all ages appear to have a most provoking special predilection—we may remark that Mr. Newman's dissertation upon the beautiful insects will be found very useful to those who pursue the subject as a study of natural history, by enabling them to distinguish their varieties, and to ascertain the localities where each is to be found. The information is ample and intelligent; while the engraved specimens are, so far as the absence of colour permits, sufficient for identification.

OLD MERRY'S TRAVELS ON THE CONTINENT; with numerous Illustrations. Published by HODDER AND STOUGHTON.

We cannot say if "Old Merry" be or be not a noun of multitude; but all the books that bear the name are sound and good—interesting and instructive. There is nothing very new in this pretty volume, but the several journeyings are pleasantly recorded, and may be read to great profit by the young. The writer takes us to familiar places—not only as an intelligent guide, but as a cheerful companion and a judicious counsellor, making the way agreeable and "merry" by anecdote and tale. The engravings are of much excellence, illustrating the text by buildings, scenery, costumes, &c.

THE ART-JOURNAL.



LONDON: JULY 1, 1871.

THE ROYAL ACADEMY.

THE ONE HUNDRED AND THIRD EXHIBITION.

SECOND NOTICE.



HE Academy sustains its success: it does not suffer, like some associations, under severe competition: the Exhibition proves as popular this year as in prior seasons. The noble galleries during the past month have been thronged first by Londoners, and then by the usual influx from the provinces. The British public has an insatiable appetite for exhibitions, and the Academy will always be specially favoured, because there alone can the Art of our times be fairly judged and fully enjoyed. In our first notice we carried our review into the Great Gallery, we then criticised many of the leading figure-compositions. It now remains for us to notice several important foreign contributions, also some of the more conspicuous portraits, and some few remarkable landscapes. We reserve further space for this Great Gallery, because it is once more deliberately hung as a climax to the entire collection. Its table of contents serves as an index of the efficient forces of the Academy: no less than thirty-four Academicians and Associates honour the room with their presence and adorn its walls with the best products of their talents. Yet if the number had been fewer, or the talent greater, the Exhibition would have suffered less. Academicians from time to time need to be weeded out, and young rising men to be planted in their place. Nevertheless, whoever would know the present phases of our national Art, whoever would acquaint himself with the relative merit or preponderance of historic painting, *genre*, portraiture, and landscape, must take stock of the 104 pictures specially selected for this *salle d'honneur*.

GALLERY NO. III. (Continued.)

T. WEBSTER, R.A., has of late years contributed to the Academy but sparingly. His work is always deliberate and mature, his compositions, though seldom novel, are never hasty. 'Volunteers at Artillery Practice' (138) is a picture which serves up pleasantly old materials. Mischief-making boys, with faces as round and as ruddy as apples and cherries, are playing at soldiers. The little fellows are old acquaintances, we have long known of their pranks in the school-room, of their romps in the playground. Webster has not so much variety

as Wilkie: his incidents, though lively, have no great action, his figures are staid and often motionless. Yet no artist better understands the nature of boys, especially when comic, naughty, or ready for a practical joke. In the way of quiet, sly by-play Webster is not surpassed by any of our humorists, whether they be writers or painters. For small pictures of the Dutch type humour is the most serviceable of mental states and conditions: a loud laugh throws a composition out; a quiet smile is more easy of pictorial management. The English school has abounded in humour, Leslie was a humorist; the Scotch often fall into a broader vein—they pass into dry drolery. Glancing round the present exhibition we perceive in the works of F. D. Hardy, Pettie, Nicol, and others, that our painters are never happier than when they succeed in provoking a smile. As a rule, our Academy is less tragic and more cheerful than the exhibitions of the Continent. "Cheerfulness," says Addison, "keeps up a kind of daylight in the mind, and fills it with a steady and perpetual serenity." It is sometimes hard for a nation to be cheerful: we imagine that in coming years the Art of France may be tragic, deeply shadowed, melancholy, but scarcely cheerful. A sense of guilt, a feeling of suffering takes from a nation's Art its sunshine and serenity. In England only can pictures wear habitually a smiling countenance: the blessings our country has so long enjoyed have made our national Art emphatically cheerful. The pictures of THOMAS FAED, R.A., usually speak of a life tranquil and content, of a conscience at ease, of a home made happy, of a peasantry industrious, honest, dutiful, true to the domestic affections, simple cottagers who never break into ambitious rebellion against the humble lot assigned to them by Providence. Under the title 'A wee Bit Fractious' (150), Mr. Faed paints a mother and child: the tenderness of the mother's love is true to nature. The general style and treatment in noway differ from the artist's prior work. Solid, straightforward painting from a well-chosen model; texture, a broken harmony of colour; and a broad realism in the draperies and accessories, justify the popular favour pictures of this class receive. A most commendable study is produced by Mr. NICOL, A.R.A., of a weather-beaten old tar 'On the Look Out' (184). The handling is masterly: Denner never painted wrinkles on a face more literally; but this is faint praise for a head which has a life and a vigour wholly beyond Denner's reach. 'The Missing Boats' (166), by A. H. MARSH, is of an unmitigated naturalism: the figures are awkward and ugly. Yet a work of this unswerving fidelity and uncompromising truth is of promise for the future. Mr. Marsh is a recently-elected associate in the Old Water-Colour Society. 'The Prisoner and his Guests' (183), by W. F. YEAMES, A.R.A., has a quiet naturalism much to be preferred to the artist's historic effort in the last room. Mr. PETTIE'S 'Pedlar' (179) exemplifies the prevalent humour of which we have already spoken. In a style more refined are a brother and sister 'Coaxing' (139), by H. LE JEUNE, A.R.A. This artist's pictures if not strong are charming: the figures are generally elevated above common nature. J. ARCHER, R.S.A., has also a refined way of putting an incident on canvas. 'The Peacemaker: a Sister tries to reconcile two Brothers' (225) is a well-considered work, duly balanced and evenly painted. J. R. HERBERT, R.A., aspiring to be poetic, falls into bathos. 'All that's bright must fade' (206), were it not so large, might pass for *genre*; at any rate,

it is little else than a poor costume-picture. A butterfly alighting on the lady's head is scarcely sufficient as a pictorial conception to transmute prose into poetry. The colour is dead, opaque, discordant. The artist has been at pains to get a great way off from nature; he seems to have thought that his subject might be thus sublimated. The result is that the picture is about equally removed from nature on the one side, and Art on the other.

Portraits in the new rooms of the Academy do not provoke so much complaint as in the old. The increased space renders the prescriptive portrait of a gentleman or of a lady less obnoxious than heretofore. It seems practicable to distribute no fewer than twenty-nine portraits, more or less pleasantly, about the Great Gallery, and in number as well as in merit these works fairly represent the present phases of the art in England and in Scotland. Beginning with the President, the 'Equestrian Portrait of J. G. Legh, Esq., Master of the Hertfordshire Hounds: Huntsmen and Whips' (216), is remarkable as including no fewer than eighteen dogs, four horses, four red coats, four black hats, all severally approaching the size of nature. The horses and the dogs will be particularly appreciated in the provinces. Yet a picture made up of these materials can scarcely rank as a work of Art. Mr. WELLS, R.A., at the present moment takes the lead among our portrait-painters, especially when anything is needed so substantial as a statesman. 'The Right Hon. Henry Austen Bruce' (154), by this painter, is every way worthy of presentation to the Home Secretary "by his friends and the electors of Merthyr Tydvil, Aberdare, and Vaynor." Some painters hand down a man to posterity as a petrification: Mr. Wells, on the contrary, endows his sitters with life and animation: his attitudes are free; even when a figure is at rest it seems ready to assume motion; a member of the government if not speaking, very properly gives signs of thought and deliberation. In an Art point of view also, the portraits of Mr. Wells are the reverse of slight or superficial. They are literal and yet not prosaic. Among the leaders of parties in the legislature attention is naturally drawn towards 'His Grace the Duke of Richmond' (152), by the Hon. H. GRAVES. The style is not very firm or quite masterly, yet the intention is good, and the picture altogether something more than amateurish. The painter has gained strength since last we met him. Strong, at any rate in force of background, are the portraits of J. P. KNIGHT, R.A.: good, quiet, and plain in style is 'The late Dr. Green, Professor of Anatomy to the Royal Academy' (159). The number of celebrities here congregated is, as usual, great; indeed, the weight of intellect is in excess of the quality of Art. The loss of Sir Watson Gordon is again felt, yet the Scotch school remains forcible. One of the best of the kind is 'Lord Cowan, Edinburgh' (204), by N. MACBETH, A.R.S.A. The manner may be rather prosaic, and notwithstanding the presence of red, we feel the absence of colour. Somewhat brilliant, recalling indeed, with a difference, the manner of Lawrence, is the portrait of 'Mrs. Peter Simpson' (174), by D. MACNEE, R.S.A. Among Scotch artists successful in portraiture must also be mentioned Mr. ARCHER and Mr. HERDMAN. Either Mr. SIDLEY, or his sitter, 'The Right Hon. James Stansfeld, M.P.' must be faulty in colour: otherwise, however, the picture is commendable. R. BUCKNER and J. SANT, R.A., have points in common: they are alike favourites with the ladies, their figures

are dressy and move in good society. 'Lady Poltmore' (211), by Mr. Buckner, is eminently in the style of fashion. A full-length portrait (162) without a name, by Mr. Sant, has also the merit of being sunny, romantic, and pleasing. Taken for all in all, the finest portrait of the year is that of 'George Grote, Esq., Vice-Chancellor of the University of London' (165), by J. E. MILLAIS, R.A. This artist does not simply paint a portrait: he at the same time makes a picture, admirable for drawing, colour, and texture. Truly great portrait-painters have always been colourists: witness the Venetians and our own Reynolds. We fancy Mr. Millais may have modified, and in some way exalted, his style by converse with Mr. Watts. Of mutual fellowship we have here proof, in the head of 'J. E. Millais, R.A.' (172), by G. F. WATTS, R.A. Character in its breadth, and colour in Venetian depth, mark the manner of Mr. Watts. A less successful head is that of 'F. Leighton, R.A.' (177). Mr. Watts is not thorough or complete in execution; as soon as his idea dawns upon canvas, even dimly, he throws down his brush. Among portraits of artists by fellow-artists is a dashing, sketchy head of 'John McWhirter' (190), by J. PETTIE, A.R.A. These several portraits of Mr. Millais, Mr. Leighton, and Mr. McWhirter, suggested at the Academy dinner the reference of the Lord Chancellor to "the portraits of the great painters of every time and country since the revival of Art painted by themselves. Few there are accustomed to the works of master-minds who are not pleased to possess a more complete embodiment than fancy can suggest of the form and fashion of the countenance. I trust," continued the learned lord, "there may be hereafter a collection made under the sanction of the President of this Academy of the great artists of modern times, painted by their contemporaries." It is known that Mr. Watts has for some years been engaged in painting the great men of the day. The series, which has become numerous, there is reason to hope, may at some time be presented to the nation.

Landscapes are here rather at a discount, because they are supposed not to furnish a large gallery so effectively as figure-pictures. Still a few masters not so well represented in the other rooms must claim our brief attention. Mr. MASON, A.R.A., scarcely belongs to landscape-painting proper; he holds in fact an intermediate position between simple nature and human incident, and one great charm of his works consists in the perfect relation and reciprocity between all the elements in his pictures, whether animate or inanimate. Thus, in 'Blackberry Gathering' (168), the figures, in action, colour, and mode of handling, are in absolute unison with sky, trees, and foreground. The style is Italian rather than English, romantic rather than realistic. It may be reckoned as one of the many reactions to Pre-Raphaelitism. G. E. HERING displays accustomed refinement and sentiment, with more than usual breadth and force, in 'Arran Moorland' (140). The study of sky is remarkably fine. C. H. POINGDESTRE, an artist of whom the island of Jersey has reason to be proud, contributes a poetic landscape, perhaps the best fruit of his long Italian residence, 'The Marble Quarries at Carrara' (235). E. W. COOKE, R.A., gains the literal foreground study which C. H. Poingdestre lacks. 'A Bit of English Coast' (224) is remarkable for faithful transcript of crumbling cliff and shingly shore: the boats and fishing-tackle have photographic truth.

J. C. HOOK, R.A., has visited Norway

with doubtful benefit. 'Salmon Trappers' (163), in that country, is a work inferior to fishing and coast-scenes in the Scilly Islands and on the shores of Devon, with which this artist has made us familiar. Norway is a country likely to lead Mr. Hook astray; her landscape is calculated to aggravate rather than to mitigate the painter's mannerism. In that northern latitude, fields and hill-sides, on emerging from their winter-coat of snow, break out into a crudity of green abhorrent when on canvas. The late Professor Forbes, in his instructive volume on the glaciers of Norway, showed by illustration as well as by letter-press that Scandinavia yields to no country in wild grandeur and pictorial sublimity.

'The Wooden Walls of Old England' (195), by C. E. JOHNSON, though a poor picture, was honoured with special mention by the First Lord of the Admiralty at the Academy Dinner. "I will ask," said Mr. Goschen, "the Academicians here present, that if this year they have painted 'The Wooden Walls of Old England,' they will paint next year, if their genius be equal to it, the iron bolts, which are as necessary to our security as were the wooden walls. If you have painted this year 'the wooden walls' of old England—

"Bright old ships, whose names are rich in story,
Your bead-roll sounds the notes of England's glory!"

—if a distracted painter should rush to Portsmouth in search of a subject for next year, he will not be discouraged by the outward lines of the ships he may meet with, for he will see there types worthy of his pencil, because they are the types of science and of strength." With due submission we may be allowed to express the opinion that Mr. Goschen is wrong. In the navy of the future it is hard to realise the possibility of a subject so grand as that chosen by the late Clarkson Stanfield, 'The Victory towed into Gibraltar after the Battle of Trafalgar.' And with the destruction of "the wooden walls," the art of marine-painting seems to have likewise perished. The paucity and poverty of sea-pieces in the Academy is remarkable, especially when we remember that a few years since our English painters, Neptune-like, held dominion of the ocean.

Animal-painting, in the much-deplored absence of Sir Edwin Landseer, falls into the hands of Mr. Ansdell, Mr. Cooper, and Mr. Beavis. Mr. ANSDELL is painfully hard, mechanical, and discordant; his pictures seem to have an interest for the public by the amount of matter-of-fact material he crowds into them, as for example, 'Goatherds: Sierra Nevada, Andalusia, Spain' (229). 'The Way o'er the Heath' (173) is a fair example of Mr. COOPER'S style. Mr. BEAVIS seems likely to justify the expectations his talents have raised; 'Autumn Ploughing: Showery Weather' (180) is a great advance. The artist is gaining in experience; he is also more careful and studious. The style, of course, recalls Rosa Bonheur: it would seem impossible for oxen to plough otherwise than in the manner made familiar by this lady. Yet Mr. Beavis goes direct to nature, and the onward movement, the tumbling-along weight and cumbrousness of the team, are admirably rendered. The picture has great power. We must not forget to point to a brilliant 'Balcony' (205), by Miss A. F. MUTRIE. The flowers by this lady and her sister are always a delight—there are none better.

Foreign artists are scarcely more prominent in this exhibition than in those of previous years. It is true that the calamities of war have driven some painters to seek refuge in England; and yet, on the other hand, many have been barred access by

the rupture of the ordinary means of communication. Also we have to take into account the fact that foreign works have been drawn away to the International Galleries at Kensington. We deem it fortunate that under combined circumstances no more pictures from the Continent have obtained admission. An English academy is primarily for native talent; and, considering the vast number of British works crowded out, it is not right that second or third-rate pictures from abroad should obtain exceptional favour. The galleries at South Kensington will always be open to "rejected addresses," and thus pictures which fail in the Academy need not be committed to a cellar or a garret. It is a little disappointing, and somewhat remarkable, that the overtures made by our Academy to foreign artists of renown have met with no adequate response. It is true that painters without name or position send contributions wholesale; but it is, we repeat, not a little strange and discouraging that, out of six "Honorary Foreign Academicians," M. Gérôme alone presents himself. And what makes matters rather worse, is, that the contributions of this amazingly clever painter are not over welcome to persons of refined or fastidious tastes. 'Cléopâtre apportée à Cesar dans un tapis' (144) is a picture which obtains more notice from gentlemen than from ladies: and yet it is not so much improper as disagreeable. The flesh tones are black and opaque—indeed, all the qualities admired in Titian are here absent. The best piece of painting in fact is not Cleopatra, but the carpet. This picture of unblushing nudity is an example of that school of French Art which will be identified by posterity with the second French empire.

Nobler in aim and purer in moral principle are the works which from time to time M. LEGROS has exhibited, and, indeed, painted, in London. 'Chantres Espagnols' (187) is in fact more closely allied to Spanish than to French schools. The figures of the seated ecclesiastics are solemn and massive, the modelling is firm, the colour sombre, yet rich in shadowed harmonies. This work shows persistent study prolonged over some years. The characters, strongly pronounced in individuality, have appeared separately in the Dudley Gallery and elsewhere. For example—one of the most solemn and stately in this priestly assembly is a life-study taken from an organ-grinder in London streets. Mr. RUDOLPH LEHMANN is another painter who has tarried so long among us that we begin to regard him as one of ourselves. His style, however, remains essentially foreign, and that, German rather than French, as specially manifest in several portraits in the Academy. 'May we come in?' (197) has a personal interest: family portraits are here wrought into a pleasing *genre*-picture. The artist himself, standing before his easel, is brought within view by means of a mirror. The execution is softly delicate, the sentiment essentially refined. L. PERRAULT, whom we have been accustomed to meet in the "French Gallery," is also one of the many artists who now seek in England peace and quietness. 'Bo-Peep' (229), though soft and waxy, has a pretty sentiment which obtains wide sympathy, but the style wants nature and simplicity. W. W. OULESS, a resident in London, and an exhibitor in the Academy for three successive years, is somewhat foreign in style. 'An Incident in the Revolution, 1792' (142), has considerable power; while 'Sympathy' (232) passes into tenderness. This artist is worth watching; he has knowledge and Art-instincts which

promise that he may do much. M. DE HAAS, the Dutch cattle and landscape-painter, is unworthily represented. ALMA TADEMA, another famous Dutchman, seems likely, in more ways than one, to find England pleasant and profitable. He has taken the house and studio of Mr. Goodall, the Academician, and is to be congratulated on his prospects. His present picture, a murdered 'Roman Emperor' lying in a heap upon the marble pavement, is not very much to our liking; 'The Vintage,' exhibited at Mr. Gambart's Gallery, is a far better and more pleasing work. Mr. Tadema will have to contend against a mannerism which, if he do not conquer in time, will obtain uncontrollable mastery over him. In his pictures human figures are apt to be borne down, and all but annihilated, by realism and materialism. Marbles and mosaics, though painted to illusive perfection, can never have the worth and dignity of historic Art. The great painters of this class have always made the palace subordinate to the emperor, the pomp and outward trappings of royalty of inferior moment to the drama of humanity. Tadema's figures are sometimes shadows, sometimes dolls, and sometimes only bundles of clothes.

GALLERIES NO. IV. AND V.

In these two galleries the interest is sustained by a somewhat miscellaneous assemblage: there are few pictures which attract greatly, and yet no rooms are more crowded. Gallery V. is distinguished with doubtful advantage by the presence of works of unusual size. For instance, here hang 'Contadine in St. Peter's, Rome' (359), by K. HALSWELLE, A.R.S.A.; 'A Wild Stag at Bay, with Portraits' (360), by S. CARTER; also a large work (406) by R. ANSDELL, R.A. The general impression that in this room size prevails over quality becomes irresistible as soon as one sees, hung full on the line, 'Lady Jane Grey' (395), and 'Winter' (414), severally by R. THORBURN, A.R.A. So long as members have a right to usurp the best places by the worst of works, the Academy will have to submit to censure and public outcry. Barring this example of manifest injustice to outside talent, the hanging is fair and judicious. Almost every picture can be seen: some contributions, it is true, are at a height of a fourth story from the ground, but when the canvases are large the rows are not more than two, or at most, three deep. With few exceptions, pictures near the ceiling are not worth looking at. The contents of Galleries IV. and V. may be analysed as follows:—Total number of pictures, 192. Of this total 16 are contributed by eleven Academicians, 6 by five Associates, and 170 by one hundred and sixty-two outsiders. Of these outsiders thirteen are foreigners, who contribute 14 works.

Several artists present in these galleries have already obtained notice. If we are now obliged to pass them by, it is not from want of respect but simply from want of space. The most important contribution by P. F. POOLE, R.A., claims priority. The scene taken from *Cymbeline*, 'Guilderus and Arviragus lamenting the supposed Death of Imogen' (312), is in Art-quality similar to recent works of the painter. Form is merged in undefined mist: poetry and sentiment are rubbed in or scumbled with a film of opaque white. Yet to the picture may be conceded imagination—even genius. J. E. MILLAIS, R.A., has been already noticed: the 'Somnambulist' (313) comes as a fresh proof of the artist's versatility and artistic skill. 'A Doubtful Proposal' (269)

may be noted as perhaps the best contribution of C. LANDSEER, R.A. His brother, T. Landseer, has not appeared for several years as an oil-painter. Of the three brothers of the name of Landseer at this moment within the Academy, Mr. THOMAS LANDSEER, A.E., shows especial readiness when he throws aside the graver and takes up the brush to delineate a 'Deluge of Rain passing into a Waterspout' (244). The work can scarcely be measured by ordinary standards. Whatever be its shortcomings as to detail and technical qualities, the whole scene displays grasp of imagination, with no ordinary power of educing from the materials in hand the utmost pictorial effect.

'Contadine in St. Peter's, Rome' (359) is the most powerful work yet produced by K. HALSWELLE, A.R.S.A. Yet the means the artist employs are common and claptrap. The figures are but costume-models, the sentiment is trite, not to say vulgar. We cannot congratulate Mr. Halswelle on his success, but we can speak in high praise of his talent, which only needs severe chastisement to bring it right. Like power, not to say effrontery, is manifest in an amazingly clever 'Study of an American Slave-Girl' (412), by R. GAVIN, who, like Mr. Halswelle, carries as his credentials the letters A.R.S.A. Also to a rather dashing style belongs 'The Elopement of Dorothy Vernon with Sir John Manners: Haddon Hall' (354), by A. JOHNSTON. Artists thus clever could afford to be less clamorous for ephemeral applause. E. OPIE, who bears an honoured name, and who, like the "Cornish genius," comes from near the Land's End, contributes an honest nature-study, 'On the Seashore: a timid venture' (325); Mr. Opie has still to seek refinement and Art-treatment. T. BROOKS has a pretty, pleasing picture, 'A Story of the Sea' (316); the figures are gracefully grouped upon the shore. As a curiosity we regard 'A London Merchant fishing for Salmon off the Old Swan Stairs in the Sixteenth Century' (261), by J. RITCHIE. The subject is new and worth the painting. The picture has deservedly attracted observation. Also eminently original and suggestive is J. MACWHIRTER'S donkey on the sea-shore in a deluge of rain, with the quotation,

"A great while ago the world began,
With bey, ho, the wind and the rain."

These two galleries, it will be perceived, are distinguished chiefly by works of promise by rising men. Here we find Mr. STOREY'S best effort, 'Lessons' (277). The execution may want firmness, the forms definition; in seeking light the artist has lost substancy: yet the picture has delicacy in tender greys, and much quietude and refinement of sentiment. Mr. Storey will some day win his way to the Academy. Mr. CROWE satirises "Friends" seated in a Quakers' Silent Meeting. The artist bases his dry humour on the perversion of truth; the picture evinces more mechanical skill than Art-intuition. Mr. J. BURK, in 'Fifth of November' (294), is endangering the position he once won: he would succeed were he content with truthful realism and simple naturalism based on Wilkie, Teniers, or Ostade. F. D. HARDY exhibits two scenes after his happiest mood, wherein children are the actors, 'House-keepers alarmed' (321) and 'Explorers' (299). The artist is felicitous in a sort of hide and seek, in a surprise of light in shade. An episode he can master, a main action he mars. It is extraordinary how hard it is even in smallest spheres to succeed wholly. Thus for years F. D. Hardy and George Smith have each been

near to the highest point in *genre*, and yet because Webster and Wilkie, not to mention old Dutchmen and living Frenchmen, are or have been much beyond them, their talents lie in comparative neglect. In Art, as in all other matters, to attain to something more than respectable mediocrity is not hard, but to climb to what Alpine travellers term "inaccessible summits," is a feat permitted but to few. And it seems to us that Mr. GEORGE SMITH has just failed at the point when he might have fondly hoped the highest summit had been reached. 'The Last Scene in the Gambler's House' (376) is not one picture, but a succession of pictures. The canvas is five feet long, and contains upwards of fifty figures. The composition, instead of being brought to a climax, is scattered. This auction in a gambler's house wants the dramatic intensity which Wilkie threw into 'The Rent Day' and 'Reading the Will.' Yet Mr. Smith shirks no figure, slurs no accessory, every part of his picture is wrought with utmost care. We think very highly of a contribution by Mr. A. C. GOW, 'Captain Bobadil' (276). For humour, delineation of character, colour, and sparkle of execution, this picture has few rivals. Worthy of commendation are the 'Blackberry-Girl' (372), by G. WELLS; 'The Course of a Lover never runs smooth' (428), by H. B. ROBERTS; 'Sand-pit on Hampstead Heath' (426), by H. WEEKES; 'The Goose Girl' (361), by E. G. DALZIEL; and 'London Street Flowers' (327), by Mrs. S. ANDERSON. Among foreign painters who practise *genre*, again appear Fagerlin the Swede, Bource the Belgian, and Frère the Frenchman. The manner of these several painters is pretty well known; and it so happens that neither is quite at his best.

The portraits in these two galleries are numerous and good. The royal pictures we are sorry not to be able to accept as the best efforts, either of the Hon. H. GRAVES or of C. BAUERLE. A clever picture is made by P. A. FRASER, 'At the Fireside (portraits)' (247); but the detail in the background savours of the broker's shop. RUDOLPH LEHMANN has a quiet, refined manner; his colour may be the reverse of brilliant, and his flesh-tones are not very transparent; yet there are few portraits in a higher style than that of 'Mrs. Matthews' (424). The mere absence of colour and the tasteful use of black, come in these garish days as a relief. In equally pure style are 'A Castilian Lady' (393), and the portrait of 'Mrs. William Holdsworth' (471), by the late T. F. GOODALL. These works show in nice balance taste, talent, training. It is with extreme grief that we think of the sad fate of this young man, destined, it would have seemed when last we saw him, to attain the highest rank in the profession. His death is not only a bereavement to his family and friends, but a loss to Art.

It has been the good fortune of J. P. KNIGHT, R.A., to transmit to posterity the well-known features of men who have deserved well of their day and generation. Every one will recognise at a glance the faithfully and strongly-delineated head of 'Sir William Tite' (358), painted by subscription for the Royal Institute of British Architects. Equally vigorous in style and individual in character are 'Samuel Mendel, Esq.' (322), and 'Joseph Mayer, Esq.' (322); the latter painted by public subscription in commemoration of the opening of the Mayer Free Library and Pleasure-Grounds in Bebington, Cheshire. We also think very highly of LEGROS'S full-length of 'Randle Wilbraham, Esq.' (351), presented by his tenantry. The head stands out in the

strong firm relief of a bust; the hands, marked with character and detail, carry out the general expression. The stand of the figure is firm, almost immovable; indeed, the portrait may be termed somewhat monumental. Another tribute of respect is a large portrait-picture, by S. CARTER, entitled 'A September Evening: Exmoor Forest—a wild stag at bay, with portraits' (360). The artist can paint a horse, also a hound, and he is not deterred by difficulties which would dismay most men. The picture is large; it is crowded as a huntsman's meet: Sir Francis Grant, who is at once sportsman and painter, might almost envy Mr. Carter his success. The drawing and handling are good; perhaps the attitudes are sometimes awkward; certainly Sir Edwin Landseer would have endowed the brute creation with more grace.

EDWARD ARMITAGE, A.R.A., is privileged in the way of portraiture to exhibit a large mass of brain. 'A Deputation to Faraday' (311) includes, in addition to the professor, Lord Wrottesley, Mr. Gassiot, and Mr. Grove. Science is imprinted in the collective heads; the artist has certainly given weight and force to the assembled intellect. The picture would have been more attractive with greater colour; a certain dry chalkiness might with advantage have given place to warm liquid hues. An equally meritorious picture near at hand suffers from like causes. The earnest student-head of 'The Rev. F. D. Maurice' (314), by S. LAWRENCE, is carefully modelled in form, and is wholly satisfactory in expression; but as to colour and quality in flesh-painting, the work is woefully wanting. Miss STARR shows mastery, with a sketchiness almost approaching negligence, in 'Amy, daughter of Sir John Lubbock, Bart., M.P.' (391). This talented lady's portraits have usually been in marked contrast with her fancy compositions. Her portraits—that is, her literal studies from the life—have a truth and vigour which become lost in her elaborated works. The only portrait that remains to be noticed is a brilliant and stylish full-length of 'Lady Susan Bourke' (287), by R. HERDMAN, R.S.A. The cast of the drapery is admirable; the face would admit of more delicate modulations: this effective picture is injured by the colour in the background.

The landscapes and miscellanies are more numerous than remarkable. Among the contributors, Peter Graham, Birket Foster, Mark Anthony, Alfred Hunt, and James Danby are the best-known names. 'The Rainy Day' (348), by PETER GRAHAM, is a mistake; it is seldom wise to paint what in nature is unpleasant; and here matters are made worse by awful colour. In the next room the artist is himself again. Miss OSBORN'S 'Hay-Boat' (268), with pretty children nestling playfully, is a charming, well-painted picture. The scene is laid on one of the romantic lakes in upper Bavaria. 'The Thames near Eton,' (298), by BIRKET FOSTER, again proves how a dexterous painter in water-colours may break down in oils. A. W. HUNT, another member of the Old Water-Colour Society, scarcely succeeds better within the Academy. The forms want definition: the picture is as a sketch magnified: but yet the harmony, the vision, the fire of colour are truly Turner-esque. Alfred Hunt is the most sensitive and rapturous of our colourists. JAMES DANBY also is once again fervid in harmony on 'The Day after the Gale' (317). 'Moonlight on the Mountains' (388), by A. GILBERT, is, as usual, spectral and large: yet the picture merits the place wherein it can be seen and appre-

ciated. W. H. PATON, R.S.A., has not been shown by the hangers equal favour. 'A Border Keep' (302), four ranks high, cannot make known its delicately modulated tones or its carefully-drawn details. W. H. HOPKINS deserves notice for a study—(401), without a title except a verse of poetry—of sea and golden sward, capital in colour; a scene, sunny and pleasant to look on. As next in the catalogue we cannot pass without commendation, careful horse portraiture (402), by J. DUVAL. Close by, E. HAYES'S 'Gale—Scarborough' (389) meets the eye. Similar gales by this artist we have, with encomium, encountered in divers exhibitions. The spectator knows precisely how far the gale will go, and all that will happen. G. F. TENISWOOD'S 'Stonehenge—Moonlight' (338) shows much poetic feeling for such night-scenes.

MARK ANTHONY has not for some years put forth his peculiar genius so vigorously as now. 'The Return after Labour' (264) is grand in intention: no artist has a finer conception of the nobility of an oak-tree: but the picture is ruined in the treatment; it falls into confusion. F. B. BARWELL has managed with skill a composition of no ordinary difficulty, 'The Hill at Norwich—Market-day' (293). 'Stonehenge' (410), by HARRY JOHNSON, has more effect than study or detail. L. SMYTHE must be commended for his dauntless labour in an almost unpaintable wood and river-scene (421). G. HALL adopts a somewhat foreign manner in the low tone and unobtrusive quietism thrown over an 'Evening near Criceirth' (345). To the above commendable works we must add 'In a Copse: November' (405), by A. PARSONS; a study equally delicate and true, of 'Winter Woods' (409), by G. SANT; 'The Shady Side' (396), by H. MACCALLUM; also 'A November Day in the Pass of Leny, Scotland' (420), by J. T. HAVERFIELD. Neither must we forget to mention two foreign landscape-painters of note. E. BERGH, the famous Scandinavian artist, whose works are seen in the Royal Picture Gallery of Stockholm, contributes a 'Birch Wood' (330). As we admire the feathery foliage, the silvery tree-stems, and the delicately-attempered green of the northern sward, it is easy to understand the high position held by this artist in the north of Europe. With regret we have to take leave of L. R. MIGNOT, a foreign artist with high gift of imagination, who died among us recently. The grand mountain range of 'Chimborazo' (368), which must be the painter's last contribution to the Academy, tells how much we have lost. For wide extent of space, for atmosphere, for tropical heat, and luxuriant vegetation, this landscape stands unequalled.

GALLERIES NO. VI. AND VII.

These two galleries, identical in size with Galleries IV. and V., contain a total of 171 pictures. The following is the analysis of their contents:—Nine Academicians contribute 12 pictures, five Associates 5, and one hundred and forty-three outsiders 154 pictures. Of these outsiders eleven are foreigners, who obtain admission for 12 works. Thus, once more it is seen how greatly the outsiders are in excess of the members. These figures, together with the fact, that works by strangers are often to be seen in the best places, rebut the charge that the Academy is blind to the interest of the profession at large. Gallery VI. does not call for any special remark. The room, however, next to it in succession, is the most provocative of criticism in the Academy. Certainly a large part of the pictures in

Gallery VII. would have been simply excluded from any exhibition in London ten or twenty years ago. And yet these eccentric works are not of a nature to pass under the term Pre-Raphaelite. In fact, since Pre-Raphaelitism has gone out of fashion a new, select, and also small school has been formed by a few choice spirits. This anomalous phase it is not very easy to define. Perhaps the school, if school it has a right to be called, can be best appreciated by examples which we owe to the talents of Mr. Moore, Mr. Maclaren, Mr. Armstrong, Mr. W. B. Morris, Mr. Barclay, and others.

W. B. RICHMOND, son of George Richmond, R.A., again obtains a central place on the line for a work of high purpose, but of infirm execution; 'Bowl-Players' (523). The style has close affinities to the classic, the figures are but partially draped, and in anatomy, severity of modelling, and *verve* in action, they might be mistaken for Roman athletes. The game is carried on pleasantly and deliberately in the confines of an Italian or Grecian villa, with delectable surroundings of columns, vines, laurels, and cyprus trees. These imaginings are unhappily embodied with considerable infirmity of hand and *technique*. Thus the work halts betwixt success and failure.

Mr. Richmond's pseudo-classic work may serve as a key-note to the new school. The brotherhood cherish in common, reverence for the antique, affection for modern Italy; they affect southern climes, costumes, sunshine, also a certain *dolce far niente* style, with a general Sybarite state of mind which rests in Art and aestheticism as the be-all and end-all of existence. W. MACLAREN, in Gallery X., gives expression to this mental condition in 'Alma Quies' (1,064), a picture which pleasantly recalls the memories of poetic lands, and, by dreamy placitude and hazy reverie, carries imagination far away from the stern realities of this work-a-day world. 'Capri Life: the Embroiderers' (547) is an adaptation of the same manner to what pretends to be a real scene: but still we are a great way off from reality. G. MASON'S 'Milkmaid' (553) is a picture lovely in unison of colour, tone, sentiment. Other artists of the clique follow in the same groove. E. BARCLAY'S 'By the River-side' (536) is tainted by mediævalism, and hardly in fact escapes the ridiculous; but in 598, 'On the Steps of Anacapri'—a kind of ascending Jacob's ladder—this artist, like his fellows, finds himself at home in Italy. The peasants, familiar to tourists, who bear burdens up this rock-cut path, are made to assume the statuesque attitudes of classic *caryatides*. The sunshine is Italian, light and colour illumine the shadow. T. ARMSTRONG, in 'Winter' (577), and 'A Music-piece' (544), adapts the principles of the school to northern climes and domestic themes. 'The Music-piece' is not without melody, the lines flow in rhythm. The picture combines that grace in awkwardness, that beauty in ugliness, which the school, ever and anon, affects. In the way of portraiture, 'Mrs. E. Langton' (515), by J. C. MOORE, kindly exemplifies the relation in which the new school stands, not to Greece only, but likewise to Japan. ALBERT MOORE, brother of the last artist, exhibits three products more directly classic, viz.: 'Sea Gulls' (520), 'Battledore' (597), and 'Shuttlecock' (601). Here the forms, especially the draperies, are classic, while the colours incline to tender and tertiary harmonies made known in this country by large importations of Japanese screens. The new and abnormal school we have attempted to describe has several phases:

indeed, each individual artist has his distinct phase. Taken as a whole, it may be accepted as a timely protest against the vulgar naturalism, the common realism, which is applauded by the uneducated multitudes who throng our London exhibitions.

J. PETTIE, A.R.A., gives, after his self-reliant manner, verisimilitude to a fictitious 'Scene in the Temple Gardens' (501). Shakspeare invented this rise of the quarrel of the Roses for the purpose of his drama, and Mr. Pettie sees in the imagined scene a subject for a striking picture. Plantagenet, Somerset, Suffolk, Warwick, and others, are grouped round the red and white rose-trees supposed to grow in the Temple Gardens. The composition is compact, the situation dramatic, the colour and the shade are of a sombre depth, which seems to forebode tragedy. JOHN GILBERT once more betakes himself to oils with doubtful advantage. 'Convocation of Clergy' (461) has the execution and quality of a design on wood or of a water-colour drawing. The forms and details want further definition and study. Yet the work is great by its power, character, and dramatic action. 'The Easter Vigil' (486), by E. LONG, affords capital specimens of Spanish ecclesiastics after the manner of John Phillip. This artist is becoming more careful and studious; but his style is still rather showy and conventional. 'Black Monday' (432) is at once identified with the clever pencil of G. E. HICKS. 'A Chapter from Pamela' (490), it is equally clear, must come from the easel of G. H. BOUGHTON. This last artist bids fair to win his way into the Academy. The picture before us is sunny and pleasant: the figures in the clover-field are well designed and painted: the style is rather French. 'Spring' (453), by F. HEILBUTH, is rude and rough in execution: the artist in Gallery X. has 'A Scene on the Banks of the Seine' (1,042) more worthy of his reputation. There is a sparkle in the sunshine, and a cool repose in the shadow, which are enticing to the eye and the fancy. G. F. FOLINSBY, an Englishman by birth, and a German by training, sends from Munich a studious and well-wrought work, 'Lady Jane's Victory over Bishop Gardiner' (445). The style is that of the Piloty school. The contrast between the towering rage of Gardiner and the imperturbable calm of Lady Jane is finely conceived. The treatment is broad and intelligent, the colour is pitched in a low key, the *impasto* is solid. C. LUCY exhibits a figure of considerable historic dignity, 'Charlotte Corday returning to Prison after her Condemnation' (532). S. SOLOMON, after his usual impressive, spiritual, and mystic manner, gives another version (485) of the Jewish Rabbi who appeared in the Dudley. A. B. DONALDSON, another frequenter of the Dudley Gallery, sends two pictures (541 and 575), poetic and well coloured, after the mediæval mannerism which he and others affect. R. BATEMAN'S 'Annunciation' (551) is an ultra-manifestation of this abnormal Art. 'A Reverie' (514), by S. BUTLER, is to be commended; the work is a happy medium between new and old schools. VAL PRINSEP may be congratulated on his powerful, original, and highly imaginative embodiment of 'Odin, the Northern God of War' (566). The execution is in keeping with the conception: the picture is animated by the weird spirit of the German and Scandinavian mythologies.

A few capital *genre*-pictures demand attention. F. HOLL, son of the late W. Holl, the engraver, produces two works which sustain the good name this clever young artist has already made. 'No Tid-

ings from the Sea' (595), the property of her Majesty, tells a pathetic story: the execution is as earnest as the thought. 'The Daily Governess' (472), plodding duty-bound through the snow, is much to the credit of T. GREEN. The picture awakens pity. A. STOCKS paints 'An Interior' (507) quietly and studiously; in tone he is most true, and detail and realism he brings into perfect pictorial keeping. A young artist does well to begin thus carefully. Also commendable is 'Uncared For' (455), painted with painstaking pencil by A. E. MULREADY. To the above may be added 'The Wayfarers' (467), by J. CLARK; 'The Old Apple Room' (466), by F. SMALLFIELD, an Associate of the Old Water-Colour Society; and 'The Draw-Well' (579), by W. SMALL, an Associate of the Institute. The last work is substantially a *replica* of a water-colour drawing mentioned in the *Art-Journal* with strong encomium on its appearance in Pall Mall. The drawing is the better work of the two. Mr. Small and Mr. Smallfield take good places in Burlington House; it is to be hoped, however, that they will not prove unfaithful to the Water-Colour galleries, which have a strong claim to be sustained against the formidable rivalry of the Academy.

The landscapes in these two galleries show almost every possible diversity of style. PETER GRAHAM'S 'Bridle-path' (442) is broad and powerful: the fir-trees are noble in form and masterly in painting. This is perhaps the best product of what may be termed the Scotch school of landscape. The opposite, and now all but extinct, style once known as pre-Raphaelite, obtains a good illustration in a carefully mapped-out scene, 'Etna from the Heights of Taormina' (545), by J. BRETT: the artist succeeds better with 'The British Channel seen from the Dorsetshire Cliffs' (522). The wide expanse of blue sea is skilfully managed; the eye is carried far away along a path of light made by the sun on the shining waters. The colour is deliciously tender; the horizon and sky are in fine aerial perspective. To bring the picture into unison was no slight difficulty. J. S. RAVEN, in accordance with his antecedents, throws a brilliant blaze of colour over 'Lago Maggiore' (538). G. F. TENISWOOD'S best effort is 'Twilight—in the Isle of Skye' (504). The scene is grand; the picture may remind the spectator of John Martin. A. BIERSTADT contributes two small landscapes (433 and 440); though diminutive, they are after the manner of the large panoramas which have acquired for the painter renown: the style is that of the Düsseldorf school. 'On the Leigh Downs—month of April' (524), by G. HASTINGS, calls for warm praise; the detail is careful and true, the style commends itself as a simple transcript of nature. 'The Haunt of the Fallow Deer' (457) is one of those sunny beech-wood scenes, with green sward, to which we have been long accustomed from the pleasant and conscientious pencil of W. LUKER. In like manner we recognise a familiar student of nature in B. W. LEADER'S 'Stream through the Birch-wood' (591): the penciling of the trees is lovely and delicate. C. N. HEMY and J. G. NAISS woo nature in sterner and more repellent aspects. Again the latter paints 'A North Devon Cove' (560) as if the rocks were of cast-iron: yet the picture is powerful and strictly conscientious. Also literal and earnest is Mr. Hemy's 'Shore at Limehouse' (435). The picturesque "stuff" on the river becomes absolutely grand by colour as well as by a downright decisiveness and unflinching

reality which remind us of the backgrounds to old German panel-pictures. The Misses MUTRIE each contribute flower-pieces brilliant as tasteful.

The portraits are not very remarkable. The best worth remembering is that of 'Le Père Hyacinthe' (477), by Madame HENRIETTE BROWNE, otherwise Madame DE SAUX. We have never seen by this lady, not even in Paris, a portrait more simple, broad, or truthfully outspoken: it wants colour and transparency—common faults with this painter. Also deficient in colour is a portrait—otherwise satisfactory, certainly massive in brain, and strong in reflective faculty—that of the 'Rev. Thomas Binney' (443), by L. DICKINSON. For general artistic management may be commended picture-portraits of 'Miss Maynard and Miss Blanche Maynard' (510), by A. CORBOULD. L. W. DESANGES has, after his usual method, animated by a flash of light the figure of 'Mrs. Prioleau' (463). Mr. HEALY, the American artist in Rome, exhibits a faithful but somewhat inartistic transcript of 'Pius IX.' (452). The portrait, by Mr. F. SANDYS, of 'W. H. Clabburn, Esq.' (468), 'cannot be commended for reading of character, for treatment of colour, or for rendering of flesh-tint. Mr. Sandys is usually more successful in studies in simple *chiar-oscuro*.

GALLERY X. AND LECTURE-ROOM.

Perhaps no better proof can be given of the all but exhaustless resources of the Academy than in the pleasing fact that the last Gallery is equally attractive with the first. The rooms, by well-considered hanging, maintain an even interest throughout, with two exceptions only: the 7th Gallery, we have seen, is held sacred to eccentricity: in like manner the Lecture-Room is dedicated to talents which affect singularity. A lecture, indeed, might be delivered in this Lecture-Room illustrative of what young students should avoid. Beginning at the commencement, the first seven pictures might with advantage have been excluded altogether. And as we proceed it is found that some of the obnoxious works are made worse by the unusual size they assume: as examples may be quoted 'A Vendre' (1,150), by J. L. GEROME, H.F.A.; 'At the Bar' (1,168), by F. WALKER, A.R.A.; 'The Guide' (1,172), by A. H. TOURRIER; 'The Betting-Ring, A.D. '68' (1,173), by H. C. SELOUS, &c. Fortunately the collection is saved from condemnation as a whole by a fair sprinkling of good pictures. The joint contents of Gallery X. and Lecture-Room are as follows: total number of works 157, which admit of analysis thus: thirteen Academicians contribute 16 works, three Associates 1 each, and one hundred and twenty-four outsiders 138; of these, eleven foreign artists send 14 pictures. As to subjects there is a preponderance of landscapes, *genre*, and miscellanies.

J. E. Millais, R.A., and F. Leighton, R.A., have already fallen under notice: we will, therefore, merely record the presence of 'Yes and No' (1,055) by the former, and 'Cleoboulos instructing his Daughter Cleobouline' (1,118) by the latter. The Lecture-Room, as we have said, is adorned—or shall we say disfigured?—by the chief works of W. Q. Orchardson, A.R.A., F. Walker, A.R.A., and J. L. Gerome, H.F.A. In 'St. Mark's, Venice' (1,117), Mr. ORCHARDSON has assailed a most difficult subject; he rounds the arches, turns the domes, covers the cavern-vaulted roof with mosaics: and having thus mastered the position, he hastily leaves his picture when about half-finished. The subject is, in fact, not much more than

rubbed in. As a pictorial feat, as a sleight-of-hand performance, the work is amazingly clever. As usual with this painter, the colour is good. 'At the Bar' (1,168), the first and only contribution of Mr. WALKER since his election as Associate, is universally pronounced a mistake. The artist's meaning, if not unintelligible, has been open to controversy. The principal figure proves to be a woman on her trial; the expression of the face and hands, it must be admitted, is fine. The intention of the work, in fact, is good, but the result decidedly disagreeable, because instead of beauty we are given ugliness, instead of brilliance blackness. The execution is muddled: the artist found his picture going wrong; indeed, it had gone so very far wrong that it could not be set right. The case admitted of but one remedy, that of taking a fresh and unspoiled canvas, in order to begin again at the first beginning. M. Gerome's 'A Vendre' (1,150) is another picture which it were better should not have been painted. This exposure for sale of a female slave is degrading, not to say disgusting. Neither is the scene redeemed by excellence of Art. The composition is one-sided, the drawing negligent, the colour dirty. The hangers seem to have desired to place the picture out of sight in a corner. Another celebrated French painter, M. HEBERT, long known in the Gallery of the Luxembourg by 'Malaria,' and for some years Director of the French Academy in Rome, favours our exhibition with a well-considered and soundly-painted composition, 'The Morning and the Evening of Life' (1,157). A noble figure in the full strength of womanhood stands at a well: this ideal of an Italian peasant is raised above the level of common life: the work is something more than a costume-picture: the style may be designated as the romantic naturalistic. Of still nobler purpose is a well-conceived composition, 'The Summit of Calvary' (1,177), by P. R. MORRIS. A shepherd with his flock, walking on the hill of the Crucifixion, comes to the Cross: he pauses in dismay. The scene is novel and striking: the picture as a sacred drama is most impressive.

J. ISRAELS, the Dutchman who dedicates his Art to the annals of the poor, again comes before us with a tale of woe. 'How Bereft' (1,038) is a cottage household shadowed by death: a coffin is borne to the door. We incline to think the scene over-enacted, and yet commonplace. To bring together a cradle, coffin, and clock-case is no great stroke of genius. We have in general much respect for M. Israels: in the present instance, however, too much reliance is placed on the story, and too little on the Art: the picture is roughly painted, the shadows are black, the colours muddled. J. TOURRIER, whom we have often commended, is going back: 'The Guide' (1,172) is slurred and scamped. 'The Betting-Ring, A.D. '68' (1,173), by H. C. SELOUS, is in a common, ranting manner. 'Running a Rapid on the Mattawa River, Canada' (1,063), by Mrs. E. HOPKINS, has spirit, action, motion. The colour is rather crude, and the general style seems to be derived from the Art of the American aborigines. The picture would make a capital illustration to a book of travels. J. E. HODGSON also contributes gleanings from his journeyings: his studies on the northern shores of Africa have an ethnographic interest. Yet 'An Arab Patriarch' (1,160) is more true than pleasing: the artist's colouring is apt to be cold; his mode of painting is dry, matter-of-fact, and unemotional. The figures consort but ill with the landscape, and yet the painter has

evidently been at much pains to keep his composition together. Mr. Hodgson is never careless; though apparently slow, he is sure.

Refinement, poetry of sentiment, and delicious quality of colour, we are almost sure to find in ARTHUR HUGHES, 'Evening' (1,025) is responsive to the Shakespearean lines,—

"So service shall with steeled sinews toil,
And labour shall refresh itself with hope."

An old man bears firewood on his back: it is evening, and he has reached the evening of life when toil is well-nigh ended. Children seated in the gloaming are in keeping with the spring-time in the budding, blossoming woods. The picture is pleasantly suggestive to fancy. Were it stronger it were better; and yet we could not afford to lose any of the tenderness or quietude. Also Miss M. EDWARDS we may thank for a refined poetic work, 'The Knight's Guerdon' (1,105). B. RIVIERE is by turns refined and coarse: 'Circe' (1,156) and the swine is so unflinchingly true to swinish character as to be unutterably repulsive: 'Come back' (1,049), on the other hand, is intended to move the mind to love and sympathy. A poor girl who has wandered an outcast from home returns to the cottage-door with shamefacedness. The dog, which does not forget her, springs forward with warm caress. We are sorry to object that the picture is better in sentiment than in Art. The handling is smooth and without texture, the colour is something between the showy and the sickly: the style courts popularity, but success cannot be assured without more earnest study and less affectation. No such reservation is needed when we praise Mr. PEELE'S 'Prayer for Health' (1,044). A sick girl lies on a cottage-bed, her hands clasped, her eyes upraised. The expression is earnest, the whole scene most impressive: the execution is careful, unostentatious, and yet somewhat short of realistic. It hits a happy mean.

Naturalism and individualism remain strong within the Academy. 'The Children's Fairing' (1,162), by E. NICOL, A.R.A.; and 'Black to Move' (1,074), by J. D. WATSON, are leading works in this popular but plebeian manner. Also for faithful portraiture of individual, not to say national, character; another noteworthy work is the 'Westphalian Card-Players' (1,136), by H. CARTER. This artist has studied in Germany, as his picture indicates: his style belongs to that branch of the Düsseldorf school which is identified with the national life of Scandinavia. H. H. EMERSON'S 'Foreign Invasion' (1,087) comes in the not very formidable form of Italians with bagpipes: the picture wins a good place by fairly well-painted character and costume. 'Tired Out' (1,104), by A. STOCKS, has capital realism after the manner of the Dutch. Powerful, naturalistic, but overdone, is 'Woman interceding for the Vanquished' (1,026), by T. J. BARKER. G. G. KILBURNE, of the Institute of Water-Colour Painters, takes to oils successfully: 'Among our Ancestors' (1,036) is refined, detailed, and well executed. Also A. M. ROSSI deserves to be remembered for 'A Family Group' (1,093), remarkable for finish, colour, incident: the carpet, wall-paper, book-case, and engravings are rendered with illusive reality. F. W. W. TOPHAM would do better could he bring himself to the realism and naturalism of the works we have enumerated. 'Home and Victory' (1,069) is sadly wanting in solidity; the figures are so unsubstantial and vaporous as to be almost translucent; we

shall next expect to see the background through the painter's foreground. Mr. Topham should content himself to be less brilliant; a little more sobriety would gain for his conspicuous abilities greater respect. D. T. WHITE deserves notice for 'Dr Johnson at Rehearsal' (1,079): the manner is French and Frith-like; the characters are pointed, the costumes well painted. We hope to see better work from C. CALTHROP than the 'Scene from *The School for Scandal*' (1,113). This painter also affects a French manner: he makes a great effort, and ends in extravagance and grimace. Another scene of revelry scarcely redeemed by the Art brought into play is R. CARRICK'S drinking-party, which passes under the title 'When the Drum beat at Dead of Night' (1,121).

A few portraits deserve to be pointed to as failures—as examples of what to avoid. Foremost may be distinguished, 'Captain Shaw, Metropolitan Fire Brigade' (1,138), and 'Fitzroy (page of honour to her Majesty) and Grenville Somerset, sons of Lord Raglan' (1,139), both by H. WEIGALL. As a companion, is gibbeted high on the walls a brazen figure, by T. GRIFFITHS, of an Eastern celebrity in costume (1,147). We will not attempt to print the name; no one can read it.

Sea-pieces are this year unusually poor. Some of the best may be met with in these last rooms. Foremost comes 'A Gale in the Downs—Steam-tug rescuing a disabled Brigantine' (1,144), by HENRY MOORE. The picture, which has been shamefully hung, is admirable for dash, spirit, motion, toss and roll of wave. 'Toilers of the Sea' (1,080), by G. S. WATERS, is a commendable study of grey sky and angry waves. In previous galleries we might have mentioned with approbation pictures by E. Duncan and W. L. Wyllie, artists well known in other exhibitions: we may also here take occasion to notice the presence of Baron Gudin, one of the most renowned painters of sea-pieces and naval battles in France. In the Paris Exhibition of 1855 this prolific painter was represented by twenty-five works, and to the last great Paris Exhibition Napoleon III. lent a picture painted to order, 'The Arrival of the Queen of England at Cherbourg.' Baron Gudin, "Commander of the Legion of Honour," has latterly been in England: his former residence in Paris, the Château Beaujon, Champs Elysées, must have been anything but a tranquil retreat for a lover of nature. It is interesting to note the style of marine-painting which obtained favour under the late empire. The French preferred Baron Gudin; the English naturally showed partiality for Clarkson Stanfield, R.A., and E. W. Cooke, R.A. 'Dutch Boats in a Calm off the Helder' (1,078) is a fair example of a faithful study which has won for Mr. COOKE his high position. Also, if we mistake not, distinction awaits W. J. CALLCOTT. 'The Breakwater at Gorleston, Great Yarmouth' (1,039) is a great and not unsuccessful effort. The difficulties encountered are immense; the picture, indeed, ends by being scattered. But the artist, if he continue thus resolutely to work, must conquer at last.

The landscapes in these rooms are, in merit and number, above the average in the other galleries. Three Linnells, the father and two of his sons, are here present. JOHN LINNELL, Sen., at the venerable age of eighty, in a grandly-coloured landscape, 'Shelter' (1,119), is as true as ever to the noble style which, over a period of a quarter of a century, he has adopted and matured. The hand is firm, the colour deeply lustrous, the general manner worthy of comparison

with the old masters. F. W. HULME, following somewhat in the footsteps of Creswick, has made a modest and truthful study, 'On a Welsh River' (1,114). The rocks in the river-bed are thoroughly well painted. B. W. LEADER is severely dealt with by the hangers: 'An Autumn Evening' (1,122) ought to have been on the line. For detail, careful study, and downright solid painting, there is not a better picture in the Academy. Also to be commended are 'Moel Siabod' (1,169), by J. PEEL; 'The Hooper's Hovel' (1,048), by F. WALTON; and especially 'The Hay-field' (1,037), by J. C. ADAMS. 'A Border Foray' (1,155), by H. GARLAND, may be named as a spirited picture of wild cattle, suggested apparently by Rosa Bonheur.

Lastly may obtain sympathy and a word of thanks some few landscapes of sentiment. H. W. B. DAVIS, who has often obtained appreciative notice in our columns, makes himself unusually impressive in 'Moonrise' (1,052). The scene is subdued into silence; the tone reaches stillness and solitude. A. HAYWARD, in 'Autumn Eve' (1,065), strikes deep and sympathetic chords by the reiteration of a warm monotone. 'Autumn, Moonrise in the Highlands' (1,073), by T. O. HUME, has a poetry which, unlike much pictorial and academic poetry, is relieved from commonplace. Also poetic in effect is 'Arran, from the Cumbraes' (1,075), by J. CASSIE, A.R.S.A. The jagged outline of the distant mountains against the warm sky has been made the most of. The placid sea and the grey mists clothe the scene in quiet reverie. Finally may be named J. W. INCHBOLD as the last of pre-Raphaelites. 'The Upper Cliff, Isle of Wight' (1,067), has the merits, not to say the defects also, even the details specially commended by Mr. Ruskin fifteen years ago in his "Notes on the Academy." Yet it is not given to genius to paint blackbirds in trees, and other like small "game," over a period of fifteen years without decadence. The landscape before us has talent, certainly originality and independence, yet is it a mistake. The picture, though clever, has the disadvantage of being in many lights invisible, and the details can be appreciated only by the aid of a microscope.

GALLERIES VIII. AND IX.

WATER-COLOUR DRAWINGS.

The collection of Drawings is by no means remarkable. It is now evident that the Academy will not materially prejudice, as at first was feared, the long-established Water-Colour Societies. Any injury that may in the long-run be inflicted seems likely to result from the fact that many water-colour painters are now giving much of their time and strength to oils. In the sphere of water-colour Art the Academy must be content to take a subordinate position.

R. Redgrave, R.A., T. S. Cooper, R.A., W. E. Frost, R.A., and W. C. T. Dobson, A.R.A., severally contribute drawings; the rest of the Gallery is placed at the service of outsiders. One or two frequenters of the Old and the New Water-Colour Societies, and of the Gallery of Female Artists, are also present. For the most part it may be observed that artists come here when dissatisfied elsewhere. We have not space for the superfluous or superabundant products of painters who have already in the Water-Colour Galleries of the season obtained due notice. We would call attention, however, to 'The Young Merchant' (730), by E. BALE, a study from nature, capital in design, colour, and handling. Also worthy of note is a

careful and refined drawing, 'Lazy' (719), by the Master of the Manchester School of Art. Mr. MUCKLEY takes a very good position in London exhibitions. Also of unusual cleverness is the battle of the bonnets, or 'Tastes Differ' (668), by R. ROSS, Junr. Genius, too, seems to assert itself in 'The Grave of Taliesan, the Welsh Bard' (641), by C. POTTER. Also may be mentioned as a striking example of the new school of mediæval naturalism, 'Peasantry nearing Paris, Sept. 1870' (731), by W. B. MURRAY. Likewise as above average merit, and as displaying talent and true study, are worthy of honourable mention an interior (767), by H. KING; 'Satisfied' (787), by W. HUGGINS; 'A Study' (760), by Miss C. PHILLOTT; and 'A Head from Life' (639), by Miss E. MARTINEAU. Interest naturally attaches to 'The Haunted Park' (629), by RICHARD DOYLE, formerly of *Punch*; likewise to an imaginative and terror-moving design, 'Death's Banquet' (814), by H. K. BROWNE, also well known in illustrated pages of our period. HARRISON WEIR, a familiar name too, but not so often seen as formerly, proves accurate study in a drawing of ducks and ducklings (762). Several minutely-finished landscapes by E. LEAR may be viewed with curiosity, as coming from the author of "The Book of Nonsense."

Flower and fruit pieces of more or less merit are contributed by J. Sherrin, J. Bligh, J. J. Hardwick, W. Hough, and T. Waite. The best crayons are by the late T. Goodall, to whose memory we have already paid tribute. Excellent etchings are produced by F. Seymour Haden, E. Edwards, and J. P. Heseltine. The most successful miniatures come from E. Moira, W. P. Rhodes, and M. C. Lepec.

The Architectural Room contains two powerful designs, which conform remarkably well to decorative conditions of colour and composition—'St. Clotilde distributing Alms' (899), and 'The Baptism of Clovis' (911), by D. LAUGÉE, a name of high repute in France. Also as artistic, and sketched withal, is 'The Original Study for the new Ceiling of the Hall at Clare College, Cambridge' (938), by Sir M. D. WYATT. 'The Ducal Palace, Venice' (890), by A. W. HANDS, is an elaborated sketch, of which Ruskin might be proud. A noteworthy treatment of domestic Gothic is 'Victoria Terrace, Aberystwith' (880), by J. P. SEDDON. 'Christ Church Cathedral, Dublin' (944), affords a good example of Mr. STREET's broad, vigorous treatment. 'The Clock-Tower of the Manchester New Town Hall' (948) is one more added to the several Gothic designs with which Mr. WATERHOUSE has adorned the manufacturing capital of Lancashire. Lastly may be mentioned, as a truly tasteful application of bricks and *terra-cottas*, 'The Interior of a Church, Bristol' (962), by PONTON and GOUGH. The collection of architectural drawings, though not much out of the common, is interesting as an index to the styles, constructions, and materials which now obtain favour.

SCULPTURE.

We have seldom seen so poor a collection of sculpture. The expectations which were naturally raised on the opening of the new rooms have not been realised. It was believed that Academicians and other leading sculptors had held back from the sepulchral cellars of Trafalgar Square. But still first-rate creations are, with few exceptions, not forthcoming. That there are large national undertakings which might bring to the Academy figures and groups of

size and significance, the Albert Memorial proves full well. Yet it has long been a complaint that there is in this country little encouragement for sculpture of a high and imaginative order. Accordingly, this year as usual, busts preponderate; portrait-sculpture, as portrait-painting, is the best sustained Art-product. Still we shall have the pleasure to point to some few works of ideal aim. The contents of the "Sculpture Gallery," the "Central Hall," and the "Vestibule," severally and collectively set apart to English and foreign sculptors, are as follows:—Total number of works 160. Of this total 4 are contributed by two Academicians, 11 by three Associates, and 145 by eighty-two outsiders. The foreign sculptors, who may be set down as twelve in number, furnish 26 works. Among honorary foreign Academicians, M. Guillaume, the only sculptor, is again absent.

W. C. MARSHALL, R.A., exhibits 'A Girl Fishing' (1,278); a figure well balanced, poetic, and refined. E. B. STEPHENS, A.R.A., has executed a commission more than commonly arduous, something sepulchral, and 'In Memoriam' (1,294), the intent whereof is supposed to receive elucidation by the text, "He was the only son of his mother, and she was a widow." A more recently-elected Associate, T. WOOLNER, departs more widely, and not unwisely, from ordinary routine in a large relief in marble, 'Virgilia bewailing the Banishment of Coriolanus' (1,277). In the background is "a bas-relief representing her husband's great achievements in Corioli, where, single-handed, Coriolanus drove the Volscians before him." The composition is concentrated, the action decisive, the execution sharp. The artist supposes that upon this bas-relief Virgilia "has been gazing, and in an agony of despair throws herself against the wall." The sculptor has given passionate expression to anguish, and yet does not exceed the moderation prescribed by the Greeks. The successive levels and the delicate transitions between *alto-relievo* and *basso-relievo* are managed with skill. Altogether Mr. Woolner is to be congratulated on his *début* as a newly-elected Associate. Mr. DURHAM, A.R.A., exhibits six works; the largest is 'A Dip in the Sea—model for a marble group' (1,224). The action is novel and difficult; the group has evidently been closely studied from nature.

J. B. CARPEAUX is one of the few foreign sculptors who call for special notice. 'La Jeune Fille à la Coquille' (1,262), and 'Le Pêcheur Napolitain' (1,264), severally in marble; and 'Ugolino and Family in Prison,' a small bronze (1,232), are works which already have obtained distinction in the current Art-literature of Europe. For modelling, action, character, in short, for Art-treatment, works of equal merit have seldom been seen within our Academy. Carpeaux has been a favourite of fortune under the late empire. He was recipient of the grand prize of Rome, of medals of the second and first class, and of a cross of the Legion of Honour. In the Great Exhibition of 1867 we commended a charming statue of 'The Prince Imperial with a Hound.' M. Carpeaux has also assisted in the decoration, after the manner of Bernini, of the Pavillon de Flore, which happily escaped total destruction in the burning of the Tuileries. He shares a common fate; we honour a great artist in works which we gladly welcome to our English Academy. M. D'ÉPINAY reminds us of Donatello in 'David' (1,267). This figure is almost the only example of waxing or tinting within the Academy. C. F. FULLER, who seems to have exchanged

Florence for Rome, sends us yet another romantic group, 'The Peri and her Child' (1,253). The composition displays the grace of line habitual to the artist, while the execution has apparently been delegated to one of the many skilled but conventional Italian carvers. A. B. JOY deserves encouragement for 'The Young Apollo' (1,281). The style is obedient to the antique, yet not without originality; the modelling has considerable decision. F. M. MILLER gives pleasing sculptural form to the lines—

"Zephyr with Aurora playing,
As he met her once a-maying."

Busts are numerous, various in treatment, and of divers merit. But precedence is due in the way of portraiture to a full-length figure by G. G. ADAMS, 'The Statue of Dr. Hugh McNeile, executed in marble in St. George's Hall, Liverpool,' which has quiet bearing, yet seems to speak; the details are well considered. H. WEEKES, R.A., throws accustomed detail and character into the marble bust of 'John Fleming, Esq.' (1,286). Heads highly wrought in expression are produced by T. WOOLNER, A.R.A., and T. BUTLER. A pleasing little head is given of 'Miss A. Beaumont' (1,243), by M. NOBLE. The *terra-cottas* of J. E. BOEHM continue unrivalled for character, animation, and piquant sharpness in touch. His statuette of 'Thomas Hughes, M.P.' (1,315), is picturesque, quiet, and manly. In a couple of child's busts in *terra-cotta* (1,230 and 1,234) this artist has happily fallen under the influence of Florentine sculptors of the fifteenth and sixteenth centuries. C. SUMMERS exhibits eight works which mostly are unfortunate by reason of vague generalisations. The bust of 'Professor Owen' (1,186) had been better for more definition and detail. Altogether unfortunate, too, is the bust of 'Daniel Maclise, R.A.' (1,304), by E. DAVIS. This is in the style of the barber's block; the bust is a painful parody on the strong manly head of Maclise. Such a work, expressly executed "by order of the President and Council, to be placed in the council-room of the Royal Academy," is likely in future ages to be a stigma on the Art of our times. Intellectual celebrities, however, with few exceptions, make very creditable appearance within the Academy. Thus as accurate likenesses and fairly good Art may be commended busts of 'Charles Dickens' (1,261) and 'George Cruikshank' (1,264), severally by J. ADAMS-ACTON; 'Mark Lemon' (1,205), by G. E. EWING; 'George MacDonald' (1,229), by G. A. LAWSON; and 'Dr. Temple' (1,282), by T. WOOLNER.

CONCLUSION.

The Exhibition of 1871 barely rises to average merit, and yet, as we have seen, it represents tolerably well the collective talent of the country. Each year the diversity of existing styles becomes more apparent; the exhibition, for instance, contains fair examples of the several cliques or parties which pass under the designation of "the St. John's Wood School," "the Little Holland House," or "the Kensington School;" "the Scotch School;" likewise of that new school which coquettes with turns with Italian Pre-Raphaelitism and German Gothicism. The friendly relations that exist between these coteries say much for the good feeling which usually prevails in London Art-circles: the independence enjoyed by individual talent is likewise a good sign of our times. Yet this individual freedom seems fatal to oneness of action; and thus the existence of a united English school has been actually called in question, and the corporate power and control of the Academy

as a governing body are occasionally ignored and set at naught. There are signs, however, that order will come out of chaos, strong government out of anarchy. All exhibitions prove how greatly our English artists have suffered from want of Academic training; the schools of the Academy have long needed reformation. Therefore the announcement recently made by the President, that divers professorships will be established, and other measures taken in the interest of Art-education, is altogether fitting and timely. The Academy will thus acquire the dignity, and exercise the high functions, which befit a noble and a national institution; and sooner or later the salutary effects cannot fail to be felt within the annual exhibition. We may rest assured that Burlington House will gather together the best Art of the period as long as the Academy shall use its governing power with discretion, and its accumulating wealth with liberality.

SELECTED PICTURES.

KEPT IN.

E. Nicol, A.R.A., Painter. J. Stephenson, Engraver.

THERE is no chance of mistaking a picture by Mr. Nicol for a work by any other artist. He is the representative painter of the more humble classes of Irish, be they dwellers in town or country, whom, under certain humorous conditions almost inseparable from their nationality, he seems entirely to monopolise: no other artist must attempt to rival him on his own ground with any probability of success.

A village school in Ireland, under the management of such a pedagogue as that represented here, promises but little in the way of education for the rising generation. Without any desire to libel the preceptor, who may pass his days quite honestly in the pursuit of his scholastic vocation, he looks very much as if he could spend some portion of the night, without doing much violence to his conscience, in snaring a hare or spearing a salmon. In fact, we are not without some recollection of seeing him—or if not him, it must have been his twin-brother—occupied in work very different from that of his present position.

The school has broken up for the day; the boys have all left, or are preparing to leave; this unhappy wight among the number, for he has packed up his satchel, taken his cap from the floor, or wherever it may have been during school-hours, and is about to make his *exit* with the rest, when he is called back by the authoritative voice of the master, who raises his eyes from the newspaper, and looks at him from over his spectacles, as if he would make a "full end" of him at once. Still there is something about the corners of that "pursed-up" mouth, and in the general expression of the face, that shows more of the assumption of power than of the intention of using it; and one feels assured the culprit will in a few minutes be playing at marbles with his companions outside, after being suitably admonished as to future conduct.

It is a capital picture of its kind: the two leading figures in it are admirable for expression in their relative character; while the youngster in the foreground, who has stopped while collecting together his well-thumbed books, which appear as if they had passed from father to son through several generations, regards his erring schoolfellow with a kind of curious look, intimating that he is only waiting to hear the verdict, indifferent whether it results in liberty or imprisonment.

THE HISTORY OF WATER-COLOUR PAINTING.

WE adopt the current term as descriptive of a branch of Art to which we owe a succession of the loveliest results that have ever been effected by human genius. The subject is suggested by a very valuable, and even more instructive than valuable, assemblage of water-colour drawings, which have been collected, and are exhibited, in illustration of the history of water-colour painting, by the Burlington Fine Arts Club, at their rooms in Saville Row. The works are limited to those of artists who were born before 1800, and who have died since that time. The earliest artists exemplified in this gathering are William Taverner (1703), Thomas Sandby (1721), Paul Sandby (1725), Thomas Malton (1726), &c. The date affixed to the name signifies the year of the artist's birth, but where that cannot be certified the earliest year of exhibition is noted.

The productions of the men above named, and of many long after them, were worked with very few colours; indeed, they show only three or four—it may be yellow ochre, a common blue, and any ordinary brown. The sketch was made out frequently by a light outline worked over with a brush charged with Indian ink, occasionally warmed with red or brown; and (we speak here particularly of foliage) the light masses being left, were subsequently washed over with yellow ochre, either pure or slightly qualified with blue, as alluding to, rather than representing, green. There are generally only two gradations, both extremes of light and dark, and frequently the latter are finished with oblique hatchings. It never occurred to the earliest water-colour essayists to give their skies a voice in the sentiment of their works. They may not have enjoyed opportunities of listening to the discourses of Van de Velde or Van der Neer, nor any others of those sagacious Low Country painters who frequently had little else than a sky for a subject. If they have, they neglected their chances; indeed, for the best part of a century there was no settled improvement in landscape, although the works of Malton, Hieronymus Grimm, and William Marlow (1742), show a superior intelligence in architectural drawing. In the direct line of landscape the Sandbys were succeeded by Barrett, William Pars (1742), G. Robertson (1742), Thomas Hearne (1744), M. A. Rooker (1746), F. Wheatley, John Smith (1749), and John Cozens (1752). In the works of some of these, attempts are made to bring the sky into the composition, but still under the prevalence of that unintelligible principle which ruled that the subject should be presented in two masses: one, the foreground, dark sometimes almost to blackness; the other, the distances, a thin and broad wash of a cold tint. In 1755 we come to Stothard, whose amiable infirmities are never thought of in the wonder he occasions as to where he gathered the stores of sweetness with which he qualified his works, whereof there are twelve here. Rowlandson also dates 1755; of him are two admirable examples—one, Covent Garden—before he sank into the slough of the most vicious caricature. Here we are no longer in the dark or the grey dawn of the story of water-colour; the path of the historian is lighted up by Blake (1757), Ibbetson (1759), Pugin (1762), Dayes (1763), Westall (1769), Edridge, Cristall, Glover, Owen, &c., until we come to Girtin (1773), and Turner (1775), who in his early time could not help falling into some of the weaknesses of his contemporaries, but lived long enough to emancipate himself from them. Although the collection contains drawings by De Wint, Prout, John Varley, Robson, Stanfield, Hunt, and many others, enough has been noted to enable us to say that the exhibition is extremely interesting; but as the works have been collected in illustration of Art-history, it would have been preferable that some of the earlier productions which mark certain states of progress had, instead of being placed high, been hung nearer the eye; an arrangement whereby the "line" might still have been secured for the brilliant examples by which it is enriched.

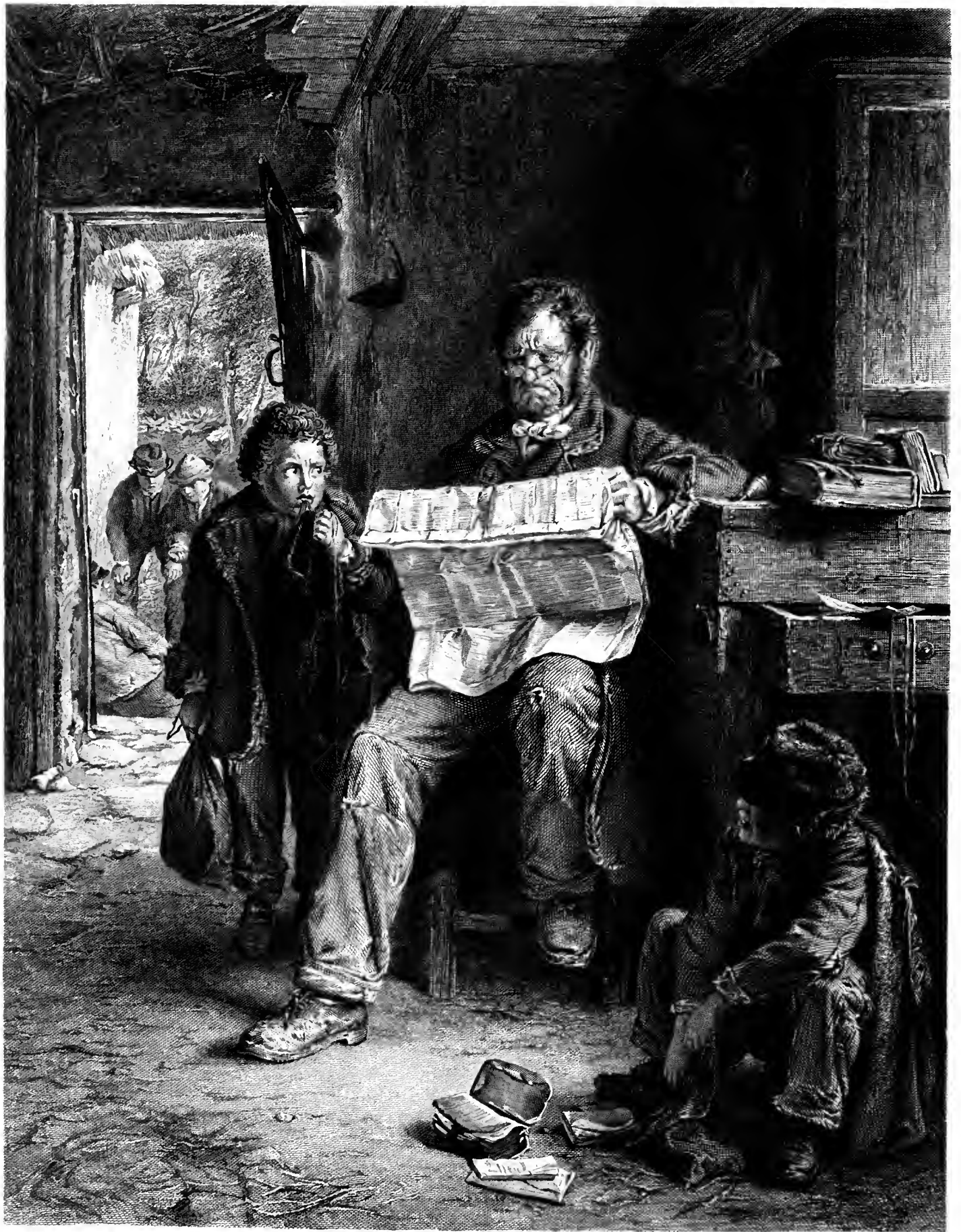

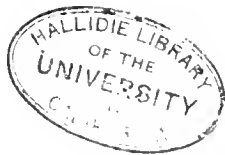

THE MUSEUMS OF ENGLAND,
WITH
SPECIAL REFERENCE TO OBJECTS
OF ART AND ANTIQUITY.

BY LLEWELLYNN JEWITT, F.S.A., &c., &c.

THE BATH MUSEUM.

AMONG the towns in this country pre-eminently rich in remains of Roman Art, the city of Bath—*Aquæ Solis* of the Romans—may claim a prominent place. There are but few places where a larger number of inscribed stones have been found; and but fewer still, it is to be regretted, where in times past they were so little cared for in the locality itself. Perhaps it was hardly to be expected that in such a place as Bath, the very centre of frivolity and fashion during the last century, anything approaching to a serious consideration of musty antiquities could show itself; while those who did pay a passing attention to them were sure to be rewarded by laughter and sarcasm from the leaders of *haut-ton* who swarmed about the place. Thus, although grand old remains were constantly being unearthed, they found no abiding place in the city, but were either cast away unheeded, or, if heeded at all, were taken away from Bath to enrich some other more sober place. It is probably not too much to say, that not a tithé of the Roman antiquities found at Bath have been preserved for that city. Still, it is a matter for sincere congratulation that so many, and such important, remains have been preserved as may be seen in the Museum, to which I am about to direct brief attention; and, in doing so, it is especially gratifying to allude to the labours of three worthy antiquaries, who have, one after another, devoted themselves to the recording and illustration of these antiquities. These are the Rev. Richard Warner, who, in 1797, published his "Illustrations of Roman Antiquities discovered in Bath;" the Rev. Samuel Lysons, who, in 1802, published his "Remains of two Temples and other Roman Antiquities discovered at Bath;" and the Rev. Prebendary Scarth, who, in 1864, issued his admirable work "*Aquæ Solis*, or Notices of Roman Bath;" a work of great erudition and research, and one which gives a better idea of the importance of the Roman city than any other has done.

The first formation of a museum in Bath took place in 1824, when, a building having been erected by Earl Manvers upon the site of the Lower Assembly Rooms—the scene of Beau Nash's reign as "Master of the Ceremonies" and "King of Bath"—which had been destroyed by fire, the "Bath Royal Literary and Scientific Institution" was formed; its object being the formation of a library of reference; the establishment of scientific lectures; and the foundation of a Museum of Local Antiquities and Objects of Natural History. The Library seems, however, to have been the main object, and it now numbers about 7,000 volumes of valuable works.

The Museum contains, besides its antiquarian and general features, a good mineralogical collection, the nucleus of which originally belonged to the Bath and West of England Agricultural Society; a cabinet of British shells; a fine geological collection numbering about 2,000 specimens, including the splendid collection of birds formed by the late Lieut.-Colonel Godfrey, a native of Bristol, and presented to the Corporation of Bath by his widow; the magnificent collection formed by Charles Moorc, Esq., F.R.G.S., and here deposited for the public benefit by him, which includes the finest series of Ichthyosauri and Plesiosauri preserved in any provincial museum; and a natural history collection illustrating the Fauna and Flora of Bath, made by the Rev. L. Jenyns, who has also presented his own library of works on natural history—the collection of a long life—to the Literary and Scientific Institution, which has lately been enlarged for the purpose of receiving it.

Most of the local antiquities are the property of the Corporation of Bath, by whom they are here deposited. Among the more prominent objects of Art and antiquity, the following will

be especially noticed by the visitor. In the Roman sculptured stones, the principal are an un-inscribed altar, two sides of which are plain, and the other two bearing respectively a figure of Jupiter, and one of Hercules Bibax, or "Convivial Hercules," bearing a club in his left, and a *cyphus*, or drinking-cup, in his right hand. An altar dedicated to the Leucetian Mars, and Nemetona, bearing the inscription:—

PEREGRINVS
SECVNDI FIL
CIVIS TREVER
LOVCETIO
MARTI ET
NEMETONA
V. S. L. M.

which reads, "Peregrinus, the son of Secundus, a Trever citizen, to the Leucetian Mars and Nemetona, pays his vows willingly and deservedly." Two altars, dedicated to the Goddess of Health, Sul-Minerva, one by Sulinus, the son of Maturus, the other by Curiatius Saturninus, are thus inscribed:—

DEAE
SVLIMI
NERVAE
SVLINVVS
MATV
RI FIL
V. S. L. M.

DEAE SV
LIMIN. ET NV
MIN. AVGG C
CVRIATIVS
SATVRNINVS
LEG II AVG
PRO SE SV
IS QVE
V. S. L. M.

Two other altars dedicated to Sul, without the addition of Minerva, record that they were erected, the one for the health of Aufidius Maximus, centurion, by his freedman, Marcus Aufidius Lemnus; the other for the health and safety of the same centurion (Aufidius Maximus), by his freedman Eutuches—twin offerings, probably, of gratitude for manumission.

An altar dedicated to the *Suleva*, or Sylphs, who were the tutelary divinities of rivers, fountains, hills, roads, villages, and other localities, by Sulinus the sculptor or stone-cutter, the son of Brucetus; and another inscribed altar, without a *foculus*, erected by Vettius Benignus, but without any deity being named.

The principal inscribed sepulchral stones are the following, which are of particular interest. A slab with a coped top, ornamented with a group of fruit and flowers, beneath which is the inscription:—

IVLIVS · VITA
LIS · FABRICIUS
IS · LEG · XX · V · V ·
STIPENDIOR
VM IX · ANNOR · XX
IX NATIONE BE
LGA EX · COLEGIO
FABRICE ELATV
S · II · S · E

This was erected (probably by, and at the cost of, his brethren the company of smiths or armourers) to Julius Vitalis, a native of Belgic Britain, and a smith or armourer in the twentieth legion; and who died in the 29th year of his age, and 9th of his service.

A sepulchral stone, on the upper half of which is carved a mounted soldier, riding over his fallen enemy, and on the lower half the inscription showing that it was erected to Lucius Vitellius Tancinus, the son of Mantaus, a citizen of Caurium, in Spain, a soldier of the Vettesan Auxiliary Cavalry, who died at the age of 46, having served 26 years. The top of this slab has been broken off and lost, but the top of another very similar stone is preserved, while the inscription is lost. Another sepulchral stone, with a coped top, has the inscription:—

D M
MERC MAGNII
ALUMNA VIXIT AN I
M · IV · D · XII.

showing that it was erected to an Alumna of Mercurialis, or Mercurius Magnus, who died aged one year four months and twelve days.

Another of the sepulchral slabs which will be noticed is one erected by his heir, Gaius Tiberinus, to a discharged soldier of the 20th

legion, who died at the age of 45. Another bears the inscription,

RVSONIAE · AVEN
N · AE · C · MEDIOMATR
ANNOR · LVII · H · S · E
L · VLPIVS · SESTIVS
H · F · C ·

showing, as it is conjectured, that it was erected to Rusonia Avenna, of the nation of the Mediomatrici, who died at the age of 58, by his heir, Lucius Ulpius Sestius.

Another very interesting sepulchral stone, erected to Calpurnius Receptus, priest of the Goddess Sul, aged 75, by his wife, Calpurnia Trifosa Threpte. The inscription is as follows:—

D. M.
C · CALPVRNIVS
RECEPTVS SACER
DOS DEAE SV
LIS VIX · AN · LXXV
CALPVRNIA TRIFO
SA [THR]EPTI CONIYX
F · C

which would read, "Diis Manibus Caius Calpurnius receptus sacerdos Deæ Sulis, vixit annos Septuaginta quinque Calpurnia Trifosa Threpte conjunx faciendum curavit." This interesting example we engrave.

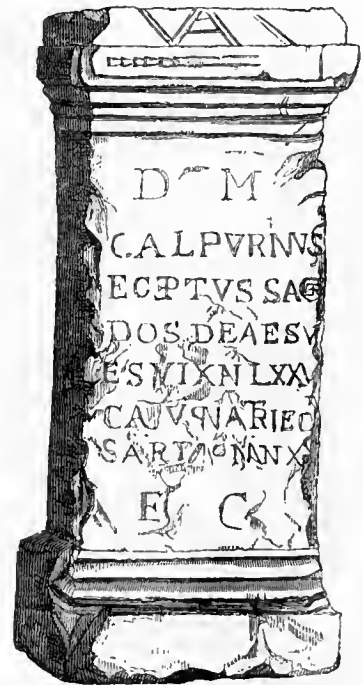

FUNERAL STONE.

There are also several other equally important inscribed stones, among which may be specially named the following altar-shaped stones inscribed:—

LOCVM RELI
GIOSVM PER IN
SOLENTIAM E
RVTVM
VIRTVTI ET N
AVG REPVRGA
TVM REDDIDIT
C SEVERIVS
EMERITVS)
PC

A stone with a part of an inscription showing that it belonged to a building, probably a sepulchre, erected by a son of Novantus for himself and family, is interesting; as is also one found upon the under surface of a covering stone of a stone coffin or cist, containing a perfect skeleton, which bears the inscription thus translated by Mr. Scarth:—"For the safety of the Emperor Cæsar Marcus Aurelius, Antonius, the pious, fortunate, invincible; August. Naevius, Freedman of the Emperor, and assistant of the Procurators, restored the chief military quarters, which had fallen to ruin."

Portions of two sculptured stones, the one being a figure draped in the *toga*, which is fastened on the right shoulder by a *fibula*, and the other representing a standard-bearer grasping the staff of the standard in his right hand while his left holds a scroll, and dressed in a tunic with waist-belt, and the *chlamys*, or military cloak, fastened on the breast with a *fibula*, are also well worthy of notice.

Among the architectural fragments preserved in the Museum, are some remarkably fine bases, portions of shafts, and capitals of Corinthian columns, from the grand old Roman buildings of *Aquæ Solis*, and formed of the stone of the neighbourhood; portions of ornamental friezes, mouldings, &c., &c.; and the *tympalum*, or pediment, and other remains of, the temples of Minerva and of Diana. The *tympalum* here referred to is 8 feet in height, and 24 feet 2 inches in width. It has originally consisted of twelve stones, of which, unfortunately, only six remain. In the centre is a large circle or shield, bearing a boldly-sculptured head of Medusa, or the Gorgon, on each side of which was a figure of Victory. The fragments of the cornice, &c., are remarkably bold and fine, and there are remains of an inscription which probably formed a part of the frieze. A series of fragments of four small sculptures of the Seasons are also preserved, as well as a fine *bas-relief* of Luna, and other relics.

Among other sculptures are, one representing a dog carrying a deer, which is thrown across his back, the feet hanging down behind the right side of the body of the hound, the head on its left side, and the neck grasped by the dog's teeth.

In bronze the two most noticeable objects are the fine head, broken off forcibly from a statue which has never been found, variously conjectured to be that of Apollo, and of Minerva. This head is one of the most interesting Roman remains found in Britain. It has been



BRONZE HEAD OF MINERVA.

engraved in "Vetusta Monumenta," and is considered to be one of the most valuable remains of Roman Art in Britain remaining to us. It is here represented.

Another bronze relic of great interest and beauty, is the medallion of Pompeia. The head, which is in profile, is very beautifully formed, the features bearing a peculiarly pleasant expression; the hair is collected in a braided knot behind, while a single ringlet hangs from behind the ear. On the forehead, and reaching from ear to ear, is worn a pointed frontlet, studded with jewels. In front of the face is the inscription—POMPEIA· I· C· V·

Among minor articles will be noticed a number of *fibulae* of the Roman and later periods; some remarkably interesting Roman keys, spoons, weights, rings, and other objects, as well as some curious and very interesting bronze *penates*, or figures of household gods. Flue and drain tiles of various forms and patterns, are also preserved in the collection, as are likewise some interesting fragments of Mosaic pavements.

In pottery the Bath Museum contains many fine examples, both of Samian and other wares;

including bowls, cups, urns, cinerary urns, lamps, *patena*, *mortaria*, &c. There are also several extremely interesting remains of Roman glass vessels.

Some highly curious and interesting stone cists, one of which contained, when found, the head of a horse, and another an interment of burnt bones, are particularly worthy of notice. There are also a few very interesting stone coffins found in Bath, &c. The stone cists or coffins of this locality are usually of the roughest construction, being simply formed of blocks of the great oolite, with both the inside and outside just as they had been left by the rough hammer of the hewer. Generally the covering-stones were of the same rough character, but occasionally more finished. Of the discovery of two of these, Mr. Charles Moore, F.G.S., gives the following highly interesting particulars. The stone cists having been made, the bodies were placed in them, and the cists then "filled in to the surface with pounded crystalline carbonate of lime, which must have been purposely brought from some mineral district, the nearest being that of the Mendips, where we know the Romans had important mining works. As a general rule, the remains of the Roman city of *Aquæ Solis* lie from 12 to 16 feet below the present surface; and we have these coffins covered up to that depth; but when they were nearer the original surface a number of land shells of the period found their way through the interstices of the lids, while some of the *Brachiopoda*, corals, and other fossils, derived from the superior oolite, were washed in and found in a thin ochreous deposit on the top of the carbonate of lime." A considerable variety of shells was thus discovered, as were the bones of the water-vole;* and among the fossils were two which were never previously met with but by Mr. Moore in the lower oolite of Dundry.

There were also found a bronze bead, and fragments of woven texture of the dress of the lady interred in the cist.

Among the miscellaneous articles in this admirable collection are two fine Egyptian mummies, and other Egyptian and Babylonian remains; a Roman pig of lead, bearing the inscription—IMP· HADRIAN· AVG—found at Bath; a goodly assemblage of celts of various forms, and other weapons, including a fine bronze leaf-shaped sword; some good examples of querns, or hand-mills; an interesting series of casts of mediæval seals, and many other note-worthy objects.

The Museum also possesses an extensive cabinet of Roman and other coins; the Roman series found in Bath alone extending from Claudius down to Gratian. There are also several very fine and rare medals, English coins, &c.

Some valuable and highly interesting and instructive models of Stonehenge, both in its present state and as restored, and also of various Druidical remains in Devon and Cornwall, will be found worthy of examination; and the Museum is further enriched by a series of casts from antique sculptures, and by a variety of other objects, including two elegant vases, exquisitely carved in Maltese stone, some interesting paintings, and portraits of local celebrities.

It is said that the healing waters of Bath were discovered by the pigs of King Bladud while "rooting" and wallowing in the mud through which they passed; and that over these the temples were afterwards raised from which, at the present day, human excavators are continually digging up these ancient treasures of Art.

The Museum, which is under the care of Mr. Russell, the curator, ought to awaken considerable interest in the preservation of the antiquities of the district, in the minds of all the citizens of Bath, and it is much to be desired that all future objects discovered in the locality may find a resting-place within its walls.

* It may be well to state here, as it will be useful in both previous and future articles, to state that in the opening of barrows, the appearance of the bones of the water-vole or water-rat are considered an unerring indication of an interment. In the barrows of the three great periods, the Celtic, the Romano-British, and the Anglo-Saxon, the barrow-opener considers the appearance of these ossific remains to be a sure and satisfactory indication; and an encouragement to him to continue his labours.

XILATECHNOGRAPHY.

UNDER this name, Messrs. Trollope and Son, of Halkin Street West, Belgrave Square, have patented an invention which must, we think, form a new and prominent feature in interior decoration, as presenting more than the possible enrichment of *marqueterie* at one-half of the cost. One of the specimens sent to the International Exhibition is a cabinet, in imitation of ebony inlaid with ivory, so perfect in design and finish as to deceive the eye even on near inspection. The tenuity and sharpness of the lines in this piece of work sets instantly at rest any doubt as to the power of working out minute drawings. The specimens at Messrs. Trollope's establishment in Belgravia are numerous, and so varied in style and character as to show that every kind of flat ornamental design comes within the scope of this method of enrichment.

A vase is brown at the base, with ornaments of a lighter tone, and the imitation of *marqueterie* compels perfect flatness in the leafage and flowers, although we can scarcely think the art will stop until full pictorial relief be attained. Panels thus ornamented are quite a novelty, and look very rich, notwithstanding the wood which receives the design may be of the commonest kind. They are sometimes bordered by gilt moulding framed by dark walnut-wood, which again may be framed in imitative dark oak or ebony, the whole harmonising perfectly with a door-frame of a bright brown or even darker tint, edged with convolvulus leaves of a light tone. Two long upper panels contain a very simple floral design, consisting of a centre-piece and two ends bordered by the simplest form of ladder-ornament, sectioned by daisies. The inner framing imitates richly-veined rose-wood; the door-frame is of deal or ash, coloured yellow or brown. In another door the panels are red, with a floral design edged with gilt-beading, and framed into the door with a deal imitation of satin-wood relieved by black and red mouldings, the frame-work of the door being ebony. Another variety shows upright and transverse panels tinted red, bordered with ebony, red, and satin-wood mouldings, the whole let into a frame-work of rich tint. A very beautiful composition of trailing plants appears on another set of panels. The design is continuous, and as consisting of tendrils, and the most delicate forms of foliage, exhibits the extreme nicety and minute finish to which the work can be carried. We have remarked on the great simplicity of the invention. The principle may be thus briefly described. Let us suppose the design limited to three tones of the same colour—a brown it may be. The forms may, we believe, be made out by stencilling, but, as the art improves, it is reasonable to believe that nothing but artistic drawing can answer the desired end. The drawing having been made either on the natural face of the wood, or on the panel slightly tinted, those portions of the design intended to be the lightest in tone, are carefully covered with a stopping coat, after which the colouring matter intended to represent the second tone is applied, and those portions of the design which are to assume a deeper colour are stopped like the former, and again a deeper colouring is applied, after which the darkest passages of the drawing are stopped out, and the whole is gone over with a tint deep enough to form the general field, or background to relieve the whole. The operation being thus concluded, the stopping-coats are washed off and the work is polished. It will be at once seen that the principle may be carried out with any desirable number of tints. There is no limit to the application of the invention: in Messrs. Trollope's rooms are many very beautiful examples of its various uses as a medium of ornamenting furniture; as cabinets, pianos, sideboards, &c., some very successful examples of which are to be seen in the furniture department of the International Exhibition.

The merit of this invention, and of the major part of the painting, belongs to Mr. Brophy, the very able artist of Messrs. Trollope and Son's establishment.

OBITUARY.

MR. THOMAS AGNEW.

AT a good old age—he was seventy-six—and after a life of useful and profitable labour, this very estimable gentleman died in the neighbourhood of the city where his work was commenced, more than half a century ago. Few men have left earth more deservedly esteemed and respected. He lived to see great Manchester hugely increase in population; but, more than that, he aided largely to advance its material prosperity by introducing among its "Cotton Lords" a love and appreciation of Art that, beyond question, influenced its commercial produce and augmented the wealth—so much of which has been expended in those collections of pictures that are of vast value as "property," but of far greater worth as incentives to education.

The "Men of Lancashire" have learned that "things of beauty" are profitable, as well as instructive, teachers; that they "pay" in a double sense, not only as refining influences, but as actual promoters of the good taste that advances and increases "business."

Much of the beneficial change we have ourselves witnessed in the huge centres of manufactures must be traced to the enterprise and energy of Mr. Thomas Agnew. When we knew him and Lancashire first, it was a rare event to find a purchaser for any work of modern Art: cart-loads of trash under the pretence of being ancient masters, were annually sold in the north of England; works with the names of "Rubens" or "Raphael," or "Titian" found ready buyers; but pictures by British artists had little or no chance of sale: the "old" must be worth money, the "new" worth nothing. We could give many instances in proof of this assertion: some that came within our own knowledge. It was against this delusion Mr. Agnew took up arms, and Lancashire, and Manchester especially, owe him a debt that would be but partially paid by erecting a statue to his memory, among the other worthies of whom the city is rightly and justly proud.

He made a large fortune by his foresight, integrity, and abilities; and he has left successors in two sons, who with sounder Art-education and more enlarged experiences—with "customers" twenty where their father found one—carry on the business he created, and are filling not only nearly every house in Lancashire and the adjacent counties, but the best houses of the merchants of London, with examples of British Art.

So far back as 1816, Mr. Thomas Agnew became the partner of Zanetti, an Art-dealer, then the only Art-dealer (excepting one at Liverpool) in the North of England: indeed, it may be almost said out of London. Zanetti soon afterwards retired, at a "good old age," having done valuable service to Art, to dwell in his native Italy; and Mr. Agnew stood alone to carry out the work he contemplated. The house in Exchange Street, where the business is still carried on, is the house he occupied in 1826.

Mr. Agnew was not only a buyer and seller of pictures: he published many works of Art. One of the best that has been issued in England, ranking indeed in some measure with the "Holy Land" of David Roberts, was the "Lake Scenery of England," by J. B. Pyne: while the engravings he issued are so numerous that a bare list of them would fill more than a column of this journal; among them being several of the highest merit as examples of the Art. He retired from active business in 1862.

He was not without honour during his life-time: in 1850, he was elected Mayor of Salford, having been an Alderman of the borough from its incorporation; and its public museum in Peel Park contains a large number of prints and pictures—his gifts. He devoted much of his time and thought to acts of benevolence, was a liberal supporter of the many charities of Manchester and Salford, and did not think it humiliation to be a teacher in a Sunday-school: while the Peel Park Free Library and Museum, which mainly owed its existence to him, will for ages to come be a means of intellectual enjoyment to hundreds of thousands—in its noble galleries and free library, to which he was a generous contributor.

It is ever a gratifying task to write of one in whom private virtue is combined with public worth; to review a life of great utility, and to find it unmarred by any blot. Generally, laudation for a well-spent life comes when the ear is deaf to the voice of the charmer: yet none the less is the reward sure. Mr. Agnew was fortunate in finding it while he dwelt on earth: of the seed he had planted, he tasted the fruit; he lived long enough to see pictures by English masters he had bought for shillings (then their value) sold for pounds: indeed, in many instances, repurchasing them himself in that proportion: and to know that the change was in a great degree his work. That was in itself a very large recompense for the labour of fifty years; and who will grudge him the fortune by which he was ultimately rewarded, and the house he established its world-wide reputation?

TOMMASO MINARDI.

The student of Art in Rome must be familiar with the name of this painter, who for a long period held the post of Director of the School of Design in the Academy of St. Luke; his death occurred towards the end of January last, at an advanced age. Minardi has been placed at the head of the modern Italian "Purists;" and yet though he possessed positive and determinate ideas relative to Art, they failed to raise him to the rank of a great painter. This simplicity is described as coming very near to monotony, and his calmness, or repose, wants vitality. A correspondent of a contemporary journal, writing from Rome, says,— "He is best known to non-Romans by his copy of 'The Last Judgment,' in the Sistine Chapel, almost his earliest work, which attracted the notice of Canova to his rising genius: almost all the photographs, sold in Rome, of Michel Angelo's *chef-d'œuvre* are taken from it, and it was exhibited by the Holy Father in the Exposition of Christian Art last year. His greatest service to the world of Art, however, has been the formation of that School of artists whose patient works, too little observed by the world, have recently beautified so many churches of Rome with frescoes.

EMMA ELEANOR KENDRICK.

Thirty or forty years ago the name of this lady, whose death, at the advanced age of eighty-two, was announced early in the month of April, was well known in the Art-circles of the time. She was second daughter of the late Joseph Kendrick, a sculptor of considerable repute; and was favourably known as a good portrait-painter. Miss Kendrick was appointed miniature-painter to William IV.

CORRESPONDENCE.

To the Editor of the "ART-JOURNAL."

REFLECTIONS IN WATER.*

SIR,—Having noticed in a somewhat recent number of the *Art-Journal* a short paper on "Reflections in Water," would you permit me to make a few remarks on the same subject, which I trust may prove in some degree serviceable or interesting to Art-students and others?

A REFLECTION in the water is not an OBJECT in the water, and the rays of light proceeding from the first have nothing to do with the laws of REFRACTION which govern those proceeding from the second. This will be evident if we consider that anything is reflected in the same way as to size and shape, whatever the density of the reflecting medium, whether it be water, glass, or polished steel; and whatever its depth, be it the thinnest gold leaf or the thickest plate-glass mirror, a shallow pool, or the "deep, deep sea."

It is, in fact, only with the SURFACE and not with the SUBSTANCE that the reflection has to do. A tolerably correct idea of the matter will be got by regarding that portion of the earth's surface within the limits of the horizon as a huge mirror, on which are placed fields, forests, mountains, houses, &c.; the water representing the uncovered parts. And the simplest rule for the reflections seems to be to suppose everything doubled, base to base,—the surface of the water being the intersecting mirror-plane,—and to draw as much of the reality and reflection as if they were both solid.

By way of illustration, let us suppose A B, Fig. I, to be a part of that mirror viewed sec-

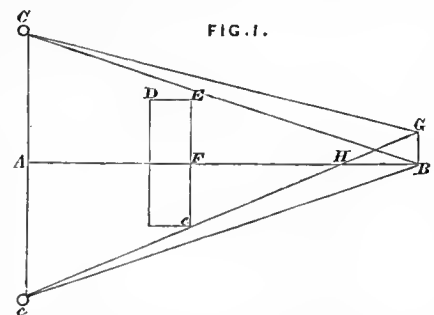

tionally, extending towards the horizon in the direction of A, the spectator's position being at B. It will be evident that if the eye is at the exact level of the water, the reflection of a tower D E F, and the moon C, will correspond with the reality in every particular as to size, position, &c., only reversed; the ray C B passing the corner E of the tower at exactly the same distance as C B from E. Note that in this example the altitude of the moon and the height of the tower are both reckoned from the same level, the level of the spectator's line of vision. Suppose now he gets up on his feet, and that his eye is at G, he will see the moon along line G C, at a greater distance above the tower than before; and its reflection along line G c, just touching the corner of the tower, as it were, the angle of incidence at H being equal to the angle of reflection. But it must not be thought that—whatever be the height of the spectator's position—the moon and its reflection will always appear at exactly the same distance above and below the horizon A. They would do so if A were as far off as the moon; for the instant the moon appeared above A, the edge of the

* With reference to this, and the following letter, which were submitted to Colonel Drayson, the writer of the paper whereon our correspondents have commented, he says,— "Having received some communications relative to the article, 'Reflections in Water,' in the January number of the *Art-Journal*, the following brief replies are offered. The reflection of the sun and of the moon ought, in each case, to be shown vertically beneath the object; thus a line from the sun to its reflection ought to cut the line of the horizon at right angles. In order to determine the position of the reflection of any distant terrestrial object, we should produce the water so that the water-line should come exactly beneath the object; then the reflection will be as much below the water-line as the object is above it."—[Ed. A.-J.]

reflecting plane, that instant it would begin to be reflected—the image descending as the reality ascended; and to find their positions, we should just have to measure them at equal distances from the horizon. But the moon is very far beyond the horizon, and—as is generally well known, we believe—may appear to have risen a short way before it begins to be reflected. A consideration of the annexed figure (Fig. 2) may help to make

FIG. 2.



this plain. The spectator looks, as it were, along a tangent, touching the circle of the earth at the horizon A, the point where the reflection of an object beyond it is first visible to a person at C. Extending the mirror plane B A towards E, we can understand how the moon may be SEEN as soon as it is above the tangential line, C A D, and how it will not begin to be REFLECTED until it has risen some distance above the level of B A E. In fixing the position of the reflection, therefore, we have to make some allowance for this, and do not simply measure under the horizon a distance equal to that of the moon above it; but if we did so—calculating not from the NATURAL but from the PICTURE horizon—the difference would be so inappreciably small as to make the position thus obtained almost correct. From the preceding remarks, too, it will be readily understood why, at sunset, the sun may continue visible for a short time after its reflection has disappeared. The great difference in distance is the main reason why we may see a small portion of the sun over a hazy belt of evening cloud, and yet have its reflection obscured by that of the cloud.

Again, in reference to objects within the horizon; although the length of the reflection is measured from the water-level at the same distance, yet, as the adjoining figure (Fig. 3)

FIG. 3.

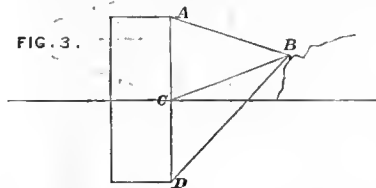

will show, the reflection has to be shortened in proportion as the angle C B D is less than the angle C B A. It will be readily perceived, however, that there will be no very obvious difference except in the case of near objects, and more especially when the spectator's position is high.

The general principles contained in the foregoing remarks afford a sufficiently simple and safe guide in the matter of all plain reflections in still water. As an example, if we had to find the position of the reflection of a bird, we should first find the water-level directly under it, then place the reflection NEARLY as far below that as the bird is above it.

And now as to the long shimmered reflection in rippled or wavy water. Almost every one, we suppose, has observed that it seems to shift its position as the spectator moves; always keeping in a straight line between him and the part of the horizon directly under the sun or moon. And that one may see the effect represented in the picture, in whatever direction he may look at it, the shimmered reflection has to be shown in a straight line, under the sun or moon. If there were any reason why it should be, on any occasion, slanting either to the right or left, there would be a similar reason why, on like occasions, the reflections of houses, steeples, masts, and other perpendicular objects, should slant also. Again, we think it must have been noticed by nearly every one, that the long shimmered reflection seems to widen towards the foreground. This, I am inclined to think, is owing partly to the reflection taking the sort of curved or serpentine form treated of in the previous article, also by Colonel Drayson, in the *Art-Journal* for 1864, though at first sight it might appear

to be only from the perspective. That the latter has something to do with it, I believe; but I think it does not rule it altogether, because a ship at the horizon does not seem to be as broad as the sun's reflection at the same distance; while in the immediate foreground the ship would occupy a considerable space, and the reflection appear only to be at most a few yards wide. Frequently, however, either in looking across a river or over the sea, it may be observed that the distant part of the long shimmered reflection of the sun or moon widens out very considerably; and this may arise from the angle at which the waves receive and reflect the rays of light, or from that and other causes.

There was one of the points in the former paper of which I felt a little doubtful. It is in connection with a small diagram representing a high curving wave, and part of the hull of a vessel, with a mast, as in Figure 4. The writer

FIG. 4.

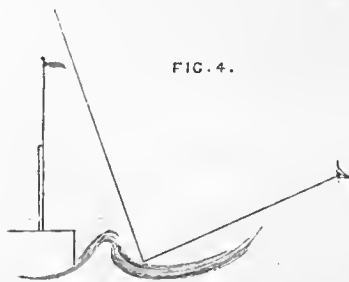

seems to make out that it would be an impossibility to see any of the ship reflected in the inner curve of the wave. As a test I tried the following experiment. Having got two small looking-glasses, I placed them near a jet of gas, somewhat in the positions shown in the annexed illustration (Fig. 5), the faces being towards each

FIG. 5.



other; and found that I could see the gas reflected in the one nearest it,—not indeed directly, but from the other;—as some part of the ship might be reflected indirectly from a nearer wave. The same holds true also when the mirrors are placed at various angles and distances, as may very readily be proved. It may also be seen that by placing the mirrors as in Figure 6, the gas will be reflected in A; from which it may be deduced

FIG. 6.



that the reflection of a bird, for instance, may be seen in a wave beyond it.

It may not be altogether inappropriate to take this opportunity of mentioning a problem which I thought of proposing in the *Art-Journal* some years ago, and which some reader may have the means of solving.

It is this:—Are circles in perspective, when not parallel with the picture-plane, always of an elliptical form, but having the near side a little wider than the other, and a little fuller in the curve toward the ends;—or, are they of an irregular shape?

A fair means for the solution of this problem seems to be presented by photographing in the required positions a perfectly flat board, having drawn on it a large square described about a circle, and measured out into small squares. Whether or not microscopic photography and subsequent enlargement would give greater accuracy I do not know. Experiment will, in all probability, determine the point.

J. T.

REFLECTIONS, IN WATER.

SIR,—I beg to offer the following answer to the first question on Reflections in Water, proposed by Lieut.-Colonel Drayson, in a recent number of the *Art-Journal*.

The reflection of the sun or moon will be vertically under the object, and as far below the horizon as the object is above. This, however, is on the supposition that the distances of the sun and moon may be considered infinite, and the horizon to coincide with the horizontal line of the picture. In the second question I do not see how the reflection of the windmill can be determined without knowing the height of the horizontal line, and the inclination of the hill on which it stands, or equivalent data.

H. A. O.

SELECTED PICTURES.

FROM THE PICTURE IN THE COLLECTION OF FREDERICK WILKINSON, ESQ.

THE WHITE COCKADE.

R. A. Hillingford, Painter. G. Greatbach, Engraver.

MR. HILLINGFORD is an Englishman, not a Scotchman; were he the latter, we might be disposed to think he had a strong national sympathy with the fallen dynasty of the Stuarts, and those who were out "in the '45" on the side of the Pretender; for he has painted several pictures illustrating some of the events connected with the insane attempt to dethrone the house of Hanover: of these we shall find opportunity of speaking at another time, as we are arranging to include this painter in the series of "British Artists."

A white cockade was regarded as a badge of partisanship in favour of the Pretender, just as the white and the red rose distinctively marked the adherents of the York and Lancaster parties in the old civil wars of English history. When Prince Charles Edward entered Edinburgh the Jacobite ladies welcomed him by waving white kerchiefs from the windows of their houses, and white cockades were distributed plentifully among his followers: these cockades were made by the fair hands of those who desired the success of him and his cause.

We may assume that the females in this picture were thus engaged, when the sound of the pipers at the head of the Highlanders under Cameron of Lochiel, as they entered the city, reaches their ears: the young boy rushes to the window to see the military display, the daughters and their mother cease from their work, while the latter clasps her hands and looks upward as if silently uttering a prayer of thanksgiving. In the open doorway is visible the head of the household, evidently charged with glad tidings of the entrance. Over the console-table is an equestrian portrait, possibly intended to represent the elder Pretender. The scene is most agreeably placed on the canvas, while all is very carefully worked out: the dresses of the group, the large apartment with its luxurious furniture and appointments, bespeak a family of good social position. One cannot but acknowledge the wisdom of the little fellow at the window, who has already mounted "the white cockade," but takes care that it shall not yet be visible; so he has turned it over his shoulder, lest the music should herald foes, and not friends, to the cause he espouses, and so the family would be compromised. The timid look of the younger of the daughters also implies some doubt as to which of the rival parties the soldiers belong; but the elderly lady has, evidently, no doubt on the matter.





A GENUINE ARTISTIC RACE.*

PART V.

INDUSTRIAL or social science is no impediment to Art in Japan. It gets at its results in its own way. As a people they contrive to live pleasantly without being in bondage to any system of superfluous wants. They have no furniture to speak of. But their most common articles in some fashion must be stamped with beauty. This is the feature which *first* strikes the senses. Convenience is secondary. They heap up tasteful treasure in which beauty is paramount to beguile the mind from dwelling on physical ills. Wonderful to relate, in their enjoyment of its objects, they actually forget our numberless necessities of life. No people can grow up with this disposition without having some of the suggestive loveliness, grace, delicacy, refinement, and atmosphere of natural truth permeate their minds and manners, even if it do no higher spiritual service to the intellect.

As regards the Industrial Arts, the principle of making ornament subordinate to use is sound. The constructive form of the object should be carefully adapted to its final purpose. If grace of form and lovely colour are superadded, these should be as accessories to commend it to the taste. But a mischievous confounding of the fundamental purposes of Industrial with the Fine-Arts is common in Europe, and universal in America. We have in consequence a vast number of things incongruous in constructive principle, vulgar in ornamentation, garish in colours, and at the same time of small value for any practical purpose, while those intended only to please the taste are tortured out of their legitimate forms by the vain desire to make them subserve a domestic need. Our homes are crowded with inappropriate objects. Money is worse than wasted on heaps of uncomfortable trash, frivolous in motive, inane in make, and annoying to the artistic sense. Paris sets this foolish fashion. The greater part of her productions are not only wrongly conceived structurally, but false as to the grammar of ornament, and very often extremely ugly. Each fresh departure from classical forms constructed on principles of harmonious curves, related to one another by subtlest gradations of lines, displays a pitiable poverty of æsthetic invention. There is no surer method of demonstrating the radical defects of the average European ornamentation than by placing it beside the common examples of Japan. Even since the Chinese followed the European track, its Art has lost those genuine qualities which, while distinguishing it from the ornament of their rivals, gave to it a peculiar value only second to theirs.

Kioto, the sacred city, is the central site of the old Art of the Japanese, and Yedo of the more recent; both to this time displaying the freshness of an unaltered youth. Feudalism has operated advantageously by providing numerous princely patrons, who, like the Dukes of Urbino in Italy in perfecting Majolica, sought to develop various branches of the minor Arts less for profit than as insignia of aristocratic culture and regal gifts. Their best epochs seem to correspond with the European; for there is a generic likeness in the decorative styles of porcelains and enamels, varied of course by the specific tastes and resources of the Japanese, to the successive Art-waves which have passed over Europe. Perhaps it would be more exact to divide the periods of Japan into two great ones, answering to our religious and naturalistic developments. The first would be contemporary with the ancient dynasty of the Mikados; the second, coming into vogue with the race of Siogoun usurpers and corresponding to the Renaissance, but without its *rococo* folly. Their virgin freshness, perpetuated through so many centuries, is largely due to the habits of the artisan. He laboured alone in his own house or with sympathetic associates on such branches of Art as had been slowly perfected in his family through many generations, fostered by his feudal lords. Hence he was born both to skill and pride in his work; in itself a marked difference from the hard choice between starvation and the

monotonous, unintellectual toil which herds European artisans in unwholesome factories and filthy purlieus of crowded cities. Further, the nature of his task, akin to his tastes, was a prolific source of happiness to all concerned. Besides the domestic satisfaction of being always at home in congenial society, which afforded him qualified critics and co-labourers, his own spirit unconsciously partook in some degree of the beauty and refinement of the motives which inspired his Art. These in general were either derived from the beautiful landscape that was ever a fruitful spring of pleasure to his household, in addition to supplying their modest wants; or from the pictorial literature which embodied the myths, history, and mythology of his native land. It is no matter of surprise, then, that he left his work with reluctance, and was diligent in perfecting it without regard to his pay. At the same time he worked only when in the proper mood to do it fullest justice, and sought his repose the instant that fatigue warned him of failing power.

Let us carefully observe some of the points he kept steadily in view. First, the mechanical finish is complete and equal throughout, and not excelled in scientific exactness by the best workmanship of Europe. Experience shows us that any closely fitting article after centuries of wear remains as perfect as when it left his hand. Whereas the subsequent shrinkage and want of original nice adjustment in European objects of a corresponding age is apparent to every collector.

Second, the ornamental features are designed and finished with equal scrupulous care. While nothing superfluous to the specific aim is allowed, there is not the slightest neglect of any portion whether prominent or not. Thoroughness is the rule.

Third, variety in form and expression is likewise the law. No pairs of anything are precisely alike. Every object has its peculiar features, differing from all others of the same family, as one man is unlike another. There are no monotonous resemblances and platitude of character as with most European productions. The commonest article has its distinct artistic physiognomy, even if repeated a million times, and costing only a penny or two. Some of the cheapest are endowed with profound æsthetic significance. A hair-pin, comb, knife-handle, or any object in itself of homely utility is exalted into beautiful Art. Exquisite taste, enlivened by an everfertile fancy, seems universal; and to a degree that exacts no inconsiderable æsthetic culture on our part to appreciate adequately. European ornament of the present time is apt to pall on the sight. It constantly demands new fashions to keep it even in temporary favour. The Japanese, as with tried friendships, becomes dearer the longer we know it; while its fecundity is no less a marvel than its perennial freshness and the perfectness of its many-sided life.

Fourth, perfect adaptation of specific detail and the *ensemble* of the decoration to the composition as a unity to the particular purpose of the article, or else such a complete independence as to banish all appearance of serviceableness, are obvious features. This organic freedom is so emphasised that a bit of Japanese porcelain finds its true place anywhere, as regards its delightsomeness. Whereas a Sèvres or Dresden vase must be put into the exact position for which it was constructively designed, to get out of it any adequate æsthetic satisfaction. In its best estate, it is a frail, insipid beauty; but more often crude, mishapen, and superficial, however showy in apparent accomplishments. Here is a specimen of Yedo porcelain of the seventeenth century in the purest naturalistic manner. It consists of a lower globe flattened at base and top, on which rises another smaller and flatter, supporting a wide-spreading top equal in height and double the diameter of its supports, the combination forming a singularly novel and gracious vase. Faint gold bars and hatchings tone the creamy white enamel. The broad, shallow mouth is protected by a narrow edge carrying the old Greek fret in red, while inside we have branches of fruit-bearing trees in full blossom of raised enamel, sheltering birds of brilliant plumage. The undermost globe or base shows

a wilderness of flowering plants in luxuriant freedom, having a Garden-of-Eden look. Separated by a red line, the smaller globe represents in low relief the blue sea lashed with foaming breakers by a typhoon; the demon of which, in the likeness of a golden-eyed, horned dragon, with crimson-striped belly and spotted green back, is sporting therein with malicious joy. In poetical opposition to this spectacle the convex surface above is circled throughout with tiny wreaths of rarest flowers, grasses, and blossoms intertwined, and most delicately executed, caressing the golden white porcelain, and making it look as if fairies had been dancing thereon, when, alarmed by mortal approach, they had flung down there garlands just as they stood, and fled away.

Fifth. Pure form does not hold a superlative position as in Greek Art. Classical bronzes, terra-cottas, and glass relied on graceful shape, their ornament being in *silhouette*, and colour and drawing subordinate to the general form. The Japanese, without neglecting form, work on a different system. Some of their vases compare favourably with Grecian. Often *bizarre* and grotesque in design, they are almost always superior in outline to the European, which owe nothing to classical patterns. Indeed, their forms are so original, diverse, and attractive, that these features alone would give them a foremost position in this kind of Art, quite independent of their unrivalled brilliancy, harmony, exquisite combinations, and subtleness of tints. It would be more apposite to state their artistic unity is so perfect, that the eye at first overlooks the more intellectual harmony of forms in its intense sensuous delight in perfect colour. Europeans attempt impossibilities. They copy on porcelain highly-finished paintings of infinite detail, or objects from nature, line for line, tint for tint, trying to reproduce on hard, reflecting, concave, convex, or rounded surfaces, without regard to the destined use or position of the vessel, perspective, foreshortenings, distribution, light and shade, and other complicated technical effects. Curvatures of a vase or dish necessarily destroy the perspective of a flat picture taken from its proper point of view, while its glistening substance reflects light, kills *chiar-oscuro*, prevents atmospherical effects, and obstructs those transparent gradations of colour needed in an oil-painting to complete its legitimate illusions. Fine Art proper has no more right of place in pure ornament of this character than has natural history or science. Sèvres china essays too much in this line in a soulless, mechanical manner, as offensive to rightful Art as bad grammar to literature. The crowning merit of Japanese work is the appropriateness of its composite decoration. Each pattern is the result of a careful calculation of its relation to a given whole, causing the object invariably to preserve its proper ornamental character, logical in construction, seductive in appearance. If this fascination be less profound than that of the best Grecian ornament, it is more varied and lively. The Japanese artist knows how to put in accord simplicity, directness, and severity of style with richness, variety, delicacy, and even grandeur; varying these qualities with the picturesque, humorous, weird, and *bizarre* of correlative merit.

I know a Yedo bowl of massive porcelain which well illustrates their severely grand manner. It is of elegant proportions and form, of an intensely indigo blue colour on the outside, with a milk-white relief of ocean-breakers tossing jets of spray into the empyrean above, in which in giddy whirl fly, in single file, round and round the upper edge of the bowl a flock of the "holy birds," those sacred birds that watch over human longevity and happiness. The entire bowl seems in motion with their rapid, revolving flight, each with a different and forcible action, suggesting a cosmic scene at the dawn of creation. Inside, this movement is repeated, the colour being reversed and on a wholly flat surface.

But it would fill volumes simply to enumerate the notable specimens of lacquer, bronzes, arms, metal-work, inlaid and otherwise, ivory carvings, the processes of which are peculiar to Japan, and constituting an Art that seems

* Concluded from p. 162.

more like alchemic magic than the result of skilled industry. The *cloisonnée* enamels of ancient make are miracles of material strength and lightness, united to wonderful intricacy of harmonious design, and a subdued splendour of colour which quite justifies the enthusiasm of an amateur who compares their commingling of inorganic forms and tints to "star-atoms, the milky way, and crushed worlds." When we can make a vessel of this character we may feel convinced that we are in the right track of Decorative Art. But it is to be feared that the commercial spirit will in time so master the aesthetic constitution of the Japanese, influenced by the example of Europe, as to lower their standard to the unpoetical level of the latter, and thus drive from the world its last genuine school. Perhaps the past has fulfilled its work, and the future may have in store an even nobler gift. Not only has Japanese Art cheered the lives and softened the manners of countless millions of our fellow beings during decades of centuries, but it has also conferred an inestimable boon on humanity. Just before the advent of Jesus Christ, a sculptor, Soukonné by name, hearing of the death of the reigning empress, carved some images, in stone; and, taking them to the emperor, persuaded him to put them into the tomb instead of immolating the favourite servants of the deceased to wait on her in the other world. From that time the cruel custom was abolished, and as a commemorative distinction, Soukonné was ordered to change his designation to *Fansi*, the artist.

J. JACKSON JARVES.

Florence.

HOW THE LOUVRE WAS SAVED.

THE apprehension that the Louvre had fallen a sacrifice to the late Communist conflagrations may be said to have produced the most poignant emotion attending any one incident, amid the group of stupendous horrors by which the close of the Parisian insurrection was signalised. It may be safely affirmed that, all over Europe, a most painful suspense prevailed, for a brief interval, on this momentous point; and it is not a little remarkable that in Paris itself, and consequently throughout France, the feeling existed some days before the truth regarding it transpired. The first bulletins of the burnings affirmed positively that the Tuileries, the Louvre, and the Palais Royal had all collapsed together in one common ruin. In the chaotic confusion of a street and barricade-war, aggravated by vast petroleum-fed fires, which canopied the scene with a dismal darkness of smoke, it would seem to have been impossible for people to scrutinise clearly, or conclude safely, as to scenes before their eyes. Gradually, however, the truth came to light; and we now offer to our readers a short sketch of the fortunes of the great French Temple of Fine Arts, in the perils it has just undergone.

The disaster of Sedan, foreboding as it did the realisation of a siege of Paris, gave signal for the adoption of decisive measures to save the Louvre from the sinister visitations of war. Peremptory orders were transmitted to its guardians to encase, precipitately, the most valuable masterpieces in the collection, and despatch them forthwith to the Arsenal at Brest. This proceeding was, in the first instance, put into force in the great epic square saloon, with its wondrous *élite* of high class pictures—its Raphaels, its Titian 'Entombment,' its Murillo 'Ascension,' *et hoc genus omne*. Then came the small but glorious cabinet adjoining, dedicated to Italian paintings of the sixteenth century alone; and so on, to the long gallery of "review," with its contrast of the different schools.

The French masterpieces, then,—the Poussins and Claudes, and Le Sueurs,—were put through the same course of conservation. Thus arrived the ominous 4th of September, when it would appear to have been considered unsafe to expose pictures to the casualties of the road, and the work of their transmission was suspended.

As, however, each precious lot of packages had been sent away, it was accompanied by a member of the administrative management of

the Museum; and, on its arrival at Brest, was formally consigned to the care of an authority established there for the purpose; and so, from that period to the present, the whole has been safely protected.

With regard to the pictures—which had been packed up, but not sent on, and in which the French school of the eighteenth and nineteenth centuries was illustrated—they, together with the Lacaze Gallery and original sketches, were, by the direction of the National Defence Government, deposited in the ground range of vaulted roofed halls, and under staircases also vaulted—in fact, in every place apart, where architect and engineer vouched for their safety from the enemy's projectiles.

While these operations were being effected by the parties to whom the protection of pictures was entrusted, those to whose care objects of mediæval and renaissance *virtu* were consigned promptly denuded the glass-cases of their precious contents and concealed them in recesses in the thick walls of the Museum, which to the authorities were fortunately familiar.

The most delicately-frail relics of the classic times were not forgotten; but were, under the pressure of the occasion, consigned to subterranean vaults, where they had to mingle with an accumulated congeries of casts.

After the investment of Paris was realised, the finest antique statues were severed from their pedestals—some being strongly boxed up, and all ranged in angular spaces, which were deemed projectile-proof.

All the windows of ground-floor lines of the building were firmly built and blocked up.

Moreover, a reservoir of water was erected on the Quays in front of the Apollo Gallery, from which an engine could inundate the roofs of the precious structure; while, in each separate saloon, hand-pumps, large vessels for water, sponges, and every available auxiliary for competing with conflagration, were accumulated.

To render all these cautions complete, they were placed under the scrutiny of a fire-engineer corps, sustained by the embodied attendants of the establishment, and by its special guardians, who maintained a double watch continuously relieved.

We should not omit to notice one very ingenious and appropriate expedient resorted to in the series of protectionary proceedings, and it was this—that the most valuable Egyptian papyrus, and other antiquarian gems, were consigned to the porphyry sarcophagi, the covers of which were replaced and powerfully cemented.

The pictures and statues of the Luxembourg were, in like manner, carefully consigned to the vaulted ground-floor chambers of Mary di Medici's Palace.

Such was the state of things when, on the 2nd of March, the Prussians paid their visit to the Louvre.

Upon the withdrawal of the Prussians, the reinstatement of a portion of the objects of Art which had been retained in Paris was immediately undertaken, and, upon the 14th of March, both artists and the public at large could enjoy a visit to some of the galleries.

Then came that unfortunate 19th of March, when the regular troops, by whom the Louvre had been protected, were ordered to fall back upon Versailles, and the National Guards, having taken possession of every entry or issue to the place, it became for a while closed to the public. Its ultimate trial and deliverance followed. It fell under the dispensation of a military governor of the Commune, and he deemed it fitting that it should be re-opened on the 13th of April. The administrative attendants, who quietly retained their places of guardianship, acted with cautious acquiescence upon this dictation, trusting they might be permitted to remain in their conservative position. In this hope, however, they were disappointed, and, on the week preceding MacMahon's final assault, they found, in the *Official Journal* of the tottering insurgents, a notification that they were discharged from their duties. They were superseded by a discreditable committee of artists, who, avowing themselves adherents of the barbaric party in power, had been elected to that position by a poor minority of the profession.

By an amusing and most commendable *ruse*, the superseded body contrived to remain practically in their places, for as long an interval as possible, by a conscientious minuteness of detail, in handing over to their successors, with all due formality of record, the vast number of objects for which they had been responsible. During this proceeding, seclusion from the maniac public was requisite; and all was closed, including the Gallery of Apollo and its treasure of gems, crystals, enamels, and carvings in gold.

The trial of fire now threw its menace round this great temple of the Arts. When the contiguous Tuileries was in general conflagration, and the adjacent Palais Royal was also delivered to the flames, what hope remained for the salvation of the Louvre? A very ominous incident seemed to involve it in the ruin impending over the whole quarter. Certain ruffian emissaries of the Commune intruded upon its *pene-tralia* with the mission, for which there would seem to have been no reasonable grounds, to search in its range of vaults for supposed secret passages to the *Champ de Mars* or the *Château de Vincennes*. Into these dark receptacles of many *disjecta membra* of sculpture and canvases they descended, compelling M. Morand, a responsible member of the guardians of the place, to be their guide, and, with pistols truculently thrust against each side of his head, putting his coolness and courage to the test at each successive failure in their researches—which in the end proved but vanity and vexation. What a subject is here presented for some future picture—an historic illustration of times unprecedented in their speciality of horrors!

Whatever the intentions of the Communists may have been in regard to the sacrifice by fire of the Louvre, and they are unworthy the benefit of a doubt on the point, the catastrophe did not occur, owing to certain different causes: first, the difficulty of propagating the fire from the Tuileries to the Fine Art quarters; secondly, to the repugnance of the artist-agents of the Commune to promote so foul a professional calamity; thirdly, to the active exertions of the faithful officials of the place, more especially Mons. M. H. Barbet de Jony; and finally to the unanticipated rapidity of the advance of the troops under MacMahon. But had the galleries been unhappily consumed, it is now a matter of certainty that the works from which they have drawn their greatest renown—the Raphaels, Paul Veroneses, Titians, Correggios, Murillos, Rubens, Mantegnas, Van Dycks, the galaxy of the Dutch and Flemish collection, the Claudes, the Poussins, the Le Sueurs, would all have been saved within the protecting retreat of Brest.

The building of the Louvre has also been fortunate exteriorly, yet not without most critical incidents of danger. After being abandoned, as a post, by the retreating Communists, the troops of the line made a partial entry into it, in order more effectively to carry on their attack upon the Barricade de L'Ora-toire, which was thrown across the Rue Rivoli. One of their officers, however, who was told of the danger that would assuredly arise from its being made the actual source of contention, promised that there should not be a fire of musketry from its windows. A superior in command took a different view of his duty and issued a contrary order. The untoward result was, that from a battery on the Pont Neuf defending a barricade, at the construction of which it had so happened the whole administrative corps of the Louvre had been compelled to work, a flight of projectiles was directed upon the gallery. From these, the *façade* of the building received some severe disfiguring wounds. In another instance a tricolour flag had been hoisted over the dome of the *Pavillon de L'Horloge*, and instantly became an object of fire from the insurgents; but the general in command, anxious to save the fine *caryatides* of Sarrasin, placed underneath, from the danger by which they were thus menaced, ordered the flag to be withdrawn, and the anticipated forbearance was obtained.

In a word, then, the Louvre promises to be itself again, after a short restorative interval, and over its chief portal might be inscribed, upon the suggestion of the classic muse, *Sic me servavit Apollo*.

FRENCH PICTURES.

A SECOND exhibition of works of the Society of French Artists is now open at 168, New Bond Street, organised by the same committee of very eminent painters under whose auspices the former exhibition was administered. The works are few when compared with the numbers found in our own principal galleries; but they are very select; many are of rare excellence, and all are of a size well suited to mingle with such pictures as are found in English private houses. They are the property of various contributors, and are supplemented by a charming private collection, the property of Mr. Laurent Richard, who by removing it from France in time to this country has saved it from certain destruction, his house at Neuilly and his establishment in the Rue de Rivoli having both been destroyed.

By the attractions of these works the visitor is drawn from side to side of the room; but at length, fascinated by their lustre, settles in patient contemplation of a couple of Meissoniers, the more remarkable of which is 'The Guitar-Player,' a small figure loosely dressed in the costume of the middle of the seventeenth century. He is seated, and plays from a music-book, propped up before him, with an earnest expression of feature which tells us he has a difficult passage to deal with. In brilliancy and harmony this picture surpasses all the single figure-subjects by the artist that we have had the good fortune to see. The second is 'A Soldier of the Time of Louis XIII.,' which, although very rich in many of the finest characteristics of the painter, is much inferior to the other. The equipment is a buff coat with loose skirts, long boots, a Spanish hat, long rapier, and other items of the period. It is worth a visit to the gallery to see these pictures alone. The great successes of this collection are principally landscapes, of which there are not fewer than thirteen by Theodore Rousseau; the grand crowning-piece of these is called 'Le Givre;' it represents a wild solitude, canopied by a dark, tumultuous, and threatening sky, which in the horizon marks the time by indications of a sunset; that is, the strong colour is rather that of sunset than sunrise.

It is necessary to sustain our statement as to the excellence of these gatherings, by giving the names of some of the painters; they are known as men whose successes are transcendental, and whose failures are always original and interesting curiosities. Thus, in continuation of Mr. Richard's works we have by Eugène Delacroix six, prominent among which are 'Medea,' 'St. Sebastian,' and 'The Crucifixion;' by Diaz three, 'Bohemians,' 'Forest of Fontainebleau,' and 'In the Woods;' Jules Dupré, ten landscapes; Troyon, seven cattle subjects of great power and beauty; Ziem, 'Stamboul' and 'Venice;' Corot, four; Clays, 'A Calm;' Fromentin, two Arab subjects; and we are referred to the past by examples—some precious, all interesting—of Fragonard, Ommeganck, Gericault, &c.

To turn to the works of the contributors in the other assemblage: there is, by Diaz, 'Diana and her Companions,' a small picture of infinite sweetness, remarkable as studiously rejecting every cognizance of classic Art: to this M. Delaunay offers a contrast in 'Rescued,' a small work founded on the story of Hercules, Dejanira, and the centaur Nessus; here the antique has been consulted. Brandon has an able agroupment of 'Italian Peasants;' Hébert, 'At the Fountain;' Corot, a variety of landscapes; T. Rousseau, five examples of village scenery and open country subjects; Jules Dupré, landscapes, figures, and marine views; Daubigny, landscapes and various effects; Troyon, landscapes and groups of cattle; Fromentin, several Eastern subjects; Diaz, forest scenery and figures; Roybert, animals and figures; Decamps, animals and local studies; Delacroix, dramatic and figure pictures; and also works by Lambert, Millet, Ribot, Guignet, Ricard, Gesa, Regnault, Melin, Troyon, Schreyer, &c. So many of these are brilliant stars in the galaxy of French genius, we regret the necessity that compels us to pass their works with the mere record of the artists' names.

INTERNATIONAL EXHIBITION.
THE BELGIAN PICTURES.*

In continuation of our notice of this section of the picture-galleries, we may point out the following, as specially worthy of remark:—

In 'The Rehearsal' (833), A. ROBERT, appears a company of monks engaged in preparing a psalm or chaunt, for execution perhaps in public. The executants are staid and earnest in their purpose, but the painter has not been able to resist the temptation to show a slight leaning to caricature in portraying some of the heads, which he characterises generally as belonging to persons of little intelligence or refinement. The picture is remarkable as being entirely devoid of colour, the brown frocks of the monks being relieved simply by the plainest background. The heads are brilliant and very careful, and the work is altogether of much excellence—a daring proposition very skilfully carried out. A new version of the story of Lady Godiva, is presented to us in No. 868, J. VAN LERIEUS, or rather a rendering of the tradition such as we have never seen before attempted. The figure is entirely nude, with the exception of a curtain which she in a moment of alarm wraps round her. She is quite alone, having just descended the staircase leading into the castle-court, where her horse awaits her. The object of the artist has been to tell the story by means of a nude figure, which by the way is admirably painted, and certainly the allusion is as perfect as if the picture were vulgarised by a number of probable circumstances. The modesty and apprehension of the lady at the novelty of the situation, are impressively depicted; but in order to enhance the brilliancy of the flesh-painting, the curtain which she in her fear wraps round her is so heavy, dark, and dull in colour, as absolutely to divide the figure into parts. This is a grave error, as but for this, the picture had been of rare excellence—a connecting link between a classic Andromeda and a Titianesque Venus. 'Good Luck' (766), C. BAUGNIET, describes the turn affairs are taking in a hovel, where a gipsy is the officiating priestess. We are bound from their dress to assign the ladies who consult the sybil a creditable position in society. The intention is perspicuous enough. In 852, 'A Painter,' A. STEVENS, we are introduced into a richly-furnished studio, wherein is seated the artist, apparently contemplating a cast of drapery which he is about to copy. There is much sound work in the picture, but we are left in doubt as to whether the figure bearing the drapery is a living model or a lay figure; and also in 'The Pilgrimage' (791), C. DE GROUX, we are in ignorance as to the object of the pilgrimage; and there is nothing in the composition to declare it. The picture is attractive from its high merit, but the artist does himself infinite injustice by his imperfect title. 'Camoens shipwrecked, 1560, saving only his *Lusiad*,' (845), E. SLINGEN-EYER, is an admirable but a very difficult subject. It is here rendered unnecessarily repulsive by a show of the bodies of the drowned sailors. M. ADOL. DILLENS exhibits a very successful work (797) which he calls 'Recruiting,' but this title explains in nowise the situations in the composition. There is also by the same painter a highly characteristic and powerful work, 'A Village Feast, Zuid Beveland,' and by BARON WAPPERS, one of the touching incidents

in the closing scene of the life of Charles I., that of the presentation of a rose to the king on his way to the scaffold. The flower is given by a girl who kneels to the monarch as he passes. The resemblance to the king might have been better, but it yet sufficiently identifies the unhappy monarch. 'The Dead Lamb' (774), by H. CAMPOTOSTO, is one of the best pictures in the room. It shows two young cottage children weeping over their dead pet-lamb. The elder is a most successful study, indeed the principle set forth in the lights and darks of the figure refers us to the acknowledged and too little followed canons of the great spirits of the Art.

In the pictures above mentioned those have been selected which illustrate some characteristic of Belgian Art, and it will be observed that in their highest walk the Belgians owe nothing to the Flemings of even the palmy era of their school. But it would be difficult to have escaped such an influence entirely; we find therefore, allowing for the passage of time, some effective practice according to the precepts of the grand old Dutch and Flemish worthies, who although dead yet speak.

Of animal-painting there are many superb examples, as 'Field Life,' (775) H. CAMPOTOSTO and E. VERBOECKHOVEN; 'Group of Sheep' (795), P. DIELMAN; 'Horses at the Watering Place' (799), E. DE PRATERE; and by the same (800) 'Beagles;' 'Flock of Sheep on the Downs' (842), C. T'SCHAGGENY; and by the same, 'The Return to the Farm' (843), and 'Le Coup de Collier' (844); 'The First Snow' (859), C. VERLAT; 'Horses in a Field' (864), J. L. VAN KUYCK, &c. Many of the landscapes evince much freshness and force, referring for their principles and taste rather to the French than any other school. Of those most conspicuous by their merits are, 'Old Ponds in the Park at Tervueren' (763), and 'Near Dinant—Winter' A. ASSELBERGS, (764); 'Winter in Flanders' (783), MARIE COL-LART; and by the same a 'Flemish Orchard' (784); 'A Rapid on the Lesse' (814), KINDERMANS; 'Ponds near Ostendrecht' (818), T. P. F. LAMORINIÈRE; 'Winter' (823), J. L. MONTIGNY; 'Dauphiné—France' (831), J. QUINAUX; by F. J. ROFFAIEN are 'The Road from Zermatt to Riffelberg, Haut Valais' (838) and 'Monte Rosa from the foot of the Riffelhorn' (839), 'Trooz, near Liege' (870), and 'Prayon, near Liege' (871), J. VAN LUPPEN; &c.

The works have been judiciously selected with respect to a fair representation of the several classes; but we cannot help thinking the standard would have been higher had they been gathered from public collections of acknowledged worth; a measure all but demanded on an occasion as the present.

BAVARIAN PICTURES.

The works representing the painters of Bavaria are, with a few exceptions, the contributions of the artists themselves, and nearly all have been painted within the last two years. A few rise into serious and *de facto* narrative; but the majority of the figure-compositions are founded on simple every-day incident. There are sacred subjects in which executive argument might have been expected on the side of that linear severity to which years ago Bavarian artists were much inclined; but however impressionable they may have been to early Italian Art, they seem more completely than ourselves to have risen superior to unwholesome illusion. In support of this observation we may point un-

* Continued from page 169.

exceptionally to the entire assemblage, although it presents nothing to contrast with its now prevalent popular manner. By KAULBACH (we presume Wilhelm Kaulbach, the great stereochrome ornamentist of the new Museum at Berlin) is a subject from "Quentin Durward" (901), called 'Louis XI., and his barber, Olivier le Dain,' of which the painter has made a picture of rare excellence. If it be not by Wilhelm Kaulbach, it is at least as good as anything that artist has ever done. The king is kneeling in prayer, and Olivier le Dain appears a little aside, and seems unwilling to disturb him. The situations are nothing but commonplace, but the learning of the master appears in the perfect suppression of all disturbing influences, and the rejection of a hundred details with which less profound students would have embarrassed the subject. Again, in the working of the picture there are a sweetness and a crowning grace—results only attained to by long, earnest, and successful inquiry into the mysteries of the art. 'Lost' (898), L. Z. HOFMANN, is the title of a picture which offers many points of interest in its dispositions and effect; but the title is so insufficient, that it is in nowise allusive to the two figures which it should describe.

In 'Taking Leave' (933), J. WATTER, the forcible opposition of extreme tones is shown in imitation of certain of the famous old Dutch pictures. The incident takes place in the vestibule of a noble country mansion, and tells of the affectionate parting of a sportsman and his wife, it may be. He is got up for the hunting-field scrupulously according to French taste. It is a pleasing cabinet-picture. Another work, referring immediately to the old Dutch school, is 'Cossacks at a Ferry' (890), by B. TOS; it is an effective study of gradation to the jealous exclusion of colour; and again in a 'Moonlight Landscape—Winter' (926), painted by STADEMANN, where the sky reminds us forcibly of Vander Neer, and the ice-plains of Cuyop and others who have most successfully described winter-scenery. Nor can we help remarking a very excellent cattle-picture (931), by F. VOLTZ, called 'Cattle—Noontide,' a work which might be placed side by side with the best animal-pictures of any period; it is very equal in execution, firmly worked, and, though without the finish of Berghem, reminds us strongly of his predilections in arrangement. Very different in feeling from these are (918) 'A Bird's Funeral,' L. NEUSTATTER; and (887) 'On the Way to School,' P. BAUMGARTNER, which are based on a class of incident not recognised, and worked out with a sentiment not felt, by the magnates of the Low-Country schools. The former is a solemn and lachrymose procession, forming *queue* to a canary on its bier; and the latter, a company of children evidently on their way to school, but bent on riotous enjoyment rather than on acquitting themselves creditably before their master. The merits of these works are diverse. The former with all its moving sentiment is somewhat hard in manipulation; but the latter has much tenderness of feeling, and evinces a masterly knowledge of the refinements of gradation proper to skilful relief. To understand these pictures, titles are not necessary; but we have to remark on the injudicious artists do themselves by describing their subjects imperfectly; a very striking instance of which occurs in 'The Involuntary Return' (882), A. DEIBL, a title which in nowise helps to a solution of the situation. 'An Alpine Nosegay' (920), A. NIEDMAN, contains two figures, that of a girl sitting near a window

arranging a bouquet; and on the outside a second person, a man, whose presence could well be dispensed with, for the girl with her flowers is so agreeably painted, that she alone would constitute a study of much interest. This is one of those cases which, showing valuable properties in one impersonation, is enfeebled by the want of equal quality in the other. 'A Sample of Wine' (936), R. S. ZIMMERMANN, is a small picture very successful in that kind of expression becoming to such an experiment. The subject has often been entertained by German artists, and too frequently extreme efforts to secure originality have lapsed into caricature. An admirable and earnest work (924), by A. SEITZ, is called 'Monks performing Music,' wherein everything has been done to give force and individuality to the performers, each of whom is seated at a table with his instrument. It is a picture of high merit; the heads are brilliant in finish, and the scene is not encumbered with useless accessory. The contrary, however, is exemplified in (908) 'Village Scenery,' C. MALI, wherein the components are redundant and the general arrangement too much broken up.

'The Murder of Rizzio' (925), O. SEITZ, is as full of movement as interpretations of this event usually are; but in order to enhance the horror of the scene, the artist asserts the murder to have taken place in the presence of the queen, whereas the unfortunate man was dragged into another room, where he was despatched by the daggers of the conspirators. The subject is very ungrateful to paint, and not less difficult than ungrateful. The scene here is too complicated to reconcile us to such narratives, the repugnant features of which must be compensated by the very best points of Art. In 'John Sebastian Bach's Morning Family Prayers' (921), T. E. ROSENTHAL, we have an example of colouring on a principle for which there is not much feeling in the works of the present day. Bach himself presides at the piano, while his family is variously disposed around him. The arrangement is skilful, the attitudes natural, and the purpose of the assembly literally described; but the peculiarity is the colour, which may be described generally as warm and cool greys, with a sparing central focus of red. The work has merit of a high character, but the systematic denegation of colour deprives it of the power of holding its own, even among moderately-coloured works. 'Two Moors' (915), by V. MULLER, is only a study of two heads, but really more pictorial than any similar negro production we remember. Another couple of heads, differing from these in everything, is shown in (894), 'The Return from the Entombment of our Saviour,' St. John and the mother of Jesus, wherein the faces are in what may be called deep shade, an effect appropriate and successfully made out. 'Christ and the Sick Man at the Pool of Bethesda' (927), T. LUDWIG, is another scriptural theme; but its realisation has been conceived in a vein so opposite, that a comparison suggests, more pointedly than in ordinary cases, questions as to the proper feeling wherewith to approach scenes from Scripture.

Examples of landscape, sylvan, and coast scenery are not numerous, but they speak well for the progress of Bavarian Art in a direction which has not been so specially followed as that of academic teaching. Of 'Beechwood and Sheep' (893), C. EBERT, the life is a flock of sheep driven through a pathway overhung by forest trees, painted with more deference to nature than has been usually found in like works of the

Teutonic schools. What we mean objectionably appears prominently in a 'Landscape' (888), by H. BECKMANN, the components of which are trees and water, all very firmly painted, but apparently not from nature. 'The Potato Harvest' (907), A. LIER, is a very successful, broad, grey landscape; and 'The Bay of Woerkim—Esthonia, Baltic' (928), P. TIESENHAUSEN, is a highly meritorious marine picture: of material there is little; but that little is made most effective through the genius of the painter. 'Stone-Pits, near Polling' (896), E. HELLRATH, although not an interesting subject, is powerfully rendered. Other works of various degrees of excellence are a 'Group of Peasants' (911), W. MARC; 'An Autumnal Day' (906), D. LANGKO; 'Girl from Procida' (891), F. DUERK; 'A Savoyard Girl' (899), F. H. HOHBACK, &c. The contributions of the Bavarian artists amount only to about sixty productions, most of them recently painted; these works, therefore, must not be accepted as representing the artists of Munich, who, as promoters of modern *renaissance*, take foremost rank among the schools of Europe.

EUROPE.

FROM THE GROUP OF SCULPTURE BY
P. MAC DOWELL, R.A.

THIS is the third engraving we present to our subscribers out of the four which form the subjects of the larger groups intended for the Albert Memorial in Hyde Park. The sculptor lived long enough to complete his work, but, unhappily, did not, we believe, survive to see it raised to its resting-place.

It will at once occur to the mind of those familiar with classic history, that Mac Dowell, in his design of the principal figure, has referred to the mythological story of Europa carried off by a bull; simply, however, to give somewhat of poetic colouring to modern history. Europe, an elegant impersonation, crowned, bearing a kind of sceptre in her right hand, and an orb in her left, is seated majestically on a noble animal, which, however, appears to be of a small breed. The sculptor, doubtless, had an object in this, for had the bull been of greater height, it would have too much dwarfed the surrounding figures, and obtained too great prominence.

The four nations which have played the most important parts in the annals of Europe are typified in the subordinate figures. On the right is Britannia, holding a trident, the waves of the sea rolling up to her feet. On the left is France, with a sword in one hand, and a wreath of laurels in the other; the former symbolizes her military prowess, and the latter may be accepted as denoting her successes in war. By her side, at the opposite angle, sits Italy, resting her left hand on an ancient lyre, a painter's palette and brushes lie at her feet; these attributes refer to her renown in the arts of music and painting: her head is upturned, and her right hand uplifted, as if listening to some sweet melody of song. The fourth figure, which is not seen in the engraving, represents Germany: it is accompanied by emblems significant of philosophy and the sciences.

It is thus apparent that the whole subject has been judiciously worked out, both in the entirety of the group, and in each individual portion of it: the result being a combination of matured thought and very skilful execution.



EUROPE.

(THE ALBERT MEMORIAL, HYDE PARK.)

ENGRAVED BY W. ROFFE, FROM THE GROUP IN MARBLE BY P. MAC DOWELL, R.A.



ARCTIC SCENERY.

SOME four years ago there was exhibited in the Haymarket a picture, called 'Crushed in the Ice,' by Mr. W. Bradford, an American artist. It represented a vessel ice-bound in one of the drear solitudes of the Arctic seas, and was regarded, not only as a work of great merit, but was pronounced by competent authorities as faithfully depicting, so far as it went, the scenery of the icy regions. Mr. Bradford is now at the Langham Hotel, in London, and has brought with him some of the further results of that voyage, of which it must be said, they excel in everything the picture we mention; wherein the point was, with its surroundings, the steamer that Mr. Bradford had chartered for his expedition, which, it must be allowed, is the most chivalrous ever undertaken in the cause of Art. The ship's company was, we believe, fifty hands all told, and in order to secure as much as possible of the scenery of the frozen seas, Mr. Bradford engaged the services of two photographers, the products of whose labours set before us the beauty and magnificence of Arctic scenery in a manner which, to the extent accomplished in this case, could not be effected by any other means. The theatre of Mr. Bradford's operations is Melville Bay, which may be called a bight in the far north of Baffin's Bay, and on the eastern coast of North Greenland; the time occupied altogether in the study of the phenomena of those inhospitable regions was seven years. The navigation of this part of Baffin's Bay is considered more fraught with danger than that of any other tract of the Polar seas. In the largest of Mr. Bradford's pictures the steamboat appears hopelessly wedged in the ice, and so close in-shore that the lofty cliffs tower almost perpendicularly at only a short distance from the vessel; so that the situation at once suggests the questions as to how she got there, and how she will get away. Looking seaward, the eye traverses only a vast plain of ice, even to the extreme horizon—a dismal waste devoid of every sign of life. There are appearances in this work which have not been recorded in any other transcripts we have seen of the frigid North. The pink hues assumed by the ice when lighted by the mid-night sun are tender beyond description; yet richer and far more striking than these are the colours which are put on by such portions of the ice as have been broken up; presenting their edges to the light, and the reflections from the water. These fragments assume the most intense and transparent emerald, blue, and opal tints, which, we are assured, are by no means exaggerated. These effects have never before been rendered in any pictures of Arctic scenery that have come under our notice.

Again, rolling over the cliffs there is a dense mass of cloud, resembling rather volumes of smoke than any nebular forms that ever appear in Europe. In comparison with this our storm-clouds, although ever so menacing, are grand and self-possessed; but this phenomenon is so wild and savage that, but for an assurance of its being a veritable incident of the Greenland sky, it might be assumed reasonably enough to be an imaginative attribute. In this picture we look seaward, far away over the boundless icy plain, with our backs to the sun; but another describes a midnight sunset, the glories of which are shed over the entire extent of the view, insomuch as to warm and harmonise the whole. Again, the ice repeats the beautiful greens and broken hues it borrows from the water, and the wealth of pink and orange distributed by the sun offers a combination of tints which has never before appeared in relation with any painted description of the frozen seas. Mr. Bradford has several other similar views, and is rich in photographs, all representing coast and sea scenery of the same character. In some of these, where the steamboat appears, we see her quietly resting on upheaved piles of table-ice, and in this position giving out volumes of black smoke from her funnel; which apparent anomaly is explained by the necessity of being at all times ready to embrace a chance of extrication which may at very short notice present itself by the opening

of a passage, called a "lead," into a sea free from ice. Some of the icebergs represented in the pictures and photographs are grounded in five or six hundred feet of water. It is not probable that any expedition will ever be again fitted out for such a purpose. On this occasion Mr. Bradford was assisted by Mr. Legrand Lockwood, an enthusiastic and noble-hearted American, and both are to be most earnestly congratulated on the perfect success of the enterprise.

MURAL DECORATION AT
LYTHE HALL.

LYTHE HALL, Haslemere, Surrey, the seat of J. Stewart Hodgson, Esq., is one of those Tudoresque mansions, abounding with mullioned bow-windows and stacks of ornamental chimneys, that, with more or less evidence of architectural taste, are being at the present time so extensively constructed in the country. Many of the architects employed on these buildings evince a most gratifying knowledge of, and proficiency in, their art, and among these, Mr. F. P. Cockerell, under whose superintendence Lythe Hall has been reared, occupies an honoured position. With considerable taste and discrimination on his part, and judicious liberality on that of his employer, Mr. H. S. Marks, A.R.A., has been commissioned to pictorially decorate the entrance-hall. His work has just arrived at completion, and we have been favoured with a view of it. The decoration consists of a series of scenes illustrating country life; they are to surround the hall at a height of about 9 ft. from the ground; the figures are for the most part 3 ft. high, and are painted on canvas in dead colour. One represents driving home cows after milking; another, haymakers; next we have a ploughing-scene; then a winter-subject—"Tom bears logs into the Hall, and milk comes frozen home in pail;" as a contrast and companion to this, we have a summer-scene—girls hanging out clothes to dry; in another we are shown a consultation between the farmer and his man as to the pig or pigs that shall be killed for Christmas; girls are next to be seen feeding fowls; over the wall of the farmyard in which the action is taking place we observe a number of quaintly-clipped yew-trees. An angler earnestly pursuing his occupation, and a heronry—one bird in the act of gulping a fish—are the subjects of two other minor pieces. The spandrels of an arch give Mr. Marks the opportunity of introducing perhaps the most effective bit of work, ornamentally speaking, in the place; on one side is a cuckoo perched on a blooming hawthorn, and on the other is delineated the bird of wisdom and of night, sitting on a leafless tree: in both these there is more than a suspicion of Japanese inspiration, shown in the conventional and suitable treatment of the trees, particularly the hawthorn blossom.

Independently of the correct drawing and the excellent grouping of his figures, and the knowledge of nature shown in his rural backgrounds, Mr. Marks is to be commended for the intelligent way in which he has accommodated his art to mural purposes; he is content to give relief, not by making a figure, as they say, "stand out of the canvas," but by effectively and harmoniously contrasting his colours; so far from an appearance of roundness, each figure is encircled by the same firm black line that we are so familiar with in stained-glass windows, and he has done what we must consider to be violence to his feelings in keeping his draperies, &c., conscientiously flat; but if he has denied himself the pleasure of exerting his strength as an accomplished artist, he lets us see very plainly that he means not to allow his powers of humour to be placed under a bushel.

In thus taking up decorative Art we would cordially recommend Mr. Marks's example to our rising and risen artists; some of the greatest of whom, Mr. Watts, Mr. Herbert, and a few others, be it remembered, need not the hint. What Raphael and Michel Angelo found both pride and profit in doing, surely the lesser luminaries of the present day could undertake without much derogation of dignity.

PICTURE SALES.

A COLLECTION of oil-paintings and water-colour drawings, the property of Mr. F. Wilkinson and Mr. E. Radley, was sold by Messrs. Christie, Manson, and Woods, on the 13th of May. The following examples are most worthy of note; we were, however, unable to ascertain into whose hands some of them fell.

Oil-Pictures.—"The Fox and the Grapes," A. Solomon—engraved in the *Art-Journal* for 1862—150 gs. (Addington); "The Marriage Contract," R. A. Hillingford, £92 (Bevis); "A Clergyman and Village School visiting the Tower of London," a finished sketch for the large picture exhibited at the Royal Academy in 1862; and "Annt Deborah's Pocket," both by G. B. O'Neill, 155 gs. (Lesser); "Tasso Reading to Alfonso d'Este and his Daughter," R. A. Hillingford, £93 (Bevis); "Snow-Scene," with sheep, T. S. Cooper, R.A., 100 gs.; "The Squire's Feast," G. B. O'Neill, £126; "A Calm," Sir A. W. Callcott, R.A., 180 gs. (Ellington); "Charles II. and Lady Margaret Bellenden at the Tower of Tilletudlem," C. R. Leslie, R.A., 205 gs. (Metcalf); "Venice: the Guidecca looking east," E. W. Cooke, R.A., 175 gs. (Wilkinson); "Norwood," T. Creswick, R.A., £120; "The Poison-Cup," J. D. Watson, 120 gs.; "Coblentz," W. Müller, £192; "Gillingham," W. Müller, £367; "Across the Common," J. Linnell, 875 gs. (Vokins); "Landscape," Copley Fielding, 795 gs. (Vokins); "River-Scene," with cattle, T. S. Cooper, R.A., formerly in the collection of Mr. Biggs, 340 gs. (Sir W. Armstrong); "The Tower of St. Lawrence, Rotterdam," J. Holland, £166; "The Port of Rhodes," W. Müller, 355 gs. (Agnew); "The Merry Heart," J. Phillip, R.A., 265 gs. (Sir W. Armstrong); "The Royal Mule," Mdlle. Rosa Bonheur, 355 gs. (Addington); "A January Morning," H. Wallis, £173; "A Honiton Lace-Manufactory," F. R. Pickersgill, R.A., £173.

The following were catalogued as a "different property:"—"The Pot of Basil," Holman Hunt, the small finished sketch for the large picture, 525 gs. (Ellington); "Il Dolce far Niente," Holman Hunt, 710 gs. (Willis); "The Opium-Dealer," W. Müller, formerly in the collection of Mr. Knowles, of Manchester, 610 gs. (Radley); "The Important Letter," H. Bright, the figures by J. F. Herring, £131; "The Gipsy's Rest by the Way," H. Bright, the figures by C. Baxter, £148; "The Two Friends," H. Schlesinger, 100 gs.; "A Clover Field," V. Cole, A.R.A., 130 gs.; "The Lady's Boudoir," W. Q. Orchardson, A.R.A., £89; "Early Morning in Brittany," Mdlle. Peyrol Bonheur, £99.

Water-Colour Drawings.—"The Romance of the Armoury," G. Cattermole, £61; "Cow and Sheep," T. S. Cooper, R.A., £73; "Sheep in the Snow," T. S. Cooper, R.A., £87; "Children by the Sea-shore," £97; "Haslemere," £115; "Feeding the Chicks," £78;—these three are by Birket Foster; "The Trumpet-call to Arms," J. Gilbert, £73; "The Challenge," J. Gilbert, £126; "In Brittany—the Old Story," F. Goodall, R.A., £77; "Asking a Favour," E. Nicol, A.R.A., £72.

A miscellaneous collection of pictures was sold in the same rooms on May 23rd. Among them was a fine water-colour drawing, "Sophia Western and the Squire," F. Taylor, 160 gs. (Morris). The following are oil-paintings:—"Grandmother's Birthday," Duverger, 125 gs. (Johns); "A Workman of Cairo," "Passing the Tombs," and "An Eastern Merchant," F. Goodall, R.A., 240 gs. (Willis); "Scene from *She Stoops to Conquer*," "The Farewell," and "Queen Elizabeth with Amy Robsart and the Earl of Leicester at Kenilworth," three small pictures by W. P. Frith, R.A., 335 gs. (Wilson); "Girl with a red Fez," C. Landelle, 105 gs. (Pole); "The Creole and the New Jewel," J. Portaels, 190 gs. (Williams); "Sunset at Sea," Jules Dupré, 170 gs. (Ansten); "The Rich Widow and her Suitors," D. W. Wynfield, 150 gs. (Ansten); "An Interior," a lady arranging flowers and fruit, F. Willems and D. de Noyer, 155 gs. (Ansten); "Ophelia," J. E. Millais, R.A., a small picture, 100 gs. (Williams); "Cottage and Children," with ducks, J. Linnell,

small, 190 gs. (White); 'Love's Beginning,' W. Q. Orchardson, A.R.A., 165 gs. (Ansten); 'Falstaff's Own,' H. Marks, A.R.A., engraved in the *Art-Journal* of last year, 250 gs. (Williams); 'The Return of the Wanderers,' P. F. Poole, R.A., 195 gs. (Green).

Another miscellaneous collection of pictures, including oil-paintings and water-colour drawings, was sold by Messrs. Christie, Manson, and Woods on the 27th of May. In the former class may be pointed out:—'Olivia,' from the *Twelfth Night*, W. P. Frith, R.A., £89; 'A Woman of Cairo,' F. Goodall, R.A., 100 gs.; 'On the Thames, near Chiswick: Moonlight,' J. Linnell, 100 gs.; 'Water-Carriers,' R. Beavis, £107; 'The Fly-Maker,' E. Nicol, A.R.A., £153; 'Shakespeare's Cliff,' C. Stanfield, R.A., £113; 'A Woody Landscape,' T. Creswick, R.A., £162; 'A Woody Scene,' W. Linnell, £107. The drawings included:—'Warwick Castle, from the Avon,' D. Cox, 80 gs.; 'View in South Wales,' P. De Wint, £115; 'View in Cumberland,' Copley Fielding, £135; 'Cader Idris,' Copley Fielding, £180; 'Storm and Wreck off the Needles,' Copley Fielding, £246; 'Venice,' J. Holland, 140 gs.; 'Canal-Scene, Venice,' three figures in a gondola, J. Holland, £80; 'November 11, 1 P.M.,' A. W. Hunt, £162; 'A Highland Scene,' W. L. Leitch, 120 gs.; 'Exterior of Louvain Cathedral,' S. Prout, £71; 'View near a Farm,' Birket Foster, £107. The names of the purchasers did not reach us.

On the 3rd of June Messrs. Christie & Co. sold a number of paintings, chiefly by old masters, belonging to several owners. The following were the leading examples:—'St. Catherine,' B. Luini, 80 gs.; 'Portrait of W. Pitt,' Hoppner, 160 gs.; 'Portrait of an Old Man in a Red Cap,' Rembrandt, £140; 'Portrait of Rubens,' by himself, in a black dress, dated 1619, 255 gs. (Rutley); 'A Woody Landscape,' a bridge over a stream, and a village in the distance, Ruysdael, from the Redron collection, £136; 'A Girl seated at a Table,' on which are a pen and a book, Greuze, 400 gs. (Lytleton); 'Place Navone, Rome,' during a fête in 1729, Pannini, engraved, 610 gs. (Doyle); 'Les Singes Cuisiniers,' Decamps, from the Demidoff and Redron collections, 950 gs. (Ellis); 'La Marchande d'Oranges,' Decamps, from the Redron collection, 530 gs. (Agnew); 'View on a Canal in Winter,' J. Van Ostade, £299; 'Interior of a Cottage,' G. Morland, £100. The next six works were from the gallery of the Duc du Lau:—'Portrait of a Young Lady,' with powdered hair, in yellow dress, G. Romney, £136; 'Portrait of Anne of Denmark, wife of James I.,' Pourbus, £225; 'Portrait of Thomas Killigrew,' his name painted on the collar of a dog, Van Dyck, 285 gs. (Graves); 'Landscape,' with a corn-field, a cavalier in a red dress, on a white horse, &c., Ruysdael, 100 gs.; 'Landscape,' with cows, a woman and girl seated under a tree, a herdsman standing behind a black cow, with other accessories, Cnyp, engraved in the catalogue of the Duval Gallery, Geneva, 710 gs. (Durand Ruel); 'La Limonade,' G. Terburg, engraved in the Choiseul Gallery, 435 gs. (Ellis); 'A Girl reading "Clarissa,"' Sir J. Reynolds, a portrait of the painter's niece, Miss Theophila Palmer, afterwards Mrs. Gwatkin, 750 gs. (Agnew); 'Garden Scene, with a spaniel, dead peacock, &c.,' J. B. Weenix, 100 gs.; 'A Dutch Village,' J. Van Ostade, £157; 'The Daughter of Herodias,' Carlo Dolce, £96; 'View near a Farm,' a woman milking a cow, a herdsman at her side, other cows, a horse and three sheep on the left, a pool of water in the foreground, signed and dated 1651, P. Potter, 330 gs. (Allen). This picture was bought, in 1796, by Mr. Ralph Willett, from the descendants of the Dutch family for whom it was painted. The names of some of the purchasers did not transpire.

At a sale last month of pictures, &c., in Bath, belonging to Major Wilcock, of that city, a 'View in North Wales,' with overshoot water-mill, bridge, &c., by W. Müller, realised £185; and 'View on the Wye,' by J. Tennant, £60.

MINOR TOPICS OF THE MONTH.

THE WELLINGTON MONUMENT is now to be completed in about two years and a half; and the cost will, on the whole, be moderate! So, at least, is the official statement that has been made in both Houses of Parliament. Mr. Stevens is to be allowed to continue his labours, but under the superintendence of a gentleman "properly qualified" to fill so onerous a post. This gentleman is said to be Mr. Leonard Collman. The total additional cost is computed at £9,000, raising the whole amount to £22,000. As we are promised that the work will ultimately be "worthy of the nation and of the illustrious man to whom the monument is to be raised," we trust the result will justify the pledge: the country has waited long enough for something.

THE SOCIETY OF ARTS has this year awarded the Albert Gold Medal, instituted for "distinguished merit in arts, manufactures, or commerce," to Mr. Henry Cole, C.B., of the South Kensington Museum.

UNIVERSITY COLLEGE.—The three Professorships of the Fine Arts founded by the liberality of the late Mr. Felix Slade are now completed by the appointment of Mr. E. J. Poynter, A.R.A., to that in University College. It is intended to open the classes for drawing, painting, and sculpture in October next. Six scholarships for proficiency in these branches of Art were established by Mr. Slade: each is of the annual value of £50, is tenable for three years, and is open to ladies.

THE PRIZES AT THE CRYSTAL PALACE PICTURE-GALLERY have been awarded—partially, that is to say, for Messrs. E. M. Ward, Louis Haghe, and S. C. Hall, on whom the duty of selection devolved, declined to award any to the "best historical picture" and "the best water-colour drawing." There were pictures of merit in both classes, but they did not come under the "rules" laid down for the competition; the "£40" and the "£20," therefore, stand over to the year 1872. The prize of £35 for a figure-subject in oils was awarded to Mr. J. Hayllar, for his picture (120), 'The Plagues of the Garden;' and that of £30 to Mr. E. Gill, for his picture (No. 93), 'Storm and Shipwreck.' Of the eight medals to foreign artists five only were awarded—to MM. Delbeke, Wittkamp, Pauwels, Raeymackers, and Frère, jun. Here also the adjudicators were compelled to pass over some excellent works as not coming within the rules. In their report, the adjudicators advise the Directors of the Crystal Palace Company to make additions in 1872 to the prizes—of medals more especially—and to cause the arrangement to be known *in good time*; they consider the result cannot fail to be a great improvement in the exhibition of the next year. "They desire to add a strong opinion, that the advantages offered to artists by the Crystal Palace Company are not sufficiently known and understood, and have been, therefore, too much neglected. The exhibition is visited daily by more than a thousand persons—occasionally by a very much larger number, among them being many to whom the acquisition of pictures is a need and a delight; and that, although the sales effected in the Gallery have been large, they would have been much larger had the artists properly responded to the liberality of the Crystal Palace Company in supplying to them so fruitful a source of publicity. And they feel sure that, with requisite efforts, the spacious and well-lit galleries of the Crystal

Palace may be made to rank among the best, most attractive, and most popular of the picture exhibitions of the metropolis." We can but echo these sentiments, hoping, and, indeed, believing, they will bear fruit in 1872.

THE SCOTT CENTENARY.—A committee has been formed in London, co-operating with the Edinburgh committee, to honour the memory of Sir Walter Scott, on the 9th of August: its main purpose, however, is to complete the "Edinburgh Scott Monument"—a work that, in 1871, remains unfinished! From a statement put forth it appears that—

"Thirty statues are required to fill the canopied niches around the structure, and Messrs. Brodie and Hutchinson, sculptors, R.S.A., are willing to furnish these statues—modelled and executed by themselves, and cut out of the best freestone, for £50 per figure. The figures will be selected from the leading novels and poems of Scott, which afford an ample variety of character and costume, and a most interesting illustration of national history."

If every reader who has derived enjoyment from "The Waverley Novels" and the poems of this great master were to contribute a penny towards the required fund, not thirty, but thirty thousand statues might be the result, if they were needed. It is not creditable that a difficulty exists in procuring £1,500; we trust the reproach will not be endured much longer. It is by no means a question for Scotland only; every educated Englishman owes a debt to Sir Walter Scott—not for delight merely, but for the soundest morality, the most genial teachings, the purest and holiest patriotism. If he never wrote a line that dying he would wish to blot, he certainly never penned a sentence which was calculated to do harm. All human kind are his debtors, and will be so to the end of time. It would be easy to write at length on this seductive topic; we must content ourselves, however, with a few words, to express the hope that many subscribers to this fund of gratitude and affection will communicate with the hon. sec., Colin Rae Brown, Esq., 21, Cockspur Street, Charing Cross.

AN EXHIBITION OF "ANCIENT PICTURES" is now open at the Gallery in Berners Street. They are the property of Don José de Arrieta (the brother-in-law of Admiral Topete), a distinguished Spanish gentleman, and have been collected in Spain. Of the authenticity of a large proportion of them there can be no doubt; perhaps they may be, in all cases, traced to the masters to whom they are attributed, although these masters are the great artists of the world—Murillo, Tintoretto, Caravaggio, Velasquez, Andrea del Sarto, Zurbaran, D. Teniers, Poussin, Leonardo da Vinci, Titian, Guido, Sebastian del Piombo, and others. Some of them bear undoubted evidence of originality, and are very fine as well as very beautiful: an 'Assumption,' by Murillo, is especially so; a more exquisitely-perfect example of the great painter it would be difficult to find in any gallery, public or private. We have always much hesitation in expressing opinions concerning "ancient pictures," or in accepting the *dictum* of any authority on the subject, unsupported by testimony. But our readers who are interested in this matter may see the collection, and judge for themselves.

A DISTINGUISHED AND VERY ABLE ARTIST, S. ROSENTHAL, has painted a picture to commemorate the inauguration of Freemasons' Hall. Brother His Royal Highness the Prince of Wales, the grand master, the Earl of Zetland, the Earl de Grey and

Ripon, and many other of the brotherhood, "free and accepted masons," figure in the group. It contains nearly a hundred portraits; we can depose to the accuracy of likeness in several of lesser note, while the leading personages will be recognised at once. The arrangement is excellent; each is fully seen, while there is no overcrowding or confusion. The painter has necessarily introduced so many persons, that perhaps grace of composition is sacrificed; but as an assemblage of portraits it has been rarely surpassed; while, as a work of Art, it has high merit as well as interest; indeed, it may be justly ranked among the very best productions of its class. We presume it will be engraved, and probably some wealthy brother will present the picture to one of the Freemasons' Charities.

SOCIETY OF WATER-COLOUR PAINTERS.—Mr. John Gilbert has been elected president of this institution in the place of Mr. F. Tayler, who has resigned after many years of active service.

"THE BREAKING UP OF THE 'AGAMEMNON,'" an etching by Mr. S. Haden, has recently been published by Messrs. Colnaghi and Co. It is a remarkably free and vigorous example of the art, with a fine effect of sunlight on the water, but it seems to lack the delicacy manifest in preceding works of this accomplished etcher, and the lights and shadows are too strongly, almost painfully, contrasted. We cannot understand why the old ship is so weak in colour, with the setting sun nearly behind her; the light reflected from the water would scarcely account for it. In the distance we see Greenwich Hospital and the *Dreadnought*, the latter moored considerably below the former, and not above, as we always remember her when passing up and down the river. The plate is unusually large for an etching, and is unquestionably a work of great merit—one that has rarely been surpassed by a British artist.

A STATUE OF THE LATE ROBERT STEPHENSON, C.E., is about to be erected by the London and North-Western Railway near the entrance-gates of the road leading to the Euston Square terminus.

MR. THORNYCROFT'S 'BOADICEA.'—This really grand composition is now perfect, as to the design, and has been cast in plaster. The conception was first entertained by Mr. Thornycroft twenty years ago, but it was never advanced, until recently, beyond the principal group. Now Boadicea appears in a war-chariot, with her daughters, one on each side, and drawn by two fiery horses. Her attitude is extremely imposing; she is with the most energetic and vehement action addressing her people, and calling for vengeance for the wrongs they have suffered at the hands of the Romans. She stands with her arm raised above her head; and from her entire action and expression we seem to listen to the most passionate and heart-stirring language, and gather from her manner the conviction that she is addressing a multitude. The car resembles a *biga*, having a fixed pole, but solid wheels. The horses are modelled with much learning, and a mastery of the character of the animal, which could only be acquired by lengthened observation of its action, realised by great experience. They are attached to the pole by the simplest possible device, and there are no reins, for the Britons guided their horses by the voice. The incident takes place in sight of the Roman army, as is indicated by an expression of alarm on the part of one of the daughters. The composition has been studied so successfully as to appear to

advantage from every point of view. It has been taken up by the Board of Works, and is destined for Kensington Gardens, where it is hoped it will be favourably seen, as it is the grandest purely historical sculptural work of our time.

MR. PRITCHETT'S "INK-POTS."—There was exhibited some time since, at the gallery of Messrs. Agnew, in Regent Street, a set of ink-sketches, to which, from their novelty and merit, we gave a notice of some length. These are now reproduced by the Autotype Company, 36, Rathbone Place. There they are to be seen as most successful examples of this, the only real means of representing in repetition the touch, feeling, and other characteristics of the artist. All the subjects, it may be remembered, are in Holland; many from the famous Schevevingen and its sandy shore. The eccentric title under which the series is brought forward is a translation from the Dutch, in which language the word means a drawing made in ordinary ink. We know old, very old Schevevingen, as it has been painted by Ruysdael, Teniers, and others, who have represented it as a fashionable seventeenth-century watering-place; but all the Dutch and Flemish painters have missed the grand point of showing us the natives as they are. The dangers of the shallow, and extremely flat, foreshore offer occasion for many touching episodes, which are too familiar to make deep impression on the feelings of native observers. It is not too much to say that Mr. Pritchett shows us this coast and its inhabitants with a greater apprehension of picturesque truth than any of the native artists who have painted the place and its people. The spirit, freedom, and decision of touch shown in these works could never, we think, have been imitated by any manual elaboration. The autotype repetition, to say nothing of its general truth, is most curious in its conscientious record of point for point and tone for tone. The work comes forward under the patronage of the Queen of the Netherlands.

THE GRAVE OF CHARLES LAMB.—The editor of the *Hackney Gazette* has addressed to us a letter (which was inserted in the *Athenaeum*) with information that the grave of the genial essayist and sweet poet, in Edmonton Churchyard, is in a deplorable condition. "The mound is half trodden down, broken and unkempt, and overgrown with nettles and rank gorse-grass. Friendship's hallowed words, too," he adds, "will, in a year or two, unless the letters are recut, have passed away. The cost to restore it, I learn, will not exceed £3." We may add to this that the condition of the grave must be spoken of in the past tense: it *was* in a deplorable state. It is not so now. There are tens of thousands who would have done what it has been the privilege of one to do.

THE REYNOLDS COLLECTION.—Mr. C. W. Reynolds's well-known collection of pottery and porcelain was dispersed at Christie's in a four days' sale, beginning on the 29th of May. It was remarkable as comprising specimens of almost every known manufacture, with an extensive series of marks. Mr. Reynolds had given his special attention to *faïence*, and possessed fine examples of many of the rarer fabrics. Of the Spanish *faïence* of Alcora there were above twenty *plaques*; one, with an equestrian figure, sold for £40; and a pair, of which Galatea, after Caracci, formed one of the subjects, sold for £36. Of the Antonibon fabric at Nove, near Bassano, there was sold a splendid specimen, the *chef-d'œuvre* of the manufacture, a vase with deep blue ground—subject, 'Alexander and

the Family of Darius:' this fetched £195; and another vase, £130. Of the Nove porcelain, two fan-shaped *jardinières* sold for £78 and £80, and a vase for £60. The prices attained by the Moustiers ware were low in proportion to the excellence of the specimens. A rose-water dish and ewer, with mythological subjects, sold only for £15; a dish, after the style of Bérain, for £35; another for £38; and a third, after Tempesta, for £16. The fine pair of blue Rouen dishes sold for £42; and the coloured dish, "à corne," for £10. There was a curious large punch-bowl, in the form of a bishop's mitre, made at Kiel, Denmark; this sold for 23 guineas. A spirited Doecia group, 'The Rape of the Sabines,' after John of Bologna, sold for £50; and another, 'Hercules and the Nemean Lion,' for 28 gs. A *déjeuner* set of the rare Caen porcelain, animals in red on a yellow ground, fetched £40; cups and saucers of the equally rare Etiolles, 10 gs. the pair; and 20 gs. were given for a cup and saucer of Buen Retiro. A white barrel, surmounted by figures of children, of the same fabric, sold for 28 gs. The unique collection of the old Fulham stoneware, acquired by Mr. Reynolds from the Dwight family, excited great competition. A life-sized bust of James II. sold for 38 gs.; and a dish, 2 feet in diameter, with the arms and cipher of James II. on a blue ground, rivalling in brilliancy the Nevers *faïence*, sold for 13 gs. The touching half-length figure of the child Lydia Dwight, modelled by the father after death, her head reclining on a pillow, and her hand holding a nosegay of flowers, was bought for £150: it bore the date 1672, and was purchased for the South Kensington Museum. The English porcelain maintained its usual high price. A pair of white Bow shell salt-cellars, with crayfish in relief, sold for £40; and a Bow milk-pot, with the goat and the bee, for 37 gs. Four Chelsea figures of the Senses sold for £147; and a fluted vase for £73; a Bristol *cauelle* for £78; and a Plymouth cup and saucer for £17. A white bust of George II., in the same ware, £25; an hexagonal vase, with flowers in relief, of Worcester, sold for £50; and a beautiful tea-service, with fan-shaped decoration, in the Japan style, for 47 gs. It must ever be a subject of regret that this important collection was not secured for South Kensington, to whom it was offered, we understand, on most favourable terms; but viewing, as they too often do, every purchase in reference solely to its artistic beauty, the authorities have, in the present instance, lost the golden opportunity, not likely again to offer, of acquiring a collection invaluable for study and instruction.

MR. BACON'S colossal equestrian statue of the Prince Consort is advanced through the first stage, that is, the completion of the model. The prince appears in the uniform of a field-marshal, and is lifting his plumed hat from his head, as if in the act of saluting. In the finish of both the figure and the horse great care has been exerted to secure resemblance on the one hand, and accuracy on the other. The site destined for the reception of the work is the Holborn Viaduct; and it is expected that the authorities of the City will contribute a pedestal. The statue is the gift of a gentleman whose name does not transpire. It has been proposed that it shall be gilded, and Mr. Bacon, with this view, has prepared a small gilt model, mounted on a pedestal composed of red and grey granite, with an emblematical figure, also gilt, at each of the angles. It is not, however, certain that this model has been accepted.

REVIEWS.

LECTURES ON ARCHITECTURE. Delivered at the Royal Academy, on March 2nd and March 16th, 1871. By EDWARD M. BARRY, R.A. Published by MACMILLAN & CO.

THE absence, through illness, of Mr. G. Gilbert Scott from the lecture-room, as Professor of Architecture at the Royal Academy, compelled the Council last season to seek other aid. Among the gentlemen who supplied the place of the absentee was Mr. E. M. Barry; he delivered two lectures, which lie before us in a printed form. Called upon without time or opportunity for special preparation, in addition to other circumstances unfavourable to a mere *locum tenens*, Mr. Barry felt he could do little more than direct the attention of his auditors to a few general principles affecting architecture in England, and also to some of those essential qualities in architecture which appear to merit special consideration.

In discussing the former of these divisions, which formed the subject of the first lecture, attention is directed to generalities; such as, the position occupied by architecture in the present day in comparison with that of earlier ages, the means now adopted for extending the knowledge of it, and of its importance both from an æsthetic and social point of view. "The architect must go hand in hand with the sculptor and the painter. In this country, for various reasons, the latter have scarcely ever a fair chance, and the architect has had too often to lament over consequent incompleteness in the realisation of his conceptions. To diffuse nobler and juster ideas on this subject would be a work worthy of the Academy."

In the second lecture the essential principles of true architecture are considered briefly under the heads of *Permanency, Convenience, and Beauty*; and here Mr. Barry dilates at some length on the extensive introduction of iron as a principal material in modern building: admitting its utility for certain specialities, it appertains far more to the purposes of the engineer than of the architect, even when applied to such structures as Westminster Bridge and other similar works. In the present day "the engineer has somewhat encroached on the architect, and this has been very much due to the course taken by the latter. He has been too often looking backwards while the others were looking forwards. He has been dreaming of an impossible recurrence to bygone modes of thought, while the engineer has pressed boldly onwards to conquer the future. The consequence has been, that the progress of our day has found an illustrator in the engineer, rather than in the architect."

This is a truth not to be gainsayed; and, therefore, it is essential for the architect to keep pace with the science of the engineer, and to do his best to combine his art with it. "When we contemplate some of the appalling structures of modern engineering, we may, indeed, ask ourselves in dismay—Is the world to grow uglier as it grows older? The only way to prevent this misfortune is for Art and Science to go hand in hand, for the architecture of the future must perform be scientific."

These lectures—they are published as a pamphlet—deserve a larger audience than any they could possibly have had within the walls of the Academy: they are addressed as much to the man of taste as to the professional student.

RECUEIL DE FAÏENCES ITALIENNES DES XV^e., XVII^e., ET XVII^e. SIECLES, DESSINÉ PAR MM. CARLE DELANGE ET C. BORNE-MAN, ET ACCOMPAGNÉ D'UN TEXTE PAR M. A. DARCEL ET M. HENRI DELANGE, EDITEUR. PARIS, QUAI VOLTAIRE, No. 5, 1869, in folio.

M. Delange has done good service to Art by his splendid publications illustrative of the artistic *faïence* of the Middle Ages and the Renaissance. His two works upon French *faïence*, that of Bernard Palissy and the so-called Henri Deux, have been long before the public. To these, his third, upon Italian *faïence*, just completed, is but a necessary complement, for these productions all belong alike to that epoch when

Art was allied to industry, and the Italian *faïence* of the fifteenth and sixteenth centuries was the reflex of the art of painting, which it followed in its progress, perfection, and decline.

The work of M. Delange comprises one hundred beautifully-coloured plates taken from specimens in public or private collections, selected either from their marks or their style as characteristic of the manufactures to which they belong. The text is the joint production of M. Alfred Darcel, author of the admirable catalogue of the Italian *faïence* in the Louvre, a model of its kind, and of M. Henri Delange, the translator and annotator of Passeri. In his preliminary sketch M. Darcel expresses his disappointment that so little has been added to the knowledge of Italian *faïence* since the publication of his catalogue; for had Italian *literati* exhibited more industry in the examination of their municipal and ecclesiastical archives, they would probably have brought forward as much new light upon the history of the ceramic Art in Italy as has been lately effected upon that in France.

Discarding the wide application of the word "majolica," as at present used, to Italian *faïence* in general, the authors restrict the term to those pieces only which are heightened with metallic lustre, giving to all others the generic designation of "*faïence*." For this they have the authority of Piccolpasso, who in his treatise on the Potter's Art, written in 1548, distinctly explains the difference.

The illustrations begin with a few specimens of Persian, Hispano, and Siculo-Moresque pottery, as the lusted decoration is evidently derived from the East, brought into Spain by the Moors, and thence probably introduced into Sicily by the Aragonese princes.

The authors assign nearly one-fourth of their illustrations to the productions of Caffagiolo, a manufacture which, though neither mentioned by Passeri or Piccolpasso, lasted more than a century, and must have contributed largely to the development of the ceramic Art. It was the first to depict the human figure, and to produce works of artistic value. The style of decoration called "*porcellana*" was peculiar to this fabric, and its pieces constantly bear the badges and arms of the Medici princes, its patrons and neighbours. Deruta, which, like Caffagiolo, is best known by its productions, has ten illustrations, mostly of those subjects in relief, generally in blue, heightened with metallic lustre, which form the *spécialité* of the fabric. But, to show that Deruta did not confine herself to lusted pieces, we have a splendid plate of grotesques (*candelieri*) in blue *camaiéu*. The taste for grotesques was at its height at the beginning of the sixteenth century, and subjects from the designs of Nicola da Modena occupied the broad rim, and sometimes the whole, of a plate, to the exclusion of all other decoration.

The name of "Ravene," hitherto unknown in the ceramic world, appears on an artistic plate, the figure of Amphion, in blue *camaiéu*, surrounded by a kind of "*porcellana*" border. The productions of Faenza and Gubbio, M. Delange places as the highest artistic period. Faenza, with its *bianco, sopra bianco, and berettino*, or blue enamel; Gubbio and its metallic lustres, with which Maestro Giorgio transformed into majolica the works of Urbino and Castel Durante. Many writers now wish to degrade Giorgio to the rank of a mere ornamentist; but because he decorated the productions of others, it does not follow he was not a ceramic painter himself. All those pieces in which his name does not appear conjointly with that of another artist, M. Delange is disposed to restore to him, as his own design. Some of his finest works are here given; among others—The Three Graces, 'Judgment of Paris,' and 'Bath of Diana.'

Next follow "*storiati*" plates of Castel Durante, Forli, Rimini, Pesaro, and Venice, the series being completed with twenty examples of Urbino, whose productions threw such lustre upon ceramic Art, and began when other fabrics were on the decline. Among these are several of the works of Orazio Fontana and many well-known specimens of the graceful arabesques on white ground, after Giovanni da Udine, for which Urbino was so celebrated. An excellent map, giving the sites of the prin-

cipal manufactures of *faïence* in the valleys of the Apennines and other Italian localities, is a valuable addition to this interesting and splendid work, which is indispensable to the library of every lover and student of Art.

AN HISTORICAL VIEW OF LITERATURE AND ART IN GREAT BRITAIN FROM THE ACCESSION OF THE HOUSE OF HANOVER TO THE REIGN OF QUEEN VICTORIA. By J. MURRAY GRAHAM, M.A. Published by LONGMANS, GREEN, & CO.

As a simple digest—for it professes to be nothing beyond this—of the large subject which Mr. Graham undertook to carry out, his book deserves attention. So much has already been written about the literature and Art of England during the last century and a half that little more remains to be said of each, and of this little, one scarcely expects to find any new light thrown upon either subject. But by adopting a divisional method, and by arranging his materials under a well-defined classification, each branch of literary composition, with the names of the writers who most prominently sustained it, is placed succinctly before the reader; yet not so compressed as to leave him, especially with the aid of a few extracts from the works of each author, without a tolerably comprehensive idea of the literary men of the period. Yet Mr. Graham has confined his history within rather narrow limits; the sciences, philosophy, politics, theology, and numerous other subjects are excluded from it; in short, with the exception of poetry and the drama, all that rank as the highest branches of literature remain untouched. To this extent his book must be considered defective.

The arts are treated in a similarly classified manner, under the respective heads of Architecture, Painting, and Sculpture. Here we find short running comments on the chief works of the principal men who have figured in each department—comments of which our own journal, the pages of our contemporaries, and of biographical writers, have furnished the sources, and are duly acknowledged.

The author's survey of the productions of Art and literature is characterised by discrimination and a catholic spirit in judgment. As a book of reference, or to occupy an hour or two in pleasant reading, its contents, so far as they go, are to be commended.

GEMS: NOTES AND EXTRACTS. By AUGUSTO CASTELLANI. Translated from the Italian by MRS. JOHN BROGDEN. Published by BELL AND DALDY.

Doubtless some of our readers will remember seeing in the *Art-Journal* of about three years ago an interesting and valuable paper on ancient jewellery, by the author of the book now before us, who is son of Signor Castellani, the famous jeweller and goldsmith of Rome, and who, we believe, carries on the same Art-manufacture in Florence. Both to mineralogists, and as an object of trade and commerce, a knowledge of gems—their quality, character, and relative value—is of importance; and this volume supplies just the information which the student would naturally require. The author does "not pretend to teach anything new, or to make wonderful discoveries, but only to offer a volume on precious stones in which are collected the best observations hitherto made in works on similar subjects," added to the experience and knowledge he has himself acquired in the study of this science. No fewer than one hundred varieties of precious stones are here brought into notice, their component parts analysed, their peculiar properties pointed out, and the chief places mentioned where they may be found. Remarkable specimens are also spoken of, with some interesting anecdotes respecting them and their possessors.

The original text has been carefully and very intelligibly translated into English by Mrs. John Brogden, the wife of the eminent goldsmith and jeweller of London. It is right to add that the profits arising out of the sale of the book are to be handed over to the Goldsmiths' Benevolent Institution.

THE ART-JOURNAL.



LONDON: AUGUST 1, 1871.

THE STATELY HOMES OF ENGLAND.

(OCCASIONALLY OPEN TO THE PUBLIC.)

"The stately homes of England,
How beautiful they stand!
Amidst their tall ancestral trees,
O'er all the pleasant land."

MRS. HEMANS.

By S. C. HALL, F.S.A.

THE ANTIQUARIAN NOTES AND DETAILS
BY LLEWELLYNN JEWITT, F.S.A.

HATFIELD HOUSE.



HATFIELD is entitled to high rank among the Stately Homes of England, whether we consider its architectural merits, its historical associations, or the picturesque attractions by which it is surrounded. Seven centuries have passed since Hatfield became a place of note; and the crown, the mitre, and the coronet have successively held sway over its destinies. Of its architectural glories, little now remains of a date anterior to that of James I., in whose reign the present noble house was built. A part, however, of the previous palace of Hatfield still exists, interesting as the home of the Princess Elizabeth, during the reign of her sister, Queen

Mary. Nor was her residence here, though compulsory, a state of imprisonment and oppression, as some have said; for it is proved, from various records, that she met with considerate treatment, and lived in a state befitting her lofty rank and queenly prospects, till, on the death of Mary, she proceeded hence to take possession of the throne of England.

Hatfield House lies some twenty miles from London, in the county of Hertford, and is the seat of the most noble the Marquis of Salisbury—the representative of the grand old line of the Cecils. The history of the mansion is one of considerable interest, dating, as its name *Hatfelle* indicates, from Saxon times, and undergoing many changes under its royal and noble and ecclesiastical owners. It belonged to the Saxon kings until, in the reign of Edgar, it was given by that monarch to the monastery of St. Etheldreda at Ely, which was founded in 673, destroyed in

870, and refounded in 970, and erected into a bishopric, in 1108, in the reign of Henry I. Thus Hatfield being attached to the new bishopric, and the manor becoming one of the many residences of the prelates, acquired, it is said, its appellation of "Bishop's Hatfield." Hatfield continued to be one of the palaces of the Bishops of Ely, and was occasionally used as

a royal residence, until the reign of Henry VIII., when it was made over to the crown. "William de Hatfield, second son of Edward the Third, was born at the palace," and at various times before it finally became vested in the crown, it was used and frequented by royalty. During the latter part of the reign of Henry VIII. the young prince Edward, afterwards

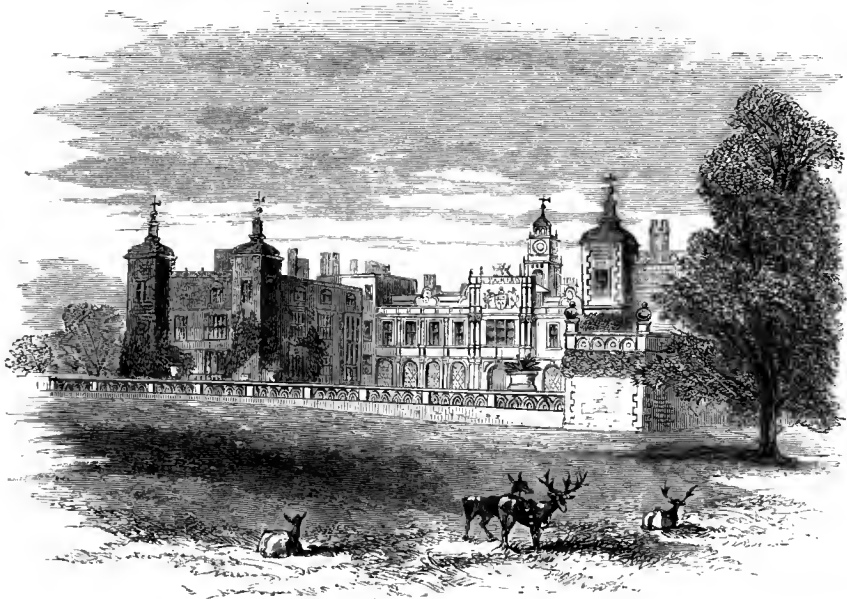

THE FRONT VIEW.

Edward VI., resided at this place, and is variously stated to have been here and at Hertford when the news of the death of his father was conveyed to him, and when, consequently, his accession to the crown took place. In the fourth year of his reign the youthful monarch conveyed Hatfield to his sister, the Princess Elizabeth, afterwards Queen Elizabeth, and here she

frequently resided. Indeed, the greater part of the troublous reign of Mary, the Princess passed at Hatfield, "with few privations and no personal hardships to endure," but with much mental torture; for it must not be forgotten that she had been removed from Ashridge to London and imprisoned in the Tower, for her supposed participation in Wyatt's rebellion, and was then, under



THE EAST VIEW.

surveillance, permitted to retire to Hatfield. It was at Hatfield that Elizabeth, it is said, while seated under an oak tree, received the welcome intelligence of the death of her sister, "the bloody Queen" Mary, and on hearing the news she fell upon her knees, exclaiming in Latin, *A Domino factum est istud, et est mirabile oculis nostris.* ("It is the Lord's doing, and it is marvellous in

our eyes"). Words which she adopted as a motto for her gold coinage, while on her silver issue she chose the somewhat similar one *Posui Deum adiutorem meum* ("I have chosen God for my helper"). Thus Hatfield became identified with the coinage of the realm as well as with many of its rulers. The day following this event Elizabeth was waited

upon at Hatfield by several noblemen of the late queen's Council, whom she received very kindly, "but presently showed her decided preference for Sir William Cecil (afterwards Lord Burleigh)—the astute, the most politic Cecil—whom she instantly appointed principal Secretary of State." On the 23rd of November the queen removed from Hatfield with an escort of more than a thousand persons, and made her progress by slow degrees to Somerset House.

In 1587 Elizabeth had, it is recorded, been visited at Hatfield by Mary, whom she received with much state, and with great festivity, playing herself upon the virginals, to accompany a child who sang. It was at Hatfield, too, it is said, that Elizabeth received the proposals of marriage from the King of Sweden for his son Eric, which she turned to such profitable account with her sister by declaring that she would never listen to any overtures of this nature which had not previously received her Majesty's sanction.

It does not appear that after her accession to the throne Queen Elizabeth ever resided at Hatfield; although she had previously been much attached to the place, and had kept up Christmas revels and Shrovetide and other festivities in a liberal manner. At one of these, Sir Thomas Pope, her guardian, made "for the Ladie Elizabeth, alle at his own costes, a greate and rich maskinge, in the great hall at Hatfielde, where the pageauntes were marvelously furnished with "banket of sweete dishes," "a snttletie in thirty spyce," and wonderful garnishings, but for which "folliries," Sir Thomas got "snubbed" by his queen, who ordered these mummeries to cease.

James I., in the third year of his reign, exchanged Hatfield for the house, manor, and park of Theobalds, with his minister, Sir Robert Cecil, afterwards created Earl of Salisbury, whose descendant, the Marquis of Salisbury, is the present owner, the estates passing in regular succession from that time to the present day, and continuing to be the principal residence of that noble family, about whom we now give some details.

The family of Cecil is one of considerable antiquity, and many of its members have distinguished themselves both in statesmanship, in the field, and in the arena of literature. The greatness of the family was laid by Sir William Cecil, the friend and adviser of Queen Elizabeth before her accession to the throne, and her first chief Secretary of State. "This distinguished statesman," says Sir Robert Naunton, "was the son of a younger brother of the Cecills of Hertfordshire, a family of my own knowledge, though now private, yet of no mean antiquity, who, being exposed and sent to the city, as poor gentlemen used to do their sons, became to be a rich man on London Bridge, and purchased (estates) in Lincolnshire where this man was born." First he became Secretary to the Protector Somerset, and afterwards, on the accession of Elizabeth, he was appointed Secretary of State. In 1561 he was made President of the Court of Wards. His great talent and assiduity won for him much regard at court, where he was treated with great favour. In 1571 he was created Lord Burleigh, and continued to maintain his distinguished position in the state till his death. He resided chiefly at Theobalds, where he often had the honour of entertaining his sovereign, who was "sene in as great royalty, and served as bountifully and magnificently, as at anie other tyme or place, all at his lordship's chardg," &c. The events in the life of this statesman are so closely associated with the history of England itself in the stirring times in which he lived, that they are too well-known to need more than a passing notice. After being mixed up in every affair of state from some time before the accession of Elizabeth, having taken part in all the proceedings connected with the unfortunate Mary Queen of Scots, and with his own hand drawn up her death-warrant, and after having for forty years mainly directed the councils of the "Virgin Queen," Sir William Cecil, now Lord Burleigh, died on the 4th of August, 1598, in the seventy-eighth year of his age, to the great grief of Elizabeth, who is said to have wept bitter tears at his death.

The eldest son of Lord Treasurer Burleigh

succeeded him in his title, which has since been augmented by the Earldom and Marquisate of Exeter; while his youngest son, Sir Robert Cecil, inherited much of his father's talent and wisdom, "with a more subtle policy and a superior capacity for state intrigue." For certain secret services to James, during the life of Elizabeth, he was raised by the king to the

peerage. In 1604 he was created Viscount Cranborne, and, in the year following, he was made Earl of Salisbury. After filling the office of sole Secretary of State, he succeeded, on the death of the Earl of Dorset, to the high post of Lord Treasurer. "Shrewd, subtle, and penetrating," he discharged his duties with great ability, and while attending to the interests of



THE GARDEN.

his country forgot not his own, having, "by various methods," increased his inheritance to a very ample extent. After taking a prominent part in the affairs of state during Elizabeth's reign, he was the one who, on her death-bed, succeeded in inducing her to name her successor. Cecil, who was then her Secretary, approached her bed with the lord-keeper and the

lord-admiral, and begged the dying Queen to name her successor, when she started and said, "I told you my seat had been the seat of kings; I will have no rascal to succeed me!" when Cecil boldly asked her what she meant by "no rascal?" to which she replied, a king should succeed her, and who could that be but her cousin of Scotland? and she begged to be no

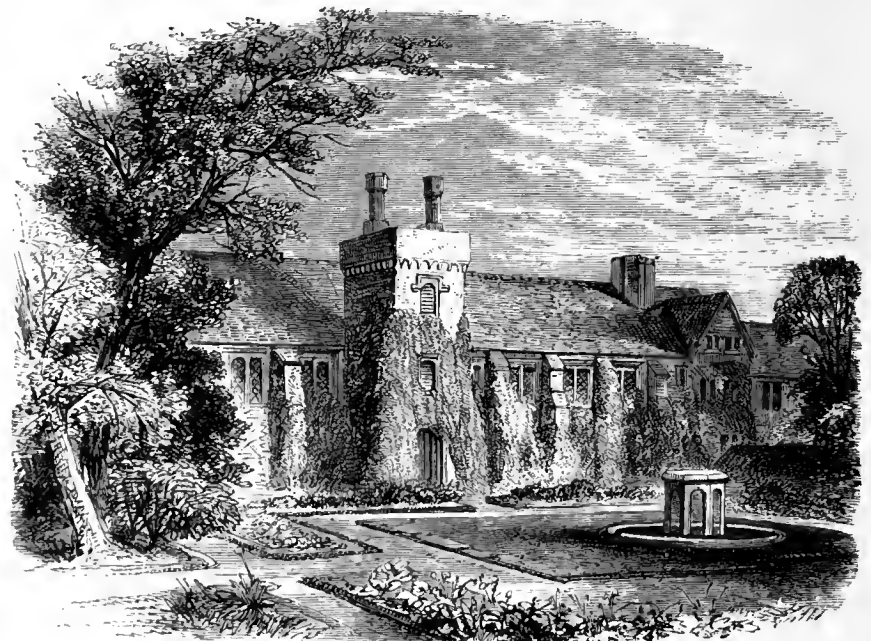

THE OLD PALACE.

more troubled. Nevertheless, some hours later Cecil again "besought her, if she would have the King of Scots to succeed her, she would show a sign unto them, whereat, suddenly heaving herself up in her bed, she held both her hands joined together over her head in manner of a crown. Then she sank down, fell into a dose, and at three o'clock in the morning

died in a stupor." Five hours after her death, Cecil proclaimed James of Scotland, King of England, Scotland, France, and Ireland, Defender of the faith, &c., and thus at once secured the country against conflicting claimants to the crown. Soon afterwards he received the new monarch at Theobalds, who a few days later rewarded him by important offices and by

creating him Baron Cecil and afterwards Viscount Cranborne, and Earl of Salisbury. From the moment of James's accession, through all the troublous times of the gunpowder plot, and all the matters relating to Lady Arabella Stuart, to Sir Walter Raleigh, and others, down to 1612, Cecil's was one of the most prominent names in the kingdom. In that year "he died, worn out and wretched, at Marlborough, on his way back to court." In his last moments he said, "Ease and pleasure quake to hear of death; but my life, full of cares and miseries, desireth to be dissolved." It was this nobleman who exchanged his mansion of Theobalds, with the king, for Hatfield. On his death, his title and estates descended to his only son, William Cecil, who became second Earl of Salisbury; and, dying in 1668, was succeeded by James Cecil, as third Earl of Salisbury. The fourth Earl of Salisbury, also named James, died in 1694, and his great grandson, James Cecil the seventh Earl, was created Marquis of Salisbury by George III., in 1789. This nobleman had succeeded his father in 1780. He married the lady Mary Amelia Hill, second daughter of the Marquis of Downshire, by whom he had issue, a son who succeeded him, and two daughters. He died in 1823, and was succeeded, as second Marquis of Salisbury, by his only son, James Brownlow Williams Cecil, Viscount Cranborne, who was born in 1791. His lordship married, first, in 1821, Frances Mary Gascoigne, daughter and heiress of Bamber Gascoigne, Esq., and assumed the surname of Gascoigne-Cecil. By this marriage he had issue three sons, James Emilius William Evelyn Gascoigne-Cecil (who died during the lifetime of his father) Robert Arthur Talbot Gascoigne-Cecil, the present Marquis, and Eustace Brownlow, William Gascoigne-Cecil, M.P.; and two daughters, the Lady Mildred Arabella Charlotte Henrietta, married to A. J. B. Beresford-Hope, M.P., and the Lady Blanche Mary Harriet, married to the late J. M. Balfour, Esq. The marquis married secondly, in 1847, the Lady Mary Catherine Sackville-West, daughter of Earl Delawar, by whom he had issue three sons and two daughters, Lords Sackville Arthur, Arthur, and Lionel; and Ladies Mary Isabella, and Margaret Elizabeth. His lordship died in 1868, and his widow, the Marchioness of Salisbury, was re-married, in 1870, to the present Earl of Derby. He was succeeded by his son, the present peer.

Robert Arthur Talbot Gascoigne-Cecil, third Marquis and sixth Earl of Salisbury, Viscount Cranborne, and Baron Cecil, Chancellor of the University of Oxford, was born in 1830, was educated at Eton and at Christ Church, Oxford (B.A., 1850, M.A. and Fellow of All Soul's College, 1853), and in 1853 was returned to parliament as M.P. for Stamford, for which place he sat until, in 1868, he succeeded to the title. In 1866-7 he held the office of Secretary of State for India, and still holds many important local appointments. In 1857 his lordship married Georgina, daughter of Sir Edward Hall Alderson, Baron of the Court of Exchequer, by whom he has issue living four sons, viz., James Edward Hubert, Viscount Cranborne, born 1861, Rupert William Earnest, born 1863, Algernon Edward Robert, born 1864, and another born 1869; and two daughters, Beatrix, born in 1858, and Gwendolen, born in 1860. His lordship is patron of eight livings in Hertfordshire, Dorsetshire, and Essex. The arms of the Marquis of Salisbury are quarterly, first and fourth **CECIL**, viz., barry of ten, *argent* and *azure*, over all six escutcheons, three two and one, *sable*, each charged with a lion rampant, *argent*, a crescent, *gules*, for difference; second and third **GASCOIGNE**, viz., *argent*, on a pale, *sable*, a conger's head, erased and erect, *or*, charged with an ermine spot. Crests, first, on a wreath six arrows in saltire, *or*, barbed and feathered, *argent*, banded, *gules*, buckled and garnished, *or*, surmounted by a morion or steel cap, proper (Cecil); second, on a wreath a conger's head erased and erect, *or*, charged with an ermine spot (Gascoigne). Supporters two lions, ermine.

Hatfield House is of vast extent; it is of brick, with stone dressings. It was built between the years 1605 and 1611 by Robert

Cecil, first Earl of Salisbury. After being suffered to fall into decay, it was restored and beautified by the sixth earl, about the middle of the last century.* In 1835, a great part of the west wing was destroyed by fire (in which the Dowager Marchioness of Salisbury perished), little being left of that part of the house besides the outer walls. On this disaster occurring,

occasion was taken to effect a general reparation of the entire building. The house is built in the form of a half H, comprising a centre and two wings, the hollow part being turned towards the south. The centre is a magnificent example of the Palladian style, and, although of mixed architecture, presents, in its totality, a design of great richness and beauty.

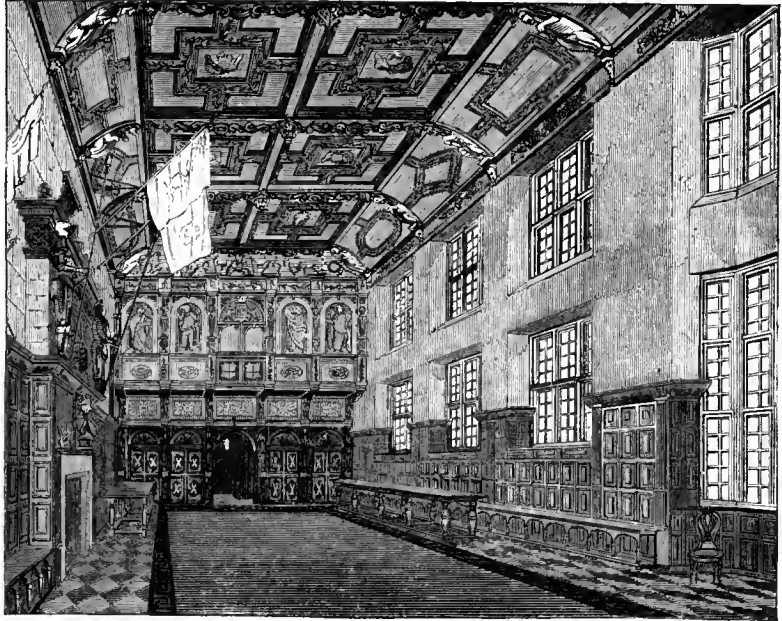

THE HALL.

The basement-story contains an arcade with eight arches, divided externally by pilasters, whereof the upper parts are fluted, and the lower parts enriched with Elizabethan arabesques. The lower pilasters are Doric, the upper Ionic. The wings are massive, and comparatively plain, supported at each corner by square turrets, 70 feet high to the gilded

vanes: the space between, comprising three stories, is relieved by a fine oriel window of two stories. The centre tower, over the grand entrance, is also 70 feet high; it has three stories with coupled columns at the corners, the whole having an agreeable pyramidal effect. The third story of the tower contains a clock, and also the armorial bearings of the founder,

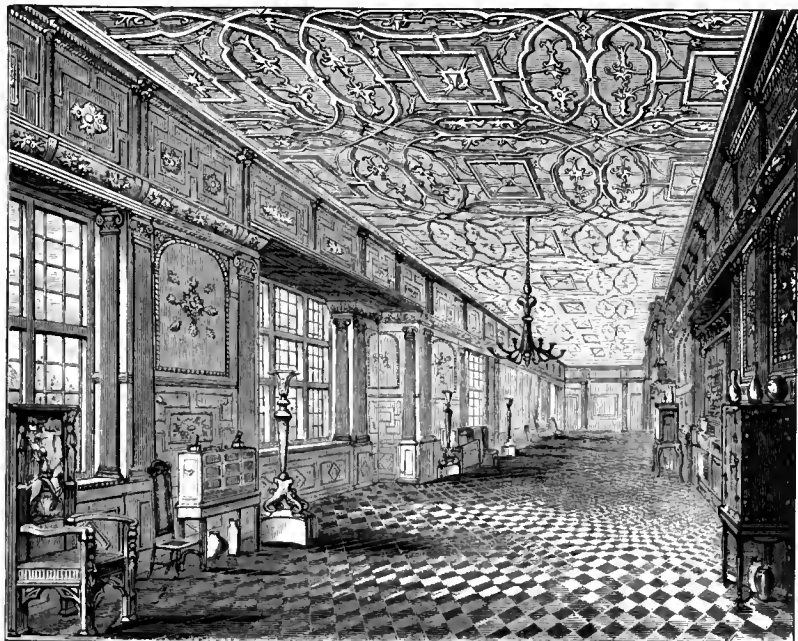

THE GALLERY.

with the date 1611, in which year the present house was finished. The length of the southern

front is 300 feet, the centre being 140 feet, and each wing 80 feet wide, with a projection from the centre of 100 feet.

* The old palace is now the stables; its roof of arches, supported by corbels, is intact, and singularly beautiful. Immediately underneath one of the windows is a stone, with the inscription, "The last charger of Arthur Duke of Wellington (descended from his Waterloo charger, Copenhagen) was presented by the second duke to Mary, Marchioness of Salisbury, June 18, 1852, and was buried near this spot, Feb. 21, 1861."

The northern front is plain—a severe simplicity, nearly allied to grandeur, being its chief characteristic; the centre compartment, with its entrance-doorway below, and noble clock-tower above, being the only elaboration it contains.

The south front contains the principal entrance, and, from its symmetry and ornate

character, is, architecturally at least, the principal one. The east front has, however, certain advantages, which go far towards making it the most interesting, as it certainly is the most picturesque. The view in that direction, whether from the house or of it, is by far the most pleasing, as the founder well knew when he caused the principal apartments to be placed on this side. The scene from these rooms is of remarkable interest and variety; first there is a noble terrace-walk, with enriched parapet, over which the eye wanders at will among the clustering flowers of the Elizabethan garden, and from thence to the maze, beyond which is the park, with its fine sheet of water surrounded by noble old trees.

Entering the mansion the visitor is admitted into a spacious HALL which leads to the GALLERY, in which are preserved many interesting relics of former days. Among these are the saddle-cloth on which "good Queen Bess" sat on her white charger at Tilbury fort, and another saddle-cloth used by the first Earl of Salisbury, the celebrated Sir Robert Cecil; a large collection of arms, many of which were taken from the "invincible Armada" of the Spaniards; and a number of models and other interesting objects. It contains also several effigies of men in armour, one of which is given in our initial letter.

The GRAND STAIRCASE is one of the most magnificent parts of this palatial residence. It occupies, in plan, a space of 35 by 21 feet, and comprises flights with five landings. "The balusters are massive, and carved in the Italian form; above the handrail are represented genii, armorial lions, &c., and here is a hatch-gate, probably to keep the favourite dogs from ascending to the drawing-rooms. The upper division of the ceiling is enriched by a very beautiful pendant in the Florentine style," relieved by gold and silver and colour. On the walls are hung a series of family portraits of the Cecils by Lely, Kneller, Vandyke, Zuccherro, Reynolds, and others. At the foot of the staircase is the DINING-ROOM, panelled throughout with oak, and having an enriched ceiling. Over the door is a marble bust of Lord Burleigh. Near this are the breakfast, summer, drawing, and other rooms, all of which are fitted and furnished in a style of sumptuous magnificence, and contain a vast number of very valuable paintings. Among the pictures contained in this noble mansion are no fewer than five original portraits of Queen Elizabeth, including the celebrated large one by Zuccherro; and many portraits, &c., which were the private property of that sovereign.

The GREAT HALL, or MARBLE HALL, is 50 feet by 30 feet, and is extremely lofty. It is lit by an oriel window at the upper or dais end, and by three bay windows; and is panelled with oak and lined with fine old tapestry. A carved screen, with an open gallery, decorated with armorial bearings, badges, &c., is at the east end, and the ceiling, which is coved and divided into compartments, is decorated with heads of the Cæsars. Here are deposited two banners presented to the late marquis by the Duke of Wellington—part of the "spoils" of Paris in 1814; here are also two other banners taken in the Crimea.

The staircase leads, almost direct, to KING JAMES'S ROOM, or the GREAT CHAMBER, one of the noblest apartments of the house, the extreme magnificence of which it is not easy to describe; in truth, it is too rich, and the eye turns involuntarily to the grand oriel windows for relief. The ceiling is of exquisite design, and was till recently plain white, now it is all gold and colours. The chimney-piece is massive, of white marble; and a central niche over the fire contains a life-size statue of James I. in dark stone. The fire-dogs are of silver; the furniture and the six chandeliers are gilt; the curtains are of white satin; the chair and sofa coverings are crimson velvet; and the carpet, "patent Axminster," is of Elizabethan design, worked in brown, gold, scarlet, and blue. This room, which is very large, contains some of the most important pictures, including Reynolds's portraits of George III. and Queen Charlotte.

The GALLERY extends the whole length of the south front; it is about 60 feet long and 20 feet wide. The ceiling is of remarkable beauty,

one of the finest examples of a period that was most prolific in such designs. The walls are panelled with oak, and are profusely carved.

THE LIBRARY, of equal dimensions with King James's Room, is enriched over the chimney-piece with a fine mosaic portrait of the first Earl of Salisbury—1608. The collection of books and MSS. is of extreme interest and value. Here, among other treasures, are preserved "the forty-two articles of Edward VI., with his autograph;" Cardinal Wolsey's instructions to the ambassador sent to the pope by Henry VIII., with Wolsey's autograph; and a pedigree of Queen Elizabeth, emblazoned, tracing her ancestry to Adam. The state papers in the collection extend through the successive administrations of Lord Burleigh and his son, the first Earl of Salisbury, and include documents which came into Lord Burleigh's hands through his connection with the court. Here are no fewer than 13,000 letters, from the reign of Henry VIII. to that of James I. Among the earlier MSS. are copies of William of Malmesbury's and Roger de Hoveden's English History; a splendid MS., with miniature of Henry VII.; another, with the autograph of Henry VI.; a treatise on Councils, by Archbishop Cranmer; the original depositions touching the divorce of Anne of Cleves; the proclamation of Edward VI. on ascending the throne; the original council-book of Queen Mary I.; historical MSS. by Lord Burleigh; the Duke of Norfolk's book of copies of his letters on the affairs of Mary Queen of Scots; accounts of the Earl of Northumberland's conspiracies, and the actual draft, in the handwriting of Sir Robert Cecil, of the proclamation declaring James of Scotland King of England, as well as the papers relating to the gunpowder plot, and to the Raleigh conspiracy, &c. Here are also many autograph letters of Queen Elizabeth, and the famous Cecil papers, "the oak cradle of Queen Elizabeth, the pair of silk stockings presented to her by Sir Thomas Gresham, and the purse of James I."

THE CHAPEL is a remarkably fine and interesting room, with a richly-painted window, and a gallery decorated with paintings of scriptural subjects.

The Park and grounds are full of fine trees, which from many points offer beautiful pictures, more particularly when seen in combination with the house or garden-terraces. Among the grand old trees in the park are the "Lion Oak," nearly 60 feet in girth, and a thousand years old; and "Queen Elizabeth's Oak," under which she is said to have been sitting when she received the news of her accession to the throne. The Gardens and Vineyard are remarkably beautiful and interesting. The latter, which is entered through an avenue of yew trees forming a picturesque wall on either side, and cut so as to give the appearance of walls and towers, with loopholes and battlements, is immortalised by Pepys.

The Privy Garden, on the west side of the mansion, is enclosed within a high and closely-cut hedge, with a close walk or avenue all around it. In each of the four angles stood a mulberry tree, said to have been planted by King James I., and in the centre is a pond surrounded by rockwork.

The three pairs of splendid entrance-gates, of French metal work, and of the most elaborate and artistic character, were put up by the late Marquis of Salisbury in 1846, when Hatfield House was honoured by the presence of her Majesty and the Prince Consort.

The town of Hatfield presents few objects of antiquity; it stands on the side of a hill, on the height of which are the gates of the mansion. Close at hand is the parish church, a structure with little pretence to architectural beauty.

We may not omit to mention that at the termination of the grounds runs the clear and beautiful river Lee—here of considerable depth. There is no bridge to cross to the other side, where are the kitchen gardens of the house, but a ferry-boat is always at hand.

On a steep above the river is the yew-tree walk—a series of pathways bordered by the venerable trees, dwarfed generally, but producing a most agreeable effect.

In all respects, therefore, Hatfield House is largely gifted by Nature as well as Art.

SELECTED PICTURES.

FROM THE PICTURE IN THE COLLECTION OF ROBERT RAWLINSON, C.B., BOLTONS, WEST BROMPTON.

THE HIGHLAND KEEPER'S DAUGHTER. J. R. Ansdell, R.A., Painter. C. Cousen, Engraver.

THE observer need not of necessity be a sportsman to feel interest in this picture; but he must be a lover of the animal world, or the work would have comparatively little attraction, except as an example of good painting. In England especially, there are few households, from the highest to the lowest, among whom the dog is not, and most deservedly so, a familiar friend. C. R. Leslie, in his "Autobiographical Recollections," says, referring to the Queen on her return to Buckingham Palace after her coronation:—"She is very fond of dogs, and has one very favourite little spaniel, who is always on the look out for her return when she has been from home. She had of course been separated from him on that day longer than usual, and when the state coach drove up to the steps of the palace, she heard him barking with joy in the hall, and exclaimed, 'There's Dash!' and hastened, after laying aside the emblems of royalty, to go and fondle the dog.*"

Mr. Ansdell's charming picture represents a scene in the Western Highlands, not far from Oban: a portion of the range of mountains seen in the distance is situated north of the island of Mull; the water is the head of Loch Etive. On the right, in the middle distance, are cottages of the keepers; the time of year is autumn; and the sportsmen have evidently just arrived, with their hounds, from Oban by way of the lake. The dogs are leashed together, two spaniels and two setters; and are following hungrily and expectantly a "braw, fair-haired lassie,"—such an one as Burns described in song. She carries, in a broad earthenware dish, the smoking viands for their meal: but is compelled to bear the dish aloft, lest the eager animals make a premature raid on its contents. Their form and action show perfect breeding; the fine and long silken hair (brown and white) of the setters; and the short smooth coats of the pointers, slightly pied (black and white), are rendered with true artistic skill. By no means an unconcerned spectator of the scene is the "collie-dog," which, from his distant vantage-ground, sniffs the savoury food, and not without a desire to receive an invitation to the feast; he looks, moreover, disposed to be present and do his part in it, even as an uninvited guest, but knows by experience that he is not able to "hold his own" in a scramble or fight for the meat.

The principal group is admirably composed; each constituent part is full of life and action; but especially striking and vigorous in attitude is the "Keeper's Daughter," who is, unquestionably, the most attractive object in the picture. Among the numerous works of the artist to which at various times our attention has been directed, we do not remember one, of a similar kind,—we are alluding only to his Scottish subjects,—which is preferable to this, for originality of design, richness of colour, and careful execution. Its owner may be congratulated on the possession of a picture which, though comparatively small, is valuable for its artistic qualities, is pleasing in subject, as a representative scene of sporting life in the Highlands.

* On Windsor Castle slopes, near to the Queen's summer-house, there is a monument in statuary marble over the grave of "DASH."





THE ADVANTAGE OF PHYSICAL GEOGRAPHY

TO THE

STUDENT AND CRITIC OF ART.

BY PROF. D. T. ANSTED, M.A., F.R.S., ETC.

I.—RIVER-VALLEYS.

ALTHOUGH on various occasions it has been pointed out, both by the writer of this article and by other authors, that a knowledge of the principles of certain departments of science, and of certain important details determined by science, cannot fail to be of great value to the artist, there is still so much indifference to this matter that it may well bear reconsideration. For this reason a renewed attempt to point out by a few illustrations some of the relations between Science and Art, will, perhaps, be welcome to the reader of the *Art-Journal*, and may be suggestive of an improved mode of treatment, both with regard to works of Art, and the judgment that should be formed of them.

In the present article it is intended to consider the natural history of river-valleys; chiefly with the object of showing that the form and physical features of valleys and their characteristics, which render them interesting and picturesque, or the reverse, have intimate reference to their origin, to their relation to climate, to distant mountain-chains, to the rocks of which they are formed, and often to some very different state of things, the discussion of which carries us far back into the ancient history of the world. In other words, that causes, whose consideration involves a knowledge of physical geography and geology, having been concerned in the formation of valleys, some knowledge of what has operated to bring out the present conformation of a country, will help the artist to delineate it, and the Art-critic to judge of the delineation.

Every channel that conveys the collected waters from a certain district of high ground through plains to the sea, or to some natural depression of the earth's surface, is in the sense here intended a river-valley; and every group of water-channels that ultimately combine to form one river, may be said to form part of such river-valley. Technically, the whole country from the mountains to the sea, that supplies the river with water by carrying over its surface the rain which has fallen there, or any part of it, is the drainage-area of the river, and forms a part of the river-valley. We will endeavour, by a few examples drawn from familiar and home localities, to show what are the essential points of structure and surface that tend to give a special character, not only to river-valleys on a large and complete scale, but to each separate part of a great river-valley, when the country traversed by it is extensive, and has varied physical features.

Let us first take the case of a well-known river in our own country, and follow its course from its sources, small and obscure, but numerous, situated among hills in a distant county; tracing it in its various forms of brook, rill, rivulet, and river, watching the differences that occur when it receives tributaries, or rather when two parts of the general stream first occupy the same channel, and following it at length into the sea, where it is lost in the vast expanse of water that seems unaffected by so paltry an addition to its volume.

The Thames, the father of the English rivers, whose course is more remarkable for gentle beauties than for the bolder and harsher features that are met with in other

streams, is formed originally by a collection of springs at the foot of the Cotswold hills, in the county of Gloucester. These springs, examined at any season, consist of the rain that has fallen some time previously on the sides and summit of the range, on rocks that are much cracked, and that allow water to pass readily into them. The water thus entering is, however, checked on its way downwards by coming in contact with bands of clay and other rock which it cannot pass through. It then makes its way through the strata to the surface, which it reaches in some nook where its constant passage has worn a small, but convenient, channel.

It would not be easy to reckon the number of small channels commencing with the springs thus coming out on the eastern side of the Cotswold hills, that contribute to form the young Thames. The water oozes silently from the rock at all times, varying a little at different times of the year. It has previously trickled through a complicated labyrinth of narrow crevices of the limestone rock, and through many tortuous channels between the bands of limestone, which are open in some places, and almost closed in others. The hills above are often dry and bare during the summer, but yet the interior of these hills is slowly giving out the accumulation of water obtained during the previous autumn, winter, and spring. A belt of vegetation marks the line along which the springs issue, and separates the brown from the green in a very visible manner.

Owing to the nature of the rocks and their position, and to the form of the surface, there are no deep gorges cut, through which the river rushes; no waterfalls or rapids are caused by natural obstructions to its passage, against which it might expend the force of its current; and there is no considerable or abrupt descent to produce a strong and rapid stream. The rainfall of the country being spread over the year, there is rarely a drought long enough to dry up these rills, nor is the rain often heavy enough to fill all the crevices, and produce by a torrent a wet season. The flow is indeed not equable, but it is incessant, and the difference at different seasons is not enormous. Through wide, park-like fields, between gentle slopes, among trees and shrubs, the various tributaries quietly make their way and combine their waters. At intervals they pass villages and towns, and a part of the water is directed into canals, or employed for town and agricultural use; but little change is thus made, and the stream always retains its interesting character.

Geologically the Thames, in its upper course, traverses only the rocks of the middle and newer parts of the secondary period—the former, the various divisions of the oolite, consisting partly of sands, partly of clay, partly of various limestones; while the latter, the representatives of the newer secondary, include the sands called greensand (often red enough in actual colour), and the great body of the chalk. In its lower course the river passes through the great mass of lower tertiaries, called sometimes the "London clay series," because it includes a great thickness of the clay on which London is built. Crossing the limestones, nearly at right angles, it is curious to trace the course of the Churn, one of the chief tributaries of the Upper Thames, as it changes its direction on entering the clay-beds immediately overlying them. The stream almost doubles back upon itself, running from Cirencester to Oxford, in a direction considerably to the north of east, after having come, from near Cheltenham, to Cirencester nearly due south. There is a

marked difference in the scenery between these points, as every one knows who is familiar with the counties of Gloucester and Berks, and it is due almost entirely to the nature of the rock. As the united streams of the Thames and the Isis leave Oxford, and enter the Portland series, they again cross the rocks at right angles; but on entering the lower greensand series they once more take a winding course, which is continued through the chalk part, or near Reading, Henley, Great Marlow, and Maidenhead, till the river enters the London clay, not far from Windsor. It is not necessary to remind the reader of the scenery of these parts of England. It must be familiar to all, because those who have not been so fortunate as to make frequent pilgrimages by land or water to the many favourite spots, have been taught their appearance and the nature of their beauties by the artist. The lovely woodlands of Berkshire are as completely a result of the existence of certain rocks in a certain position, producing soil, as they are of the adaptability of the climate and the circumstances of the neighbourhood affecting the culture and habit of the trees. This vegetation is a part of the valley of the Thames, and the trees would not be where they are if the valley had taken another direction or were formed of other rock.

Besides its principal stream, the Thames valley carries the waters of many tributaries to the sea. These also run through various rocks—one through the chalk, losing itself within the rock and burrowing through the chalk; another crossing the lands and clays of Sussex before entering and crossing the chalk. Many originate in the London clay. All these streams, like the main river, have cut their own way through the rocks; they have, in the course of time, with the assistance of rain and frost, produced those modifications of the surface with which all are more or less familiar, and if the work appears small in proportion to what is seen elsewhere, part of this is due to the general reduction of the whole surface, part to the geographical position, part to the moderate climate, part to the smallness of the scale of all work in islands, and the comparative want of effect in results when compared with work done on large continents, where lofty mountains produce rivers of corresponding magnitude.

But we need not travel so far to find a contrast. The Severn, in our own country, affords one which is equally striking and instructive. Geologically, the Severn is a river through old rocks greatly altered, the Thames through rocks comparatively modern. The Severn and all its chief feeders originate in surface-streams, the immediate result of rain falling in high, and often mountain, country, scarcely cultivated or wooded, and allowing but little of the water to penetrate into the interior. Unlike the Cotswold hills, which are of stratified, and, to a great extent, of absorbent rock, the schists and other rocks near the sources of the Severn are mostly non-absorbent, and the slope is generally considerable. A multitude of small streams and streamlets, most of them dry during the greater part of the year, all help, in time of heavy rain, to swell the torrents that then rush down the hill-sides into the valleys, and make their way at last to the main stream. Each torrent helps to carry down sand and stones, and each aids either to deepen its bed by erosion, or render it more shallow by depositing in sheltered places where the current is checked, the stones that the water has brought down.

In a small country like England, where

the strata are tilted and soon crossed at right angles to their extension, there is no great distance that can be traversed by a river without change in the rock. Thus, the main stream of the Severn, even before it reaches Shrewsbury, has left the hard slates and entered the soft new red sandstones, where the slope being diminished, the speed of the current is checked. The Teme and the Wye, however, two of the principal streams that feed the Severn, after a similar course through slates, cross only the much harder and more compact sandstones and other rocks called by geologists "old red sandstone." These, therefore, do not in any part cease to be subject to floods, and help greatly to retain this characteristic for the river to which they are tributary, even considerably below the part where they enter. On the other hand, the Gloucestershire Avon, which is a feeder that has received its waters from soft rocks, and which traverses somewhat flat ground, is a comparatively sluggish stream, coming in between the two to which allusion has been made, and simply adding a little to the volume of the river, without in any way affecting the general result.

The Severn contrasts with the Thames as a river in almost every point in which rivers can differ, and the scenery contrasts accordingly. Whether we visit the wild Welch valleys at the foot of Plinlimmon, or follow the dancing and sparkling trout-streams of which there are so many in the upper part of all the tributaries; or whether we study the rushing torrent of the Severn after a freshet—an event periodical and very frequent; or, even if we only look at its ordinary flow, exhibiting a kind of subdued vigour, as it hurries through a deep narrow channel or expands into a broad sheet of water, there is nowhere the smallest resemblance to any part of the Thames scenery. The expression of force and strength, originating in the hills and mountain-sides is retained throughout in the Severn, while the gentleness and calmness of the Thames from the commencement, are never lost.

There is much interest in this comparison between the two principal rivers of England, inasmuch as geologically they traverse from the commencement and throughout, rocks altogether distinct in age and composition. The Thames rises through middle and newer secondary and tertiary rocks; while the Severn hardly reaches any point in which the rocks are of newer age than the lowest secondary, and for a very great distance is confined to palæozoic rocks of an old and altered type.

The termination of the courses of the two streams offers contrasts no less remarkable than is observed in the river-valleys in the upper part. A little below Gloucester there is a point where, owing to the existence of a line of hard rock, brought to the surface in a direction nearly north and south, the channel is narrowed, and almost reduced to a gorge, below which it expands into a wide open basin, which again is closed by a similar gorge near Aust cliff, immediately above the junction of the Wye. These gorges are entirely due to causes that are explained by reference to the geology of the country. The estuary of the Severn is strictly corresponding to the river as a flood-stream.

In the lower valley of the Thames the stream makes its way through the same mass of London clay that has been passed through already for a very long distance. There is no gorge, no interruption to the general uniformity of the dip of the rock, and the river flows gently to the sea, only interrupted by the accumulations brought

up by the action of the tide. The absence of picturesque cliffs, of any marked variety of soil or condition to produce a change of scenery, and of any rock to cause a divergence of the stream, has resulted in the monotony of the scenery in the one case, while the presence of such causes has produced unusual picturesqueness in the other.

But the river-valleys of the Severn and the Thames are not the only types that are illustrated in English rivers. Many of the upper valleys of the principal tributaries of the Humber (a stream which combines the Trent and the Ouse), such as the Derwent, the Ribble, the Lune, the Aire, and others, bring us into acquaintance with a variety of river-valley belonging to limestone and gritstone rock; and although the examples will not bear comparison with the gigantic limestone fissures forming the valley of the Colorado, in North America, where a vast body of water rushes along a narrow channel between some thousands of feet of vertical cliff on each side, still there are fine examples yielding some of the most picturesque scenery of England.

The peculiar valleys in the limestone and gritstone rocks of Yorkshire and Derbyshire, well deserve, and have received, the careful attention of the artist as examples of river-valleys. Here we occasionally meet with small rapids and cascades—phenomena elsewhere rare in Great Britain. The vertical cliffs are often clothed with tree vegetation, and thus become highly picturesque. At frequent intervals the naked rock is exposed, and often there are transverse fissures in the rock, forming small tributary valleys, and affording a pleasant break to the otherwise somewhat monotonous character of the larger fissure of the principal stream.

The Aire, one of the most picturesque of the Yorkshire smaller rivers, springs at once a full stream from under a huge limestone cliff called Malham Cove, 285 feet in height. The water is supplied by subterranean channels in the limestone; some of it perhaps from Malham Water, a beautiful little lake on the high ground to the north, from which a small rill proceeds a short distance, but only to be lost in the cracks of the limestone rock.

Malham Cove is part of a long line of cliff connected with an important dislocation of the limestone rocks of this part of the country. If the water came over the cliff instead of at its foot there would be a magnificent cascade; and there is, in fact, a small stream that dashes over the edge in a narrow gorge at no great distance.

The scenery near Matlock affords an excellent example of this kind of river-valley. It has, however, more than the usual beauty, and less of the severity and majesty that is sometimes found. Very fine instances of the same general kind will be familiar to those who have visited the Franconian Switzerland in Germany; and corresponding scenery as obtained from sandstone rock is seen in the well-known Saxon Switzerland, on the banks of the Elbe, not far from Dresden, where, however, no regular stream connected with it exists.

The following account of the scenery of one of the Yorkshire valleys of this kind, by Prof. Phillips, well illustrates the brief account above given, and cannot fail to interest the reader:—

"In dry seasons the channel of the stream which descends from Great Colne to join the Lune is a wild hollow of stones; in wet seasons these are rolled along by its powerful torrent. In ascending the stream we find not only its actual banks, but considerable hills on its sides, to be composed of similar materials, drifted together

by some earlier forces of water. Farther upward these pebble-banks give place to the native slaty rock which has been their prolific parent, and the little stream winds, falls, and rushes through these rocks with a great variety of beautiful and intricate scenery. On a small scale it is indeed admirable, especially when the beck is reduced by long-continued drought to the few pure and perpetual feeders which are its proper source. The water is then of a clear and beautiful green, and is collected in little fairy pools, or pouring in tiny cascades over the blue slaty rocks which it has sculptured and perforated in a thousand ways. Hazel, holly, ivy, mountain-ash, and a hundred other humbler plants, combine with the heathy ground and the lichen-grey rocks into minutely-beautiful pictures.

"Still farther up the valley the limestone dips into the stream, and gives occasion to entirely different and equally curious scenes.

"The channel divides into several small branches, one which bears the most water being otherwise the least marked. Another through which in dry weather hardly a rill is seen—yet even in that state is almost impassable on account of its deep pools shut in by steep precipices—becomes in a rainy season a wild chaos of tempestuous water. This is Eargill, one of the most singular glens to be anywhere found. For several hundred yards along its course through the Scar limestone this rock is wasted and perforated by the elements into a great variety of fantastic shapes.

"The interior is wasted as much as the surface, and a great number of caves are formed by the action of water on the great interior fissures. These are partly laid open by the falling away of the limestone, and give occasion to the name, Eargill Kirk, which is applied to the narrow and irregular passage. As usual, there is a good deal of wood about the caverns.*

This account of the peculiarities of streams making their way through limestone rocks, will be found to apply in a very complete manner to similar phenomena, on a much larger scale, in other countries. Generally the river-valleys of this kind occupy fissures in nearly horizontal sheets of limestone, forming what is called "table-land" and very level on the surface. In Spain one may travel over many miles of nearly flat and very uninteresting country, with no appearance of break or change, till within a few yards of the edge of one of the yawning fissures belonging to a great river-valley. In a few minutes the character of the scenery is entirely altered. From a bare, treeless plain, we drop into a richly-wooded, picturesque, and considerable valley, with very little water, perhaps, in sight, but exhibiting unmistakable proof not only of water-action, but of the near presence of water. Such are examples of fissure-valleys, on a larger scale than are seen in England.

This reference to the principal varieties of valleys may help to give to the Art-loving reader a deeper and more intelligent interest in the scenery he loves to depict or study. Each is distinct and has its own characteristic beauties and peculiarities, and in each case the effect is due to good physical and geological causes easily traceable. It is not, of course, all rivers that are so typical, but scarcely any would fail to afford useful illustrations of the principle to which attention has been directed. It is not too much to say that the study of physical and geological causes would greatly help the artist to seize those points in a landscape that really influence the rest.

* Phillips's "Rivers, Mountains, and Sea-coast of Yorkshire," p. 115.

OLD BOND STREET GALLERY.

THE time has been, and that even of late years, when complaints were rife on the part of junior Art-students, that they could never obtain a place for their essays in a public exhibition, nor see their names in a catalogue. The temper of the times is changing, and this complaint can now no longer be urged in the face of the many institutions which have recently sprung up, admitting any essays in which there is a scintillation of genius. This exhibition presents for inspection 531 productions in oil and water-colour, being the performances of 375 contributors. A strong argument in favour of such exhibitions is that they contain works of considerable power by persons entirely unknown to fame; and the most gratifying passage in the history of the pictures is, *that they are sold*. Again, we observe here the names of men of reputation who are not ashamed to mingle in the throng, and who may, in such cases, truly be said to condescend to painters of unconfirmed estate. On entering the rooms we are confronted by 'St. Michael,'—a portion of a design painted as a specimen for mosaic, by W. F. Woodington. It is an ultra-colossal study of the head and bust of the archangel, and was, we believe, proposed to assist in the decoration of St. Paul's; under what circumstances of proposition and consequent rejection we know not. All that can be said of this work is, that nothing of a more sublime character will ever appear in the cathedral. The design bespeaks this praise for itself; but, independently of this, Mr. Woodington is known as a sculptor and a painter of exquisite taste and feeling. Besides his 'St. Michael,' he contributes two other pictures.

To note a few of the extensive miscellany, 'Fort La Concher, St. Malo, Brittany' (9), G. C. Stanfield, is an attractive performance: it is a subject to which this artist would do justice. The picture, 'We are Seven' (16), from Wordsworth, G. F. Chester, is full of that moving pathos which so sensibly stirs the heart in the poem. 'Ten Minutes' Rest' (17), E. J. Humphrey, takes us to the studio of the artist, who is lighting a cigar while his model rests; the latter is very forcibly brought forward. The study of a lady at a casement (30), without title, bespeaks on the part of the artist, R. L. Allbridge, valuable independence of thought and originality of purpose. 'Table Gossip' (41), Carl Bauerle, presents two children's heads, well grouped, animated, and carefully finished, though rough in texture. A 'Portrait' (76), Sir F. Grant, P.R.A., is that of a young lady—head and bust, in a riding dress: very agreeable in expression, but wanting the freshness of the President's earlier works. No. 215, by Alyce M. Thornycroft, is perfect as a conception, according to the severer canons of Greek Art: it represents Antigone, in defiance of the prohibition of King Creon, preparing to give burial rites to the body of her brother, Polynices. 'Moonlight in the Trossachs' (80), T. O. Hume, is remarkable for the success of the sky; and a 'Silent River' (92), G. Chester, although produced with a sentimental title, is worthy of note. 'La Pia dei Talmonel, Castello delle Maremme' (122), by Salvatore Martine, represents a religious procession formed of numerous figures well drawn and carefully painted. 'The Prima Donna' (137), J. A. Fitzgerald, is an extremely well-painted episode from the weary life of those peripatetic histrionic asteroids who pass from youth to age in strolling from fair to fair. By J. E. Millais, R.A., is a beautifully tender drawing in pencil, touched with white, called 'A Reverie;' and W. E. Frost, R.A., contributes 'A Nereid,' one of his inimitable oil-miniatures; and a frame containing ten very graceful water-colour sketches. Two charming landscapes, of great merit as transcripts of nature, are the productions of A. de Bréanski. By G. E. Hicks are, especially, two groups of children, worked out with a show of learning seldom seen in such subjects; and we are agreeably surprised by a very well-executed landscape by Mr. Solly, F.R.S. There are also successful studies by L. Alma Tadema, L. Smythe, J. Morgan, E. Ladelle, H. Dawson, G. Smith, W. L. Wyllie, and others.

EARLY PAINTERS
OF NORTHERN ITALY.*

Nothing, save an enthusiastic love of Art, could have allured the authors of these and preceding volumes into such apparently unprofitable regions as they have travelled over. The ground certainly promises some harvest to reward their toil, but the labour of procuring it is great; and, when realised, the results interest only a few; for early paintings, whether Italian or Flemish, have only a very narrow circle of admirers; while, as a rule, if the works themselves are valued, their history, and that of the painters, are comparatively matters of indifference to the possessors of the pictures. It is, however, the same spirit working in such writers as Messrs. Crowe and Cavalcaselle, which, though operating in different directions, urges the biblioplist to give his time and attention to worm-eaten manuscripts, half-illegible parchments, and musty tomes; and animates the antiquarian to pursue his researches among mouldering architecture of every kind, and to burrow his way, like the mole, through ancient grave-mounds and all other memorials of long-past generations of the great human family; and thus the world, somehow or other, is made wiser, and, it is to be hoped, better, by the labours of all these toilers after facts and truths.

The two volumes now offered to the public by Messrs. Crowe and Cavalcaselle comprise the history of Venetian and Lombard Art—that is, the Art of Venice, Padua, Vicenza, Verona, Ferrara, Milan, Friuli, and Brescia—from the fourteenth to the sixteenth century. The subject was alluded to, but little more than incidentally, in the authors' "History of Painting in Italy," but it is now fully developed in all its various ramifications; the object being to trace the currents by which the main stream of progress in North Italian painting was affected. Still, the narrative is strictly limited to the history of quite the early painters of the respective schools, whose names, with the exception of a comparatively few, are known only to the student of ancient Art. The most familiar of those of the fifteenth century, allied with the Venetian schools, are the Bellinis, Carpaccio, and Cima da Conegliano; to the sixteenth century belongs Giorgione. Titian and Tintoretto might also very properly have been included within the list, for they both lived in the latter century, and executed their best works within that period. We may presume that the introduction of these distinguished painters would have unduly lengthened the history; certainly they demand a volume, at least, for themselves.

Two or three distinct currents, we are told, may be traced in the Art of Venice at the beginning of the fifteenth century. "During a previous age, the tendency of painters was to preserve the oldest types, the most venerable formulas, and the most antiquated handling." Examples of this kind of work are still to be found in some of the decorations of the churches of Venice; as in the wall-painting of a lunette, originally belonging to the tomb of the Doge Francesco Dandolo, about 1338, formerly in the cloister of the Frari church, but now transferred to that of San Salute; and also in a mosaic forming part of the monument erected to the Doge Michell Morosini, in 1382, in the choir of the church of S.S. Giovanni e Paolo, of which edifice so large a portion was destroyed by fire two or three years ago. "The Giottesque element displayed its excellence in vain within the churches and chapels of the neighbouring Padua. It passed through Venice and scarcely left a sign. The cause lay deep in the hearts and customs of the Venetian people, who preferred the barbaric splendour of the Orientals to the sober but refined taste of the Tuscans."

Tracing back the origin of the Venetian

school of painting, we are told:—"The main current, which had been fed by Lorenzo, Semitecolo, and Guariento, was now fed by Jacobello del Fiore, Negroponte, and Donato, a race of artists whose skill by no means equalled that of cotemporary Tuscan craftsmen. But by their side, and perhaps because del Fiore had shown so little real power, the state employed two strangers, Gentile da Fabriano and Pisano." Where they came from has never been ascertained; Lanzi says Fabriano began to distinguish himself among the painters employed, in 1417, on the dome at Orvieto, and that he went afterwards to Venice, where he was engaged in decorating the public palace. Pisano's birth and education are yet more involved in obscurity; del Pozzo, intimating that he belonged to Verona, while Vasari asserts that he was journeyman to Andrea del Castagno at Florence. However, "these strangers introduced a new feeling into Venice; and this new feeling became characteristic of a school which arose in the island of Murano. A third division was created by the efforts of Jacopo Bellini, a pupil of the Umbrian Gentile" (da Fabriano), "but taught within the walls of Florence, and thus prepared for a great and important part.

"It was to happen that these three currents should flow for a moment in a parallel direction, that they should then commingle, and finally unite to form the school of Gentile and Giovanni Bellini," the sons of Jacopo. "During this process the old Veneto-Byzantine style was elbowed out of the world in silence and without regret. The Murianese grew up to a moderate and by no means disagreeable originality which soon glided into imitation of the Mantegnesque and the Bellinesque. The Bellinis absorbed all the principles of artistic progress within the city of their birth, and deserved for this reason to be called the fathers of Venetian Art."

About one half of the first of these two volumes presents a history of the Venetian painters from the time of the Bellinis to that of Bissolo and Bartolommeo Veneziano; of the latter artist our National Gallery offers an example—a portrait of a young man; it is signed and dated, 1530, on a white scroll. Next follows a notice of Paduan Art, which during the fourteenth century was "a mere exotic," thriving under the direction of men who went from other cities to Padua. As that period closes, Giottesque is supplanted by Umbrian feeling, and at last a study was founded by Squarcione, "in which the rudiments of education might be attained." The most famous artist of this school in the fifteenth century was Andrea Mantegna, whom Squarcione adopted when a child, though in after-life "sworn hostility" divided them. Mantegna's chief works are, perhaps, better seen in Mantua, Florence, and Rome, than in his native city. His famous 'Triumph of Julius Caesar' is, as most of our readers are aware, at Hampton Court. With some remarks on the schools of Vicenza, Verona, Ferrara, and Parma, the first volume closes. The most familiar name among the early painters of these cities is that of Francesco Raibolini, commonly known as "il Francia," a native of Bologna.

The second volume is devoted to the Art of Northern Italy in the sixteenth century; it includes a list of men, gathered from various places, Milan, Venice, Brescia, &c., whose works are held in the highest repute wherever European Art has circulated—such painters as Bramantino, Borgognone, Solario, Antonella da Messina, Giorgione, Pordenone, Sebastian del Piombo, Palma Vecchio, Lorenzo Lotto, and others of less note.

In introducing the name of that splendid colourist Giorgione, the authors say,—"The grandest form of Venetian Art in the sixteenth century—that which left indelible marks on the schools—we owe to Giorgione and Titian. It would be difficult to overrate the influence which each of these distinguished individuals exercised upon the painters of his time, nor is it possible to find two men who have remained more justly or more constantly in honour. Giorgione and Titian were born so nearly at the same time, that they may be called contemporaries, but the growth and expansion of their talent were singularly different. Titian seems to have risen

* A HISTORY OF PAINTING IN NORTH ITALY—VENICE, PADUA, VICENZA, FERRARA, MILAN, FRIULI, BRESCIA, FROM THE FOURTEENTH TO THE SIXTEENTH CENTURY. Drawn up from Fresh Materials after Recent Researches in the Archives of Italy, and from Personal Inspection of the Works of Art scattered throughout Europe. By J. A. CROWE and G. B. CAVALCASSELLE, Authors of "Painting in Italy," "The Early Flemish Painters." 2 Vols., with Illustrations. Published by J. Murray.

steadily but slowly to eminence; Giorgione, at a very early period, showed signs of precocious skill. In the genius which he displayed, in the rapid development of his means, in his early death and subsequent fame, Giorgione may be compared to Raphael. The measured steps by which Titian rose to the highest place amongst the craftsmen of his time remind us of Ghirlandajo."

Both Giorgione and Titian studied in Venice under Giovanni Bellini, but when Titian left the atelier of the latter, he became the disciple of Giorgione, "who gave an impulse so powerful and so lasting to the style of Titian, that Titian with his richly-endowed pictorial constitution, was enabled first to equal, and then to surpass, Giorgione. Whether Titian's renown was ever so great as that of his short-lived rival is doubtful."

Sebastian del Piombo is another distinguished name in the annals of Italian Art of this period. He "would have succeeded to Giorgione's practice at Venice, but that he wandered to Rome at an early period of the sixteenth century. He had been Giorgione's friend and journeyman, had probably sung and played with him in more than one concert, and haunted the same scaffoldings in Venetian palaces; no two artists of that age were more completely similar in feeling; but there was this difference between them: that one was a man of acknowledged repute, when the other struggled as a beginner. Sebastian knew that Giorgione held a high position, but he also thought that a man so talented and so young would hold that position long; and this induced him to seek his fortune away from Venice." Yet he did not quit it without leaving behind him sure evidence of a genius destined to produce great works. Of this the most notable example, perhaps, is seen in his picture of 'St. John Chrysostom,' in the Church of San Giovanni Crisostomo, Venice, which is styled, "majestic," by our authors. "The composition," they say, "wants compactness, as a whole; it displays the realistic, impetuous spirit of a man gifted with pictorial fire, but without the exquisite delicacy of Giorgione, the supreme dignity of Titian, or the aristocratic force of Michael Angelo."

Sebastian went to Rome, where, in time, he acquired very much of that "aristocratic force" in which he had heretofore been deemed deficient. In Rome he received an uncommon share of attention, and from none more than from two of his most celebrated contemporaries, the rugged Michaelangelo, and the kindly Raphael, "between whom strong rivalry existed. It has always been said that Michaelangelo, knowing his own inability to acquire the gifts which distinguish Sanzio" (Raphael), "courted Sebastian's friendship, in order that, by instilling into him the true precepts of drawing and composition, he might produce a successful rival to Raphael. The tale thus told seems on the face of it improbable, but there is no doubt that Sebastian became Michaelangelo's friend and Raphael's enemy."

One is tempted to linger long over these most interesting and instructive volumes, so full of genial and judicious criticism on pictures, a large proportion of which are known only to the few whose enthusiasm for Art has led them to go forth in search of them. We must, however, bring this notice to an end; and do so by using an expression which has almost become hackneyed, that this history is, "a most valuable addition to our Art-literature," notwithstanding the labours of other previous writers in a similar direction. We would suggest, however, that, if a second edition be called for, as we hope it may, the pages should undergo careful revision as regards punctuation; this has not received the attention it demands; and, as a consequence, the sentences read, sometimes, rather obscurely. An occasional want of uniformity in the orthography of proper names is also occasionally noticeable, for example, Michael Angelo and Michaelangelo, observable in the passages we have quoted. Writers, we know, frequently differ in the manner of spelling the names of the old painters; Raphael, Raffaele, and Raffaello, are respectively adopted by authors; but whichever be that determined on, it should be used throughout.

THE SOCIETY OF WOOD-CARVERS.

THIS very modest and unobtrusive association, which has its rooms and offices at 22, Newman Street, has now been established upwards of forty years, and has in its time advanced the taste and education of many who have become artists by its aid, but who, without such assistance, could scarcely have hoped to have risen beyond the condition of mechanical copyists. Those of us who may remember the pretensions of the art in this country thirty years ago, have been much surprised at the quality of the works produced within that period, though without inquiring as to the nature of the agencies by which that quality has been brought about. In every department of Art great changes have recently been wrought with mixed results, but generally for the better. No Art-institution can stand still—all are either progressive or retrogressive; and it is much to be regretted that the Society of Wood-Carvers is on the decline; not because there is no demand for wood-carving—there is a more extensive demand for the products of the art than there ever has been; nor because there is no need of such an institution, for without the advantages of associations like this, the acquisition of special education up to certain points is, if not impossible, certainly very difficult. This society, then, is in decadence, as is shown by its reports and other official statements; and the object of this notice is to make this fact known to its old friends, members, and patrons, in the hope that something may be done in the way of assistance and reconstruction.

One of the annual reports now before us states the year's expenditure at something over £96, while the subscriptions, &c., amount to £104; hence it will be seen that the help required would be by no means extravagant in amount. Our appeal is made in full conviction of the merits and the claims of the society. The improved state of the art shows the necessity for a guild or association of wood-carvers, and as such an institution already exists, the readiest means of promoting the interests of the art and its professors, will be to support and reconstruct that which has been so long and so advantageously in existence. One of the primary causes of the decay of the society is said to be the establishment of another association of wood-carvers, which offers to its members substantial aid in time of sickness, on the principle of a benefit club; but, as a society putting forward superior claims to public notice, it is to be feared that the one to which we refer is declining, from its too retiring habits. We never hear of it in anyway before the public, nor have we known it hold exhibitions of the works of its members, which, to the prosperity of every Art-society, is indispensable in the present day. In the preface to the laws of the society its objects are thus stated:—"The co-operation of wood-carvers to promote the advancement of their art; the formation of a collection of books, prints, drawings, and casts; to afford facilities for self-improvement, and the diffusion among the members of such information as may assist them in the practice of their art, and enable them to obtain employment."

Such are the objects that have been kept in view since the establishment of the society, in May, 1833, when five operative wood-carvers associated themselves as the nucleus of the institution. Their resources were of the slenderest, and their rules of business as simple as possible. As the register of the company and their accounts, a twopenny memorandum-book was sufficient, and yet their ambition was boundless, being no less than the rearing of an establishment with a museum and educational means similar to those of South Kensington. But although they may have failed in this, let us see what they have effected. The number of members was, a few years ago, nearly 200; last year's report states the number at 86, thus showing a great diminution. The property of the society consists of books, prints, casts, carvings, photographs of choice sculpture and bas-reliefs; and, in short, of a large collection of material judiciously selected with the view of improving the taste of students. The library

consists of about 300 volumes of books, and sets of plates, and every facility is allowed for rendering these available. We repeat that such an institution is required now as much as when the Society of Wood-Carvers was established in 1833. It has declined not in consequence of any dearth of merit, but simply because it is not well up in the rapid current of the times. It should be brought and kept before the public, and assimilated in shape to the educational and technical institutions of the day. Mr. Sandilands, the secretary, will afford all particular information as to its means and purposes.

While we would urge the members of this society to make what exertions are in their power to uphold and extend its influence, and especially by giving publicity to its operations; we would invite the attention and assistance of all to aid in promoting the objects of an institution seeking to develop the resources of an important branch of Art-handicraft.

SELECTED PICTURES.

FROM THE PICTURE
IN THE SHEEPSHANKS GALLERY.

THE MARKET BOAT.

C. Stanfield, R.A., Painter. J. C. Arnytage, Engraver.

THIS engraving is from one of the earliest pictures exhibited by Stanfield—at the British Institution, we believe, so far back as 1826;—it may thus be accepted as a kind of *avant-courier* to the large number of marine-works which followed it during a period of about forty years.

The scene lies on the Scheldt, a locality which painters of "sea-scapes" have loved to frequent for more than two centuries. Though, from the flatness of the shore on both sides, its banks are not so almost uniformly picturesque as our own Thames, any one who has sailed up the river as far as Antwerp, and even beyond, must have noticed that they offer in the towns, villages, and churches, of quaint architecture, in the green meadows studded with cattle, and in sundry other special features, conjointly with the heavy-built Dutch merchant-shiping, and the numerous market-boats plying between the coasts, materials to form attractive subjects for the painter.

Judging from the breadth of water, Stanfield must have sketched this view no very considerable distance from the mouth of the river: the near boat is preparing to cross over with its freight of passengers, fruit, vegetables, &c., for one of the boatmen is unloosing the craft from the buoy, while another close to him hails a similar boat approaching from the other side. Behind is a Dutch schooner tacking up the river; and, moored off the opposite coast, is a large vessel which, so far as the flag at her stern can be made out, is a British ship.

The market-boat in front, with its contents, is a picturesque bit of composition, and shows much rich and varied colouring, which is partially repeated in the water, the artist skilfully treating the grouped objects so as to let a gleam of bright sunshine fall upon this part of the work; and as the clouds roll away for a few minutes—there is rain coming on in the distance—gleams of sunlight are repeated on the opposite land and water. A fresh breeze is blowing, just enough to keep the masses of clouds in tolerably rapid motion, and to cause a surf on the dwarfish waves as they roll onward to their near shore. The action of the water shows the artist's close study of the elements, while his judicious treatment of light and shade keeps everything in its proper place, and subordinate to a general brilliant result.





INTERNATIONAL EXHIBITION.
THE ENGLISH PICTURES.

THE paramount feeling with which we approach this admirable gathering of British Art, is the conviction that the works reflect the spirit of the day; as they have been, for the most part, recently produced. Indeed, in looking at the nerve and life of many of the pictures and drawings, and remembering the brevity of their existence, we must class their authors among the most accomplished of *improvisatori*. We are here in company with many of the most ambitious spirits of our time, who signify broadly enough what they are doing to-day; but that is no key to any forecast as to what they will do to-morrow. Of a selection of these works it were perhaps the highest commendation to say that our painters of the last century would not have understood them. One, taken as a text and followed out, would unfold a curious history. We need not say that the assemblage presents every diversity of material, for among the most prominent works are those of F. Leighton, G. F. Watts, T. Faed, J. Linnell, H. S. Marks, E. Armitage, J. E. Millais, E. M. Ward, W. Dyce, E. J. Poynter, Sir E. Landseer, C. Stanfield, A. Elmore, J. C. Hook, E. W. Cooke, W. H. Hunt, and many others, equal in power, whose names even there is not space to record; proceed we, therefore, to particularise—

A small picture, 'Offerings to Isis' (11), E. J. POYNTER, A.R.A., bearing reference not only pictorially but also architecturally to the Egypt of the past. The offerings are borne in a basket on the head of a girl, who, it need not be said, is costumed in accordance with the historical accuracy of the temple-vestibule in which she is placed. There may or may not have been a purpose in the cast of this figure. Why it suggests architecture is that it resembles a Caryatid, the basket on the head doing duty as a capital. Under any circumstances it is a remarkable work, and strikes at the root of certain principles which have been accepted as rules incontrovertible, and according to which the working regulations of our English *renaissance* are hopelessly wrong. Mr. Poynter exhibits also (43) 'Andromeda,' a story sufficiently hacknied to give a double relish to the novel terms in which it is here told. To these and other works akin to them we point, without ignoring their indebtedness to earlier convertible Art, as essays essentially different from all modern instances. The habit of decrying British Art has obtained overmuch since we have been inundated with foreign pictures. Another of Mr. Poynter's pictures is the grand and well-known work, 'Israel in Egypt.' We pass on to 'Esther's Banquet' (38), E. ARMITAGE, A.R.A., a work triumphant in colour, and showing a singular power of keeping a commanding subject well in hand; it is, indeed, a rare display of artistic erudition, and beyond all question the finest of Mr. Armitage's contributions. The refinements which mark both the exalted ideal and the mechanical qualification, prove how much there is to be learnt by students, even of mature years. The rules of the applied Art here are such as men acquire only after a lifetime of labour. 'After the Transgression' (60), G. F. WATTS, R.A., is the most daring presentment in the Exhibition. It is a sketch of the crucifixion, with a richness of colour and studious looseness of touch, reminding the observer of one or two similar sketches by Tinto-

retto—notably one in the Pitti at Florence. *Apropos* of this a chapter might be written; but of the works generally exhibited by Mr. Watts, all that can be said here is, that they prove him greater than his reputation. He exhibits portraits of Lord Lawrence, Lord Campbell, Right Hon. W. E. Gladstone, Thomas Carlyle, &c. The new school is again brought before us by Mr. LEIGHTON'S 'Mermaid' (36), a highly successful version of a subject presenting so many difficulties as to be rarely attempted. The siren has more of the Lurley than the mermaid. A youth blindly yielding to her intense fascinations is already in her fatal embrace. The conditions are set forth as challenging diverse interpretation—a painted fable, or a painted fact. This is fruit of another branch of the new school. In 'Measure for Measure' (12), R. BURCHETT, are some admirable figures and much skilful painting, but the correlations of the various persons require explanation, in the absence of a leading point of interest.

Many works, it will be noticed, are here which have been exhibited before, but their quality demands that at least they should be named. Their presence is undoubtedly welcome, for on each occasion of their exhibition they are seen with renewed interest. Among these, besides those already pointed out, are 'The Minstrel's Gallery' (10), H. S. Marks, A.R.A.; 'Waiting for the Verdict' (41), and 'The Acquittal' (46), A. Solomon; 'Renewal of the Lease Refused' (85), E. NICOL, A.R.A.; 'The Seventh Day of the Decameron' (64), P. F. POOLE, R.A.; 'The Poor Man's Friend,' T. FAED, R.A., and, by the same, 'From Dawn to Sunset' (292); Mrs. E. M. WARD'S 'Scene from the Childhood of Joan of Arc' (373), and 'Palissy the Potter' (335); 'Christ Raiseth the Widow's Son of Nain' (279), W. C. T. DOBSON, A.R.A.; 'St. Paul's' (274), D. ROBERTS, R.A., and, by the same, 'Westminster Bridge' (280); 'Landscape' (291), T. CRESWICK, R.A.; 'Electra at the Tomb of Agamemnon' (313), F. LEIGHTON, R.A.; 'Camel Crossing the Nile' (320), F. GOODALL, R.A.; 'Werner, and Josephine, his Wife' (Mr. Macready as Werner), (330), D. MACLISE, R.A.; 'The Sisters' (323), J. E. MILLAIS, R.A.; 'Louis XVI. in the Temple' (342), E. M. WARD, R.A.; 'Two women shall be grinding at the mill' &c. (396), A. ELMORE, R.A.; 'Van Amburgh and his Lions' (398), Sir E. LANDSEER, R.A.; 'The Mitherless Bairn' (407), T. FAED, R.A.; 'Highland Lassie' (408), Sir E. LANDSEER, R.A.; 'The Knight-Errant' (431), J. E. MILLAIS, R.A.; 'Mountain Scene' (418), C. STANFIELD, R.A.; 'Both Puzzled' (435), E. NICOL, A.R.A.; 'Scene from *The Merchant of Venice*' (436), J. C. HOOK, R.A.; 'St. Paul's from the Thames—looking West' (464), D. ROBERTS, R.A.; and by the same 'St. Paul's from the Thames—looking East' (458); 'The Virgin and Child' (362), W. DYCE, R.A., &c.

We find among the above, some of the best works painted by the artists whose names they bear, with an admixture of others, unimportant perhaps as to subject, but yet rendered both technically and in spirit in a manner to do ample justice to the reputations respectively of their authors. Among them are seen instances of that diversity of manner which, in comparison with the show-gatherings of other nations, presents no such concentration of feeling, or operative similitude as marks a common course of teaching. On the contrary, the conclusion that must be arrived at by the study of these performances is, that every British artist acknowledges no master.

To proceed: by 'The Death of the First-Born' (20), H. WARREN, we are referred at once to the twelfth chapter of Exodus. The mother weeping distractedly over her dead child explains the cause of her affliction, and the circumstances point to the universal visitation. Notwithstanding the independence of thought and show of power in 'The Harbour of St. Ives' (8), C. NAPIER HEMY, we turn from the picture with the impression that the artist, in his anxiety to paint substance, has entirely overlooked the necessity for transparency. The details in 'The Causerie' (42), ALMA TADEMA, approach doubtlessly as nearly as possible, the truth of the apurtenances of Roman domestic life. The *causerie* is held by two ladies, whose surroundings bespeak the wealth of resource, in the properties and economy of the ancients, possessed by this artist whose works are always marked by much refinement. The fitting sunlight formed and driven at the capricious will of the clouds in 'A Gleam on the Hills' (47), J. PEEL, represents a passage of picturesque nature often attempted, but rarely compassed so effectually as we see it here. 'Water-mill and Ford' (53), by the same hand, is also a meritorious picture. The occurrence described in 'Padre Francisco' (68), E. LONG, is perhaps not uncommon where the Catholic clergy are at all times open to the visits of penitents. The *padre* here is asleep in his chair, and his servant is about to awake him to announce the arrival of a lady. The incident is set forth with some unction—and the drawing and painting are highly satisfactory. Scarcely do the cattle of the Pontine Marshes look wilder than the black cattle of the Highland hills, when the fierceness of their aspect receives justice at the hands of the painter, as in 'Highland Landscape and Cattle' (68), H. GARLAND. 'The Plough' (73), F. WALKER, A.R.A., is a strikingly original work. It is very like an ancient picture; there is, however, too much red in it; the colour which abounds in a quarry, forming a large feature of the scene is, unnecessarily, we think, repeated in the sky; but this detracts immaterially from its other merits. 'Happy Childhood' (82), C. BAUERLE, a foreign artist, is an attractive picture; but there is not the sparkling character about M. ISRAEL'S two pictures (86 and 92), 'The Mother Sick' and 'The Mother Well,' that prevails in his sea-side subjects. So much difference is manifest between this painter's interiors and his outdoor incidents, that there is very little in common to determine them as works by the same hand. Striking excellence is shown in 'The Crown of Thorns' (79), P. R. MORRIS; 'Companions in Solitude' (101), W. GALE; 'Okehampton Valley, Dartmoor' (94), and 'Rain Clearing Off' (451), H. MOORE; 'Tea on the Grass' (114), J. ARCHER, R.S.A.; 'The Murder of the Innocents' (148), W. E. FROST, R.A.; 'Autumn' (160), and 'Rough Pasturage' (297), J. W. OAKES; 'Cortile of a Genoese Palace' (202), W. W. DEANE; 'Venus' (261), H. C. SELOUS; 'The Grape-Gatherer' (272), T. BROOKS; 'A Cornish Gorge—Moonrise' (390), G. F. TENISWOOD.

To 'Mariana' (80) (*Measure for Measure*) it would appear to us that the artist, Mr. F. R. PICKERSGILL, R.A., has communicated a degree of softness beyond what he has considered generally necessary to his works. The study may be said to be in shade, with just sufficient light to render mutually the utmost value to the proposed effect. 'Pilgrims at the Scala Santa, Rome' (84), K. HALSWELLE, has the great merit of personal variety; inasmuch as the

pilgrims do not look like modifications of the hacknied models that figure in so many compositions. The work is otherwise a marked success. By H. DAWSON (Nos. 91 and 108), 'Greenwich Hospital' and 'London from Greenwich Hill,' show a command of resource and an unbiased feeling of which similar instances are not numerous. The subjects have been painted many a time and oft, and very successfully; yet the artist in entering the *mêlée* shows a well-grounded affiance in his powers.

'North Sea Fishing Pincks' (121), E. W. COOKE, R.A., declares at once how much more this painter is at home on the North Sea than on the Adriatic. The picture is a trifle harder than the artist's wont. The "pinck" owes its popularity entirely to Mr. Cooke—we knew nothing of the craft until he took her in hand. 'A Rift in the Gloom' (139), G. E. HERING, is an effect which, of course, the artist has seen. Everything is sacrificed to the intensely dark drapery of the sky, whence issues an utterance of much grandeur, the veracity whereof is accepted on the pledge of the high reputation of the painter. 'A Breeze up Channel' (135), G. L. HALL, is a small sea-view, responding admirably to its title, with a broad effect of daylight. 'The Lock, Cashibury' (146), T. J. SOPER, is a great advance on anterior works. In 'Aurora in Romagna—Peasants from the Mountains on their way to Rome' (155), W. LINNELL repeats, we think, a presentment which he has essayed before. If he has worked with the view of giving a scriptural character to his composition, he is perfectly successful. The work has much of the *cinque-cento* savour, and the wayfarers, it is not necessary to tell us, are bound on a holy mission. While in 'Pelleas and Ettarre' (164), (*The Holy Grail*), E. H. CORBOULD, we must do all justice to the romantic sentiment and the precise painting of this artist, yet in company with men of greater reputation it would be better (*artem celare*) to mask here and there a cast of his academic erudition, than to fritter it away in circumstantial niceties. The picture is one of unquestionable power, but a thought more dramatic than Tennyson's verse. With the available sum of our Egyptian lore, 'The Death of Cleopatra' becomes a subject more interesting than of old, when the great authorities rendered the story in the common form, the semi-nude figure applying the asp. Here (No. 176), V. C. PRINSEP, in the ample hall of an Egyptian palace, is a group of women, whom one, perhaps Charmione, is already dead. The picture is large, and the figures are seen in an uncompromising breadth of light, an error, we submit, for such a work. It wants the force of shade, and a larger scale of gradation; and between the impersonations the contradistinction is insufficient. J. W. INCHBOLD'S 'Early Spring' (177) exhibits marvellous patience in the perfection of its finish. The trees—beeches—are exquisitely made out. 'An English Harvest Field' (183), W. GOSLING, is a great advance on antecedent works. In 'A Highland Burn' (184), HAYNES KING, the material is commonplace—two girls catching water at a rill—but there are many interesting points developed in its completion. 'A Summer Afternoon in the Highlands' (185), B. BRADLEY, is bright and sunny, with an appropriate living element in the flocks and herds of these mountain-pastures. Another rural theme, without any dominant incident, is 'Labourers returning from Work—Evening' (195), J. W. KNIGHT; its merit rests on its forcible and independent manner.

As there are other valuable works to which nothing but a description in detail ought to be given, and as it is impossible to extend the notice thus far, their presence in the exhibition can only be signified by the titles. The assemblage contains, as we have already remarked, many fine pictures which have been seen before. Of these some have been noted, and others are now added to the list. 'Herod's Birthday Feast' (189), E. ARMITAGE, A.R.A.; 'The Prince Consort in Council over the Plans for the Exhibition of 1851' (231), H. W. PHILLIPS; 'Painting for Lumette—in the Competition Gallery, South Kensington Museum' (235), F. R. PICKERSGILL, R.A.; 'A Sunday Afternoon at Hampton Court, A.D., 1658—the Cromwell Family with Milton' (240), C. LUCY; 'The Queen's Departure from Ireland' (267), M. KENDRICK, R.H.A.; 'Lane Scene near Ecouen, France' (285), J. C. THOM; 'The Reverie' (288), W. C. THOMAS; 'A Fairy Tale' (317), LOUISA STARR; 'Charles Dickens' (329), W. P. FRITH, R.A.; 'The Acre by the Sea' (361), J. C. HOOK, R.A.; 'The Jeweller of St. Petersburg' (394), W. C. THOMAS; 'At Lesbia's' (419), L. ALMA TADEMA; 'Ave Maria' (426), K. HALSWELLE; 'Attack and Defence' (429), J. C. HORSLEY, R.A.; 'On the Way to the Cattle Tryst' (432), P. GRAHAM; 'Scene from *The Merchant of Venice*,' J. C. HOOK, R.A.; 'Morning Prayer' (443), W. HOLMAN HUNT; 'Silenus and Bacchanals' (444), W. E. FROST, R.A.; 'Laura in Avignon' (450), W. C. THOMAS; 'Mother and Child' (460), J. SANT, R.A.; 'Lost and Found' (166), J. C. HORSLEY, R.A.; 'The Flight of Mary of Modena' (145), A. JOHNSTON; 'An Old English Homestead' (134), R. REDGRAVE, R.A.; 'The Visitation and Surrender of Syon Nunnery' (129), P. F. POOLE, R.A.; 'Margaret of Anjou' (128), J. HAYLLAR, and others, for even the titles of which there is not space. These, however, and those that precede them, prove this collection of English pictures to be one of the most varied and interesting that has ever been brought together.

The water-colour works, which are in number upwards of five-hundred, are distributed in the rooms marked 7, 8, and 9, and represent, principally, the different classes of living or recent painters distinguished in that department. Indeed, it is only just to say, that many of the examples are among the very best productions of the artists whose names attach to them; and of these names a proportion stand high on the roll of fame. Thus, by F. TAYLER, are, 'On the Ptarmigan Hills' (1,758), 'Stag Hunt in the time of George II.' (1,673); and Portraits of the Marquis of Lorne, when about eleven years of age, and Lady Edith Campbell, both mounted on shelties, and galloping over the heather; by F. W. TOPHAM, 'A Pastoral' (1,628), 'Welsh Wayfarers' (1,709), 'The Disputed Point' (1,795), &c., presenting specimens of different periods; C. HAAG, a study of Arab figures made at Palmyra (1,756), and (1,639), 'Portrait of my Mother.' The Highland landscapes by W. L. LEITCH, Nos. 1,578, 1,964, and 1,977, describe with perfect truth the face of the country and the aspect of its sky. The sacred interiors by S. READ, as that of 'Milan Cathedral' (1,605), and others, convey to us a sense of vastness which may, or may not, be maintained by the reality. After all, Mr. Read only avails himself of the common privilege of poetising his subject. The mysteries of space are also thoroughly understood by G. DODGSON, an artist who, we submit, is little understood, and much undervalued;

his works are 'The Wedding March' (2,100), and 'Woods at Evening' (1,785). There is by O. W. BRIERLY (1,594) a representation of South Sea Whaling in its most exciting aspect—doubtlessly true, but somewhat painful. E. DUNCAN'S subjects are (1,695 and 1,960) 'A Fresh Breeze—Vessels entering Yarmouth Harbour,' and 'At Stratford-on-Avon,'—the latter a production of infinite grace and sweetness. By the late JAMES HOLLAND is a rich specimen of his Venetian series, as 'A Shrine in Venice' (1,713), and others which represent him as an English landscape-painter. An 'Ecce Homo' (1,657), by W. CAVE THOMAS, is a brilliant and highly-finished drawing, having all the zest of the flowery times of the old schools; it is the property of the Prince of Wales. By the same hand there is 'Sunset on Calvary' (1,904), the lower compartment of a fresco, painted by Mr. Thomas, in one of the churches in Marylebone; and two others. 'The Fall Out by the Way' (1,999), H. B. WILLIS, a combat between two Highland bulls, is the most spirited drawing ever made by the artist. The works of G. A. FRIPP are not fewer than sixteen, bearing various dates, and representing this artist in full force. The contributions by G. J. PINWELL are already famous, as they deserve to be—being 'The Pied Piper of Hamelin' (1,736), and (1,969) 'A Seat in the Park.' Of BIRKET FOSTER'S two drawings (Nos. 1,738 and 1,973), entitled respectively 'The Weald of Surrey,' and 'Brighton,' the former exhibits most perfectly the power of this painter in reconciling detail, with a description of space and atmosphere. Of Scottish scenery two of the most interesting pieces are by W. EVANS—they are the property of the Queen—(Nos. 1,902 and 1,903), respectively 'Ferry on the Tay near Dunkeld,' and 'On the Road between the Tummell and the Tay;' and for attractive qualities the following are prominent amid their surroundings—'The Stonebreaker' (1,963), H. WALLIS; 'Uri Rostock and Lake Uri' (1,997), D. H. MACKEWAN; 'The Ore Stone Quarry, Torquay' (2,015), W. BENNETT; 'Shipping Lemons at Mentone' (2,052), W. W. DEANE; 'The Night of the Return' (2,058), J. LEECH—an illustration of 'The Battle of Life,' and also by Leech the illustrations of 'The Cricket on the Hearth' (2,089); 'Lock Eive—Moonlight,' A. P. NEWTON; 'The Grand Canal, Venice' (2,113), COL-LINGWOOD SMITH; 'The Great Exhibition of 1851' (1,560), L. HAGHE; 'Over the Moorland' (1,563), R. REDGRAVE, R.A.; 'Prince Rupert's Discovery of Mezzotint' (1,561), T. H. MAGUIRE; 'The Elopement' (1,575), J. ABSOLON; 'An Autumn Evening in South Wales' (1,590), J. H. MOLE; 'The Woman of Samaria' (1,604), H. TIDEY, and by the same, other scriptural subjects. Equal in many points to these are drawings by W. Fyfe, Madame Bisschop, C. Rossiter, J. W. Inchbold, W. R. Beverley, E. Hargitt, E. Leach, Harrison Weir, E. Hayes, R.H.A., H. G. Hine, H. Johnson, &c.; and this brilliant assemblage, does it not embody the story of the maturity of a school? We regret that our inelastic limit forbids our doing full homage, especially to those who maintain themselves with lustre unsullied in their respective spheres.

We must, however, remark that, as there are rooms set apart solely for the contributions of the works of foreign painters, we cannot understand why such pictures should have been associated with those of our own school: the arrangement is a mistake.

THE MUSEUMS OF ENGLAND,
WITH
SPECIAL REFERENCE TO OBJECTS
OF ART AND ANTIQUITY.

BY LLEWELLYNN JEWITT, F.S.A., &c., &c.

THE EXETER MUSEUM.

THE Devon and Exeter Museum is a new establishment, dating back for its foundation only a very few years; but it has already acquired many objects of great interest, and worthy of careful attention. The first attempt at forming a museum in Exeter—which city, as the capital of one of the richest and most favoured counties in England, Devonshire, ought to possess one of the best in the provinces—was made in 1813, when the "Devon and Exeter Institution" first sprang into existence. As a nucleus for the formation of a museum at that time, a number of gentlemen presented collections of objects in natural history, &c., among whom Sir Thomas Acland gave several hundred pounds' worth, which he had bought on the dispersion of the famous "Bullocks Museum" in London. These, however, through the destructive effects of neglect and insects, have been destroyed and lost. The collection of minerals not being very tempting to insects, shared a better fate, but no part of it is now in the museum under notice. In 1845 Dr. Scott publicly advocated the subject of the formation of a good Devonian museum, but with no success. In 1851, thanks to the impetus given to Art-education and other matters, by the Great Exhibition, the subject was again mooted; and, four years later, a School of Art was established in Exeter. In 1861 a determined effort to establish a museum, and to provide accommodation for the School of Art, was made; and, after the death of the Prince Consort, it was determined that the erection of the building, and the formation of the Museum, &c., should take the form of a memorial to the prince. A site valued at £2,000 was most liberally presented by Mr. Gard, and an additional plot of land of the same value was purchased, and upon this one of the finest buildings for museum and

The building is faced with dark red porphyry from the Pocombe quarries near Exeter, relieved with dressings of Bath-stone and Chudleigh limestone. The shafts of the windows are of red sandstone, from Bishop's Lydiard, near Taunton. The principal entrance is through an arcade of three arches supported on columns of polished Aberdeen granite. The ground-floor is raised six or seven feet above the level of Queen Street. The whole of the rooms are *en suite*, so as to allow of passage completely round the building on occasions of large assemblages. The Museum occupies the whole of the right-hand side of the building, the Free Library is

This remarkable cup—very similar in form to a unique gold cup from Cornwall, in the possession of her Majesty the Queen—is ovate, or bell-shaped in form, tapering downwards from the rim and terminating in a cone, so that it cannot stand. It has a handle on one side, and is ornamented externally with encircling lines, and internally with zig-zag lines. It was found in 1868, with a deposit of calcined bones, and was the only relic discovered in the barrow.

Another cup of almost identical form and size, found at Broad Down in 1870, will also be noticed. It is here engraved.

Among the Celtic pottery is an excellent example of a so-called "incense-cup," from Broad Down, but which is probably, as I have already on various occasions had occasion to state, a small cinerary urn, for the reception of the bones of an infant, to be buried in the larger urn with those of its mother. It is 2 inches in height, and 3 inches in diameter, and ornamented with upright bands and horizontal lines of zig-zag ornament, and has, as is not usually the case, two small perforations on one side. This will be found among the engravings on the following page.

There are some exceedingly good cinerary urns and drinking-cups of the usual forms, which are well worthy of careful attention, for comparison with examples from other localities. These are from barrows at Broad Down, Farway, near Honiton, Nymet Tracey, near Crediton; Pynes, near Exeter; Northam, and other localities in the county.

Belonging to the same period are some remarkably fine bronze celts, palstaves, daggers, &c., from Rockbeare, Drewsteignton, Plymstock, South Petherton, Honiton, Broad Down, Pynes, &c. Also several good implements of stone and flint, including a celt of greenstone found at North Bovey, and some sling-stones and "thumb-flints" from Broad Down.

Among other bronze implements, three sword-blades, found with others during draining operations in a meadow at Talaton belonging to Sir John Kenaway, Bart., not far from the Roman Road, are especially worthy of examination. They have been most ably described and illustrated by Mr. Charles Tucker, F.S.A., to whom Devon-



DRINKING-CUP OF KIMMERIDGE SHALE.

located on the left, and between them, at the back of the building, are the Class-Rooms of the School of Science. The Library contains about 10,000 volumes of books, the greater portion of which were transferred to the Institution from the Public Select Library, which was established in 1808, and, until March, 1871, was located in Bampfylde House.

Among the more important objects of Art and antiquity preserved in the Museum, are many which deserve especial notice. And first it may be as well to call attention to the fine statue of the late Prince Consort, in his robes as Chancellor of the University of Cambridge. It is the work of Stephens, and is considered to be one of his best productions. Another Art-feature in the Museum is a collection of proofs of engravings, by Samuel Cousins, R.A., a native of Exeter, which have been presented to the institution by the artist himself, and by Mr. Graves, the publisher. In the class-room is Cross's picture of 'The Burial of the young Princes in the Tower.' The first cast from the original model by Belmes, for the statue of Sir William Follett, in Westminster Abbey, presented by his brother, is also worthy of special note. There are also some marble busts, medallions, and other Art-objects.

The especial antiquarian objects are the splendid series of Celtic remains from Tumuli, on Broad Down and other localities, exhumed by that learned and energetic archaeologist, the Rev. R. Kirwan, through whose exertions they have been placed in the Museum. Among these remains are some of extreme rarity, while others are at present unique. One of the most curious is the drinking-cup of Kimmeridge shale, 3½ inches in height, and 3 inches in diameter at the mouth, which is here engraved.



DRINKING-CUP OF KIMMERIDGE SHALE.

Art-purposes in the provinces has been erected, from the designs of Mr. John Hayward, at a cost of about £15,000. The building, which is of Gothic character, contains, besides the ample space afforded for the Museum, a School of Art, a Free Library, a Reading-room, with class-rooms and apartments for curators, masters, and others.



CINERARY URN, BROAD DOWN.

shire is much indebted for the elucidation of some of its antiquities.

Among other Roman remains may be noted "two volutes of an Ionic column, dug up at the corner of Queen and Paul Streets, Exeter," in the course of excavations in connection with the Museum; some fragments of Samian ware also discovered on the site of the Museum, one of

which bears the potter's mark, P-E-GEMIN-M; and other Samian ware, and pottery of various kinds, from other parts of the city, including an interesting *terra-cotta* lamp from St. Sid wells.

A bronze figure, or rather, group of a centaur and other figures, is "supposed to be the head of a Roman standard belonging to the second legion of the Emperor Carausius;" it was found on the beach at the mouth of the river Sid, at Sidmouth, and is conjectured to have fallen down from the camp on the heights above. The group is 9 inches in height, and is much mutilated; it rests upon a socket, into which a shaft has originally been fixed.

Other relics of the Roman occupation of Devonshire, including coins, paving, draining, and roofing tiles, leaden pipes, fibulae, &c., will be found in the collection.

A curious local relic is a "bifontal bust of Isis, in grey freestone, glazed over," which was dug up in Bel Hill, Exeter, in 1833. This interesting head—which is, of course, Egyptian—is 3 inches in height, and has the face of the goddess on each of its two sides, with lines of



BRONZE DAGGER, BROAD DOWN.

hieroglyphics. It, as well as the bronze centaur, has been figured by Captain Shortt.

There is also a collection of articles, including fragments of pottery, flakes of flint, antlers of the red-deer, teeth and bones of the extinct Irish elk, ox, boar, goat, &c., from the submerged forest at Northam, in North Devon.

Two querns, dug up on Torr Farm, Chagford, are deservedly worthy of notice; as are also several other somewhat similar objects found in the county.

Among the mediæval pottery are two "Sack Pots," dug up in Queen Street; and a Bellarmine, found in the Close, Exeter. There are also several interesting examples of encaustic paving tiles, discovered in Exeter. Among other local relics—and to these it is always well to direct especial attention—the following are extremely noteworthy:—

Three ancient measures of the city of Exeter: the first bearing the inscription, "Elizabeth Regina 1601;" the second bearing the inscription, "An Ale Gallon sized and sealed in the Tower of London by me John Reynolds of the Mynt Anno 1653;" and the third bearing the words, "Peck—Coal Measure—City of Exeter." Also a 14 lbs. weight, of bronze, of the time of Henry VII.

A curious assemblage of instruments of obsolete punishment, connected with the city, are,

a Brank of remarkable construction, the lower part, covering the mouth and chin, being a perforated plate, from the inner surface of which the gag projects as usual. The only example of analogous form that has come under my notice is the one engraved on page 71, vol. i., of "The Reliquary." The example in the Museum is supposed to have been brought from the old gaol of Exeter, and to have been used for refractory prisoners. A spiked Anklet, said to have

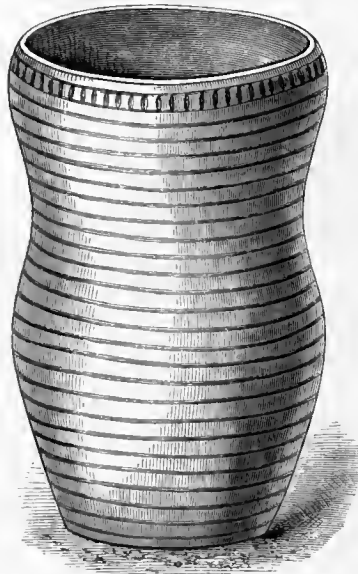

DRINKING-CUP, BROAD DOWN.

come from the same place, which consists of a ring of iron opening on one side by means of a hinge, and clasping and locking on the other, so as to fasten it on to the ankle, and having four long and sharp spikes standing out from its outer surface. A "Waist-iron"—a strong oval ring of iron, opening, clasping, and locking—for encircling the waist, and thus to chain up its unfortunate wearer. A Thumb-screw of powerful



BONE BEAD, BROAD DOWN.

construction. There are also some Handcuffs, and other singular relics.

A sacramental flagon, of pewter, formerly belonging to the parish of Rew, bearing the following inscription:—"This was provided by Frederick Wyome for the Parish Church of Rhiw AD 1662."

A cast of the head of the effigy of James Lord Audley, which was dug up in 1826 on the

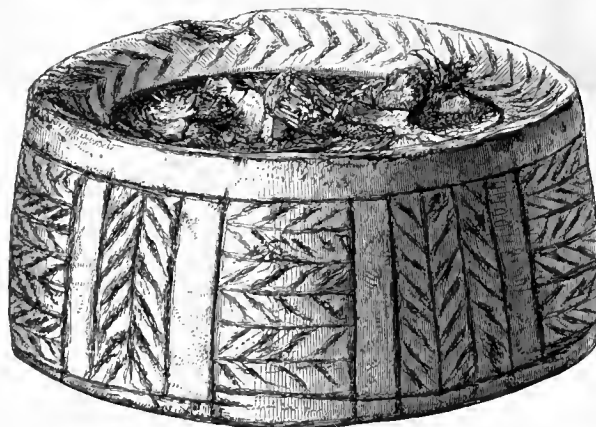

SO-CALLED "INCENSE-CUP," BROAD DOWN.

site of the Dominican Convent, now Bedford Circus—the effigy itself being, it is understood, in the possession of the Mayor of Exeter, by whom, it is to be hoped, it will be placed in the Museum.

A very interesting object is the model of a well of curious construction, in the parish of St. Sidwells, Exeter, anciently called Hedwyllmede, which has been very carefully examined and described by Mr. Tucker. Beneath the stone resting on the sand-rock at the bottom of this well, a coin of Nero, in fine preservation, was found.

Of Egyptian antiquities, besides the head of Isis already spoken of, the Museum contains "the mummy, coffin, &c., of An-st-shu-mut, a priestess of Amun-Ra, perhaps as early as the nineteenth dynasty (B.C. 1464), the hieroglyphics on which are well preserved." It was brought from Thebes in 1819 by Rev. Fitzherbert Fuller. Also a mummy, with coffin and cover, of a man named Amenhetpai, preserved by the wax process. This interesting example was brought from Egypt by H.R.H. the Prince of Wales.

Among the Peruvian antiquities are several curious facial and other grotesque vessels from the tombs of the Incas, near Truxillo; and an assemblage of curious remains washed out of a grave at Arica by the earthquake-wave by which the city was destroyed. Among these is an awl made of human bone, a fishhook and sea-weed line, and other objects. From New Grenada are also some highly interesting vessels, including a large bottle in fine preservation, a jar, a very curious clay cup, a spindle-whool, and other articles.

One very attractive feature in the collection,



BRONZE CELT, BROAD DOWN.

which it would not do to omit to mention, is the fine collection of ancient lace, both Devonshire and foreign, which has been most liberally presented to the Museum by Mrs. Bury Paliser, the best living authority on the history of lace, and to whom the Devonshire lace-makers owe so much for the interest she has taken in this the legitimate Art-manufacture of the county, as an addition to the gift of Mrs. Treadwin, of Exeter, who most liberally presented some marvellous examples of modern skill, among which is the lappet, so much admired at the Great Exhibition of 1851.

Besides these the Museum contains all the usual features of such institutions in "foreign curiosities," and objects of natural history, &c.

The entire collection is under the able directorship of Mr. W. S. M. D'Urban, to whose energy it owes much of its success. It is to be hoped that so excellent an institution, which has been commenced with such a good spirit, and carried on in so liberal a manner, may meet with continued and increasing support, and may become, what it bids fair to be, one of the best of provincial institutions, and one which shall be in every way worthy of the beautiful county whose history, arts, and antiquities it is intended to illustrate.

THE ROYAL INSTITUTE OF BRITISH ARCHITECTS.

THE President and Council of the Royal Institute of British Architects gave their annual *conversazione* at their rooms in Conduit Street, on the 29th of June. The gathering was numerously attended, and the arrangement, lighting, and adornment of the apartments gave great satisfaction to the guests. The band of the Coldstream Guards was in attendance, and performed a selection of admirable music in the lower gallery. The supply of ices, fruits, and sherbets, did great credit to the hospitality of the entertainers, and was especially welcome on the occasion of the first real summer-evening of the year.

The lower gallery was adorned with the collection of French marbles, bronzes, *terra-cottas*, and other works of Art, for the display and sale of which M. C. de Marnihac has engaged the room until October. Among these were especially to be admired several statuettes in *repoussé* silver; works at once precious, substantial, and elegant. The metallurgical skill displayed in the soldering together of the different portions of these figures by joinings, which are almost everywhere imperceptible, is of the highest order. There were several of the beautiful bronze reductions of antique statues, of which M. Barbedienne has so fine a display at the International Exhibition. Numerous copies and reproductions of the works of Clesinger and other modern French artists were remarkable for the purity of the marble, no less than for the beauty of the work. A little group of a nymph and a satyr is especially charming. Compound busts in bronze and Algerian onyx are also displayed, together with a bas-relief in painted marble—of which the less said the better. A combat between two bulls of the antique Roman breed, by Clesinger, in red marble, is a perfect marvel of execution, both as to spirit of design, and delicacy of detail.

The larger reception room, and other apartments on the first floor, were adorned as usual by loans from various contributors. Some very good Japanese chinaware came from the show-rooms of Messrs. Farmer and Rogers, including fine specimens of Satsuma ware, examples of old *cloisonné* enamel, of brilliant red and gold lacquer, and the most impossible and ferocious monsters in bronze. There was also a collection of modern majolica, painted by Mr. W. S. Coleman. Some of these are hand-painted, others are partly produced by mechanical aid. A large *plateau*, of a deep yellow, on which a brilliant Oriental butterfly is displayed on a spray of foliage, and a small grey plate, with a lovely "blue bird," were particularly admired. Of course, there were samples of Salviani's glass; including mirrors of which the frames, as well as the plates, are composed of this lustrous material. Messrs. Salviani, moreover, exhibited some modern Italian majolica, giving very accurate reproductions of *renaissance* forms, which deserve more attention than they have yet received. Mr. Peacock exhibited a series of ivory carvings, two of which were remarkable for the size of the block, as well as for the boldness of the relief. These represent the uplifting of the brazen serpent, and the descent of Moses with the tables of the law. A Hercules and Hebe formed the subject of another *plaque*, boldly treated, and an Anthony and Cleopatra had almost the finish of stone cameo-work. There was also a curious antique *triptych*, containing an alabaster Madonna, very early work—said to be from a nunnery near Worcester. A cup, covered with the triumph of Cleopatra, was the most noticeable of the ivories. There was a very curious bas-relief in marble—an Oriental scene with a female near a bath, and a royal personage close by. A collection of Saxon and Roman weapons, chiefly from the Thames, contained some curious arrow-heads, spirally finished, or *rifled*. Among the pictures we noticed a fine group of cedars, by MacCullum, and a dreamy-looking 'Music' by A. Pio. The contributions, as a whole, were of great and varied interest.

CORRESPONDENCE.

To the Editor of "THE ART-JOURNAL."
CIRCLES IN PERSPECTIVE.

SIR,—To the question proposed by "J. T." in your last number, I beg to offer the following answer. The perspective representation of every circle is a regular ellipsis when the eye is without the circle, which may be demonstrated by considering that the rays from the circumference of the circle to the eye form an *oblique cone*. But it is well known to those who are acquainted with conic sections that every section of a cone, whether right or oblique, is a true ellipsis, except in one case only, which is when the section is taken sub-contrary to its base, a situation which happens so rarely in drawings that it may be disregarded altogether, and the section of a cone, or the perspective of a circle, in all cases considered as an ellipsis.

The figure below represents the easiest method of finding the perspective of a circle in *oblique* perspective:—

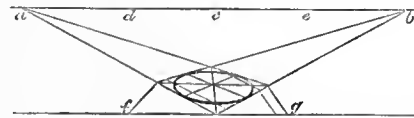

ab is the horizontal line, c the centre of the picture, and de are the distance-points. The several divisions of the reticulated square are laid upon the ground-line fg , and from these, lines are drawn to the distance-points. The perspective of the square is then drawn with all the lines across it, and the curve traced through the different points.

E. C. LEFROY.

TEACHING DRAWING.

SIR,—Having for some years taken great interest in the promotion of Art, I was glad to see in the report of a recent meeting of the London School Board, a proposition that Drawing should be one of the subjects taught in elementary schools. Would it not be a good opportunity for the Science and Art Department to use its influence to get this proposal carried into effect, so that the country might have a real national School of Art, and not the semblance of one? This, I venture to say, will not be the case until Drawing is universally taught as a branch of education, as it is in Germany. Although large sums of money are paid for teaching Drawing, both in our national and private schools, we have little or no results; and this cannot be otherwise so long as it is looked upon "only as an accomplishment."

It is the fashion to blame the Drawing-master for the bad system of teaching usually practised, but it is not his fault: he would carry out a thoroughly sound course of study were it possible. The parents want a "show," and the pupils will not learn if the master insists, and so he is at their bidding, or "his occupation's gone." Most school-masters look upon Drawing as a troublesome study: in fact, they consider it interferes with the legitimate work of the school, and so the lesson must be given in play-hours. The money paid for such lessons as these is very badly invested; it cannot be expected that much real work will be got out of a boy in his play-hours. Moreover, it is a common practice to keep a boy from his Drawing as a punishment for failure in other lessons! The Drawing-master cannot complain to the principal, as it is his order; and certainly not to the parent, for that would be a dire offence; and thus from one cause and another the study of Drawing in this country is up-hill work. I will give an illustration. The other day, visiting a friend whose daughter had just "finished" her education at a fashionable "Ladies' College," and was supposed to have great talent for Drawing, I was shown some of her paintings, which at the first glance I thought very good and clever; but closer examination showed them to be only tinted lithographs! The shaded

Drawing is given to the pupil, who tints it from a copy, and this is put forth as "her drawing." A label at the back (which had been carefully pasted over with paper) gives the following: "Drawing Copies specially adapted for Holiday Specimens. No. — by ——" It is, I think, hardly possible to conceive anything more injurious to the mind of a young person than such a dishonest practice as this, and it should be exposed and deprecated by every one who takes an interest in Art.

AN ART-TEACHER.

SOUTH KENSINGTON MUSEUM. SCHOOLS OF ART.

THE annual distribution of prizes for the works sent up from the Schools of Art took place on the 6th July. H.R.H. the Princess Louise intended to preside, but was unavoidably detained elsewhere at the last moment. The examiners were—Sir R. D. Wyatt; Messrs. C. W. Cope, R.A.; R. Westmacott, R.A.; R. Redgrave, R.A.; F. R. Pickersgill, R.A.; J. C. Horsley, R.A.; H. A. Bowler, and J. H. Pollen. Nine gold medals, twenty-four silver medals, sixty-five bronze medals, and ninety-five prizes of books were awarded. A selection from the works sent for competition is exhibited in one of the eastern galleries of the South Kensington Museum, adjoining the room containing the Elcho Collection of Pictures. It is matter for congratulation that, of the above marks of distinction, one gold medal, seven silver medals, twenty-one bronze medals, and thirty-one prizes of books were carried off by female students.

The general display is such as to show a decided advance on the works of previous years, and that almost, without exception, in the different branches of education. In one group of drawings—namely, the coloured studies of natural objects—the practical skill arrived at is often of a high order. It is true that this is but an inferior grade in Art, yet it is one highly important to master. Some of the drawings of fruit, flowers, and dead life, are undeniably superior to many that have been exhibited during the present season at the water-colour exhibitions, and at that of the Royal Academy. This is not, perhaps, a matter upon which to congratulate the world of Art, but it is highly creditable to the youthful artists and to their teachers.

Some alteration appears to be requisite in the mode of distributing the gold medals. The number of works selected for the national competition was 64,608. These are divided by the examiners under the heads—of studies from the antique; designs for architecture or manufactures; and studies in light and shade, colour, or from the life. This classification would give six branches of Art-education in design. The number of gold medals usually given is ten. In the present year two gold medals are awarded for models from the antique, one for a model from life, two for designs for lace-curtains, one for a design for a decorated ceiling, one for an architectural design for a church, one for a design for a set of jewellery, and one for a group in water-colours. This disproportionate allotment tends to invalidate the distinction attached to the medal. Thus the sepia drawings of a decorated Gothic church, while highly creditable for a young student, involve the sense of absurdity when we find them to be selected from among 64,000 drawings, to be rewarded with one of the nine gold medals. There is nothing in the design to justify such a species of national distinction. Even the grace and beauty that might have been added to the building by the obvious expedient of varying the tracery of the windows, which any Gothic architect would have done, is neglected, and the same stiff trefoil recurs in every pointed arch. Architecture has always been an extremely weak point at South Kensington, and such an award as this calls pointed attention to the fact. Again, the design for a set of jewellery is not one that would have received applause, to say nothing of a gold medal, from practical workers in gold and enamel. The design, rough as it is, is not without merit, but the amount of labour involved

in the application of the enamel is out of all proportion to the effect produced. The main form of ornament, a flat cup, containing a ball surrounded by rays, is somewhat heavy; the whole effect is that of unmeaning prettiness. With the richer specimens of ancient goldsmith's work now accessible, especially referring to those from Denmark, it is altogether out of the question to give such high distinction to a design like this. The design for the decoration of a ceiling, though rough and unfinished as a drawing, has much richness and harmony. It will, no doubt, come out well in plaster. The lace-designs are very graceful, especially that by William Butler, of Nottingham. But while too large and outspread for lace proper, they would prove far less effective for window-curtains than something in a bolder style of work. G. F. Munn's figure from the antique is a miniature model of the well-known Farnese Hercules. In receiving this figure as a model, the students should be distinctly taught that, notwithstanding the great skill displayed in its manipulation, it is a work dating during the decline of Art. One main defect of the original marble, the disproportionately small size of the head, seems exaggerated in the model. Of the model from life we are happy to speak in terms of the highest encouragement. It is a statuette representing Samson in the act of bursting his bonds. The artist has been unusually happy in the choice of a model—the figure possessing the full vigour of manly strength displayed, without exaggeration, or the introduction of supplementary and imaginary muscles. The legs are very admirably modelled, the pose is expressive, escaping, although only just escaping, that want of balance which is destructive of sculptural beauty. The sideward sway of the figure, and the return of the clenched right hand towards the head, give the effect of motion without wearying the eye. The figure is a credit to Mr. James Robertson, and to the Edinburgh school. Miss Rosa E. Stanton, from the Stroud School, has a gold medal for a brace of dead partridges, lying on moss and leaves, in which the ruffling of the plumage seems to have been done by the wind itself. How it is that one of the gold medals has not been given to Miss Montalba for her charming design for a majolica *plateau*, we are altogether at a loss to conceive. It is a proof that eight good judges do not constitute an unerring tribunal. This design has every quality that should have recommended it for distinguished reward. It is intended for the service of ceramic industry, in the purely mechanical part of which we are now in advance of nearly the whole world, and in the Art-department of which original grace and beauty are so eminently desirable. It is good in drawing, happy in subject, and harmonious and appropriate in colouring. A very pretty village-maiden, with an earthen pitcher in one hand, and a reed or bull-rush in the other, is tripping down to a stream, her slender weapon being assumed to awe a flock of uncivil geese. Around the edge of the *plateau* is an arabesque, lighted up by charming birds and beasts, a ferocious and terrible dragon, and delightful little gnomes in long pointed hoods. The drawing is not a copy of a piece of majolica, but a design for reproduction. It is, therefore, properly drawn with a clear and definite pencilling. It is possible that the artist may not possess the rare power of the faultless and rapid touch requisite for painting on wet enamel. But the design, properly reproduced, would give a *plateau* of which Minton or any other potter might be proud. The great superiority of the Belgian artists over our own in this especial department, which comes into such strong relief in the International Exhibition, is an additional cause for lamenting this unaccountable injustice to Miss Montalba. Mr. Robertson's Samson, and Miss Montalba's *plateau*, are decidedly the most original and satisfactory designs in the entire exhibition.

Among the other drawings attention is due to Miss Emily Austin's fruit in water-colours, a bunch of apples stippled in with a touch like that of crayon. Mr. F. E. Bodkin's monochrome painting in water-colours of a colossal barbaric head from the antique, does honour to the South Kensington School. This fine subject is one very frequently repeated, and in this

instance is rendered with great beauty. J. Chanwell, of Bradford, has a shaded ornament, drawn from a cast, with an admirable and masterly touch. John H. Park, of Coventry, gives a very rich and harmonious design for a carpet—a pale crimson centre and delicate white corners. Mary E. Southworth, of Manchester, has drawn an exquisite group of convolvulus. Peter Smart, of Aberdeen, is very successful in his monochrome drawing of an acanthus ornament from the cast; and William Stevenson's model from life—a young man about to bathe—is highly promising, and shows much real sculptural feeling. Each of the above productions is justly rewarded with a silver medal.

Among the bronze medallists are especially worthy of note Agnes Keeling, of Lambeth, for her design for lace, which is not a puzzle put together, but a graceful and harmonious conception. W. C. Little, of South Kensington, has a good head from the antique. Julia Pocock, of Bloomsbury, has given a model of a head from life, in which, while the hair is somewhat "sketchy," the definition of the features, the physiognomic expression of the face, and the delicate modelling of its slightest traits, deserve very high praise. H. Stade, of Bradford, gives a set of designs for plates,—gorgeous and well-painted birds,—which are admirable both in choice of subject and in execution. We should like to know for what reason the exquisite bunch of purple grapes, a portion of which fades into a deep shadow that might have been cast under an Italian sky, painted by Mary Wedd, has been omitted from the medalled studies.

The point in which the exhibition is weakest is in the want of feeling for the antique displayed in most of the models from ancient marbles. We strongly suspect that this portion of study should be postponed till after some proficiency has been attained in modelling from life. Almost every Greek or Roman face attempted has more or less English features. Notwithstanding some minor details deserving criticism the entire exhibition is a decided success.

SCHOOLS OF ART.

LEEDS.—Mr. Walter Smith, head-master of the Leeds, Bradford, and Wakefield Schools, is about to leave this country for the United States. Some time since he was invited, on the recommendation of Mr. Henry Cole, at South Kensington, by the State-education authorities of Boston, in America, to visit that city for the purpose of advising on the best means of establishing a training-school for Art-masters; Art-schools, and a museum of Art-works throughout the State of Massachusetts; an act having last year passed the legislature of that State decreeing that drawing should form part of the education of youth. At the close of the visit liberal offers were made to Mr. Smith by the authorities of Boston to induce him to take up his residence in the city, and personally direct the whole Art-education of the State: this, after due consideration, he has acceded to. His position in the State will combine the offices of Chief State Inspector of Schools of Art in Massachusetts Commonwealth; Head-Master of the Normal Training-School for Art-Masters, in connection with the Museum; Professor of Sculpture, and Art-Lecturer. It is stated, in a Leeds newspaper, with reference to this matter, that a subscription was made among the workmen in one Boston factory, after an address by Mr. Smith, of no less a sum than £300 to aid in the establishment of a museum in that place.

GLOUCESTER.—The foundation-stone of an edifice intended to include a school of Science and Art, and a Museum was recently laid in this city; it is estimated to cost £5,000. A School of Art has existed here for several years, and has flourished under the able direction of Mr. Gambier Parry; and a kind of museum has also been got together in rooms lent by Mr. Sydney Dobell; but both have overgrown the dimensions to which hitherto each was limited; hence the necessity of a new building.

ART IN SCOTLAND AND THE PROVINCES.

GLASGOW.—A very ingenious piece of work has recently been exhibited in this city: a model of Jerusalem (with the surrounding country) as it is supposed to have existed in the early Christian days. The different sections of the city are distinctly marked out; and while the streets and bye-ways are set forth with wonderful *minutiae* of detail, the various public buildings are carefully elaborated. We have all the localities with which Scripture has made us familiar: Mount Moriah, the Temple of Solomon, the palaces of Herod, Queen Helena, and of Caiaphas; the houses of Pilate, and Annas, and many more; the splendid arched bridge leading along the Via Dolorosa, and so through the Gate of Judgment to the scene of the Crucifixion. We have Calvary and Gethsemane, the Valley of Jehosaphat, the brook Kedron, the Mount of Olives, the Pool of Siloam, the tomb of David, and, in short, a complete concentration of all those hallowed spots so interesting to the thoughtful mind. The entire fabric is of wood, covering an area of 144 square feet, weighing about 12 cwt., and is divided into nine sections; the largest requiring four men to move it. The whole has been skilfully coloured by an artist named Speirs, and the result is picturesque and natural. The author of this rare construction is a common working joiner in Glasgow, who has devoted the leisure of the last twenty-five years to the formation of his pet design. He is the eldest son of Captain Dumbreck, R.N., deceased, who fought at Trafalgar. Mr. Dumbreck illustrates his model every evening by a descriptive lecture, to which he gives considerable zest by his enthusiasm as well as by the knowledge displayed of his subject, gathered from Holy Writ, Josephus, and other historic sources.

BIRMINGHAM.—The Spring Exhibition of the Birmingham Society of Artists has closed satisfactorily to those most concerned in its success. The sales effected show an increase of £441 over those of last year, having amounted to the sum of £1,859, 16s.; the attendance of visitors was also considerably greater. The largest sums realised were for Birket Foster's 'Crossing the Ford,' 370 gs.; for S. Bough's 'Cadzow Forest,' 100 gs.; and for W. H. Vernon's 'On the Ogwen, North Wales,' £50. The total number of drawings sold was 130; a small proportion, however, to the number exhibited—upwards of 600. The purchases made by prize-holders of the Birmingham Art-Union showed a falling off in value of £75.

BLACKBURN.—Mr. Fairhurst, a monumental sculptor in this town, has presented to the Corporation a piece of statuary, executed by the workman in his employ, at his own expense and under his own direction, for erection in the park.

BRIGHTON.—The town-council has resolved by a large majority of votes, to erect a building for the purposes of a public museum, library, and picture-gallery. It is scarcely creditable to the inhabitants of so large, influential, and wealthy a town as Brighton, that such an institution was not in existence long ago.

EXETER.—In the course of some repairs recently undertaken in the Lady Chapel of the Cathedral, a fine example of early fresco-painting was brought to light on one of the walls. The picture represents the Virgin surrounded by a *nimbus*; two angels are placing a crown upon her head, while other angels are present, with an outer circle of figures—kings, queens, and saints—surmounted by Cherubim and Seraphim in the act of adoration, and bearing scrolls inscribed "Dominions, Principalities, Thrones, Powers," &c. From what can now be seen of the painting, it evidences good artistic treatment, and much richness of colour and detail; but it happens, unfortunately, that the lower and larger portion is concealed, or rather has been destroyed, by a monument placed against the wall about two centuries ago.

PLYMOUTH.—A statue of Sir Francis Drake, the famous admiral and circumnavigator of Queen Elizabeth's days, is to be placed over the municipal offices of the new Guildhall in this seaport.

THE NATION OF SHOPKEEPERS.

It might be hardly necessary for us to revert to a subject on which the last word has been said in our pages, were it not to defend a meritorious body of men from the covert satire of the member for Cambridge University. That honourable member gave vent to a well-merited indignation by saying that the treatment of Mr. Barry by Mr. Ayrton was such as not only to justify the assertion of our continental neighbours that the English were a nation of shopkeepers, but to show that we had placed a shopkeeper at the head of our governmental department of Art.

On behalf of all those who honestly and industriously live by trade, from the *millionaire* merchant down to the itinerant vendor of matches, we enter a protest against this most depreciatory remark. No doubt there are shopkeepers and shopkeepers—and there may be those of the latter who, finding themselves unexpectedly set on horseback, ride gallantly—we all know where. But, as a rule, proper respect to public decency,—appreciation of, and care to provide for, the public taste,—avoidance of any cynical and unblushing display of their own defects of education, of temper, or of good feeling,—a disposition not unnecessarily to wound the feelings of the more cultivated of their customers and paymasters,—readiness to obviate all just causes of complaint,—that decent social modesty which is demanded by civilisation,—these are the attributes of shopkeepers. Indeed, in the absence of any such qualifications, small would be their custom and scant their profit. It is therefore evident, and will, we doubt not, be admitted by Mr. Beresford Hope, that we cannot be said to have a shopkeeper at the head of our office of works. The more the pity. It would be a very inferior and ill-judging shopkeeper who, while vulgarly sneering at one of our most interesting architectural gems as a vault, and expressing his idea that the Reformation had put a stop to the old Christian custom of naming churches after some dedicatory saint, should go on to state publicly that a piece of work had cost exactly fifty times as much as was really the case. This is a very cheap and easy method of obtaining a spurious credit for economy.

The importance of the subject is far greater than may appear at the first blush. Under the peculiar nature of our parliamentary party government, it has not infrequently happened that a totally unprepared, or even a very unfit man, has been placed in a post of ministerial power. That the selection of a man, fitted by antecedents and by education to direct our army, our navy, or our home affairs, is a duty demanded by even the slightest sense of patriotism, has not yet been made a point in our political catechism. Party first, country afterwards, is an old rule, only rendered tolerable by the excuse that it is by party discipline alone that the country can be governed. But then we have had the safeguard that the persons thus selected by lot are, as a rule, English gentlemen. A certain large conscientiousness comes in to the aid of an imperfect choice. The man who is made a minister has usually a sense of the responsibility of his position, which prevents him from exposing his ignorance of any special duty, and induces him to go to work in earnest to fit himself for his post. Late enough no doubt, but better late than never. The main point is, for the incoming ruler to feel his own defects, and the probability then is that he will be on his guard against their evil.

But when, for the first time, we see not only a thoroughly incompetent person, but one who actually glories in his incompetence, appointed to any public office, we see a great blow dealt at the permanence of our national institutions. Such an appointment, especially when persevered in after its mischievous tendency is apparent to all non-party men, is a step down hill. Who is dragged down may be a question, but, any way, the country suffers. The next thing to a public depreciation of our great national monuments, will be the neglect or the falsification of our history. Why should room that might be let as shops and warehouses, to the receipt of a large annual income, be devoted to

keeping up fusty records or old-world pictures? St. Paul's is far too large for a church—why not sell it for a central railway-station? Turn out the old clips and bones from the British Museum, and we shall have space for an excellent hospital. As for South Kensington, to the hammer with it at once! If these measures are not proposed by those who condemn the vault at St. Stephen's, at all events it cannot be because they would seem to such persons to be inconsistent or unfit.

ART IN CONTINENTAL STATES.

BERLIN.—The colossal statue of the Prussian King, Frederick William III., of which we have lately heard much in association with the triumphal entry of the German troops into Berlin, when it was unveiled, is the work of Albert Wolff, one of the ablest pupils of Rauch. It is an equestrian group, and represents the monarch extending his right hand, as if in the act of pronouncing a blessing on his people: he wears the uniform of a General, with cocked hat and flowing cloak, the latter being extended by the stepping action of the horse. The group is bronze, and is reported to be noble in character and very imposing in its general aspect.

DRESDEN.—The exhibition of works by Holbein, postponed last year in consequence of the war between Germany and France, is now announced to open on the 15th of the present month, and to continue till October 15th. It is referred to more in detail on a subsequent page.

MEISSEN.—A party of artists, literary men, and others left Dresden for this picturesque small town, situated on the Elbe, on the 25th of June, to celebrate the fourth centenary of Albert Dürer. After listening to a selection of sacred and classical music in the old church, the visitors proceeded to the banqueting-hall in the schloss, where a feast was provided, and speeches were delivered by Professors Hübner and Gruner, of Dresden. In the evening a short dramatic entertainment, called "Albert Dürer's Birthday" was given by the artists present; a dance and fête concluding the day's enjoyments. The streets of Meissen and the banquet-hall were decorated with pictures illustrating scenes in the life of the famous old artist of Nuremberg.

MONTREAL.—A very characteristic bust of the late Bishop Fulford, of Montreal, executed by Marshall Wood, has recently been placed in the vestry of Christ Church Cathedral, in this city.—Mr. Wood's statue of the Queen is to be erected in Victoria Square.

PERU.—An international exhibition is to be held in Peru in December—the first of the kind in South America. The chief prize of honour, to be competed for by both Peruvians and foreigners, consists of a gold medal of £200. The next is a prize of honour for foreigners, consisting of a gold medal and £100.

NEW YORK.—The Scottish Societies of this city have resolved to erect a statue of Sir Walter Scott in the Central Park, and have arranged with Mr. John Steel, R.S.A., of Edinburgh, for a bronze copy of the marble figure in the Scott Monument, Princes Street, Edinburgh. Mr. Steel will design and supply a pedestal of Peterhead granite on which the statue is to be placed.—A statue of Professor Morse, "the father of Telegraphy" in the United States, was unveiled before a large assembly, on the 10th of June, in the Central Park, Mr. Morse himself being present, and manipulating, on a telegraphic apparatus which was brought to the platform, the following message:—"Greeting and thanks to the telegraphic fraternity throughout the world. Glory to God in the highest; peace on earth, and goodwill to men." Our readers will probably remember, that in describing the statue "The Genius of Electricity," published last year in the Journal, we gave a short notice of Mr. Morse, more especially with reference to his early career as an artist, especially in England. The Professor is now eighty years of age, yet still retains all his faculties, mental and bodily, in much vigour.

SKETCHES IN THE FAR EAST.

H.R.H. THE DUKE OF EDINBURGH, in a cruise of some two years' duration through all those eastern shores and islands which are accessible to a British man-of-war, had taken the wise and salutary precaution of including an artist among the small party of his attendants. M. Chevalier, who is, we believe, a Swiss by birth, had charge not only of the journal of the voyage, but of the graphic delineation of many of the most exciting scenes and incidents which it afforded. Hastily thrown on paper, as was unavoidable, these sketches form a very faithful record, and the lifelike presentation of many quaint instances of Oriental habit, and the scenery of some of the most glorious landscapes in our planet, possess unusual interest. It is much to be desired that extracts from the journal, illustrated by a selection of the sketches, should be published at once. The new gelatine process will allow of the reproduction of the drawings at an almost nominal cost; and the work, if edited by competent literary skill, would be an enduring monument of a tour which is of happy political augury, as well as a real outcome and evidence of the mode in which members of the Royal family exert themselves to keep in the van of the stirring life and improving culture of the day.

India and Ceylon, Australia and New Zealand, China and Japan, and the romantic group of the Sandwich Islands, furnish the greater number of the sketches which we have had the privilege to examine. We will not attempt an orderly account of some 125 drawings, not yet catalogued or described, but note those which most struck our attention in a walk round the studio, accompanied by the courteous and intelligent artist, whose interest in his work, and ready explanation of the scenes and incidents illustrated, added in no small degree to the pleasure of the visit.

Among the first of the sketches that meet the eye are one or two taken in Hawaii, where the European, almost English, character of the dress of the white natives, their bonnets, and parasols, and donkeys, might have illustrated a summer holiday on some Welsh or Irish coast. On the contrary, the stern grandeur of the granite peaks of the mountain in Tahiti called the Diadem, soaring to upwards of 9,000 feet, and viewed from the shore of Papiiti harbour, where Captain Cooke first landed, far exceeds that of the scenery in our own islands which most nearly approaches it—namely, the wild hills about St. Davids, in Pembrokeshire.

Next is one of the most remarkable and puzzling architectural relics in India—the ancient Hindoo Temple at Gaur. This city, near Patna, in Bengal, was the most ancient capital of Benares. The date of the temple is stated positively to be anterior to the Christian era. Yet the vaulted nave might have been reared by a Gothic architect—the form of equilateral spherical triangle, prevalent with us in the time of King Henry III., being regularly maintained in the arches. All that can be learned as to this most important building is of the utmost interest. Then we come to a very lifelike sketch of the *Galatea* at anchor in the port of Cheefon, surrounded by a swarm of tossing bumboats. Again, we are shown the dusky population of Ceylon pouring forth to greet the son of the English Queen—the roads spanned by flowery triumphal arches. Then comes a banquet at Singapore, and a festive scene by night, lighted up by torches and fireworks. Again, we are led into the presence of an antique Buddhist temple at Kandy, in Ceylon; the very *sanctum* of that ancient faith, where a tooth of Buddha himself is preserved as a relic, hidden under seven concentric golden bells. Hard by is a view of the lovely double bay in Ceylon—the nearest European approach to which is to be found in the bays of Sorrento and Salerno, or the double harbour of Brindisi. Then we have a state reception at Tahiti. The Duke of Edinburgh sits on a chair of state to the right of the Queen, attired in what is a state dress, but what resembles one of the summer ornaments of our fireplaces, made of strips, or rather rags, of the delicate transparent membrane of the cocoa-nut; a perfect pyramid of

offerings, chiefly garlands and fruit, is piled up before the royal pair. Then we have a series of sketches illustrating a tiger-hunt, from the start of the party in early morning, to the bivouac at night. The military form in which the solid line of elephants wheels round the wounded prey is very striking. Some sketches illustrative of animal life are executed in sepia, now commonly used for architectural designs, with very happy effect. The Pah, in Honolulu, some 4,000 to 5,000 feet high, recalls Solva, in Pembrokeshire. There is a magic view of Bombay, jutting out between two seas; a stately sketch of the Residency at Lucknow; and a charming Japanese interior, half conservatory, bright with flowers. There is a boar-shooting scene in New Zealand, under a steady downpour of rain, like an aerial cataract. "The View of Heaven," near Yokohama, almost deserves the poetic name. There is a fairy scene at Benares, displaying a mosque of magic proportion, under the shadow of which is the large double barge built for the Duke by the Maharajah, and propelled by paddles at the stern after the fashion of a treadmill. The state barge of his Highness, with a peacock carved on its long dragon-like prow, is rowed close by. We conclude with the most dashing and original scene of the entire collection—a bathing party at Hilo, in Hawaii. It might have been painted in another planet, or in the golden age of our world. A basin, surrounded by rocks, is fed by a fine cataract, coming down with a jutting rush. From rocky shores, and sand, and every point of vantage round the bay, the white unclothed natives are jumping and precipitating themselves into the water, diving, and sporting, and swimming, and even shooting down the waterfall. A flock of water-birds, or a shoal of seals, could not enjoy themselves more unrestrictedly. It is a wonderful bit of contemporary life. We hope the suggestion as to the publication of these sketches may be of some service.

ART-UNION OF LONDON.

The following pictures have been selected by prize-holders from the various exhibitions of the season:—

FROM THE ROYAL ACADEMY.—'Dr Johnson at Rehearsal,' T. D. White, 200*l.*; 'War News—Hostilities have Commenced,' G. Pope, 100*l.*; 'Town and Castle of Amboise on the Loire,' G. C. Stanfield, 100*l.*; 'A Runaway,' W. M. McTaggart, R.S.A., 45*l.*; 'A Salmon Trap,' J. Adam, 45*l.*; 'Too Late,' A. D. Cooper, 30*l.*; 'The Homestead,' A. J. Stark, 25*l.*

FROM THE SOCIETY OF BRITISH ARTISTS.—'St. Michael's Mount, from Marazion,' George Cole, 60*l.*; 'The Cliff,' T. Roberts, 50*l.*; 'A Summer Afternoon on the Mole, Surrey,' W. H. Foster, 45*l.*; 'Cattle on Hampstead Heath—looking West,' H. Earp, 40*l.*; 'On the South Coast,' E. Holmes, 40*l.*; 'Portland Island,' E. F. D. Pritchard, 40*l.*; 'Little Goody Two Shoes,' Mrs. Charrette, 31*l.* 10*s.*; 'A Modern Imogene at the Cave,' A. F. Patten, 31*l.* 10*s.*; 'On the Scheldt,' E. Hayes, 30*l.*; 'The Lesson,' R. C. Green, 30*l.*; 'Winter,' J. C. Thom, 26*l.* 5*s.*; 'Loch Katrine and Ben Venue, Perthshire,' C. Pearson, 25*l.*; 'The Pet Bird,' R. Physick, 25*l.*; 'A Quiet Spot,' C. Smith, 25*l.*; 'Pat preparing for the Fair,' A. Gunn, 21*l.*; 'A Berkshire Water-Mill,' Miss S. S. Warren, 21*l.*; 'Fishing Town on the French Coast,' J. J. Wilson, 21*l.* 10*s.*; 'Fruit and Still Life,' C. T. Bale, 20*l.*; 'Low Tide, Schevening Beach,' E. Hayes, 20*l.*; 'Mill near Tamerton, Devon,' W. Pitt, 20*l.*; 'Morning—near Great Marlow, on the Thames,' J. C. Salmon, 20*l.*; 'Mouth of the Thames—Blowing Fresh,' C. Taylor, 20*l.*; 'Among the Heather,' T. F. Wainwright, 20*l.*; 'A Venetian Balcony—the Gift Refused,' 26*l.* 5*s.*; 'Old Bridge at Onwlln, South Wales,' J. Peel, 25*l.*

FROM THE NEW BRITISH INSTITUTION.—'There, on this spot by traitorous hands,' &c., C. Calthrop, 50*l.*; 'Stepping-stones on the Ogwen,' W. H. Vernon, 45*l.*; 'La Débutante,' Haynes Williams, 45*l.*; 'Treasure Trove,' C. M. Webb, 40*l.*; 'The Black Pool,' J. Finnie, 30*l.*; 'The Miller's Waggon,' J. Peel, 30*l.*; 'In the Marshes, Rainham,' W. Luker, 25*l.*; 'Under the Elms, Hyde Park,' J. Thorpe, 21*l.*

FROM THE SOCIETY OF PAINTERS IN WATER-COLOURS.—'On the Road between Cladish and Dalmally, Loch Awe, Argyshire,' T. M. Richardson, 45*l.*; 'A distant Gleam of Sunshine over the Sea,' S. P. Jackson, 40*l.*; 'Distant View of Conway from the West,' David Cox, jun., 35*l.*

FROM THE INSTITUTE OF PAINTERS IN WATER-COLOURS.—'Vessels off Tynemouth Bar,' Edwin Hayes, 84*l.*; 'The Bridge and Campanile of S. Croce,' D. H. Mc Kewan, 42*l.*

FROM THE GENERAL EXHIBITION OF WATER-COLOUR DRAWINGS.—'Glacier Stream, Zermatt,' A. Croft, 40*l.*; 'Near Harlech, North Wales,' H. Moore, 20*l.*

FROM THE ROYAL SCOTTISH ACADEMY.—'Glen Croc,' J. L. Wingate, 28*l.*

COMMERCE.

FROM THE GROUP OF SCULPTURE BY
T. THORNYCROFT.

IN any great English monument assuming to have a national character, it was only right that Commerce, certainly one of the distinguishing features of our diversified community, should be prominently represented. "Ships, Colonies, and Commerce," has long been a favourite motto in our country. The omission from the Albert Memorial of such a representative group would, therefore, have been a grave error: Mr. Thornycroft's expressive work supplies what otherwise would have been an unaccountable void.

The composition suggests both the luxuries and the necessities of life. The principal figure, holding a cornucopia in her hand, is typical of Prosperity, and shows that commerce is the medium of scattering wealth and abundance throughout the land. The other standing-figure may be accepted as a young merchant, or supercargo: he is habited in Anglo-Saxon costume, symbolising the very earliest spirit, in England, of mercantile adventure: in his right hand he carries an account-book and a purse, indicating that, to embark in mercantile transactions, he must possess both capital and credit; in his left hand he bears balance-scales, the emblems of just trade or barter. An Eastern merchant forms the counterpoise to the latter figure; he is offering to him for sale a jewel-casket, which typifies the luxuries of life: its necessities appear in the figure of a rustic, seated upon a skin, with an open sack of unthrashed wheat before him, which he also tempts the youth to buy. Thus, the trapezoidal form of the group, which the sculptor evidently intended to give it, is rendered complete. Among the attributes, or accessories, is a bale of cotton, or silk, another emblem of commerce; and serving, where it is here placed, to give solidity to the lower part of the composition. It will be observed that all the lines of the group are made subservient, and lead up, to the head of the principal figure.

Mr. Thornycroft has most successfully worked out the idea of the subject: the figures, individually, are exponents of their calling; and, collectively, make up a group of much elegance, combined with spirited and life-like action.

THE INDIAN COURT AT THE INTERNATIONAL EXHIBITION.

THE sparkling freshness of the International Exhibition has, in the present year, been kept up by accident, and even by misfortune. The deplorable events of which France has been the scene, so delayed the efforts of the French exhibitors to represent themselves worthily before us, as to render necessary a separate opening of the French annex, which took place in the month of June. With the commencement of the fine weather of July the Indian Court was completed, and opened to crowds of delighted visitors. The success that attended these subsidiary openings has been so complete as to lead to the suggestion whether, on another occasion, the plan of development of the resources of the Exhibition may not be advantageously made part of the programme. With the exception of the comparatively few visitors who would come in the first few weeks, and come no more, every one would be benefited by a plan that would allow of an exhaustive observation of the whole contents of the collec-

tion without confusion to the mind, or too much fatigue to the body.

The Indian collections now open to the public are arranged in a central hall, garnished on the north with a row of little cells or shops like an oriental bazaar. The effect of the court is very different from that of any other portion of the Exhibition, no less from the appropriate mode of arrangement, than from the wonderful splendour of the textile fabrics that form the most attractive objects of display. The exhibits have come from every part of India, and the various local governments as well as the native princes appear as exhibitors.

It may be fair, however, to call attention in the first place to the tempting wares of those commercial firms which are either already established in London, or which take occasion of the present opening for striking work among us. Of the numerous visitors to the Indian Court the majority will come away with the wish to become purchasers of some Indian articles of luxury or of utility. It will be, therefore, of service to point out where their wishes can be most readily gratified.

The corner cell, or portion of the northern arcade, is occupied by specimens of Turkey and Indian carpets, rugs, and hangings, exhibited by Watson, Bontor, and Co., of 35, New Bond Street. Lists and prices of these durable and splendid fabrics are here to be obtained, and the various descriptions of carpet are admirably illustrated. Next comes a compartment devoted to the display of furniture. Exquisite carved chairs, tables, and other objects, in perforated black wood, are to be found in this spot, which, on the occasion of our last visit, was not thoroughly arranged. Then comes a most careful, as well as very interesting, cell, full of the oriental goods sold by Alfred Inman, of 17, Ebury Street. These are objects of domestic requirements, which, for the most part, are of very moderate cost, including not only Fine Art objects in bronze, brass, carved wood, stone, and ivory, Bombay inlaid work, lacquered ware, fans and screens of palm-leaf, seats, fishing-rods, blinds and baskets in bamboo, oriental pottery, and egg-shell porcelain, silk fabric caps, handkerchiefs, and embroidery, but also condiments, preserves, pepper, Chinese and Indian tea.

The next compartment is literary or educational, comprising maps, books, and periodicals, illustrative of India. It is opened by H. T. King, East India agent, from the library at 45, Pall Mall. This novel feature of the court gives unusual completeness to the display. A compartment of double size is then devoted to the display of the shawls and shawl goods manufactured in Kashmir; the acknowledged beauty and great value of which have commanded the admiration of the world of taste for several centuries. They are exhibited by the Kashmir Shawl Company, the head-quarters of which are at Sreenuggur, Kashmir, and Jumoo, and whose agent in London is Seth Anderjee Cowasjee, a gentleman who, judging from his head-dress, is a Parsee. Some idea of the importance of this industry may be arrived at from the fact that the value of shawls exported from India, exclusive of those sold in that country, rose in the year 1862 to £459,441. Some of those displayed in the exhibition are priced as high as £500; and one, which was presented to her Majesty the Queen Victoria, by H.H. the Maharajah of Cashmere, cost £1,000 in workmanship. Long and square shawls of Kannikar loom-work, and specimens of Amlikar needle-work, and Dorree and Kytondur embroidery and fancy work, are to be found in this costly stall. A second compartment occupied by carpeting, concludes the row of small cells.

In the main apartment, the attention is principally claimed by the splendid tissues called Kincaubs, which are brocades in gold and silver, and silk of the richest dyes. Our readers may remember the account which we gave sometime since (see *Art-Journal* for April 1870) of the India Museum, in Downing Street. The same costly display of Oriental taste, and the same valuable information for our home manufacturers, are to be found illustrated, by fresh examples, in the Indian Court. We may add that the same admirable power of organisation, and clear method of imparting information,



COMMERCE.

(THE ALBERT MEMORIAL, HYDE PARK.)

ENGRAVED BY E. STODART FROM THE GROUP IN MARBLE BY T. THORNYCROFT.



which characterise the work of Dr. Forbes Watson in the Museum, attest his handiwork in the ordering of this Indian Court. Any one who is desirous to obtain practical and accurate information as to any important branch of Indian manufacture will be able, so to speak, to run it to earth, by means of the very lucid catalogue issued by the Department; and by the examination, not only of the raw materials and specimens of finished work, but also of the drawings and models of the workmen engaged in the actual procedures of manufacture, which have been executed by native artists.

It is impossible to condense an exhaustive account of this gorgeous and costly display within the space at our command. The metal work alone would occupy several columns. The show of arms and armour, inlaid, enamelled, set with uncut gems, is magnificent. There are from forty to fifty articles of gold; more than double the number of objects in silver; a collection of imitation gold and enamel ornaments from Bombay, lamps, idols, personal ornaments, and domestic implements in brass; about ninety specimens of that peculiar art of inlaying steel with gold which is practised chiefly in the Punjab, and known by the name of *Koofgari* work; and the cheaper, coarser, but still effective, mode of covering pewter vessels, hooka bowls and pipes, boxes, "goglets," and rings with silver-leaf, which is known as *Bidree* work.

We have specimens of carvings in very different substances, from the blackwood which affords the material for such very exquisite articles of household furniture, to imperishable jade and rock-crystal. Among these the carvings in sandal-wood, from Mysore, Moradabad, Bhurtpore, Coomptar, Ahmedabad, Bombay, Baroda, and Madras are perhaps the most attractive, from their delicate fragrance, no less than from the elegance of their design and execution. We desire to give prominence to the name of Naorojee Shapoorjee and Co., of Bombay, as the carvers of the superb Blackwood chifonier, davenport, and side-board, that form one of the most striking groups of objects in the Exhibition.

Among the carvings in ivory we find evidence of a mischievous and mistaken idea of education which has led to the production—more especially in the school-work—of objects that must certainly displace the great marble dog in the South Kensington Museum from the championship attributed to it by Mr. Ruskin, of being the very worst thing that human art ever produced. Nothing can be more effective and characteristic than Indian Art, whether in carving or in textile fabric, when applied with an Indian motive; nothing can be more abominable, feeble, tasteless, and utterly vulgar than the outcome of Indian skill applied under the direction of what we suppose must be called English taste. It is beyond our department to speak of the wisdom or folly of the attempt to transplant the political institutions, the philosophy, or the religion, of one great branch of the family of nations as exotics into the soil in which those of a very different race have struck root. But as to the attempt to convert the Art of India into the likeness of what may be called Art in England, there can be but one opinion among competent persons. We trust that the display of the hybrid abominations which are exhibited, we suppose with gleeful self-satisfaction, by some of the educators of Indian youth, will have the effect of calling the attention of the government of India to the ruin and destruction which will be brought upon the productive power of that great empire unless this barbarous mode of teaching be at once sternly repressed.

The drawings, engravings, and photographs exhibited in the Indian Court form a collection admirably illustrative of the country. Indian pottery is also illustrated by a series of some thousand objects, that form a valuable appendix to the small but elegant collection in the eastern gallery of the Exhibition. Educational works and appliances are also fully illustrated. We have given but a hasty peep at this brilliant court; but it will perhaps be enough to induce many a reader to visit it with deeper interest.

OBITUARY.

JOSEPH PETZL.

THIS artist, one of the most popular *genre*-painters of Germany, died at Munich in the month of May. He was born at that city in 1803, but went to Berlin and studied there under Begas. Petzl accompanied King Otho to Greece, a country which suggested to him the subjects of some of his best pictures, as 'Greeks reading Otho's Proclamation,' a work containing numerous figures, all portraits; it was exhibited at Berlin in 1834. Another is 'A Greek Wedding,' a composition containing a great variety of figures in rich costumes, full of animation, and brilliant in colour throughout. Count Raczynski, in his "Histoire de l'Art Moderne en Allemagne," says,—“The Prince de Tour et Taxis possesses one of the richest compositions by him with which I am acquainted: in this picture he seems to have been inspired by Wilkie's 'Reading the Will.'”

Petzl lived nearly the last half of his life at Munich, and is usually classed with the painters of that school. There are few collections in Germany which have not some specimens of his works.

PETER VON HESS

The name of Hess is familiar to all who are acquainted with modern German Art. Peter von Hess, who died at Munich, where he and others of his family long resided, on the 4th of April, was born at Düsseldorf in 1792-3. He was eldest son of Charles Hess, professor of engraving in the Munich Academy; his next younger brother being Henry Hess, the distinguished historical painter; and the youngest, Charles Hess, a battle-painter of some note. Peter had acquired the *soubriquet* of the "Horace Vernet of Central Germany," from his numerous pictures of battles: of these the most prominent are his 'Battle of Arcis-sur-Aube,' and 'War in the Tyrol,' both of them large compositions with numerous figures. But his finest work is considered to be 'The Entrance of King Otho into Nauplia.' 'The Crossing of the Beresina,' was painted for the late Emperor of Russia.

As a painter of *genre*-subjects, Peter von Hess made himself very popular, and his works of this kind are to be found in some of the best collections on the Continent; but for many years past the commissions he received for battle-pieces, especially from the Bavarian government, compelled him to limit his labours almost entirely to such subjects. About twenty years ago he published a large folio volume entitled "An Album of Greek Heroism, or the Deliverance of Greece:" it contains nearly forty illustrations in chromo-lithography, bordered with gold; the descriptive letter-press being written in Romaic, German, English, and French. It is a very splendid volume.

ALEXANDER KEITH JOHNSTON, F.R.S.

Though not strictly within the usual scope of our obituary register, we cannot allow the death, early last month, of this distinguished geographer to pass without notice. He was born in Edinburgh, in 1804, and was educated at the High School in that city, with the view of adopting the medical profession; but, instead, was articled to an engraver, and thereby acquired that artistic skill which characterised the geographical works published by him: these have made his name, as associated with the science, renowned over the world.

THE ANATOMY OF OXEN.

BY M. E. TSCHAGGENY.

A WORK of extraordinary merit, interest, and value, may be examined in the Belgian Court of the International Exhibition. It is the produce of almost a life: or, at all events, of its comparative leisure: the life of an accomplished and popular artist—M. Edmond Tschaggenny, whose paintings are well known in England and highly appreciated, not only in his own country, Belgium, but in all the states of Europe. The artist has made his reputation by his pictorial portraits of animals, but he excels in other branches of Art. To his careful and matured study of what is called "the Lower World" in nature, he is, however, mainly indebted for his fame. The work to which we direct attention is evidence of this; it is the result of long and arduous labour. No anatomist has given to the human form more continuous thought, or described it with greater force and effect, than has M. Tschaggenny, as regards the animal he delineates. We copy a passage from the report of the commission of the Paris Universal Exhibition, in reference to this remarkable work: "M. Tschaggenny has proved that he possesses a great mastery of the art of drawing animals, joined to a knowledge of anatomy, which is the fruit of patient and laborious studies during a period of more than twenty years."

The drawings, ninety-eight in number, are contained in three folio volumes; the first shows the living cow, "for the study of the exterior conformation;" the second being a complete natural skeleton; then follow drawings of all the bones and muscles, nothing of the animal being left without full and explicit description, so that the work—to borrow from the report of a commission charged on behalf of the Belgian Royal Academy of Medicine—"not only deserves attention from an artistic point of view, but also with regard to Science"—all the objects contained in it being "depicted with the most scrupulous accuracy, several among them being indicated for the first time."

In the *Paris Medical Gazette* we find the following passage, which better describes the voluminous and exhaustive work than our pen can do:—

"This Atlas, which the author has sent to the Universal Exhibition, constitutes for connoisseurs one of the jewels of that great international display, and deserves, in the highest degree, to fix the attention of painters and of men of science."

"M. Tschaggenny reproduces, drawn most carefully, and painted with all the skill and tact of which he is capable, the bones, the articulations, all the muscles, as well as nearly all the most superficial vessels and nerves, and represents those parts, in their different aspects, layer by layer, in a perfect topographic order. The author, a conscientious and able artist, has thought himself obliged, in the interest of his art, to study in the most minute manner the anatomy of animals, particularly that of those known as 'domestic.'"

Unless it be sought for, it is more than probable this great achievement of industry combined with genius will be overlooked. Amid a crowd of more inviting objects the volumes may be lost; but true lovers of Art, attentive students of Nature, and especially those who are interested in the most useful of all the animals that minister to the needs of man, will do well and wisely to search for it and examine it carefully. Those who do so will be amply repaid. As a production of Art it is of marvellous merit: every drawing is the result, not only of actual study in the *atelier* of the anatomist, but of artistic power and skill. It is a work that ought to be published, in order that what must now be the acquirement of one may be the instructor of many.

It can surprise no one who examines this collection, that its author has attained a position as an animal-painter second to no artist, living or dead. His paintings are, as we have said, familiar to English collectors: he may have been surpassed in popularity by artists who have aimed at greater singularities, but for soundness of treatment, for thorough comprehension of his leading theme, and for matured Art-knowledge, he has no competitor, even in Belgium; while in England there is no painter who approaches him in truth combined with fancy, and force associated with pictorial effect.

MINOR TOPICS OF THE MONTH.

THE NATIONAL PORTRAIT GALLERY.—We find in the fourteenth annual report of the Trustees of this gallery, lately issued, that nine pictures have been presented during the past year, and twelve were bought: the "gifts" have now reached 91 in number, and the purchases 229. Since the collection was removed from George Street, Westminster, to South Kensington, the number of visitors increased from 24,416 to 58,913.

THE NATIONAL GALLERY.—Preparations are being made for the proposed extension of this edifice. Among the buildings in course of removal are the Grammar School founded by Archbishop Tenison, and several houses and tenements between the National Gallery and Hemmings Row.

THE ELECTION AT THE ROYAL ACADEMY.—The Royal Academy has elected George Edmund Street, Esq., architect, to the vacant membership. Of the abilities of that gentleman there is no doubt; in his profession he holds prominent, if not high, rank, and is generally esteemed. Whether the accession will be of any value to the Academy is another matter: Mr. Street does not seem to think his contributions to the Exhibition of much worth. In 1871 he sends nothing whatever, and in previous years his aids in that way have been few and far between. The contest lay between Mr. Street and Mr. Joseph Durham; upon every principle of policy and justice, the latter should have been preferred to the former; less because the number—four—of the architects equals that of the sculptors—members and associates—that sculptors are far more beneficial contributors to the Exhibition than architects—that the vacancy was created by the retirement of a sculptor—than because architects have their own Institute, which confers honours as great, or almost as great, as those awarded by the Royal Academy; and because sculpture, as an Art, requires the fosterage, encouragement, and help which architecture does not, in England. There is no doubt that the great abilities of Mr. Durham are largely appreciated by his professional brethren, as they certainly are by the public. The Members and Associates of the Royal Academy marked their sense of his merit by sending him to the ballot with "the favourite;" and he will, it is more than probable, be the successful candidate next time. Indeed, in his own Art, if he has any competitor, he has no rival. The Testimonial in the Horticultural Gardens is almost the one public monument to which we English may point with pride; and his group entitled 'A Dip in the Sea,' now in the Exhibition, may be referred to as a great triumph of British sculpture—perhaps the greatest of its class and order that has been achieved since Gibson ceased to work, and Foley to exhibit.

THE CONVERSAZIONE AT THE ROYAL ACADEMY was a very brilliant affair—a thorough success; the pictures were seen better by gas-light than by sun-light; the refreshments were ample, and the company seemed full of life. Several of the Royal Family, and a large number of the aristocracy were among the guests; and naturally the artists assembled in force. The entertainment, in short, was a happy mixture of social pleasure with intellectual enjoyment.

HOLBEIN EXHIBITION.—One of the most interesting exhibitions that has ever been held in association with Art is to take

place at Dresden, from the 15th of August to the 15th of October. It will consist of the works of the great artist, Hans Holbein. Her Majesty the Queen has graciously consented to contribute the most prominent Holbein paintings in the galleries of Windsor and Hampton Court; no doubt her example will be followed by many collectors, whose homes or portfolios contain productions of the mighty master. Those who desire to be contributors may communicate with Messrs. Holloway and Son, Bedford Street, Covent Garden, who will take all trouble off the hands, and such services will be gratefully acknowledged by Dr. Julius Schnorr von Carolsfeld, Professor J. Felsing, Chairmen; and Dr. A. von Zahn, Hon. Secretary, Dresden. The names are well known and highly honoured in England as well as in Germany.

THE CRYSTAL PALACE PICTURE GALLERY.—We have frequently directed attention to the advantages which this gallery presents to artists, not only for the display of their works, but as a medium of sale; for it is seen daily by at least a thousand persons, many of whom covet pictures as home-luxuries, and who would certainly become purchasers if the supply were equal to the demand. We announced last month that certain "money prizes" were awarded by the directors to exhibitors; under "conditions," however; for it was provided that pictures eligible for such prizes should have been painted within a fixed period, and not have been exhibited elsewhere. The arbitrators, Messrs. E. M. Ward, R.A.; Louis Haghe, and S. C. Hall, were, however, of opinion that money prizes were not lures to leading artists, who would rather shrink from competing where money was to be the reward; and they recommended that gold, silver, and bronze medals, in sufficient number, should be offered as inducements to artists generally: the suggestion has been acted upon by the directors. They announce that next year, in the summer of 1872, forty medals will be thus awarded—five of gold, twenty of silver, and fifteen of bronze. The resolution is a wise one: we cannot doubt that the most popular and prosperous artists, British and foreign, will compete for these medals; they will be regarded as heirlooms. There are few means by which artists can gain any such: the Royal Academy dispenses its honours with a niggard hand, and other institutions think they are sufficiently liberal when they give one gold medal in one year. The Crystal Palace Company will give five—surely they will be temptations to artists, who, when obtaining that which will be a family prize for generations, will know that, in acquiring it, they have instructed and delighted tens of thousands. Mr. Wass will, in due course, issue the company's table of conditions.

MR. F. MADOX BROWN has recently completed three pictures which, on account of their originality and independence of thought, call for special notice. They are, it is presumable, the artist's works for the season, and must have occupied him a great length of time; their qualities are of a description that require them to be placed near the eye. The subjects are of an ordinary kind, and hence the greater the merit of any novelty of treatment. They are 'Romeo and Juliet,' 'The Coat of Many Colours,' and an 'Entombment.' In the first, it is the balcony-scene that is set forth—that is, the leave-taking. Romeo had taken his farewell, and had departed; but Juliet prevails on him to return, and she is again in his embrace, while one foot is yet on the rope-ladder, and

the other on the balcony. He points to the brightening horizon, but she closes her eyes, and refuses to see and acknowledge the coming day. The figures are brought into a relation in a manner to concentrate the essence of the most passionate discourse of the lovers. The weakness of the ordinary treatment of the scene has generally been prettiness of detail. Here there is no such infirmity; everywhere the picture glows with the living expression of the text. In 'The Coat of Many Colours' the point presented is that usually selected—the exhibition of the garment by Joseph's brethren to their father Jacob, who is seated under a fig-tree. In the characteristics, superficial and otherwise, Mr. Brown departs entirely from accepted conventionalities. The equipment of his figures he marks neither as Egyptian nor Assyrian; but, in the absence of formal authority for early scriptural costume refers to both, and herein lies a reasonable probability. The entire cast of this picture is admirable, and can have been produced only by earnest research and profound study. In the 'Entombment,' the persons brought forward are Nicodemus, Joseph of Arimathea, St. John, and the three Marys; and in this work as much care has been exercised as in the two others. There is also a smaller study from the *Corsair*.

ORNAMENTAL RAILING TO THE EMBANKMENT GARDENS.—With much good taste the gardens are being laid out on the ground which, we trust, will yet be rescued from the grip of the law-officers of the crown. The railing, let us note, is about as bad as possible—rather resembling piecrust than cast iron. For a public fence we require something massive, solid, durable. Wrought iron spears are probably the best elements to use; and if cast iron be employed, the pattern should be one suitable for a metallic design. The present palisade is *fine, mesquin*, unmeaning, and would fly to pieces like glass under a blow or two from a heavy hammer. It is a new instance of the result of getting our decorations done cheaply—at least, of getting it done, in the first instance, for little money.

STATUES DOING PENANCE.—We protest against the practice, which almost daily gains ground, of making the effigies of our public men do a long penance in the streets of the metropolis, enveloped, like the frail Jane Shore, in a sheet, though without the taper in the hand. An Indian Hero is thus gibbeted at present in the garden on the Thames Embankment, just by the junction of Whitehall Place with the river-side drive. On the occasion of the Queen's visit to St. Thomas's Hospital, when this route was much frequented, we hoped that this ugly disguise would be removed. It still remains, however. A granite pedestal, adorned with bronze trophies, supports a statue clad in damp calico, clinging to the prominent parts of the figure in ludicrous and most unseemly guise. The true reason of the delay in unveiling the statue, which is that of Sir James Outram, by Mr. Noble, we understand to be the non-completion of the laying out of the surrounding ground: this might have been done long since, and there is, therefore, no sort of excuse for the unseemly condition in which the work now appears. We have waited for the "unclothing" to give some account of it.

CHRISTI TRIUMPHUS.—A chromo-lithograph, gay in gold and colours, has been issued by M. Levy, of Paris, and may be obtained at Messrs. Hachettes, in King William Street. It was prepared during the siege of Paris, and certainly must be

taken to regard the future more than the present, being sketched from the Romanist, though not from the Papist, point of view. The subject is a processional triumph, on a gold ground. Some slight liberties have been taken with the order of the procession, as far as chronology goes—to say nothing of other difficulties. Adam and Eve march first, in girdles of leaves. Noah is one of their immediate followers: he bears aloft a child's Noah's ark, with the dove on the roof. Then come, almost in a parallel line, Moses, Joshua, and Tobit—the latter known by his fish. Abraham very unpunctually follows, with a carnifical knife, and a shrinking victim. Then come the six Sibyls, bearing voluminous banners, inscribed, not with their names, but with their designations. Isaiah is conspicuous in a following group of prophets, and is followed by a group of naked children, no doubt the Holy Innocents, bearing the implements of the Passion. The cross is borne by a tall naked figure. The car of Christ is drawn by the four evangelic beasts, who seem utterly overpowered by the weight; and the four great doctors of the Latin church are putting their shoulders to the wheel. The apostles succeed, each bearing the instrument of his martyrdom. Then come bishops, including among the number St. Lawrence with his gridiron, and St. Sebastian transfixed and bleeding. Monks, saints, anchorites, and nuns close the procession; one of the last figures being a gigantic St. Christopher, with the *bambino* on his shoulders—a representation somewhat irreconcilable with the car. We have no doubt the group will find many admirers.

STATUES OF EMINENT STATESMEN.—There is some talk of erecting, by means of subscriptions, in the vicinity of the Houses of Parliament, statues of the late Earl of Derby, Viscount Palmerston, and Sir Robert Peel; these, it is said, are to be followed by others. The site proposed for these works is that of the gardens in Parliament Square, opposite the gateways of New Palace Yard.

MANY objects in the International Exhibition have been purchased by the Princess Louise and the Marquis of Lorne. The manufacturers seem very proud to have thus supplied the fair Princess, and several of them have indicated the agreeable fact by "ticketing" such objects.

NEW ZEALAND SCENERY.—Until within the last few years New Zealand may be said to have been, to the great body of the public, a veritable *terra incognita*—a name and nothing more; latterly, however, photographs have found their way from that distant shore to friends in the old country; and, though dealing with little more than coast-scenes or views but a short way inland, they have given many of us some idea of the grand scenery of these Southern islands; and now, through the medium of the interesting collection of pencil and water-colour drawings by M. Chevalier, at present exhibited at the Crystal Palace, in which he gives us the most graphic glimpses of "mountain, fell, and flood," we are enabled to see more of the wildly picturesque and beautiful country comprised in the two islands forming New Zealand. It is not merely *scenery* that M. Chevalier portrays; we are shown strange types of physiognomy, quaint and marvellous tattooing devices, drawings of elaborately-carved canoes, uncomfortable looking weapons, &c., altogether composing a very perfect and valuable series. He is indeed no cursory and hasty observer, having resided for two years on the islands, exploring at the time thoroughly its varied scenery, rang-

ing the forests, laboriously making his way through the dense undergrowth, and scaling the rocky mountains; possessing also a facile brush and judicious taste, he is completely justified in coming forward as an exponent of New Zealand landscape. Many of the views will strike the spectator with the general resemblance they bear to certain parts of the Western Highlands of Scotland; 'Le Anan Lake' (25 and 29), for instance; but others again, such as 'Mount Egmont' (88), boast a sublimity and a vastness that no part of the British Isles possesses: the drawing just referred to is, both for effect and execution, perhaps the best in the Gallery; there are about 150 altogether. Standing on their own merits as works of Art, and divested of the adventitious aid which the portrayal of a grand or striking scene confers to the popularity of a picture, these water-colour drawings, as a whole, would hardly hold their own against the majority of the contributions to our London exhibitions; they are clean and vigorous, but deficient in aerial perspective and *light*; they, however, show very evident signs of extreme care and fidelity, with considerable determination in the selection of suitable views, and altogether form an exhibition which those who are interested in our Australasian possessions would do well to visit.

BUST OF SIR WALTER SCOTT.—The "Centenary," in August, that will, of a surety, bring together a large number of the most intellectual and patriotic men and women of the age, to commemorate the birthday of Sir Walter Scott, will be commemorated in many ways. The Ceramic Art-Union has very wisely prepared a bust of the great "magician," who still ministers to the happiness of, it may be, the half of human kind. The one selected is that by Chantrey—undoubtedly the best; it represents Scott in his best time, before age had contracted the features: he was past his prime, indeed, when he sat to the sculptor, but his grand forehead and genial countenance had rather improved than deteriorated. It is just the likeness of the great man, which all readers of his imperishable works would desire most to look upon. The bust under notice is not large—14 inches high: it is an admirable copy of the original, and will be cordially welcomed by thousands, not only in Edinburgh, where the "gathering" takes place, but in all places where are read the poems and stories of the man who will never die.

MESSRS. HOLLOWAY AND SON announce for publication a work of some magnitude and great interest—"Engravings from the Choicest Examples of Art-workmanship contained in the celebrated Collections of this Country." They will be from drawings made by M. Edouard Lièvre: his publication, *Les Collections célèbres d'Œuvres d'Art en France*, is well known to all connoisseurs. It is a "scarce" book, now of large value. The production announced will be limited as to issue: it must be, necessarily, costly; yet will readily find purchasers.

A STATUE OF THE LATE MR. H. BALFE, the eminent musical composer, is to be placed in the vestibule of Drury Lane Theatre, if the subscriptions his friends and admirers are endeavouring to raise will permit the work to be done.

A DRINKING-FOUNTAIN is to be erected in the Regent's Park, in memory of the late Mr. Joseph Payne, Deputy-Assistant Judge of Middlesex, long known for his philanthropic exertions to ameliorate the condition of the lower classes, and especially of their children.

REVIEWS.

ÆSTHETIK ALS PHILOSOPHIE DES SCHÖNEN UND DER KUNST. VON MAX SCHASLER. BERLIN, NICOLAISCHE VERLAGSBUCHHANDLUNG.

THIS work proposes (the first number only is before us) a critical history of æsthetics from Plato to our own times. Dr. Schasler introduces his subject by a justification of the definition which he gives of it above, and states its claims to the consideration of an established science. Since the middle of the last century, when Alexander Gottlieb Baumgarten, by his work called "Æsthetica," introduced the new science, much has been said and written about it, but until the present hour no definition has been generally settled and accepted. Many a lengthy paraphrase has been written in explanation, and many would-be expositors have wandered far into obscurity in their wordy solutions. It appears to us that Dr. Schasler, in describing his subject as "The Philosophy of the Beautiful and of Art," has taken the sense of the majority, and given an intelligible solution that renders further discussion useless.

He lays down a curious table, in which he sets forth the different kinds and degrees of interest men take in Art, from the practical to the æsthetic, through the artist, the lover of Art, the collector, the dealer, the publisher, the auctioneer, &c.; dividing his system into three sections, the judgment of the feelings, the judgment of the intellect, and the judgment of reason, and after an exposition of the relations shown in the table, he says:—"We now find ourselves on the ground of æsthetics as a proper philosophical science, which we shall see presently in the historical development of its principles, obeying throughout the same law, for antique æsthetics must be regarded as intuitive, those of the eighteenth century as reflective, and those of the nineteenth as speculative." We cannot follow the writer through his dissertation on the antique to Plato—through the Socratic and the Platonic, the Peripatetic, Stoic, and Epicurean, the Eclectic, and his other divisions; it is enough to say, that by the profundity of his "reflective science" he rivets the attention, and is very amusing when giving flowing rein to his diverse shades of "ironie." *Apropos* of his nomenclature—not his, but that of his language, for the words are common enough—we are seriously reminded of our own poverty in Art terms, as we are obliged to have recourse to a foreign language to render such words as "Kenner," "Kennischaft," "Kunstliebhaber," having nothing to substitute for connoisseur, amateur, &c., and being ashamed of that honesty which, in other languages, employs native words to express common things. In speaking of the pomp and variety of collectorship, which the writer describes as accompanied by much ignorance, he says, of this order of Art-lovers were the Medici, Pope Julius, King Louis, Frederick William IV., Count Raczyński, Baron Von Shack, and Louis XIV., who was the reality of all that was vain and ignorant in matters of Art. Yet it is open to question that had these patrons been practically more skilled, should we have been equally well provided with Art-centres, and instructive collectors? Göthe sums up this category very simply with the observation, "Man lernt nichts kennen, als was man liebt." Burke says the same, and in his earnest self-examination, with equal simplicity, expresses himself ashamed of admiring in his youth what he could not approve in more mature years. Dr. Schasler's book propounds many new and interesting views, by which the more abstruse matter is greatly relieved.

THE ART OF SKETCHING FROM NATURE. By PHILIP H. DELAMOTTE, Professor of Drawing in King's College, and King's College School. Published by BELL AND DALDY.

"Theory may be acquired from books, but it must be confirmed and modified by practice; and thus copies may suggest, but actual sketching from nature alone will make the suggestions

available." The remark is made by Mr. Delamotte, but its truth must be admitted by every one who has made Art a study: books and teachers can only point out ready and proper methods of working; all else must come from the student's observation and practice. Yet it is of primary importance that he should be well-trained in elementary knowledge ere he can expect to succeed when he goes to nature; and this is the object aimed at in Mr. Delamotte's valuable treatise—valuable for the instruction given in the text, and equally so, if not more so, for the numerous examples, admirably reproduced in chromo-lithography, which illustrate the writing.

It is presumed that the student has gained tolerable proficiency in the use of the blacklead pencil, that most useful of all instruments to the learner, and in the principles of light and shade, before he consults this book, which is strictly limited to colour; and to *sketching* in colours. No attempt is made to produce finished drawings; these may afterwards, if desired, be done at home: the work here is out-of-door work. Prefacing his instructions with a descriptive list of the materials required by the sketcher, and of the colours principally in use, with their various compounds, the author proceeds to offer examples, describing in terms not too technical the mode of operation. These examples are twenty-four in number, ranging from objects of still-life, patches of weeds, "bits" of foliage, and portions of buildings, to the wide landscape. In addition to those from Mr. Delamotte's own pencil, are *sketches* by E. W. Cooke, R.A., Constable, J. Varley, S. Prout, Girtin, Birket Foster, and G. H. Thomas; in order that the learner may not find himself restricted to a particular style, but may study those of various eminent landscape-painters: such introductions will be found by the student most valuable. So also are numerous wood-cuts, admirably engraved, from the works of Turner, W. Collins, and others, for the management of light and shade.

Of the many treatises on water-colour painting which have come before us during our long experience, there is not one we can recommend as being so eminently practical as this. At the present season especially, when amateurs are tempted to try their hands at sketching from nature, we would advise them first to look into this volume.

FORS CLAIVIGERA. Letters to the Workmen and Labourers of Great Britain. By JOHN RUSKIN, LL.D. Printed for the Author by SMITH, ELDER, & Co.; and sold only by Mr. G. ALLEN, Heathfield Cottage, Keston, Kent.

Under the above somewhat eccentric title, and adopting a mode of publishing altogether unusual for what, it may be supposed, is desired to have a wide circulation, or it would be altogether useless, Dr. Ruskin has issued, since the commencement of the year, a monthly letter addressed to the working-classes of our country. How far what he advances will be found generally intelligible to a very large majority of those into whose hands these tracts may fall, is scarcely a matter of question; but we have no hesitation in saying, that there is very much in them which may be readily understood, even with only a slight measure, comparatively, of intellectual power: and that were his theories and arguments carried out, very much that is now both socially and politically evil would be changed into good. Take, for example, the advice given at the end of the tract for February:—"1st. To do your own work well, whether it be for life or death. 2nd. To help other people at theirs, when you can, and seek to avenge no injury. 3rd. To be sure you can obey good laws, before you seek to alter bad ones."

There are few topics occupying the mind of the public at the present time, on which Dr. Ruskin has not something to say; and he says it, moreover, in a manner that no one else would think of doing when writing on such subjects; now persuasive, and now argumentative; sometimes humorous, and sometimes satirical: it is a strange compound, but the admixture is decidedly wholesome, and calculated to benefit,

in a politico-economic sense, the constitutions of our countrymen of all classes.

But how are they to get at it? The author says: "For reasons which will be explained hereafter in the course of these Letters, he wishes to retain complete command over their mode of publication. . . . I send a copy to each of the principal journals and periodicals, to be noticed or not, at their pleasure: otherwise I shall use no advertisements." Believing that these tracts are calculated to do much good, if read attentively and without prejudice, we will endeavour to aid their circulation by stating that a remittance of *sevenpence* to Mr. Allen, at the address indicated, will procure a single copy of any one letter, forwarded by post.

RAMBLES OF AN ARCHEOLOGIST AMONG OLD BOOKS AND IN OLD PLACES. By F. W. FAIRHOLT, F.S.A. Author of "Dictionary of Terms in Art," &c. Illustrated with One Hundred and Fifty-nine Wood Engravings. Published by VIRTUE & Co.

Till within the last four or five years there was scarcely a name among the contributors to the *Art-Journal* more familiar to our readers than that of the late Frederick W. Fairholt; and we may add, speaking in our own interests, that there is not one of the many who have aided us either with pen or pencil, or with both, whom we more miss, from his varied antiquarian knowledge and his talents as a draughtsman. During a period extending beyond a quarter of a century, our publication bore testimony to his valuable labours, mostly on subjects of general interest, and not addressed merely to the lovers of archaeology, though requiring acquaintance with the science to set them lucidly before the reader.

Many of the papers he wrote and illustrated for us are of a character to warrant re-publication as a distinct and separate book, so as to be more readily accessible than when scattered through a number of large volumes: and thus our publishers have collected together a variety of these papers, and have re-produced them in an elegant form, printing them on toned paper, and putting them into a rich and appropriate binding. The principal subjects include "Grotesque Design, as exhibited in Ornamental and Industrial Art;" "Facts about Finger-Rings;" "Ancient Brooches and Dress-Fastenings;" "Albert Dürer, his Works, Compatriots, and Times;" with others on Ancient and Mediæval Manufacturing Art, &c.: all of them containing much interesting and curious information, which cannot fail to prove acceptable to a very large class of the community for the research they show, and the popular style in which they are written.

THE SUBTROPICAL GARDEN, OR BEAUTY OF FORM IN THE FLOWER-GARDEN. By W. ROBINSON, F.L.S., Author of "Alpine Flowers," "The Wild Garden," "Hardy Flowers," &c. With Illustrations. Published by J. MURRAY.

The object of this book is to waken a taste for something more than mere colour in the flower-garden, by enumerating, describing, indicating the best positions for, and giving the culture of, all our materials for what is called "subtropical gardening," a term which, the author says, is not very happy nor descriptive; yet it is popularly used to mean the culture of plants with large and graceful, or remarkable, foliage or habit, in association with the usually low-growing and brilliant flowering-plants now so common in our gardens. This system of gardening could, of course, be only adopted where there is a considerable extent of ground undercultivation, and is the very reverse of what is known, and can only be used in small allotments, as the Italian system, where the flower-beds are occupied by low-growing plants. They who are fortunate enough to possess space sufficient for the purpose may advantageously follow Mr. Robinson's instructions. He would, however, have done well to append the English name, if there should happen to be one—as in most cases, doubtless, there is—to the Latin name of the plant, which is recognisable mainly by those who have made botany a study; and this few mere amateur-gardeners have done.

SIMON'S BAY, CAPE TOWN: TABLE MOUNTAIN AND DEVIL'S PEAK, CAPE OF GOOD HOPE. Chromolithographed by HANHART, from Drawings by MAJOR HAVERFIELD, R.M. Published by FISHER, Glasgow.

These are works of great merit and much interest; they bring us to acquaintance with scenes and places familiar to hundreds of thousands, to many of whom they will be pleasant memories; they are admirable as works of Art; the results of frequent study; for it is obvious that the artist has seen them often and long: few objects of so remarkable a class have received more ample justice from the painter.

Happily, several of our soldiers and sailors are artists, who, of late years, have devoted much of their leisure to Art-studies; their opportunities are abundant to bring to our acquaintance the marvels of distant lands. Major Haverfield is one of those to whom readers, thinkers, and Art-lovers owe a large debt. He is working now nearer home, for one of the most attractive landscapes in the Royal Academy is from his masterly pencil. No. 430 represents 'A November day in the Pass of Leny.' It is a true transcript of nature; seen with the eye and mind of a poet-painter, manifesting skill and power, and in all respects a work of rare ability.

THE KERAMIC GALLERY. PART I. By WILLIAM CHAFFERS. Published by CHAPMAN AND HALL.

This is the first instalment of a work intended for completion in six monthly parts, the whole to contain from five to six hundred illustrations of rare, curious, and choice examples of pottery and porcelain from the earliest times to the present, selected by the author from the British Museum, the South Kensington Museum, the Geological Museum, and various private collections. These illustrations will be accompanied by historical notices and descriptions.

To no better hands could be entrusted the compilation of a work like "The Ceramic Gallery," than to those of Mr. Chaffers, who has long made a special study of the subject, and has already written more than one book treating of it. This first part of his new publication opens with a concise history of ancient pottery, followed by one, which will be carried on in the next part, on the Maiolica of Italy—we follow his orthography of the word that hitherto has almost invariably been spelt Majolica, and also his substitution of the "k" for the "c," in ceramic, and other Greek derivative words, and even in proper names, which he appears to have adopted throughout, according to the new-reading which has recently come into vogue. This treatise on Maiolica, or the painted pottery of Italy, is classified under the heads of the places at which it was produced, and reference is made to some of the most important specimens in existence that were made in those places: Thirty-two illustrations, printed by the Woodbury process from photographs are introduced; some of these are very beautiful in form and ornamentation; others are quite pictorial: we question, however, whether wood-engravings of the best kind would not better have represented the designs in accuracy and delicacy of detail; very much of these qualities is lost in some of the examples.

DUPREZ' VISITORS' GUIDE TO MOUNT EDGE-CUMBE. Illustrated with Seven Photographs. Published by WRIGHT, Plymouth.

This little guide-book to one of the loveliest places in England is very well done; there is no pretension about it; it tells all that need be told of the beautiful demesne and the noble family, and does ample justice to both. The photographs are good, and the points well selected. The book may, therefore, be a pleasant and useful companion to all who visit this attractive place, and who on reaching it will pass through the most delicious scenery of our island. The literary portion is very creditable to the pen of its author, Mr. W. H. Wright.

THE ART-JOURNAL.



LONDON: SEPTEMBER 1, 1871.

BRITISH ARTISTS:
THEIR STYLE AND CHARACTER.
WITH ENGRAVED ILLUSTRATIONS.

No. C.—ROBERT ALEXANDER HILLINGFORD.



HE numeral preceding the name of Mr. Hillingford shows that a centenary has at length been reached in this series of biographical sketches of "British Artists." Commenced in 1855, it has been carried on through each successive year with the exception of two intervals, occupied, in 1865, by "Modern Painters of Germany," and, in 1866, by "Modern Painters of Belgium." It may not prove altogether uninteresting to remark, that out of the one hundred artists of this country whose names have appeared in the series, seventeen

were dead ere the writer began his labours: namely—Bonington, Callcott, Collins, Constable, Etty, Flaxman, Fuseli, Haydon,

Hilton, Lawrence, W. Muller, G. S. Newton, S. Prout, Reynolds, Turner, B. West, and Wilkie. Twenty-three have passed away from us since 1855—G. Cattermole, A. E. Chalon, A. Cooper, D. Cox, Creswick, J. Cross, F. Danby, Dyce, Eastlake, J. Gibson, J. D. Harding, D. O. Hill, Jutsum, W. H. Knight, Lance, C. R. Leslie, Mulready, J. B. Pyne, D. Roberts, A. Solomon, C. Stanfield, F. Stone, and W. F. Witherington. Among these forty names—in which appear those of two who were not painters, Flaxman and Gibson, the only sculptors that have been included in the entire series—will be found many of those most distinguished in the annals of British Art: while of the sixty yet remaining with us, the majority may take rank with the leading men of our school, and the others are efficiently helping to maintain its reputation.

The writer of these sketches may not inappropriately, at this advanced stage of the series, take the opportunity of expressing his acknowledgment to those artists who have so courteously supplied him with the materials for his papers; thereby ensuring accuracy in whatever relates to their biographical character. He can scarcely recall one, out of the eighty-three living during the period, to whom he has not been indebted for valuable information. Relying, as the past warrants him in doing, on the like aid in the future, his work will be carried on.

ROBERT ALEXANDER HILLINGFORD was born in London, on the 29th of January, 1828. His family lived in Boulogne, where, at the early age of six years he received his first lessons in drawing from the late G. Stubbs, an English artist resident there, who frequently exhibited, up to 1855, at the Royal Academy, marine-pictures and figure-subjects. Stubbs, we believe, was no relation of the well-known animal-painter of the same name, who died in the early part of the present century. In 1841, being then but thirteen years old, Mr. Hillingford went to Düsseldorf, where he entered the schools of the Academy, studying chiefly under Professor Sohn. After remaining there five years, he proceeded to Munich, and thence to Italy, visiting Rome, Florence, Naples, Perugia, Assisi, Ravenna, and other places remarkable for their Art-remains. His stay in Italy was prolonged for sixteen years; his residence being chiefly in the three first-named cities; but in all he found great delight in studying the early Italian Art of the *quattrocento* period, though one sees little of it in his works.



Drawn by W. F. Allen.]

EVANGELINE.*

[Engraved by Butterworth and Heath.

He commenced practice as a painter of *genre*-subjects: several pictures of this kind he executed in Rome; notably, one entitled 'The Last Evening of the Roman Carnival,' purchased by Prince M. Kotschoubeg, and exhibited in St. Petersburg in 1859: it procured for the artist the diploma of Honorary Member of the Imperial Russian Academy of Fine Arts.

In 1864 Mr. Hillingford returned to England, and settled in London; where, however, his pictures have been seen only on three occasions. The first was at the British Institution in 1864, where he exhibited a powerful and effective example, 'The Choir of St. Maria Novella, Florence.' In 1866 he sent to the Academy 'Petruccio,' a work which did not escape our attention, and was

pronounced by us to be "clever;" it was bought by Mr. Newsham, of Preston, an intelligent collector. The other was exhibited in the same gallery in 1868; it is one of those here engraved, 'BEFORE THE TOURNAMENT.' There is an originality of conception in this representation of a long by-gone scene that is peculiarly striking; the composition as a whole may be deficient in motive, but the bevy of beautiful maidens on their temporary watch-towers, waiting to witness the hostile encounter; and the sturdy man-at-arms keeping back the mob from intruding on the privileged classes, combine, with the accessories, into a most agreeable *tout-ensemble*. It belongs to Mr. R. Nicholson, of Chester.

To the Fine Art Exhibition held in Leeds in 1868, Mr. Hilling-

ford contributed 'Julia's Mission,' from the *Two Gentlemen of Verona*, bought by Mr. T. M. Smith, of Halifax, and 'Preparing the Court-Bow,' which found a purchaser in Mr. F. Turner, also of Halifax. As I have not been fortunate enough to obtain a sight of these pictures, I cannot say anything about them. 'THE FLIGHT OF JESSICA,' here engraved, was also exhibited at Leeds, and was sold to Mr. T. E. Sowerby, another gentleman of Halifax. It represents Jessica eloping with Lorenzo from the house of her father, Shylock. She takes with her a casket of precious jewels from the old usurer's hoard, and is habited, to escape recognition,

"Even in the lovely garnish of a boy,"

but, with innate modesty, is most unwilling to be seen, even by



Drawn by W. J. Allen.]

THE FLIGHT OF JESSICA.

[Engraved by Butterworth and Heath.]

her lover, in unfeminine attire; so she thus addresses him:—

"Here, catch this casket; it is worth the pains.
I am glad 'tis night, you do not look on me,
For I am much ashamed of my exchange:
But love is blind, and lovers cannot see:
The pretty follies that themselves commit;
For if they could, Cupid himself would blush
To see me thus transformed to a boy."

Merchant of Venice, Act 1. Sc. 6.

The artist has taken a pardonable liberty with Shakspeare's description: it is one, too, which, so far as we recollect—for it is long since we saw the play performed—is usually adopted on the stage. The above words are addressed to Lorenzo from an open

window, and he is told to "catch the casket," which, it is presumed, she throws to him. But she is here represented as having descended with it in her hand, and still carrying it, while she looks timidly and warily round, as if dreading lest her movements should be watched by some concealed tale-bearer. The *mise en scène* is rather dramatic, yet the conception is bold, the two principal figures are effectively grouped, and the play of light and shade brings them both well forward.

'EVANGELINE,' another of the engraved examples, was painted last year for Mr. Colls, who kindly permitted us to copy it while in his possession; the picture now belongs to Mr. Thomas Baring,

and was never exhibited publicly. Here is the "keeping-room" of Benedict Bellefontaine, "the wealthiest farmer of Grand-Pré;" in the background is the worthy owner, about to commence a game of draughts with his old friend, Basil Lajeunesse, the village-blacksmith. Before them stands René Leblanc, the notary, who has been called in, "with his papers and inkhorn," to prepare the marriage-deeds between Evangeline and Gabriel Lajeunesse; "for this is the night of the contract"—

"Orderly all things proceeded, and duly and well were completed,
And the great seal of the law was set like a sun on the margin."

But before leaving the two friends to their game, the old notary

has risen from his chair, and drinks to the health of the bride and bridegroom from

"the pewter tankard with home-brewed
Nut-brown ale, that was famed for its strength in the village of Grand-Pré."

* * * * *
"Meanwhile apart, in the twilight gloom of a window's embrasure,
Sat the lovers, and whispered together, beholding the moon rise.
Over the pallid sea and the silvery mist of the meadows
Silently, one by one, in the infinite meadows of heaven,
Blossomed the lovely stars, the forget-me-nots of the angels."

Here again, as in the 'Jessica' picture, Mr. Hillingford has taken poetical license with Longfellow's description; for Evan-



Drawn by W. J. Allen.]

BEFORE THE TOURNAMENT.

[Engraved by Butterworth and Heath.

geline and her companion are not looking out on the landscape; their backs are turned towards the window, and they seem too much occupied with each other to notice anything that is apart from them. Yet this deviation from the strict letter of the text in no degree lessens the interest of the picture itself: we have the spirit of the story graphically set forth; while the work itself is a most pleasing example of *genre*-painting.

Of other works painted, but not exhibited, by this artist, we may point out 'The King! over the water,' in the possession of Mr. Fox, of Manchester; 'Prince Charlie at Carlisle,' the property of Mr. Jardine, of the same city; and 'The White Cockade,' in the possession of Mr. F. Wilkinson, of London. This last picture

formed the subject of one of our recent large engravings. Mr. Wilkinson also possesses 'The Marriage Contract.' In the collection of Mr. W. Cotterill, of Lower Broughton, Manchester, are 'The Marriage Contract' and 'The Ante-room,' both of them small finished studies for the larger pictures; and in the King of Wurtemberg's palace of Rosenstein, near Stuttgart, is another of Mr. Hillingford's works, 'A Neapolitan Boat and Peasants.'

This artist is evidently not wanting in patronage; still we would suggest to him whether it would not be to his interest to show himself more than he has hitherto done in the London galleries: there is no fear that he would be unable to hold his own among his compeers.

JAMES DAFFORNE.

SELECTED PICTURES.

FROM A DRAWING IN THE COLLECTION OF
H. J. TURNER, ESQ., HAMILTON TERRACE,
ST. JOHN'S WOOD.

DANTE.

J. L. Gérôme, Painter. C. H. Jeens, Engraver.

ADMITTING the genius of M. Gérôme, who takes rank with, perhaps, the greatest of living French painters, it must, with equal reason be allowed that his most important works do not, with some few exceptions, tend to elevate the true dignity of Art. Sensuous representations of classic history or mythology are not those which refine and purify the mind, but the contrary; and even such subjects as 'The Death of Marshal Ney,' in the Royal Academy Exhibition of last year, records only an act that had better been left to the pen of the historian. It is no sentiment of false delicacy which constrains the remark, that pictures like M. Gérôme's 'Bacchus and Cupid intoxicated,' and his 'Cleopatra before Caesar,' the latter exhibited this year in the Royal Academy, are works tending to demoralise, more than to chasten and exalt, the feelings; and are unworthy of the pencil that produced 'Le Siècle d'Auguste,' and 'Dante.'

Of this last subject the artist painted a large picture in oils, which was engraved, of a commensurate size, by J. G. Levasseur, for Messrs. Goupil and Co. The original study was, we believe, made in water-colours, or a copy of the painting in that medium was taken by M. Gérôme—for we are not certain which was actually the case—and was purchased by its present owner, Mr. Hamilton, who has kindly permitted us to engrave it: the drawing is of large dimensions and very beautifully executed.

The story of the life of this great Italian poet, who is considered as second only to our own Shakspeare in delineating human character, is most eventful and interesting. Taking part, and a prominent one, in the factions which convulsed almost every city of Italy in mediæval times, Dante was, in 1302, heavily fined, and, on non-payment of the same, exiled from Florence, his native place. By a second sentence, decreed two or three months later, he was condemned to be burnt alive: but he had already left the city, commenced his long wanderings through several parts of Southern Europe, and never returned to Florence. And this brings us to question the truth, as regards locality, of M. Gérôme's picture. The scenery is evidently that of the outskirts of Florence, the Duomo of which is on the left in the distance. Dante is here represented as a comparatively aged man, but he was in the prime of life when he quitted the city, never to enter it again: it is clear, therefore, that so far, the composition is merely ideal. It appears, however, that after he had written the *Inferno*, he became quite an object of fear to the ignorant and superstitious, and was pointed out as he walked through the streets or along the highways, with the remark,—*"Voilà celui qui va en enfer et en revient."* This is the point of the picture: the man who, as was said of him, "had been into hell and had come back again," is taking his evening walk moodily; but probably thinking more of the political state of his country, or of poetic writings not yet penned, than of the dread his presence inspires in those around him. The figure of Dante is very impressive, but the composition as a whole is scattered; and the woman with a fractious child is ill-drawn: the picture would be better without this group.

THE DRAWINGS

OF

M. ANGELO AND RAFFAELLO
AT OXFORD.*

A CRITICAL account of the magnificent series of drawings of these great masters at Oxford was a desideratum, and we are glad that Mr. Robinson, who is so well qualified to judge of their merits, has devoted his attention to them. In the introduction to the work before us, an interesting account will be found of the collection of which the series at Oxford is a part.

The passion for collecting ancient drawings was originated in England by Charles I. and the Earl of Arundel. What was most valuable in the collection of the latter was afterwards secured by another great collector, Sir Peter Lely, who also acquired valuable examples of the Royal Collection. In 1680, Lely's collection was dispersed by auction, and collecting drawings by the old masters became the fashion. Fine assemblages were made by the Richardson, and Sir Joshua Reynolds was an enthusiastic collector.† George III. formed the great series at Windsor Castle. But Sir Thomas Lawrence reaped the richest harvest, with the assistance of the brothers Woodburn, from the spoils of France, Italy, and Spain. The Chevalier Wicar obtained in the latter countries a valuable assemblage during the progress of the army there. Mr. W. Y. Otley secured a large portion of these, which were afterwards purchased by Sir T. Lawrence for £10,000; and the latter also secured from the Baron le Non some fine examples collected by the Zanetti family, of Venice. Some of these had been in the Arundel Collection. Mr. Woodburn purchased for Sir Thomas, in 1824, several exquisite drawings of Raffaello from the Marquis Antaldi, of Pesaro. These had never been out of his family; the marquis was a descendant of Timotes della Vite, a scholar, and the executor of Raffaello. By this means the splendid portrait of Timotes della Vite, "the finest head ever produced in black chalk," was added to the collection. Mr. Robinson prints, for the first time, a curious MS. catalogue of pictures and drawings of Raffaello, in the possession of the Antaldi family, written in the seventeenth century. The marginal word *venduto* (sold) was added to the entries of the drawings selected by Crozat, twenty-six in number. This catalogue was given by the marquis to Woodburn, and was presented to the University Galleries by the Rev. H. Wellesley, Principal of New Inn Hall. In 1820 the purchase of the collection of Mr. Dimsdale for £5,500 rendered the Lawrence Collection the finest in existence. On one occasion Sir Thomas purchased an entire collection for £2,200, simply because it included six drawings by Raffaello and Michel Angelo.

These facts are sufficient to show the magnitude and importance of the Lawrence Collection. Sir Thomas had expended at least £40,000 upon it. He died in 1830, and wished his collection to be offered to George IV. for £18,000; and, if the king did not desire to possess it, successively to the trustees of the British Museum, to Sir R. Peel, and to the Earl of Dudley. If all declined, and a purchaser could not be found on the Continent, the collection was to be dispersed by auction. The persons named refused the offer, and a subscription was got up to purchase the drawings for the National Gallery, but this failed, and the Messrs. Woodburn ultimately purchased the collection for £16,000. These gentlemen organised a series of ten exhibitions in London, each comprising 100 drawings. Private amateurs purchased several sections, but

* A CRITICAL ACCOUNT OF THE DRAWINGS OF MICHEL ANGELO AND RAFFAELLO IN THE UNIVERSITY GALLERIES AT OXFORD. By J. C. ROBINSON, F.S.A. Oxford, Clarendon Press, 1870.

† Sir Joshua's collection was sold in 1794 at fixed prices. It included 54 by Correggio, 28 by Annibale Caracci, and 18 by Lodovico Caracci, 70 by Vandyck, 9 by Fra Bartolomeo, 32 by Tintoretto, 43 by Giulio Romano, 12 by Leonardo da Vinci, 44 by Michel Angelo, 22 by Rubens, 24 by Raffaello, 19 by Rembrandt, and 13 by Titian.—Leslie and Taylor's "Life and Times of Sir J. Reynolds," (ii., 635).

not those of M. Angelo and Raffaello. The latter were sent to Holland for the inspection of the Prince of Orange (afterwards King William II.), who wished to have 'part. Fortunately, as Mr. Robinson observes, "the knowledge and experience of the royal amateur were not on a par with his zeal." He selected the largest and most showy drawings, being chiefly copies and drawings by scholars and followers of the great artists. In 1842 the University Galleries at Oxford were in course of erection, and the drawings remaining in the possession of the Messrs. Woodburn were purchased by public subscription. This would not have been done had not the Earl of Eldon supplied the £4,000 required to complete the purchase (£7,000). A munificent gift of £1,200 by the present Lord Eldon should be mentioned, given for the purpose of providing books, prints, photographs, &c., to assist in the study of this noble collection. In August, 1850, the Art-treasures of the King of Holland were sold at the Hague. Mr. Woodburn purchased most of the M. Angelo and Raffaello drawings, and united them to the residue of the Lawrence Collection still in his possession. When he died, in 1853, they were offered for sale at Christie's, but the biddings were so low that the sale was stopped. In 1860 they were sold by the same auctioneers; and Mr. Robinson points out that "not till then were any of the Lawrence drawings purchased by the Government; and even then, although a special grant of money was made by the treasury to the British Museum for the purpose of acquiring the finest works in the sale, so little understanding was there of the paramount value and importance of the specimens on the part of those charged with the disposal of the grant, that a large proportion of incomparable drawings of Michel Angelo and Raffaello passed into the hands of private collectors at little more than nominal prices, whilst after the sale a sum of several hundred pounds, sufficient to have purchased them twice over was actually returned to the treasury as an unexpected balance." Well might Sir Digby Wyatt, in his recent lectures at Cambridge, regret that we have not a minister of Fine Arts, and observe that "our nobility and our rulers show but little signs of sympathy, while royalty itself has shed but a weak and ineffectual ray upon the progress of Fine Art in England." Of course, the name of the late Prince Consort will ever be an exception to this; and in Mr. Robinson's work we observe he states that not the least of the services rendered to Art by the Prince was the formation of a complete collection of illustrations, in every possible vehicle, of the works of Raffaello. This collection is preserved in the Royal Library, Windsor Castle.

Photography has been of immense assistance to the student and collector of ancient drawings. Before this invention, the comparison of actual fac-similes of dispersed drawings was practically impossible.

To give an idea of the interesting matter contained in this volume we select two criticisms—one on works of M. Angelo, and the other on those of Raffaello.

"M. Angelo (p. 28.) Torn leaves from a small sketch-book, now joined together as a single sheet, containing first sketches for the ceiling of the Sistine Chapel, chiefly drawn with the pen in bistre. It may be safely assumed that these sketches were made in A.D., 1508, Michel Angelo being then [in his thirty-third year. He had just completed (Feb 21) and fixed in its place at Bologna, the colossal bronze statue of Pope Julius II; and he appears to have returned for a very short time to Florence, and to have gone on to Rome some time during the ensuing month of March. He expected then to have been able to proceed with the marble tomb, which he had begun three years previously for the Pope, and which had been necessarily in abeyance during his and the Pope's absence at Bologna; but Julius, in the interim, had formed other plans; and in spite of M. Angelo's disinclination to burthen himself with so vast an additional undertaking, the Pope determined to set him to work at once to paint the ceiling of the Sistine Chapel, and we know, from a record in M. Angelo's own hand, that he made a beginning on the 10th of May, A.D. 1508. There is



C. H. JENNS. SCULPT.

DANTE.

THE DIVINE COMEDY OF DANTE ALIGHIERI. TRANSLATED BY J. J. PURNELL. ESQ. HAMILTON, 1847.



little doubt therefore, that the present sketches were made some time betwixt the above period and the end of the same year; and the date '15th September,' which occurs on one of these sheets, probably indicates the exact day on which the drawings on that particular leaf were executed. . . . The book of which these leaves formed part would seem to have been the vehicle in which Michel Angelo, having settled the general disposition of his design, proceeded with a certain amount of system and order to work out his ideas in detail: with this, in fact, he may be presumed to have entered on the second stage of his labours. These sketches are not, as Ottley intimates, jottings from nature made in the streets of Rome; but on the contrary rapid conceptions, some of them entirely momentary and original; others are, perhaps, further developments of thoughts and motives already shadowed out in the general design. . . . These leaves afford us a vivid illustration of the practical method by which the great work in question was, as it were, gradually built up; and they form a singularly interesting and important record of the workings of the mightiest mind which, perhaps, ever concerned itself with the plastic Arts." (Then follows a detailed account of the sketches.)

"Raffaello (p. 47.) Seven men seated at table; a study for a portion of a composition of the 'Last Supper.' This most beautiful drawing is doubtless a first study from living models in the costume of the day, for one half (the left side) of a design for the above-named subject. . . . The drawing is squared over for enlargement, an indication that it was intended to be further worked out as a cartoon; no correspondent composition is, however, known to have been carried out in a finished shape by Raffaello. There is no resemblance betwixt these figures and any of those in the *fresco* ascribed to Raffaello, discovered a few years ago in the Convent of St. Onofrio at Florence. A comparison of this with Leonardo da Vinci's famous 'Cenacolo' at Milan, would certainly not be to the disadvantage of Raffaello."

Mr. Robinson gives 80 figures of the paper marks copied from the sheets of paper on which original drawings and written documents by Michel Angelo and Raffaello were executed. It is needless to remark on the utility of these, as they often furnish important information on the date, or place of execution, of a drawing. We will, however, give one example. On letters written by M. Angelo from Bologna, in 1506, when engaged in the production of the colossal bronze statue of Pope Julius II., afterwards destroyed, the marks are the capital letter B, probably for Bologna, the paper being doubtless purchased by him there. No drawings of this work are known to exist, but Mr. Robinson points out that in drawings of the great master yet to be brought to light, studies of the lost work may be identified by the capital B as the water-mark.

INTERNATIONAL EXHIBITION. THE FRENCH PICTURES.

THE French Fine Art Exhibition is set forth, chiefly, in Room XX., and in number amounts to 430 works, wherein is represented not only every acknowledged department of painting, but every technical and sentimental by-way into which painters may have been tempted by eccentricity or the mere longing for novelty. A great majority of the pictures has been sent by the artists themselves; there are, however, among the contributors the names of the Baroness Burdett Coutts, Mr. Gladstone, M.P., Mr. Theodore Martin, Mr. Thomas Baring, the Marquis of Westminster, the Duke of Wellington, Mr. Bolckow, M.P., Mr. John Graham, &c. It would appear, *primâ facie*, that the selection has been made with a presumed deference to English tastes; that there is just enough of the well-

known high savour of French Art to counteract a suspicion that we do not see the extremes to which it has attained. Of the larger pictures are some of a very high degree of excellence; but the power of the collection is shown in the smaller works, and it is difficult to see how certain of these, in their peculiar qualities, can ever be surpassed. The pictures being almost wholly of very recent production, cannot be accepted as a representation of what may be comprehensively called the French school. Many we have seen before, and some have been even lately described in the columns of the *Art-Journal*.

By works more or less valuable we are reminded of Boucher, David, Horace Vernet, Delaroche, Ingres, Ary Scheffer, Roqueplan, Prudhon, &c.; and charmed by others to which attach the names of Meissonier, Rosa Bonheur, E. Frère, Henriette Brown, Cabanel, Gérôme, and others.

Prominent among the most remarkable in the twentieth room is DELAROCHE'S well-known 'Marie Antoinette' (1,201), the large picture. Although on her-way to execution, and the term of her life may be counted by minutes, we cannot doubt the truth of that expression of ineffable scorn with which she regarded even the extreme measures of her persecutors, the intensity of which the artist has so well depicted in those worn features. We see in this fine work an admirable instance of that wholesome tendency to sober and earnest narrative which Delaroche promoted and exemplified, but which has been superseded not by the dramatic, but by the theatrical, and ultimately by the horrible, as we see in Regnault's 'Execution in a Moor's Palace,' a sickening example of a taste too prevalent among the living school of France, but which the painter,—who, unhappily for his artistic fame, for he had talents that would have raised him to a high position, fell in the recent war in France,—will never exhibit again.

In contrast to 'Marie Antoinette,' there is also Delaroche's 'St. Cecilia,' which has always struck us as a finished study, intended for mural painting in a dim light. The profile head of the nearer of the angels reminds the spectator of that of Delaroche's Angel Gabriel, which was painted from a woman, most probably Madame Delaroche (*née* Vernet), who sat for the bright figure in the picture representing Michael Angelo descending the stairs of the Vatican. It need scarcely be observed, that this is essentially an exhibition marking rather the conditions of the day, than professing in anywise to set forth those of an anterior period: thus, the few of the earlier magnates whom we meet with are rather alluded to than represented.

We are reminded of L. DAVID by his 'Death of Marat,' a picture of which we have spoken in an antecedent number; of GREUZE by several works; and of others likewise; but on these examples it is inexpedient to dwell, as for instance, INGRES is referred to by two studies, which have been already noticed, and HORACE VERNET by 'A Bitch and Pups' (1,483). Be it not forgotten, that immediately above Delaroche's 'Marie Antoinette,' there is a large picture of transcendent merit, which is not named in the catalogue; hence it is presumable that it was hung after the catalogue was printed. Such vexations are of continual occurrence where exhibitions are open to supplementary addition, but in such case, care should be taken to label the works that are not named in the catalogue.

In seeking to signalize the features of French Art as distinguished from that of

other countries, we are greatly impressed by an accidental gathering of a few small pictures in a corner of the large room illustrating a *genre* of painting that the French may fairly call their own. 'Le Souper,' by MOREAU, who lived in 1776, presents an example of the small cabinet picture of the last century; which was always in its pretension of greater social refinement than the corresponding vein of Dutch Art. Near this little work hangs 'Le Vieux Savant,' by MEISSONIER, a miniature, it may be called, of the rarest excellence—the very perfection of that kind of painting which has been left for Meissonier to carry out to its *ne plus ultra* of harmonious beauty. With this little picture may be compared, though disadvantageously, 'L'Amateur de Graveurs,' also by Meissonier, which, in presence of the other, shows somewhat hard and mealy, yet in the absence of the other would be regarded as a performance in every way worthy of its author.

There are distributed through the rooms some of the best efforts of members of this section of French figure-painting, but they are all deficient in that masterly power of elastic concentration shown in the works to which they owe so palpably their impulses. 'Le Vieux Savant' is a miniature, but it comes forward with a scope and largeness suggestive of a life-sized composition. In this following—and they may be proud of their success—are CHAVET, in 'Le Peintre'; DUVERGER, in 'La Bonne Aventure'; PECRUS, PLASSAN, and others.

We are reminded of ARY SCHEFFER by his 'Margarite' (1,297). It is the figure seated in the large chair, and is the weakest of his studies from *Faust*. It was exhibited in Paris with his other works after his death. DUBUFE'S portrait of Rosa Bonheur is seen here better than when exhibited elsewhere; that admirable and characteristic picture in which Mdlle. Bonheur appears with her right arm thrown over the neck of a red bull. We know of three *réplique* of this fine work. As the name of this lady occurs to us here, it may not be out of place to note that of her works, there are 'Returning from the Mill' (1,141), and 'The Forest of Fontainebleau' (1,142),—the large picture representing a family of deer alarmed on the plateau of Fontainebleau. It was exhibited in this country a few years since, and is the property of an English collector;—as is also 'Returning from the Mill,' in which the usual forms of composition professed by this artist are not observed, yet it is in everything equal to her best works. By M. GUDIN are 'Sunset at Sea' (1,233), another picture with the same title (1,234), and 'Wreck' (1,235); the most remarkable of this painter's works is the large picture described by us on the occasion of the notice of the magnificent gathering shown in the Gallery of British Artists for the relief of the French refugees during the late war.

By the ornamentist BOUCHER are no fewer than four pictures (1,326 to 1,329); the subjects and manner of these works have that savour of decorative Art by which a mural painter is always betrayed; yet they bear the impress of Boucher's genius, whose compositions have, in their particular line, never been surpassed. 'Truth' (1,375), J. LEFEVRE, is a life-sized nude figure, holding aloft a lighted lamp. The picture is striking for two reasons—first, because it is well-drawn and painted, and again, because it is by no means clear what reference such a figure bears to Truth. 'Falstaff at the Eastcheap Tavern' (1,537), L. OLIVIE, is the least inviting and the most difficult to

paint of all the scenes of which Falstaff is the hero: the success here is very partial.

By DAUBIGNY are landscapes characterised by great simplicity as based upon one point of effect, which is always conspicuously worked out. They are 'The Banks of the Oise' (1,183), 'Sunset' (1,187), 'Moonlight—Picardy' (1,188), and some others. Strongly contrasting with these, there is by LEGAT, but without number or title, a farm-house embowered in trees, and painted with the utmost realism of old Dutch Art. It has been zealously worked out on the spot, and if, in what is called execution, it differs widely from Daubigny's essays, how much more does it from those of COROT, who stands alone in his manner of reading nature, as shown in 'The Border of the Forest' (1,169), 'River Scene' (1,170), 'Evening—Country near Rome' (1,172), and others. Another feeling for landscape is exemplified in the studies of N. DIAZ DE LA PENA, notably in 1,208, 'Forest of Fontainebleau,' which is very freely worked with a full firm touch, but with particular attention to the definition of masses. M. de la Pena exhibits also 'Venus and Adonis' (1,207), 'Venus and Cupid' (1,210), 'Garden Party' (1,211), &c.; all these are strictly imitative of the emanations of the old Italian schools, with the difference that the figures are not so elegant. In No. 1,512, M. PERRIN FEYEN affords us a new version of Ophelia, who is represented standing at the water's edge in strong opposition to the moonlight. The picture recommends itself by its entire absence of affectation. There is another single figure of great merit by the same hand, called 'On the Beach' (1,513), and also the more ambitious subject 'Professor Velpéau and his Pupils' (1,363). The examples of E. FRÈRE are more varied and somewhat larger than we generally see: they are 'The Patient' (1,226); 'Coming out of School' (1,227); 'Preparing for Breakfast' (1,228); and 'Crumbs of the Cake' (1,430). From these we see that when M. Frère entertains a distributive subject, he shows the difficulties presented in such case to an artist who has confined his attention principally to concentrative incident. In 'Coming out of School,' for instance, the finish is even more cautious than in 'Preparing for Breakfast,' but the local objects in the former importune the eye to the disadvantage of the life of the story, while in the latter the figures are, by special appointment, the leading argument. The singular beauty of M. Frère's smaller works suggest a comparison which were uncalled for in the case of painters of inferior power. 'A Kitchen' (1,545), is the only contribution by RUIPEREZ, one of the most distinguished of the followers of Meissonier; and of PLASSAN, 'Dressing' (1,467), is the only specimen; there are, however, four of PECRUS, 'The Young Mother' (1,385), and three others, all of which sustain the reputation of the artist as a professor of minute and careful finish. 'The Ladies of St. Cyr performing *Athalie*' (1,415), J. CARAUD, is a rehearsal of the play before the Court; Racine himself is present as prompter, and, as may be supposed, the scene has more of the drawing-room than the stage. There is greater point in 'Louis XI.' (1,306), E. R. THIRION, wherein we see the king, attended by Olivier le Dain, contemplating the gambols of a kitten: this picture is forcible and characteristic. 'A Cervarolle' (1,241), E. HERBERT, is really a triumph in *chiaroscuro*, and shows what can be done even with a single figure; and to instance a dissimilar subject, showing an equal amount of study in another direction, there

is an extraordinary depth of agonised expression in the 'Magdalene' (1,270), by H. MERLE; and in 'Ruth and Naomi' (1,264), E. LEVY, the figure of Naomi with the child forms a group of such perfect grace as to distance every other passage of the picture, which is none the worse for its savour of Andrea del Sarto.

'Solitude' (1,160) pronounces itself at once the emanation of a master,—it is by CABANEL, the only picture by him in the Exhibition. 'A Circassian Girl' (1,258), C. LANDELLE, is a study of a head which has been worked into high pictorial quality, with the ever present remembrance of the Fornarina in the Tribune at Florence. There are other excellent works by the same painter. We notice 'Cain' (1,308), A. TRIPET, to say that there is in it a strong dash of the caricaturesque altogether inconsistent with the subject. Cain is represented as an outcast and a fugitive, and is pursued by two large hands ready to clutch and crush him. By T. RIBOT, Nos. 1,389 and 1,390, respectively 'The Philosopher' and 'The Monk,' are impressive imitations of the Spanish School, especially of Ribera. Madame HENRIETTE BROWN is represented by only one picture (1,413), 'A Turkish School,' which is not in the usual line of her expositions; it is, however, a production of infinite beauty. We have recently seen more worthy specimens of L. Y ÉCOSURA than are exhibited here; the beauties, however, of 'The Studio' (1,426), and 'The Master Out,' (1,427), would materially aid the reputation of one less known than this artist. Highly interesting also are 'Henrietta of France' (1,138), F. BIARD; 'Marshal Saxe' (1,153), J. L. BROWN; 'The Amende Honorable' (1,194), E. DELACROIX; the works of ISABEY; those of ROYBET; the wonderfully-finished pictures of COOMANS, 'The Mirror' (1,422), and 'Study' (1,321); 'At Alma Tadema's House' (1,483), F. VERHAS; 'Before Fencing' (1,459), A. F. MONFALLET; 'Grief' (1,496), CAMBON; 'Scene from *Faust*' (1,525), A. LAROCHE, that wherein Faust sees Margaret at the Witches' Sabbath—a failure, from the great difficulty of the subject; 'Demosthenes' (1,526), LECOMTE; 'A Pantomime in Old Paris' (1,533), MONFALLET. Portraits are happily not numerous, we cannot, however, overlook that of the Countess Pepoli (Mdle. Alboni) (1,540), by PERIGNON, which is perfectly unaffected, and most successful in points committed to the discretion of the painter.

It will be observed that the highest reputation in landscape-painting, so called, is won by French artists rather by the expression of powerful effect than a faithful presentation of the face of nature. If we take as a standard Constable's 'Corn Field,' or Turner's 'Crossing the Brook,' we find the principles of such works very little regarded by French artists.

Of the landscape of LAMBINET is one example (1,256); but of the works of DUPRÉ there are not fewer than twenty, numbered from 1,212 to 1,224, and again from 1,354 to 1,360, presenting varieties of scenery, associated with cattle and figures. By C. PISSARO are two winter-subjects of much natural truth, 1,276 and 1,277; and the collection is not without specimens of T. ROUSSEAU, as 'Morning' (1,289), and 'Evening' (1,290). The works of this painter are often very powerful and strikingly original, and remarkable also in this class are a 'Landscape' (1,410), C. BERNIER, with more of natural beauty than we usually see in French representations of wood-scenery; 'View near Rotterdam' (1,444), T. JONGKIND; 'Twilight' (1,435), GIROUX; 'Land-

scape' (1,492), L. BELLY; and some others. Of the cattle-pictures of TROYON, some, especially the smaller ones, are among the best he has ever painted; they assure us at once that they have been studied not as portraits of animals, but as pictures; such are 'Landscape with Cattle' (1,309), again the same title (1,479), 'Sheep' (1,553), and others. So also do 'Cows Drinking' (1,161), L. CABAT; 'Horses' (1,239), J. HEREAU; 'Cow' (1,291), T. ROUSSEAU; 'Landscape with Cattle' (1,482), VAN MARCKE. And if we reduce some of the poultry-pictures to their fundamentals, who will say that they are not carried out according to the canon of what is called "high Art?" and although convulsed by the pedantry of the thing, we become subdued by the fascinations of such presentments. In company with C. E. JACQUE there is no Hondekoeter of the past fit to be named. We would also call attention to the superb flower-composition of LAYS, and to other works which offer much instruction to the student.

SAVAGE ORNAMENTS.

BY P. L. SIMMONDS.

It is strange to note how fashion is forced to fall back on old types, and to reproduce from bygone times things almost obsolete. Hoops, which had been long abandoned, come in again as crinolines—so with bonnets, and hair-dressing, and ornaments for the person. Many of the simple garlands of flowers for the head, the ostrich or egret plume, the shell bracelet, or necklet, were first set in fashion by uncivilised races. We improve upon some of their simple ideas, and perpetuate and extend many species of decoration which would otherwise be lost. What is the kohl or antimony used for the eyelids, the pearl-powder for the skin, and the rouge for the cheeks and lips, but the more finished application of the ochre, arnatto, and other dyes, of the early Britons, and of some savage tribes of the present day who glory in war-paint for state occasions?

So many of the native tribes are fast disappearing, as in Australia; or are becoming semi-civilised as in Africa, New Zealand, the Hawaiian and other islands of the Pacific, that a glance at some of their simple styles of ornament or decoration for the person may not be without interest. They naturally adopted for ornaments those objects which most readily came within their reach, such as glittering shells, brilliant insects, gandy feathers, necklaces of the sea-urchin or *echinus*, nuts and coloured seeds, and the teeth of animals. Even in everyday life in Europe, where the slender purse-strings will not admit of heavy gold ornaments, diamonds, and other costly gems, the original selection and taste of the aboriginal tribes have been adopted and improved upon, in shell-ornaments, whether for brooches, bracelets, or ear-drops; in glittering insects, or the teeth and claws of animals mounted in gold. A lady of our acquaintance, moving in the highest circles, wears a tooth of her dear departed, elaborately set in gold and jewels, as a pendant from the neck. We have but to visit the shops of some of our eminent naturalists to find jewellery, of the most savage origin, elaborated into adornments for the fair sex, as well as the stronger race, in what should be the most civilised nation of the world: wild boars' tusks, tigers' fangs and claws, cheetahs' tusks and claws, are made into necklets and ear-rings, bracelets and brooches, scarf-pins, whistles, seal-handles, &c., either set in gold or silver. A tiger's claw bracelet, set in gold, shown in the Indian collection at the Paris Exhibition of 1867, was prized at seven guineas. Any thing *outré* finds favour now-a-days. Necklaces of the tusks and teeth of the wild hog or peccary, the jaguar, the cayman, the alligator, the bynari, a species of fish, as worn by the Caribisi tribes of the Essequibo and Pomeroun river-districts, were shown in the

British Guiana section at the Paris Exhibition. A pair of Pianoghotto ear-rings, from the interior of Guiana, would prove rather too ponderous for our European ladies to have a chance of becoming fashionable. They are made of the large teeth of the water haas (*Hydrocherus Capybara*, Desm.), and are provided with an ingenious spring to keep them fast in the ear. Teeth seem a favourite species of ornament in widely-separated localities. The Indians of Rio Negro wear a girdle of the teeth of the ounce; the Zulus of Natal necklets of various teeth; and a shark's tooth suspended by a bit of black ribbon from the ear, is the favourite ornament of a New Zealand belle. A breast-armor of hogs' teeth is worn in the South Sea Islands; and bracelets made of curved boars' tusks from the same quarter may be seen in the South Kensington Museum. In the Christy collection there is an armet made of boars' tusks, which is worn when dancing by men of the Sandwich Islands; also an iron bracelet from Africa, bound round with fibre, to which is attached a large curved boar's tusk as a pendant. Necklaces of monkeys' teeth, with the *elytra* of the *Buprestis*, are common in Guiana. Sharks' teeth are used, too, for offensive purposes; spears and swords armed with these serrated teeth, and fighting gloves studded with them, are common in the Navigator's and other islands of the Pacific.

What a great variety of decoration does the gay plumage of the feathered denizens of the forest furnish to the aboriginal tribes! and many of these chieftains are as luxurious in their ambitious requirements as any European potentate: those feathers which are the rarest being the most highly prized. The crown or cap of feathers worn by the Caribis and other Indian chiefs in Guiana, has two of the tail-feathers of the macaw inserted at the back; and these choice feathers are, after use on state occasions, carefully preserved in hollow reed cases. In the feather caps worn by some Dyak chieftains of Borneo, the long tail feathers of the Argus pheasant appear to be a favourite ornament. In some of these are toupees of the tail-feathers of cocks and other birds, and the grotesque beak of the large hornbill (*Buceros rhinoceros*). A tassel of the skins of the toucan, attached to a necklace of peccary teeth, is also worn by the Accawai Indians, about the Essequibo river. The tassel is arranged to fall down the back.

The Kamtschadales and the inhabitants of the Kuriles, have the bills of puffins fastened about their necks with straps; and the wearers are always supposed to be attended with good fortune so long as they retain them there.

Never European drum-major gloried in such a decoration as the Kahili or feather sceptre, judging from specimens sent to the last Paris Exhibition; these are borne before persons of quality on grand ceremonies in the Sandwich Islands. They are of all colours and of all lengths; and there were also shown hair-collars, or necklaces of human hair, the ancient war-decoration of the Hawaiian chiefs. Queen Emma also sent some tippets of feathers, from a rare bird called the Oo (*Drepanis Pacifica*), whose plumage is entirely black, except a yellow feather on each wing. This article of dress, red and yellow, but where the latter predominates, is an ancient sign of high rank in the islands. What a hecatomb of black birds must have been killed to obtain their two choice feathers!

The *acangatara*, or head-dress of feathers, worn by some of the tribes of the Amazon river, is valued highly. It consists of a coronet of red and yellow feathers disposed in regular rows, and firmly attached to a strong woven or plaited band. The feathers are entirely from the shoulder of the great red macaw; but are not those that the bird naturally possesses, for these Indians have, according to Wallace, a curious art by which they change the colours of the feathers of many birds. It is thus described by him:—They pluck out those they wish to paint, and in the fresh wound inoculate with the milky secretion from the skin of a small frog or toad. When the feathers grow again they are of a brilliant yellow or orange colour, without any mixture of blue or green, as in the natural state of the bird; on the new plumage being plucked out, it is said always to come of the

same colour, without any fresh operation. The feathers are renewed but slowly, and it requires a great number of them to make a coronet, so we see the reason why the owner esteems it so highly, and only in the greatest necessity will he part with it.

Attached to the comb on the top of the head of the chieftain is a fine broad plume of the tail-coverts of the white egret, or more rarely of the under-tail coverts of the great harpy eagle. These are large, snowy-white, loose, and downy, and are almost equal in beauty to a plume of white ostrich feathers. The Indians keep these noble birds in large open houses or cages, feeding them with fowls, of which they will consume two a-day, solely for the sake of these feathers; but as the birds are rare, and the young is with difficulty secured, the ornament is one that few possess.

Strings of shells for necklaces and bracelets are a very common ornament among most savage littoral tribes. Captain Burton, in his work on Central Africa, states that cowries are used as ornaments for the neck, arms, and legs, and decorations for stools and drums. One tribe, the Wajiji, wear necklaces of small pink bivalves strung upon a stout fibre. The Cayapas, in the district of La Tola, Equador, both male and female, wear round their neck large collars of shells, small fruit, eggs, and teeth of the jaguar, alligator, and snake.

Small cowryshells are much employed for ornament in Africa and the East. *Cypræa annulus* is used by the Asiatic islanders to adorn their dress. Dr. Layard found specimens of it in the ruins of Nimroud. Raised cameos are produced on some small ones by the aid of acids which destroy the outer layer of shell where not protected by wax. In the Friendly Islands permission to wear the scarce orange cowry as an ornament is only granted to persons of the highest rank.

The skin jacket worn by some of the Bornean tribes in war is ornamented with cowry and other shells placed over one another like scales or links in a coat of armour. The Dyaks also stick these shells in the sockets of the skulls of their enemies, and they look like a closed eye. The use of these money cowries, as they are called, is not however restricted to savage tribes, for in India they are still much employed to ornament the trappings of horses and elephants. One of the valves of the *Spondylus*, which is also worn as a distinction of rank, is now most difficult to obtain. Sections of white cones, sufficiently large to go on the arm as a bracelet, are so much in request in the Pacific Islands that dealers in Europe obtain high prices for them. Very often rare terrestrial or fluviatile shells are obtained from these native necklaces: one which contained some such was stolen from an aboriginal figure at the Crystal Palace, as the shells were worth to collectors several pounds.

In full dress many of the Pacific islanders are decked out with large white *Ovula* shells appended to the waist, elbows, and ankles. Necklaces of *Natica* shells are also common in the South Sea Islands. Those made from the *Elenchus irisodonta* shell were always held in high estimation among the aboriginal women of Van Diemen's Land, worn as ornaments round the neck and head. The bright naere and play of iridescent colours, which doubtless first recommended them to notice, were brought out by partial decomposition and removal of the cuticle from long exposure after being cast up in a dead state. The aborigines effected the same end, artificially and systematically, by placing them in a thick dense smoke from green vegetable matter. Instead of employing pyroligneous acid, thus accidentally obtained, they afterwards came to use vinegar and friction to remove the epidermis, and then rubbed them with various fatty substances until a brilliant polish was acquired: they also boiled the shells with tea and other dyes to deepen the blue and green tints characteristic of them. Small holes were made in these shells by placing them between their eye-teeth, and giving them a nip, and they were then strung upon kangaroo-sinews. But the last of the aboriginal Tasmanians has passed away, and no more shell-necklaces can be obtained there.

The *Dentalium* shell is cut by the North American Indians into beads, of which they construct their wampums or treaty belts, and the sea-worn fragments are made into ornaments for their dresses. It is a milk-white round shell of extreme hardness, resembling the shank of a common clay pipe. It varies in length from 1 to 4 inches, and is about $\frac{1}{4}$ an inch thick, hollow, slightly curved, and tapering a little towards the ends. They are valued in proportion to the number that, when arranged on a string passing through their hollow tubes, extends a fathom's length: forty to the fathom is supposed to be the fixed standard of excellence and worth.

Many of the Esquimo have various unsightly modes of ornamenting, or rather disfiguring, themselves, in which shells are used. In their ears they wear strings of bones, mussel-shells, and beads. Some pierce the *septum* of the nose, through which they thrust quills or tubulose shells strung on stiff pieces of sinew; sometimes they insert two shells joined together, and tipped with a coloured bead at each end. Other tribes of Esquimo make a slit in the cheeks or in the lower lip for these ornaments. The two prevalent modes adopted are the following:—one consists in the upper lip being slit or cut quite through, in the direction of the mouth, a little below the thick part. This incision, which is made even in children at the breast, is often above 2 inches long, and either by its natural retraction when the wound is fresh, or by the repetition of some artificial management, assumes the true shape of lips, and becomes so large as to admit the passage of the tongue. This happened to be the case when the first person having this incision was seen by one of Captain Cook's party at Prince William's Sound, who called out that the natives had two mouths, which, this great voyager observes, it very much resembled. In this artificial mouth is placed a flat narrow ornament, made chiefly of a solid shell or bone, cut into little narrow pieces, like small teeth, almost down to the bone or thickest part, which has a small projecting portion at each end to support it in the divided lips, the cut part then appearing outward. The other mode is merely to perforate the lower lip in several places, when the ornaments consist of as many distinct shelly studs, whose points are pushed through the perforations; the beads appear within the lip, as another row of teeth immediately under their own. Attached to the studs from below are suspended small strings of beads which hang down to the point of the chin. These are not removed so easily as the lip-ornaments, which are at pleasure displaced and replaced by the tongue. Labrets, or lip-ornaments of metal and wood, are also used by the natives of Central Africa.

All the Hottentot females, and the Bush women, make, in a peculiar way, flat beads of the ostrich egg-shell, and of these form necklaces, fillets, and bracelets. I cannot well understand how these are uniformly cut out of such brittle substance, and the edges must be ground down with much patience. I was long puzzled with strings of these sections, and could not conceive what they were derived from, for after being long worn, they get much discoloured. Iron and copper armlets and glass and ivory arm-rings, with belts and strings of beads of different kinds, are the most esteemed ornaments throughout the greater part of Africa. Some of the heavy ivory armlets are inlaid with silver. In the region of the White River ear-rings of red copper are more fashionable than those of gold for the lobes of the ears, while rings of leather and of horn are those used in Kordofan.

The brilliant beetles originally used as ornaments by the Indians, as the *Buprestis gigas* for bracelets in Guiana, and the pearly *Pachyrhynchus pretiosus* and *scintillans* of the Philippines, the *Entimus imperialis* and *augustus* of Brazil, the *Præpodes regalis*, and others, are now frequently seen in our shops mounted as ear-rings, necklets, pins, &c.

We find in the southern parts of the new Continent many insects which seem to have been formed chiefly to gratify the eye by their brilliancy of colour, others that by the metallic reflection, which their carapace gives

forth in obscurity, may rival even the diamond. Such, for example, as the beautiful butterflies of the genus *Morpho*, and especially *M. Adonis* with its large blue wings, and *M. rhetenor*; *cypris*, *menelas*, *anaxibia*, &c., found in Cayenne, Brazil, and Mexico, the price in Europe of specimens of these for *parures* has often risen to £6 and £10. Others of smaller size are sought after by belles for their head-dresses at balls or soirées, owing to their elegant and dazzling colours, as *Chlorippes lawrence* and *C. cyanophthaline*.

As an ornament for the person on muslin ball-dresses, scarfs, silver-lace, silk-bags, &c., the *elytra*, or wing-coverts, of green and other brilliant coloured beetles, are often used in India; and garlands are occasionally made of them. In Rio Janeiro they are formed into artificial flowers, and some of the most elegant varieties are worn by ladies as ornaments in the hair. A small golden fly of an extremely brilliant colour is strung for necklaces by the country people of Chile, and they retain their brilliancy for a long time. One of the prettiest savage ornaments I have seen is a feather crown from Guayaquil, with long pendants of the *elytra* of the brilliant green beetle *Chrysochloris chrysochloris*, overlapping each other.

The Indian women ornament their head-dresses with the fire-fly (*Elater noctilucus*). The country ladies of Cuba imitating this, attach them to their bosoms through a natural aperture near their heads, which gives them no pain; and also fasten them in the flounces of their dresses when dancing, where, excited by the motion, the insects resemble so many large diamonds.

Nuts and seeds are another common form of savage ornament readily adapted to necklets and bracelets, and some of which are popular even in Europe at the present day, for rosaries, chains, bracelets, &c., either in their pristine state or carved and mounted in silver and gold; the most esteemed are those known as Brahmin's beads, the corrugated seeds of *Elaeocarpus ganitris*, the *quandong* nuts of Australia (the seed of the *Santalum acuminatum*), and what are popularly termed peach-stones from China, which are the elaborately carved seeds of a species of *Canarium*.

The seeds of *Monocera tuberculata* are used for bracelets and beads in Travancore. The nuts of *Putranjiva Roxburghii* are strung by the natives and put round the necks of their children as an antidote to keep them in health. The fruit of the doom-palm is turned into beads for rosaries in Africa, and also made into little oval-shaped snuff-boxes with a wooden peg for a stopper.

The red seeds of the wild liquorice plant of the tropics, which has a jet black spot at the top, and the larger scarlet seeds of the Indian red sandalwood tree, are often strung for rosaries and necklaces; so also are the grey bead-like seeds of the plant called Job's tears, the larger grey nickar beans, or bonduc nuts, the small black seeds of the Indian snot (a species of *Canina*), the larger black hard seeds known as soap berries, and the small brown seeds like apple pips, the produce of *Desmanthus virgatus*. Handsome bracelets and rings are carved out of the nut of the Awara palm (*Astrocaryum Awara*); it is black, very hard, and bears a high polish. The betel nut, the vegetable ivory nut, and various others, are also used in Europe for ornamental purposes, but these are turned and carved by more finished tools than the savage races have at their command.

The Kaffir is as proud of his snuff-box as his more civilised European brother; but then he feeds his nose with a spoon, and this and his snuff-box are worn over the ear. These snuff-boxes are made from tiny calabashes, nuts, and the young fruit of the baobab tree.

Even in the subject of dressing the hair how long are the peculiar customs of the aborigines to be preserved intact, or is European fashion likely to run in this direction? will our ladies copy some of the African customs next, as they have done the unsightly *chignons* of the Japanese belles?

The head-rings worn by married Kaffirs are formed by sewing a palmetto leaf to the woolly hair, and covering it with vegetable wax and charcoal. It is firmly attached to the hair

itself. The mode of dressing the great masses of woolly hair which lie upon the shoulders of the Balonda negroes reminded Livingstone of the ancient Egyptians. A few of the ladies adopt a curious custom of attaching the hair to a hoop, which encircles the face, giving it somewhat the appearance of the glory round the head of the Virgin. Others wear an ornament of woven hair and hide, adorned with beads. The hair of the tails of buffaloes, which are to be found farther east, is occasionally added. Sometimes they wear their own hair shaped on pieces of hide into the form of buffalo horns, or make a single horn in front. Occasionally the front hair is parted in the middle and plaited into two thick rolls, which falling down behind the ears, reach the shoulders; the rest is collected into a large knot, which lies on the nape of the neck: men dress their hair in this last fashion. The Bashingo negroes plait their hair fantastically. Some of the women weave their hair into the shape of a European hat, others arrange it in tufts, with a threefold cord along the ridge of each tuft; while others again, follow the Egyptian fashion, having the whole mass of wool plaited into cords, all hanging down as far as the shoulders. A chief of this tribe who visited Livingstone, wore his back hair made up into a cone about eight inches in diameter at the base, carefully swathed round with red and black thread. When the doctor, by way of getting into the confidence of the negroes of the Leeba, showed them his hair, they considered it was not hair at all, but thought he had made a wig of lion's mane, as they sometimes do with vegetable fibre, and dye it black and twist it so as to resemble a mass of their own wool. How closely do European females of the present day imitate this! Goat's hair, jute, and other vegetable fibre, is now dyed and made into artificial tresses, spread over frissons.

Like some of their more civilised brethren, the Maories of New Zealand are passionately fond of adorning their persons with trinkets and other ornaments. Ear-ornaments are in general use; they are worn by both sexes, and are of great variety. Those of greenstone (*poenamau*) are the most highly prized. The ear-pendants, of greenstone or jade, vary in form; some are narrow pieces from 3 to 5 inches in length, and others are round, thin, and flat. They are suspended by a piece of black ribbon. Sometimes ear-ornaments are made of the feathers of the Huia or Tui birds.

The breast pendant is generally also of nephrite or greenstone, carved into an uncouth resemblance of the human figure, the image being not unlike a Hindoo idol, having an enormous face with red scaling-wax eyes, and badly-shaped legs of disproportionate size. These "hei-tikis," as they are termed, are, some, about the size of shillings, and others as large as plates. The ornament is a sort of heirloom, being handed down from father to son. This greenstone or jade has for a long time been the most highly prized material employed by the Maories in the adornment of their persons: there are four varieties of it.

1. The *inanga*, the most valued, is rather opaque in appearance, and is traversed with creamy-coloured veins; the best ones are made of this kind. This is a ponderous weapon, weighing about 6 pounds, nearly 1 foot long, and in shape resembling a powder-flask flattened. Its edges are sharp as a knife, and in the handle is a hole for a loop of flax or leather, which is twisted round the wrist.

2. The *kaunairangi*; this variety is of bright green colour, with darker shades or mottled, and is the most translucent; it is a brittle material, and not easily worked; ear-pendants are frequently made of it.

3. The *kawa-kawa* is of a dark olive green, and has rather a dull and opaque appearance. The little images (*hei-tikis*) and ear-pendants are composed of it.

4. The *maki-tangi-wai* is the least esteemed by the Maories, but by far the most beautiful of all. It is of clear pale green, and is very translucent. The natives will drill a hole through a pebble of it, and hang it to a child's ear, but do not care to fashion it into any shape. It is the only kind of jade that would be esteemed for purposes of ornament by Europeans.

India can hardly be considered an uncivilised country, and yet some of the ornaments worn by females are savage and uncouth enough. The heavy masses of bangles of porcelaneous shell, or ivory, the *choories* or glass bracelets and armlets might be tolerated even in Europe by ladies who glory in being loaded with jewellery on arms, neck, breast, and ears; but what shall we say of the *nuth* or nose-rings, set with pearls, costing several guineas, and the silver enamelled toe-rings; and *erodias* worn on "the fingers of the feet?" The gold *runktees*, or head ornaments, worn by women, valued at five guineas, might also be popular here; and the *kinlai*, or comb, with a receptacle for oil, but not the *sulka*, or garland of cow-tail hair.

Mere verbal description conveys but a poor idea of the several styles of savage ornament I have passed under review, but it would be impossible to illustrate them fully. The Christy Collection, 103, Victoria Street, contains specimens of very many of those here alluded to, and much may yet be done to bring together, in ethnological collections, examples of these characteristic ornaments of aboriginal races who are fast fading away in America, Africa, Australia, and the South Pacific Islands, before the progress of civilisation—a civilisation which, however, has its foibles of vanity and love of finery as marked, and imitative faculties as strongly developed, as any of the rude races who are giving way before it.

SELECTED PICTURES.

FROM THE PICTURE IN THE POSSESSION OF THE PUBLISHERS.

THE REPROOF.

J. Coomans, Painter. J. Demannez, Engraver.

WITHIN the last very few years a field of subjects, new in modern annals of painting, has been taken possession of by several artists both here and abroad. We allude to the representation of Greek and Roman scenes, both historical and domestic; and a most agreeable variety do subjects of this class present in companionship with others depicting incidents of far later times, or of our own life.

Two Belgian artists have, among foreigners, especially distinguished themselves by works of this kind, Alma Tadema and Joseph Coomans. Our readers who remember the series of illustrated papers on the modern painters of Belgium will doubtless recollect that Coomans appeared in the list; and that we then engraved, in 1866, two of his pictures, delineating scenes of old Roman domestic life; both of them very elegant and attractive compositions. "The Reproof," which we now engrave, is equally meritorious, though more circumscribed in subject. A young Greek boy, who may possibly grow up to be a Leonidas, a Miltiades, a Pausanias, or, it may be, a Pindar or a Thucydides, has been guilty of some misconduct—perhaps broken his mother's distaff, which lies on the ground—and the lady calls the delinquent to her side to read him a lecture: but the "reproof" is given with true matronly gentleness, the smile on her face almost contradicting her words, while the little fellow looks upwards to his mother as if half ashamed of himself, yet assured of pardon. The group, with its surroundings, has somewhat of a statuesque character, yet it is unconstrained and perfectly natural; while the *negligé* arrangement of the masses of drapery gives great richness to the composition, and affords the artist opportunity for brilliant colour.

The administration of parental justice takes place on the vine-covered terrace of a villa overlooking the sea; perhaps, on one of the "glorious isles of Greece" which to this day are the delight of travellers.





THE MERCHANTS OF THE MIDDLE AGES.

BY THE REV. E. L. CUTTS, B.A.

PART V.

WE have, in a former paper, given some pictures from illuminated MSS., in illustration of the costume and personal appearance of the merchants of the middle ages; but they are on such a scale as not to give much characteristic portraiture—except in the example of the bourgeoisie of Paris, in the illumination from Froissart, on page 54—and they inadequately represent the minute details of costume. We shall endeavour in this paper to bring our men more vividly before the eye of the reader in dress and feature.

The "Catalogus Benefactorum" of St. Alban's Abbey, to which we have been so often indebted, will again help us with some pictures of unusual character. They illustrate people of the burgesse class who were donors to the abbey; the peculiarity of the representation is, that they are half-length portraits on an unusually large scale for MS. illuminations. When we call them portraits, we do not mean absolutely to assert that the originals sat for their pictures, and that the artist tried to make as accurate a portrait as he could; but it is probable that the dona-



No. 1.

tions were recorded and the pictures executed soon after the gifts were made; therefore, presumed, in the lifetime of the donors. It is moreover probable that the artist was resident in the monastery or in the dependent town, and was, consequently, acquainted with the personal appearance of his originals; and in that case, even if the artist had not his subjects actually before his eyes at the time he painted these memorials, it is likely that he would, at least from recollection, give a general *vraisemblance* to his portrait. The facts are very dissimilar, and all have a characteristic expression, which confirms us in the idea that they are not mere conventional portraits.

They seem to be chiefly tradespeople, rather than merchants of the higher class; and of the latter half of the fourteenth century. Here, for example (No. 1), are William Cheupaing, and his wife Johanna, who gave to the Abbey-church two tenements in the Halliwell Street. One of the tenements is represented in the picture, a single-storied house of timber, thatched, with a carved stag's head as a finial to its gable. This William also gave, for the adornment of the church, several frontals, with gold roses embroidered on a black ground; also he gave a belt to make a *morse* (fastening or brooch) for the principal copes, with a figure of a swan in the *morse*, beautifully made of goldsmith's work; also he gave to the refectory a wooden drinking-bowl or cup, handsomely ornamented with silver, with a cover of the same wood. He wears

a green hood lined with red; his wife is habited in a white hood.

The next picture (No. 2) represents Johanna de Warn, who also gave what is described as a well-built house, with a louvre, in St. Alban's town. This house, again, is of timber, with traceried windows, an arched doorway with ornamental hinges to the door, and an unusually large and handsome louvre. This louvre was doubtless in the roof of the hall, and probably over a fire-hearth in the middle of the hall, such as that which still exists in the fourteenth-century hall at Pevensey, Kent. The lady's face is strong corroboration of the theory that these are portraits.

Next (No. 3) is the portrait of a man in a

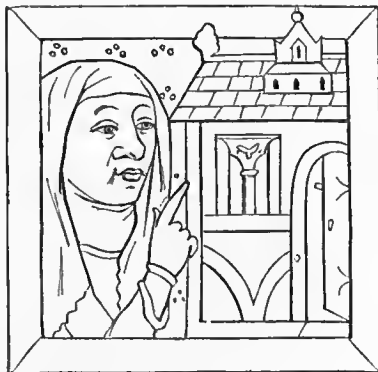

No. 2.

robe, fastened in front with great buttons, and a hood drawn round a strongly-marked face, reminding us altogether of the portraits of Dante.

The last (No. 4) which we take from this curious series is the picture of William de Langley, who gave to the monastery a well-built house in Dagnale Street, in the town of St. Alban's, for which the monastery received sixty shillings per annum, which Geoffrey Stukeley held at the time of writing. William de Langley is a man with regular features, partly bald, with pointed beard and moustache, the kind of face that might so easily have been merely conventional, but which has really much individuality of expression. The house—his



No. 3.

benefaction—represented beside him, is a two-storied house; three of the square compartments just under the eaves are seen, by the colouring of the illumination, to be windows; it is timber-built and tiled, and the upper story overhangs the lower. The gable is finished with a weather-vane, which, in the original, is carried beyond the limits of the picture. The dots in the empty spaces of all these pictures are the diapering of the coloured background.

But curious as these early portraits are, and interesting for their character, and for their costume, as far as they go, they still

fail to give us complete illustrations of the dresses of the people. For these we shall have to resort to a class of illustrations which we have, hitherto, for the most part avoided—that of monumental brasses. Now we recur to them because they give us what we want—the *minutiae* of costume—in far higher perfection than we can find elsewhere; we have avoided taking well-known examples already published, and have gone straight to the monuments themselves. Again, instead of selecting one from one part of the country, and another from another, we have thought that it would add interest to the series of illustrations to take as many as possible from one church, whose gravestones happen to furnish us with a continuous series at short intervals, of the effigies of those men who once inhabited the old houses of the town of Northleach, in Gloucestershire. This series, however, does not go back so far as the earliest extant monumental brass of a merchant; we therefore take a first example from another source. We have already mentioned the three grand effigies of Robert Braunché and Adam Walsokne, of Lynn, and Alan Fleming of Newark; we select from them the effigy of Robert Braunché, merchant of Lynn, of date 1367 A.D. We have taken his single figure (No. 5) out of the grand composition which forms, perhaps, the finest monumental brass in existence. The costume is elegantly simple. A tunic reaches to the ankle, with a narrow line of embroidery at the edges; the sleeves do not reach to the elbow, but fall in two hanging lappets, while the arm is seen to

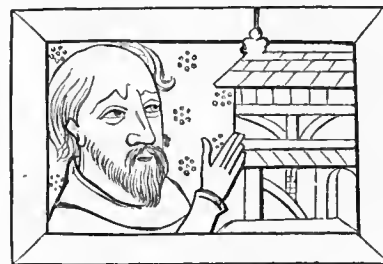

No. 4.

be covered by the light sleeves of an under garment, ornamented rather than fastened by a close row of buttons from the elbow to the wrist. Over the tunic is a hood, which covers the upper part of the person, while the head part falls behind. The hood in this example fits so tightly to the figure that the reader might, perhaps, think it doubtful whether it is really a second garment over the tunic; but in the contemporary and very similar effigy of Adam de Walsokne, it is quite clear that it is a hood. The plain leather-shoes laced across the instep will also be noticed. If the reader should happen to compare this wood-cut with the engraving of the same figure in Boutell's "Monumental Brasses," he will, perhaps, be perplexed by finding that the head here given is different from that which he will find there. We beg to assure him that our wood-cut is correct. Mr. Boutell's artist, by some curious error, has given to his drawing of Braunché the head of Alan Fleming, of Newark; and to Fleming he has given Braunché's head.

We feel quite sure that every one of artistic feeling will be thankful for being made acquainted with the accompanying effigy of a merchant of Northleach (No. 6), whose inscription is lost, and his name, therefore, unknown. The brass is of the highest merit as a work of Art, and has been very carefully and accurately engraved, and is worthy of minute examination. The cos-

tume, which is of about the year 1400 A.D., it will be seen, consists of a long robe buttoned down the front, girded with a highly-ornamented belt; the enlarged plate at the end of the strap is ornamented with a T, probably the initial of the wearer's Christian name. By his side hangs the *anlace*, or dagger, which was worn by all men of the middle class who did not wear a sword, even by the secular clergy. Over all is a cloak, which opens at the right side, so as to give as much freedom as possible to the right arm, and to this cloak is attached a hood, which falls over the shoulders. The hands are covered with half gloves. The wool-pack at his feet

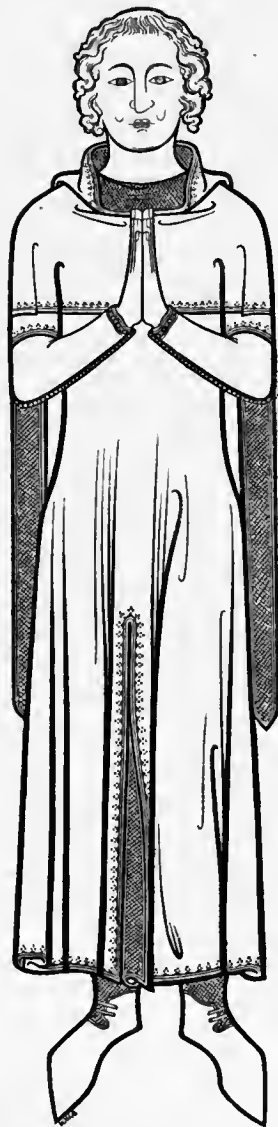

No. 5. ROBERT BRAUNCHE, OF LYNN.

shows his trade of wool-merchant. Over the effigy is an elegant canopy, which it is not necessary for our purpose to give, but it adds very much to the beauty and sumptuousness of the monument.

Next (No. 7) in the series is John Fortey, A.D. 1458, whose costume is not so elegant as that of the last figure, but it is as distinctly represented. The tunic is essentially the same, but shorter, reaching only to the mid-leg; and with sleeves of a peculiar shape which, we know from other contemporary monuments, was fashionable at that date. It is fastened with a girdle, though a less ornamental one than that of the preceding figure, and is lined and trimmed at

the wrists with fur. Very similar figures of Hugo Bostock and his wife, in Wheathamstead Church, Herts, are of date 1435; these latter effigies are specially interesting as the parents of John de Wheathamstede, the thirty-third abbot of St. Alban's.

The next (No. 8) is an interesting figure, though far inferior in artistic merit and beauty to those which have gone before: the name here again is lost, but a fragment remaining of the inscription gives the date MCCCC—with a blank for the completion of the date; the same is the case with the date of his wife's death, so that both effigies may have been executed in the lifetime of the persons. The date is probably a little later than 1400. The face is so different



No. 6. FROM NORTHLEACH CHURCH.

from the previous ones that it may not be unnecessary to say great pains have been taken to make it an accurate copy of the original, and it has been drawn and engraved by the same hand as the others. The manifest endeavour to indicate that the deceased was an elderly man, induces us to suspect that some of its peculiarity may arise from its being not a mere conventional brass, such as the monumental brass artists doubtless "kept to order," but one specially executed with a desire to make it more nearly resemble the features of the deceased. If, as we have conjectured, it was executed in his lifetime, this, perhaps, may account for its differing from the conventional type. His dress is the gown worn by civilians at

the period, with a *gyrcire*, or purse, hung at one side of his girdle, and his rosary at the other.

Lastly we give the effigy (No. 9) of another nameless wool-merchant of Northleach, who is habited in a gown of rather stiffer material than the robes of his predecessors, trimmed with fur at the neck and feet and wrists. The inscription recording his name and date of death is lost, but a curious epitaph, also engraved on the brass, remains, as follows:—

"Farewell my frends, the tyde abideth no man,
I am departed from hence, and so shall ye;
But in this passage the best songe that I can
Is requiem eternam.
Now then graunte it me,
When I have ended all myn adversitie,
Graunte me in Paradise to have a mansion,
That shed thy hode for my redemption."

The mention of fur in these effigies suggests the restrictions in this matter imposed by the sumptuary laws; but they

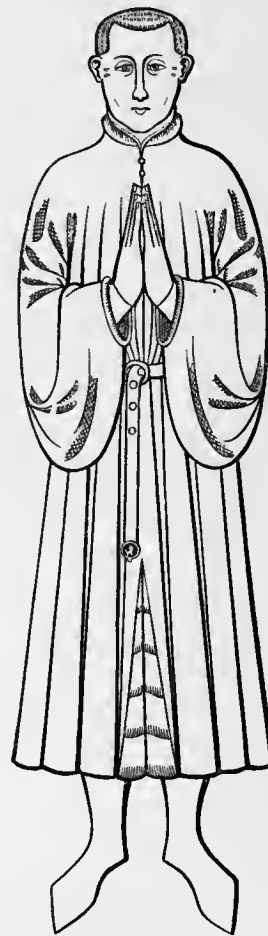

No. 7. JOHN FORTEY, FROM NORTHLEACH CHURCH.

were not very strictly obeyed; so that the king and his advisers sought from time to time to restrain the extravagance of the lieges. By the most important of these acts, passed in 1362, the Lord Mayor of London and his wife are respectively allowed to wear the array of knights bachelors and their wives; the aldermen and recorder of London, and the mayors of other cities and towns, that of esquires and gentlemen having property to the yearly value of £40. No man having less than this, or his wife or daughter, shall wear any fur of martins (martins?) letuse, pure grey, or pure minever. Merchants, citizens, and burgesses, artificers and people of handicraft, as well within the City of London as elsewhere, having goods and chattels of the clear value of £500, are allowed to dress like esquires and gentlemen of £100 a year;

and those possessing property to the amount of £1,000, like landed proprietors of £200 a year.

There are some further features in these monumental brasses worth notice. Knightly effigies often have represented at their feet lions, the symbols of their martial courage. Some of our wool-merchants have a sheep at their feet, as the symbol of their calling; this is seen in the wood-cut No. 10. A cut of a similar badge is placed on a separate plate below the effigy No. 8, but we have not engraved it. In another, in the same church, the merchant has one foot on a sheep and the other on a wool-pack; here the two significant symbols are combined—the sheep stands on the wool-pack. In both examples the wool-pack has a mark upon it; in the former case it is something like the usual "merchant's mark," in the latter it is shepherds' crooks, which seem to be his badge, for another crook is laid beside the wool-pack. At the feet of the effigy No. 7 is also his merchant's mark enclosed in an elegant wreath, represented in the wood-cut No. 11. The initials I and F are the initials of his name; the remainder of the device is the trade-mark. We give two other merchants' marks (Nos.

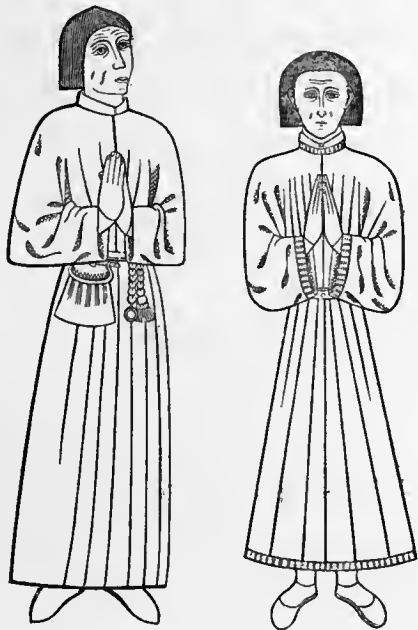

Nos. 8 and 9. FROM NORTHEACH CHURCH.

12 and 13); the first from the monument of No. 9, the other from that of No. 8. If the reader cares to see other examples of these marks, and to learn all the little that is known about them, he may refer to a paper by Mr. Ewing, in vol. iii. of "Norfolk Archæology."

We have in a former paper (p. 55) given from his monumental brass a figure of Alderman Field, of the date 1574, habited in a tunic edged with fur, girded at the waist, with a *gypcire* and rosary at the girdle, and over all an alderman's gown. In St. Paul's Church, Bedford, is another brass of Sir William Harper, Knight, Alderman, and Lord Mayor of London,* who died in A.D. 1573; he wears a suit of armour of that date, with an alderman's robe forming a drapery about the figure, but thrown back so as to conceal as little of the figure as possible. In the Abbey Church at Shrewsbury is an effigy of a mayor of that town in armour, with a mayor's gown

of still more modern shape. The brasses of Sir M. Rowe, Lord Mayor of London, 1567, and Sir H. Rowe, Lord Mayor 1607, both kneeling figures, formerly in Hackney Church, are engraved in Robinson's history of that parish. And in many of the churches in and about London, and other of the great commercial towns of the middle ages, monumental effigies exist, with which, were

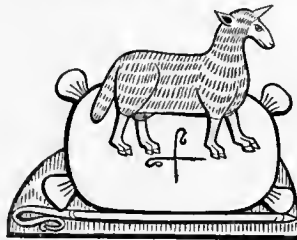

No. 10.

it necessary, we might lengthen these notes of illustrations of civic costume.

In further explanation of civil costume from MSS. illuminations we refer the artist to the Harleian "Romance of the Rose" (Harl. 4425, f. 47), where he will find a beautiful drawing, in which appears a man in a long blue gown, open a little at the breast and showing a pink under-robe, a black hat, and a liri pipe of the kind already given in the citizens of Paris, p. 54; he wears his purse by his side, and is presenting money to a beggar. At f. 98 is another in similar costume, with a "penner" at his



No. 11.

belt in addition to his purse. There is nothing to prove that these men are merchants, except that they are represented in the streets of a town; but their costume is such as was worn by merchants of the time.

With these costumes of civilians before our eyes we wish to use them as illustrative of a subject which was touched upon in a former series of papers in the *Art-Journal*, viz., the papers on the Secular Clergy of the Middle Ages; in the volume for 1864. We there devoted some columns to a discussion of the ordinary every-day costume of the



No. 12.



No. 13.

clergy, and stated that there was no professional peculiarity about it, but that it was in shape like that worn by civilians of the better class, and in colour blue and red and other colours, but seldom black. If the reader will turn back to pp. 333, &c., of that vol., he will find some wood-cuts of the clergy in ordinary costume; let him compare them now with these costumes of merchants. For example, take the wood-cut of Roger the Chaplain, on p. 333, and com-

pare it with the brass of No. 6 here given. The style of Art is very different, but in spite of this the resemblance in costume will be readily seen; the gown reaching to the ankle, and over it the cloak fastened with three buttons at the right shoulder, with the hood falling back over the shoulders; the half-gloves are the same in both, and the shoes with their latchet over the instep. Then turn to the priest on p. 334, and it will be seen that he wears the gown girded at the waist, with a purse hung at the girdle, and the flat cap with long liri pipe, which we have described in the costumes of these merchants. Lastly, let the reader look at these brasses of wool-staplers, and compare the gown they wore with the cassock now adopted by the clergy, and it will be seen that they are identical—i.e., the clergy continue to wear the gown which all civilians wore three or four hundred years ago; and in the same manner the academic gown which the clergy wear in common with all university men, is only the gown that all respectable citizens wore in the time of Henry VIII. and Elizabeth.

ART IN SCOTLAND AND THE PROVINCES.

EDINBURGH.—The exhibition in connection with the centenary commemoration of Sir Walter Scott, recently held in the rooms of the Royal Scottish Academy, proved most interesting and attractive; nor is this matter of wonder when we consider how warmly the undertaking was taken up by men of position and influence, and how liberal were the contributions of all kinds by those who possessed any object associated with the life and works of the great "Wizard of the North." Four rooms of the Academy Gallery were occupied with such objects. In the first room was shown a fine collection of tapestry and armour, suggestive of the tastes and pursuits of Scott; and in the centre is placed the model of the Scott Memorial, by Kemp, of which the late Robert Chambers wrote—"As long as it stands in its majestic and imposing beauty, the pilgrims of future centuries, who gaze upon it in silent admiration, will connect the name of the builder with the thought of him whom it commemorates." In the same room were statuettes of Scott and of characters found in his novels, as Jeannie Deans, Diana Vernon, Donnie Sampson, &c. In the remaining rooms were portraits in oil and personal relics of Scott; the latter, far too numerous to mention, being exhibited in glass-cases placed round the walls.

The general collection of pictures was very large. This department of the exhibition was intended to illustrate persons or historical incidents introduced by Scott into his writings, as well as portraits of his personal friends, the Ballantynes, Constable, Cadell, his publishers; Hogg, Mackenzie, Professor Wilson, Mackay, and others. Of historical portraits were Claverhouse, by Sir Peter Lely; James VI. and Anne of Denmark; Prince Charles Edward; Henry, Cardinal Duke of York; the Chevalier St. George; George Heriot, the founder of the Hospital in Edinburgh called after him, and the "Ginglin Geordie" of James I. Pictures, suggested by his novels and poems, by many of the best Scottish painters, abounded. In short, the whole gathering included so much that was valuable and interesting, that we regret not to be able to afford space for a detailed notice of it.

NORWICH.—In the year 1867 an exhibition of Fine and Industrial Art was opened in this city, the success of which has led to a second exhibition of a similar kind. This was opened by the Mayor, in St. Andrew's Hall, on the 2nd of August. About 400 oil-paintings, water-colour pictures, &c., were contributed, with a large assemblage of works of industry.

* Engraved in Fisher's Bedfordshire Collections, and in the London and Middlesex Archæological Society's Proceedings for 1870, p. 66.

THE TRIAL OF THE PYX.

A DOOR in the eastern cloister of Westminster Abbey leads to the celebrated chapel of the Pyx. In this mysterious chamber the Pyx (or *box of box-tree*) is deposited, containing a plate of gold and one of silver, to test the standard of the coin of the realm. This interesting room—access to which can only be obtained in the presence of representatives of the Secretary of the Treasury, the Chancellor and Comptroller of the Exchequer—forms a considerable portion of the only existing remains of the great abbey of Westminster, built by Edward the Confessor at a cost of one-tenth of the property of the kingdom. Edward, a Norman in his sympathies, built the first cruciform church in England, and the result of fifteen years' building was a Norman edifice, now destroyed, with the exception of the substructure of the dormitory. Two bays of the Confessor's work form the chapel of the Pyx. Mr. Scott notes that the stone altar remains nearly entire, having in the middle of the top a large circular sinking, probably for the reception of a portable altar-stone.* A detached *piscina*, in the form of a column, adjoins the altar. This chamber was the ancient treasury of England. For about 240 years it contained the most treasured relics of the State, such as the crowns of St. Edward and Edith, the "pilgrim's ring," the black rood of Scotland, the cross of St. Neot from Wales, the sword with which Athelstane cut through the rock at Dunbar—together with plate, jewels, and relics to a large amount. As a terror to evil doers, and to those who might cast longing eyes on the wealth within, the very door was covered with human skin. Dean Stanley says it is the skin of a fair-haired, ruddy-complexioned man. Fragments of human skin have been found on the doors of several churches in the country. Such relics have been usually assigned to the Danes; but Dean Stanley seems to think there is no period to which they can be so naturally referred, as that after the great robbery of 1303, to which we shall presently allude. At that time the building was altered and an inner chamber built. Mr. Scott says the door of the Chapel of St. Blaise, or old Ravestry, which occupies the space between the transept and the entrance to the chapter-house, was lined with human skin in the same manner. He thinks the persons whose skins were thus used were not necessarily Danes, but persons executed for sacrilege.

An immense hoard of money, plate, and jewels had in 1303 accumulated in the treasury chamber, when Edward I., in March, left Westminster for the Scottish wars. Two months after a great part of the treasure was carried off by a most daring and systematic robbery. Early in June the king heard of it at Linlithgow, and the Abbot and eighty monks were committed to the Tower. It seems extraordinary that more stringent measures were not taken to guard the hoard, which could not have been less in value than two millions and a half of our money, for four years before an attempt had been made to break open the treasury, and the Abbot, we are told, had to make "peace" with the king respecting it. The robbery was arranged by the sacrist of Westminster, Richard de Podelicote (who had been a travelling merchant), and the keeper of the Palace. The keys were in "a canvas pouch, sealed with the perfect seal of the king's cofferer," and carried by John de Drokensford, Master of the Wardrobe, who hurried to Westminster when he heard of the robbery. A man named Albon made the utensils to break open the treasury, and the cunning of the robbers is shown by the fact that early in the spring the green plot enclosed by the cloister had been sown with hemp, so that they might have some place to hide the treasure. It was said that the monks allowed this to be done, and purposely prevented a man entering who usually had the herbage of the cemetery. The king did not lose any time, writ after writ was issued, the chief criminals were taken, and the principal part of

the treasure recovered. Richard de Podelicote was the chief offender, and the following extract from his story will show the character of the spoil:—"He put a great pitcher with stones and a cup in a certain tomb. Besides he put three pouches full of jewels and vessels, of which one was 'hanaps,' entire and in pieces. In another a great crucifix and jewels, a case of silver with gold spoons. In the third 'hanaps,' nine dishes and saucers, and an image of our Lady in silver gilt, and two little pitchers of silver. Besides he took to the ditch by the mews a pot and a cup of silver. Also he took with him spoons, saucers, spice dishes of silver, a cup, rings, brooches, stones, crowns, girdles, and other jewels, which were afterwards found with him."* After this time the chief part of the royal treasures were removed to the Tower, but the regalia, the relics, records of treaties, and the Pyx, the subject of this paper, remained.† The regalia continued here in the custody of the Chapter till the time of the Commonwealth, and now the Box or Pyx is all that remains.

Assay of gold and silver is said to have originated with the Bishop of Salisbury, treasurer to Henry I. The first statute for its regulation was passed in 1238, and the first trial of the Pyx ten years after. At this trial twelve goldsmiths and an equal number of other citizens acted in the examination. The privilege of assay was in 1300 granted to the Goldsmiths' Company, and persons were forbidden to sell articles which did not come up to the standard. The Pyx trial seems to have taken place more frequently then than recently, for in 1344 it was ordered that the privy council and the authorities of the Mint should make the trial every three months.

From the Conquest to the reign of Henry VII. the coinage was never much debased with alloy, monarchs contenting themselves with reducing the weight of the pieces. Edward III. reduced the weight of the silver pennies from the previous general average of 22 or 22½ grains to 20½, and afterwards even to 18, but his splendid gold coinage was superior in weight and purity to any coins of the period in Europe. Henry IV. reduced the penny to 15 grains, and in the reign of Edward IV. the value of the precious metals had so increased that less of gold and silver was put into the coins. The standard of weight for the penny had fallen to 12 grains in the reign of Richard III., and so much light money was made in that of Henry VII. that it was enacted "that no person should refuse the king's coin of good gold and silver, on account of *thinness*, on pain of imprisonment or *death*." In the reign of his successor the weight of the penny was 10 grains, and no less than 2 ounces in 12 of alloy was employed. This was the third coinage; in the fourth the alloy was half the amount, and in the fifth even more than this. The trial of the Pyx must have been a great farce in this reign. The gold coinage was debased also, though not to such an extent as the silver. Mr. Noel Humphreys points out that the excessive debasement of the silver coin in this reign was the first blow struck against the regulations passed in previous reigns, to prevent the export of coin, for it caused foreigners to prefer merchandise or bills of exchange. Edward VI. wanted to improve the coinage, but it was more debased in his reign than before. The shillings often passed as sixpences, and in the reign of Queen Elizabeth these were stamped with a potcullis, and ordered to pass for 4½d. But as if this was not sufficient, the shilling was debased to 9 ounces of alloy to 3 ounces of silver. The king in his journal said, "It was appointed to make 20,000 pound weight somewhat baser, to get gains £15,000 clear." In the reign of Elizabeth the latter passed for 2½d. It is curious that at this time crowns and half-crowns were coined only 1 pennyweight worse than the ancient standard (11 ounces 2 pennyweights to 13 pennyweights of alloy). The credit of reforming the coinage has been given to Queen Elizabeth, and in this she was assisted by the great London merchant

Gresham. It is curious, that in the disturbed reign of Charles I. the coinage was never debased, however rude the piece, the proper purity and weight was maintained.

As the trial of the Pyx only took place at intervals, it was necessary for the masters and workers of the Mint "to mark a privy mark in all the money that they had made, as well of gold as of silver, so that at another time they might know, if need were, which moneys of gold and silver, among other moneys, were of their own making, and which not." After the trial had taken place they received their "*quietus* under the great seal, and to be discharged from all suits or actions concerning those moneys." The Mint mark was then changed, and continued till the next trial of the Pyx. There are really two boxes, each of which may be called a Pyx, one containing the standard, preserved at Westminster, and the other containing specimens of each *journey* (that is out of every 15 pounds of gold and 60 pounds weight of silver) kept at the Mint. The standard plates of gold and silver at Westminster were placed there in the time of George III.

For a number of years the trial of the Pyx has been held about every five years, but in 1870, pursuant to the Coinage Act, it was ordered to take place at least once every year. The *Times* remarks that it has been the custom for certain members of the Privy Council to attend on this occasion, and for the trial to be presided over by the Lord Chancellor, but Her Majesty now orders that the Queen's Remembrancer in the Court of Exchequer (who has hitherto administered the oath to the jury), shall preside at the trial, swear the jury, and receive their verdict. The trial of the Pyx, which took place July 18th this year, is the first under the Coinage Act of 1870. The Queen's Remembrancer, the Deputy Master of the Mint, the Warden of the Standard, the jurors, and the clerk of the Goldsmiths' Company, assembled at Goldsmiths' Hall, to "make the assays of these moneys of gold and silver, and truly report if the said moneys be in weight and fineness according to the standard weights for weighing and testing the coins of the realm, and the standard trial plates of gold and silver used for determining the justness of the gold and silver coinage of the realm in the custody of the Board of Trade." We have quoted the words of the oath administered to the jury. The standard fineness for gold coins, as set forth in the first schedule to the Act, is 11-12ths fine gold, and 1-12th alloy, or millesimal fineness 916.66. The remedy allowance being millesimal fineness 0.002. For silver coins the standard fineness is 37-40ths fine silver, and 3-40ths alloy, or millesimal fineness 925, the remedy allowance being millesimal fineness, 0.004 (*Times*, July 19th). The jury are also required to weigh the coins to ascertain if they are within the remedy as to weight. The amount of gold moneys coined at the Mint from April 5th, 1870, to June 30th, 1870, was 6,344,597, out of which coins to the value of £8,012 were deposited in the Pyx, or 6,971 sovereigns, and 2,082 half-sovereigns. The amount of silver moneys in the same period was 571,042, and coins to the value of £179 16s. were placed in the Pyx.

The verdict, we need hardly add, was very satisfactory in all respects. At the dinner in the evening, the Prime Warden of the Goldsmiths' Company stated, that 10 half-sovereigns out of 19 were exactly the standard weight, and that the variation of the remainder was very trifling. As to the "degree of fineness," the bulk of the silver coin agreed exactly with the standard trial plate, although the law allowed a variation of 8 parts in 1,000. The Chancellor of the Exchequer, who is also Master of the Mint, said, that in the Act of last year, all the scattered statutes, Orders in Council, and regulations regarding the Mint, had been gathered together, and the conduct of the trial of the Pyx continued in the hands of the Goldsmiths' Company, with whom it had rested since the reign of James I. A saving of £8,000 had during the year been effected in the expenditure of the Mint without, Mr. Lowe hoped, impairing its efficiency.

JOHN PIGGOT, JUN.

* There is a tradition that this is the tomb of Hugolin, the chamberlain of the Confessor.

* See S. Bart's paper in Scott's "Gleanings from Westminster Abbey," 282 B.

† Stanley's "Memorials," 385.

ALEXANDRA PARK.

THE past month has witnessed the appeal to the public from the Executive Committee of the Alexandra Palace and Muswell Hill Estate Tontine, which we anticipated in our number for April last. So much will be found in our columns, during the last twenty months, as to the beauty of the site, the capabilities of the noble Palace, and the advantages to be derived from the establishment of a centre of Industrial and Fine Art display, that it is quite unnecessary now to say more on these points. We may, however, render good service to our readers by giving them something resembling a *precis* of the prospectus. This document appears to have been framed with the most conscientious care, so as to leave nothing vague, and to explain to all intending subscribers their exact legal position, as well as the privileges and benefits they may expect to enjoy. The consequence is, that the prospectus is hard to understand from the very fullness of its detail. Men of cultivated education have been heard to express their alarm at such lengthened communications. The great mass of the public, whom it is intended to interest as guinea subscribers, will, probably, find themselves still more at fault to understand the advertisement, although, when they have once got the scheme fully in their minds, they will recognise the advantage of so full and definite a statement.

The sum originally paid by the vendor for the acquisition of the 498 acres of timbered and turf land, which it is now proposed to secure for a people's Park, is not stated. Recent sales, however, in the immediate neighbourhood, have been made at a rate exceeding the price of a thousand pounds per acre. On the various buildings, roads, and other objects, exclusive of land and also exclusive of unpaid interest of money, we are assured that upwards of four hundred thousand pounds have, up to this time, been expended.

This estate is offered to the incoming company for the price of £675,000, which it is proposed to raise in guinea certificates. Power is taken to raise or borrow a further sum for the completion, adornment, furnishing, and working, of the estate. The great peculiarity of the scheme is, that the cost of the proprietary tickets, which give to their owners privileges fully the equivalent of the amount paid, will be actually returned to the subscribers at the expiration of the association. A life is to be nominated on each ticket. If the life falls, that is to say, if the nominee dies, twenty shillings out of every twenty-one paid, will be returned to the proprietor of the ticket. The holders of tickets, the lives named on which are in existence on the 30th June, 1886, will divide the property between them. In fifteen years hence, the steady increase in the price of ornamental property in the neighbourhood of London, to which we have repeatedly called attention, will, in all probability, have raised the value of the Alexandra Estate to some sevenfold its present amount. This value, more or less, will be divided among the survivors; who will, according to the usual average of life, be reduced to fewer than two-thirds of the original subscribers. Thus it is quite within the limits of probability that a guinea invested in the Tontine to-day, after giving the privileges which we shall mention to the subscriber for fifteen years, will be repaid in the satisfactory shape of a ten-pound note, in 1886. A hundred guineas, invested in the name of a young person in the incoming month, will put, in all probability, a thousand pounds in his pocket fifteen years hence. This expectation is not confined to the promoters of the undertaking. The writer of the City article of the *Times* remarks, that "each subscriber will have several options as to the mode in which he may obtain a return for his investment, and be virtually guaranteed against loss."

The privileges secured by the certificates are these. First, a free admission to the grounds on every Sunday; a proprietor's right, to which no payment will admit, and which no non-proprietor can enjoy. This alone is well worth the money several times over. Then, it is

intended to devote all the profits of the admission fees on ordinary days, after making proper provision for the maintenance of the property and the service of the public, to the purchase of objects of Fine and Industrial Art, which it is intended to distribute among the certificate holders by a series of Art-Unions. The prizes will range from £2 to £500—nor is there anything to bar a fortunate proprietor from obtaining prizes in any, or in all, of the five successive distributions.

It will be seen that subscribers to this enterprise, besides ensuring a permanent benefit to the metropolis, and indeed to the nation, will derive both personal and pecuniary advantages from their venture to which no other project on foot can lay claim. The respectability of the names of the trustees and executive committee, no less than the unanimous consent of the press, vouches for the good faith and good conduct of the enterprise.

THE CASTELLANI COLLECTION.

THIS famous collection of products of ancient goldsmith's work is now to be seen in the British Museum. It is, as it were, on view pending deliberations as to the expediency of adding it to the national treasures in the Jewel Room. The price asked is £24,000; and whether this sum be given or not, it is earnestly to be hoped that the chance of acquiring an assemblage of objects so precious will not be thrown away. Such a collection could not fail to have a world-wide reputation. Its formation was begun more than forty years ago by Signor Castellani, of Rome; who, with a taste in advance of his time, conceived the idea of improving the modern manufacture of jewellery by reverting to antique design. He perceived that such of the models as the Greeks and Etruscans had left us transcended in taste everything of modern make, inasmuch as to suggest the adoption of ancient design, which has been done so judiciously and successfully, that the name of Castellani has for years been an unquestioned guarantee for the classic elegance of every object that passed from his hands. He was ably seconded in his selection and researches by the learning and experience of friends whose tastes tended in the same direction, notably by the Duca di Sermoneta.

From the time that Signor Castellani first addressed his attention to this method of improving the taste in jewellery, the collection has been steadily increasing, as well through his care and attention as those of his sons, Alessandro and Agostino, who were educated in the tastes of their father, and grew up surrounded by some of the most beautiful reliques of antique Art. The abiding-place of the collection was the Palazzetto Poli, the contents of which combined to form one of the most interesting museums in the city, and a centre whence issued the Art-oracles of men eminent in the most flowery Olympiads of Greek history.

The collection is not placed all together, but arranged in red velvet cases, and distributed in different parts of the Jewel Room, on entering which the eye is at once arrested by the richness of the objects in the cases immediately on the right of the visitor, and surmounted by the alabaster vase, on which is inscribed the name of Xerxes in four languages. Conspicuous among these ornaments is a crown of gold laurel-leaves, with *bulle* in the centre. By the Romans triumphal crowns were made of laurel, as also the chaplets that were suspended in the vestibules of houses in which a birth had taken place. Of these crowns, used on different occasions, there are several, all of similar construction—that is, the leaves, formed of thin leaf gold, are attached to a fillet, so as to overlap. They are of different sizes, the larger ones being about 1 foot in length, by 5 or 6 inches in breadth. With this crown is a necklace formed of emeralds, cut and strung cylindrically, each stone alternating with a powdered gold bead, and having in the centre a *bulle* with a *repoussé* design. The emeralds have neither been well selected nor well cut, but the gold-

smith's work is such as could not be excelled by the utmost cunning of the present day. This crown was found at Cære. An article perfectly unique is a gold sceptre found at Tarentum. It is nearly 2 feet long, having the shaft enriched by a reticulation of gold thread, with minute enamel rosettes at the intersections of the network. It has a capital of eight large acanthus leaves surrounding a fine pomegranate of greenish glass. There are also two necklaces: one, found at Cbiusi, is formed of seventeen small stars and two crescents linked together by swivels; the other is formed of plain round gold buttons. Of the same group is a gold diadem formed of three twisted fillets of plain gold, having as a centre a herculean knot set with a garnet. No. 9 contains the famous collar found at Milo (anciently Melos), the most beautiful of all the Greek ornaments known. To the band, which is formed of minute gold threads, is attached a number of small gold festoons, whence depend, in two rows, 114 *amphoræ*, a larger and a smaller row powdered; the whole of workmanship the most exquisitely delicate. There is no existing example of antique goldsmith's work to match this elegant ornament. It was formerly the property of M. Maltass, of Smyrna, and is said to have cost £700. In the same group is a necklace set with garnets, and a gold collar formed of a band of open roses, with double lotus flowers, whence depend, in the place of *bulle*, seven human heads, two of which, having horns and ears, allude, perhaps, to the story of Io. This was found at Tarentum, and presents one of the rarest examples of pure Greek. In the same group is another ornament, found at Melos. It has probably been the centre-piece of a frontlet, or necklet, and is formed of what would now be called a true-love knot, of beautiful workmanship, containing a garnet and enriched at the wings by scale-work. In case No. 15 is a remarkable chain necklet with lions' heads, and a fine example of *repoussé*, found, with earrings of like character, at Capua. One of the richest and most perfect diadems is formed of three rows of ivy leaves with berries. This was, perhaps, a convivial crown. From Corneto there is (645) a necklace with nine *bulle*, and having for a centre-piece the head of the river-god Achelous; and grouped with the objects found at Capua is a pomegranate, sacred to Proserpine, beautifully enriched with palm leaves and lotus flowers: this was perhaps worn attached to a chain or a *fibula*. In case No. 10 is a large funereal diadem, formed of three rows of bean leaves. It is about 1 foot in length, and about 5 inches in width: it was found at Chiusi. In the same case is a large *bulle* with chain (671); and (665) eight large massive gold cylinders, elaborately studded and threaded with flowers, leaves, and ovals in relief, and set with garnets of different sizes: this was found at Olbia, in Sardinia. Near it is a necklet with acorn and gold button-form pendants; and No. 699 affords further examples of *repoussé* work in a pair of gold armlets, the designs being composed of figures and winged lions. In case 10 are three gold diadems: one, of laurel-leaves, has for a centre-piece a large rose with a mask; another is formed of bean leaves. Case 12 contains a small *tiara* composed of sprigs of laurel, with a rose centre; and beneath this is a large *bulle*, with a *repoussé* Gorgon's head, to which is attached the tooth of some carnivorous animal, worn as an amulet. In the same case is a variety of necklets, one especially beautiful, consisting of powdered gold beads alternating with blue stones; in the same group are others of similar composition. Of the valuables found at Bolsena is a unique set (48) of large gold rings forming a chain. They are not soldered, so as to form a continuous circle, but any may be removed from the chain, for the purpose of being used, it is supposed, as ring-money. In the same case with these rings is a large *bulle*, $3\frac{1}{2}$ inches in diameter, with the story, in *repoussé*, of the reception of Hercules in Olympus. From Prænestine is a remarkable necklace of amber and gold, with a set of hatchet-formed pendants; another of amber, silver, and enamel; another also of amber, silver, and enamel. Some of the silver ornaments are massive and heavy. In case 21 is a necklet, with

amphore nearly as large as a bantam's egg; and in No. 16 are some heavy silver armlets, with tigers' heads of gold, a silver statuette of Jupiter seated, and other examples of the silversmith's art of the Roman period.

The different cases contain a variety of objects that, although making no great figure in the groups in which they are placed, are nevertheless not less interesting, archæologically, than the larger and more lustrous examples of goldsmith's work. For instance, beneath and near the Portland vase, are cases containing silver and amber ornaments of a very early Etruscan period from Præneste; and, to pass on to the latter Roman, Merovingian, and even the *cinque-cento*, periods, there are an enamelled group of the Virgin and Child in a crystal case, necklaces of glass and gold beads, curiously-wrought hair-pins and crosses of various degrees of excellence of manufacture, wherein, to an attentive observer, are signalled the feeble Roman imitations of Greek Art, which declined into vulgarity and thence sank into barbarism—a condition having a significant value as one of the baser links of history, but for which there must be a *hiatus* in the story of Art.

We should have scarcely looked for specimens of *torques* in this collection, as that ornament was peculiar to the northern nations, though it was also worn by the Persians. There are *torques*, however, in case No. 15, brilliant and in perfect condition; and in the same case two glass perfume-bottles in gold stands, and in other cases are distributed a variety of beautiful and interesting *scarabæi, camæi, intagli*, some of which are of much importance and value; also a variety of earrings, many remarkable for their design and the elegance of their workmanship. Among them is a suite found at Capua, consisting of necklace and earrings, the latter ornamented with lions' heads, a pair of earrings from Bolsena, designed as figures of Victory; and from Cervetri, a pair of bracelets ornamented with figures in relief, and enriched with filigree network.

Not the least interesting objects in the collection are the finger-rings, of which there are about 480 arranged in two cases, and ranging even from early Egyptian to the *cinque-cento*. There is no form of modern ring which has not a prototype here. Some of the thumb-rings are singularly massive and heavy, as also are others—episcopal and official rings. Some are remarkable for delicacy of finish, others for the coarseness of their workmanship; some impress us, by their worn appearance, with a conviction of descent through many generations as heirlooms; others, by the freshness of their setting and engraving, that they could have been used but little after leaving the hands of the goldsmith. It will have been observed that the precious stones occurring in the collection are the garnet and the emerald, which were the coloured stones principally used for ornament till some centuries before the Christian era. There is a diamond ring of Roman make, the stone of which has been set without having been cut: it was then a gem of the greatest rarity, and prized accordingly. The Etruscan rings are curious and very interesting, some being mounted with *scarabæi*, and very delicately finished. And not less attractive are the oval rings found at Chiusi; but yet more remarkable than these are some that resemble the Roman iron rings worn during the republic, and before the institution of the *jus annuli aurei*. There are several early Christian rings, one of which has the crossed P in gold; one has the anchor, and another, more directly allusive to the Church, has the emblematical ship; some bear inscriptions, and others only a mystic symbol. The great variety of design in the rings entirely anticipates the utmost ingenuity of the present day, and many of the other objects of personal adornment have not been surpassed by the cunning of modern productions. The Greeks here, as well as in the highest walk of Art, maintain their superiority. We are now searching every museum in Europe for those antique models, the beauties of which are conspicuous amid the generally heavy and bald patterns peculiar to the present day. The effect of this is already apparent in the composition and forms of much of the ornament of recent manufacture.

PICTURE-SALES.

THE season for the disposal of pictures by public competition has now almost, if not quite, come to an end. It has not been a busy one compared with many past years: no very important private gallery, we are glad to find, has been brought into the market; and had it not been for the distribution of some "trade" collections, such as those of Messrs. Everard & Co., Mr. Wallis, Mr. Brooks, and Messrs. Agnew & Co., the season might almost be considered a dead one. It speaks well for the favourable condition of Art when collectors are disposed to keep the works they have acquired.

The latest sale calling for notice was the collection of about 120 modern and ancient paintings, the property of the late Mr. Samuel Wheeler, of Brighton, and Barrow Hills, Surrey: it was disposed of by Messrs. Christie, Manson, and Woods, on the 29th of July. Many of the English pictures were painted expressly for that gentleman, and they may be classed among the best works of the respective artists. Those by R. Ausdell, R.A., of which there were not fewer than seven, were conspicuous in the collection for their number and excellence; namely,—'An Orange-Seller of Seville,' 265 gs. (J. Mason); 'Ptarmigan,' 140 gs. (Grant); 'A Family Group—Fallow Deer,' 250 gs. (Johnson); 'The Drover's Halt,' the landscape by T. Creswick, R.A., 500 gs. (Agnew); 'The Browser's Halloo,' exhibited at the Royal Academy in 1866, 375 gs. (Tooth); 'Stray Sheep,' 240 gs. (Agnew); and 'The Road to Seville,' with herdsmen and cattle, 580 gs. (Grant). The other principal examples of British Art were,—'A Neapolitan Peasant teaching her Child to dance the Tarantella,' T. Uwins, R.A., 120 gs. (Cubitt); this elegant composition was engraved in the *Art-Journal* for 1848; it was then the property of the late Mr. S. Cartwright, for whom it was painted: 'Melrose Abbey,' D. Roberts, R.A., from the Bicknell Collection, 235 gs. (Grant); 'Market-Cart crossing a Brook,' F. R. Lee, R.A., painted for Mr. Wheeler, and exhibited at the Royal Academy in 1851, 210 gs. (Agnew); 'English Meadows,' F. R. Lee, R.A., with groups of cattle by T. S. Cooper, R.A., painted also for its late owner, 475 gs. (Vokins); 'Sketching from Nature,' T. Webster, R.A.: in this picture Webster introduced portraits of himself, his father, mother, and sister: we engraved it in 1855, among several which accompanied a biographical sketch of the artist; it is an early work, and many years since came into the possession of the late Mr. James Wadmore, of Stamford Hill, who paid a very small sum for it, the painter being then an "unknown man." When Mr. Wadmore's pictures were sold, in 1854, after his death, 'Sketching from Nature' realised 352 gs.; it now sold for 245 gs. (Agnew). Two or three other modern works must be added to the above: 'Ancona,' C. Stanfield, R.A., painted for Mr. Wheeler, and exhibited at the Academy in 1848, 500 gs. (Agnew); 'Zuyder Zee Fishing-Craft returning to Port,' E. W. Cooke, R.A., also painted for its late owner, 430 gs. (Agnew); 'View in Luxembourg,' B. C. Koelkoek, 121 gs. (Nathan).

The pictures by old masters included—'A Woody Landscape,' with horses, cattle, sheep, and goats, A. Van de Velde, signed and dated 1663, 215 gs. (M. Colnaghi); another 'Woody Landscape,' J. Ruysdael, with figures—a cavalier on horseback, men, peasants, dogs, and sheep, by N. Berghem, signed by both artists, and dated 1652; a very fine specimen, from the collection of the Duchess de Berri, and noted in Smith's "Catalogue," 755 gs. (King); 'Sportsmen halting,' P. Wouvermans, 250 gs. (Agnew); 'The Guitar-player,' W. Mieris, signed and dated 1705, 295 gs. (M. Colnaghi); 'Landscape,' A. Cuypp, with a boy under a tree tending four oxen and cows; signed; 250 gs. (King). 'Music,' 'Painting,' 'Sculpture,' and 'Architecture,' a set of four designs by Carl Van Loo, bought at the sale of Louis Philippe's Gallery, and formerly in the Château de Bellevue, 720 gs. (Rutter). The whole sale realised £10,214.

DECORATION OF ST. PAUL'S.

THE great bell of St. Paul's announced, on the last day of July, the unexpected death of Dean Mansel, and the rolling thunders of Father Smith's noble organ pealed forth the Dead March in Saul as his requiem. The man dies, but the dean survives. The Corporation of Dean and Chapter is one of those artificial entities that are held to be immortal. Yet as to this corporation is entrusted the care of the fabric of the cathedral, and as the action, for good or for evil, of such collegiate bodies is vividly affected by the character of their successive heads, the subject is not without interest for the world of Art. It is indeed a matter of national importance. At the time when a large sum is being asked for from the public for the ornamentation of St. Paul's, the appointment of a man of educated taste to the deanery ought to be a *sine qua non*. Neither familiarity with the rules of logic, nor profound acquaintance with Greek plays, nor ingenious subtlety in theological disputation, is the qualification chiefly of service to the man who is responsible for the fabric. The distribution of the fat things of the Church is a matter foreign to our columns: but the appointment of a man able and willing to do for St. Paul's what the present Dean of Westminster has done and is doing for his collegiate church, is a matter the country has a right to expect.

The tenure of the late Dean, little more than a couple of years, has not been long enough to render his memory altogether responsible for much that has lately gone on in the Cathedral of questionable, or rather of unquestionably, bad taste. It is high time that there should be some one actually responsible—some one with a character to lose or to immortalise as a restoring or purifying dean. The public is by no means satisfied with proceedings that are taking place in the Cathedral. If the arrangements for "unifying" the services have the result of removing the cumbersome and ill-designed stone-pulpit, it will be to the great advantage of the nave. The sale of the transept organ, and the re-erection, at the west of the choir, of the grand old instrument which has, comparatively recently, been banished to the top of the closets, is also a desirable plan; provided always—which is no small assumption—that the new woodwork thus rendered necessary shall be consistent with the unrivalled carved work of Grinling Gibbons, which gives such peculiar beauty to the choir. The stalls of the dean, the sub-dean, and other officers, now inappropriately erected as *sedilia*, will, we trust, be restored to something approaching their original position. In fact, the removal of the organ screen is tacitly admitted to have been a mistake, although the separation which it effected between the choir and the nave was too absolute for parochial convenience.

The monuments of Nelson and Cornwallis have been removed to the south transept, where they are better lighted than in their former position. The unsightly gaps thus occasioned will, no doubt, in due time be filled as we suggest. But we think the placing of a portion of the old organ-screen as an internal porch to the north door is very unfortunate. An internal porch is a contradiction in terms—it has no *raison d'être*. Nor is this evil redeemed by any architectural or picturesque beauty in the present instance. The marble-columns are now simply obstacles to entering or leaving the church. The plain marble frieze which bears the epitaph of Wren—*Hujus ecclesie et urbis conditor*—is made to tell a lie. In its original position it indicated the site of the great builder's tomb, *subtus conditur*, in its present one it does not. A plain, unmeaning balcony, looking rather like a railway water-tank than anything else—this ill-used piece of work serves now only to encumber and hide the northern portal. Truly we have need of some assurance that a more correct taste shall regulate the outlay of money subscribed, not to deface, but to adorn, St. Paul's—the most noble ecclesiastical edifice, of its style, the country possesses, and which, therefore, deserves all the jealous care and attention that can be bestowed upon it.

BRITISH GALLERY,
57, PALL MALL.

A VERY interesting collection of pictures of the "Early English and Modern Schools" is now on view at this gallery. The object of the *entrepreneur*, Mr. Cox, has been to give examples of the works of nearly all the principal painters of the English School—from Hogarth to Turner—with a very fair admixture of their successors' productions. Of this latter class, however, there are but few that can lay claim to be absolutely modern; judging from the comparatively unfamiliar, and the occasionally raw, appearance presented by some of the works of our living painters, many years would appear to have elapsed since they first saw the world on the outside of the artist's studio walls; there are, of course, sundry exceptions in this respect.

By far the most important picture as regards size, subject, and prominence of position, is undoubtedly Hilton's 'Deliverance of St. Peter from Prison' (1); and, whether we regard its grandeur of conception, its bold yet subdued colour, or its masterly drawing and composition, we can conscientiously re-echo the encomiums passed on the work in the descriptive letter-press of the catalogue, and share the writer's wonder that it has not ere this found an abiding home in one of our churches—or better still, in the national collection. The fine engraving by E. J. Portbury will have familiarised the public with this picture. Hogarth's 'Life Academy' (7) is another work that ought, we think, to belong to the nation; to the left of the composition a nude male model is enthroned, while, armed with pencils and drawing boards, an imposing array of students confront and nearly surround him; the picture is valuable both for its artistic qualities (which stamp it as one of the master's finest productions) and also on account of the numerous portraits of departed celebrities with which it is crowded; the effect of the lamp-light streaming down on model and students is marvellous. There are here some very fine specimens of Sir Joshua Reynolds, of which, perhaps, the best is that well-known and truly wonderful portrait of Giardini, Manager of the First Italian Opera (33); for force and subtle vigour it is almost unrivalled. 'Resignation' (16), too, is a noble work, the appearance of care, suffering, yet withal patience, in the countenance of the seated figure, is beautifully expressed; but this picture seems to have suffered, in common indeed with most of the artist's productions, to a full degree from Time's destroying touch: we appear to be regarding it through a russet-tinted glass. Also by the same master are portraits of 'Lord Ilford' (69), and the 'Duchess of Bedford' (79). We have two interesting, though not very important, examples of Gainsborough—'Fisherman and Child' (4), and a portrait (151). Of Richard Wilson's works are, 'Lake Scene' (28), and 'Bridge at Rimini' (29). In striking contrast to these latter works are those of Constable, which are as free from system as the others are conventional, as fresh and *noisy* (if such a term may be employed) as Wilson's are severely, stiffly dignified: the best are, perhaps, 'Sunset' (10), and 'View of Borrodale' (71); the latter is painted in that earlier manner, preferred by many to the florid style in which he later indulged. George Morland is represented in 'Clarissa Harlowe' (12), and three others; Opie in 'Mrs. Siddons' (23); and James Ward in 'The Angel Troubling the Water at the Pool of Bethesda' (5). There are some very fair examples of Stothard, Copley Fielding, old Crome, C. R. Leslie, Müller, Collins, and Turner; and also of those painters recently lost to us—Mulready, Dyce, Stanfield, Creswick, and MacIise; by the latter are three very important and characteristic works—'Macready as Macbeth' (40), 'Ye Lady Margaret's Page' (44), and 'The Witches in Macbeth' (153). There is the usual 'Head of a Girl' (11) by Grenze, and by the same painter, 'A Magdalen' (82).

Passing to the productions of living artists, Mr. Elmore's 'Excelsior' (41), demands our first attention; to those who may not have seen the picture when exhibited a few years ago on

the walls of the Royal Academy, we may state that a picturesquely-attired youth, with the "Rossetti" head of hair, is represented toiling upward and upward; with much that is beautiful, there is a certain want of tone in the colouring; and we must also object to the excessive and unnecessary size of the canvas; we marvel, however, that it has failed to obtain an honourable resting-place. 'The Artist's Studio' (85) is a very interesting and excellent example of Mr. Frith's talent—interesting, inasmuch, as in the artist taking stock of the newly-arrived model, we recognise the youthful lineaments of the painter himself; and excellent, from its intrinsic merits as a careful and effective bit of painting; his handiwork is also seen in 'Sweet Ann Page' (50), 'Mary, Queen of Scots' (52), and 'Asleep' (137). In considering 'The God Pan' (31), we are led to think how much Mr. Leighton, R.A., has improved in his art since the days in which he gave to the world this Academic nudity. Mr. Orchardson, A.R.A., shows to decided advantage in 'Bedtime' (38); this gentleman, unlike Mr. Leighton, should go *back* a little; we have seen nothing of the artist's of late years, to equal this little picture for truth and tenderness; he shows us a cottage-interior, through the latticed window of which the sea is visible, and the children are retiring to rest. 'Listeners seldom hear good of themselves' (39), is a bright and pleasant production from Mr. J. Burr's easel. Edwin Hayes, R.H.A., is favourably represented in 'Dutch Boats hauling off Shore' (53). 'The Expected Arrival' (98), by E. C. Barnes, representing a family by the shore awaiting the advent of some loved member, is as pleasant and agreeable a picture as we should expect from the artist, and is painted in his usual free and (shall we say) *easy* style. The lines—

"Something it is which thou hast lost,
Some pleasure from thine early years,"

are appended to Mr. Calderon's picture (103): an earnest, middle-aged man is intently and absorbingly regarding a portrait of a nun whom, in former times, it requires little imagination to perceive he had deeply loved; his wife and family are present, and the former is gazing on her husband with an admirably-managed expression of mingled jealousy and sorrow. This picture most of our readers will remember as engraved in last year's *Art-Journal*. 'The Farewell' (109), by Alexander Johnston, with some youthful crudity, possesses the same purity of intention and freedom of execution which, with a later-acquired experience and knowledge, may be said to characterise his present works. Mr. J. B. Burgess is charming as usual in his 'Pastor's Visit' (110). 'Corinne' (148), by Joseph Coomans, is a perfect gem for finish, refined elegance, and agreeable colour; it forms a marked contrast to Mr. Frank Buchser's 'Mary Blain' (162), than which a more complete change from extreme delicacy to vigorous roughness could hardly be imagined. Mr. Buchser, a Swiss painter, has evidently thrown to the winds all the conventionalities and dogmas of the schools, and chooses to look upon nature from his own standpoint: how far he has succeeded it would be well to leave the spectator to decide. The scene is laid in a plantation in the Southern States of America; a group of negroes is introduced reclining on the ground; one of them is singing to his own accompaniment on the national instrument. There is a very remarkable and sunny effect of light in the piece, and the figures are effectively though carelessly drawn; but in striving after originality, we are afraid the painter has overstepped the modesty of nature.

Space forbids a more detailed account of the works in this gallery. It will suffice to draw the intending visitor's attention to Mr. J. S. Lander's 'Christ Walking on the Sea' (45); a small *replica*, by Sir Noel Paton, of his 'Pursuit of Pleasure' (46); 'Jewish Synagogue' (48), by W. Strybiski; a 'Landscape,' by G. Arnold (72); 'Scene from *Cymbeline*' (89), by P. F. Poole, R.A.; and minor works by E. M. Ward, R.A., J. Sterling, E. Nicol, A.R.A., &c. The collection is a very good one, and the undertaking merits success.

THE CHAPTER-HOUSE AT
WESTMINSTER.

A VERY proud position was occupied by the mitred abbot of Westminster, before the spoliation of the monasteries. Many a bishop was his inferior in wealth, in power, and even in rank. At no time can his dignity have been more conspicuous than when he sat installed in his noble Chapter-House. Of the carved work and tabernacle work of his stall, the rich tracery of its canopy, the grotesque impropriety lurking under its folding seat, we have now no relic or likeness. But the lofty hall, with its clustered Purbeck marble columns in the centre, is now so far rescued from the grip of the utilitarian school that we can form some indistinct idea of its former splendour. The world was shut out. There was no communication between the Chapter-House and the town or suburb of Westminster. The lofty windows, occupying almost the entire surface of six sides of the octagon, were ablaze with ruby and purple. Sculptured angels swung their thrubles on either side of the arched and pillared gateway, which led through a low passage, exquisitely adorned by the pious sculptors of the thirteenth century, to the great cloister. The mode in which this part of the structure is prolonged into the South Transept of the Abbey, so as to enable the abbot to make his sudden and stately appearance, not at the gate, but within the very heart of the Minster, is one of the peculiarities of the Abbey Church of St. Peter. No less recluse, stately, and convenient, was the entry from the tower-cloister to the Chapter-House. A tree of Jesse ran like a vine round the mouldings of the arch, bearing quaint kings and grim little patriarchs. Beneath, the crypt, with its walls fifteen feet thick, indicates the more modest dimensions awarded by the piety of the Confessor to the Council-room of the Chapter, as compared to the stately proportions allotted by the second founder of the Abbey. A mark of the growth of the power of the Abbot of Westminster during the early Norman reigns, is afforded by this relic of the earlier building.

The arcades around the octagon beneath the sills of the great windows, have been painted at a later period than that which is indicated as the date of the building itself. Originally they may have been concealed by the stalls; but, towards the middle of the fifteenth century, the Revelation of St. John was illustrated by a series of paintings, in oil, on the walls, some very beautiful relics of which the care of the dean and his structural assistants have given to our view. Not only have these paintings been cleaned from the coat of whitewash which hid and protected them, but the stone has been indurated, so that their preservation for the future is assured. They are not *fresco* paintings, but oil-painting on the stone itself. The colours have stood remarkably well, where actual violence has been escaped—the gold of the *nimbi*, the crowns, and other adornments of the figures, is as fresh as if laid on last year. Beneath the various scenes, which are represented in most curious and literal detail, are descriptions or extracts from the prophecies, written in very fine black letter, on thick paper, with red capitals, cemented to the stone, and probably covered with the same coat of varnish as the paintings. Subjects in natural history were painted below—the idea seeming to be that of a consecutive series of things in heaven, things on earth, and things under the earth, or in the sea. The spelling is as quaint as the drawing—we can decipher the names of the "Ro" and the "Croceidyle." The heads of two of the angelic figures rise to the sublime. The restoration does the utmost credit to all concerned. We trust the funds requisite to fill the windows with stained glass will be forthcoming, although we hope that the treatment will be limited to *grisaille* and diaper. The Chapter-House ought to be seen, as far as possible, as it was intended to be seen by its original architect. No living artist has as yet shown himself strong enough to design figure-subjects for these magnificent window-spaces. The painful effect on the eye of filling lights of such large dimensions with ordinary transparent glass is very perceptible in the Chapter-House; but this is preferable to work like that at St. Paul's.

ART IN CONTINENTAL STATES.

PARIS.—The museums and Art-treasures of Paris have suffered less from foreign and civil war than might have been apprehended. The gems of the Louvre were sent for safety to Brest. The only picture-galleries yet opened are some of the French school: the *Salle des Sept Cheminées*, containing the large works of Girodet, David, and the other painters of the Empire; and the Great *Salle*, with the pictures of Greuze, and of Vanloo, Boucher, and the Louis XV. school. Also the new room containing the bequest of M. La Case, among them several small pictures by Watteau, which artists are diligently copying. The *Salon Carré* and the Great Gallery are still closed, with the *Galerie d'Apollon*, which suffered severely, and the *Musée des Souverains*. In the *Musée des Dessains* is placed a quantity of furniture preserved from St. Cloud, consisting of tables, *encoignures*, clocks, &c.—many of the best style of Louis XIV. The pottery and Sauvageot collection is also replaced.—The loss of the Library of the Louvre is incalculable. Its treasures had been removed to a secure place during the siege, but immediately after the armistice, orders were sent to its curator to restore them to their places, an order, unfortunately, too quickly obeyed, as they were included in the destruction of the Tuileries.—The *Hôtel de Ville* lost in its library the beautiful missal of Juvenal des Ursins, purchased by M. Firmin Didot for 60,000 francs (£2,200), and presented by him to the city. The library of the Arsenal had been doomed by the Commune, and its director and his assistant were among those sentenced to be shot, but the arrival of the Versailles troops saved them both. The 80,000 books were again taken down to the cellars where they had been placed before the siege, to save them from their dangerous proximity to the *Greniers d'Abondance*, which were burning for days; but fortunately the volumes escaped. The *Luxembourg* has not suffered, and some twenty pictures have been added; among others, P. de la Roche's 'Death of Queen Elizabeth,' which has not been shown for years—probably was packed away in the *Garde Meuble*. The porcelain-manufactory of Sèvres has escaped the fate of her neighbour, the beautiful Château of St. Cloud, now, with six hundred houses in the town, one frightful heap of ruins. With the exception of a few shells, no injury has been done to the building, and its contents were carried out of harm's way. Within the space of one week the whole of the Ceramic Museum, the valuable specimens of the manufacture, pictures, library, &c., were all packed and transferred to Paris. The last waggon-load only entered the gate as communication was closed, and the *employés* who had the charge of it were compelled to remain in Paris until the end of the siege. Much anxiety was felt as to the fate of the venerable, indeed, octogenarian, curator of the museum, M. Riocreux; for six months no tidings could be gained of him, and it was even reported that, emulating the example of Frederick the Great towards the artists of Dresden, he had been forcibly removed to the Berlin manufactory; but such proved not to be the case. He never left Sèvres during the siege, but, when ejected by the Prussians from the manufactory, he remained with M. Salvétat and others of the staff in the town, to watch over the safety of the workshops, until allowed by the Prussians to re-enter the building. There was left at Sèvres porcelain to the value of 350,000 francs (£14,000), which was not removed to Paris; unfinished pieces, such as required the *ornolu* mountings, which are all made at the manufactory, general "stock," &c. All these the Prussians cleared off as "*souvenirs*" of their occupation, leaving nothing but an enormous earthenware "*tinaja*," a Spanish vessel some 10 feet high, and a white Sèvres porcelain-vase of similar altitude, which was exhibited in 1867 as a triumph of modelling and firing. M. Riocreux is now busily employed in unpacking the cases from Paris. Happily few pieces have been broken, but the ceramic world has sustained a great loss, in the cup of Henri Deux ware of M. Utu Dorigny, which perished in the conflagration of the Rue du

Bac by the Communists. It was one of the finest specimens of the fifty-three pieces existing. The collection of M. Dutuit narrowly escaped a similar fate—having been sent for safety to the care of an antiquary in the *Quai Voltaire*, separated only by a wall from the flames of the *Rue de Lille*. The Palace of Fontainebleau was at a safe distance from the ravages of the insurgents, but was occupied during the siege by the Prussians. All the furniture, carpets, and state beds, the Gobelin tapestry and embroidered satin panels of the walls, had been previously removed. Not a chair was left for Prince Frederick Charles. It was given out that they had been sent to Paris, but they had been all secreted at Fontainebleau. The carved wainscoting was protected by planks of wood, and suffered no injury; and the *Galerie Henri II.*, with its gorgeous ceiling, carvings, gilding, and paintings, after the glorious designs of Primaticcio, are all untouched. The historic carp of the lake, however, were not left "unrequisitioned." After the soldiers had eaten some thousands of these venerated and venerable fish, the Prussian Prince forbade their being caught, and the old white specimens, said to be contemporaries of the Valois, who made the journey to Paris for the Exhibition of 1867, are still to be seen in high health, disputing with the swans the pieces of bread thrown to them, as vigorously as their younger brethren. The furniture and works of Art are being re-installed in the palace, and soon all will be again in its place, leaving no trace of occupation by the invader.

MANUFACTURES.

FROM THE GROUP IN MARBLE BY
H. WEEKES, R.A.

THIS engraving is the last we have to give of the four smaller groups which are for the ornamentation of the Prince Consort Memorial. The three that have preceded it symbolise respectively, Agriculture, Engineering, and Commerce; and in each of these are four representative figures: Mr. Weekes has adopted, in his design for Manufactures, a similar number, according to the directions given to all the sculptors; but a limitation to four personal types, in dealing with a subject so comprehensive, affords an artist no opportunity of description; it confines him to bare allusion. The presiding genius, a female of small and delicate proportions, holds in her left hand an hour-glass; to show the importance of time to the artisan; while her right hand points to a beehive, significant of industry. On her left, his foot resting on his anvil, is a broad-shouldered worker in iron, with some bars of metal behind him: this figure is unquestionably the principal feature of the group; his back reminds one of the famous "Farnese" Hercules, though there is no exaggerated display of anatomy; and his strong muscular limbs and body are the development of physical power. At his feet, in a half-reclining position is a potter, who has brought to the meeting some beautiful objects of his Art-workmanship; and the fourth figure, that of a factory-girl—too well favoured every way, it is to be feared, to have been copied from nature—offering a web of cloth. Thus we have the three great industries of the country, the iron-trade, the textile and the fettle productions, fitly represented.

The disposition of the whole group is such as to render it less effective when engraved, than the others. Our artist found it difficult to find a point of sight taking in all the figures so that each might be well seen, without some appearance of confusion in the lines; but it is a fine work of Art, most honourable to Mr. Weekes, the sculptor; its merits must not be judged by our view of it.

ART-UNION OF LONDON.

THE prizes of the Art-Union were exhibited at the Gallery of the Institute of Water-Colour Painters during the latter weeks of August. The pictures, drawings, and sculpture were in number 113, of which 64 were selected from the Exhibition of the Society of British Artists, 20 from the Royal Academy, 7 from the Institute of Water-Colour Painters, 4 from the Society of Painters in Water-Colours, 2 from the General Water-Colour Exhibition, 2 from the Dublin Exhibition, and 1 from Edinburgh. The highest prize, that of £200, was 'Dr. Johnson at Rehearsal,' by D. T. White; those of £150, 'Moonlight on the Mountains, Llyn Idwal, North Wales,' A. Gilbert; and 'Old Canal Lock near Bishopstoke,' G. Cole; those of £100, 'War-News—Hostilities have Commenced,' G. Pope; and 'Town and Castle of Amboise on the Loire,' G. C. Stanfield; those of £75, 'Grandfather's Departure,' J. C. Waite; and 'Vessels off Tynemouth Bar,' Edwin Hayes; those of £60—three in number—'The Reproof,' J. D. Linton; 'St. Michael's Mount, from Marazion,' G. Cole; and 'Fishing Smack leaving the Harbour of Yarmouth;' the other prizes descending the scale, as £50, £45, £40, &c. The subject of the highest prize is a suggestion from Thackeray's "Georges," showing Dr. Johnson in the green-room of Garrick's Theatre in the act of acknowledging the courtesy of one of the actresses whom Garrick is about to lead on the stage. Both the doctor and Garrick are unmistakable portraits, and the general treatment is independent and forcible. 'Moonlight on the Mountains,' (64), by Gilbert, is really a very fine picture; the moon does not appear, but the light is so admirably managed as to show completely the grand details of the scene. 'The Old Canal Lock,' by George Cole, is a scene of another kind, but chosen, with excellent taste, for a display of firm and effective painting. In 'The Town and Castle of Amboise' (11), G. C. Stanfield, we see the exterior of one of the most interesting of the ancient *châteaux* of France, painted with all the artist's accustomed breadth and firmness; and in 'War-News' (59), G. Pope, the by-play between the lovers shows, as we may accept it, the commencement of the first quarrel. Among the minor prizes are many pictures of merit, and the water-colour works have been selected with more than usual discernment. We may mention two picturesque interiors by J. Nash; 'Distant View of Conway,' D. Cox, jun.; 'The Bridge and Campanile of S. Croce, &c.,' D. H. McKewan; 'On the Road between Cladish and Dalmally, &c.,' T. M. Richardson; with two by Edwin Hayes, &c.

The principal prize appointed for 1872 is the marble group by C. B. Birch, which, it may be remembered, won a premium of £600 some years since; besides this there will be eight engravings of coast-scenery by Brandard, Cosen, Prior, and A. Willmore, after subjects by Cox, Fielding, and Prout; and certainly these views, which have been selected with taste and judgment, will form a set of engravings in interest and beauty inferior to none ever offered by the society. The Council is right in thus varying the works offered to subscribers; a large print necessarily involves the cost of a suitable frame, a matter of no little importance to some persons; whereas a handsome volume of engravings subjects the subscriber to no such outlay, and, comprehending as it must, numerous subjects, is, undoubtedly, as much appreciated as a single print—perhaps, as a rule, more so.

The subscriptions for the past year amounted to £10,171—a result really marvellous, when we call to mind the recent disturbed state of all our business-relations; and we most cordially join in the compliments paid to active advocates of the good cause of Art as far away as Constantinople, Barcelona, Queensland, South Australia, &c.

We cannot help remarking on the want of knowledge displayed by the subscribers generally with respect to the distribution. It appears by the report that, besides the prizes determined through the medium of the ballot-box, other prizes are distributed, as bronze vases, busts



MANUFACTURES.

(THE ALBERT MEMORIAL, HYDE PARK.)

ENGRAVED BY H. C. BALDING, FROM THE GROUP IN MARBLE BY H. WEEKES, R. A.



of the Princess Louise, chromolithographs, medals, &c.; and it has been asked when these were allotted. The answer to this is, that the drawing is continued on a second day at the offices of the Art-Union, and subscribers have the privilege of being present; but this is so little understood, that there is, as a rule, no attendance of subscribers. It will be remembered that some years ago pictures were selected by the officers of the society, and recommended to prize-holders. This measure worked admirably as to the quality of the works selected, but it has been discontinued, because, we may presume, prize-holders prefer choosing for themselves. A "committee of taste" cannot be expected to please everybody. The reserve fund amounts now to the large sum of £15,769.

THE CENTENARY OF WALTER SCOTT.

EVERY newspaper in the kingdom has published some details concerning an event that has made all Scotland wild with joy. A hundred years ago was the birthday of the great and good man who, though dead, yet liveth—whose works will endure as long as any language lasts; for they are read in every land throughout the world.

It well behoves the Scottish people to cherish his memory; but every country claims him; he belongs to us as much, or almost as much, as to them: his poems and stories are ours as well as theirs; for us there needs no translation—they were written in the Anglo-Saxon tongue, and, perhaps, nine-tenths of the people who speak it are, more or less, familiar with them. Time has not impaired their infinite variety; the characters depicted are not for a day, but for all time; they will delight our children's children, as they did our fathers and ourselves; more, they will be sources of instruction as well as pleasure for ages upon ages yet to come. The author was, and is, and will be for ever, one of the great chiefs among the benefactors of humankind.

It is not only as a great author that Scott demands the gratitude of the generations that succeed him—he was emphatically a good man—good in all the relations of life—consistent, upright, true: his precepts are those of virtue, and his example gave them weight. If he had been less conscientious he might have lived longer—longer, that is to say, on this earth; but the lesson he taught by his struggles in age will bear fruit as long as his memory endures. So many things have been said, and so well said, within the last few weeks concerning the author and the man, that, write as we may, we could but echo them. It would shame us, however, to be the only journal in the kingdom that offered no tribute on a shrine that it is not irreverent to term holy.

This grand commemoration has been held while many of his contemporaries and of his personal friends—not a few—yet live among us; there are witnesses in abundance whose evidence is not that of hearsay. Of his direct descendants, indeed, unhappily, none remain; the title he earned does not now exist, and the blood that stirs at Abbotsford is little of his; but there are thousands in and about Edinburgh who can recall him to memory and picture him to their children, if not in his prime, before age and trouble had so pressed down his faculties, that the mind preceded the body to the grave.

All glory to his name! Mankind honours, reveres, and loves him; and the tens of thousands who were not present at any of the "fêtes" have joined as heartily in the laudations uttered as the most enthusiastic of the auditors. England has responded to the "all hail" of Scotland, and the centenary has been celebrated in hundreds of thousands of homes where the uttered words have not been heard, but which have been none the less acceptable to the spirits of those who "rule us from their urns."

MINOR TOPICS OF THE MONTH.

ROYAL ACADEMY.—The newly-appointed chair of Professor of Chemistry has been filled by the election, on August 1, of Frederick S. Barff, M.A., whose chief opponent was Arthur Herbert Church, M.A., Professor of Chemistry in the Royal Agricultural College, Cirencester. Mr. Barff, we hear, was elected by a considerable majority; though Mr. Church's testimonials were of a very high order. Both gentlemen graduated at Oxford.

UNIVERSITY COLLEGE.—The classes in the Department of Fine Arts, established under the will of the late Mr. Slade, will meet on the 4th of October, under the direction of the newly-appointed Professor, Mr. E. J. Poynter, A.R.A.

THE WORKS OF CARRIER-BELLEUSE.—A collection of singular interest will be submitted for sale by Messrs. Christie on the 1st of November next. The sculptor, Carrier-Belleuse, holds a high position in Paris—perhaps the highest in his profession. Recent events in France compel him to some arrangement by which his finances may be recruited (it is so with many of the artists of that afflicted country), and he has resolved on disposing, in England, of a large assemblage of his works. They will be eagerly sought for by collectors, being of high merit and interest, although, generally, they are reductions, in *terra-cotta*, of his leading and most renowned productions: being comparatively small in size, they will suit Art-lovers who are not wealthy enough to purchase marbles. The collection will consist of about one hundred "lots," including copies of nearly all the productions of the accomplished sculptor, the *terra-cottas* being made and "baked" in his own establishment—in a great degree the work of his own hands—and existing only as single examples.

MR. NICHOLAS CHEVALIER, who accompanied His Royal Highness the Duke of Edinburgh during the greater part of his late voyage, has had the honour of submitting to the Queen the sketches he made for his Royal Highness to illustrate the journey. A large number of the artist's drawings and sketches made in New Zealand are now exhibiting at the Crystal Palace.

THE CERAMIC AND CRYSTAL PALACE ART-UNION.—We have made this society sufficiently known to our readers. The office is at 16, Great Castle Street, Regent Street, near the Circus; where nearly one hundred specimens of ceramic Art—"for choice"—are submitted to subscribers at the time of subscribing—a chance of a prize being also acquired: the prizes are distributed annually in the month of July. At a meeting of subscribers held at the great room, 9, Conduit Street, on the 30th of July, prizes to the value of £400 were accorded, several members of the committee being present—Mr. S. C. Hall in the chair, and Mr. E. M. Ward, R.A., moving the adoption of the report, which was written by Dr. Doran, F.S.A. The report was very encouraging: in the year 1870-1 there was a large addition to the list of subscribers; many of these were from the colonies; the agents also are increasing, and seem to act with much energy. The council objected to two of the works submitted to them, which were, of course, withdrawn—the constitution of the society requiring that all works shall be approved by the council.*

* In the course of his address Mr. E. M. Ward said, "the figures on the several vases were painted as well and as correctly as any that were imported from France; they were correct in drawing as well as in good taste, and generally excellent as Art-works."

The report expressed a strong opinion that the operations of the Art-Union had materially advanced the interests of ceramic Art. It will be our duty, from time to time, to notice the issues of the society.

RAFFAELLE'S LA VIERGE AU BERCEAU.—A picture with this title has recently been exhibited at the Society of Arts. It was in the possession of the Cardinal Mazarin, who received it as a present from the Marquis of Fontenai-Mareuil, ambassador to the Pope, Urban VII., who maintained that this example was the original work of Raffaele. It was lost for some time, and, according to the best authorities, has been found in Düsseldorf. It came there through the painter Kolbe, of Paris, who was appointed by Cornelius, Professor of the Academy of Düsseldorf. He procured it from a French family, whose name seems to be De Savon, according to a note found on the back of the picture, and it remained more than half a century in the possession of M. Kolbe, and afterwards in that of his widow. At her death it passed to M. Schreiner. This picture may be assumed to be an original. According to Felibien, Raffaele made the design of two pictures; one now in the Louvre, the other that in question; and gave them to his pupils to finish. The original drawing is in the possession of Her Majesty the Queen. Both pictures are larger than the drawing. It is obvious that when this picture was painted, the artist had not yet determined its dimensions, as we find small pieces of wood have been added at the top and bottom of the panel, probably to make it more symmetrical. The work on those pieces is evidently as old as the rest. If this were a copy only, a panel would not have been chosen to which additions were necessary afterwards. The dimensions are the same in both. But that exhibited at the Society of Arts is as fresh and beautiful as if just finished. M. Andreas Müller, Professor of the Academy of Düsseldorf, having most minutely examined it, says:—"This picture has undoubtedly a very high artistic value. It is certainly the one, lost for some time, which belonged to the Cardinal Mazarin. It is of much greater beauty than that of the Louvre. It is identical, even to the merest details, with the original drawing in the possession of the Queen, and of which the Düsseldorf Academy possesses a photograph. The treatment of the dresses is quite Raffaellistic, the body of the child, especially, is of such beauty of form as Raffaele only could have painted. The child of the Louvre picture, on the contrary, seems rather mannered, as far as one can judge from a photograph. Moreover, this picture is in excellent condition and has never been retouched." [We are indebted for much of our information to the *Kuntz Blatt* of Düsseldorf; the picture unquestionably bears out the criticism, and establishes the details.]

OFFICIAL REPORTS ON THE INTERNATIONAL EXHIBITION.—It is only due to the *Art-Journal* to protest here against a note appended by the editor, Lord Houghton, to Mr. Julian Marshall's article on "Engraving, Lithography," &c., reviewed in another column, as a portion of these "Official Reports." After remarking on the probability of the early extinction of line-engraving in this country, his lordship goes on to say—"At the present moment in this city the whole commerce in this department—which at one time was alone recognised as high Art in engraving—is in the hands of one Art-publisher," (the italics are our own), "and depends for existence on his liberality and sense of duty

to his profession." The inference to be drawn from this passage, which goes forth to the world with such high authority, is, that the line-engravers of England are supported by one firm of publishers only: yet it so happens that this very firm, the name of which it is quite unnecessary to mention, sends out very few pure line-engravings, the work of our countrymen. But surely Lord Houghton is not unacquainted with the *Art-Journal*, which, for more than a quarter of a century, has been, we hesitate not to say, the mainstay of the Art in England; producing works that have employed, with, perhaps, two or three exceptions, *all* the best line-engravers living among us, and still continues to employ them. Lord Houghton must at least have heard of such publications as *The Vernon Gallery*, and *The Royal Gallery of Art*, and could scarcely be ignorant whence they had their origin: to circulate, therefore, such a statement as he has done, shows either ignorance on the part of his Lordship, or injustice towards other enterprising publishers. We only repeat what many line-engravers have said to us, that, were it not for the *Art-Journal*, they would be very much in the condition of "frozen-out gardeners," so comparatively insignificant is the support they receive from *Art-publishers*.

OUR PUBLIC STATUES.—Experiments are being made to find suitable resting-places for these memorials. A cast of Mr. Noble's fine statue of Oliver Cromwell has been temporarily placed in the plot of garden-ground opposite Palace Yard: and another, of Brunel, the engineer, on the Thames Embankment, between Hungerford and Westminster bridges, and at a short distance from the statue of Sir James Outram. But who is to determine the fitness of the locality? we trust this will not be left to the taste and judgment of the right honourable gentleman whom the caprice of fortune has placed at the head of the Department to which is confided, for a time, the destinies of our public buildings and monuments. Whether it shall or shall not please the Legislature to place the statue of the "Protector" among those of kings and queens in the palace at Westminster, even Mr. Ayrton cannot inform us. The President of the Board of Trade states, with his usual clear-sighted wisdom, that the statue of Cromwell is an experiment to ascertain how Lord Palmerston or Sir Robert Peel (detestable achievements both) would look in the same place. One thing, however, is sure, that Mr. Noble's figure is a most admirable work, a better has not been executed by any modern sculptor, and there can be no doubt that if Cromwell is to be commemorated in bronze or marble, there is no living artist to whom the task could be confided with greater certainty of a successful and honourable result. If, as Sir J. Pakington informed the House, the statue "is intended for Manchester," we may envy that liberal and enterprising city its possession.

INCONGRUOUS ORNAMENT.—One great and crying evil of our present method of decorating London is the absence of anything like a sense of "keeping." One man designs a house, one a road, one a statue; but how they are to harmonize with each other is the business of nobody. Things excellent in themselves may be rendered absurd, or even odious, by this want of general design. A striking instance of such negligence has just occurred on the parapet of the Thames Embankment. Those of our readers who occasionally steam along the river are familiar with the lion's

heads, with mooring-rings in their mouths, that have been adopted as ornaments for the pilasters of the granite wharf-wall. Visitors to the newly-opened gardens, or passengers along the Embankment, will also have noticed the erection, within the last few weeks, of Mr. Vulliamy's dolphin lamp-posts on each of the stone pilasters. The lion's heads are bold and good. The lamp-posts, although the design is not suited for a long unbroken repetition, are also good. But the difference of scale is such as to make the juxtaposition of the two metallic ornaments, when seen from the river, extremely displeasing. The lion's head altogether dwarfs the dolphin standard—the dolphins make the former look disproportionately large. Fish above flesh—or at least sea-beast above land-beast—looks ill-considered and is out of taste. Did any one, responsible for the selection of the design, ever take the trouble to see how it would look in its place?—that is to say, to examine it from both sides?

THE STATUE OF SIR JAMES OUTRAM, by Mr. Noble, which for many weeks has stood, on the Thames Embankment, enveloped in something or other bearing not the slightest resemblance to the "martial cloak" of a warrior, is at length exposed to public view; Lord Halifax having undertaken the important duty of presiding at the unveiling on the 17th of August. The famous Indian general is represented as standing, quietly and self-possessed, on the battle-field: his right hand grasps firmly a sword, on which he leans; in his left he holds a field-glass to his breast, ready for instant application to watch and direct the war-storm. Several exploded shells are at his feet, with a dismounted gun, &c. The statue is a vigorous and manly figure, full of character well-defined: it stands twelve feet high, is cast in bronze, and is placed on a pedestal of the best Aberdeen granite, seven feet in height, and about fourteen feet square at the base. At the uppermost angles of the pedestal, groups of Anglo-Indian trophies are introduced with excellent and novel effect.

SGRAFFITO ORNAMENT FOR BUILDINGS.—A new method of architectural decoration is now being applied to the exterior of the new schools at South Kensington, which promises, if it answers expectation, to revolutionise our street-architecture. The grimy and gloomy aspect which stucco of all kinds assumes after a few years' exposure to the atmosphere of London, is one of the evils of the metropolis. Paint, indeed, restores the freshness of the first work of the builder, but to paint a house is no trifle. The cheap and effective method which is universal in South Wales has never found favour in London, although an annual coat of whitewash over all stuccoed buildings would cost little, and would brighten up the streets amazingly. Such, however, is not the plan to which we refer, and which is, for the first time, undergoing trial on the back of the noble building, from Mr. Waterhouse's design, that looks down on the visitors to the International Exhibition, from its airy *terra-cotta loggia*. The pilasters, friezes, and main features of the building are executed in carefully-pointed brickwork. Panels are recessed to the depth of a quarter brick, and spread over with a coat of the patent selenitic mortar (invented by Colonel Scott), which has the advantage of drying with great rapidity. On this, when dry, is spread a second coat of mortar, similar in its elements, but finer, and blackened with manganese. On this, in turn, is spread a third coat, yet finer, thinner, and of a tinted white. Decorative

patterns are traced on this surface, either by hand, or by the application of paper *formulae*; and the designated parts are scraped out, leaving the white pattern relieved on the black ground. The effect of the few panels as yet completed is very happy. The durability is expected to be great; and it is to be hoped that it will not only be the durability of a sound weather-proof rendering, but that the black and white will preserve their tints uninjured, and will be only cleaned and freshened by the rain.

STATUE OF MICHAEL DE LA POLE, EARL OF SUFFOLK.—In the studio of Mr. W. D. Keyworth, 62, Buckingham Palace Road, is a statue of Michael de la Pole, Earl of Suffolk, and Lord Chancellor of England, A.D. 1383. It is a figure of heroic size, in Sicilian marble, and is intended to be placed in the new Town-Hall at Hull. It has become of late years customary for the sheriffs of Hull to present to the Corporation a statue of some eminent person connected historically or officially with the town. Thus Mr. Keyworth has already executed two such statues, those of Sir William de la Pole, the first Mayor of Hull, and of Andrew Marvell, both of which have been noticed in the *Art-Journal*. The present subject is presented in the robes of his high office, richly embroidered with fur, and confined at the waist by a girdle, with a pouch at the left side, according to the fashion of the fourteenth century. There is in the treatment of the figure a novelty, from which it derives much relief. The chancellor is supposed to be leaving court, and is engaged in conversation by some of those around him on subjects which may have officially occupied his attention. The weight of the body is borne by the left leg, while the right still rests upon a higher step, the descent being assisted by the right hand resting on a support. This is an agreeable departure from the set *pose* of high ceremony, in which it is too often deemed necessary to plant high dignitaries. The features are relaxed into a genial expression, though in some degree saddened, as if by a presentiment of evil days to come. The head is uncovered, and the features are young, though Michael de la Pole must at this time have been fifty years of age. The connection of the De la Pole family with the town of Hull fully justifies any commemoration of the name which the corporation and inhabitants could establish; for not only were the De la Poles eminent as merchants of Hull, but greatly distinguished among the merchant-princes of England. There is also in Mr. Keyworth's studio a bust of the Marquis of Westminster, on the success of which, as far as it has been carried, the artist we think is to be congratulated. The Marquis wears the volunteer uniform, and the general treatment is extremely simple. There is not, we believe, any bust of him, this being the first time he has ever sat to a sculptor. As the work is only yet in the clay, and the sittings are at present suspended, it is premature to say more of it than, that even in its present state it is very striking as a likeness.

MESSRS. COX AND SONS afforded us the opportunity of minutely examining the very splendid and costly Bible recently presented by the Church of England Sunday Schools of the United Kingdom to her Royal Highness the Princess Louise, on the occasion of her marriage. The binding in which the book (as a jewel in its mounting) is enshrined, is a very perfect specimen of the bookbinder's and silversmith's art. The sides are of vellum diapered in gold, with tooling of appropriate devices, and enclosed

in a mounting of silver, perforated with foliage, set with jewels, and enriched with scroll wire work, having gems for the flowers. The sides are strengthened with applied mouldings, and united to the back by continuous silver hinges. The back is also of silver gilt, moulded into a very elegant form, with plates at top and bottom to protect and conceal the actual sewing of the printed sheets, and is adorned in *repoussé* work with the sacred monogram, the title and date in ornamental characters, with foliage and jewels in appropriate settings; and in the lower part with niches, beaten in the silver, containing the Princess' initial entwined with her coronet and the ancient Ship which is borne on the shield of the Duke of Argyll for the Lordship of Lorne. The composition is united and completed by tabernacle-work, mouldings, and foliage. The whole is of mediæval character, beaten by hand out of silver plates, and is a good example of the skill and thought that can be expended on works of such moderate dimensions, and that are required to make their works of Art. The work was designed by Mr. S. J. Nicholl, architect; and executed by Messrs. Cox and Sons, of Southampton Street, Strand.

NEW COURTS AT SOUTH KENSINGTON.—The new courts at the South Kensington Museum, which display, at present, only vast blank red gables to the passengers on the Brompton Road, and are gradually edging Mr. Woodcroft's Patent Museum into the gutter, will form a remarkable feature of a group of buildings which is annually assuming more and more importance. The estimates passed the Commons, unquestioned by any of the furious advocates for economy where they have no share in the expenditure, owing to a lucky blunder of the chairman of the committee. There can, therefore, be no doubt that we shall see the design of these courts fairly carried out. They are intended to receive objects too colossal to find room in any other part of the museum. The Sanchi Tope will be erected in one, and the magnificent Portal of Sant Iago, which has been so imperfectly presented to public view hitherto, opposite the entrance of the museum, in the other. The courts are each 120 feet long, 60 feet wide, and 90 feet high. They are of twin structure, being divided by an arcade, supporting a gallery communicating with the other galleries of the museum. At the height of some 60 feet a row of highly ornate cantilevers supports a balcony that runs entirely round, from which a view is obtained of the court below. A row of windows opens on this balcony; but the principal light is derived from a curved ceiling, panelled in dead glass. The effect, as at present apparent, is most promising. But it will be necessary to deaden the glass in the vertical windows, which will otherwise greatly interfere with the illumination derived from the roof. As simple lofty chambers, designed, and very appropriately designed, for the display of very large objects, these new courts are, as far as our knowledge goes, quite without either rival or precedent.

VICTORIA EMBANKMENT.—The garden on the Thames Embankment between Charing Cross and Blackfriars has been opened to the public, and gay dresses and bright faces may be seen wandering over the fresh gravel, and looking with wonder at an attempt to make people happy, *gratis*. The seats are much to be commended, except for their disproportionate height, which is such as to destroy the repose they would otherwise afford to women, children, and four men out of every five. They must

have been designed by some abnormally long-legged person. Turf and trees cannot fail to be charming in the very interior of London. But the method, to which we objected as soon as the work was commenced, of raising unmeaning mounds to shut out the squalor of the land-ward premises, is an unquestionable mistake. These mounds are planted, and when the trees and shrubs have grown, and when the leaves are on them, they will serve as a screen to the people in the garden. But it is inconceivable that the premises in question should be left in their present disreputable condition. The erection of the bank, however, is a bar against their improvement. The proper thing would be to level the banks—artificial hills are always absurd—and to build an arcade at the back of the Garden. A charming winter-walk would thus be given to the metropolis; a convenient cover might be afforded to the premises, and a row of shops or stalls would render the undertaking lucrative as well as ornamental. At the same time the fine old water-gate, by Inigo Jones, which now looks so absurd, up to its knees in the bank, could be properly restored. Either it should be raised some 8 or 10 feet, or a proper flight of steps, with side walls of appropriate masonry, should be built so as at once to display and to utilise it. With tumble-down back-premises, large spaces of unoccupied building-land, sham banks, and buried gateway, the Board of Works has done all in its power to spoil what, in spite of it, is one of the brightest spots in London.

MUSEUM OF PRACTICAL GEOLOGY.—A new edition of the Catalogue of the contents of this institution has recently been published. Since the first edition appeared, in 1855, the Museum collection has been so largely increased—and as a consequence has been re-arranged—that a new Catalogue was absolutely necessary. This has been almost entirely prepared by Mr. Rudland, Assistant-Curator; but a most valuable addition to it, is in an Appendix, by Mr. George Maw, of Benthall Hall, Staffordshire, a practical potter, and a recent contributor of numerous specimens of raw materials employed in the manufacture of pottery of various kinds: it is to the description and use of these that Mr. Maw has limited himself, chiefly in a tabular form: he sets forth also the localities in which the clays are found. The Catalogue is extensively illustrated, and cannot fail to be specially useful to manufacturers and collectors.

MR. ALFRED ROGERS, of Maddox Street, the son and successor of the most famous wood-carver of this century, who still lives (an octogenarian), exhibits a large number of his own works, and those of his venerated father. Those who can estimate this beautiful and attractive class of Art, will do well to visit the establishment and examine them. They consist of brackets, jewel-cases, miniature-frames, picture-frames, boxes, and so forth, exquisitely designed and carved; in many instances so ably, that the works of the son are seen advantageously beside those of the father.

CIVIL LIST PENSIONS.—Among the names which appear in a recently published list of Government pensions, is that of Mr. Warwick Brookes, "in consideration of his talent as an artist." Can any of our readers tell us who this fortunate gentleman is? for we confess never to have heard of him.

MR. FOLEY, R.A.—We are happy to state that this gentleman has returned from Hastings so far improved in health, as to be able to resume the labours of his studio.

REVIEWS.

BRITAIN'S ART-PARADISE: or, Notes on some Pictures in the Royal Academy, 1871. By the EARL OF SOUTHESK. Published by EDMONSTON AND DOUGLAS, Edinburgh.

It is a rare occurrence to find a peer of Great Britain employing his pen as a critic of the works of our painters: yet this is what the Earl of Southesk has essayed in a modest pamphlet of between forty and fifty pages. His lordship has arrived at the conclusion that our artists "are, year by year, doing less justice to themselves and less to the public:" and there is no doubt he will find many who agree with him. Some of the reasons he assigns for the inferiority of modern to ancient Art, are:—"False ideas in Art; False ideas in morals; Cynical indifference to real fame; Want of respect for Art and for the intellect of the public; Flattery of the fancies of the day as a matter of trade; Haste and Carelessness; Contentment in the use of bad materials; and persistency in the conventional misuse of them. Above all,—Forgetfulness that an inner spirit, as well as an outer form, subsists in all Art-work, and that unless the first is created in truth and beauty, the latter can be endowed with but little of either. Common sense (which is truth in homely guise) is set at nought, and the 'fitness of things' is disregarded or despised."

In opposition to this list of serious charges against our artists, we must offer one in their favour, if anything venial may be said in the way of condoning false or bad Art, or that which is presumably so. Lord Southesk accuses painters of "want of respect . . . for the intellect of the public:" we may mistake his meaning, but, supposing the phrase is intended to convey the idea of the intellect as applied to taste and judgment in Art-works, it may be questioned whether the *public*, employing the word in its most comprehensive sense, knows anything at all about it. And how could it be otherwise? seeing that nine-tenths of the community have never made Art a study, even in its grammar. Artists paint works that are likely to find buyers, and endeavour to accommodate themselves to the taste of their customers. It is matter of deep regret that it should be so; but until the public has been taught to discriminate between good and bad, real and fictitious, Art, this must ever be the case. The fault lies less with the painter than with his patron. The question, however, is too wide for discussion in this place.

Lord Southesk is evidently an ardent admirer of the works of the old masters, and trying those of living artists by the touchstone of the past, he finds them wanting in almost every excellence he sees in the former: the comparison may not be quite fair, nor reasonable, taking times and circumstances, and other matters, into consideration. Arguing from his stand-point he unquestionably proves his case against some of the leading pictures in the late exhibition of the Academy; and though we could not adopt as our own the whole of his strictures, it must be admitted that his lordship brings to bear on his critical remarks no inconsiderable amount of taste, judgment, and discriminating knowledge of Art. His pamphlet may be read instructively both by painters and their patrons: its severity is not unmingled with kindness of feeling.

GESCHICHTE DER PLASTIK. VON DR. W. LÜBKE. LEIPZIG, VERLAG VON E. A. SEEMANN.

The interest commonly felt in the subject of this work, and the admirable manner in which the book is placed before the public, entitle it to a place of mark in the catalogue of Art-histories. The first edition was published in 1863; and in prefacing this, the second, edition, the author says, that the favourable reception which has been accorded to the former has induced him to bring forward another edition. By those to whom the book is in anywise known it will be found how much improved it is as to fulness of detail and completeness of treatment, especially in those portions devoted to the

consideration of the antique. The number of illustrations in the first edition was 231, but the additions have necessitated an augmentation of the number to 377, all woodcuts after drawings of perfect accuracy—indeed, it would almost appear that the draughtsman has ventured to improve some of the early Greek and Mediæval compositions. Be that as it may, the illustrations give a double value to the written matter, for even written descriptions of diversities of styles never satisfactorily enlighten the artist; and the more elaborate and minute they are, the more hopelessly they embarrass the amateur. It is not necessary, however, briefly to go over the oft-told tale of the birth and infancy of sculpture, but it may be useful to point out how the relations of the Art in different countries and at different periods are signalized. It is not the multitude of illustrations that instruct us on the main points it is desirable to consider, but the judicious selection and careful apposition of materials that define styles and epochs.

The plan of the work opens with a chapter on the sculpture of India, which is followed by an essay on that of Egypt. We have then examples of the well-known sculptures of Nineveh, and may remark the great step made in the animal forms contained in some of these works, while it is observable that the human figure, for a lengthened period in the early times of Greek Art, is still modelled with a decided leaning towards the styles of Nimrud and Persepolis. Nor do we recognise a perfect emancipation from Assyrian and Persian influence until we arrive at the end of the sixth, and the beginning of the fifth, century before the Christian era, as shown by our own statue of Apollo, by Canachos, in the British Museum. After this we are gradually led up to the brightest era of Greek sculpture. The second volume opens to us the sculpture of the early and later Gothic periods, referring to the cathedrals of Bamberg, Strasburg, Freiburg, Gloucester, Nuremberg, Augsburg, Esslingen, Westminster Abbey, &c.; after which is considered the Italian Art of the twelfth and fourteenth centuries, with examples of the beautiful works of Nicola Pisano and Giovanni his son, Pietro Tedesco, Niccolò Aretino, and the works of others at Venice, Naples, &c. The commencement of the fifteenth century introduced a new era, with the rejection of the traditions under which the artists of the earlier times had worked. Francesco Squarcone went to Greece in order to collect materials as the groundwork of study, and Brunellesco and Donatello visited Rome with the same view, and we know to what account they turned their experience. This, we may say, brings us down to the time of Ghiberti, who, falling in with the feeling shown in the Baptistery gate of Andrea Pisano, at Florence, began his in 1403 and finished it in 1424. In dwelling on Italian Art, all works of any degree of prominence are mentioned, as are also those of Germany, among which we were much interested in the account given of the Nuremberg artists, Dürer, Vischer, and others, who stand apart from the common current. The work ends with Canova, and a brief review of sculpture since his time; the whole constituting a history of sculpture complete, intelligible, and comprehensive.

ART PAST AND PRESENT. A Few Words to English Artists on the State of Art in this Country. Published by W. RIDGWAY.

It is not an easy matter for any writer about Art, whatever faculties he may possess for the office of teacher, to gain the attention of artists, as a class. They are not amenable to instruction, if the lessons inculcated are not in accordance with their views, or opinions, or tastes. Generally an artist works in the groove he has made for himself, or which seemed natural to him; and it is very difficult, nay, almost impossible, to move him out of it; nor is it to be supposed that the anonymous author of this pamphlet will be able to effect what many previous writers have failed in accomplishing when attempting to change the character of English Art; even were it in all cases to be desirable: of this we are by no means sure. Art is ordinarily the reflex of a nation's mind,

expressing its ideas, feelings, and habits; and it is scarcely to be expected to go beyond this.

With the exception of landscape-painting, the author considers British Art at a very low ebb. "Glancing round our annual exhibitions of pictures," he says, "we see (with the exception of some few men whom it would be invidious to name) that, in compositions demanding high expression or original treatment, either utter inability to touch the ideal is apparent; or, as in most cases, a forced and theatrical effect takes the place of real power. In portrait-painting, which during the last century has obtained great excellence amongst us, although the flesh-tints and colour of hair are represented with a wonderful regard to truth, the attitude and adjuncts of the picture (so to speak) proclaim how dwarfed is the imagination by a servile fidelity of imitation of whatever may be good or bad. Portraits are seldom seen where the face is a study." And further on, after denouncing the painters whom he assumes to be led by the public; and the public, who follow the leading of ignorant Art-critics; he asks, "Are our artists utterly without any spirit of their own? Are they so far divorced from their Art and influenced by the prevailing Mammon-worship, that they care not what their work is, so long as it can command a good figure? Public taste, at a particularly low ebb just now, must be pandered to, or else success is doubtful. Private patronage delighting in inferior Art, is eagerly sought for. Common subjects, vulgar portraits, these please popular taste. Once an educating power, Art is now but an instrument of ministering to the insatiable demand for pleasure."

Admitting that there is but too much of truth in these strictures, yet it is undeniable that when a really good picture, whoever may have painted it, comes before the public, it soon finds a purchaser: Art-patrons are not blind to excellence, nor slow in seeking it out, and securing it. The advice of our anonymous author to artists is—and it is not unworthy of their notice—"Let them educate their patrons, not be taught and guided by them. Let them show that the true spirit of Art is not quite dead, that something yet remains to be done by those who are able to do it. Let the education, not the amusement, of the people, alone be the noble aim they set before them. Men who have the power and understanding should not fritter away their energies." The writer's aim throughout the pages points to the development of sacred Art in its highest manifestations; but the tendency of our age is altogether in the opposite direction.

OFFICIAL REPORTS ON THE VARIOUS SECTIONS OF THE INTERNATIONAL EXHIBITION OF 1871. Edited by the Right Hon. LORD HOUGHTON. Fine Arts Division, Part III. Published by J. M. JOHNSON AND SONS.

What may be the contents of the two preceding Parts of these Reports we have no means of judging; for Part III. only has reached us, and that through the courtesy of one of its writers. It includes a paper on Engraving, Lithography, &c., by Mr. Julian Marshall; one on Wood-Engraving, by Mr. T. J. Gullick; another on Photography, by Lieut.-Colonel Stuart-Wortley; and a fourth on Architectural Designs, Drawings, and Modelling, by Mr. T. Roger Smith. Mr. Marshall's report is scarcely more than a brief history of his subject; he seems to have found but little in the Exhibition worthy of reference. But to this paper, the editor, Lord Houghton, has appended a note which, certainly, concerns ourselves; and, therefore, we have given it prominence in a preceding page.

Mr. Gullick follows much in the wake of Mr. Marshall, but enters somewhat more into the specimens of wood-engraving now at South Kensington. His remarks are discriminating and judicious; but he deprecates that contemporary Art is so slenderly and inefficiently represented in the Exhibition. Col. Stuart-Wortley considers the display of Photography of 1871 a "marked advance on any previous International Exhibition, in the two points on which the future status of photography principally must depend." He alludes, first, to the more earnest seeking after Art

as seen in the treatment of subjects; and secondly, to the extreme importance of the improvements shown in the new processes by which permanence will be given to the photographic print, and greater economy and simplicity secured in its production.

But by far the most comprehensive and relevant report is that on the subject of architecture by Mr. T. Roger Smith. It is thoroughly practical and to the purpose; and is worthy of perusal by the profession. Architecture has its own special organs among our cotemporaries, and we must leave it to them to discuss the views embodied in Mr. Smith's contribution to these Official Reports.

NOBLE LOVE, AND OTHER POEMS. By COLIN RAE-BROWN. Published by W. SKEFFINGTON.

This unpretending volume of poems rises far above the level of what is usually considered good poetic composition. The story of "Noble Love" is very simple: the hero, "a child of charity," is taken into the counting-house of a rich London merchant, with whose only daughter he falls in love, and who returns his attachment. But the young lady, unknown to herself, had been betrothed, when a child, to the heir of a goodly acres adjoining her father's estate. The discovery is made when Edith comes of age; and Evander, the type of "noble love," leaves her and his country at once, to seek his fortune in a distant land, where he accumulates vast property with the sole object of presenting it to her in the shape of a

"stately Doric Pile whose walls
Have sheltered thousands whom the waves of life
Threw back upon its strand—as helpless wrecks
Unfit to battle longer with the storm.
Such was the ending of Evander's dream,
And such the Noble Love to Edith given—
Such is the history of a Life well spent,
Emblazon'd in a deathless Heraldry!"

The poem deals less with the plot of the story, than with thoughts and reflections on the age in which we live, associated with some very beautiful descriptions of nature. Its whole tone is high, and its language both elegant and powerful. It is appropriately dedicated to the Baroness Burdett Coutts, as "exemplifying a phase of English Charity."

Many of the minor poems in the volume are, in purity of sentiment and refinement of feeling, in no way inferior to "Noble Love." "The Light of the Word," "The Scottish Emigrant," "Outsiders," "Five Hundred," a tale of the sea, with others, are most creditable to the heart and the head of their author. The book will add another leaf of laurel to the chaplet already worn by Mr. Rae-Brown, whose "Dawn of Love," and other poems, published some time ago, passed favourably through the ordeal of public criticism.

MY SCHOOL DAYS IN PARIS. By MARGARET S. JEUNE. With Illustrations. Published by GRIFFITH AND FARRAN.

This pretty volume, which will much interest old and young, is got up with the excellence that characterises the publications of Messrs. Griffith and Farran. The contrast between French and English school-life is drawn with a pen steeped in loving memories of the past; but the reader must not imagine that this is a reliable picture of school-life as it exists in every French school. The author's lot was cast not only in a pleasant first-class Protestant *pension*, that had the advantage of being conducted by gentle and refined ladies, who mingled pleasure and instruction together, but the pupils were more carefully selected than scholars generally are; the elements were well blended; one class drew forth the best tendencies of the other, and if there were "black sheep," they were kept out of sight! But we cannot accept this picture of "school days in Paris" as a type of French, or, indeed, of any schools. It is the *exception*, not the *rule*; but the volume is cheerful, agreeable, and useful, and we should welcome and enjoy another from the same pen.

THE ART-JOURNAL.



LONDON: OCTOBER 1, 1871.

THE HOME OF A MAD ARTIST.

STANDING on the Carraja bridge at Florence, and looking sixty miles away to the westward, the spectator sees three prominent peaks, rising like a triple crown over ranges of mountains, which break up the nearer and farther distance into walls of luminous purple and deepest blue. At sunset a flood of opalescent splendour shimmering around them wraps the scene in golden mist, just as the burning atmosphere of the summer's day cools into limpid starlight. In winter the snow-robed crown sparkles in the frosty air as if it were cut out of solid diamond, giving to the Carrara mountains, on whose head it rests, the queenship of the Apennines. But this wintry magnificence, like a glimpse of another world too bright for mortal eyes, can only be enjoyed far off. When, however, the warm months envelop it in soft sheen and mysterious space, melting into shadowy heights, the gazer lingers wistfully over the shifting forms and hues, and yearns to be among them. For myself, I have never seen these mountains in winter or summer without an involuntary desire to go there. They appeal to the inner sense as a resting-place midway between earth and heaven, where body and soul might receive strength for either. The summer of 1869 was so beautiful in Florence, that it was a penance even to think of going elsewhere, as indeed it is at all times to those who have long resided within its walls. Nevertheless, I could never cross the bridge without being haunted by my temptation, now of eighteen years' growth. A daughter was tardily recovering from a lung fever,—the legacy of whooping-cough,—when the physician prescribed mountain-air as more healing than drugs. So Pescaglia was recommended as affording the best. But where was Pescaglia? Precisely within the charmed circle of this triple crown of Carrara hills, nestling amid chestnut and oak trees, imbedded in fragrant vegetation, and clinging, with divers sister-hamlets, as ancient as the Cæsars, to steep crags divided from each other by cool glens, joyous with running streams, and shaded by old monarchs of the forest which had braved the centuries since the days of the tyrant Castruccio, and, it may be, the pious Countess Matilda. Here, if anywhere, nature was serene and charming; a health-giver to spirit and sense, promising a loving return, in her own motherly way, to human confidence. True, there was not a semblance of an inn; an unfattened calf was killed only once a week, to be divided among the few eaters of meat of the region; bread, dark and acid, had to be brought many miles; fruits were scanty and half wild; in fact, the diet must be restricted to such supplies as could be gleaned from the scantily-stocked farms of the peasantry, who were as innocent of any knowledge of the ways and wants, and even the persons, of city people, as so many Calmucs. The fare was not attractive, for the only food in reliable abundance was the staple, clammy, chestnut-cake, of a deep chocolate colour, which only the active life of a goat could render digestible, while to the untutored stomach it was a nightmare of a thousand-fiend power. Still there was some-

thing so bewitching in this mingling of feast of the soul and famine of the body—nature, at once so aesthetic, spiritual, and sanitary, doctoring dilapidated frames without fees, and hindering all excesses of mind and body whether we consented or not, that it hit the appetite for novelty if it missed the more carnal one. Moreover, even greater boons were promised—complete social enfranchisement, harmony and equality with the natural world; absolute genuineness of life, even for a fleeting moment; these were indeed royal gifts.

Being loth to tempt the tempter into this Eden, I decline to name the town where we exchanged the rail for the district road which came to an abrupt end at the foot of the picturesque crag, out of which Pescaglia grows as naturally as its chestnuts and vineyards. No carriage-wheels ever profane the quiet of its narrow streets. The strong visitor must climb to it on his own limbs, and the invalid be borne in a chair on sturdy mountaineers' shoulders. Suffice it to know that the road to Pescaglia is lovely even in the most fertile province of Italy. Winding beside a coquettish river, it passes through tunnels, under toppling cliffs, along gorges flattening out into meadows and orchards, shadowed by olive and vine-growing hills, covered with *renaissant* villas and feudal towers, and bordered by ivy and rose-draped walls fringed with hoary mosses, amid which flit in imperial livery of green and gold mercurial lizards. It opens on mediæval churches far gone in decrepitude, like the temporal power that reared their walls, but whose silver-toned bells are as sense-enrapturing as ever, when their mellow strains echo throughout the neighbouring peaks. It stretches across dry torrents choked with the avalanches of spring, and devastated fields. It is caressed by wild plants bending beneath the weight of their fragrant charms as they listen to the chatter of merry brooks or flirt with amorous insects. Now and then we encounter a country cart clattering along at a break-neck pace top-heavy with embrownd maidens going to and from reeling the cocoons of silkworms, in those strange buildings with steaming "loggia," which surprise the novice in their mysteries; donkeys that jealously regard the city-carriage with heels perversely turned thitherwards, inviting collision; a soil neither flat nor sterile, but a happy mingling of man and nature in a struggle to get the best of each with occasional signs of disagreement in their methods of agriculture. Such were some of the features of this road, as it wound among valleys that shut in closer and closer, narrowing and deepening until the last turn brought it to an abrupt termination at an old stone bridge over the precipitous streams which furrow the mountain on either side of Pescaglia, and, whenever it rains heavily, make it roar with the rush of their impatient floods. There stood our "city of refuge," looking from its perpendicular eyrie almost straight down upon us, peeping out of a bower of green, overtopped by the ruins of a venerable castle, backed against precipices half hidden in luxuriant green, but too rough to be ascended otherwise than by the tortuous paths which led to the highest pastures, just under the naked peaks that cut sharply but gracefully against the young twilight. Everywhere the outlines of the Apennines are of feminine beauty of contour and delicacy of curve.

Invalids and baggage had been put down on the roadside, and abandoned by our driver, to contemplate the scenery until help should come from above to make the ascent. Shut in below as we were by the steep and close hills, it was almost dark before it arrived. Meantime, the gossips of the sole habitation hereabouts brought out some rude chairs, and proffered such hospitality as their meagre household might yield, with genuine good-will and an absence of a disposition to make money out of our position that showed no theories of *bakshish* had yet entered their souls. They were decidedly behind the age, but in the right direction for travellers. As ours was the first foreign family that had come among them, this exemption undoubtedly was due to ignorance of their *suzerain* rights, which future visitors can explain if they choose. Under the circumstances of our appearance in this sudden fashion, stranded on their highway, an

indefinite amount of voluble curiosity would have been pardonable; their manners, however, were not merely unexceptionable, but the acme of refined courtesy. I felt at once as if I had always lived there, and each face was a familiar friend. The few foot-travellers—pedlars of wooden shoes and cheap female finery, or peasants driving before them files of donkeys laden with wood—manifested no more surprise at our improvised encampment than would a city-idler on meeting a do-nothing neighbour following his praiseworthy example. Saluting us kindly, they passed on without one furtive glance. This was not owing to stolidity of temperament, for on questioning any their replies were vivacious and sensible enough. One scarred and furrowed old lady was eloquent on the woes of life in the abstract, dwelling on her being rooted for more than seventy years to a spot which had no change except of the monotonous seasons to offer to her time-worn body. From birth to burial she had to see the same faces, eat the same meagre food, do the same frame-racking work, and look on the same hard-hearted mountains. Fine scenery, forsooth, but what good came of that to her! Evidently she was a misanthrope in principle, just as there are pitiless philanthropists. The world needed a certain amount of grumbling to keep it moving, as a donkey requires the cudgel; and Pescaglia had fallen to her lot for its castigation. As she turned to go, with a lugubrious shake of her withered head and a pitying glance of her sharp eye, she asked "if we came voluntarily." On being assured that it was actually so, "you'll find good air and water, nothing else; this is all Pescaglia gives to any one; much good may they do you. Good day," and she hobbled off.

Others stopped for a chat of a more cheerful turn, doing the honours of their mountain scenery with a sincere appreciation of the "fine air and water," which all agreed were its distinctive merits. But even these could not quite take it in that we had come "voluntarily." Never did a few people show a more touching humility as to their own importance and local advantages, but whatever they had was at our disposal. Their talk was so simple-minded and unworldly that I was almost sorry when the carriers did arrive. We made a merry *cortège* up the paved footway under the trees, more picturesque, but steeper and more winding each step as we drew near the house in which we were to be lodged, whose owner, leaving a singular history, had died the preceding year. Our self-made friends seemingly attached a peculiar importance to us because we were to occupy this grand "villa," which in their eyes was the seat of untold magnificence, the like of which it was doubtful we had ever seen. It was superbly furnished; in short, a miniature Versailles, if we might construe their adjectives by their common significance, spoken in an undertone of mingled awe and mystery. Having expected nothing superior to the stone floors and rough quarters of an ordinary farmhouse, this intelligence was agreeable, besides *piquant* to the curiosity. Our path left the real Pescaglia somewhat on the right hand, and ascended a twin hill, skirting the mossy walls of an extinguished convent and a tiny church of the Lombard period—that is, all of it that had not been restored by modern Vandals into architectural and spiritual inanity—until losing itself on a narrow, ankle-wrenching pavement between rows of stone houses, so called by courtesy, but in reality cheerless hovels of prosaic discomfort and poverty within, and picturesque outlook in mass without, which led to a *cul de sac* that terminated in an embattlement doorway and courtyard. On ringing a brisk bell the entrance flew open, presenting an agreeable spectacle, if not the counterpart of Versailles. A turreted wall enclosed a baby-garden on a terrace overhanging the valley, with miniature parapets and towers having all the grand airs of a feudal castle, even if it were not as big as a real one. In the centre was a marble fountain throwing up exquisite jets of mountain-water as clear as crystal, sprinkling confused masses of lemon and orange trees, vines, roses, tea-plants, and others, rare and common, helter-skelter in a labyrinth of democratic weeds. Fronting in our way, with drawn sword and full panoply of armour, was

the archangel Michael, the guardian of the gate, in lively fresco, but with his celestial splendour somewhat dimmed by long exposure to earthly showers and incipient cryptogamia. The villa itself formed two sides of the garden. On the left, as we went towards the principal door, was an elaborate fresco covering two stories with an extraordinary composition. In the centre stood the Madonna in glory, with a face of ineffable sweetness, gazing on rats jumping through hoops held by other rats, and doing all kinds of circus antics, besides stealthily cutting off the tail of a huge cat unsuspectingly moralising on the top of a queer palisade. Others were holding up gold coins in their mouths to the Virgin, or blowing soap-bubbles in her honour. But the queerest fact was the humanity expressed in the features of all the rats, as distinctive as so many human beings, but otherwise cleverly drawn, and coloured rats of all degrees and ages, singularly coherent in expression in an extravagant incoherence of entire composition.

By the time we had got thus far our general escort had vanished like so many shadows, evidently having either a wholesome respect for the grandeur of the premises or a mystical fear of its painted inmates. If the exterior decoration were queer, the interior was even more so. Each room, ante-room, stairway, and ceiling was thickly painted in strong oil-colours with similar compositions, done not unskillfully by a free brush and vigorous stroke. I must describe some. The great hall was laid out in Chinese scenery of the cheap tea-tray fashion, jumbled with chaotic phenomena of the heavens, ships scudding against the wind, and a demon-visaged comet dashing headlong into the sun just rising over the hills in the shape of a human face surrounded by spiked rays, with eyes weeping mammoth tears in harrowed anticipation of the collision. A nautical rat, standing upright on the topmost leaf of a tall tree, was inspecting the scene through a telescope, while another at the foot was inquiring what it all meant.

Our chief bedroom had a very weird and apocalyptic aspect; three sides being filled with hosts of doves sweeping centrewards in regular, interminable, converging lines, feathery hosts on hosts, some full grown, others just bursting from their egg-shells, led by naked *amorini* with immense dickerkeys about their throats, epaulettes on their shoulders and regulation kepis on their heads. For a moment the room seemed to whirl round and round in their whirling flight, while the great blue eyes of the military Cupids glared at us so wildly in the dim light that I exclaimed, "I can't bear this; if I sleep here I shall go crazy." A waking horror, like the stealthy creep of a choking nightmare, weighed down my brain. Was the air of the chamber filled with infectious madness? But the ringing laugh of my wife quickly drove away the demon of gloom and summoned the imp of the ridiculous in its place. The paintings soon became such an unending source of amusement and speculation that it was agreeable to be among them. Incoherent as they were to the last degree, they begot at last in me a dreamy repose of mind and body eminently refreshing and companionable, as if they were the embodiment of unseen, inscrutable joys rather than maddening woes.

But to return to first sensations! A shout of laughter and wonderment from the children drew us to their discovery; a decidedly original picture of "*Providentia divina*" and family love, as it was inscribed. A lady-rat, just confined, was lying in a stately bed with lace cap and ruffles, awaiting her gruel which a tidy rat-nurse was bringing her in the orthodox vessel always provided for this momentous domestic event. The rotund-bodied father was lying on his back on the floor, amid a heap of toys, tossing several of his babies on his four feet into the air; while the rest of the brood were enjoying their playthings or quarrelling as fraternally as if they had been human babies. Stores of apples and other toothsome dainties formed the walls and ceiling of the nursery of this happy family. My own little rats, the youngest only fifteen months, never grew tired of examining and commenting on this wonderful composition.

On the opposite wall was a far different scene. At the left sat an impressive, allegorical,

gigantic figure of a woman of majestic mien and handsome features, dressed in blue, surrounded by mystical emblems and inscriptions in unknown tongues, of gracious look and abstracted air, leaving one in doubt whether she was meant to be the incarnation of the arcana of the black-art or one of the mysteries of the Apocalypse. At all events it was a masterpiece of intense supernatural suggestiveness which would not have discredited William Blake. There was a wise solemnity and spiritual composure about it that soothingly contrasted with the crack-brain character of the rest of the wall-decorations. Immediately next to it, behind the bed, was a handsome Madonna in glory, watching flying fiery serpents and nondescript monsters wildly shooting through space, wept over by a lugubrious sun, like the one in the hall, rising over a foreground of slab-like rocks broken with sharp precipices, down which, sitting on drums, rats, travestied as soldiers of the line of the time of Napoleon I., were sliding, falling, pirouetting, or presenting arms to the Virgin.

The chambers above, which formed our nursery, were known as the "rooms of the sacred mysteries," so the *custode* of the villa told us, although anything more mysterious than these below them would be difficult to conjure up. Some of their scenes were naïvely curious; one, a party of old rats with human physiognomies, gambling—the oldest and wickedest glancing over his cards with sardonic satisfaction at the chagrin and fury of those whom he has cheated, overlooking an outsider who is silyly stealing the stakes. Another was a more elaborate affair, occupying an entire side of the room, in the centre of which was the Holy Family and attendant saints in masses of clouds, listening to polkas performed by bands of rats dressed as military musicians. At one side two rats were blowing the face of the sun with great bellows to keep up its heat; and in a corner the moon, pale and sickly-looking, was being fed by one of these quadrupeds with porridge out of a huge spoon.

I fear it would be tedious to describe any more of our "Versailles" gallery, but the dining-room must not be omitted. Next to rats, the favoured topics were Franciscan friars. All of this part of the villa was dedicated to them. The painted background formed the whole interior architecture of a convent, exposing cells, refectory, prison, chapel, and cortile. In some of the cells the friars were uncorking champagne bottles labelled with the insignia of the Holy Ghost. In another, one was carrying his head under his arm in a procession—a miracle unnoticed by his brethren, among whom were two women in disguise, whom also they discreetly failed to see. The prison held a friar undergoing penance, tormented by be-devilled cats and frightened by a bodiless arm ringing a bell over his head, while others kept rapping on his window. In the refectory the table was laid with two big bottles of wine and a small bit of bread for each friar. The standard of conventual holiness was decidedly material. Our deceased host himself had been a great collector of bottles. These were arranged by hundreds, of all sorts and shapes, on shelves in the dining-room, filled with extraordinary liquids, and decorated with masonic and Christian emblems and signs of the Trinity in silver and gold paper. The chapel itself had been partly converted into a *studio*, and in part devoted to an altar covered with tawdry French ornaments, and dismal *souvenirs* of the grave. Altogether it was a strange villa.

The history of its owner was still stranger. He had been city-born, of a noble family, rich as provincial fortunes count; had travelled, sojourned often in Paris, whence came the luxury of furniture, linen, silver, glass, and books, we found here; and, finally, after many bachelor experiments in love, had decided on marrying a peasant-girl, with whom he was really enamoured. To this turn of eccentricities his relations put their veto. In America there would have been but one ending to a similar interference; but in Italy, where family discipline is supreme, our friend's protest took the same turn against his own body that Heloise's relatives did against Abelard's for his illicit love of their charge. By his own hands he was as effectually cured

of any disposition to marry his sweetheart, or any other woman, as his nearest heir could wish. In lieu of an amatory ambition he was seized with an artistic mania for decorating this villa, in which he passed most of his time, bewildering and amusing his rustic neighbours, wasting his patrimony in painting and re-painting, harmless in his ways, often jocose and hospitable, ducking unsuspecting girls by suddenly letting loose his fountain on them, experimenting in horticulture and entertaining monks, who enjoyed his fare if they did not his frescoes. Thus he lived on in a half-serious, half-droll manner, but gradually growing sadder and madder, until his kind guardians who had provoked his madness sent him, vainly protesting, to a mad-house to die, which he speedily did of the longing he had to be back painting his quaint imaginings once more on the walls of his quiet home at Pescaglia. A short story, but it is all I have to tell of a soul's tragedy that even now moves me strangely, as I recall its sad record in that strange little villa whose atmosphere was yet green with the piteous memories of a gifted, wasted life; yet not all wasted, for there were in them spiritual gleams of consciousness and an evident struggle for better things, not all impotent of celestial fruit let us believe, as the last sigh left his phrensied lips on earth, and his spirit ascended to peace and freedom, to love and paint for ever as he liked in the celestial kingdom.

And now, patient reader, if you do not weary of this storyless tale, let us chat a little with our living neighbours. The first comer, and not the least gossip, is the gentleman who brings our milk. I say "gentleman" advisedly, because his manners and language are thoroughly gentlemanly; his bearing easy, independent, and courteous, indicative of self-respect and respect of others. Had our croaking old dame below added fine manners to her scanty list of good things at Pescaglia, she would have come within the truth; for they were as abundant and spontaneous as the fine air and water themselves. Indeed I am inclined to believe that the fine quality of these elements had much to do with the prevailing manifestations of genial humanity. In his outer self our milkman was as rough—perhaps we should call it untidy in New England, where dirt has no sense of the picturesque under any combinations—as his brother peasants, but his frank deportment was more becoming than fine raiment. It struck me as I looked at him that to be clothed in one's "right mind" was better on the whole than being in the "height of fashion." He never poured out his measure of milk without making it an overflowing bumper, unwatered (was not that the trait of a gentleman?) or giving the servants an extra quantity to drink to his health, as we sat cosily together on the stone-steps, listening to his tales of Pescaglia life. He was a widower, with a baby-daughter, and would marry again if he could find a woman who would be kind to his pet. For himself he preferred the single existence. His means, a few cows, chickens, some chestnut and olive trees, ensuring him a few hundred francs income, were sufficient. But his sister was a great lady. She owned sixty cows, and made no end of butter, which traders from Leghorn came for weekly. Once a year all the relatives and the *curé* dined with her. Such feast was rarely seen anywhere. Roast-meat, salad, cheese—he gave us a sample tougher than gutta-percha—enough for every one and unlimited "*vino sincero*," the acrid wine of the district, beside which mineral vinegar is honey itself. But his relish of this diet would have been cheaply bought by a city epicure with half his fortune. A broker of marriages—it appears this kind of business is rife in the rural districts—had just described to him a stoutish, good-tempered girl on the other side of the mountain, who had several thousand francs, and eagerly desired a husband; in short, a genuine, buxom heiress of strong hips and spine, whom he would secure for something less than the regular commission,—as the milkman was no novice in matrimony.

I ought to explain that the "strong hip and spine" qualifications are essential for the steep, rocky hills, up and down which the women from infancy are trained to carry heavy burdens on

their heads, while the men rest theirs on their shoulders, supported by a strap around their foreheads, pulling by it much as the oxen do by theirs. Even in polite Pescaglia the largest and weightiest loads were invariably borne by the women. Indeed there is a common saying of the men in some parts of Italy in regard to an extra heavy burden, that "it is a woman's load." Why there should be such a distinction in the mode of carrying, the female skull being thinner and more delicate than the male, I never could clearly make out. Be the reason what it may, its sanitary effects were unexceptionable; for straighter-backed nymphs of firm, elastic step and lofty carriage no where else could be found. The broker was right therefore in presenting foremost the best points of his human wares. But our friend was not eager at sniffing the bait. The reduction of commission had a look of a double commission; the girl might be paying something herself. Who knows, and for what reason? She might not be kind to his little one. In fact, he gave the cold shoulder to the broker, but told us confidentially that he meant to drop over on the sly and get an anonymous look at her charms.

Here comes the mercurial messenger under plea of bringing our letters from the post, a service which he has voted to himself. He is the newsmonger and wisecracker of the whole neighbourhood. A philosopher too, caring neither for the great nor the little world; ambitious, doing nothing to support himself and no one doing anything for him,—a seedy, spare-ribbed, faded-out youth of mysterious means, their *maximum* less than a franc a day; always obliging, and as chirpy as one of the sparrows the Lord feeds, and no less restless of movement and tongue. Well up, is he, in the politics of the world; fluent in Italian literature, conservative in tone but liberal in theory, partisan of nothing, weighing the pope and Garibaldi in a just balance, and pronouncing wisely wherein each was wanting; sagacious in his estimate of the French and Germans in the war just begun, possessing broad ideas and but small geographical knowledge; preferring Pescaglia summer and winter to all the world beside, an idler without an atom of laziness, epicurean with nothing to keep him in condition; knowing the precise value in francs of every girl in the region about, their glowing estimate of their own charms and the counter estimate of their rivals and lovers; to sum up, a daily biper *New York Herald* of Pescaglia, taken in by every householder whether he would or no. His topic this evening was somewhat in the vein of the milkman's, only he omitted his own confessions. The mother of Signorina X. had just snubbed Signore Z. by telling him, after a personal inspection, that he was not handsome enough to be her son-in-law, although the daughter was only too glad to accept any one unseen; that Pescaglia was as innocent of evil as Arcadia itself, but it had one trying fault: everybody knew everybody's business in advance; illustrating this state of precocious information, I repeat it mildly, by the fact that no wife could have the prospect of a family increase without, in less than one week from the actual fact, its being known and discussed on all the doorsteps in town. Pure mountain air is always favourable to *clairvoyance*; the guileless creatures cannot avoid the gift of tongues and double sight. Pescaglia was as watchful over female deportment as the greatest city. No mother, in society, would permit an unmarried daughter of any age less than three-score to go out unattended by herself. If she did, who would marry the sweet dove? Rustic lovers had a better time. Fashion cared less for their courtships, and hence they were happier and honest. After this edifying manner he flowed on until his instinct told him it was opportune to leave, when he would gracefully invent an engagement and disappear.

A more serious visitor was an aged priest; learned and liberal, exiled by vindictive superiors to this wilderness, but who avenged himself by combating papal infallibility and the temporal power by pamphlets, which, with praiseworthy frankness, he addressed directly to Pius IX. himself. The other priests told his parishioners that masses said by him would have no efficacy in

saving their souls. Although living in solitude, devoured by a cruel *dyspepsia* that refused him regular sleep and drove him to solitary rambles at strange hours, he had won the esteem and confidence of the people. Whenever his archbishop sent him a dubious circular to read to his congregation he had the habit of forgetting it, which preserved their brains from being infected by the casuistries of the Vatican, while their un-informed consciences were equally kept from any superstitious strain. But there could be no sounder evidence of the enlightened spirit of the population than their tolerant and even support of him in his antagonism to the pet dogmas and ideas of the Pope. Only a few years before he would have been effectually silenced by the Inquisition. But in Pescaglia the people at large are in advance of their teachers in their readiness to learn, and in independence of judgment. The general type of the Italian peasant indicates a race of remarkable quickness of intellect and fine physical and mental stamina, obscured, it is true, by poverty and the ignorance forced on them by vitiated institutions, and the habits highly esteemed by the papacy as a pledge of unquestioning obedience in its sons. In this outpost our priest was doing good service to liberal progress by disseminating ideas that are steadily undermining the system of intellectual bondage in which the peasantry of Italy has been so long held.

We soon knew all our neighbours. Whenever we strolled courteous salutations greeted us from every doorway, with beaming smiles and pleasant words for the little ones. Here we received news of a fresh comer into the world, with those domestic details which make the human heart beat as with one pulse; there the details of a last departure, so unnoticed in the living crowd of a city, but where we were, shut out of the feverish, great world, particularly solemn and suggestive of one's own call to bid the long good night to earth. Next door, there always sat in the glowing twilight a male dying of a cancer, and so poor that a little portion of our meagre fare seemed to him a feast of Belshazzar. It was touching to receive his daily "God-speed" in our walk, and see his grateful, ghastly smile, so corpse-like that death itself could not change it unless to make it even sweeter in spirit. One evening a dozen chickens just bought and turned loose in the garden to fatten, if it were possible, frightened at the prospect, flew over the wall into the outer darkness, lost, as we gloomily fancied, for ever to our craving palates. By morning unknown hands had recaptured and brought them all back. The population overflowed with friendliness to us as to one another, agreeably spiced with piquancy of individual character. Our mornings were spent on the grass under the shade of old forest-kings, gigantic chestnuts, and youthful oaks, breathing the fragrant air, gazing on the clear summits opposite, or following with the eyes the picturesque mountain gaps and valleys as they meandered towards the Serchio in the far distance. Wild flowers profusely spotted the hill-sides. Insect-life was the most beautiful I had seen out of Brazil. Indeed, in the shady dells and nooks which gathered up the rivulets into natural fountains and waterfalls the vegetation was almost of tropical exuberance and beauty. Large ruby-coloured oleanders enlivened the deep greens of the terraced meadows, alternated by the golden sheen of ripe grain, or the silvery gleam of the olive-tree. Reclining here in the lap of nature, the hours went by only too swiftly. I fully appreciated the wholesome delight of the Japanese in similar scenery, and comprehended how it had come to enter so delectably and extensively into their lives, literature, and Art, engendering an exquisite sensitiveness to natural beauty, and providing resources of health and happiness unknown to the average European mind.

Every day brought us at this spot its social reception of one sort or other. Sometimes animals, birds, insects, flowers, and children played the chief parts, always to the sharp notes and quick beat of the restless *cicada*, which sung in the trees overhead. Stalwart peasants would stop and chat about their hero, Garibaldi; boast that they were better shots than the famous corps of Bersaglieri, and how eager to strike a blow

for republicanism when the hour should come. *Papalini* retaliated by telling us that the *Garibaldi* were cowardly marauders. But political differences seemed to have no sinister effect on their mutual friendliness. Three papers were taken in the village, representing the extremes of radicalism, conservatism, and Jesuitism, and freely circulated from hand to hand, so that none were ignorant as to their neighbours' sentiments. During the hot weather they went to bed at 9 P.M., summoned by a noisy hand-bell rung from house to house, the only human sound that broke the intense silence of our night, after the clatter of the goats and sheep, following the bells of their leaders coming down the mountains had ceased. All the workers rose at day-break to harvest the grain during the cooler hours. In winter they gossiped later around roaring kitchen-fires; courting perchance: indeed, our handsome talker had courted in this manner for ten years, and was so content with his occupation that he might make it a score of years before he committed himself to the more placid joys of wedlock. All agreed that Pescaglia was crimeless. Jealousy and heartburns never provoked the knife as elsewhere. Stealing was unknown unless committed by an outside vagabond. Taxes were heartily anathematized for absorbing quite half of their rents or incomes in one shape or other. Everybody was poor in their scattered population of twenty-five hundred souls, and yet every one was rich; for contentment was the common virtue, and no one ever begged. This exemption from the teasing vice of Italy had greatly surprised us, and showed no ordinary degree of self-respect. I fear, however, my wife inadvertently let envy into the heart of our nearest neighbour, a middle-aged dame occupying a stone-house rented at twelve francs the year, but which she thought was an exorbitant price, by telling her that a city midwife, which was her profession, got twenty-five francs for each case; while her fee was only one franc, and all her numerous relatives must be attended gratis. Ejaculating "Jesu Maria! is it possible," with a dubious shake of her head, she evidently thought she was imposed upon, but whether by us or her clients, we could not make out. Still I do not think that the enterprise of Pescaglia will at present take the turn of raising prices on home-industries, particularly as some of our providers were wont to inquire of us what they ought to ask for their produce. Those who had travelled in the course of their lives as far as Lucca had come back sufficiently developed in the principles of trade as to ask a bouncing sum, with the expectation of being set right by our superior information as to the markets elsewhere. But all were easily satisfied, and showed not the least covetousness. Really they were as simple-minded, honest, and polite, as if there were no money in the world. Happy in the minor key of existence, satisfied with their meagre portion of worldly riches, they literally seemed not merely void of envy and uncharitableness, but were absolutely generous with their scanty means, insisting at times on bestowing gifts of fruit or vegetables on us.

With all this moral wealth, I fear they lacked the one thing needful to a complete appreciation of their resources of happiness. There was no spontaneous sympathy with nature, such as adds so much enjoyment to the lives of the Japanese. In this, however, the Pescaglians only partook of the common insensibility of all Italians to the beauty of the landscape. Nevertheless, "fine air and water," although to some extent counteracted materially by the villanous chestnut diet and frightfully acrid wine, did give a refreshment to their existence, which was gratefully acknowledged. The only suggestion of local pride was in their meek boastfulness of the sanitary advantages of their mountain home. No typical Christian of the apostolic age could be more humble in thought. Indeed, to the last, they never ceased their plaintive apostrophe, "Do you stay here *voluntarily*?" and seemed greatly relieved in mind as to the condition of our faculties, when as often assured that it was to enjoy their "fine air and water" we had come; to them the sole intelligible motive. But nature in this secluded laboratory of hers was doing wiser for their weal than they knew. Constantly fanned by breezes untainted by human foulness

and crime, fresh from those ethereal regions which are the fountain-head of man's strength and purity, they brought to humanity a moral as well as physical *ozone*, which imparted to it the finer elements of character and temperament." In some measure the atmosphere of towns is like that of unventilated rooms, an insidious compound of the grossness and disease of the mass of population, depressing and unwholesome to an individual in proportion as his standard of life is higher than the average of his neighbours. False passions and opinions are as contagious as fevers, and infest the air in the same subtle manner. Despite ourselves we incline towards the dominant tone of life amid which we live. If we emerge from stifling cities into the uncorrupted atmosphere of the ocean or mountain, there penetrates into our systems a subtle, soothing exhilaration, which elevate, the senses into a more spiritual apprehension of the hidden forces of nature while strengthening our material bodies. For a brief moment, before the wave of worldliness again breaks over our quickened faculties, we fancy ourselves nearer to heaven itself. For do not dark spirits affect the gloom of close quarters congenial to their condition, while the bright ones, if tempted to revisit the earth, must choose the sweetest and purest, whether in the individual heart or the air that feeds its life-blood?

But I have another theory to account for the gentleness of this race, more particularly of the old ladies. Whenever we met any of the aged, toil-stained women, so neat in their home-spun, often-patched garments, with their placid bearing and courtesy of language, as gracious in form as those of our ideal high-born dames, when the spirit of chivalry still lingered in aristocratic manners, I always fancied I was spoken to by a noble lady in lowly disguise, fulfilling a vow of humility, to chasten her soul into greater virtue. Why might not these faultlessly polite old ladies, in their tattered robes, with their native elegance of manner, and unconscious equality and independence, a perfect social type,—why might not these gentle, courteous beings be the re-incarnations of haughty, selfish, courtly women, doing voluntary penance for former errors and acquiring, under opposite conditions, those Christian qualifications which are needed to give them rank and riches in the court of the celestial King? If it were so, they were learning their new lessons so well that they might return to the golden city without fearing any further rehabilitation in flesh to remodel lives wasted in pride and luxury. I loved them all. I felt honoured by their hearty, kindly questions and wishes. Unwittingly, they raised my estimate of the fundamental soundness of human nature, when undisturbed by the casuistries of fashion and ambition, and undecked by the weeds of civilisation. In them and their progeny lay Italy's undeveloped promise of power; a promise richer than that of her quarries, her oaks, her olives and vines, and far more precious even than the "fine air and water" which nourished their sane bodies; fair seed of the future of the world's favourite seat of Art, song, and beauty.

The true Pescaglia was in the opposite ravine. Ours was merely a rustic suburb. Like all the villages of Italy, Pescaglia was a miniature city, with rows of stone houses with balconies facing each other in extremely narrow streets paved in the ancient Etruscan manner; possessing a public palace, the home of the syndic, and an army of *impiegati* in salaries of less than a franc a day; also a tiny church begun when Christianity was in its infancy, and, over all, a beeting Acropolis in ruins. Shop, there was none; merely a mongrel *café*, close and dark as a convict's cell, where tobacco, stamps, salt, coarse bread, and, it was reported, *gazosa* might sometimes be found. A tailor who plied his needle in the open air under a vine was the only evidence of a trade. In less unbelieving times there existed several convents, but so small they seemed more like play-convents than real ones. One, about the size of a ship's cabin, still sheltered a few disconsolate nuns, left in their dismal, dingy cells, because they had cried so hysterically when the government officials had told them they were free to go wherever they liked. Little had they seen of the outside world from their iron-bared loop-holes, except a few

trees and patches of sun-scorched rocks high in the horizon. What wonder then that they clung as closely to their dens as the tree-slug does to its hole when he hears the wood-pecker's ominous tap. One ventured to call on us escorted by several relations. The interview began and ended, on the part of the suppressed nun, in a speechless prolonged stare of amazement so persistent that my wife was put to her wits' ends to devise a stratagem to break the situation. Pale, sickly face, empty soul, cramped mind, a feebly shaded growth of good-for-nothing goodness, a being as helpless and timid as a silver-fish in a dry globe; this was the result of complete isolation from mankind to save her soul.

Pescaglia had its theatre; a low dank stone shed, with a few benches and a rude stage, where *Orestes* was given by the village amateurs in a heroic vein. Alfieri was succeeded by Voltaire's *Zaire*; high game both in this unimaginative century. It was a misfortune that each spectator, at four cents a head, knew every weak spot in the actor's costumes and rant; so that the tragedy at times threatened to lapse into broad farce. Finally the poetical overcame the prose elements, and there was a hearty appreciation of the motives of the plays. But for me, the best acting was that of the troops of young virgins, as comely, fair, and strong of limb as the biblical Ruth, every sunset trooping down the steep pathway to fill their copper vessels at a cool fountain in a near glen, and then, poising the heavy vases on their heads, walk up the hill with the mien and gait of as many Junos; never failing to give me a smiling greeting, as I sat in the recess of an archway to a shrine, watching them and overlooking the magnificent prospect forty miles away beyond luxuriant Pescia. What flexible, elastic, rounded frames, with plenty of good brain to top them. Good stuff there for healthy mothers and apt minds; not enfeebled by one-sided culture as too many girls are in New England, with muscleless bodies starved on pastries and vile candies, or shrivelled by fiery furnaces. These Pescaglians were of the flashing eye and ready tongue; no fools they, or fool's prey either. How independent, too, they are of us. For do they not grow and spin their own linen; raise the sheep whose wool they weave into winter's clothing; cut out their own wooden shoes and decorate them with gay colours and brass nails; while all the meat, grain, oil, wine, lumber, marbles, and even metals they require, are at hand in these motherly hills? Why should they covet our ingenious methods of making ourselves unnatural, discontented, and unhealthy?

Although Pescaglia has its army of free-thinkers and republicans who favour religion and politics not at all to the liking of the *codini* and Jesuits, yet they all cordially unite in keeping up the old fêtes of the Roman Church as handed down from its times of absolute power. Every town in Italy has its patron in heaven, charged with its spiritual and material welfare, the duties of which unite in him the functions somewhat of a pagan divinity and a diplomatic agent to a foreign court of the first class. To be doubly sure, Pescaglia had chosen the two strongest saints in the calendar, Peter and Paul, for her guardians. In their honour an annual festival had been instituted, of a very mixed character. Its celebration began in the church, by adoring the saints with rites which any genuine pagan God might covet, ending in a triumphant procession of the clergy in fullest ecclesiastical uniform, following files of youthful virgins clad in spotless white, wreaths of flowers on their heads, bearing candles and chanting hymns as they passed along the streets carpeted with fragrant leaves, amid the vineyards, to the roadside shrine of the Madonna del Carmine, which formed a sort of spiritual outpost to the place, kept in a condition of repair that contrasted sensibly with the picturesque decay of the worldly citadel above.

And such stillness! In this light air the faintest motion of a leaf seems audible. Some stillness makes the senses gasp, as if the breath of life were leaving them. There is a solitude too that irritates. Nature wages an occult war on our nerves, exhausting their vitality and intensifying their sensitiveness to incipient madness. She puts us under a receiver

and amuses herself with our antics in the exhausted air. But the quiet of Pescaglia is a balm to the spirit; its solitude delicious and companionable; for the atmosphere is charged with delicate harmonies, and to gaze into the speechless night was listening to celestial melodies. Even the hot amber sunlight lulled the body into a gentle repose, at peace with itself and all else. In abandoning ourselves to these influences we grew superior to ourselves. One felt how it was that the Olympian gods were finer than men. They breathed an atmosphere free from human sighs, groans, rivalry, and hate. Pure air and water insensibly make pure minds, with a little help from honest hearts. How long before the solitude would have turned to weariness of self and nature we did not stay to test. It was breathable bliss while we did stay. There was no overstrain of our welcome on either side. Whooping-coughs, lung fever, and moral and social miasma of all degrees of harassment were totally exorcised. One day there came news of some fine ladies from the baths of Lucca who were seen riding on donkeys at a village fair eight miles off. The report fell on our ears as if it concerned beings in another planet. It was a luxury to be out of "society." Even the distant rumour of it shook me like an ague-turn. It was "good" to be alone, for we were on ground consecrated like that of Sinai by a mighty presence. Pursuers of fashionable happiness had not yet disturbed its serenity. To the last moment an exhilarating satisfaction of attained rest and health was felt. Instead of fading away on re-entering active life, the impressions gained at Pescaglia have settled firmly into the memory, as one of those rare experiences which ever after haunt the imagination more like a dream than a reality, but whose beneficent effects are indelible in the system.

JAMES JACKSON JARVES.

Boston, U.S., August, 1871.

SELECTED PICTURES.

FROM THE PICTURE IN THE COLLECTION
OF JOSHUA SATTERFIELD, ESQ.,
ALDERLEY EDGE.

THE HINDOO MAIDEN.

H. Le Jeune, A.R.A., Painter. D. Devachez, Engraver.

THERE is a pretty yet fanciful sentiment in the practice of the young Eastern girls who test the fate of their absent loved ones by launching a lighted lamp on the bosom of the Ganges and other rivers of their country. Moore alludes to it in his "Lalla Rookh,"—that part of the poem which tells the story of the "Veiled Prophet of Khorasan,"—where the Princess, on her journey from Delhi to Cashmere to meet her affianced lover, first witnesses the ceremony.

Mr. Le Jeune has here placed the maiden in a spot that presents all the appearance of a dreary solitude; no sign of human habitation is visible, and even vegetation is sparse, while the rocky banks of the river look dark and desolate against the twilight of the sky. Kneeling down in an easy and rather elegant attitude, the girl earnestly watches her tiny lamp still burning brightly as it passes down with the stream, throwing a radiance on its surface, and auguring favourably for a successful voyage. Above her is a brilliant star, indicative of hope, which also casts its reflection on the river from the horizon to the foreground, as foreshadowing the course that her own missive seems disposed to take,—to the peace and joy of the sender. The head of the figure is finely modelled, though the mass of hair causes it to look somewhat large in proportion to her body: the face would be called beautiful, were it not for the anxious expression pervading it; this, however, is a merit, for without such the point of the story would be lost.





BRITISH ARTISTS: THEIR STYLE AND CHARACTER.

WITH ENGRAVED ILLUSTRATIONS.

No. CI.—JOHN FAED, R.S.A.



Y priority of birth this artist might claim precedence, in these biographical sketches, over his younger brother, Mr. Thomas Faed, R.A., of whom a notice appeared in our number for January last. We pay, however, no respect in our arrangements to chronological order, but simply introduce the names of all as we are best enabled to do, and with some view to variety; and thus it has happened that the elder brother appears in the numerical rank a little below the younger. Moreover, the latter is better known among us, from his much longer residence in London, than the other, who did not quit Scotland till within the last few years, had made there an excellent reputation before he came to London, and had been elected a member of the Royal Scottish Academy.

JOHN FAED was born, in 1820, at Burley Mill, Kirkcudbright. In the notice of his brother allusion was made to the early years of the two boys, of the strong feeling for Art evidenced in both, and the difficulties with which they had to contend in their attempts to develop it, in a locality altogether without any of those numerous advantages enjoyed by juvenile aspirants in large towns. We also spoke of the fraternal love which prompted the elder brother, when he had gained some

mastery over his art, to take the younger under the shadow of his wing, and help him onwards. This is a bright spot in the career of John Faed—one which, seeing what fruit it has brought forth, he must ever look back upon with heart-felt satisfaction.

In the midst of every discouragement, without proper tools of any kind, and, at first, unable to procure colours, he yet set his face steadily against being baffled by circumstances, and before he had seen more than ten summers he had formed the ambitious design of executing a large picture. To accomplish this object he was compelled to prepare stretching-canvas, frame, and almost every other article essential for carrying out the work. His courage, however, did not fail him, and he actually did execute a picture of considerable dimensions, representing 'Abraham offering up Isaac.' Our curiosity, at least, would be gratified by seeing how such a subject was treated, on canvas, by a boy who had not yet entered into his teens. Whatever the merits or the demerits of the work may have been, it had the effect of quickening the impulses of the youthful artist, who, perhaps finding he had begun at the wrong end; or, more probably, concluding that he might employ his talents more profitably, turned from sacred history to miniatures, and commenced, at the early age of twelve, to perambulate the villages of Galloway as a miniature-painter: this he continued to do for a considerable time, and with gradually increasing success, till he was about twenty-one years of age; when, feeling desirous of pursuing his profession to the best advantage and in a more prominent sphere of action, he quitted his native locality, and went to Edinburgh, where his talents soon brought him into notice. Irksome as miniature painting—beautiful as the art—was found to be, he adhered to its practice for several years, as a means of securing an income for the younger members of his family, especially for his brothers Thomas and James, who then resided with him. As soon, however, as these had become in a great degree independent of his brotherly care and solicitude, he determined to emancipate himself from what



Drawn by W. J. Allen.]

THE CID.

[Engraved by Butterworth and Heath.]

had hitherto been a tolerably lucrative, though most distasteful, practice, for one more congenial, yet of doubtful prospect.

In 1850, Mr. Faed, whose merits as a miniature-painter had already been recognised by his election as Associate into the Royal Scottish Academy, exhibited three *genre* subjects in the gallery of that institution: one of these, 'Boyhood,'—two young urchins who have been fighting, are separated by an old man—

was noticed in our Journal at the time as evidencing much power. The whole three found, we believe, purchasers. In the next year's exhibition, a picture suggested by an old Scottish ballad, "The Cruel Sisters," brought him yet more favourably before the public; from that date his success in his newly-adopted line of Art was secured. An additional impetus was also given to his labours by his election as a member of the Scottish Academy. An extract from our

report of the Scottish Exhibition of 1852 thus refers to his contributions:—"J. Faed, R.S.A., has two works, being subjects from Shakspeare, 'Olivia and Viola,' and 'Rosalind, Celia, and Orlando.' They are of extraordinary finish; may, indeed, vie in this respect with the pictures of Mieris. We know of no artist in modern times who exhibits more extraordinary manipulative power. Every square inch seems a work of time and labour; yet there is by no means a deficiency of harmony over the whole."

Again, and with reference to Mr. Faed's 'Cottar's Saturday Night,' we spoke of it as "perhaps the most carefully-finished picture in the exhibition" (of 1854, in Edinburgh). "The living groups, however, are not of the 'cottar' class, but of a higher social grade. When this is stated, our whole stock of objection is exhausted; for the figures are faultless in drawing, very agreeably grouped, and beautifully coloured. The orthodox canon for the completion of such a work has been strictly adopted by the artist, in his having introduced a handsomely-dressed female, 'Jenny,' as a prominent feature in the composition. The grace

of attitude, the sweetness of expression, the rendering of the accessory—the 'braw new gown'—which she displays, the lustre and purity of colour, and the delicate and elaborate finish of the whole—these things were never excelled, except, perhaps, in the highest characterized works of the Flemish school."

In 1855 Mr. Faed exhibited three pictures in the same gallery—'Reason and Faith,' an allegorical subject represented by a pair of figures—Reason, a fair, bright-eyed youth, leading along a blind girl, his twin-sister, Faith; 'The Philosopher;' and 'Newton searching after the Principles of Light:' all are distinguished by beauty of colour and most careful finish. The same may be said of several contributed in the following year; the principal being 'The Raid of Ruthven—an outrage offered to James II., of Scotland, by the Master of Glamis,' and 'The Household Gods in Danger,' a smaller canvas representing a child curiously examining some valuable specimens of china. Lest our space should be so occupied as to leave no room for comment on later works, we must pass over some of the artist's



Drawn by W. J. Allen.]

THE STIRRUP-CUP.

[Engraved by Butterworth and Heath.

pictures of this period by simply naming them; for example, 'The Scottish Justiciary,' 'Alice Lee,' and 'Job and his Friends,' exhibited in 1857; three subjects from Burns's "The Soldier's Return"—a moiety of six pictures painted and engraved for the 'Association for the Promotion of the Fine Arts in Scotland—exhibited in 1858; 'Job and his Friends,' and 'A Bedouin Arab exchanging a Young Slave for Armour,' exhibited in the following year—Mr. Faed never, perhaps, painted a more beautiful work than this last,—and 'Boaz and Ruth,' in 1860. To these must be added, 'Queen Margaret refusing to give up the Keys of Edinburgh Castle to the Rebels' (1860); 'Pastimes in Times Past' (1861); 'The Old English Gentleman of the Olden Time' (1862).

In this last year Mr. John Faed came up to London, whither his younger brother, Thomas, had preceded him about twelve years. He was not unknown in the gallery of the Royal Academy; for in 1861 he exhibited there his pictures, 'Queen Margaret' and 'Pastimes;' and in the year of his arrival among us, contributed another of these Scottish works, 'The Old English Gentleman.'

In 1864 he sent 'Catherine Seyton'—her interview with the bashful Roland Græme, as described in Scott's "Abbot." The picture obtained well-merited eulogium at the time in our columns:—"Catherine Seyton' is one of the best-painted pictures in the entire exhibition, and certainly by far the most successful work we have yet seen from the easel of J. Faed. The whole picture maintains a winning refinement, which is not broken through even by the explosive burst of Catherine's hearty laughter. The two figures are happily composed, not only in relation the one to the other, but also in regard to the size of the canvas to be filled, and yet are not crowded—vital points, in which an artist often fails from the want of a geometric eye for space and proportion. The painter, too, has justly balanced the figures against the accessories, giving to the human element its due preponderance over tables and chairs; and yet these appurtenances stand substantially upon the floor, and are executed with a precision and polish which might excite the admiration of a West-end cabinet-maker." Other pictures painted this year, but not exhibited at our Academy, were

'The Old Style,' 'Tam o'Shanter,' and 'Annie's Tryst'—the last is a charming little bit of Scottish life.

'Kinmont Willie a Prisoner,' suggested by a ballad in "Border Minstrelsy," exhibited at the Royal Academy in 1865, is an elaborately-painted work. To that year also belong Mr. Faed's 'Had-don Hall of Old,' and a 'Scene from *Cymbeline*,' neither of which we have had the opportunity of examining. His principal contribution to the Royal Academy in the following year was 'A Wap-penschaw.' In 1867 he exhibited three pictures—'Old Age,' 'The Ballad,' both of them showing much refinement of feeling and manipulative treatment, and 'THE STIRRUP-CUP,' this last forms one of our engraved examples. The picture is the property of Samuel Shaw, Esq., of Greenbank, near Halifax. The subject in itself calls for no special description, but it is brought forward in a most agreeable manner, is effectively composed, and the colouring is rich and harmonious. Its owner may congratulate himself upon possessing an excellent specimen of this artist's work. His contribution to the Academy in 1868 was only one

small canvas, 'The Auld Crockery Man;' of sufficient merit to win for itself a place "on the line" of the room where it hung.

Referring to our catalogue of the Academy Exhibition of 1869, we find notes of unquestionable approval made against Mr. Faed's picture, 'The Parting of Evangeline and Gabriel;' but his second work, 'John Anderson my Jo,' was, undoubtedly, the more universal favourite. "There is scarcely a more popular picture in the Academy," was the remark made upon it in our pages, than this. "People, as they stand around this humble scene of domestic felicity, hardly know which most to admire, the good old couple seated by the fire, or the tea-pot and tea-cups standing on the table. We have heard preference given to the latter; but really, on every ground, this cottage-story merits the admiration it receives. It is carefully and evenly painted throughout, and possesses the best qualities we are accustomed to look for in the Scotch national school of Wilkie."

'AULD MARE MAGGIE,' another of our illustrations of this



Drawn by W. J. Allen.]

"AULD MARE MAGGIE,"

[Engraved by Butterworth and Heath.

artist's works, was in the Academy Exhibition of last year. The subject is suggested by one of Burns's ballads:—

"A gude new year I wish thee, Maggie."

What a kindly look the old farmer bestows on the faithful animal which has journeyed many a weary mile with him and his wife to market and back, through a long course of years, and is regarded, doubtless, as one of the family! There is much capital painting in this most pleasant picture, concerning which we may remark that at the sale of the collection of Mr. Brooks—who courteously permitted us to engrave it—in April last, it realised the large sum of 750 guineas: the canvas is of considerable dimensions. Mr. Faed's only other picture of the year was 'The Gamekeeper's Daughter.'

In the present year he exhibited nothing in the Academy, being unable to complete in time a large picture on which he had long been engaged, 'The Statute Fair.' We had, however, an opportunity of seeing it, when finished, at Mr. Brooks's gallery in Pall

Mall, and gave a report of it in our number for the month of June. Taking it as a whole, it is undoubtedly the most important work the painter has ever produced.

One of our engravings, 'THE CID,' is from a picture in the possession of George Fox, Esq., Harefield, Alderley, which, we believe, was never publicly exhibited. It represents an assumed incident in Spanish history that speaks of the body of the famous Castilian hero, known as "The Cid," being taken from its tomb, clad in the armour he was accustomed to wear, mounted on a charger, and led into battle, in order to strike terror into the hearts of the Moors, whom, when living, he so often defeated. The composition is very spirited.

There are many other pictures by Mr. Faed—especially some exhibited in Edinburgh of late years—of which we could speak, did space allow; but it is exhausted. Still, we trust enough has been said to direct the attention of our readers to one who deservedly ranks among the best British painters of *genre* subjects.

JAMES DAFFORNE.

GAINSBOROUGH AND HIS 'BLUE BOY.'

"If ever this nation should produce genius sufficient to acquire to us the honourable distinction of an English school, the name of Gainsborough will be transmitted to posterity in the history of Art among the very first of that rising name."

So said Sir Joshua Reynolds, in his "Fourteenth Discourse," and subsequent critics have cordially endorsed that opinion. Mr. Ruskin, in "Modern Painters," says—"Gainsborough's power of colour (it is mentioned by Sir Joshua as his peculiar gift) is capable of taking rank beside that of Rubens. He is the purest colourist—Sir Joshua himself not excepted—of the whole English school; with him, in fact, the Art of painting did in great part die, and exists not now in Europe. In management and quality of single and particular tint, in the purely-technical part of painting, Turner is a child to Gainsborough."

But Gainsborough's beautiful landscapes were not appreciated as they deserved while he lived. Sir William Beechey tells us that his landscapes stood ranged in long lines from his hall to his painting-room, and they who came to sit for their portraits rarely deigned to honour them with a look as they passed. Gainsborough studied Wynants and Ruysdael, and made Snyders his model for animals. He only painted four sea-pieces, yet it does not seem from any want of ability; for Walpole says:—"In the Exhibition of 1781 he had two pieces of land and sea, so free and natural, that one steps back for fear of being splashed."

Five years after Gainsborough came to London, and rented part of Schomberg House in Pall Mall at £300 a year,—that is, in 1779, when fifty-two years of age,—he is said to have painted Mr. Buttall's son 'The Blue Boy.' In his "Eighth Discourse," delivered December, 1778, Sir Joshua says:—"It ought, in my opinion, to be indispensably observed that the masses of light in a picture be always of a warm mellow colour—yellow red or a yellowish white; and that the blue, the grey, or the green colours be kept almost entirely out of these masses, and be used only to support and set off these warm colours; and for this purpose a small proportion of cold colours will be sufficient." Gainsborough, to refute this, painted Master Buttall in a blue dress, producing, Dr. Waagen thinks, "a harmonious and pleasing effect." At least, this is the hitherto generally received opinion; but facts which we shall presently mention render it probable that the 'Blue Boy,' or, at any rate, one 'Blue Boy,' was painted before the delivery of the "cold-colour" discourse. The facts we shall bring forward are carefully selected from a series of papers contributed to *Notes and Queries*, by Mr. J. Sewell, Assoc. Inst. C.E. First let us see what is to be said for the 'Blue Boy' in the possession of the Marquis of Westminster, exhibited at the first Exhibition of Works of Old Masters at Burlington House—size, 5 feet 10 inches, by 4 feet. It is believed to have been bought by the first Earl Grosvenor a short time before his death in 1802. It was one of twelve paintings by Gainsborough exhibited at the British Institution in 1815. It again appeared at the Exhibition of Art-Treasures at Manchester. Those who consider this the original, rely chiefly on the fact that critics have accepted it as genuine, and that at the British Institution, in 1815, many who saw it were well acquainted with the artist's works. Cunningham and Mrs. Jameson both say that this picture passed from the hands of Hoppner, the fashionable portrait-painter, to that of Earl Grosvenor; but Mr. R. Gale, of Holborn, the picture-dealer, remembers that, about thirty years ago, it was a current trade-anecdote that this picture was seized, among other effects, for rent, and sold for a sovereign at Bingham's auction room, in Leicester Square, and purchased for the Grosvenor Gallery after it had passed through the hands of several dealers. Mr. Gale says it was also believed by the trade that the picture was more than once restored by those through whose hands it passed. This statement seems pro-

bable; for, at the *Conversazione* of the Institute of Civil Engineers in 1867, when the rival 'Blue Boy' was exhibited, the sketch of the Westminster 'Blue Boy' was shown by Lord R. Grosvenor, and that nobleman was understood to say that the Westminster 'Blue Boy' was bought from a dealer and not from an artist. This overthrows, therefore, the statement which has been copied over and over again respecting Earl Grosvenor's purchase from Hoppner. It may be mentioned that the Rev. J. S. Trimmer (a descendant of Gainsborough's friend, Sir J. Kirby), and Mr. Gainsborough Dupont (the descendant of the artist's nephew and pupil), men well qualified to judge, think it possible that Gainsborough may have painted both pictures. It is also possible that a spoilt first painting may have been given to Master Buttall, afterwards to become the Westminster 'Blue Boy.'

There seems to be a probability amounting almost to a certainty, that the 'Blue Boy' was painted by Gainsborough, at Bath, in 1769, and is the portrait in a Vandyke dress so admired in the Royal Academy Exhibition in 1770. This is the statement of Mr. Joseph Hogarth, of Mount Street, Grosvenor Square. Mr. Sewell points out that this adds weight to the tradition said to have been believed by Turner, R.A.,—that the boy was not young Buttall, but represented a youth connected with the Molyneux (now the Sefton) family; for Gainsborough exhibited the portrait of Lady Molyneux the previous year, and it may have been one of her two brothers, Viscount Petersham, then sixteen, and Henry Fitzroy Stanhope. The boy certainly does not look like an ironmonger's son, as Mr. Buttall, sen., was, living in Greek Street.

At the last Winter Exhibition of the Royal Academy a very fine Gainsborough (recently valued for legacy duty at £1,500) was exhibited. It (102) contains portraits of the Countess of Sussex and her daughter, Lady Barbara Yelverton, afterwards Baroness de Ruthyn. This very picture was exhibited at the Royal Academy in 1771, the year after Gainsborough had exhibited the 'Blue Boy;' and Mr. Sewell says it is a companion to the least-known 'Blue Boy;' "in the description of canvas used, in the very thin but brilliant water-colour-like style of painting so characteristic of Gainsborough's portraits painted at Bath, and even in their ground-plan the pictures differing little more than necessary from the positions and dresses of those represented." Tried by this test the Grosvenor 'Blue Boy,' he says, "fails; the canvas is different, the vehicle different, the painting thicker, the colouring less delicately managed, and the general effect disappointing."

The two 'Blue Boys' in question differ so much in colour, that they might be distinguished by the titles *Light* and *Dark* Blue; the former applies to the Westminster portrait, the latter to the least-known picture. Now for the history of the latter, so ably traced by Mr. Sewell. The vicissitudes the Westminster 'Blue Boy' passed through, according to Mr. Gale and others, render it almost certain that it cannot have been in the possession of those who are known to have had a 'Blue Boy' at certain periods. The original is believed to have been purchased from Gainsborough by the Prince of Wales, afterwards George IV.; for Mr. Trimmer, in Thornbury's "Life of Turner," states that Mr. John Nesbitt, M.P., purchased the picture of the Prince for £300. The Prince was a great patron of Gainsborough, and it was about the hanging of the portraits of the Princess Royal and the Princesses Augusta and Elizabeth, painted on commission for the Prince, that the artist quarrelled with the Royal Academy. Gainsborough very rarely marked or dated his works. But it is a curious fact, that in the least-known 'Blue Boy,' "most unobtrusively placed on the right corner of the canvas, where it was practically, if not really, hidden by the frame, there are the remains of the impression of a small seal or mark, to all appearance as old as the picture, and of the same material and colour as the foreground." The general outline is that of the royal shield, without a motto, used for marking royal property. This seems to be a confirmation of its having been in the Prince's collection. Nesbitt probably bought the picture

between 1795 and 1802 of the Prince; but, at the latter date, Nesbitt's affairs were in such a state, that a six days' sale of his effects took place. Many of the pictures were bought in, and were afterwards removed to Nesbitt's seat at Heston, where we know the 'Blue Boy' (bought in at the sale for 65 gs.) was in 1815. There is every probability that Hoppner took care of the picture for Nesbitt until it was removed to Heston, as Nesbitt's affairs were a long time being settled. Fortunately, one of the Heston household in 1815 still survives, aged 82, and she expressed her willingness, having well remembered the picture, to go to London and see it. She instantly recognised the Dark 'Blue Boy.' She says, the 'Blue Boy' "was a great favourite amongst us in the house, for the nice boy seemed always looking at us, no matter what part of the room we were in. I remember the 'Blue Boy' coming to Mr. Nesbitt's soon after he came to Heston, and I would not say anything about Mr. Nesbitt and his household I did not know to be true. The 'Blue Boy' came then carefully packed in a large case or crate, and was hung opposite the fire-place in the parlour in the house now called 'The Hall,' and the property of Mr. Hogarth the magistrate. Along with my grandson I saw the 'Blue Boy' at No. 1, Stephen's Square, Bayswater, on Thursday last, March 9th, 1871, and I am confident it is the same picture which hung in Mr. Nesbitt's house at Heston, but it is now in a broader frame than it was at Heston." The picture was sold in 1820, when Mr. Nesbitt left Heston. It was bought by Mr. W. Hall, then an auctioneer, who died July 12, 1852. His son died four years after; and in March, 1858, Hall's effects were sold under an Order of the Court of Chancery. The Dark 'Blue Boy' was sold as 'A Portrait of the Prince of Wales' to Mr. Dawson, who changed the frame as detected by the housekeeper. Dawson offered it to the late Marquis of Westminster for £1,500 (the price Mr. Hall considered it worth), but it was afterwards sold to its present owner. Mr. Sewell concludes that the Westminster (or Pale) 'Blue Boy' was unknown and unheard of during Gainsborough's lifetime, and for many years after his death. It could not have been Nesbitt's picture, as the important evidence quoted proves he had his picture with him at Heston. Now as to the opinions of those who have examined the Dark 'Blue Boy,' Mr. R. J. Lane, the great nephew of Gainsborough, says,—

"I have carefully examined the picture. The figure is more elegant than the Grosvenor picture—the character of the face far more pleasing; the minutest touch of the subordinate parts probably Gainsborough's. The comparative smoothness of the painting of the face might suggest the hand of Dupont, his nephew, who worked for him, but would not interfere with the integrity of the work as Gainsborough's."

Fulcher, in his "Life of Gainsborough," says that Mr. C. Ford, of Bath, has the original sketch in oil; but that gentleman states the work he has is an unfinished study of a Bluecoat Schoolboy; and this Mr. Fulcher saw, mistaking it for the 'Blue-Boy.'

The naval, or dark, 'Blue-Boy,' is described by Mr. Sewell thus—"The portrait is that of a good-looking youth, standing with cap in hand in front of a darkly-painted landscape, through the foliage of which the light is shown at intervals in Gainsborough's best manner. The attitude is excellent, and the face so life-like that it appears as if turned on the spectator to listen to something addressed to the boy, and he was thinking what to say in reply. With the exceptions of the flesh tints the whole of the Vandyke costume is painted on different shades of blue colour."

There is a third 'Blue Boy' in the possession of Mr. Riddell Carre, of Cavers Carre. It is, he says (*Notes and Queries*, July 10, 1869) a picture of his father-in-law, painted by Gainsborough, about 1770, when the boy was about seven or eight years old. He is represented in a surcoat, long waistcoat, and breeches, all blue, with collar, lace frill, and ruffles, and white silk stockings, shoes, and buckles. The boy is represented plucking a flower with his right hand and holds another in his left. The picture has no name or date on it. Size, 3 ft. 3 in., by 3 ft. 4 in.

INTERNATIONAL EXHIBITION.
PICTURES OF VARIOUS NATIONS.

IN this notice are considered the works of different schools, examples of which are sufficiently numerous and important to require an exclusive review. We have seen enough of continental Art to know that several even of the leading nationalities are not fully represented; yet it cannot be said that the great majority of the works exhibited are not of the marketable class. Indeed, pictures which contain the pith and essence of a school are not always the most saleable. From this great aggregation there is much to be learnt; the student is not wearied by one never-ending formula of Art; but can at once determine the degree of cultivation, and the direction of taste, in this or that country; whether the people have access to pictures, and what kind of pictures; or see little beyond the nature around them. The selections noted in this paper are those of Italy, Prussia and other states of Germany, Austria, Hungary, Denmark, Sweden, Norway, &c.; and it would be more than surprising if, under the pressing conditions of the occasion, productions of the highest kind were numerous. The most remarkable advance in certain schools is observable in landscape-painting; but yet more striking than this, is the fact that the gentle influences of Art have a voice even in the uttermost north, from within even a few degrees of the Arctic circle. Since our former notices, many additions have been made to the collections, and in a manner greatly to embarrass the inquisitive visitor, but this perhaps is inevitable according to existing arrangements. What we mean is, for instance, that after looking at No. 992, we must walk, the distance may be a quarter of a mile, to see No. 994. The difficulty is not so great generally, but in many instances the search for the vagrant numbers is all but hopeless. This, however, will doubtlessly be remedied in future years.

Surprise is continually expressed that painters should adopt subjects entirely uninteresting, and from sources comparatively obscure, when there is at hand in historical and biographical narrative, so much striking incident that is still new to the canvas.

Thus from ITALY we have (1,094), by C. MACCARI, a picture of rare merit entitled, 'Sira sacrifices her Life for the Mistress Fabiola,' (*sic*) from a narrative by Cardinal Wiseman. The artist has exhausted in his work all available ideas and hints, for careful study and astute reasoning appear in every passage. The figures are two women, one lies dead on a couch; the other laments the catastrophe. It is a composition of great power, and the result of an amount of elaboration that had been enough for three pictures. More pointed and legible than the above is another large picture (1,053) by R. TANCREDI, of which the subject is 'Buoso da Dura,' the betrayer of Manfred, King of Naples, now returned a beggar to his native country. The wretch sits crouching in the corner of the vestibule of some public building, the object of the threats and scorn of his countrymen. The situations may be called fairly original, and the narrative is lucid and forcible. The attractions of this work, which is of high character, lie in a direction different from those of the preceding. By the same hand is a second work, small (1,052), called 'The Ransom,' containing numerous small figures, a troop of robbers of course, and the inevitable bearer of the bag of gold. It

is not easy on mechanical evidence to assign these two works to the same painter.

Occupying the centre of the Italian side is a large military subject (1,028), 'The Death of Cajroli,' an incident of the battle of Varese. This large picture was painted by C. AMEDOLLO in 1862, and was described at length in our columns some years ago. 'The Entombment' (1,043), A CISERI, is the only sacred subject among the Italian works. The figures are of the size of life and represent the three Marys, Joseph of Arimathea, St. Peter, and St. John. It is not founded on the common idea of the assemblage round the open sepulchre, but refers more immediately to the deposition, and the procession from Calvary. The impersonations are all acceptable save that of the mother of the Saviour, and she, both in form and expression, is vulgarised. There is admirable quality throughout the picture; it would tell very effectively as a bas-relief. In 'Le Castellane, ed il Menestrello' (1,050), M. RAPISARDI, we find a young and interesting minstrel the object evidently of the tender regards of a group of high-born damsels. The situation is, according to the romantic vein, the very essence of the romance of the Italian poets, but it is felt instantly that there is something weak in this report of the incident. To use a common phrase, it is not equal in its development, the draperies are poor and want decision in their markings, otherwise there is somewhat in the picture to commend; the expression, for instance, of some of the ladies communicates to us at once their inward thoughts. On the other hand, in 'Parade Day' (1,095), M. BIANCHI, the subject is a theme of hopeless speculation, as presenting three or four girls who are just completing their equipment in festal attire, in the presence of a person very like a beadle. The manner is hap-hazard and coarse beyond what is commonly found in Italian Art, and the absence of a key to the incident is a serious defect.

As may be expected the classic and poetic element is conspicuously represented. There is a 'Sappho' (1,033), A. BACCANI, of the size of life, a character as difficult of realisation as any in the whole circle of poetry or mythology. She sits in the shade of trees, holding a lyre and crowned with laurel, a decoration questionable at least. To us the features look like a suggestion not so much from a Greek, as from a Roman head; but when we think of Sappho we cannot regard them otherwise than severely prosaic. If she was not good she was at least beautiful, and from what we know of her, it may be said that few painters even in the course of a long lifetime, have seen a living head that with necessarily skilful treatment could be accepted as representing Sappho. Also by Signor Baccani, is 'A Grecian Idyl' (1,034), a small picture of two nymphs, one extended at length on a panther's skin, the other seated behind her playing two *tibiae*. This picture has evidently cost the artist much labour, but his purpose should have been drawing and definition, not a *pseudo*-breadth which imparts to the figure the appearance of all drawing having been washed out. By this artist is also an admirable portrait of Lady Mary Fox (1,033). In the 'Nourmahal' (1,099) of B. AMICONI, there is something more loose and voluptuous than should be presented in a picture. 'A Woman of Albano and her Infant' (1,048), G. MÜLLER, will be recognised as a suggestion from one of those Madonnas, of which there are several publicly known, wherein the child is made to stand up. It is no detriment to the work that it suggests

comparison with a famous picture, since it is done creditably; there is, however, another mother and child by the same painter 'The Impatient Baby' (1,047), an Italian peasant-woman with her child swaddled into that hideous form so common on the continent. The mother is a charming study, she is seated in shade, the effect of which is so complete as to exclude all available suggestion. The features are extremely sweet in expression, and the dress is the every-day household attire, without any affectation of holiday finery. In 'La Bella Giardiniera' (1,044), M. GORDEGANI, the lady, a life-size figure, is shut in by a background of laurel bushes. The treatment is too large for such a subject. As a well-matured study a crushing contrast to this, and some others bearing marked evidences of easy-going execution, is offered by a picture (1,093), C. MACCARI, called 'Recollections of the Past,' in which appears a lady, we think it is, playing a guitar; but the sex matters little, for we are looking only at the æsthetic quality of the Art. The style of the figure is pronouncedly Venetian, greatly assisted by its dark and mysterious appointments; but—and here is the injustice the painter does himself and his work—it is by no means clear how the title applies.

There are among the Italian pictures a few landscapes, in which are more freshness and nature than prevail in some other schools. The name of CASTELLI prepares us always for something far beyond the mere circulating medium of the Italian school; thus 'A Landscape' (1,039), a piece of wooded scenery, by its elegant composition entirely gratifies the eye. There is no imitation of Claude, but there is a co-incidence of sentiment with him. The trees are graceful in form, are painted with a free and generous, but decided touch, and the painter has ventured to give them the colour of nature. There is, moreover, a story about a party of nymphs, who seem to have emptied and overturned in their glee several large *amphoræ*, and overcome with wine, are now sleeping on the grass, where they have been discovered by a party of Satyrs who are moving stealthily towards them. Again by Signor Castelli, is 'Near Porto D'Anzio' (1,040), a production with a very different motive, as affording a view of a section of the coast. In the dispositions are the same completeness and evidence of masterly tact that prevail in the foregoing work, and the near and middle distances acquire picturesque interest from being so judiciously broken. We are in a grove of pines; the ear is importuned by the endless grating of countless *cadace*, and we feel the evening air yet hot with the breath of noontide. But above all we are made sensible of how deeply the eye becomes saturated with the blazing effulgence shed from southern skies. The picture might be pronounced too hot, the water even looks warm and steaming, but it is not so. On the other hand we are accused of painting Italy and Egypt much too grey, but that is really as we see it, our eyes can reconcile themselves to nothing, save through the mysterious greys of the north. There are other works which announce themselves as transcripts direct from nature, as 'The Arno, near Florence' (1,036), E. C. BORGIA, 'Lake of Silva Plana, in Upper Engadina' (1,042), C. CAVALIE, 'Valleys in Upper Italy' (1,041), by the same &c.

It was not to be expected that PRUSSIA could be adequately represented by recent works. Considering her strength in Art, her schools might have been more worthy

celebrated by a selection of pictures dating prior to the recent convulsions, than by a contribution generally small in number and comparatively unimportant in purpose, of which the landscapes are the better part, though they ought not to be so, because it is not in this direction that Prussia excels. For instance, a small 'Virgin and Child,' by Professor ITTENBACH (1,068), embodies a sentiment which the German schools have cultivated with much success. There is no version of this subject that does not recall some other reading which has preceded it. It may, therefore, be said that this will suggest the famous Dresden Madonna by Raffaele, or certain of the very sweet Nuremberg figures. The group is relieved by a gilt background, and is apparently a study for a large picture. No. 1,065, called 'Confession,' O. ERDMANN, affords another instance of what we have so frequently complained in the course of our notice—that is, the want of relation between the title and the picture. We find here two persons, a lady and a gentleman, richly dressed in the costume of the last century. Both are seated, and the lady addresses the other in a deprecatory manner; but there is nothing to signify that she is making a confession—nothing to point out the relation between the parties, nor any suggestion or evidence of fault on the part of the lady. The drawing is correct and the painting masterly. 'The Last Days of Pompeii' (1,080), R. RISSE, is, as may be supposed, a scene from Lord Lytton's novel, where two of the principal characters, with the blind girl, are grouped in a boat at such a distance from the shore as shows Vesuvius and the contiguous line of coast. The purpose of the painter seems to have been to prefigure the fate of the city according to the description of the premonitory indications, rather than truly to define the characters. Thus much care has been bestowed on rendering accurately the burning mountain and the face of the shore line. The ominous cloud hangs over Vesuvius and shades the neighbouring heights. 'The Lake of Murg, Switzerland' (1,086) R. SCHULTZE, is a small piece of water, clear and evidently deep, dominated by rugged crags broken and looking as if subject to continual disruption; and this kind of close mountain-scenery is that which seems to be much affected by the German landscape-painters as being consonant with the gnome and legendary lore of the country. Of this spirit also are a 'View of Toedy, Switzerland' (1,087), by the same artist; 'Mount Pilatus' (1,084), E. SCHÖNFELD; 'Scenery among the Hartz Mountains' (1,075), C. LUDWIG; and 'Evening Twilight' (1,067), by J. HERMES. 'The Jungfrau,' (1,058), A. BECKER, is a scene of infinite grandeur, though the view is taken from a point which does not fittingly describe the height of the mountain, whose snowy slopes we here contemplate over a confused interval of rocks and rifts looking almost as recent in their wild confusion as if the upheaval to which they owed their chaotic displacement had been but of yesterday. It is a fine picture, but we must protest against the too palpable and easy means of disposing of a difficulty by dividing the subject into two parts so distinctly marked—one of dark, the other of light. By H. POHLE (1,079) is a 'Castle and Park, with Figures,' designed apparently rather as a piece of stage-ornament than for a picture. The spirit of the scene is a numerous company of ladies and gentlemen who have just risen from an open-air banquet. It is the only composition of its kind in the Prussian contribution, and presents much that is

clever; but as a composition it wants counterpoise, and this incompleteness is at once felt. By the well-known artist, LEU, there is a study (1,074) which pronounces itself at once as a piece of Norwegian scenery, consisting of a *fjord* intersecting a mountainous shore, and penetrating inland between lofty perpendicular cliffs. It is well worthy of the reputation of the painter; but the striking features of the best passages of these northern landscapes are so similar as to convey the impression that even diverse subjects are but different views of one, and the same, place. 'A Summer Day' (1,056), HERMINE VON RECK (Baden), is not, as may be supposed, a landscape, but a country girl seated on a bank—a study not only of very agreeable character, but showing much more command of the means of effect than is commonly seen. By C. F. DEIKER is a large picture called a 'Hunting Scene' (1,061), in which appears a stag making his last stand against the dogs. The canvas is elaborately overcrowded for any impressive result. 'The Holy Women at the Foot of the Cross' (1,054), L. DES COUDRES (Baden). This fine subject has been so frequently painted that it is impossible to avoid comparisons, which are not always favourable to the immediate version. The impersonations here are the three Marys, St. John, and Joseph of Arimathea. The characters are well defined.

From SAXE WEIMAR are a few landscapes of great force and substance. By STANISLAUS, Count of Kalkreuth, 'A Mountain Landscape—view of the Jungfrau' is a very successful transcript of scenery that places us in the presence of the vast mountain, the slopes of which are mantled with eternal snows. It is a magnificent rocky solitude, admirable in intention, but too evidently divided into a light and a dark, the latter consisting of black and opaque shades. Similar power of delineating rocky scenery is again shown by this artist in a 'Mountain Landscape from the Lake of Vierwaldstätt' (971). A very different class of subject from these is presented in 'On the Brook in the Thuringian Forest' (979), E. WEICHBERGER—a well-wooded glade traversed by a rapid rivulet, agreeably painted; and also from the Thuringian Forest, a curiosity in the shape of 'The Hut of a Charcoal-burner' (966), E. FREIESLEBEN. There are also valuable qualities in a 'Portrait of an Old Man' (967), P. C. GUSSOW; in the portraits by VERLAT (977 and 976); and in that by the COUNTESS OF KALKREUTH (970). The only seriously-studied figure-composition from Weimar is by F. PAUWELLS, and is called 'Pastimes for the Count de Buren at Antwerp under Philip II.' (973). This Count de Buren, who is scarcely yet a youth, appears with his attendants in a boat on the Scheldt. He stands at the stern steering, while his tutor behind him wishes to direct his attention to some distant object across the river. There are several figures in the agroupment, and all are carefully painted. A picture, marked as from Germany, is novel and striking in conception. It is by A. SCHREYER (1,115), and entitled 'Horses escaping from a Burning Stable.' The wild terror of the animals is very forcibly delineated. They are rushing in a body against the fence which confines them, and while we contemplate the dire confusion, the predominating feeling is the hope that they will break down the obstacle and escape.

In 'The Religious Colloquy at Marburg' (938), A. NOACK, of Hesse, the persons present at that famous controversy—A.D. 1529—are readily distinguishable. So much

pains has been taken with the portraiture, that the execution has become in some degree hard: Martin Luther is addressing the assembly. 'Gretchen in Prison' (1,055), J. GRUND (Baden), seems to have been worked out as an attempt to show with how little colour a picture can be painted. A denegation of colour in a theme of this kind is undoubtedly a propriety. The appliances are scarcely German enough for Margaret, but the figure can represent no other ideal.

Those catalogued as AUSTRIAN are few and comparatively unimportant, when we remember the many famous names whose incense issues from the studios of Vienna. A remarkable production is the story of Ibycus, called 'The Cranes of Ibycus' (1,109), H. SCHWEMMINGER. Ibycus was a poet of Rhegium who was murdered by two ruffians when on his way to a poetical contest. He called on some cranes to witness his murder, and the result was the execution of the assassins. The subject is remote, but the figures are accurately drawn and well painted, and the entire composition has much the appearance of an academical prize-essay. Other works are 'The Death of the Stag' (1,104), J. HOLZER; three well-painted studies of heads, by A. MAVER, all numbered 1,105; 'The Convent Garden' (1,111), HANSCH; and by the same artist 'Under the Linden Trees' (1,110), &c. Two painters named REIFFENSTEIN and REICH co-operate in two small pictures, 1,116 and 1,117 respectively, a 'Boy with a Dog,' and a 'Girl with a Cat,' the latter is one of the sweetest figure-pictures in the Exhibition.

The pictures from HUNGARY are, as may be expected, not numerous; and the half of the contribution has been made by one artist, by name ORSZAGH, whose works are all small and sketchy, and look as if they were essays preparatory to larger studies. In others there is more ambition and a higher range of thought than in these sketches; for instance, 'Cupid and Psyche' (1,006), T. K. LOTZ, is in its Art a production of such rare quality as to cause regret there should be anything to raise a doubt of the truth of the propositions. Psyche is here a woman, too old for our conceptions of her; the painter must have intended a nymph rather than a Psyche. In 'The Persecution of Christians' (1,009), J. MOLNAR, a large composition, there is much power and knowledge. The adoration of the officiating elder is solemn and affecting, but as a study of bright colour the drapery is not in harmony with the painful allusions of the scene. 'Coriolanus before Rome' (1,011), S. ORLAY, shows the Volscian leader just about to yield to the supplications of his wife and mother; it is a subject very difficult of treatment. Not less so is 'Dante and Beatrice' (1,024), M. THAN. In the two figures is much to admire, but all their sentiment and beauty are counteracted by heaviness and the absence of impressive grace. 'The Park of an Exiled Nobleman' (1,005), G. KELETI, is a work of great power and very pointed in description. It represents the ornamental home-grounds of a man of cultivated tastes, as we learn from a now broken statue of marble which has been the cynosure of the place. But now weeds are everywhere—flowers nowhere—and, worse than this, a herd of swine has been turned in to complete the desecration of this once cherished site. 'Kohlbach Valley' (1,000), is a rocky and picturesque piece of nature, to which ample justice has been done by the artist, A. BRODSZKY.

But the great work of the Hungarian contribution is 'The Union of Lublin, 1549' (940), J. MATEJKO—a large work full of figures, all remarkable for distinctness, individuality, and variety of character. It is not enough to say that it is masterly, it exhibits powers of the very first order. The works of Herr Matejko are not familiar to us, but it is easy to estimate his *status* from this grand picture, which, by the way, though inestimable as a work of Art, is little interesting to us as chronicling events that in nowise affect us.

The contributions from the most northern countries of Europe are not of course numerous, but they exhibit an efficiency highly creditable to the schools they represent. Among those of SWEDEN, 'The First Trip' (988), B. NORDENBERG, containing many well drawn and painted figures, represents a numerous rustic family busily preparing to start a young mother and her infant on some short expedition of pleasure or ceremony. Other notable figure-compositions are 'The New Scholar' (985), A. JERNBERG, and 'A Choir of Boys in a Country Church' (989), B. NORDENBERG,—an excellent picture. Of the more remarkable landscapes are, 'On the Shore of Lake Mälaken' (983), E. BERGH; 'Swedish Waterfall' (990), A. NORDGREN; 'A September Day—Recollection from Ulriksdahl, Vicinity of Stockholm' (944), A. WAHLBERG, and a coast scene, 'Fog at Sea' (987), A. KALLENBERG, both of which successfully describe remarkable phases of nature.

From DENMARK we have little. Madame JERICHAU contributes two pictures of great excellence, one is called 'Shipwrecked' (1,091), and describes the means taken to recover a child rescued from shipwreck; the other (1,092) is a 'Greek Shepherd at the Ruins of the Parthenon.' There are also two of great merit by C. F. SÖRENSEN, numbered respectively 1,088 and 1,089, and entitled 'Storm on the N. W. Coast of Scotland,' and 'The Bay of Naples.'

Some pictures from NORWAY are much to be commended for correct drawing and careful painting. 'The Grandparents' Visit' (953), A. TIDEMAND (whose works are already favourably known to us), is not inferior to the artist's best productions. Another domestic incident (948), children roasting potatoes, and entitled 'Are they done?' is by JOHANNA MÜLLER. To pass to a more ambitious theme, there is 'The Battle of Stamford Bridge' (942), P. N. ARBO, a very elaborate study, in which is shown the death of the Danish King, (A.D. 1066). 'A Plateau in Norway' (943), by J. F. ECKERSBERG—an artist whose death we reported a few months since—is original in everything, an extremely difficult passage but treated with great felicity. The character of the scene has no parallel either in Central or Southern Europe. Again there is much independent feeling in the management of 'A Street in the Altstadt, Hamburg' (946), by W. HANNO. Deserving also of particular notice are, a 'View from Nærnaes on the Sognefjord' (947), N. B. MOLLER, and 'Folgefonden, Snow Fields and Glaciers' (951), H. G. SCHANCHE; and thus we terminate our notice of the pictorial department of the International Exhibition, with an expression of satisfaction at the opportunity that such a gathering has afforded us of comparing the pretensions of such a variety of schools; and a hope that the favourable impressions which they have communicated may on future occasions be not only sustained but improved.

INTERNATIONAL EXHIBITION OF 1872.

HER Majesty's Commissioners have announced that the second of the series of International Exhibitions will be opened at South Kensington on the 1st of May, 1872, and closed on the 30th of September following.

The productions of all nations will be admitted, subject to their approval by competent judges as being of sufficient excellence to be worthy of exhibition, and provided they have not been exhibited in the previous International Exhibition.

The Exhibition of 1872 will consist of the following classes. For each class a separate committee of selection will be appointed:—

DIVISION I.—FINE ARTS.

Fine Arts Applied or not Applied to Works of Utility Executed Since 1862.

Class 1.—Painting of all kinds, in oil, water-colours, distemper, wax, enamel, and on glass, porcelain, mosaics, &c.

Class 2.—Sculpture, Modelling, Carving, and Chasing in marble, stone, wood, terra-cotta, metal, ivory, glass, precious stones, and any other materials.

Class 3.—Engraving; Lithography; Photography, as a fine art, executed in the preceding twelve months.

Class 4.—Architectural Designs and Drawings, Photographs of executed buildings, studies or restorations of existing buildings and models.

Class 5.—Tapestries, Carpets, Embroideries, Shawls, Lace, &c., shown not as manufactures, but for the fine art of their design in form or colour.

Class 6.—Designs for all kinds of Decorative Manufactures.

Class 7.—Reproductions—*i. e.*, exact copies of Ancient or Medieval pictures painted before A.D. 1550. Reproductions of mosaics and enamels; copies in plaster and fictile ivory. Electrotypes of ancient works of art, &c.

DIVISION II.—MANUFACTURES.

Class 8.—Cotton and Cotton Fabrics.

Class 9.—Jewellery—*i. e.*, articles worn as personal ornaments made of precious metals, precious stones, or their imitations, but not goldsmiths' and silversmiths' work, which will be exhibited in 1876, or watches, which will be exhibited in 1875.

Class 10.—Musical Instruments of all kinds.

Class 11.—Acoustic Apparatus and Experiments.

Class 12.—Paper, Stationery, and Printing:—(a) Paper, card, and millboard; (b) stationery, account books, &c.; (c) letterpress, plate, and all other modes of printing.

Raw Materials, Machinery, and Processes used in the production of all the several classes of manufactures mentioned above.

Detailed rules and lists of the separate trades engaged in the production of objects of manufacture will be issued.

DIVISION III.—RECENT SCIENTIFIC INVENTIONS AND NEW DISCOVERIES OF ALL KINDS.

All objects submitted for this Exhibition must have been produced since 1862. In the divisions of Manufactures and Recent Scientific Inventions and Discoveries producers can send only one specimen of each kind of object they produce, such objects being distinguished by novelty or excellence. The days appointed for receiving each class of objects are as follows:—

On Friday, March 1st.—Machinery and raw material.
On Saturday, March 2nd.—Recent scientific inventions and discoveries.

On Monday, March 4th.—Cotton.
On Tuesday, March 5th.—Acoustic apparatus.

On Wednesday, March 6th.—Paper, stationery, and printing.

On Thursday, March 7th.—Painting in oil and in water-colours.

On Friday, March 8th.—Painting in oil and in water-colours.

On Saturday, March 9th.—Reproductions of pictures, mosaics, enamels, &c.

On Monday, March 11th.—Architectural designs, drawings, and models.

On Tuesday, March 12th.—Tapestries, carpets, embroideries, &c.

On Wednesday, March 13th.—Engraving, lithography, photography, as fine arts.

On Thursday, March 14th.—Designs for all kinds of decorative manufactures.

On Friday, March 15th.—Furniture and all decorative works.

On Monday, March 18th.—Stained glass.
On Monday, March 25th.—Musical instruments.

On Wednesday, March 27th.—Sculpture.

On Tuesday, April 9th.—Jewellery, which must be brought in small cases, to be previously obtained from the Commissioners.

Prizes will not be awarded, but a certificate of having obtained the distinction of admission to the Exhibition will be given to each exhibitor.

All the rules and regulations in force as regards the Exhibition of the present year will equally apply to that of 1872.

OBITUARY.

SIR JAMES PENNETHORNE.

THIS gentleman, well-known as an architect, has not lived long to enjoy his recently-acquired honour of knighthood: he died, at his house, Malden, Surrey, on the 1st of September. Sir James was a native of Worcester, and was born about the year 1800. Having entered the office of the elder Pugin, with whom he remained a considerable time in studying his profession, he visited the Continent, especially Italy, with the same purpose, and, returning to London, became Mr. Pugin's chief assistant. About 1832 he was appointed Surveyor of Her Majesty's Works, and to the Board of Woods and Forests. During his career the metropolis witnessed many useful and ornamental works carried out from his plans and under his directions: the most notable being the formation and laying-out of Victoria and Battersea Parks; the erection of the Record Office in Fetter Lane; the new west wing of Somerset House; the south wing of Buckingham Palace; and the enlargement of the University of London.

In 1857 Sir James Pennethorne received the annual medal of the Royal Institute of British Architects; and in 1865 the royal gold medal. Last year he was knighted.

JOHN R. ISAAC.

Though the death of Mr. Isaac occurred some time since, we are glad of an opportunity of according a few lines to his memory.

He was the eldest son of Mr. Ralph Isaac, of Liverpool, silversmith and jeweller. He showed at an early age a decided talent and taste for the Fine Arts, and became an excellent draughtsman and engraver, to which latter business he was brought up. Having commenced in these branches, combining with them lithography and heraldry, he had a full share of the public work of the town, as also an extensive private connection. Among his earliest successes was his gaining the prize for the best design for cabins in the steamship *Liverpool*. He was afterwards employed in similar work for the Royal Mail Steamship Company. On the visit of the late Prince Consort, in 1847, to lay the foundation-stone of the Sailors' Home, Mr. Isaac designed and executed most of the work required by the Corporation for that event. He also issued a medal commemorative of the visit; one, in gold, he had the honour of presenting to the Prince. He was shortly after appointed medallist, lithographer, and engraver to his Royal Highness.

Mr. Isaac was chosen one of the Commissioners for Liverpool for the Great Exhibition of 1851. During the period of the Crimean war, he invented and patented the portable folding-hut, which was seen and approved by the English and French governments. By order of the former he erected a number of these huts at Aldershot. About 1850 he turned his attention to the business of the Fine Arts in connection with his former pursuits. In all connected with the above he displayed taste and ability of a high order, and strict integrity in the matter of buying and selling. His devotion to the Fine Arts was exemplified by the encouragement he gave to young artists. Two most important works produced by him were views of Liverpool and Manchester, published in chromo-lithography. For twenty-five years he was the honorary local secretary of the London Art-Union.

Mr. Isaac has left a son to carry on the business he founded, who promises to follow in the footsteps of his worthy father.

A VOICE FROM THE TIBER.

It will be within the recollection of our readers that so soon as Europe became aware of the downfall of that government which has reduced the *Campagna di Roma* to a squalid and pestilential desert, we called attention to the opportunity afforded for a complete investigation of the bed of the Tiber.* Our anticipations have been happily confirmed, and we are informed that an association is in course of formation for the purpose of exploring the channel of this river. Signor Alessandro Castellani, whose name is well known in this country, is named as chiefly active in the affair; and it is hoped that the artists, antiquaries, and learned men of both Europe and America will co-operate in raising the funds.

The project, as at first sketched out, is not that of a commercial or financial speculation; it is as an historic and archaeological pursuit that the exploration is projected. It will be evident, however, little more can be expected from this mode of appealing for public support than such a first instalment of funds as shall enable the managers of the undertaking to give some answer to the question—What may be expected from the search?

Expectation in Italy, indeed, seems very high. All things, possible and impossible, which are known to have existed among the chief Art-treasures of the world, and which are not otherwise accounted for, are put down to the *debit* of the Tiber. Even the famous golden candlestick of the temple at Jerusalem, which is represented on the arch of Titus, as borne among the spoils exhibited at that conqueror's triumph, is promised readily to the explorers, in spite of the evidence existing as to its transportation to Carthage by Genseric. It is not according to our own experience that the inhabitants of a beleaguered city, when the last hour of the siege arrives, should betake themselves to the patriotic task of rescuing the treasures of public and private wealth from the grasp of the enemy by casting them into the river. Burying we can understand well enough: there is an old and significant proverb to the effect that those who hide can find. But when life, honour, liberty are all vibrating in the scale, it is certainly rather accordant with our knowledge of Italian nature to suppose that the Romans should have endeavoured to make terms with their conquerors by helping them to discover the highest prizes of their venture, than that they should at once have aggravated the fury of the victors, and deprived themselves of the means of deprecating it, by a wholesale deportation to the Tiber of the chief treasures of the mistress of the world.

As to any systematic committal to the Tiber, on the chief occasions of the sack of Rome (by the Goths, the Vandals, the Lombards, the Greeks, and the Spaniards), we confess that we must await the testimony of the river itself before according any large measure of belief. Still less likely do we consider it that the mere approach to the gates of Rome of the Gauls or of the Huns should have added to the lost wealth of the Tiber. And on occasions of domestic uproar, when the statues of a fallen empire were overthrown, or when *main basse* was laid upon the house of prince or prelate, we would back the singular capacity of the Italian *lazzarone* for the snapping up of unconsidered trifles against the dramatic despair that should hurl golden treasures into the water. That we have only to trench and dig, in order to receive our fill of the most precious and valuable relics, we beg leave, therefore, for the present to doubt.

It is: the ordinary habit of rivers that run through cultivated districts to raise the level of their beds by deposits of the mud and silt borne down in their course. The burrowing action to which we owe so much of the result of pre-historic river activity is, for the most part, overcome

by the activity of man. But, in the course of rivers through the midst of cities, the convenience of the inhabitants generally leads to operations which restrain the level of the water, and counteract either the slow regular rise of the bed, or the more rapid mining action, such as may be noticed in the bed of the Thames, since the recent interference with the course of the river by new bridges and wharf-walls. Now, as the period to which the Romans point as that of the chief enrichment of the channel of the river lies from thirteen to fifteen centuries before our present date, it is clear that very slight causes of disturbance, acting over so long a period, may have had irresistible accumulated force. It is evident, therefore, that the case is one as to which it is no more possible to speak with certitude; in the absence of direct experiment, than it is as to the existence of coal under *strata* as yet unboiled. There is a great possibility, and that is all that can be asserted with confidence.

In one respect the traditions of the Italians, the discoveries that have long taken place, and are yet taking place, throughout great part of Italy, and the savage habits of barbarian conquerors, may be considered to agree. The thirst of the soldier is for gold—the art-value of a cameo or an intaglio goes for nothing in his eyes. Bracelets, ear-rings, rings, and similar objects are rudely and ruthlessly snatched both from the living and from the dead, on occasions similar to those of which the history of Rome gives but too many examples. The metal of which such ornaments are composed is the attraction—the gem, unless it is one of brilliant water, has often been wrenched from its setting, and hastily thrown aside. There is, then, a great probability that not a few cut-stones, the least perishable and the most highly finished of the works of the Greek artists, may be recovered from the mud of the Tiber, provided the search be carried on with something of the minuteness that characterises the diamond-washings of Brazil.

It will not be out of place to mention, in reference to the subject of the search for treasures of which the loss or the locality is entirely matter of conjecture, and as to the quiet and private abstraction of which, supposing them even to have been cast into the Tiber, no insuperable difficulties seem to have occurred, that there are spots in Italy which are certainly known to be the scenes of historic events, and the place of sepulture of at least archaeological treasures. Such is the bar that now prevents the access of any vessels of, moderate tonnage to the noble harbour of Brindisi.

It is our wish that a matter of such grave interest to the Art-world as the exploration of the Tiber should be regarded in a sober and practical light. Exaggerated expectations will be almost certain to lead to cruel disappointment, and thus to the definitive abandonment of the undertaking. On the other hand, there is ample ground for submitting the question to the test of experiment. We have little doubt this will now be done. But we are anxious the experiments should not be of that amateur and ill-considered kind which the glowing language of the announcement of the project leads one to fear are about to be attempted. The problem is a serious one. Certain conditions are absolutely essential to a satisfactory solution. Among these conditions is not only the habit of looking out for relics, which has become almost a second nature among the Italian peasantry in many parts of the country, but experience in directing fluviate and sub-aquatic operations, which can be best furnished by England. It ought to be known that it was by a brave British officer, to whose exertions the army is indebted for some of its most valuable text-books, that the practice of sub-aquatic research and labour was first rendered anything but precarious and unsafe. English divers, before the time of General Pasley, although furnished with the diving helmet, by means of which they could remain for hours under water, so managed their apparatus that if a diver stumbled and fell he was almost sure to lose his life. The charges and remuneration of the divers were kept up, it was considered, by the risk of the operation. General, then Captain, Pasley's efforts to introduce a perfectly safe, as well as commodious, diving suit, in which any

careful man might descend into the water without much previous instruction, met with determined opposition; and it was only by employing the disciplined privates of the Sappers, instead of the professional divers, that successful results were attained in the case of the *Royal George*.

That an expedition organised in this country, and guided by the long and varied experience that we can command in sub-aquatic procedures, would be the cheapest and most satisfactory mode of putting the preliminary question to the Tiber, we think there can be no doubt; for it is important, in our opinion, that the enterprise should be divided into two distinct stages. The first is the experimental one. What reason does examination, partial, indeed, but exact, so far as it goes, give for believing that there actually exists treasure recoverable from the Tiber? So long as the reply to this is mere inference and speculation, money will only be slowly forthcoming. Therefore the first search must be made with as little expenditure as is consistent with thorough practical exploration. As to that, we have indicated what experience points out as the proper course. If these preliminary investigations have the promised result, it will not be difficult to raise the money necessary for a more thorough and exhaustive series of operations—that is to say, if the Italian government will so far depart from their ordinary laws and regulations as to allow foreigners to take part in such an undertaking, and to acquire the proprietorship of the objects saved. As to rescuing gold and silver, brass and marble, for the Roman museums, that, though in itself a most praiseworthy object, is hardly one for which Italians should come to England for aid. A good deal, therefore, remains to be done before we hail with any very vehement applause the invitation to take part in the dredging of the Tiber. We hope those concerned in the scheme will take counsel by experience, and proceed with that measured and well-ordered haste which alone will prove to be consistent with good speed.

SELECTED PICTURES.

FROM THE PICTURE IN THE NATIONAL COLLECTION.

SLEEPING BLOODHOUND.

Sir E. Landseer, R.A., Painter. C. G. Lewis, Engraver.

A TRUE believer in the doctrine of metempsychosis may well suppose that the soul of Sir Edwin Landseer will hereafter pass into the body of some dog, so thoroughly have the painter and the animal been associated together for many years. Pope speaks of the "untutored Indian" and his dog sharing the same immortality of happiness:

"He thinks, admitted to that equal sky,
His faithful dog will hear him company;"

and certainly, if fidelity, and love, and trust, would secure such a privilege, a very large number of the canine race would be entitled to it.

What new thing can be said about Sir Edwin and his dog-pictures? The latter have long since exhausted all the eulogy that could possibly be bestowed on them by writers. Such dogs as his were never before seen on canvas, and probably never will be again. Here is a magnificent fellow, a "retainer" in some lordly mansion of old; he is said to be asleep, but he has an eye half-open, and is keeping watch and ward against any intruder; and his ears are on the listen, as if he heard the approach of some well-known footstep, possibly that of his master, who owns the strong helmet near him. "It is but a dog, after all," perhaps some hypercritic of Art may observe. "True," we reply; "but Landseer's dogs are not every-day dogs; and here is one of them."

* We can go back, with reference to this subject, to a far more remote date than that alluded to by our contributor. As long ago as 1846 we directed attention to a scheme then proposed for searching the bed of the Tiber: it, however, came to nothing, chiefly, we believe, on account of the hostility shown to it by the Papal authorities.—[Ed. A. J.]





EXHIBITION, OR BAZAAR?

THE Managers of the International Exhibition have justified the predictions of their enemies, and disappointed the hopes of their friends, by an avowal which has been elicited, rather than frankly made. The high tone originally adopted, and in virtue of which the main support obtained in this country has been forthcoming, is quietly dropped. The fair and open advantage offered to the individual artisan or small manufacturer to display his productions, signed with his own name and address, side by side with those of the largest firms in the world, is implicitly destroyed—the character of an educational, artistic, national display is to be abandoned—and the ground purchased by the money of the public is to be covered by a monster bazaar.

There are numerous points of view from which this determination may be regarded. It is hard to say from which of them it appears most objectionable. Perhaps the most serious of all is the great want of honesty involved in the project itself—independently of that evinced in the method in which it has been allowed to come before the world. We must dispose beforehand of the excuse that the International Exhibition and the South Kensington Museum are two distinct establishments. We freely admit that they differ—as much as the right-hand pocket of one's trousers differs from the left-hand one. Each has its own completeness, but each forms a constituent part of the same garment,—and the public has paid for the cloth. The members of the Committee of Council on Education are Commissioners of the International Exhibition, as well as ultimate authorities at the Museum. The secretary of the department is the director of the Museum, a member of the General Purposes Committee of the Exhibition, and, there need be no delicacy in saying the very *genius loci* of South Kensington. The Director of Works for the Department is the Secretary to the Exhibition Commissioners; offices, officers, and mutual aid are intertwined and interchanged between the Museum, the Exhibition, and the Albert Hall. Of the essential unity of the entire scheme there is no question whatever.

During the last ten years, the Science and Art Department has received no less than one million three hundred thousand pounds of public money. How much of this has been spent at South Kensington alone the public is not informed, as the expenses of general management are not distributed in the returns, but they give the acknowledged cost of South Kensington, for last year alone, as £64,000 against £78,000 spent in all other parts of the country. A quarter of a million sterling has been voted for new buildings, besides another hundred thousand for works and repairs. Thus munificently endowed (and we by no means grudge the amount) by the nation, the establishment at South Kensington has duties to discharge, no less than privileges to enjoy. It is at once a neglect of duty and an abuse of privilege, to come forward as a competitor with bazaars and with the great body of the retail tradesmen of the metropolis.

Such a competition is unfair and unjust. The rivals are heavily handicapped. Rent is the main charge upon the retail tradesman. In proportion to the publicity of his situation, and that of its capability for making large sales—is the amount of his rent. Thus it is not from greediness, but from self-defence, that the best shops in

Regent Street, Bond Street, and other favourite localities, are for the most part devoted to the sale of articles of better quality and higher prices—articles which yield a higher profit to the salesman—than is the case in more out of the way districts. A well-established business, with a good name well known, may thrive anywhere; but casual custom, which forms probably the larger part of these minor commercial transactions, is chiefly dependent on locality.

Whether then we look at ceramic manufacture—as illustrated during the present year—at jewellery, at textile fabrics, or at any other branch of retail commerce, London is full of old-established tradesmen, who pay high and even enormous rents, for the benefit of publicity and good situation. The general movement of fashion, like the steady increase of building, is a matter of which they are content to take the risk. But that the money of the tax-payers should be employed, in the first instance, in creating a great centre of attraction, which naturally tends to draw away shoals of customers from the haunts of trade, and then in opening a set of shops in which, rent free, certain favoured tradesmen may undersell their rent-paying brethren, is a step which needs only to be represented in plain English to show its utter iniquity. We will not use the term “job.” We will not impute any but the highest motives to the eminent men who have been betrayed into giving their sanction to this false step. But it is pretty clear that this sanction must be withdrawn. A weight will otherwise be tied around the neck of the Department which will swamp it. Who will be the minister that will have the face to ask parliament for two hundred thousand pounds for the expense of the Science and Art Department for the year ending March, 1873, when from all the united retail tradesmen of London there comes up one great cry of remonstrance and of indignation?

It is probably only in England that such a step would have been attempted. Had we any minister for Art, or any man, even in the subordinate posts in which æsthetic matters are administratively dealt with, who united competent knowledge of Art-matters to the faintest glimmer of patriotic or public spirit, such a proposal would have been strangled at its birth. Had we any local government of the metropolis, a measure so unjust to the ratepayers would be at once denounced and successfully opposed. The wisdom of the old rules as to trade within the freedom of cities and towns is illustrated by the present question. The old hatred of monopoly will be revived. For it would be a monopoly—and a most odious one—to allow the attraction, comfort, and accommodation secured by the state, professedly for educational purposes, to be rendered subservient to the establishment of a new, rent-free, favoured set of shopkeepers.

It must not be forgotten that one main feature of the Exhibition, on the advantage of which unusual stress was laid by its advocates, will be destroyed by this innovation. In an Exhibition, pure and simple, the humblest exhibitor, whose product is admitted, stands on the same level (if justice is done him) with the wealthiest and most famous. This is, there can be no doubt, a very admirable thing. But supplement the Exhibition with shops (for which the fashionable term of “annexe” has been invented), and the case is wholly altered. It will suit the purpose of the large manufacturer to keep shopmen or annexe-men, whose wages will be amply covered by the sales they effect. But how will it be as to smaller exhibitors?

They can afford no such cost; and thus, even after having run the gauntlet of an invisible and irresponsible committee of selection, they will be as much as ever overshadowed by their more wealthy rivals. The fortunate exhibitors, who can make a large display in the galleries and a corresponding one in the annexed “shop,” will first distance the London tradesman, and thus eat up their smaller brethren.

We have no wish to rank among those persons who take credit to themselves for predicting evil, or to say, that is just what we said would be the case. But it is impossible but that a long acquaintance with artists on the one hand, and with manufacturers on the other, combined with the facilities afforded by the machinery of the periodical press for gauging the public taste, should give a certain degree of experience, and lead to conclusions which it may not be altogether prudent to neglect. The experiment of a perpetual Exhibition was regarded, in the first instance, as extremely doubtful, by all persons except those who proposed it. In committing so much of its conduct to members of the gallant and scientific corps which is such an honour to the British army, we long ago pointed out that a serious error was committed. The professional education of the Royal Engineers is the best attainable in England. It does not, however, in any way include æsthetic cultivation, except so far as the mere practice of drawing may be considered to tend in that direction. In architecture there is a six-months' course—a period which speaks for itself. The habits of military promptitude and discipline are not calculated to produce that facility in dealing with manufacturers, artificers, and craftsmen of all kinds, which is a main feature of the civil professions of the architect and the engineer. Thus, in entrusting to Royal Engineers the conduct of negotiations with English exhibitors, we foresaw causes of trouble which have not been slow to declare themselves. Looking at the correspondence between the Commissioners and Mr. Copeland, it is impossible to acquit the former of great disingenuousness, except on the score of unusual want of the tact and habit of business. In June, 1871, the “red minute” No. 28 is quoted, which seriously modifies the professed principles of the Exhibition, and was acted upon in the case of foreign exhibitors, but not communicated to English exhibitors. This alone is a serious piece of mismanagement. The minute authorises the erection of galleries upon payment of a moderate rental. From the form of the Exhibition, this concession, nominally made to both “Foreign and British exhibitors” (*sic*), is available only for the former; as the French commission, for example, can supply objects of varying character year by year; while a manufacturer of pottery, of glass, or of other objects, only needs space for a single year, for which no one would erect a special structure. These buildings are called “Supplementary Galleries” in the minute, and “Annexes” in the correspondence. They are distinctly stated to form no integral part of the Exhibition, while in reality they are indistinguishable from any other of the galleries. They are, in fact, shops, with salesmen and saleswomen who solicit you to buy, just as in a bazaar of not the best character. They exist in direct violation of Article G of the announcement of the Commissioners, which states that no objects exhibited can be removed until the close of the Exhibition. Faith with the English exhibitors is entirely broken by this mode of dealing with what are termed “Annexes.”

ROYAL BIRMINGHAM SOCIETY OF ARTISTS.

THE Autumn Exhibition of the above-named society was opened to the public on the 28th of August. If the contents of the gallery are fewer in number than heretofore, every available foot of space is filled, while in general excellence the Exhibition is above the average: special works giving it precedence over the displays of the society for the last few years. The present includes many of the important works which were objects of interest when they hung in the recent exhibition of the Royal Academy—Millais's 'Moses, Aaron, and Hur;' Leighton's 'Greek Girls picking Pebbles by the Sea;' Horsley's 'Mary Queen of Scots in Captivity;' Pettie's 'Scene in the Temple Gardens;' George Smith's 'Last Scene in the Gambler's House;' 'Harvesting,' by George Cole; 'A Native of an English Common,' by the late John Phillip; 'Sunday Morning,' by C. J. Lewis; 'Day Dreams,' by W. P. Frith; 'The Depths of the Forest,' by J. McWhirter; &c. 'The Weird Sisters,' by Maclise; the very charming portrait of a lady, by James Sant; and 'Lady Dufferin,' by R. Buckner, are also works of special interest. As the great majority of the pictures named have already received notice in our columns, it is unnecessary to do more than simply allude to them by name as an indication of the artistic wealth of the collection. A recognition is due to the liberality of Colonel Charles Ratcliff, D.L. and F.S.A., Messrs W. C. Firmstone, W. H. Smith, M.P., Charles Winn, Joseph Beattie, William Everitt, and Mrs. Campell, for loans from their private galleries. Contributed direct by artists there are pictures of mark, as 'James VI. at Church,' by Ritchie; 'Queen Mary's last look at Scotland,' by Drummond; 'A Battle-field twenty years hence,' by Armitage; 'Good News of King Charles,' by W. H. Fisk; 'Fluelen, Lake of Lucerne,' and an 'Autumn Afternoon,' well represent John Syer. Numerous sea-pieces demonstrate the abilities of H. and H. J. Dawson; and the quiet which reigns over the works of James Danby is apparent, and as ably worked out as ever in his contributions. Limited space compels us simply to indicate that there are, in addition, interesting works by F. W. Topham, Charles Lucy, Collingwood, L. Haghe, H. Moore, Harry Johnson, Alexander Johnson, R. Clothier, J. A. Houston, Herring, A. J. Woolner, E. T. Cobbett, James Gow, D. W. Wynfield, H. C. Selous, H. Weigall, P. Deakin, F. Walton, &c. Continental schools are represented by Verlat, Coninck, Baccani, &c.; and the lady-contributors from a distance include Mesdames Anderson, Oliver, Luker, Misses Phillott, Rayner, McWhirter, Burgess, Blunden, E. M. Osborn, &c. While no doubt the chief interest of the Exhibition centres in works contributed from artists residing elsewhere, Birmingham has painters of its own, and to their works attention will now be directed so far as limited space permits.

Art grows by what it feeds upon; and exhibitions of pictures are incentives to the practice of Art. One-fourth of the works which make up this collection are by local professional artists, or by amateurs, who unitedly contribute no fewer than 169 examples. F. H. Henshaw, the Nestor of Birmingham artists, has confined his contributions to one solitary example, but it is characteristic; and 'The Queen's Bridge at Shugborough' is as sunny and bright, the leafy surroundings as delicately touched and carefully worked out, as any ever produced by this artist's pencil. Had 'The Cattle Trud,' of Peter Graham, not left its recollections, we should, as we do, award (as he is entitled to) the highest praise to C. T. Burt, for his 'Mountain Mists,' a very noble picture, admirably worked out. The open-air feeling and the masterly use of the pencil are further demonstrated in 'Mowing,' 'Carrying Hay,' and 'Crossing the Heath,' by the same artist. If S. H. Baker could abandon his peculiarity of colour, which is generally too low in tone, his pictures would gain by it; but for this defect his 'Evening' would be very attractive; and equally so his 'Llangynog;' and his other works. His sons, Alfred and Harry, show here-

ditary talent and independent thought, from which much is to be expected; an examination of the six works contributed by each shows facility of manipulation and good colour. C. W. Radcliffe, in free touch, is a master; probably if this were a little curbed and greater attention paid to form and colour, his pictures would be more valued than they are. W. H. Vernon's industry is undoubted, and is proved by the number of works exhibited by him; it might be suggested his pictures would be improved by more careful execution of his foliage, and a less liberal use of brown. C. R. Aston contributes a number of works which give evidence of continued care and promise: his 'Richmond Castle,' 'Richmond Castle and Bridge,' 'On the Mersey,' amply confirm our early-expressed opinions of his excellence and success. John Steeple is also a contributor; 'Ben An from the foot of Ben Venue, Loch Katrine,' is his best work, and is well sustained by two charming little sketches of North Wales scenery.

F. H. H. Harris has abandoned his former class of subject, and contributes a group of 'Cromwellian Warriors watching at an Outpost,' also an illustration of olden-time history, 'Margaret Roper about to steal her Father's Head from the Gate of Old London Bridge;' neither one nor the other can be considered a success. R. S. Chattock contributes only an etching; A. E. Everitt, various architectural and picturesque representations of buildings, time-honoured and hallowed; among others, that of the 'North Aisle of King's Norton Church,' speedily to be numbered among the things that were. P. M. Feeney contributes seascapes; uninviting as 'Sketch of the Sea from the Clovelly Hills' may appear to the casual observer, and, despite the want of apparent work, it could only have been made out by careful study. The same remark applies to his 'On the Clovelly Coast.' Edwin Taylor's landscapes are remarkable as examples of nature in holiday garb.

In portraits by local artists H. T. Munns must be placed in the van: his portrait of the Lord Mayor of London is admirable; it leaves but little to be desired, and is soundly and honestly painted. Clever as his other and dissimilar works are, the artist would do well to adhere to portraiture. W. J. Roden has some good portraits, but that of Mr. Peter Hollins is not a great success; very much better is that of Mr. Joseph Moore. His subject picture, 'The Betrayal of Christ,' is a mistake, despite the affectation of "old master" colour; the head of Judas is that of the very lowest possible type of humanity; intellect the traitor possessed; his representative in Mr. Roden's picture has not a trace or vestige of it.

Of the *genre* class of works, *i.e.*, figure-subjects, J. Pratt, F. Hinkley, and F. Hill, &c., are exhibitors. Pratt's best work is the old woman at her fruit-stall doing 'A quiet Trade,' which is minutely and carefully painted. T. Worsley, as a flower-painter, has no local competitor who at all approaches him in his keen perception of beauty in colour and form which distinguishes nature's most exquisite and tender handiwork. T. Clare is also an exhibitor; and a word of commendation is due to W. Pilsbury, for his delicately, beautifully, and truly-coloured group of flowers. H. H. H. Horsley, F. Green, H. Key, H. Pope, J. L. and D. R. Carpenter, J. J. Hughes, &c., with many others which our limits preclude the possibility of naming, comprise the local male contributors; of local lady-exhibitors there are many. Miss G. M. Steeple does so well, that it is important she should do better; her trees are too much disconnected in their masses; nor are their foliage or their varieties quite distinguishable by the treatment adopted on 'Ilka Bank.' Nature is something more than pretty; if this lady's works were finished out of doors they would be improved. Miss Aston has wisely kept to miniature and sent a very charming example, 'The Bride's Sister,' which does her credit. Among the other local lady-exhibitors, the names of Misses L. H. Aston, Florence and Mary Vernon, Bradley, Perrins, &c., will be found enumerated.

The Exhibition as a whole is excellent, and does abundant credit to the committee and indefatigable secretary, Mr. A. E. Everitt.

ART IN SCOTLAND, IRELAND, AND THE PROVINCES.

EDINBURGH.—Mr. Brodie, R.S.A., has completed the model of his colossal statue of the late Professor Graham, Master of the Mint; a work to which we alluded last year. The figure wearing a D. C. L. robe, is seated in an arm-chair, holding in his hand a book, on the cover of which appear symbolical representations of philosophical instruments: the statue is to be cast in bronze.

DUBLIN.—Mr. J. H. Foley, R.A., paid, somewhat recently, a visit to this city to report to the Committee of the O'Connell National Memorial the position in which that work now stands. Owing to the long-continued severe indisposition of the sculptor the progress of the memorial has necessarily been delayed; and Mr. Foley stated that he could not guarantee its completion before three years, though he might manage to get it finished in a shorter time, yet not in a way so satisfactory to himself that he would promise to put his name to it. The most advanced portion of the work is the central shaft of the pedestal, round which full-length figures, to the number of fifteen, will be placed. The majority of these, Mr. Foley assured the committee, are nearly completed.—An ineffectual attempt was made by some rampant iconoclasts, during the recent visit of a deputation from France, to destroy the statue of George IV. at Kingstown. The gunpowder by which it was intended to blow it up, or throw it down, exploded without any injury beyond leaving black marks on portions of the pedestal.

BATH.—Subscriptions are being collected for the purpose of procuring a duplicate of Mr. Theed's bust of Sir William Tite, now in the London Institution, Finsbury, to be placed in this city, of which Sir William has long been one of the representatives in parliament.

FALMOUTH.—The Royal Cornwall Polytechnic Society has awarded a silver medal to Mr. J. Squire, of Ross, Herefordshire, for his drawing entitled 'Evening at the Bedruthan Steps, Cornwall,' exhibited at the Society's gathering recently.

LIVERPOOL.—The annual Autumn Exhibition of pictures, &c., opened early last month with upwards of 900 works of all kinds. Most of the principal paintings in the collection had previously been exhibited in the London galleries; such, for example, as 'In St. Mark's, Venice,' W. Q. Orchardson, A.R.A.; 'The British Channel seen from the Dorsetshire Cliffs,' J. Brett; 'After a Battle—Wars of the Roses,' A. B. Donaldson; 'Saved,' J. D. Watson; 'Hercules wrestling with Death for the Body of Alceste,' F. Leighton, R.A.; 'The Love-Song,' J. Pettie, A.R.A.; 'The Church Militant,' and 'The Lament of Jephthah's Daughter,' both by G. E. Hicks; 'Odin,' V. C. Prinsep; 'A Disputed Text,' J. A. Houston, R.S.A.; 'A North Devon Cove,' J. G. Naish; &c. We have no space this month to enter upon critical details: it must suffice to say that the general interest of the exhibition is well maintained by the contributions of such artists as E. W. Cooke, R.A., J. Danby, J. Field, E. Hayes, P. F. Poole, R.A., C. H. Poingdestre, J. B. Burgess, C. Lucy, R. Beavis, G. F. Tenniswood, R. Hillingford, R. Ansdell, R.A., M. Anthony, A. H. Tourrier, F. W. Topham, J. Sant, R.A., A. Johnston; and many more well-known names.

MANCHESTER.—The Exhibition now open is certainly an improvement on predecessors of late years: it had dwindled from the best of the provincial gatherings to very nearly the worst. A deleterious influence has long been over it. A suspicion is very prevalent that the Art-magnate of the great city desires its suppression altogether. Probably there is no foundation for such an idea. But be the cause what it may, certain it is that the Exhibition at Manchester has descended from bad to worse: the better artists do not send contributions, and collectors (of whom there are so many) withhold from it their support. Yet the district annually "consumes" a very large proportion of the works that are produced in England and in Scotland, while the chief "buyers" of foreign pictures

are to be found in Manchester and the towns that neighbour it. Mr. Everard here gathers a rich harvest year after year. In 1871, the Exhibition would have been as were those of previous years, but for the liberality of one gentleman—George Fox, Esq., of Alderley—who has lent to it no fewer than twenty-six pictures, productions of the great artists of this country and the Continent, no one of which had been previously seen in the city. The result is, that the Exhibition is decidedly good: it contains much that will interest and instruct, and is not unworthy of the grand centre of Art-patronage. It was opened at too late a period of the month to enable us to do it justice: a duty we shall therefore postpone.

NORWICH.—The annual Exhibition held this year in connection with the Norwich Industrial Exhibition, in St. Andrew's Hall, is now open. The gathering consists of 418 works in oil, water-colour, and sculpture; comprising among its principal contributors the names of Mrs. E. M. Ward, E. Hayes, R.H.A.; F. Smallfield, C. L. Nursey (Hon. Secretary); H. Moore, J. Danby, J. Archer, R.S.A.; G. F. Teniswood, J. H. Mole, P. R. Morris, R. Burchett, T. Clarke, A.R.S.A., J. Bell, &c.

PRESTON.—Mr. Noble is engaged on a statue of the late Earl of Derby, to be erected in the Miller Park, adjoining this town. It is proposed to place the figure within an alcove, or under a canopy of some kind, to protect it from weather and smoke.

WINDSOR.—A short time since an action-at-law was decided in the County Court of this town arising out of the following circumstances. Mr. A. Y. Nutt, an architect, and who holds an appointment at Windsor Castle, was sketching, on the 15th of July, in the Clewer Fields, when he was roughly accosted by the son of a farmer, named Gristwood, on whose land he stood, as to his right to be there. An altercation followed, and he was charged with trespassing; the result being that Gristwood, his son, and a labourer in their employ, seized hold of Mr. Nutt, and dragged him a considerable distance, with the intention of placing him in the Clewer lock-up, though he repeatedly gave them his name and address: his sketches, colour-box, and other materials were also thrown down and injured. The elder Gristwood was sued for the assault and damages, and the court very properly adjudged him to pay the plaintiff £10 for the destruction of his property, and £20 for the assault; the defendant was also mulcted in the whole of the costs. The penalties awarded show that the court considered the case to be one deserving of a severe punishment. The lesson may not be lost either on owners of land or on artists who go out sketching.

ART IN CONTINENTAL STATES.

PARIS.—Though allusion has already been made to the condition of Art-matters consequent on the siege of Paris and the Communist outbreak, further details may not be unwelcome to those who, with artistic sympathies, look wistfully on the trials through which the city has been doomed to pass. In the list of the architectural sacrifices, apart from all historic associations, they will have mournfully to contemplate the vast ruins of the *Tuileries*, the *Hôtel de Ville*, the *Palais Royale*, the Finance Department, the *Palais de la Legion d'Honneur*, the *Palais du Quai d'Orsay*, the *Palais de Justice*, and the *Palais de St. Cloud*. Minor and meaner remains might, but need not, be added. In all these, the main walls, unbroken, but wounded by many a sweep of ambient flame, stand in striking stateliness. Strange to say, they are, for the most part, unstained by the dark defacing tint which generally accompanies conflagration. Their noble stone is pure and clean, like the time-bleached remains of Palmyra, in the desert. On the other hand, where so much was fearfully menaced, much has been happily, nay, inconceivably preserved. The Louvre, with the exception of some injury to the Gallery of Apollo, has been held intact, with all its priceless con-

tents. Its great marbles, ancient and modern, still grace their pedestals. There the *Athlete* and the *Discobolus* display their fine muscular action; and the *Venus de Milo*, withdrawn from her temporary entombment in the cellars of the Prefecture of Police, again "rains influence," as seen from afar, and as gradually approached, in her secluded pavilion. The pictures of the old masters, thanks to the Arsenal of Brest, will again cheer, elevate, and instruct. Their galleries have not as yet been arranged for public admission, but the great French *Salons* are, as they were in the good times gone by. The contents of the *Luxembourg* galleries—the *élite* of modern French works—are quite intact. The *Sèvres* Museum, which, when menaced by the Prussians, was carried into Paris, has, strange and wondrous to relate, escaped attracting the worse than iconoclast Communists. The *Gobelins* fell, with all the tapestry it contained, created in that marvellous mechanism of Art; but the untouched crown-repositories are known to be replete with these precious commodities. The richly endowed Museum of *Cluny*, shrouded in its time-honoured structure, wherein, as in a reliquary, are encased the masonry of Roman *Lutetia Parisiorum*, still also preserves its cabinets stored with curiosities of *faïence*, of crystal, of jewellery, arms, antique furniture, and its redundancy of curious *et cetera*. Two fine libraries have emulated the fate of the Alexandrian, and become food for fire—those of the *Louvre* and *Palais Royale*. But the great *Bibliothèque Impériale*—the more than rival of our Museum—has been spared, as have those of *Sainte Geneviève* and the *Sorbonne*, besides other minor but not unimportant collections. The invaluable conglomerate of manuscripts belonging to the Imperial Library owe their preservation, as did the *Milo Venus*, to the protection of cellars. They were for a time buried, to rise again in those of the *Ecole des Beaux Arts*. In a more remarkable manner have the national historic archives, and the noble structure in which they were garnered, been preserved: for the latter was but too patent in its architectural beauty, yet its contents were undisturbed. The noble *Hôtel Soubise* stands in close proximity to the vast structure of the *Mont de Piété*. The extensive treasures of the latter drew the incessant attention of the commissaries of the *Commune*; but if their eyes turned towards the other building, with the pillared ranges of its courtyard, they found it all barren. The churches of Paris have also escaped, with the exception of a partial, but most severe loss, inflicted on *St. Eustache*, where the glass-paintings of Philippe de Champaigne have been destroyed—an irreparable loss. However, *La Sainte Chapelle*, that marvel of loveliness in Gothic Art, has escaped; and *Notre Dame* has to bless herself for not having been converted into a bonfire.

Many symptoms indicate that a great effort is to be made to revive Art in Paris, and to restore artists of every class—painters, sculptors, architects, and engravers—from the depression of the past disastrous year. There is an energetic reaction of work throughout the *ateliers*. In order to concur in the most practical manner with this important movement, it has been formally resolved and arranged, on the part of the Government, that the Exhibition of 1872 shall open in the old quarters, the *Palais de l'Industrie*, a month earlier than usual, viz., on the 1st of April. Every means will, no doubt, be taken to render French artists, and all others concerned in the matter, aware of this fact.

ANTWERP.—Mr. W. P. Frith, R.A., has been elected an Honorary Member of the Belgian Academy of Art, the head-quarters of which are in this city.

MILAN.—The building intended for the International Exhibition, to take place in the autumn of next year, is reported to be advancing. The applications for space on the part of intending exhibitors are so numerous that the committee has resolved upon the erection of additional annexes.

MOSCOW.—Encouraged by the success of the Industrial Exhibition held in St. Petersburg last year, the Russians are preparing to have one in Moscow, in the spring of 1872, on the same plan, but on a more extensive scale.

ART IN PARLIAMENT.

DURING the late session some of the Art-questions Parliament touched upon collaterally, are really more important than those which have been directly entertained. It is not the bare finance of the subject we would deal with in our retrospect; that is settled commercially by scale and weight, though we are often left with the wrong scale uppermost. It is the taste that is brought to bear upon matters of Art, when such are under discussion in even both houses of our legislature, to which we would point attention, or rather to the want of it.

On the 11th of August, a question was addressed by Mr. Whalley to the First Commissioner of Works, in reference to the statue of Oliver Cromwell, then exhibited in Palace Yard, as to whether the site it then occupied would be permanently appropriated to it; and this induced a few observations on the sites to be appointed for statues of eminent men. The subject was dismissed with a few off-hand observations. But if this question is worth notice at all in the House of Commons, it is worth mature consideration; for, after all, it is a matter of national importance, and if not duly discussed and exhausted, it will be productive hereafter of endless mistakes and expensive rectifications, whereof instances were adduced indirectly by Lord Elcho's question, as to whether there was any truth in the rumour that the "condemned statues" were to be resuscitated, and "placed in groups in enclosures in the neighbourhood of the Palace of Westminster?" This proposition is not very clear, but as it stands, it sounds very like such a concession made to the importunities of the several committees as shall crush the artists under the weight of adverse public opinion. The reason we have so many bad statues is, that our celebrities are unfortunate in having too many friends, whose persecution of them extends even beyond the grave. They could not be rescued from their clients during life, and the latter insist upon caricaturing their patrons after death. If such works are placed in public situations, it is not too much to ask that sculptors of approved ability be employed to execute them. Mr. Ayrton's replies to the questions put to him on this subject sounded very much like banter, but on being pressed he said:—the sites had been placed at the disposal of the committee who were at liberty to take what course they deemed most advisable. When either the models or the complete works were erected, they would be open to the observation of any member of that house; and on a previous occasion he spoke of the "gentlemen who were desirous of erecting the statues to the memory of the statesmen he mentioned," and here lies the gravamen of the mischief. In the whole course of our experience we have never known a statue so erected to come out a success, as the rule of these committees has been not to give the commission to a sculptor of publicly acknowledged worth, but to some enterprising artist who only wants one chance to raise himself to fame. These benevolent committees know, of course, nothing of Art. As our public statues increase in number, locality becomes a grave public question, and should be regulated by some suitable conditions. But the mistakes that are continually committed, as well with our inside as with our outside decorative Art, are utterly incomprehensible. If Canning were an English statesman and worthy of a memorial, why is he to be left out in the cold, if Parliament Square is to be the place of assembly? If a statue be worthy of erection, it is a public outrage to remove it and consign it to the cellar. But the argument is, that certain works, called by Lord Elcho the "condemned statues," were not worthy of erection, and this was discovered only when they had been subjected to public criticism: these facts demand that such public works should be directed by a competent committee.

Of the Art-questions discussed some were of little public interest as abounding in wearisome repetitions; we are, however, promised a report on the frescoes and interior decorations of the Houses of Parliament.

PRESERVATION OF WORKS OF ART.

At the recent meeting, at Weymouth, of the British Archaeological Association, a paper read by Mr. Joseph Drew, F.R.A.S., &c., on the above subject demands some notice in our columns.

After briefly reviewing the arts of sculpture and painting from the earliest period down to the end of about the seventeenth century, and the comparatively excellent condition in which the best works of the Italian and Flemish masters are still seen, Mr. Drew refers to that of more recent pictures, and especially those of quite recent times, lamenting the strong evidence they give of premature decay.

"Now the great question is, where are we to look for the cause of this decadence? Certainly not in the decline of the art. If we could entirely disabuse our minds of that 'halo' which schoolmen and enthusiastic Art critics have thrown around the works of ancient Art, and were to go through this year's exhibition of the Royal Academy, we believe we could point to canvases not wanting in the beauty and passion of Raphael, the sweetness of Correggio, the triumphs of Titian, the cool silvery transcripts of Ruysdael, or the golden sunsets of Cuypp—the mellowness of tone, which time alone can bestow, being the only element wanting to render many of them worthy of the admiration bestowed upon their early rivals. But will these modern efforts of the painter's Art bear the same test of years as their predecessors have done? We have melancholy forebodings—amounting almost to a moral certainty—that they will not. Now, the old masters were chemists as well as painters, they were no tyros in the mysteries of the crucible and alembic; they knew from personal investigation, much thought, and direct experience, the nature and durability of the pigments they were using. Under their own supervision were their canvases and panels grounded—under their own immediate direction were their colours selected and their mediums proposed. No element of care was wanting, no precaution neglected to make their works, not only worthy of their name to posterity, but durable in the highest degree. The artist colourman, with his prepared canvases at so much per yard, coated with whitening and size, and his tube colours, and megilgih, so neatly put up, but which will not bear the action of light for a few years, was unknown in these early days; and it was not until the productions of this particular branch of trade were made competitive in price and cheapness and became the order of the day, that decay commenced its ravages, and the durability of paintings could no longer be relied upon. In examining the preparation on some panels of the 15th century, we found the surface upon which the picture was painted much harder than the panel itself, whilst in modern panels it was quite the reverse. In the early panels the surface broke with a gelatinous kind of fracture, the edges of which were sufficiently hard to cut the fingers, whilst in the modern panels a fracture of the surface represented a soft marley appearance, and the preparation itself could be crumbled by friction or pressure. It appears then that this want of solidity in the preparation of canvases and panels permits the colour to sink in, it extracts the medium used in working them, and thus the pigments become so non-elastic, that as the panels and canvases contract or expand by the atmospheric changes so prevalent in this variable climate, so the colours are rent in all directions, and the fine network of cracks which we so frequently observe spreading over the surface of a picture would appear to be the first step towards its decay. Then again in the metropolis paintings are generally hung in rooms where the air becomes highly vitiated by the presence of large assemblages of human beings and by the pernicious influence of gas, and this is a very prolific source of destruction to these works of Art, added to which even the air of London itself has been declared by competent authorities to be very prejudicial to the preservation of paintings, owing to the excess of carbonic acid and other deleterious gases in the atmosphere; and if this hypothesis is correct then all other crowded cities must be the same. In watching the progress of this decay in a modern picture we noticed that when these cracks once made their appearance their edges were immediately eaten away by becoming oxidised, and as the erosion went on the fissures gradually widened, and although a thin coat of the finest mastic varnish would for a while stop the process of decay, still we have even seen the varnish itself rent asunder by the contractive and expansive action of the materials beneath. In fact, so justly alarmed have the patrons of Art become upon the question of durability of our modern paintings—for some of them have invested large fortunes in their purchase—that Sir Francis Grant, the president of the Royal Academy, has suggested that a chair for chemistry should be founded and a professorship established in connection with the Academy, so that the painters' Art might receive the assistance of the science of chemistry in order, if possible, to check the spread of this terrible blight which is destroying some of our noblest works of modern Art. This difference in the durability of paintings is painfully manifested, and can be readily studied by comparing the pictures of the Peel collection in the National Gallery—which are generally productions of the seventeenth and eighteenth centuries—with the Turner collection under the same roof, which may be called examples of our own day. In the former they are as perfect as when they were painted, whilst in the latter many are already in ruins. Indeed, the possessors of some of the best works of Reynolds, Turner, Wilson, Hilton, and a

score of other modern men, look with increasing dismay on the widening cracks and fading colours of those otherwise matchless productions of Art, and they feel they have a right to invoke the aid of the Royal Academy, whose council is supposed to be the conservators of this particular Art, to investigate the cause and point out the remedy for this gigantic evil, which is robbing posterity of the Art-treasures it is our duty to hand down to them, in as good a state of preservation as possible. But as we have said before, we do not believe that the Art has waned, but we do believe that all this mischief can be traced to the present rage for cheap productions. The age in which we live is essentially an age of electropaste, and lath and plaster. The ancients built their houses upon rock; the moderns build them upon sand. Quantity and not quality, expediency and not principle, are the prevailing characteristics of the present age."

There is, we fear, but too much truth in the view taken by Mr. Drew. The subject is undoubtedly one requiring consideration on the part of scientific men interested in Art; and certainly not in a less degree of painters themselves, who desire some kind of immortality for their works.

BAMBOO PAPER.

THE substitution of some available material for the rags that formerly fed our paper-making industry is a subject to which we have before referred. As soon as it became obvious that it was on the essential qualities of the vegetable fibre, and not on the accidental qualities of linen cloth, that the paper-making faculty depended, the direct appeal to nature became only a question of time. As yet all that has been done in Europe has been to make use of certain cheap and readily accessible ligneous tissues, by the mingling of which with the old-fashioned materials, in larger or smaller quantities, expense is saved at the same time that quality is deteriorated. To the use of esparto grass succeeded that of wood—wood, moreover, of such short and brittle fibre, that the paper it produces is as rotten as touchwood, with the additional disadvantage of being less combustible. A careful investigation of the various fibres supplied by the vegetable kingdom, and of their respective qualifications for the fabrication of paper, is a matter of no slight national importance. In any country in which science was properly honoured and cultivated, such an investigation would be a measure which it might be expected that the Government should originate. In the prevalence of the opinion that private advantage is the most efficient spur for scientific discovery, we are left to casual improvements in this important industry. The news of one of them reaches us from Havana. The Consul-General there has recently called attention to the enormous quantities of fibrous vegetables which the island of Cuba produces. Some paper-makers have made experiments, it is said with success, on the fibre of the bamboo, and on some of the creeping plants indigenous to the island. The bamboo has been devoted to the service of literature as long as the papyrus itself. More than two thousand years before the Christian era, the conquerors of China signalled the establishment of a new dynasty in the Flowery Land by a conflagration of the national records. These documents were written on plates of bamboo. How far they went back takes us almost beyond the flood! The dynasties of Yu, Chang, and Chea, had inscribed their records on bamboo plates for a thousand years before their barbarous destruction under the reign of the Thsin kings. Books of this primitive nature may be seen among the curiosities in the King's library at the British Museum. But to use the plant, not as wood, but as paper, to tear asunder the durable and jagged fibres only that they may be felted together in a finer and closer union—to supersede the toil of the *chiffonnier* by that of the cane-cutter—is a new application of an old material. It would be of great utility to those who are making experiments of this nature on the utilisation of vegetable fibre, to make themselves acquainted with the mode and the materials of manufacture now used in Japan. Paper, in that wonderful island-empire, serves purposes unknown in literary Europe. It is hard as *papier-maché*, or soft and delicate as cambric. It is there used for manufactures as diversified as they are numerous.

THE ANGEL OF THE SEPULCHRE.

FROM THE STATUE BY E. D. PALMER.

LIVING a secluded life—the world being his studio—in the far-off city of Albany, in the state of New York, is a sculptor, some, at least, of whose works have become known over the whole world, though few, perhaps, are aware whence they originate. The artist we speak of is Erastus Dow Palmer, born at Pompey, Onondago County, New York, on the 17th of April, 1817. At an early age he removed to Utica, where he learned the business of a carpenter and joiner, which he followed till nearly thirty years of age. "The eminently practical and prosaic nature of his trade," we are quoting from a notice of the sculptor contributed by Dr. Alfred Woltmann some few years ago to the *Berlin National Zeitung*, "did not interfere with the unfolding of his genius, which manifested itself from time to time in cleverly-conceived and skilfully-executed wood-carvings. By the merest chance he obtained possession of a cameo, bearing the effigy of a human head. His attention was awakened, and he immediately formed, and proceeded to execute, the design of cutting the likeness of his wife on a fragment of a conch-shell. This he accomplished during moments taken from his more practical engagements. A lover and patron of Art, who saw and appreciated the extraordinary promise of his first essay, encouraged him to persevere in the exercise of his newly-acquired faculty. For two and a half years he confined himself exclusively to cameo-cutting, by which he soon became celebrated, and was invited to transfer his residence to Albany, which he did."

It was, however, not to be expected that the aspirations of the sculptor would continue to range within such a comparatively circumscribed space: at the age of thirty-two he began to model busts, and to carve them in marble; the first, executed in 1850, being one of his child, exhibited in the New York Academy, under the title of 'The Infant Ceres,' where it attracted much attention. It was followed by numerous other works—busts, medallions, bas-reliefs, and statues; the list of which is far too long for us even to attempt. We may, however, point out his statues of 'The Dawn of Christianity,' which represents a young Indian girl contemplating a crucifix she has picked up in some forest; and 'The White Slave,' a nude figure bound to a tree by the Indians.

'The Angel of the Sepulchre,' executed for a monument, is his latest work: the figure is of heroic size; and is a production of great artistic power. Exception may, perhaps, be taken to the face as too stern, and not angelic, yet is it grand in expression and very beautiful. He is seated on the stone in an attitude of dignified repose, his flowing locks reaching down over the upper portion of the wings, and his entire form covered by a garment disposed in its folds and "setting" with remarkable grace. There is no conventional treatment here: it is the outcome of an original and earnest mind, a statue which the greatest living sculptor might acknowledge with pride as his own. It is, too, the production of a self-taught man, who has never travelled out of his own country.

We regret to know Mr. Palmer has been forced to relinquish his beloved art, from threatened loss of sight. He has acquired by it an ample fortune.



THE ANGEL OF THE SEPULCHRE.

ENGRAVED BY R.A. ARTLETT FROM THE STATUE BY E.D. PALMER ALBANY - NEW YORK



"LES MISÈRES ET LES MALHEURS DE LA GUERRE."

ONE of the most striking, at the same time but too natural, incidents connected with the late duplicate visitation of war in France, has been what might well be designated the eclipse of Art. The Prussian siege of Paris and the horrors, deeper and deeper still, of Commnism, were cause enough for this.

"Hope"—and Art—"for a season bade the world farewell."

All the periodicals, ephemeral and otherwise, dedicated to this theme, became extinct, and they are now but slowly giving signs of revival. They are led on very appropriately by the monthly *Artiste*, the forty-first year of whose existence had been so rudely interrupted. It is not a little remarkable, that the editors of this publication have chosen the present time for a reprint, from the original plates of Jacques Callot, of that work of world-wide renown, "Les Misères et les Malheurs de la Guerre."

The proceeding seems strikingly *apropos*. How fitting the occasion to stigmatise, with all the eloquence and point of pictorial illustration, the inhuman barbarities inseparable from the sword-slicing arbitrament of war. It was well also, under any circumstances, to give a fresh issue from the unequivocal original plates (which have been preserved by descendants of the family) of a work so unique in its character, and upon which time has so deeply impressed its approval.

Callot's career was brief, but it was teeming productive. He has left some sixteen hundred works between his earliest and comparatively infelicitous *burin* engravings and his genuine masterly etchings. In the latter he may be said to rank very near to Rembrandt. He had a strong native taste for the grotesque and caricature, but he, happily, subdued this at an early age. Nevertheless, he always felicitously touched off common topics of humour, such as illustrations of gipsy life. On the other hand, he ventured even on religious subjects, with sincerity and expression. In fact, towards the close of his days, the brilliant sunshine of his earlier life became gradually clouded with strong religious impressions deepened into melancholy asceticism. He died while yet in his prime, and in accord with a strange and well-authenticated incident. In his boyhood he had fallen into the hands of gypsies. His fortune was told, and he was forewarned that his life would not be a long one. He replied that if he only lived as an uncle, named Brunhault, had done, until he was forty, he should be content. At the age of forty-three his career terminated.

Although ostensibly French and associated with French Art, Callot was by birth a German,—he was born, in 1593, at Nancy, Lorraine, when Lorraine lived proudly under its own dukes. His father was recognised as of gentle blood, which in Lorraine was of high significance. He held the office of Herald at Arns, and yearned to have his son, Jacques, succeed to the honours of the position. The boy was wholly irresponsive. To heraldry he was never indebted for more than an initiation into the use of a pencil. He shook it off resolutely when only in his twelfth year, and, at that wondrously early epoch, devoted himself with all his energies to Art in its highest aims; for he had heard of its marvels in Italy, and longed to enter on a field of such high promise. For this, and this alone—no shade of doubt hangs over the biographical fact—Jacques Callot, almost a child, fled from house and home—intent on making way from Lorraine to Italy—to Rome. And he succeeded. He owed much of his accomplishment of this incredible enterprise to having fallen in with the tribe of gypsies to whom we have alluded, and in their company he won his way to Florence. It is not improbable that some of the mothers or daughters of these wanderers, gave the graceful, spirited, prepossessing boy an occasional lift in their truckle carts, or a ride on their donkeys. In Florence his appearance soon won for him a friend and protector, and, through the *attaché* of the duke's court, he shortly afterwards got forwarded to Rome.

Such was the adventurer before his "teens." Unfortunately for him, he was but in his legal infancy; and certain merchants of his country, who happened to be just then in the Eternal City, set eyes upon him, required explanation, and compelled him to return to his home. This, however, was but a vain rescue; in a very short time the boy was again a deserter—again, unaided by the Egyptian, trod the Italian soil, and again found himself in bondage. An elder brother discovered him in Turin, and carefully reconducted him to the parental abode. But his trials and troubles were not to be in vain. His father recognised the vocation so severely tested, consented to his becoming an artist, and provided for his return to Rome, in the snite of an embassy from the Duke of Lorraine to the Pope. The young artist then set himself sedulously to cultivate engraving with the *burin*, but, after some time, abandoning it and Rome, he betook himself to Florence, where he found in the etching-needle precisely the agent he required for the free, rapid, and responsive transmission of his fancy's teeming conceptions. Thence he carried out an uninterrupted alliance with *aqua fortis*, and became great. Duke Cosmo II. took him into high favour, and annexed him to his suite. After ten years of brilliant engagement in these quarters, the now illustrious Jacques Callot yearned for his native home, and to exchange the Arno for the Moselle. At this period he was sought for and invited to Rome by Pope Urban; to Austria, by the Emperor Ferdinand; to Brussels, by the regent Elizabeth Claire Eugenie; and by Louis XIII., to Paris. For the Princess he illustrated the Siege of Breda; for Louis, the siege of La Rochelle.

But days of heavy tribulation now came upon Lorraine. Louis XIII. turned his arms against her, Nancy was taken, and she was for a while subdued. This heavy misfortune gave occasion for a trial of Callot's higher nature, which has stamped him with the impress of true nobility. Louis wished to have his Lorraine campaign historically illustrated by Callot. The artist firmly declined the commission; he would not allow his pencil to commemorate the disasters of his country. One of the French courtiers having urged that he should be compelled to comply, he replied that he would sooner tear with his teeth the thumb from his hand than let it minister to such a purpose. Louis had the magnanimity to admire the patriotism of the artist, and held him thereafter in higher favour.

The positive experience which Callot had had in military life enabled him forcibly to conceive the work named above, and with which his memory is more especially associated—"The Miseries and Misfortunes of War." There is much completeness in the eighteen subjects in which this theme is worked out. They are miniature in aspect, but the clear delicacy of the etching-needle presents them to the eye in all the truest precision of detail. In drawing they are exquisitely correct; in action and attitude are true to life; and in general composition present the facile handling of an accomplished master. So much for their execution. The tales which they tell show forth, for the most part, the cruel iniquities of reckless marauders, who radiate on all sides from armies in a state of active campaign. The wholesale plunder of villages, with endless illustrations of murder, rape, rapine, and incendiarism appear in one set of plates; in another, the stern visitation of punishment under the *régime* of the provost-marshal, shooting at the stake, hanging in its most abhorrent form, breaking on the wheel, and, finally, the retributive vengeance wrought upon their persecutors by insurgent peasants armed with fork and flail. There were scenes in the recent wars in France, wherein what Callot set forth were but too closely emulated; while, in some specialities of horrors, they left his records but too far behind.

Personally, Jacques Callot was a man of winning aspect and manners, and in society he was a much-cherished favourite. It would be a serious omission of a curious and interesting fact not to state, before concluding this sketch, that Jacques Callot was, on the mother's side, descended from Joan D'Arc. His grandmother was grandniece of the great heroine. He was worthy of the blood.

KAPNOGRAPHIC LANDSCAPES.

IN the Ceramic Gallery of the International Exhibition were to be seen specimens of table porcelain decorated with little landscapes, in monochrome, of much delicacy and beauty. The label attached designated these articles as "smoke-painted porcelain." The peculiar clearness of the half-tones, which resemble those of the purest silver photographs, or of the gelatinous ink of the Woodbury type, challenged further inquiry. The official catalogue was obdurately dumb; and all that could be ascertained from the officers in charge of the department was, that the artist who had produced this graceful style of ceramic decoration resided at Berne.

The novelty of the method, and the puzzling significance of the expression, "smoke-painted," led us to seek for elucidation. The objects in question, it appears, were ordered by Mr. Gerard Gould, the secretary to the English Legation at Berne, for the purpose of being exhibited at South Kensington. They are all ornamented by original drawings, the method adopted being entirely inapplicable to transfer or reproduction of any kind. The quality, so precious to some Art-collectors, of being absolutely unique, is thus secured to every smoke-painted article.

The artist is Madame Adèle Lenzinger Koch, residing at Rue Christophe, Berne. In the simple and modest account which this lady has been, somewhat reluctantly, induced to give of her procedure, she does not claim originality. Originality of a high order, however, characterises the process, and we are not aware that it has been adopted by any other artist. While it is upon porcelain that the examples above referred to have been executed, any other material may serve as a basis, and we have before us some exquisitely-rendered microscopic landscapes thus produced on a common visiting-card.

The pigment is produced from the smoke of a burning candle. A wax candle is preferred; but, for some purposes, a gas jet answers admirably, as it gives clear and perfect half-tones for the distance. The candle is held in the right hand, the *plaque* to be ornamented in the left, and the latter is passed swiftly over the flame. This gives the first tint, or what, in other circumstances, would be considered an ugly smudge. A sketch is made on this bed of soot—the end of a match being used in the first instance as a pencil. Then the *plaque* is again rapidly passed over the flame. By successive operations of this kind, the charcoal of the match, a pencil, a touch from the finger, and, finally, the point of a needle being used to put in the lights—the fiery landscape is finally perfected. The simplicity of the means employed becomes apparent under a powerful magnifying glass; but the extreme delicacy attained is such as it would be difficult to imitate in any other method with which we are acquainted.

It is evident, however, that whatever be the ingenuity of the mode, it is on the skill of the artist that the beauty of the effect depends. If Madame Lenzinger has added a new medium to those already commanded by the draftsman, it is by the rare taste for natural beauty, no less than by her graceful touch in depicting the scenes she selects, that she has established an unquestionable claim to admiration as an artist.

This work—which may perhaps best be described as an etching on successive layers of the finest carbon, deposited in the form of soot—is of course as delicate and readily destructible as the finest down on the wing of the butterfly. It requires fixing. This is effected, by Madame Lenzinger Koch, by a varnish sold by Soehne frères, Rue des Filles de Calvaire, Paris. No doubt the admirable fixative Rouget, to which we have before directed the attention of our readers, would answer the purpose admirably. Articles of porcelain thus ornamented may be washed with cold water without injury. Hot water has been found to deposit a film on the surface, but on careful wiping with silk, the original lustre of the varnish re-appears.

Round medallions adorned by these silvery landscapes may be appropriately inserted in

carved work, or sculptured wood. Framed *plaques*, and objects of various kinds, may be obtained of the artist, whose rooms we recommend our tourist friends by no means to omit to visit. Especially grateful to an artist residing in such a spot as Berne is the voice of approval and of admiration from the busier part of the world. For any new branch of Art to spring up under such circumstances is a phenomenon of extreme interest to the Art-world. It is a source of satisfaction to ourselves to have the means of calling attention to the works of a painter upon smoke. Kapnography—if we are called on to christen the new Art—may be said to be the very reverse of photography. In the one, the subtle play and reflexion of light is imprisoned by the magic chemistry of the sun-beam; in the other the human imagination guides the hand to trace designs on the very type of change and emblem of destruction. To fix the faces seen in the fire, or to delineate the ever-changing forms of the clouds, does not seem to be a more unpromising task, than that of producing Alps and glaciers, forests and *châlets*, waterfalls and wood-hung streams, out of the very vapour of combustion—the smoke of a candle.

THE WELLINGTON MONUMENT.

“SISTER, sister, we have been both in the wrong,” might form the appropriate summing up of many a quarrel. In the case of the long-standing grief of the Wellington monument, neither party to the original contract can be acquitted of blame. Mr. Stevens has evidently over-estimated his own powers, and signally failed to look at his engagements with the precision of a man of business. On the other hand, not only was the bargain drawn with discreditable laxity on the part of Government, but the more serious wrong was committed of paring down the sculptor's estimate, and endeavouring, in point of fact, to pay for the bas-reliefs in the chapel, which form no part of the monument, out of money that should have gone to Mr. Stevens. Things being in this very unsatisfactory state, it was a perfect blessing to the sculptor that the matter was taken up by one of whom it may be said, with a slight inversion of the original phrase, *nihil tetigit quod non fœdavit*. The general result of Mr. Ayrton's taking a subject in hand followed in this instance. Mr. Stevens's sin of omission was blotted out by the violence of the attack on his studio and on his character. And a very pretty quarrel was got up for the edification of the outer world, and to our great national disgrace.

Out of this hobble we are glad to find that an *exit* has been provided by the use of a little common sense—rare virtue among administrators—on the part of those who had been so seriously compromised by their subordinate, the First Commissioner. A contract has been entered into with a responsible and competent person, who looks at the erection of a monument not only as a matter of Art, but as a matter of business. Eight thousand five hundred pounds, we believe, are now to be paid, and for this sum the execution of the design, by Christmas Day, 1873, is guaranteed. The various artificers employed will all come under the same regular and business-like rule; so much to the sculptor, so much to the founder, a proper allowance to every one employed; and we shall at last have the monument to our Great Captain. Mr. Collman, who comes on the scene as the peace-maker, and, what is more to the purpose, the monument-maker, is not a mere decorator, but a man of taste and of professional education, as well as a man of business; and we may look at it as a matter admitting of very little doubt, that the monument (without, however, the equestrian figure originally designed for its apex) will be complete by the time fixed.

Of the childish folly of making a full-size model of a work of Art of this nature there can be but one opinion among competent judges. Four thousand eight hundred pounds, and some eight years of time, have been wasted on a whim similar to that we have recently seen recommended for general adoption as a means

of dispensing with the aid of an educated class of artists. The fact is, that few men entirely uneducated in the use of the pencil can understand a drawing, and, in their helpless puzzle, they fancy they can understand a model, either on a reduced scale; or, as in this instance, full size. We recommend the study of the history of the Wellington monument to all persons who have hazy ideas as to models, and are unaware of the far greater accuracy that is to be attained by means of proper drawings.

The design of the statue is noble and expressive. It would, no doubt, have looked far better beneath the soffit of the arch to fill which it was originally designed, than standing in the middle of a chapel, which the incongruous reliefs that have been economised out of Mr. Stevens's pocket do not convert into a mausoleum. The fine seated figures at the side, one of which is now ready for the founder, and the other in progress, will be less distinctly visible than if they had been placed in the spot for which they were intended. The cherubs' heads, also in bronze, will, we trust, be found to emulate the noble carved work that adorns the choir of the Cathedral. Of the delicate and classic beauty of Mr. Stevens's workmanship in marble, the columns already *in situ*, covered with a rich diaper, and crowned by capitals of exquisite originality, we can speak in the highest terms. The purity of the Carrara marble is unusual. We believe that Mr. Stevens is, by preference, an artist in bronze; but he deserves praise not only for the cutting, but for the selection, of the costly material he has employed. Those of our readers who remember what we told them some time since of the cost and difficulty to be encountered by English sculptors who require Carrara marble, will well understand that Mr. Stevens must have sacrificed his pocket to his credit in procuring that which alone he has consented to use.

While it is matter of satisfaction that a practicable method of completing a work so long in hand has at last been found, we cannot omit to point out the great injury, not only to professional men, but to the progress of Art itself, that is involved in the treatment of the work of the sculptor or the painter as a subordinate incident of a contract for building or for decoration. Every member of the three great co-ordinate professions of architecture, sculpture, and painting, should lay such a lesson deeply to heart. And especially at a time when, as at present, educated professional men are made the special object of administrative discredit; while, at the same time, the Institution which has done more than any other in the country for the advance of decorative Art and industrious training, has been allowed to drift into a state of decided hostility to the architectural profession, the artist should feel that to neglect the precision and regularity of business is treason to Art itself. The education of the Royal Engineer is the best that this country affords. It includes a course of some six months' architectural study. For Royal Engineers, on the strength of this scanty preparation, to compete with trained architects, would have been a sheer impossibility, had the latter been always true to themselves. We fear that the history of the Wellington monument is only one out of many proofs of the extremely unsatisfactory state of high Art in this country.

Surely the time is arrived when Art, with its hundred ramifications, should no longer be considered insignificant, unimportant, or beneath the dignity of “Government;” when an Art-minister may be deemed as great a necessity as a minister for war. At present, all that appertains to Art is left entirely to the mercy of incompetence; a minister whose business it is to “see to it,” does not hesitate to avow that he knows nothing about it, cares nothing for it, and would very willingly permit the Thames to flow over and destroy all its idle or useless productions.

We shame to see how little is done for Art, year after year, by the legislature. Other branches of knowledge, other sources of intellectual pleasure, other originators or sustainers of civilisation, are asserting their claims in our day. Art, however, has been even more neglected during the last ten years than it was during the ten years preceding. We may well ask, How is this? and Why is this?

MINOR TOPICS OF THE MONTH.

SOUTH KENSINGTON MUSEUM.—The Annual Report of the General Superintendent and Director, Mr. Henry Cole, C.B., dated March 31, 1871, has reached us since the issue of our last number. From this document it appears that the charge of the new buildings has been handed over to the First Commissioner of Public Works—an arrangement that will diminish the apparent, though not the actual, expenditure of the Museum. The total vote for this purpose last year was £57,000. By means of a supplementary vote of £20,000 the buildings in course of erection have been rapidly advanced toward completion. Of the progress making in the erection of the new courts of the Museum, a short account was given in the last number of the *Art-Journal*. The Bethnal Green Auxiliary Museum has been finished as far as the main building goes, and is in course of decoration by the students of the Art-schools. Attention is called by Mr. Cole to the rough but effective method of executing pavement, in marble mosaic, by convict labour, of which we gave an account when a specimen was first laid down at South Kensington. The Art-collections which have been most largely increased during the past year, are those of jewellery and French *faïence*. In the former the chief purchase has been the extremely-injudicious selection of eighteenth-century jewellery made at the sale of the Treasury of the Virgen del Pilar. The agent of the Museum did not successfully compete for any of the valuable and well-authenticated specimens of ancient goldsmith's work, one of which would have been of more value than the whole of the uninteresting set of objects actually bought. A collection of Swiss and Belgian jewellery has also been purchased. 123 pieces of French *faïence* of Rouen, Sèvres, &c., of the seventeenth and eighteenth centuries, have been bought for £2,000; the sum of £1,200 has been given for a clock of gilt metal, of which the origin is undetermined and the taste atrocious; a Milanese chimney-piece of green and white marble has cost £350; £400 has been given for a dining-table and cabinet of satinwood—English eighteenth century work; a Limoges *plaque*, representing Christ crowned with thorns, has been purchased for £300; an Italian *tazza*, in heliotrope, set in enamelled gold, a rock crystal vase, and an agate cup, have cost together £580. It will be seen that the prices paid by the Museum are far from being on the decline. The most interesting and valuable purchase of the year is probably that of fifty-one pieces of Italo-Greek *terra-cottas*, statuettes, figures in *relievo*, and vases; for the most part damaged or fragmentary, but full of life and spirit, found in a tomb near Canosa, in Apulia: £400 has been paid to Signor Castellani for this collection, which is attributed to the period of declining Art in 200 B.C. When this news becomes known in Italy, there can be little doubt that Apulia will produce many more such “finds.” Mr. Layard has presented a collection of modern Spanish *terra-cotta*; Signor A. Castellani, a collection of modern Italian peasant-pottery; Mr. T. B. Illidge, a small collection of Wedgwood intaglios; and the Alexandra Palace Company, a collection of thirty Chinese musical instruments. There are also bequests of oil-paintings, water-colour drawings, and Anglo-Saxon antiquities. The number of visitors to the Museum during the year 1870 was 1,014,849, being a decrease of 28,805 on the number

in 1869. The attendance during the current year appears to be on the increase. Although in three out of eight months there has been a considerable decline, there appears to be no sign that the opening of the International Exhibition has lessened the number of visitors to the Museum. The amount voted for the year ending March 31, 1871, for the Museum was £64,112, 6s. 8d., exclusive of the proportion of the charges for general management. This total is £22,616 less than that of the previous year; but the amount of the item of new buildings, which stood at £24,000 in 1870, explains the decrease. The total expenditure on the Museum to date is nowhere distinctly stated. That of the Science and Art Department, however, from 1853 to 1871, amounts to 1,642,664. Out of this the Science and Art Schools, with their contingent expenses, have cost £587,348, leaving upwards of a million to the *debit* of the South Kensington Museum.

SCIENCE AND ART DEPARTMENT.—The Report of the Committee of Council on Education, signed by Lord Ripon and Mr. Forster, with Mr. Cole as secretary, records a large increase in the number of persons who have attended the various institutions deriving aid from the parliamentary vote. The Science-students have increased 37 per cent., from 24,865 in 1869, to 34,283 in 1870. The Art-students have increased from 157,198 in 1869, to 187,916 in 1870, or 19½ per cent. The total number of persons who have received instruction as students or attendants on lectures is upwards of 254,000. The expenditure of the Department for the year amounts to £184,796, or £17,326 less than in 1869. This, however, takes no note of the transfer of the building expenditure to another part of the votes.

SCHOOLS OF ART COMPETITION.—An error inadvertently appeared in our notice, in August, of the works of the Schools of Art at South Kensington. The statuette of 'Samson,' of which we spoke very flatteringly, and which gained a gold medal, is by Mr. James Steele, jun., of Glasgow, a student of the Glasgow School of Art and Haldane Academy. We stated it to be the work of Mr. James Robertson, of the Edinburgh school.

THE BRITISH MUSEUM.—The trustees of this institution have, it is stated, purchased for it twelve vases recently found at Capua. They are principally *amphoræ* of a rare and beautiful kind, and are assigned to a date a little later than Alexander. These vases are large in size, fine and varied in form, and have figures, in black, upon them.

GREENWICH HOSPITAL.—A portrait of the late Admiral Sir Edward Parry, who a few years since was Governor of this now silent and deserted Hospital, has recently been placed in the Painted Hall, as a gift from the widow of the gallant seaman. Another portrait, that of the late Admiral James Ross, painted, by Mr. S. Pearce, expressly for the purpose, and exhibited this year at the Royal Academy, will also find a place soon in the same noble Hall.

MR. EVERARD, of Bedford Square, to whose collection of pictures, principally of the Flemish school, we have from time to time directed attention, is about to open an exhibition at the large house in St. James's Street, formerly "Crockford's," and recently the "Wellington Club." It is of enormous extent, with spacious galleries and large rooms: yet Mr. Everard gives us to understand he will fill it, and that with pictures of the highest class, productions of all the great masters of Belgium and Holland, and some of the leading artists of Germany

and France. It is to be called **THE FLEMISH GALLERY**; and the warm support of the most influential painters of Belgium has been promised for its adequate support. It would startle our readers to know the prodigious extent of "sales" effected by Mr. Everard, not only in London, but in nearly every principal city and town in England and Scotland: and it is but just to add that he has established in this country a character for probity and fair dealing. There is scarcely an artist of note whose works he has not been the means of circulating among us. The Flemish school is especially one that is entitled to what it receives—high honour. An exhibition of works by Madou, Gallait, Portaels, and numerous other chiefs in Art, cannot but stimulate our painters to achieve excellence, and so be powerful and effective teachers. The great sales obtained for their works in England seem rather to have increased than diminished the demand for productions of our own artists; very few of true merit being returned from exhibitions to their producers. The collection Mr. Everard is about to bring together will be very attractive; its popularity may be considered sure. "The Flemish Gallery" will, no doubt, take prominent rank among the Art-institutions of the Metropolis.

DECORATION OF ST PAUL'S.—Since our last number was issued, the public has been turned out of the Choir of St. Paul's Cathedral to allow of the removal of the organ. A green curtain is hung across the western end of the head of the cross, and a temporary communion-altar is arranged on a platform covered with crimson cloth. The simple arrangement of these elevations, or flights of three, two, and one step, successively, without any rail or barrier, gives dignity to the temporary *daïs*, in spite of the rudeness of the benches and desks for the choristers and officiating clergy. A similar arrangement, on a grander scale, and executed in marble, characterises Canterbury Cathedral; and the interior is, in this respect, perhaps the most imposing of our ancient Minsters. We look with anxiety to learn how the new dean will bring to bear the excellent taste and judgment which have proved his best recommendations to this important dignity, on the great question of the worthy adornment of the Cathedral.

MR. GEORGE CRUIKSHANK.—The veteran artist, George Cruikshank, who has now nearly reached the age of an octogenarian, still wields his *burin* with youthful vigour and delicacy. The engravings he produces seem to be ever green, like their author. We have been favoured with one of his latest productions, of an allegorical nature, representing the Genius of the Commune revelling in the ruins of France. The subject is not an inviting one, and it is no bad compliment to Mr. Cruikshank to say that his republican fiend is extremely repulsive. More attractive is the frontispiece to the new edition of the *Ingoldsby Legends*, in which all the children of the fertile brain of Barham are grouping around that author's writing-table, the poor priest-ridden jackdaw playing no secondary part. In this plate, full of figures in every quarter of an inch of surface, is to be found not the slightest trace of declining power. The Cruikshank dear to our childhood is as true, as original, and as *naïve* as ever. Again, in the other illustrations of the book, old friends, as most of them are, there is the same wonderful freshness and clearness. Mr. Cruikshank originally engraved with the view of printing numerous copies of a plate, and appears to have the power of retouching without loss of effect. We are glad to give

a word of kindly greeting to an artist who is appealing to a third generation of admirers.

A MARINE AQUARIUM has been added to the attractions of the Crystal Palace; some months ago we gave details of the plan; they were then incomplete—they are now sufficiently finished. Time, however, will be necessary to give it full effect. Much animal life cannot exist without a due proportion of vegetable life, and some months must elapse before that can be obtained. Even now, however, a visit to the aquarium will be amply compensated, and the charge of sixpence cheerfully paid. The director is Mr. Lloyd, whose name is well-known in connection with projects of the kind; there is no one so capable of carrying out the plan with effect. Our principal motive in now referring to it is to express a hope that all residents by the sea-side, all who fish in deep waters, all, in short, who obtain aught that is curious from the ocean that surrounds our shores, will contribute to this grand receptacle of the marvels of the sea.

CHARLES DICKENS'S WRITING-FOLIO.—It may interest some of the admirers of the late Charles Dickens in this country and abroad, to learn that his writing-portfolio, or pad, which at his sale was purchased by Mr. William Bragge, F.S.A., the Master Cutler of Sheffield, is now in the possession of the Emperor of Brazil, who, with the Empress, were his guests at his residence at Shirle Hill, on the 8th of August, when the pad was presented to him by his worship, and gladly accepted.

THE REV. T. J. JUDKIN.—The death of this clergyman last month, at the advanced age of eighty-three, demands a record in our columns; for he was an accomplished landscape-painter, and, at one time, a constant exhibitor at the Royal Academy. The last picture we remember to have seen from his easel was, 'Gateway, Reading'—painted on the spot: it appeared in 1848. He long lived at Somers Town, where during forty years he held the cure of the Episcopal chapel, called Somers Town Chapel: this he resigned about three years ago.

THE CRYSTAL PALACE.—We shall regret to say aught that might seem in any degree to arrest the progress of this "Institution," for we regard it as a means of greatly improving, while amusing, the thousands by whom it is visited daily. The public is willing to make much allowance for its "shortcomings" in Art; to permit Mr. Blondin to cook his omelet on the slack rope, and even a horse with two heads to eat his oats without interruption. But there are limits that must not be passed: it is false economy to lose sight of the great guiding principle—that pleasure should be always, more or less, instructive. It will excite no feeling but disgust to read in the programme of a day's entertainment, that a pig is to be the reward of some oaf who will climb a greased pole. Such a temptation might have been offered a quarter of a century ago at Bartholomew Fair or at Greenwich: but the very lowest orders of society will nowadays protest against the notion that a thing so gross and coarse can please them. It is a frightfully retrograde movement; the next step may be a score of "rustics" grinning through a horse's collar—there are many yet alive who have "enjoyed" that intellectual treat.

A BUST OF THE LATE MR. GEORGE GROTE, by Mr. C. Bacon, is to be placed in Westminster Abbey. Mr. Grote held for several years the position of Professor of Ancient History in the Royal Academy.

REVIEWS.

LIFE AND LETTERS OF WILLIAM BEWICK, (Artist). Edited by THOMAS LANDSEER, A.R.A., 2 Vols. Published by HURST AND BLACKETT.

FIVE persons out of six professing an acquaintance with British Art would, we venture to say, associate the name of Bewick with wood-engraving, in the person of Thomas Bewick. But till within the last five or six years there was living an artist, William Bewick, out of whose history and correspondence his friend Mr. Thomas Landseer has compiled two very amusing and readable volumes. As a painter of original subjects he was little, if at all known out of the immediate locality in which he resided, the north of England, though his biographer says,—"As long as his health lasted he took pleasure in the production of historical and fancy pictures; and in the mansions of many gentlemen of the county of Durham, and the neighbouring counties, may be seen paintings which do honour to his taste and genius The claims of Mr. Bewick to any high rank as a painter have more than once been assailed; but without venturing to assert his right to one of the highest niches in the Temple of Fame, we are justified in asserting that the artist who received so many testimonies of approval not only from the public, but also from brothers of the brush, must have possessed more than ordinary talent." Mr. Landseer especially notices a head painted by him, which Wilkie and Callcott "mistook for a Murillo;" "The Kyloe Heifer," painted by Mr. Wilton Middleton, and engraved by C. Turner, A.R.A.; and "Jacob meeting Rachel,"—the latter was "particularly admired by Haydon." As a copyist of old masters, and especially of Rembrandt, Bewick appears to have been justly esteemed. He was born at Darlington in 1795, and died in the neighbourhood of that town in 1866. In his early years he was Haydon's pupil, and afterwards was entrusted by Sir T. Lawrence with some important commissions in the way of copies of works in Italy.* He lived on intimate terms with Wilkie, the Landseers, and the sculptor Gibson, who executed a very excellent bust of him, in testimony of regard.

There were others too with whom Bewick was associated for many years, and enjoying their friendship—with Hazlitt, Shelley, Keats; and in a less degree, perhaps, with Scott, Hogg, Maturin, and many more, eminent in the literary world. His reminiscences of these and others, as he met them in society, combined with his own correspondence and views of Art at home and abroad, form the staple of Mr. Landseer's gossiping volumes, which are full of anecdote and pleasant description, strongly tempting a reviewer to find room for some of them. We can, however, only extract a passage from a letter by Bewick to his friend Mr. Davison: it is dated January 1, 1857, about six years after the death of Turner; concerning whom he says,—

"What a fuss there is about our old friend Turner! How he has at last astonished the world of property! What would you not give for a scrap of Turner? Your little finger, I dare say. What would you have given for a shake of that mighty hand? or to have had your eyesight blest with a peep at the giant doing his wondrous work, a sly peep past the curtain to see him handle the brush, to see him poking away at his little shabby palette of dirty colours? What a wondrous artist Genius is! What a coiner,—what a philosopher's stone."

* The principal works he thus executed were copies of the Prophets and Sybils, by Michael Angelo, in the Sistine Chapel, Rome. These drawings were exhibited, in 1840, at the house then occupied by Bewick, in George Street, Hanover Square, where we saw them. A full description of the works was given in our Journal for the month of March of that year; this account Mr. Landseer has considered of sufficient value to be transferred at length to his volumes. We share his regret that, though they excited much interest in artists, unhappily for the country they were left on Mr. Bewick's hands, and not secured for any school of Art. Sir Thomas Lawrence intended to present them to the Royal Academy; but he died before the whole were completed, and those which were finished were disposed of at the sale of Lawrence's effects.—[Ed. A.-7.]

What transmutations it can effect, and how it can make the lieges stare, ope their 'glazed eyes,' and strike their illiterate senses with strange sensations, and pluck admiration from ignorance, envy, or jealousy!"

The allusion to Turner's "dirty colours" is not fortunate: his palette may have been "small" and "shabby," but certainly could not have been charged with colours that might be called "dirty," or the world would never have seen such pictures as the great painter sent forth.

Mr. Landseer has done his editorial task well: he allows his subject to speak for himself without any unnecessary interruption. He might, however, have inserted some dates advantageously, if only for the purpose of reference. On the whole his book will be found, as already intimated, very "readable."

SCRAMBLES AMONGST THE ALPS IN THE YEARS 1860-69. By EDWARD WHYMPER. With Maps and Illustrations. Published by J. MURRAY.

There must be wondrous fascination in mountain-travel, that it leads men—ay, and as we have lately read, a delicate young woman, too—to jeopardise their lives by scaling heights which seem inaccessible to any living creature but the strong-winged bird of the air. It is a species of bold daring which, it may be presumed, none can understand and appreciate but those who venture it, and who must have a peculiar construction both of mind and body to enable them to succeed in their most hazardous enterprise. "We can only die once," as a fellow-traveller of Mr. Whympers remarked, seems to be the solitary comfort the Alpine-climber can take to himself when setting forth on his perilous journey. And it must be only its exciting pleasure which prompts the undertaking, for no adequate amount of scientific knowledge has been added to the book of nature by the joint labours of the whole Alpine Club and others—that is, no really useful information; nothing beyond a more detailed description of a marvellous region of ice and snow, with its strange and beautiful aerial phenomena.

Admiring and rightly estimating all the qualities essential to make a good mountain-climber, we yet much prefer to follow such an one as Mr. Whympers on paper than in a real "scramble" among the Alps. It offers, at least, far less trouble to sit quietly and read his record of adventure, than to participate in the dangers and difficulties of ascending glaciers and escaping avalanches.

A considerable portion of this most exciting and interesting volume is occupied by the history of certain attacks on the Matterhorn; and the other excursions, that are described have all some connection, more or less remote, with that mountain or with Mont Pelvoux. These scrambles amongst the Alps were holiday excursions, and as such they should be judged. They are spoken of as sport, and nothing more. "The pleasure that they gave me cannot, I fear,"—we are quoting from Mr. Whympers's preface,—"be transferred to others. The ablest pens have failed, and must always fail, to give a true idea of the grandeur of the Alps. The most minute descriptions of the greatest writers do nothing more than convey impressions that are entirely erroneous—the reader conjures up visions, it may be magnificent ones, but they are infinitely inferior to the reality. I have dealt sparingly in description, and have employed illustrations freely, in the hope that the pencil may perhaps succeed where the pen, must inevitably have failed."

These illustrations—ninety in number, besides maps, &c.,—are by no means the least delightful portion of the book: as examples of wood-engraving we have rarely seen anything to equal them, and certainly never any that surpass them. They are Mr. Whympers's own work, and cannot fail to add materially to his professional renown as an engraver. Most of them, moreover, are from his own sketches, and, therefore, may be relied upon for accuracy. Were anything required to show the difficulties and perils of Alpine travellers, it would be the examination of the scenes which the author's

graver has depicted with such marvellous delicacy and beauty. The volume is most valuable for its illustrations alone; and we were not surprised to hear that it was out of print very soon after its appearance: a second edition has been prepared, and will, we believe, be ready for delivery in the early part of the present month.

GUIDE DE L'AMATEUR D'OBJETS D'ART ET DE CURIOSITÉ; ou, Collection des Monogrammes des Principaux Sculpteurs en Pierre, Métal et Bois, des Ivoires, des Emailleurs, &c., &c. By Dr. J. G. THÉODORE GRAESSE. Published by G. SCHOENFELD, (C. A. WERNER), Dresden; D. NUTT, London.

The title of this work—little more than a pamphlet of about forty pages—fully explains its object and scope. The list of monograms, however, is very considerable, including besides those enumerated above a large number used by the armourers, jewellers, and medallists of old times. To each is appended, so far as can be ascertained, the date in which the individual lived, and the name of his country. A curious catalogue is here supplied, and one that must be of service to antiquarians and collectors of objects of *virtu*. Dr. Graesse holds an important post in the Museum at Dresden, which has afforded him favourable opportunity for studying the marks that lead to the identification of certain classes of artistic productions. We learn from the title-page that he has published a similar work on pottery and porcelain.

MEMORANDA OF ART AND ARTISTS, ANECDOTAL AND BIOGRAPHICAL. Collected and Arranged by JOSEPH SANDELL. Published by SIMPKIN, MARSHALL, & Co.

Mr. Sandell tells us that this collection of anecdotes, &c., has been "a work of some few years;" if so, his labours have produced a "mighty small" result; his reading also must have been much restricted, to find nothing more novel and interesting than he gives us. Many of the stories—all of them relate to deceased painters—have been told over and over again, and in themselves possess little relative value. By way of increasing the number of pages in the volume, the compiler has added a quantity of miscellaneous matter—gathered from a variety of sources, acknowledged and unacknowledged—about fans, portraits of Shakspeare, old books, &c., &c., some of which have no, or but little, connection with Art and artists. The best that can be said of the "Memoranda" is, that it may afford some amusement to those who know nothing of painters and their doings.

PICTURES AND PLEADINGS. By the REV. J. B. DICKSON, LL.D. Published by HAMILTON, ADAMS, & Co., London; CROSSLEY AND CLARKE, Leicester.

A small volume of short prose and poetical writings on various subjects simply, pleasantly, and wholesomely treated. We notice it, chiefly, on account of one of these papers—"The Fine Arts as an Educational Medium." Dr. Dickson argues that Art cannot fail to be a very powerful instrument—especially at the present time, when the great social fabric is undergoing so vast a change—in elevating the social condition of the masses. "I affirm fearlessly," he says, "that the pulpit, the school, the press, are all defective without the Fine Arts. The work can't be done without them. Enthusiast as I am, and ever have been, in the cause of Art, I don't say it can do all, but it can do much to solve some of the difficulties of the times." The reverend gentleman's faith in his prescription is, perhaps, somewhat greater than our own; still, Art of a really good kind has generally been found a great teacher of what is socially good; and we should like to see the experiment tried on a scale worthy of the object. The paper on "Compulsory Education," which the author advocates, is ably, yet briefly, worked out.

THE ART-JOURNAL.



LONDON: NOVEMBER 1, 1871.

THE STATELY HOMES OF ENGLAND.

(OCCASIONALLY OPEN TO THE PUBLIC.)

"The stately homes of England,
How beautiful they stand!
Amidst their tall ancestral trees,
O'er all the pleasant land."

MRS. HEMANS.

By S. C. HALL, F.S.A.

THE ANTIQUARIAN NOTES AND DETAILS
BY LLEWELLYNN JEWITT, F.S.A.

CASSIOBURY.



CASSIOBURY, or Cashio-bury, as it is sometimes spelt, lies about a mile distant from

Watford, in Hertfordshire. It is, therefore, within easy distance—sixteen miles—from London, and may be considered as one of the breathing places of denizens of the Metropolis. The name of Cassio-bury is said, and with reason, to be derived from the Cassii, a tribe of the Britons who occupied the district, and whose stronghold, Verulamium, lies only a few miles away.

The Cassii were, at the time of the landing of Julius Cæsar, commanded by Cassibelanus, under whom they fought many battles with the invaders. The hundred is still called the hundred of Cassio, and the affix of *bury* evidently signifies an assemblage of dwellings surrounded by walls, or a burgh or borough. "Being, as its name implies, the only *bury* within the manor of Cassio during the Saxon era, it might have been either the seat of justice for the hundred (for the name *bury* will admit of this construction), or an occasional retreat of some of the British princes residing at Verulamium, of whom Cassibelanus was one," and by some writers it is stated to have been "the actual seat or home of Cassibelanus."

Under the Saxons the manor of Cassio was, it has been stated, among the numerous possessions of Offa with which he endowed the Abbey of St. Albans, and it remained attached to that abbey until the dissolution of the religious houses by Henry VIII. In Domesday book it is stated that "the Abbot of St. Albans holds Cassio; it answers for twenty hides; of these the abbot holds nineteen. There is land for twenty-two ploughs. Six hides are in

demesne, and there are five ploughs, and a sixth may yet be made. Three foreigners and thirty-six villains with eight bordars have there fifteen ploughs, and one may yet be made. There are, moreover, three bordars and two bondmen, and four mills of 26s. 8d. Meadow for twenty-two ploughs. Pasture for the cattle. Pannage for 1,000 hogs. Its whole value is £28; when received £24; and in King Edward's time £30. St. Alban held and holds this manor in demesne." In the twelfth century the revenue duties payable from Cassio to the abbey were, at Christmas 2s. and twenty-four hens; at Easter, 2s. and 600 eggs; and on St. Alban's day 2s. and twenty-four cheeses. By Henry I. the whole liberty of Cassio was formally made over to the abbey. In 1546, after the dissolution of the monasteries, "the lordship or manor of Cayshobury" and other places was granted to Sir Richard Morrison, Knight, in consideration of certain property in Yorkshire and Worcestershire, and of the sum of £176 17s. 6d. in money; to hold the same by the service of the tenth part of a knight, and paying for the same yearly £5 12s. 6½d. Soon after this, Sir Richard commenced the erection of "a fayre and large house, situated upon a dry hill not far from a pleasant river in a fair park, and had prepared materials for the finishing thereof; but before the same could be half built, he was forced to fly beyond the seas."

The mansion was completed by his son, Sir Charles Morrison, who died in 1599. On the marriage of Elizabeth Morrison, the only surviving child of Sir Richard's grandson, the property passed to her husband, Arthur Capel, created Baron Capel of Hadham, in 1641, from whom the present possessor, the Earl of Essex, is lineally descended. Baron Capel appears to have resided more at Hadham than at Cassio-bury, but his son, Arthur Capel, created Viscount Malden and Earl of Essex in 1661, after residing there for a time, took up his residence at Cassio-bury, the greater part of which he is said to have rebuilt—indeed it is said that the whole of the mansion, with the exception of the north-west wing, was rebuilt by him, employing for the house May, the architect, and for the laying out of his gardens Moses Cooke—who in 1675 published a volume on fruit trees—and, it is also said, Le Notre, and Rose, his head-gardener at Essex House, in the Strand. Of the house and its gardens, Evelyn, on the 16th April, 1680, thus wrote:—"On the earnest invitation of the Earl of Essex, I went with him to his house at Cassioberie in Hartfordshire. It was on Sunday, but going early from his house in the square of St. James's, we arrived by ten o'clock; this we thought too late to go to church, and we had prayers in his chapell. The house is new, a plaine fabric built by my friend Mr. Hugh May. There are



CASSIOBURY: BACK VIEW.

divers faire and good roomes, and excellent carving by Gibbons, especially the chimney-piece of ye library. There is in the porch or entrance a painting by Verrio, of 'Apollo and the Liberal Arts.' One room parquettued with yew which I lik'd well. Some of the chimney-mantles are of Irish marble, brought by my lord from Ireland, when he was Lord Lieutenant, and not much inferior to Italian. The tympanum or gable at the front is a *basso-relievo* of Diana hunting, cut in Portland stone handsomely enough. I did not approve of the middle dores being round, but when the Hall is finished as design'd, it being an oval with a cupola, together with the other wing, it will be a very noble palace. The library is large, and very nobly furnished, and all the books are richly bound and gilded; but there are no MSS. except the parliament rolls and journals, the transcribing and binding of which cost him, as he assured me, £500. No man has been more industrious than this noble lord in planting about his seat, adorned with walkes, ponds, and other rural elegancies; but the soile is stonie, churlish, and uneven, nor is the water neere enough to the house, though a very swift and cleare streame run within a slight shot from it in the valley, which may be fitly call'd Coldbrook, it being indeed excessive cold, yet producing fair troutes. 'Tis pity the house was not situated to more advantage, but it

seems it was built just where the old one was, which, I believe, he onley meant to repair; this leads men into irremediable errors, and saves but a little. The land about it is exceedingly addicted to wood, but the coldnesse of the place hinders the growth. Black cherry-trees prosper even to considerable timber, some being 80 foote long; they make also very handsome avenues. There is a pretty oval at the end of a faire walke, set about with treble rows of Spanish chesnut trees. The gardens are very rare, and cannot be otherwise, having so skilful an artist to govern them as Mr. Cooke, who is, as to ye mechanick part, not ignorant in mathematiks, and portends to astrologie. There is an excellent collection of the choicest fruit."

By the second Earl of Essex the gardens were altered and improved; and, it is said, that those of the old mansion of the Morrisons which had not been reconstructed by the first earl, were restored or rebuilt by him. With the exception of these alterations and a few other occasional repairs, the house remained as it was left by the first Earl of Essex, until the beginning of the nineteenth century, when the greater part was again rebuilt by the late earl, from the designs of James Wyatt.

We now proceed to speak of the families of Morrison and Capel, to whom Cassio-bury has successively belonged.

William Morrison, or Morysine, in the reign

of Henry VI. resided at Chardwell, Yorkshire, and it was his grandson, Thomas Morrison, of Chardwell, son of William Morrison by a daughter of Roger Leigh, of Preston, who removed into Hertfordshire. He married a daughter of Thomas Merry, of Hatfield, by whom he had a son, Sir Richard Morrison, who, in 1537, succeeded Cardinal Pole in the prebend of Yatminster-Secunda in Salisbury Cathedral. In 1539 he was appointed by Henry VIII. ambassador to Charles V., Emperor of Germany, in which he was accompanied by Roger Ascham, and, in 1546, had a grant of the manor of Cashiobury, and soon after commenced building there a mansion of considerable size. Besides Cashiobury he had grants, and acquired much property, in London, Wiltshire, Hampshire, and Somersetshire. Under Queen Mary and her persecutions Sir Richard was compelled to fly from England, and died at Strasburg in 1556. He married Bridget Hussey, daughter of Lord Hussey (who, after his death, married successively Henry, second Earl of Rutland, and Francis, third Earl of Bedford), by whom he had issue one son, Sir Charles Morrison, Knight, and three daughters, Elizabeth, married first to Henry Norris, son of Lord Norris of Rycote; and secondly to Henry, second Earl of Lincoln; Mary, married to Bartholomew Hales, of Chesterfield; and Jane Sibilla, married, first to Edward, Lord Russell, and, second, to Arthur, Lord Grey, of Wilton. Sir Charles Morrison, who was knighted by Queen Elizabeth, and was a minor at the time of his father's death, married Dorothy, daughter of Nicholas Clarke, and widow of Henry Long, of Shengie, and by her had issue a son, Sir Charles Morrison, and three daughters, Bridgett, married to Robert, fifth Earl of Sussex, Elizabeth and Catherine, who died unmarried. This second Sir Charles, who succeeded his father in 1599, and was then a minor, was created a baronet by letters patent, June 29, 1611, and on the coronation of Charles I. was installed a Knight of the Bath. He married Mary, daughter and co-heiress of Baptist, Lord Hicks and Viscount Campden, (the lady afterwards married successively Sir John Cooper, Bart., and Sir Richard Alford, Knight), and by her had issue two sons who died young, and a daughter, Elizabeth Morrison, who thus became his only heir. This lady, Elizabeth Morrison, married Arthur Capel, who, by letters patent, dated August 6, 1641, was created Baron Capel, of Hadham, and thus the large estates of the Morrisons, both at Cashiobury and elsewhere, passed into the family of Capel, its present holders. The arms of Morrison were, *or*, on a chief, *gules*, three chaplets of the first. Crest, specially conferred on Sir Richard, in allusion to his literary attainments, a Pegasus rising, *or*.

The noble family of Capel to whom Cassiobury, as has been stated, passed by marriage with the heiress of Morrison, and to whom it still belongs, is of considerable antiquity, and few families have been enriched by so many scions of brilliant intellect. The family appears to have been originally of Capel's Moan, near Stoke Neyland, in Suffolk, and here in 1261 resided Sir Richard de Capel, Lord Justice of Ireland: in 1368, Lionel, Duke of Clarence, son of Edward III., left by will "to John de Capell, my chaplain, a girdle of gold, to make a chalice in memory of my soul." Later on another John Capel, who died in 1441, left, by his wife, Joan, besides a son, John, a second son, William Capel, who was a draper and citizen of London, "and successively alderman, sheriff, representative of the city in Parliament, and lord mayor, and had the honour of knighthood conferred on him by Henry VII." He was twice lord mayor, and several times M.P. for the city. He died in 1515, and "was buried in a chapel founded by himself on the south side of the church of St. Bartholomew, near the Royal Exchange, London." He also gave his name to Capel Court. He married Margaret, daughter of Sir Thomas Arundell, of Lanhorne, by whom, besides two daughters, he had a son, Sir Giles Capel, Knight, who succeeded him, and married first, Mary, daughter of Richard Roos, son of Lord Roos, and, secondly, Isabel, daughter of

Sir Thomas Newton, by whom he had issue a daughter, and two sons, Sir Henry and Sir Edward. Sir Henry Capel married Anne, daughter of Lord Roos, and granddaughter of the Duchess of Exeter, sister to King Edward IV.: he died without surviving issue, and was succeeded by his brother, Sir Edward Capel, whose wife was Anne, daughter of Sir William Pelham, ancestor of the Dukes of Newcastle; he, dying in 1577, was succeeded by his eldest son, Sir Henry Capel, Knight, who, by his

second wife, Catherine, daughter of Thomas, Earl of Rutland, had, besides several others, a son, Sir Arthur Capel, Knight, who succeeded him, and was in turn succeeded by his son, Sir Henry Capel. This gentleman, who, like many of his family, had been sheriffs of Herts, married twice. By his first wife, Theodosia, daughter of Sir Edward Montagne, he had issue, besides others, a son, Arthur Capel, who was a minor at the time of his death.

Arthur Capel was born about the year 1614,



CASSIOBURY: FROM THE WOOD-WALKS.

and, both his parents dying when he was young, he was brought up by his grandfather, Sir Arthur. He espoused the royal cause in the troublous times of Charles I., and became one of his most valued and zealous adherents. He was rewarded with a peerage, being created Baron Capel of Hadham, the king in desiring this reward having written to the queen, "there is one that doth not yet pretend, that deserves as well as any; I mean Capel; therefore I desire

thy assistance to find out something for him before he ask." After taking an active part in support and defence of the king, Lord Capel was imprisoned in the Tower, and on the 9th of March, 1649, he was beheaded before the great gate of Westminster Hall. "His body was buried at Little Hadham, with an inscription stating him to have been murdered for his loyalty to King Charles I.; and his heart, according to a wish he had expressed to Bishop



CASSIOBURY: FROM THE SOUTH-WEST.

Morley, was inclosed in a silver cup and cover, to be eventually buried at the feet of the master whom he had so zealously served. But no funeral rites being performed to the memory of Charles I., the cup was kept in a press at Hadham, where it was discovered in 1703, and its contents placed in the family vault." It was this Lord Capel, who, before his elevation to the peerage, had married Elizabeth Morrison, and so acquired Cassiobury and the rest of the large

possessions of the Morrison family. The issue of this marriage was four sons and four daughters, viz., Arthur, who succeeded his father; Sir Henry Capel, created Baron Capel of Tewkesbury; Charles and Edward, who died unmarried; Mary, married, first, to Lord Beauchamp, and, secondly, to Henry, Duke of Beaufort; Elizabeth, married to the Earl of Carnarvon; Theodosia, wife of the Earl of Clarendon; and Anne, of John Strangeways.

Arthur, second Baron Capel, was, in 1661, created Viscount Malden, and Earl of Essex, and in 1670 was appointed ambassador to the court of Denmark. He it was who, as has already been stated, rebuilt Cassiobury, and formed its beautiful gardens. In 1683 his lordship was apprehended at Cassiobury on a charge of being concerned in the famous "Rye House Plot," and was committed to the Tower, where he was, as is believed, foully murdered, or, at all events, where he was found dead with his throat cut. The earl married Elizabeth, only daughter of Algernon Percy, Earl of Northumberland, by whom he had six sons and two daughters, most of whom dying young, he was at his death succeeded by his fifth son, Algernon Capel.

Algernon, second Earl of Essex, was gentleman of the bed-chamber to King William III., and held important offices under Queen Anne. He married Mary, daughter of the Earl of Portland, by whom he had issue two daughters and one son, William Capel, who succeeded him as third Earl of Essex; he married twice, and had, by his first wife, Jane, daughter of the Earl of Clarendon, four daughters; and by his second wife, Elizabeth, daughter of the Duke of Bedford, four daughters, and one son, by whom he was succeeded. This was—

William Anne Holles Capel, fourth Earl of Essex, one of the Lords of the Bedchamber to George II. and George III., and Lord-Lieutenant of Hertfordshire. He married, Frances, daughter of Sir Charles Hanbury Williams, Bart., by whom he acquired the estate of Hampton Court, Herefordshire, which was afterwards sold to Richard Arkwright, Esq., of Cromford, Derbyshire, and by her had issue two daughters, and a son, George Capel, who succeeded him, in 1759, as fifth earl of Essex; and, secondly, Harriet, daughter of Colonel Thomas Bladen, by whom he had issue five sons, viz., one who died young; John Thomas, whose son succeeded to the title and estates as sixth earl of Essex; Lient.-General Thomas Edward Capel; Hon. and Rev. William Robert Capel, chaplain to the King; and Rear-Admiral the Hon. Bladen Thomas Capel. His lordship died in 1799, and was succeeded by his son, George Capel, who, having succeeded to the estates of his maternal grandmother, assumed the name of Coningsby, and became George Capel-Coningsby, fifth Earl of Essex, Viscount Malden, and sixth Baron Capel. His lordship married twice, first, in 1786, Sarah, daughter of Henry Bazet, Esq., of St. Helena, and widow of Edward Stephenson, Esq.; and secondly, in 1838, Catherine, daughter of Mr. E. Stephens, but had no issue by either marriage. His lordship died in 1839, and was succeeded in his title and estates by his nephew, Arthur Algernon Capel, the son of his half-brother, the Hon. John Thomas Capel.

Arthur Algernon Capel, sixth Earl of Essex and Viscount Malden, and seventh Baron Capel of Hadham, was born January 28th, 1803. In 1825 he married the Lady Caroline Jeanetta Beauclerk, third daughter of the eighth Duke of St. Albans, and by her, who died in 1862, had issue: Arthur De Vere Capel, Viscount Malden, born 1826 (heir to the title and estates), who married, in 1853, Emma Martha, daughter of Sir Henry Meux, Bart., and had issue; the Hon. Adela Caroline Harriet Capel, now deceased, married to the Earl of Eglinton; the Hon. Reginald Algernon Capel, married to Mary, daughter of John Nicholas Fazkerly, Esq., and niece of the Earl of Rokeby; and the Hon. Randolph Capel. In 1863 his lordship married, secondly, the Lady Louisa Caroline Elizabeth Boyle, daughter of Viscountess Dungarvon, and sister to the Earl of Cork, and by her has issue living, the Hon. Arthur Algernon Capel, born 1864, and a daughter, born 1870. His lordship is patron of the livings of Watford, in Hertfordshire, Rayne, in Essex, Shuttington, in Warwickshire.

The arms of the Earl of Essex are—*Gules* a lion rampant between three crosslets fitchée, *or*; crest, a demi-lion rampant supporting a cross-crosslet fitchée, *or*; supporters, two lions, *or*, ducally crowned, *gules*; motto, "Fide et Fortitudine."

The park of Cassiobury embraces an area of nearly seven hundred acres, of which more than three hundred and fifty are called "the Home

Park," and about two hundred and fifty the "Upper Park;" they are separated from each other by the river Gade, which flows between them. The remainder of the ground is divided into woods, lawns, gardens, and all the other elegancies of grounds around the house, the site of which is also included in it. The parks are well wooded with majestic trees, among which

are a profusion of beech, oak, elm, and fir—some of the latter resembling in their enormous size those of Norway. Several of the beech-trees, too, are of gigantic size, some being said to cover an area of ground nearly 150 feet in diameter.

The present mansion was built from the designs of Mr. James Wyatt, at that time the

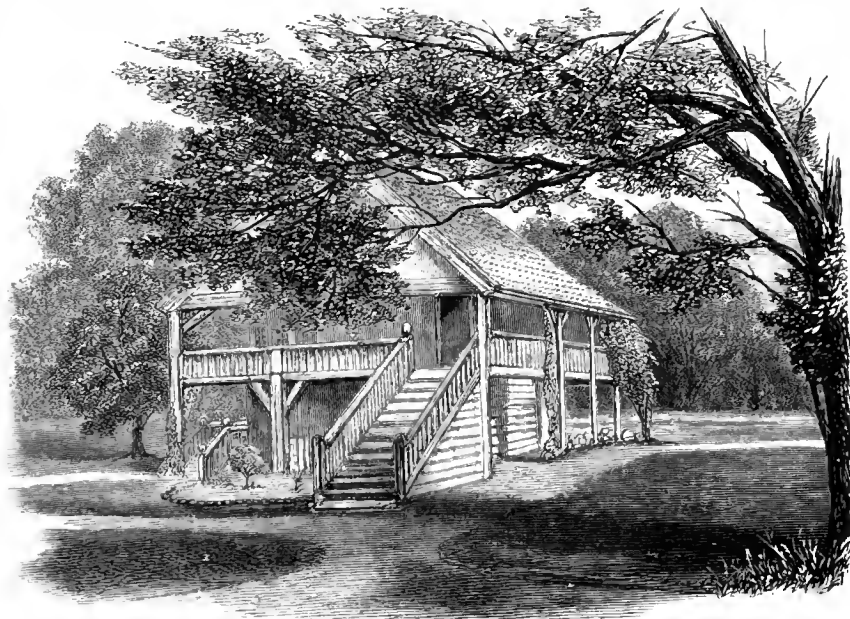

CASSIOBURY: THE SWISS COTTAGE.

fashionable architect of Fonthill Abbey, of parts of Windsor Castle, and other places: it is of that peculiar style of Gothic architecture which characterises most buildings erected by him. The general plan is a square; the building surrounding a courtyard or quadrangle, with a cloister on two of its sides; the entrance being to the west, the chief rooms to the south, the private or family rooms to the east, and the

kitchen, servants' offices, &c., to the north. A porch screens the entrance-doorway, that opens into a narrow cloister, on the right of which is a small vestibule and enclosed staircase. Eastward of these is the great cloister, having five windows, partly with stained-glass, and its walls adorned with full-length family portraits and other paintings.

Branching off from the cloisters is the SALOON,



CASSIOBURY: THE LODGE.

placed between the dining and drawing-rooms. "Its ceiling is adorned with the painting Evelyn mentions as belonging to the hall of the old mansion, and to have been the work of Verrio; the subject being composed chiefly of allegorical figures—Painting, Sculpture, Music, and War. In this apartment are two cabinets, containing numerous miniatures painted by the Coun-

tes of Essex," and many family, and other portraits.

In the DINING-ROOM, which is a noble apartment, with wainscoted walls, also hang several remarkably fine family and other portraits, by Vandyke, Hoppner, and others pictures,—notably 'The Cat's Paw,' by Landseer, and 'The Highlander's Home,' by Wilkie.

The GRAND DRAWING-ROOM, which is filled with all the elegancies and luxuries of the most refined taste, and with the choicest cabinets, is adorned with paintings by Turner, Callcott, Collins, and others. These are of the highest order—rare and beautiful examples of the great English masters in Art. Adjoining the drawing-room is the conservatory cloister, which is entered both from it and from the library.

The LIBRARY, which occupies four rooms,—respectively known as the Great Library, the Inner Library, the Dramatists' Library, and the Small Library,—is remarkably extensive; and contains, as such a library ought, a rare collection of valuable books in every class of literature. In these various rooms is preserved a fine collection of family paintings; and here, too, will be noticed some of Grinling Gibbons' matchless carvings, which are noticed by Evelyn as being there in his day. Among the historical relics preserved in the Library is the handkerchief which Lord Coningsby applied to the shoulder of King William III., when that monarch was wounded, in 1690, at the battle of the Boyne. It is stained with the blood of the king. There is

also here a piece of the velvet pall of Charles I., taken from the tomb at Windsor, when it was opened in 1813, with a fragment of the Garter worn by the king at his execution.

Like these, the other apartments at Cassiobury are filled with choice paintings and with everything that good taste and a lavish hand can suggest. The family portraits are, as might be expected, numerous, and of the highest order of Art; several are by Vandyck, Cornelius Jansen, Sir Peter Lely, Sir Joshua Reynolds, and other famous artists. Throughout the rooms are scattered admirable works by Rembrandt, Cuyt, Teniers, &c. &c.

We have made but brief reference to the gardens and grounds, and scarcely noticed the spacious and very beautiful Park. They are charms that neither lofty descent nor large wealth could purchase; the bequests only of Time. Centuries have passed since some of these magnificent trees were planted. The house is best seen from one of the high steeples on the opposite side of the river that runs through the demesne: lines of venerable chestnuts border a green sward that extends for miles.



IN THE CHURCH AT WATFORD.

Here and there glimpses are caught of the mansion, made by distance more picturesque than it is at a nearer range. In fact, there is at Cassiobury the happy combination of grandeur and beauty, natural grace in association with rich cultivation, that makes so many of the Stately Homes of England the boast and glory of the country.

The family burial-place of the Morrison and Capel families of Cassiobury is at Watford, where a fine monumental chapel exists in the parish church. This chapel "contains sepulchral memorials to the Morrison and Capel families, from that of Lady Morrison, wife of Sir Richard Morrison, who directed the chapel to be built in 1595." In the centre is an altar-tomb, supported upon six pillars, of various coloured marbles, on which rests the recumbent figure of "Lady Bridget, Countess of Bedford"—the lady by whom the chapel was founded—and daughter of Lord Hussey. She died in 1600.

On the south side "is a large and gorgeous monument to Sir Charles Morrison the elder, whose effigy, in armour, in a reclining posture, is placed under the canopy." On either side

of the tomb, in kneeling positions upon pedestals, are figures of the son and daughter of Sir Charles Morrison, and Bridget Morrison, Countess of Sussex. This work was executed by Nicholas Stone, in 1619, who agreed with Sir Charles to make "a tomb of alabaster and touchstone," and whose entry in his note-book as to price is very curious. He says he made it with "one pictor of white marble for his father, and his own, and his sister, the Countess of Sesex, as great as the life, of alabaster, for the which I had well payed £260, and four pieces given to drinke."

On the opposite side of the chapel is another large monument to the second Sir Charles Morrison, designed and executed by the same "carver and tomb-maker," as he is termed in the contract, and for which he agreed with the widow to receive £400. There are also several other interesting monuments and monumental slabs; the chapel is hung with banners and hatchments.

At this time, the church is undergoing thorough repair and restoration.

VISITS TO PRIVATE GALLERIES.

THE COLLECTION OF C. H. RICKARDS, ESQ.

At a house, "The Beeches," Old Trafford, (overlooking the site of the memorable Manchester Art-Treasures Exhibition of 1857), the residence of Charles Hilditch Rickards, Esq., is a remarkable collection of paintings, consisting exclusively of the works of one artist—G. F. WATTS, R.A., who has, in the great city of wealth, enterprise, and liberality, found in one of its most esteemed and respected citizens a full appreciation of his merits.

There are, altogether, twenty-six pictures by Mr. Watts, twenty-three of which occupy one room devoted to the singularly interesting and very admirable collection. The subjects are varied; although generally appertaining to portraiture, fancy has been, here and there, permitted full sway: while fact is usually predominant, as it is in most of the productions of the eminent painter. Those who claim for him the highest rank among British artists—and there are many who do so—will find in this room ample evidence to sustain that impression. It would be difficult to convey an idea of the power and vigour of these works; while occasionally intense feeling gives life to female beauty—a principle which Mr. Watts does not always study; sometimes, indeed, aiming to repel rather than attract; trusting, perhaps, more to strength than to refinement.

There are pictures in this series that might stand side by side with those of the best masters of the Venetian school. Such, of a surety, will give the "fame hereafter," which the artist can scarcely be said to enjoy in his generation. For ourselves—conversant as we are with his works—our estimate of his genius was much under what it is, now that we have seen in one "gathering" so many proofs of his marvellous power in dealing with subjects that in weaker hands could excite no large amount of admiration.

It will occupy no very considerable space if we devote a few lines to each of the pictures in the collection; it is not often that such a task falls to our lot, and it is pleasant to render merited homage—first to the painter and next to the gentleman by whom he is so thoroughly appreciated. There are collections in Manchester of greater extent and value, but there is no one that supplies a better theme for the critic, nor any that goes so far to remove an idea—very prevalent—that in the wealthy and money-getting city of cotton lords and merchant princes, Art is valued only as any other commodity—at what it is worth above what it will cost.

The first in order is a portrait of 'Mr. Rickards,' presented to him by subscription, to testify the respect of his brethren of the Manchester Board of Guardians, of which he was for many years the judicious and energetic chairman. Hence, no doubt, arose the acquaintance between the artist and the "patron" that has fructified to the advantage of both. Another portrait is of 'Mr. Prinsep,' the father of the well-known artist, Mr. Val Prinsep; it is a grand head, wrought to the highest possible "finish," broad in effect, yet manifesting care to points the most minute. Another is of the late 'Lord Brownlow'—the refined features of a most estimable nobleman who was removed from earth while but on the verge of manhood. Another is of the renowned violinist, 'Herr Joachim,' a highly-wrought and marvellously-finished portrait;

few works of its order have been produced to surpass it in modern times. Another is of the venerable 'Lord Lyndhurst.' There is a portrait of the artist, painted at the request of his friend, Mr. Rickards. It is a fine intellectual head of a man at his prime, or but little past it, and gives, perhaps, the key-note to the entire collection, in that subtle coincidence between the master and his work, revealing itself at once to the true student and lover of Art, though, it may be, an impenetrable mystery to the ordinary observer.

Mr. Watts has long held a high and prominent position as a portrait-painter; but it would be unjust to describe him as a portrait-painter only; there are works of his that may be justly classed among those of great historical painters. He is not, indeed, named among the more popular artists of his time; he has apparently worked out his own views for his own purpose; probably he will continue to court appreciation of the few rather than that of the many; but the homage due to genius is, therefore, surely his none the less. As a portrait-painter he has, it may be, obtained the full honours to which he is entitled—as a painter of male-portraits, that is to say; they are always original, always powerful, and always present the counterpart of marked or intellectual expression, when a congenial subject is placed by him on the canvas: but we confess we were not prepared for the grace, delicacy, and refinement, combined with strength, in the portraits that perpetuate the charms of the other sex. They are singularly true to nature, manifesting prodigious vigour in treatment, elaborated, yet free, and certainly establish the painter's right to be considered among the foremost men of his country if not of his age.

We pass to those of the series that may be classed under the term of fancy-portraits, for, with few exceptions, they are all of that order; we have, however, to notice two or three that aim at the "dignity" of history.

The first of the series is a very remarkable work, entitled 'Time, Death, and Judgment,' an allegory. A youth in the full bloom of approaching manhood, with a countenance of serene resolve, holds by the hand a hooded woman of dignified yet tender solemnity, "emblematising" Death, not as "the terror," but as an angel of deliverance; while Judgment looms in shadowy, yet suggestive impressiveness, above. Mr. Watts has authority for identifying Time with Youth, and however much it may jar on preconceived notions, we must concede the originality of the treatment; we may doubt, however, if it will be appreciated beyond the limited few in whom the ideal predominates.*

Somewhat similar in character is 'The Island of Cos,' a charming picture, representing a band of "Oceanides" sporting in a lower section of the sea. The upper sea blends with a lovely landscape, the rocks of the island stretching across the distance. We believe this is one of the finished

* We have been favoured with a copy of a gracefully written sonnet on this picture, and permission to print it, which we do gladly.

"TIME, DEATH, AND JUDGMENT."

"What power resistless o'er my being steals,
And in my soul a purer depth reveals?
Form, colour, beauty, have been often seen,
And each a sacred joy hath ever been,
But here is more—more lofty, more profound;
It captivates, and leads me on spell-bound
Into a wondrous region, new and strange,
Where thought, imagination, rapture rage!
My spirit mounts from earth-born stifling cares
To brighter realms and empyreal airs;
Hears sweet and low, through life's discordant jars,
Ethereal music from beyond the stars;
Strains breathing courage, hope, endurance, faith,
Heaven's echoes pulsating through Time and Death."

studies for a grand historical subject, representing the progress of creation.

'A Girl at Prayer' is of a very different order; it is a portrait, probably; but it tells with force and feeling a touching story. The heart of the young maid is in her self-imposed task, one in which prayer is mingled with gratitude and hope.

'The Window Seat' represents another young girl, plying her needle at an open window; it is a simple and sweet composition—a mere transcript of young nature—as it may be seen a hundred times in a day, yet one that genius can consecrate.

One of the loveliest works of the series is entitled 'The Early May'—a young girl in a blue dress; it occupies the place of honour in the room; the portrait (if it be a portrait) is that of a maiden holding in her hand a branch of apple-blossom; the composition is very touching: a soft and tender melancholy mingled with the hope of youth; somewhat of thought approaching sorrow; pensive almost to the extent of pain.

'Mergreta' is the picture of a young girl, noticeable from the combination of perfect youthfulness, with premonitory foreshadowings of tender grace and refined power, to culminate in noblest womanhood.

A woman sleeping on the sea-shore represents 'Ariadne.' It is the painter's idea of the poet's heroine. The flesh tints are simply wonderful, and with its subtle anatomy combine to form a picture that will be the especial delight of artists.

'A Knight in Armour,' and 'Daphne,' the companion, are two small upright pictures, striking from their excellence of colour; but they will not be considered equal to the artist's other works.

These, taken in the order in which they are hung, contrast with a picture that succeeds in the range along the wall: it is merely of the heads of 'Two Donkeys,' so marvellously faithful as to be of great value; Art has never gone further in picturing absolute truth; there is no living painter—perhaps none who is dead—by whom a common copy of reality has been surpassed.

It is a wide step in one sense, though not in another, to the portrait of a very lovely woman—the 'Marchioness of Bath,' a lady stepping from girlhood into womanhood, and taking with her all her charms. The artist has evidently appreciated his theme; one to which Art can scarcely render justice, so as to copy Nature.

'Little Red Riding Hood' is an original treatment of a familiar and always pleasant subject.

A 'Study from the Antique' gives life anew to the long-ago dead. The artist found his model in some old marble of ages past; and was inspired by it to produce a portrait that may be a joy for ever.

'Undine' is far more earthly: the young girl is not a spirit of air or water: it is rather a copy, though a fair one, of some beauty "ripe and real." But although the charming little picture is thus named, the artist had no intention to embody the creation of Fouqué: the association might as well be avoided by giving it another name. 'Esau' is a small replica of one of the artist's known pictures; a study apparently for some Eastern model, who may be to-day exactly what the heedless hunter was three thousand years ago.

In 'May,' the portrait of a young girl in white, are combined pensive grace and tender refinement, surrounded with an atmosphere of maidenly purity and goodness, very sweet to dwell upon.

'Edith' is the portrait of a lovely girl

with long auburn hair, very tender in expression, with heart and soul speaking in love and joy.

'Penserosa' is merely the portrait of a young girl, whose countenance expresses sadness rather than thought.

'Bianca' is a name given to a portrait, the original of which may be found at home rather than in far-off lands or in books of history. It is, however, perhaps the gem of the collection; and seems as if the artist aimed to contest the palm with the greatest of the Venetian painters. A beautiful woman bears in her hand a wreath of flowers; a necklace of pearl encloses the throat; she is habited in black velvet. All the accessories are admirably painted; but it is to the charming expression of a very lovely face that attention will be directed: perfect in drawing, carried to the highest degree of finish, the picture may take rank among the grandest Art-efforts of the British school, may compete, indeed, with the best productions of any period.

'Francesca di Rimini' concludes the series; the subject has been frequently treated by Art: notably by Gustave Doré in a picture now exhibiting in New Bond Street; and by a man of loftier soul—Ary Scheffer. The terrible and touching story of the great Florentine has never been more impressively told than it has been by Mr. Watts. The work is to the highest degree painful, so painful, indeed, that one would not desire to look upon it often: and that is apart from the main duty of an artist. The frail beauty, whose features express death, reclines on the bosom of her lover; the flesh has the taint of the grave, yet is still of earth: hand in hand, yet apparently the one hand barely touches without clasping that of the other; the eyes of both are closed; but death has failed to erase the grandeur and loveliness of the hapless pair. It is a mournful and gloomy scene; such as the poet pictured it, the artist has painted it. A more forcible rendering of a terrible passage in a terrible poem has very rarely been produced.

In this picture, as in several others of the series, some "landscape" is introduced; and we have thus evidence that the painter could, if he pleased, excel in that department of art. It is broad generally, yet sometimes minute; and if rarely what is called "finished," exhibits a truth to nature which few achieve. In the 'Island of Cos,' and in 'Little Red Riding Hood,' more especially, he has shown that boldness and vigour do not necessarily exclude nature in the treatment of minor details.

We have thus accorded a brief notice to each of the pictures in this remarkable collection; partly in honour of the liberal collector, who, having formed a high estimate of a great artist, desired to manifest a sense of his worth—and has done so; partly because the assemblage is unique: probably nowhere could we find so many examples of the genius of one painter—certainly not of one living painter; and partly because until we saw this "Gallery" (though contained in one room of a private house it is entitled to be so called), we had no idea of the great merit of an artist who seems rather to have shunned than courted popularity; and has sought his recompense not from the many but the few.

[Mr. Rickards is also the possessor of a sculptured head of the Medusa in white marble. This will add much to the interest and value of the collection—a collection, we repeat, surpassed in true worth by no other even in rich Manchester.]

THE
USE OF PLANTS AND FLOWERS
IN ORNAMENT.*

BY MISS E. TOULMIN SMITH.

THE love of ornament in some form is an instinct common to all mankind. Whether we turn to savage or civilised nations, we find it expressed in some way more or less in accordance with the true laws of beauty. The children weaving their garlands and decking themselves with flowers, the savage tattooing his face and placing feathers on his head, are only so many natural expressions of a desire for something to look upon more pleasing than the merely useful. This desire is but a carrying out of the design of the Creator of the world, who made it, and all around it, not only fit for His creatures to live in, but beautiful for them to behold. The continuance of vegetable life might have been secured, without requiring the endless variety we now have of flowers and fruits; but how much would the world have lost thereby, and how powerful a proof of the love of God to man would have been taken away! We are grateful to those who provide us with what is actually needful for our lives, but a much more lively form does this gratitude assume, if the desire for what is beautiful is satisfied at the same time with that for what is necessary. Indeed, it is doubtful whether any one would be able to make use fully of the powers given him, if the love of beauty were not gratified in some measure; and as the capacity of a talent, and the greatness of the aim towards which it directs its efforts, increase with its exercise, so the more we rejoice in what is beautiful, and seek for greater perfection, the nearer shall we arrive at an understanding of that never-failing source of beauty which is open all around,—the works of Nature.

But although a desire for ornament—that is, for something more than what is merely useful—is thus a natural instinct of the mind, it requires, like all others, to be trained and guided, lest it produce the opposite effect to what is intended. An unrestrained taste for adornment will lead to that taking the first place which should fill only the second. A first principle in ornament is never to let it supersede the object ornamented. The Egyptians, and after them the Greeks, kept this principle before them in all their works. Either, as with the former nation, ornament should be so embodied in its object as to become an integral part of it, from which one portion cannot be removed without injury to the rest; or, as among the Greeks, it should be kept subordinate to the general form of the whole. Neglect of this principle leads to much of the bad ornament of the present day. Instead of taking an idea from a natural form and using it to express one's own thought, the form itself is copied and made to look as like nature as possible. This may not strike us at first as making a wrong use of the forms drawn from nature, but a little consideration will show that it is so. In decoration we are not to change the nature of the object to be decorated, or to make it look like what it is not. This is the great difference between a picture and an ornament. A picture, to be of value, must present to our view such a representation of the subject as shall bring the scene vividly before the spectator. The differences of relief, of colour, of light and shade, are everything: the material upon which they are represented is nothing. In ornament, on the other hand, it is a mistake to represent forms and designs in so vivid or intricate a manner as shall distract the eye from the purpose of the whole, or deprive it in any way of the use for which it was originally intended. In designing patterns for a flat surface, for instance, it is bad taste to give them such relief, by means of light and shade, as shall make the whole appear rugged instead of smooth. This is very frequently done, and people allow themselves to be delighted with the wonderful copy of something with which they

are familiar, instead of considering how inconsistent it is with the subject ornamented. A carpet is made to appear as if there were real flowers upon it, or a wall-paper as if it were the side of a trellis covered with climbing plants, and both ideas are inconsistent with the surface upon which they appear, and which is required to be plain. But if, instead of copying the flower or leaf as we see it, we take note of its form, and from that work out a pattern for our subject, we shall still take our guide in Nature: but instead of being blind copyists, shall make an intelligent use of the language of form with which she supplies us.

Geometrical figures are the best upon which to found an ornamental design, and these we find in nature—the circle, the triangle, and the square being the basis of most, if not all, of her primary forms. A good illustration of the triangle is the ivy; the square we find in what are called cruciform flowers, and in the many kinds of bedstraw; and of the circle illustration is hardly needed, as we find it in the arrangement of flowers and leaves innumerable. And yet, though based upon these simple forms, what an infinite variety we see! There is no such thing as sameness. It is difficult to find two leaves exactly alike; yet a comparison of many may reduce them to the same typical form, thus showing how unnecessary it is to connect monotony with unity.

Having supplied us with a clear and simple ground-work upon which to carry out an idea, the study of vegetable growth shows what are the three other great principles always observed—namely, order, repetition, and proportion. There is not a plant that grows but exemplifies this in some way: first in the stem, then in the leaf, and then in the flower, order and arrangement are apparent. We see it plainly enough in plants whose leaves grow in pairs, one pair being placed at a direct right angle to another pair, and so on all down the stem, as in the wild guelder-rose. If we take a shoot of this tree and look at it from the top, we shall find the points of the leaves forming the four angles of a square. The same arrangement is observable in the placing of the flower-stems. This is one of the simplest. Other plants there are, whose leaves are arranged in such a manner that at every fifth row the order is repeated, or at every eighth or tenth row; and one botanist, who has paid much attention to this point, has found that in some plants—such as the house-leek and minor convolvulus—the leaves vary slightly in their arrangement until the thirteenth row, when they again start from the same relative position with regard to the stem. Of patterns founded upon the circle we have innumerable examples in the plants, both large and small, that fill our hedgerows. Take, for example, the dandelion or the daisy. Their leaves lie in circles one above another, the lowest circles clinging to the ground; but in what beautiful order are they arranged, and how exquisitely does the proportion of each diminish in size until the centre is reached, where nestle the two or three buds! We spoke of looking at a shoot of the guelder-rose to see the square arrangement of its leaves. A similar observation of shoots of other trees will give forms more or less complex, according to the growth of the leaves upon their stems. In all we shall find the same symmetry, order, and proportion, yet there is never a sameness. Harmony is produced without monotony, owing to the infinity of minor variations which are capable of introduction, without departing from the chief general form.

Another source, from which many beautiful forms may be derived, is found in sections of parts of plants. The forms suggested by some of these are exceedingly curious. A section of the stem of the common bracken gives us a very fair outline of an oak-tree with its branches sweeping the ground; another will show a willow. These fantastic forms are caused by the arrangement of the sap-vessels. Sections of other stems give a reticulated appearance, or a design of concentric circles traversed by star-like rays. The bark of trees and the arrangement of their fibres often present most beautiful geometric forms, and if we turn to seeds such as the apple, the rose-berry, and many others, a trans-

verse slice gives figures such as are found in many much-admired works of the ancients, and which are well adapted for the embellishment of flat surfaces. The architect Pugin examined very closely a large number of leaves and flowers, comparing them with the forms observable in Gothic foliage, and came to the conclusion that most, if not all, of these were drawn direct from nature. But he remarked upon the different uses made of these forms by the ancient and modern designer; the first placing them so as to give the desired pattern without interfering with the flatness of his surface; the second attempting rotundity and relief, and thus destroying the architectural consistency of the whole.

For a lesson in proportion we cannot do better than take a spray of ivy. Observe how gradually yet steadily the leaves diminish in size as they approach the tip. Each leaf as well as the whole branch is formed upon the principle of radiation from a centre and proportionate diminution. Another principle may also be observed—that every secondary line starts from its principal in such a way that the one forms a tangent to the other. This constant law of natural growth has been observed in all the best periods of ornamental Art.

When we have thus derived our forms from the plants around us, and observed how the three great principles of order, repetition, and proportion are carried out, let us proceed to apply them to the object to be ornamented, and here adaptation must be carefully attended to. In designing for such surfaces as floors, we may, with much advantage follow the example given us in the fields which are dotted with stars varied in size and shape, but which appear to us as stars only, and not as plants whose whole detail is distinct. The tile-work, so elaborately worked out in the Moorish, Roman, and Grecian floors, is arranged on precisely the same plan as this. Sometimes we find a wreath of flowers introduced round these stars, but they are only represented in flat tints, and therefore do not take away from the evenness of the surface. In designing patterns for walls we cannot give a better guide than that afforded by our old friend, the ivy, whose sprays, growing perfectly flat against a wall or paling, give form, proportion, and order, together with appropriateness, without any assistance from light and shade. The adaptation of the same system of design to small as well as large subjects is well exemplified in Egyptian and Grecian Art. We find the same ornaments, in a reduced form, upon the bowls and other household utensils of the Greeks, as they employed them to decorate their finest public buildings; and it is the same with the Egyptians; the papyrus appears on their spoons, boxes, and various ornaments in the same conventional manner as upon their temples. Nothing shows better than this how true were the principles upon which they worked, which would thus bear adaptation to all purposes.

There are four steps which the art of ornament has to take before it can arrive at perfection. The first is to imitate nature just as we see her. This requires no more mind than what any good copyist possesses. The second step is to select from nature only those forms which are the most perfect of their kind. The third step is to select such forms, and combine them in such a way as to give an idea the artist has conceived without copying nature. In the fourth and highest step the artist, after carefully studying and examining natural form and mastering the principles which regulate it, produces something that is purely ideal, but which, from the truthfulness of order, proportion, and symmetry therein combined, make the spectator feel its beauty, though not like anything to be found in the world of sense. As an illustration of the style of ornament produced by the first method, we may mention the Chinese; the second is represented by the Pompeians, and a part of the Middle-Age work; the third and fourth find their exponents in the Art of Greece, Egypt, and Byzantium, which latter reached its highest point of perfection in the Moorish palace of the Alhambra and the early English. It must be observed that in ornamental as in other Art the highest perfection was reached when the artist's

* To this essay Sir Stafford Northcote's prize was recently awarded by the Female School of Art.

hand was guided by devotion, and his one great effort was the desire to do honour to the object or objects of his worship. As Longfellow so well says:—

"In the elder days of Art
Builders wrought with greatest care
Each minute and unscen part,
For the gods see everywhere."

The Egyptians, Greeks, and mediæval artists certainly worked in this spirit.

In arranging any ornamental pattern, the first thing is to mark out the chief divisions in the space to be covered, and upon this to arrange the leading lines, so that from the beginning the general effect may be apparent. This being done, the secondary lines follow, and the intermediate spaces can be filled in according to the idea of the designer. There is no limit to the workmanship which may be bestowed, or the fancy that may be exercised, provided each part is kept in its place; the secondary not being allowed to break the continuity of the main lines, each one of which must be traceable to its origin. As examples of the highest degree of detail, which is compatible with broad effect, we would instance East Indian and Moorish Art.

We have thus far endeavoured to show upon what basis a truthful and perfect style of ornament must be founded. We will now trace shortly the different methods which have been followed in different countries, the styles flowing from the same principles being most varied.

Egyptian Art is the earliest to which we can go back. Other countries had doubtless worked out their own styles before this, but we are unacquainted with them. It is not known when or how it first arose, but the existing remains of buildings and monuments more than four thousand years old, point to a still more distant origin. Two plants, the lotus and the papyrus, were the types from which the greater part of Egyptian ornament grew, though other plants were occasionally made use of. Floral ornament was introduced. Sometimes it formed a part of the building itself, sometimes it was applied to the surface to be adorned. We find an example of the former in the columns of the temples, which very frequently are no more than the enlarged representation of a papyrus-plant, the head of which forms the capital. From the types of the lotus and the papyrus heads alone numerous varieties in the form of capitals are found, representing the flower wide open, or only half or a quarter grown. In the second class of ornament, where it was applied to a flat surface, we find representations of both flowers and animals, but always in a strictly conventionalised form. The Egyptians observed the great principle of decorative Art in never copying direct from nature. Their forms are always conventionalised, but in their method of making leaves spring from stems, and veins from leaves, they followed the law of nature respecting the tangential curvature. Representations of dried leaves, arranged on the principle of the lotus-flower, are also found, and the palm-leaf is introduced; but the fundamental types of the lotus and papyrus remain the most prominent.

When Egypt fell under the power of the Romans, a Greek element was introduced; and capitals of pillars are found uniting the two styles of architecture, the Egyptian papyrus or lotus being united with the Greek acanthus and honeysuckle. Not only in architecture, but in all kinds of manufactures, from textile fabrics and implements of household use—such as spoons, &c.,—to the Nile boats and their oars, was the type of the lotus or papyrus worked in.

Assyrian Art is considered to have been taken from the Egyptians, because the mode of representation and the objects represented are so very similar, that it is thought two distinct peoples could not independently derive the same ideas from nature. This may or may not be the case. Nature, when offering the same objects, must speak more or less the same language, and it is not by any means impossible that two of her children should interpret it in the same manner, though separated by country from each other. The pine-apple on the sacred trees, and a sort of lotus-flower, are the only designs among Assyrian ornament which appear to be drawn from this source.

Much of the ornamental foliage found at Persepolis resembles Roman so closely as to show it to be of a late date. A form is found that might be taken from the lotus-flower, or the bud, and a scroll like that of Greece.

The aim of the Egyptians and Assyrians was symbolism; the aim of Greek Art was to arrive at the perfection of beauty. Beauty consists in the adaptation or fitness of the parts which form a whole to that whole, and it was in this the Greeks so wonderfully excelled every other nation. Their Art is thought to have owed something to that of their predecessors in Egypt and Assyria; but the chief cause of its arriving at such a high point of perfection was that "the three great laws which we find in nature—radiation from the parent stem, proportionate distribution of the areas, and the tangential curvature of the lines—were always obeyed." The various parts of a scroll grow out of each other in a continuous line. The ornaments on the Greek vases and other household utensils depend almost entirely on form to produce a good effect, these forms are founded on the above principles. The Greeks never copied from nature, but drew form from it. Symbolism, which was wanting in Greek work, lost them one source of power, but this was balanced by the power of beauty.

The two plants from which the greater portion of Grecian foliage was derived were the acanthus and the honeysuckle. The latter is recognisable in many of their characteristic ornaments, but it frequently becomes so conventionalised as to lose all likeness to the natural flower.

The great secret of success in Greek Art was that, having started upon true principles, they worked these out with all the power they possessed in order to glorify their gods. Religion, not self-glorification, was the mainspring of their efforts; and no labour was esteemed too great that should add another charm to the temples dedicated to the services of religion, and the erection of which thus became an offering. It is objected, with regard to their elaborate workmanship, that much of it was placed at so great a height above the spectator, that its full beauties could not be seen; but if this fine execution did not detract from the merit of the design as a whole, it was rather in favour of the Greek artist, who bestowed such loving care on what, as was assumed, would only be seen by the deities they worshipped.

The aim of Roman ornament seems to have been to glorify self, and therefore it failed in arriving at the excellence of the Greek. The principal design of Roman ornament was that of one scroll growing out of another. The point of union was less delicate than with the Greeks, and the acanthus-leaf was not so refined. The Romans carried ornament so far as to make it primary instead of secondary, and while copying their forms from the Greeks, forgot to observe the subordination in which all were held to the main idea.

Pompeian decoration, taking a little from all preceding styles, owed its beauty to the freedom with which its fanciful forms were drawn, and the beauty of their colouring. The flowers and plants were arranged in squares or diagonals, sometimes conventionalised, sometimes drawn direct from nature, and often made to spring from most grotesque objects. As a whole, Pompeian Art is light and pretty, but is wanting in that breadth and repose which we find in ornament founded upon fixed principles.

Passing on to the East we come to Byzantine Art formed upon various schools. It originated in the employment at Byzantium, by Constantine, of numerous foreign artists, each of whom brought his own ideas. Greek influence is very marked, and traces of Assyrian workmen are also seen. Byzantine Art was at its best in the sixth century, and its forms are found repeated, either exactly or with slight modifications in many of the *Renaissance* buildings of Europe. Being the growth itself of many styles, it helped to form that of northern European nations. The Church of St. Sophia at Constantinople, erected under the patronage of Justinian in the sixth century, is the highest type of Byzantine workmanship. The distinguishing mark of this style is that the foliage has large and sharply-pointed leaflets, each one having a deep groove throughout. Its influence is chiefly shown in Moorish

architecture. In Byzantine mosaics, as in illuminated borders, we find a beautiful variety of form, mostly derived from plant-growth; but in these the principles gained from earlier sources are plainly distinguishable.

Arabian ornament was an intermediate stage between Byzantine and Moorish Art. A great breadth of effect is produced by incising the ornament, instead of raising it. The foliage, though showing traces of being derived from the Greek, and observing the principles of radiation and curvature, follows a new plan, continuing itself in one unbroken scroll instead of the stem branching off in different directions. The continuous scroll is found in their designs.

In the distribution of masses of form the Arabs did not equal their neighbours the Moors, who in this point appear to have arrived as near as possible at perfection. A comparison between Moorish and Arabian works, executed at the same period, shows the inferiority of the latter. The principles of ornamentation followed by the Arabians were similar to those which guided the Moors, whose grand work, the Alhambra, exhibits them as carried to the highest degree of refinement. Here we find the laws of proportion in colour, as well as in distribution of masses, most carefully preserved. The Moors also, in order to keep breadth of effect worked out their ornament on different planes. The leading lines would have the highest relief, the secondary lines be on a plane slightly below this, while on the third plane would be those which expressed further detail. Thus, while from a distance a good effect was obtained, this was not at all injured by a nearer approach, each step revealing new beauties which were before lost. The grand principle, to ornament construction, and not to construct ornamentation, was never lost sight of by them. They had a reason for every form they selected, and so arranged them that each line sprang from some other line. In those patterns derived from foliage, the natural method of curvature, and the connection of each line with its parent stem, are carefully regarded. Moorish Art shows how much may be learned from nature without copying her. Forbidden by their laws to give an exact representation of natural form, the Moors adopted those principles upon which it was arranged, and thus produced a class of foliage which, though extremely conventional, never offends the eye by absurd or inharmonious forms.

Among the Eastern nations Persia, India, China, and Japan, form was very much less conventionalised than among the Western. They reproduced more exactly the actual shapes of flowers and leaves. While the arrangement of their leading lines is in accordance with what are considered the best styles of Art, the intermediate spaces are filled up with actual representations of natural flowers. Understanding, as these nations do so well, the Art of harmonising colour, the beauty thus produced overcomes the inferiority of form; but looking at their designs with regard to form alone, and comparing them with those of Greece, or Moorish Art, we feel how much less mind has been required in the execution of the former, and how much less grand is the effect of the whole. One reason of this among the Persians, may be traced to their fondness for illuminating manuscripts; this would necessarily require a smaller style of Art than the works to which the Greeks gave their principal attention, and in which prettiness of design would be more pleasing than grandeur.

The Indians have worked out the most faithfully and consistently the laws respecting distribution of surface and arrangement of lines. Their Art is described as uniting the severity of the Arabian with the beauty of the Persian style. They understand in a remarkable degree how to combine richness of execution with breadth of effect, and also how to adapt the form of a flower to a given space without taking from its character. Their beautiful carvings in wood and ivory, their designs in silver as well as for their numerous woven fabrics, all show how closely natural form can be followed without being copied, and how by keeping in mind certain general principles, an endless variety may be given.

The Chinese possess, like their neighbours

the Indians, a marvellous power of harmonising colour, but they are quite wanting in the imaginative power which shall lead them to derive a figure from a natural form. They are faithful copyists, and therefore understand how to arrange their floral decorations with regard to growth, but have not been able to originate any flowing style of ornament.

Turning now from that division of Ornamental Art which had its birth in the Eastern hemisphere, let us glance at the Gothic,—the particular growth of Christian Europe. A broad style of arrangement was characteristic of the richest Gothic designs, and the effect of masses of light and shade was often trusted to, rather than detail; but all kinds of foliated form are employed in them, especially those taken from the plants of the Northern countries. Some are symbolical, as the trefoil of the Trinity; or the passion-flower of the cross. Of all the various branches of this great group, that of the Early English is admitted to be the most perfect, in principle and execution, of the Gothic period, and it excelled especially in its foliage, and the ornamental forms derived therefrom. Prior to the re-introduction of Christianity into England in the sixth century, English artists had their own modes of ornamentation distinct from those followed in other countries, but the employment of natural forms would appear to have begun about the ninth century. Gothic architecture in England reached its highest point of excellence in the thirteenth century, at which period the principles of fitness and adaptation were so observed in every part of a building, that nothing could be taken away without injury to what remained. The illuminations of the thirteenth century are also of excellent design, but afterwards works of this kind steadily decline; that is, the artists approach nearer to nature in their ornament, forgetting that it must be subservient to the form, letter or otherwise, to which it is affixed. In the cathedrals of Salisbury and Lincoln, and in Westminster Abbey, are found examples of the finest general effect united to rich decoration. The Anglo-Normans paid especial care to the doorways of their churches, enriching them with foliated forms; and in the interiors a great variety is seen in the groups of flowers, leaves, and fruits forming finials or bosses which unite the arches and leading lines of the building. Beautiful examples of this are to be found in Wells and Exeter Cathedrals, St. Mary Redcliffe, Bristol, and elsewhere. This foliage is remarkable for purity of line, boldness of treatment, and fine effect of light and shade. Besides its use in architecture and illuminations, foliated ornament was much employed by the Anglo-Saxons in their embroideries, which were celebrated all over Europe.

Little progress was made in Art of any kind in the thirteenth century, but in the fourteenth an impulse was given to it by Italian artists, who turned back to the masterpieces of Greece and Rome to help them to reform that which then prevailed. This re-birth of ancient Art culminated in that known as the *Renaissance*, or *Cinque-cento* style. The introduction of printing into Italy in the middle of the fifteenth century, gave great assistance to the restorers of the ancient styles, as it opened up to them the works of classical authors, written while Greece and Rome were in the zenith of their glory. In the ornament of the *Renaissance* period the first artists laboured; among whom we may mention Cimabue, Giotto, Ghiberti, Donatello, Raphael, and Michael Angelo. At the head of them all stands Raphael, whose crowning works in Decorative Art were his designs for the Villa Madonna, which are believed to have been executed under his own eye. Their superiority consists in the greater symmetry exhibited, and the broad effect presented by them as a whole, notwithstanding the exquisite detail of the parts. Having thoroughly mastered the principles of design presented by ancient Art, Raphael was able to adapt every form to suit his purpose without spoiling the effect, and from him arose the taste for *arabesques* which spread all over Italy. The characteristic of this style of ornament, in its pure form, is the skill with which the play of light and shade is made use of, when the ornament is in relief, to help the effect. Foliage, fruit, and flowers, are found intermingled with

birds and animals, but in the best examples all are kept in proper subordination to the general breadth of effect. The *Cinque-cento* ornament is an example of the way in which the principles of a former style of Art of acknowledged merit may be wrought out to a still further development. If the Italians of the fourteenth or fifteenth centuries had acted as some of the artists of the present day seem to do, and returned to a study of the works of their predecessors only to reproduce them, we should have had merely a second-rate edition of Greek and Roman Art, instead of the beautiful creations of the *Cinque-cento* period, which present to us the fundamental principles of ornament applied to a greater variety of form than had ever before been attempted, and exhibit a finish which, while never less than the subject requires, is not too much for it. A pure love of the beautiful would seem to have guided the artist's pencil, and to have made him add touch after touch to the child of his imagination until it stood forth to the world in perfect loveliness.

Renaissance Art was cultivated in France and Germany in the sixteenth century, but in the latter country it soon lost the gracefulness of the Italian original.

The celebrated *Majolica*-ware belongs to this period, and it presents us with designs adapted to ware fitted for daily use. To such perfection was it brought that it became a fitting present to send to distinguished persons. The Limoges enamel was also another material made use of by ornamentists of the French *Renaissance*, but it was very difficult to work.

In England a return to the study of the antique did not take place until the sixteenth century, when Henry VIII. employed some Italian artists to erect a monument in Westminster Abbey to the memory of Henry VII. Many artists came over to this country from Holland about this time, but the English themselves were by no means indifferent to the change which Decorative Art was undergoing. The second half of the sixteenth century produces many names of Englishmen connected with the ornamental buildings of their country. The close alliance existing between Holland and England in Elizabeth's time naturally brought to England many Dutch artists, who would influence considerably the Art of the time. No particular method would seem to have been followed. Combinations of lines, united with complicated scroll-work, or large flowing foliage, united with grotesque figures, all bore a part. Under skilful hands this variety in ornament produced a rich effect, but it was liable to be easily turned to over-decoration, in which the complexity of parts destroyed the unity of the whole.

Very few of the designs of Elizabethan Art are considered the outgrowth of the English mind; most of them are traceable to the Dutch influence before mentioned, though the work of English hands. This is more particularly the case with regard to tapestry-work, of which many very fine specimens of the time still remain. Illuminated missals and manuscripts of all kinds show the style of Art at the time of their production; and are very valuable in tracing the changes made from one stage to another. But it is more difficult to determine by what country they were produced than in the case of local decoration. Many of the beautiful illuminations of English books are thought to be the work of foreign artists. England does not appear to have advanced so far in any Decorative Art as in that connected with architecture. Perhaps the comparative dimness of her atmosphere led her artists to be less struck by beauty of colour, than by grace of form. While Italy produced so many glorious designs in her public buildings, France and Holland were especially strong in small subjects, such as tapestry and vessels of various kinds, the workmanship of which show them to have been the designs of first-rate artists.

In speaking of Decorative Art, the part in it taken by colour has been omitted; first, because form and the arrangement of lines is the first point to be regarded; and secondly, because colour is a subject so vast and complicated, that its consideration would swell this essay to an unreasonable size. Enough, we hope, has been said to show the source whence all that is good

in ornament has been derived. In this, as in every other branch of Art, *truthfulness* is the first thing to aim at. It needs very much study,—such as will, perhaps, seem to bring no return,—to understand how one form springs from another; and the results of many days' labour may be put down in a few lines or words. But if those words are words of truth, they are worthy to be found out and remembered, and are one more grain of knowledge to add to the common stock of the world. What we discover may be nothing new; daily do we find that nothing is new; but it is new to us, and therefore is worth finding out. Of all the employments to which men and women give themselves up, none require more patient, prayerful faith than the pursuit of Art. If their labour brings no actual result, they may be asked, or may ask themselves, Of what use is it? But if they can brighten the path of their fellow-creatures, if they can diffuse ideas of beauty, order, and propriety, where they have not before been known; and if, in doing this, they can direct minds, hitherto unheeded, to the source whence those ideas spring, and breathe into them something of the gratitude that fills their own hearts, as they behold the fairness of the world they inhabit, each one of them may congratulate himself that he is found worthy, in ever so small a degree, to add to the understanding of it. In ornamental, as in other Art, to become perfect must be a labour of love. Whatever may be the purpose for which it is intended, it must be a work of love while the artist is engaged upon it, and then he will never be satisfied without giving to it the whole powers of his mind, for we grudge nothing to what we love. It must have been in this spirit that our forefathers worked, six hundred years ago, when they produced those specimens of decorative Art which have been the admiration of the civilised world ever since. What was done then ought not to be beyond the powers of English people of the present day. The same sources of knowledge, with added ages of experience, are open now that were open then, and it is to be hoped that as more attention is given to these subjects, a truer feeling with regard to them may prevail.

SELECTED PICTURES.

THE FORTUNE-TELLER.

J. Phillip, R.A., Painter. Professor Knollé, Engraver. If our memory does not lead us astray, this picture was exhibited at the Royal Academy, in 1862, under the title of 'Doubtful Fortune.' It must be admitted that in expression and deep feeling Phillip was almost invariably wanting; his strength consisted in a gorgeous display of colour. Yet there is no lack of expression in 'The Fortune-Teller'; enough of cunning and deceit are seen in that repulsive countenance to assure all but a voluntary dupe of her readiness to play any part that may be the means of increasing her own worldly store; and she is evidently working upon the feelings of the Spanish maiden, who has come to learn her future destiny. Most probably the painter intended this, and hence he called the picture by the title he appended to it. The face of the furthestmost figure, whom we presume to be the young lady's attendant, is most suggestive of an unfavourable reading of the cards; while the action and expression of the lady herself, indicate deprecation of the intelligence to which she listens. The contrast between her graceful figure and attitude, and those of the gipsy-woman, is most effective; each is a foil to the other.

The arrangement of the two principal figures was, undoubtedly, a work of much study: nothing could be better than the graceful balance they show, even to the position of the arms and hands; yet all is natural. The picture is the work of a master of composition and colour.





THE MUSEUMS OF ENGLAND,
WITH
SPECIAL REFERENCE TO OBJECTS
OF ART AND ANTIQUITY.

BY LLEWELLYNN JEWITT, F.S.A., &c., &c.

THE CIRENCESTER MUSEUM.

FEW localities in England are so rich in Roman remains, or have produced so varied and beautiful an assemblage of examples of Roman Art, as the place whose Museum is selected for this month's notice; and fewer still have so well cared for its treasures. Cirencester, as the *Corinium*, or *Corinium Caester*, of the Romans, was the principal city of the *Dobuni*, and one of the most important stations in the west of the kingdom. From it branched out in various directions, five main roads, "the *Irmin Street North*, the *Irmin Street South*, the *Akeman Street*, the *Ickneild Street*, and the *Foss Way*;" from which again proceeded others, and so connected this great and important city with all the other stations in the kingdom. "So many principal roads centring in one place amply serve to show how important must have been the station to the people by whom they were made; indeed, the position of *Corinium* was such as to make it an important military post during the greater part, if not the whole, of the period of Roman occupancy of this island:



BRONZE FIGURE OF MERCURY.

it was central for consolidating and perfecting Roman power in the country of allies, whilst it was not far within that fortified line, beyond which were tribes who, even when subdued, would yet, from their fierceness, ever be somewhat troublesome." The site of Cirencester was, there can be no doubt, British; indeed, by Nennius, it is classed as the fourteenth in a list of thirty-three British towns, and it must, if not the capital of the *Dobuni*, have been one of the most important settlements in their district. On their subjugation by the Romans, it would naturally become necessary, for the purpose of holding it and of keeping the natives in subjection, to fortify and garrison it. Having Romanised the settlement, the British name of *Caer Corin*, by which the place is supposed to have been known (derived from the river Churn, or *Corin*), became in course of time converted into *Corinium*, or, as given by Ptolemy, *Corinium Dubunorum*. The present name of the place, Cirencester, is of Saxon origin.

That *Corinium* was a place of great importance under the Roman rule—filled with magnificent public buildings and with houses of the most costly character and of the highest style in decoration—is abundantly proved by numberless and remarkably fine remains which have been from time to time dug up, and by the high style of Art exhibited in many of them. The walls which formerly surrounded the place have naturally suffered much, and, indeed, been all but destroyed. Enough, however, still remains

to show that the *castrum* "was fenced by a thick wall having faced stones without, whilst its inner courses were built of rough irregular stones, firmly cemented together, and imbedded in a mass of concrete, formed of lime, sand, and gravel in nearly equal proportions. This structure was probably about 15 feet high, and from 6 to 8 feet in thickness; and against it, on the inner side, was thrown up a sloping bank of mixed earth and stones taken from the enclosed ground." This wall, which was surrounded by a fosse, was more than two miles in circumference, and enclosed about 240 acres of land.

Not far away, outside the bounds of the *castrum*, are the fine Roman amphitheatre, still in existence, and known by the name of the "Bull Ring;" "the Querns," where many interesting remains have been found; "Watermoor," where much pottery has been exhumed; and other spots where rich remains have been discovered; while within its bounds scarcely an excavation of any kind is made without the turning up of some interesting relic or other. Fortunately for Cirencester, many of the finest remains discovered within its boundaries are carefully preserved in the admirable museum of



ROMAN CINERARY URNS, ETC.

the town, to which, it is much to be desired, all future "finds" may be added. To this Museum, built at the cost of the fourth Earl Bathurst, and its contents, I now proceed to direct attention—simply premising that most of the objects there are purely local, being from Cirencester itself or from its immediate neighbourhood; and, therefore, they possess a rare and high degree of interest to the visitor and to the resident.

Among the chief treasures of the Museum are two magnificent tessellated pavements, which

were found in Dyer Street, in 1849, and are among the finest of existing examples. The larger of these was divided when perfect into nine octagonal compartments, each of which was nearly 5 feet in diameter, and divided by borders of a *guilloche* (twisted or waved bands), in which bright red and yellow *tesserae* prevailed. Within each of the octagons is a circular medallion, surrounded also by the *guilloche* and other effective borders, of a subdued colour, in which olive green and white prevail—this arrangement giving greater effect to the pictorial



ROMAN POTTERY, FIBULÆ, ETC.

subjects within each circle, an effect heightened by inner circles of black frets of various kinds in the different medallions. The central figure, apparently a Centaur, and two others, were unfortunately injured by the pressure of the foundation-wall of a dwelling-house. The four corner-medallions have held respectively the heads of *Flora*, *Pomona*, *Ceres*, and another; and the remainder had figures of *Silenus*, *Actæon*, and two others, with lesser subjects in the lozenges. The head of *Flora* has a chaplet of ruby-coloured and white flowers, intermixed with leaves; a bird, probably a swallow, is

perched upon the left shoulder, and against the right rests a flowering branch. *Silenus* is represented sitting backwards and sideways on an ass, holding a wine-vessel and the bridle in his right hand, while the left is extended and grasped a goblet. The head of *Ceres* is crowned with a chaplet of leaves, intermixed with ripe and partially-ripened corn; over her left shoulder rests a reaping-hook, and on her right are some ears of corn. *Actæon*, the hunter, is spiritedly shown at the moment when he was being changed into a stag, and was on the point of being devoured by his own dogs, two of which

are apparent; on his head are antlers. The head of Pomona has a coronet of fruits, interwoven with autumnal leaves; against her right shoulder is seen a pruning axe. The figure of Bacchus is very much injured, only the head and some other portions remaining. A Medusa's head and a dancing-girl will also be noticed. "The materials used in the manufacture of the *tesserae* appear," says Professor Church, "to have been carefully selected, and many of them obtained from a considerable distance. The white *tesserae* are from a singularly hard and pure limestone of the neighbourhood, the uppermost bed of the great oolite, the cream colour from the great oolite, the grey of the same stone altered by burning, the yellow from the oolite, the chocolate from the old red sandstone, the slate or dark colour from the limestone of the lower lias, the light and dark red and black are burnt clay, and the ruby red, glass. The last-mentioned colour is used for the flowers which adorn the head of the goddess Flora, and for the blood dropping from Actæon's wound. The glass is coloured red by suboxide of copper, but by lapse of time it has acquired a green crust of carbonate."

The design of the smaller pavement shows a central circle and four semi-circles placed at right angles, and forming the sides of the figure, while the corners are filled in with quadrants, thus enclosing four lozenge-shaped spaces. These forms are all of them brought out by the *guilloche*, and greater relief is given to the design by various dark-coloured frets. The figures contained within the included spaces represent the following subjects:—The centre is occupied by three dogs, represented as if in full chase, but the object they are pursuing cannot be ascertained. In the semi-circles appear a winged sea-dragon in active pursuit of a fish; a sea-leopard also following a fish; and a sprig of a plant with leaves. The three quadrants which remain consist of petals of some kind of flower, and a Medusa's head. The lozenges have elliptic sides, and contain heads of Neptune, with tangled sea-weeds and lobsters' claws entwined in the coronet which crowns the head, as also in the side hair and flowing beard; a flower with four heart-shaped petals, and an interlaced knot.*

The sculptured and inscribed stones in the Museum are but few. The best of these is a sepulchral stone representing a mounted soldier, with sword at his side, and a spear in his right hand, with which he is about to pierce the prostrate foe over whom he is riding, and who holds a sword in his right hand in defence. In the lower part is the inscription:—

DANNICVS · EQES · ALAE
INDIAN · TVR · ALBANI
STIP XVI · CIVES · RAVR
CVR · FVLVIVS NATALIS · IL
FLAVIVS · BITVCVS · ER · TESTAME
H · S · E

which has been thus translated:—"Dannicus, a horseman of the Indian wing of the troop of

* It may be useful here to note that a remarkably fine tessellated pavement remains *in situ* at the Barton, in Oakley Park, Cirencester, belonging to Earl Bathurst, who kindly allows it to be seen on proper application being made.

Albanus, who has served sixteen years, a citizen of Rauricum. By the care of Fulvius Natalis and Flavius Bitucus, the heirs of his last will, he is buried here."

Some interesting stone coffins will be noticed, the most striking of which is the example found in a meadow at Ampney Crucis, near a stream that divides that parish from Latton, and about a mile from the *Irmin Way*. It contained, when found, two earthenware vessels, a kind of axe of iron, and some human remains. Two others of smaller size, found in the Cattle Market, Cirencester, in 1867, are also worthy of note; as is likewise a portion of a leaden coffin.

The altars preserved are of the usual character, and do not possess any special interest. In the same case with them will be noticed what are

heads, among which is a figure of Mercury in a niche; a carved stone bearing two fish, their heads in a circle, very slightly incised; a head, in which one eye of black enamel is remaining; and several other heads, groups such (as the *Deæ Matres*), and other fragments.

In one case are preserved some highly interesting remains of wall-painting and internal decoration, from the same villa in Dyer Street in which the tessellated pavements already spoken of were found, and from other parts of the town. The patterns are generally simple, consisting of lines and bands of colour, and, except in one or two instances, almost devoid of ornamental design; but "the colours are good, a rich red and an excellent marone being favourite tints. Some conventional foliage was observed on the plaster of the walls of the Dyer Street villa, but

it was not found possible to preserve it. In more recent excavations (1868) in Mr. D. Smith's garden, in the New Road, a fragment of this kind of ornament was obtained, and is now in the Museum. At the same time and place many other Roman remains were uncovered. Among these, a fragment of wall-painting, with the following "squared" words scratched through the surface colour, was found:—

ROTAS
OPERA
TENET
AREPO
SATOR

This interesting fragment is preserved in the Museum, as are also some "pieces of coloured wall-plaster, found, with fragmentary pavements, &c., behind Cripps's Brewery in Cricklade Street." From the same street have, more recently still, been secured some further examples of ornamental wall-painting, which were discovered with the bronze umbo (boss) of a shield, several Roman coins, and an enamelled *fibula*.

As may naturally be expected where so many remains of houses and public buildings, with their tessellated floors and their hypocausts, &c., have been brought to light, very many flue, bonding, roofing, flooring, and other tiles have been preserved in this Museum. Among these are several inscribed examples, some with the letters in relief, others sunk: on some of these the name ARVERI occurs, while IHS and other initials and marks occur on others. There are also a large number of hollow flue tiles and square flat tiles of various sizes, which have been re-arranged in the Museum close

TESSELLATED PAVEMENT—HEAD OF FLORA.

to one of the pavements, as the Romans employed them in their hypocausts, or hollow floors, for heating rooms and baths. These tiles were used both for the support of the floors in the Roman houses, and for the conveyance of heated air beneath them. Specimens of flanged roofing, bonding, and other tiles will also be noticed. The plain tiles previously referred to as used in the construction of floors are well represented in the collection. The hollow open flue tiles from Dyer Street are 19 inches in length by 7 in breadth, and 5½ in thickness. Of the flat square tiles there are three common sizes—namely, 7½ inches square, 12 inches square, and 18 inches square. Some of the tiles show impressions of the feet of various animals which had walked over the clay when wet. There are also preserved a mass of burnt

said to be catapult, or sling, stones, but which Professor Church considers to "have been used by the Romans in their game of ball: they fit nicely to the hand, and resemble Pompeian specimens."

The examples of carvings from the ancient public and other buildings of Corinium, preserved in the Museum, are highly interesting, as showing the extent and magnificence of the place during Roman times. Among these are portions of pillars of large size, as well as about a score of bases of columns, some of which are beautifully moulded. There are also some half dozen good Corinthian capitals, and a cluster of three capitals carved in one block. "Two corner stones, one a corner piece, also demand attention as being very bold in design." There are also some interesting carved figures and

to one of the pavements, as the Romans employed them in their hypocausts, or hollow floors, for heating rooms and baths. These tiles were used both for the support of the floors in the Roman houses, and for the conveyance of heated air beneath them. Specimens of flanged roofing, bonding, and other tiles will also be noticed. The plain tiles previously referred to as used in the construction of floors are well represented in the collection. The hollow open flue tiles from Dyer Street are 19 inches in length by 7 in breadth, and 5½ in thickness. Of the flat square tiles there are three common sizes—namely, 7½ inches square, 12 inches square, and 18 inches square. Some of the tiles show impressions of the feet of various animals which had walked over the clay when wet. There are also preserved a mass of burnt

brick concrete, from a floor in the Roman Villa, Dyer Street, and a piece of concrete, with imbedded red *tesserae*.

The articles of bronze in the Museum are many, and they are very varied in their character and uses. Among them are some specially deserving of note. One of these is a perfect steelyard, or balance, which is admitted to be the finest ever found in this kingdom. It was discovered at Watermoor, in 1855, and has a double fulcrum (exactly corresponding in construction with our modern double-action steelyard), so that it could easily be adjusted for lighter or heavier articles. It is rather more than 6 inches in length, its leaden counterpoise weighing 3,240 grains. And the beam of a balance, 14 inches in length, having a central fulcrum, has a hole at one end for suspending a pan, and on one face of the beam are a number of inlaid dots of silver, which originally served to divide one of the arms into twelve, and the other into twenty-four equal parts. A variety of steelyard weights will also be noticed; two of these are in form of heads, and are of the respective weights of 417 and 419 grains. The heads are well formed and highly interesting, as are also other weights of various kinds.

Bronze compasses, nail instruments, *strigils* (scrapers), tweezers, hair-pins, bodkins, keys, spoons, and many other objects of domestic and personal use, are abundant in the collection. Some of these we engrave: one of the pins has its head ornamented with red enamel, and other objects are variously decorated. Of the *stylus* are some good examples, both in bronze and in iron. Portions of a bronze *speculum*, of strap-mounts, and other relics, also deserve examination.

One of the best bronze statuettes is a figure of Mercury, found in the Leases, or nursery-grounds, Cirencester. In it the god is represented having in his right hand a pouch or purse, and in his left he has probably held a *caduceus*. Other statuettes also appear in the same case, where likewise a beautiful bronze chain, of the most delicate fretwork, will be found worth examining.

Of *armillee* about a score of examples are contained in the Museum, some of which are of twisted form, and others more or less ornamented. There are also a number of *fibulae* of the usual Roman forms. Some of these have the characteristic twisted wire spring and fastening; others are cruciform, with projecting knobs; and others, again, are of circular and other forms.

Good examples of objects in iron are preserved in the Museum, and, thanks to the skill of Professor Church, to whom their discovery is due, they are preserved from further corrosion by being soaked in pure white solid paraffin at 212° Fahrenheit. In the series may be seen Roman knives, keys—one of which from Preston, a mile from Cirencester, has a long oval looped handle—very fine padlocks, and shears; tools, hammers, and picks; heads of javelins, spears, and arrows; bits, shoes, harness-mounts, and other horse and chariot gear: *stylis* for writing; the hasps of doors, nails of all shapes and sizes, together with many kinds of tools and mechanical implements. Very noteworthy is a large hanging-lamp, as well as a fine example of a chain, and an unfinished sword from Bourton-on-the-Water. Among the knives, one has a hole and ring for suspension, and another retains its original handle of horn. One pair of horse-shoes, from Beckhampton, are of remarkably fine workmanship, the undulatory edge, and

the six large nail-holes, being unmistakably characteristic of the Roman period.

Two very fine iron umbones of shields, of the Anglo-Saxon period, are worthy of note, as is a fine circular one of bronze, of the Romano-British period, to which traces of wood and hide are still attached; it was found in 1870, about 8 feet below the surface in a Roman villa, with other objects of the period.

Of pottery, the Cirencester Museum contains an extensive collection of examples, embracing Samian as well as imitation Samian, and all the usual varieties of Romano-British pottery, including Castor, Upchurch, Salopian, and other wares. In Samian the collection presents speci-

good examples of beads, some of which are specially worthy of note, on account of the beautiful workmanship of the glass and its colour; and fragments of a glass bowl and of window-glass.

Several *querns*, or hand-mills, are contained in the collection, and are, for the most part, of the usual character. In the lower stone of one are five holes, still, in part, containing the lead with which the iron fixing-rods had been held in their places. Many of the stones were originally about fifteen inches in diameter; one, however, is only ten inches, while another, now broken, must originally have been more than twenty.

Some of the *querns*, and fragments of *querns*, are made of a porous felspathic lava from Andernach, on the Rhine, others of sandstone, and of siliceous conglomerates. Several excellent examples of hone-stones are also preserved.

Many good bone instruments—hair-pins, pins, bodkins, needles, spoons, *spatulae*, &c.—will be noticed, as will also several counters, a portion of an armet, with other perforated and carved objects, and also some objects in jet. The collection of coins is not extensive, most of the best specimens found in the locality being, unfortunately, in private hands. Those contained in one of the cases—the best preserved of which are carefully labelled—are principally from Latton, near Cirencester. They were found during drainage operations in 1864, in the bed of the river Churn, at a point where that river divides the parishes of Cricklade, St. Sampson, and Latton; it would appear a ford must have existed there very many centuries ago. The coins were widely scattered, and extend over a long period of time.

It is well also to note that in the museum are several skulls, of the Romano-British period, found in and around *Corinium*, with Roman remains. One of these belongs to a complete skeleton, discovered in 1866, with six other skeletons, near the Barton, in Oakley Park, along with Roman coins, implements, and personal ornaments.

Having now briefly glanced at some of the more interesting objects contained in this most valuable and important Museum, it only remains for me to add that few towns have shown such an admirable and praiseworthy spirit in the preservation and illustration of its antiquities as Cirencester has done. In "preservation," it has a Museum that would be a credit to any town, in which many of its early Art-treasures are carefully garnered and made available for study and research; but beyond this it has private individuals who have, with religious care, guarded such remains as have been exhumed on their grounds, and who show a laudable anxiety to prevent their spoliation. In "illustration" it has been truly fortunate in having two such men as

Professor Buckman and Mr. C. H. Newmarch to devote their artistic and literary talents in giving to the world, in their admirable volume on "Remains of Roman Art in Cirencester,"* so excellent an account, not only of the place itself, but of the various relics which have been brought to light on its site; and in having, as the Hon. Curator of the Museum, so talented and so energetic a scientific man as Professor A. H. Church, to whom I am indebted for assistance in the preparation of this notice.

* From this admirable, and most useful book, the illustrations to this account of the Cirencester Museum, are, through the kindness of Mr. E. Bailey, allowed to be taken.



TESSELLATED PAVEMENT—HEAD OF POMONA.

mens of bowls, cups, *patera*, and other vessels; some of which are richly ornamented with groups, figures, and foliage, in relief; and one fragmentary example is particularly curious, as having its ornamentation incised into the soft paste. Many very fine and interesting cinerary urns will be noticed, as will also *mortaria*, jugs, urns, colanders, crucibles, and other vessels. A considerable number of potters' marks are preserved, both in Samian ware, and on the handles of *amphorae*, &c. Of urns enclosed in hollowed stones several examples have been, at one time or other, found at Cirencester. The vessels



BRONZE NAIL INSTRUMENT.

found in the Latton stone-coffin also deserve attention, as do those from the site of the new Cattle Market.

The glass objects in the Museum are not very many in number, but they embrace some remarkably good specimens; among them some beads, and an *unguentarium*, discovered in 1867 in a stone-coffin in the Cattle Market, are particularly good examples of their kind. Among the more interesting of the glass objects are buttons and counters, probably used in games, both of dark and light coloured imperfect glass-frit; fragments of bottles, found at the Querns, near Cirencester, one of which is a very interesting specimen of moulded or stamped glass; a fragment of a bowl, showing the ornament known as pillar-moulding; with very fine and

It may be well to add, for the information of the visitor to Cirencester; that Professor Church owns a highly-interesting Ceramic Mu-

seum, which contains many remarkably fine examples of early, mediæval, and other pottery, and of most of the more famous makes of



ROMAN POTTERY, ANGLO-SAXON UMEONES OF SHIELDS, ETC.

English earthenware. This collection may, through the courtesy of the Professor, be seen

under certain restrictions, upon proper application being made.



TWEEZERS, ETC.



NAIL INSTRUMENT.

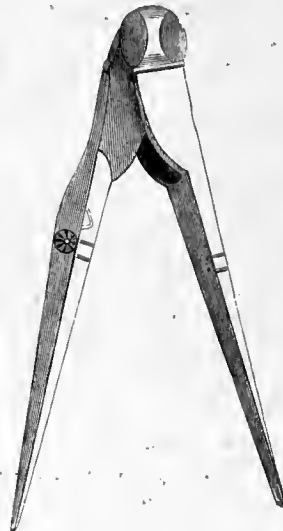

BRONZE COMPASSES.

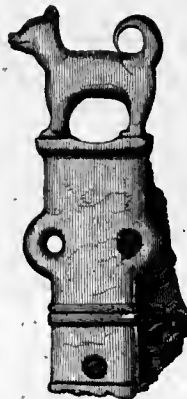

BRONZE HANDLE.

It is much to be desired that many examples of Roman Art found at Cirencester, which are now lying in private hands in the place, may

find their way ere long into the Cirencester Museum, where they will be much more securely provided for, and rendered more available for

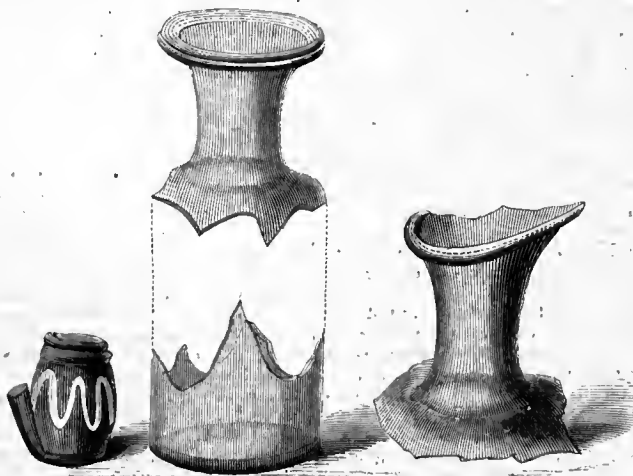

ROMAN GLASS VESSELS.

antiquarian and historical purposes than they are in their present location. In private hands, however carefully they are guarded, and how-

ever liberally access to them is given, they lose one half their value to the historian and antiquarian from their isolated position.

SELECTED PICTURES.

FROM THE PICTURE IN THE POSSESSION OF THE PUBLISHERS.

A BY-PATH TO CHAMOUNI.

J. W. Inchbold, Painter. T. A. Prior, Engraver.

MR. INCHBOLD is a painter whose works are very rarely to be met with in our public exhibition-galleries: we have no recollection of seeing a dozen of his pictures since we first heard of his name—in 1854, when he sent to the British Institution what he called 'A Study—The Common Grass.' Yet he is not one likely to be passed over in any gallery; if for no other reason that his works present a peculiarity which can scarcely fail to attract, whatever opinion, favourable or otherwise, may be formed of them. He appears to have started on his career a determined Pre-Raphaelite, and has adhered to his principles with little or no modification. In this character he won praise from Mr. Ruskin, in 1856, whose "Notes on the Academy," of that year, commended the two pictures exhibited by Mr. Inchbold for their uncompromising truth of nature. It is this quality, carried to the extremest limits of detail, which gains for him the suffrages of those who admire work that almost requires the aid of a microscope for its examination.

The picture we have here engraved is no exception to the artist's usual method, though its peculiarities are scarcely, if at all, visible in the admirable engraving by Mr. Prior, who assured us that he found it a "most difficult subject" to transfer to the steel, so full is it of beautiful detail, and so varied in colour not easily transferable into black and white. By uniting, however, the scattered parts into masses, and by judicious management of light and shade, he has produced a very effective yet delicate plate, preserving the *minutiae* of the painter's handling while combining the materials of the subject into a harmonious whole.

The picture was painted on the spot, during the residence of the artist several months, at what he told us was "a little beef-less *auberge*," near Sallanche; it is from the heights above the village that the sketch was taken. The snow-tipped hills in the distance are those of Chamouni, the nearer hill is that of St. Jervais. The mass of trees crossing the picture consists of walnuts, then stripped of their fruit, it being autumn-time; and the more immediate foreground is composed of all that luxurious material which, if not peculiar to the villages of Savoy, renders them most attractive and picturesque;—vines covered with the purple grape, apple-orchards with yet ungathered fruit; and Indian corn half concealing the singularly-formed *châlets* of the mountain-village. Out of this wealth of subject the artist has constructed a most attractive landscape, bearing on its face no appearance of a composition made up in the studio, but a veritable representation of nature in one of her grand and beautiful aspects. Assuming, as we are warranted in doing, that the artist shows us here what he actually saw, and nothing more, it would be almost impossible to find a spot anywhere, of the same character of scenery, that offers such a combination of what may be termed "material ready to hand," as this view: every portion of it comes into its proper pictorial place; the lines converging symmetrically where they meet; while the rich foliage of the foreground and the cottages of the peasantry, contrast, both in colour and in their home-associations, with the breadth of uncultivated region lying beyond.



A RY PATH TO CHAM. H.

FROM THE COLLECTION OF THE NATIONAL MUSEUM



INTERNATIONAL EXHIBITION
AT VIENNA.

THE announcement of the plan of the International Exhibition to be held at Vienna, in 1873, is perhaps the most encyclopædic document that has ever been officially published. The Arch-Duke Reigrier, in his speech at the inaugural meeting, held in the hall of the Imperial Academy of Science, on the 17th of September, paid a just and worthy tribute to the memory of the father of International Exhibitions, the Prince Consort of England. How much the Imperial Commissioners are indebted to the experience of 1851 and succeeding years, it would be difficult to tell. But they have made the most of that experience, and the scheme they now bring forward is at once so comprehensive and so well arranged as to contrast very favourably with the present state of our own classification of the aims and objects of a great exhibition.

That arrangement, as set forth in the Illustrated Catalogue of the Exhibition of 1862, consists of thirty-six classes. We should, perhaps, be wrong in speaking of these classes as marked out entirely at haphazard. Yet when we find an equal rank given to civil engineering, including sanitary constructions and objects shown for their architectural beauty, and to dressing-cases, despatch-boxes, and travelling-cases, it becomes obvious that anything like a masterly grasp and proportionate distribution, of the great branches of productive industry is altogether absent from the programme of our own titled and ornamental commissioners.

For our—there is no other word than higgledy-piggledy—mob of thirty-six classes, the Austrian commission has substituted an intelligible and excellent arrangement of twenty-six groups of objects to be exhibited. The first of these coincides with the first Class of 1862, being illustrative of mining and metallurgy. For the second, which might well have been the first, of the Austrian groups we have no counterpart, notwithstanding the evident unity and immense importance of the group. It comprises Agriculture and Forestry. Chemical industry follows, corresponding to Class II. in the English catalogue. Articles of food as industrial products form the fourth group, the title being much more definite and appropriate than that of our Class III., substances used for food. Textile industry and clothing forms Group No. VI., succeeded by industries in leather and india-rubber, metal, wood, stone, earthenware and glass, hardware, and paper. These seven groups, as to which we only have to question the ranking of work in stone together with ceramic and crystalline industries, consist of objects scattered through Classes IV., XVIII., XIX., XX., XXI., XXII., XXIII., XXIV., XXV., XXVI., XXVII., XXVIII., XXX., XXXI., XXXII., XXXIII., XXXIV., XXXV., and XXXVI., in the English catalogue. Graphical arts and industrial drawings form Group XII. There is no corresponding class with us, Machinery and means of transport constitute Group XIII. The equivalent English classes are (V.) Railway plant; (VI.) Carriages not connected with rail or tram roads; (VII.) Manufacturing machines and tools; (VIII.) Machinery in general; (IX.) Agriculture and horticultural machines and implements. Groups XIV. and XV. consist of scientific instruments and nautical instruments, a less obvious division than we have heretofore encountered. The English classes are (XIII.) Philosophical instruments, and processes depending on their use; (XV.) Horological instruments; (XVI.) Musical instruments (which it is not so easy to see provided for by the Vienna programme); (XVII.) Surgical instruments and appliances. Military accoutrements form Group XVI., corresponding to Class XI. Maritime objects form Group XVII., corresponding, to some extent, to Class XII., Naval architecture—ship's tackle. Group XVIII. contains architectural and engineering objects, corresponding to Class X. but wider in its comprehensiveness. We have now exhausted the English list, with the exception of two classes, viz., Photographic apparatus

and photography, which will probably form a section of Group XII.; and educational works and appliances, a valuable and important subject, which is fully dealt with in Group No. XXVI. of the Exhibition at Vienna. On the other hand we have the following seven groups, which are not matters of special recognition with us. XIX., Cottage-houses, their interior arrangements and decorations; and XX., Peasant-houses, with their implements and arrangements. It might appear at first as if these two groups were but sections of Group XVIII., as, no doubt, they theoretically are. But the reason of ranking them under distinct heads is, that it is intended to illustrate the actual domestic life of different nations by *fac-similes* of their habitations. Then follows a special group, to illustrate national domestic industry, designed to display the abundance of valuable sources from which its productions can be drawn. Group XXII. again embodies a new idea; it is that of the representation of the operation of museums of Art and Industry. The object is to exhibit the character of the influence exerted on the improvement of artistic taste and culture by these institutions. XXIII. is a group devoted to Ecclesiastical Art—not meaning theology, but objects produced by Art and Industry for ecclesiastical ornament. No. XXIV. is an historical or archaeological group, composed of objects of the Art and Industry of former times, exhibited by amateurs and collectors. No. XXV. Group is to illustrate contemporary plastic Art, the objects all to be of date posterior to 1851. To No. XXVI., the group of objects of education, we referred above as being parallel to the English Class, No. XXIX.

A programme for a Universal Exhibition, drawn up by a competent hand, would form a skeleton map of human industry; and the descent, step by step, into the details of each branch would present, in itself, the outline of a broad educational course. Something of this high human philosophy—the philosophy of industry—characterises the announcement we have above attempted to analyse. The heads of the Illustrated Catalogue of the Exhibition of 1862, on the other hand, might be thought to have been suggested to the secretary of the English Commissioners by a walk down Regent Street. As the gauge of the English Railways was determined by the fact of Stephenson applying his two-foot rule to ascertain the width between the wheels of a mail-coach, so may the thirty-six industrial classes have been arrived at by writing down the names of the trades exercised in the successive shops, omitting duplicates, except in the famous instance of Class XXXVI., dressing-cases and despatch-boxes.

But we have not yet exhausted the programme of the Austrian commissioners, or explained its full title to the term "encyclopædic." In truth, the scheme they have prepared amounts to a true theory of human industry. The past is to be illustrated, as well as the present; and by a broad historic treatment of the progress of industry, as well as by a display of its present condition, we are to be enabled to cast a glance towards the future.

The gradual improvement of machinery and industrial processes, and the influence due to successive inventions, are to be illustrated by the juxtaposition of the apparatus of different eras. Hand-work and machine-work will be displayed side by side. This chapter of the Exhibition will illustrate the history of invention.

A separate department will be allotted to the exhibition of the secondary products of manufacture—that is to say, to what was formerly, or is still, regarded as waste. Some of our most valued products are thus arrived at. Indeed, the analysis of waste, from the first happy experiment of Cavendish in weighing the ashes that proved to have become heavier, instead of lighter, than the original combustible, has been the very life of chemical discovery. This section will illustrate the history of industrial economy, as far as regards material.

In like manner will be formed collections to illustrate the history of trades, and the history of prices, as well as to illustrate the actual condition and requirements of commerce. A separate department will tabulate the results thus obtained, and will present them to the observer in

a graphic form. The area of land cultivated and uncultivated, the progress of agriculture, the increase of population, the interest on money, and similar subjects, will come under this section. We venture to suggest the preparation of a table showing graphically the increase of public debt, and that of military expenditure, since the year 1788; and we think that this would not be the least instructive of the diagrams prepared to teach the world.

Further, it is intended to organize a series of experiments, lectures, and discussions, so as to render better known various modes of manufacture, a subject so wide, and so vast, as to demand an exhibition for itself. We think the Austrian government can have but little idea of the fertility of the class of inventors, in speech no less than in mechanical adaptation. To establish an *annexe* of this kind is like throwing all the judicial procedure of a country into the balance of affairs, to be conducted by an over-taxed minister of public works.

We have not yet done. Temporary exhibitions are to be cared for. Living animals and dead game, fish, poultry, fruit, flowers, bread, cheese, milk, wine, all these things are to be allowed to compete. A cat-show is not mentioned, but may come under the general terms. International congresses of learned men are to be held for the discussion of industrial questions. International races will be arranged, national sports will be represented. Finally, the arrangement of the Exhibition is to be, as far as possible, on a geographical plan—that is to say—in the fashion of a map.

Paying that respect which we think due to the masterly division of the great subject of Industrial Art, and to a simple and exhaustive division which shows that our own attempts in that line have been pure confusion, we yet cannot but think that too much is here attempted. To crowd into the four or five months for which an exhibition is ordinarily open, or even into a single year, such diverse and wide-spread operations, is, we fear, impossible, with any chance of success. With all the division and organisation of labour of which our German brethren are capable, it must be borne in mind that the value of an exhibition of this nature must depend in a great degree on the capacity, vigour, and unity of its execution. All the branches of the great inquiry must come under the review of one or two directing minds. Now the disturbance of attention that would be caused by the competing claims of Exhibitions proper; Olympic games, flower-shows, and exhibitions of animals; and discussions of the merits of inventions, or other great industrial questions; will be such that no one will be able to do justice, even in the most cursory manner, to such an enormous field of inquiry. An attempt of the kind is better let alone than undertaken without a reasonable probability of success. The work of successive years is here piled together to be discharged in a few months. And when to all this is added the action of the international juries, the competition for prizes, and the award of different diplomas of merit, we fear lest, unless the main features of the plan be distributed over a longer time, in the attempt to raise an unrivalled structure in honour and in advancement of human industry—a tower whose top may reach unto heaven, it may not prove that the projectors will so confound their language—that they may not understand one another's speech.

FOREIGN ART-LITERATURE.

FRANCE.

WITH wonderful elasticity the Art-literature of France is again blossoming in monthly serials. No. 551 of the *Histoire des Peintres de toutes les Écoles, depuis la Renaissance jusqu'à nos Jours*, contains the life of Hans Burghmaer, an artist of the *École Allemande*, who lived from 1472 to 1559. The sketch in type is illustrated by a good portrait of the artist. Then we have an engraving of a very characteristic family-scene in not only high, but the highest possible, life. The Emperor Maximilian and his wife are the august persons represented. The empress

is seated in an attitude of respectful attention. The emperor, also seated, appears to be holding forth at some length, and his dutiful consort is—we are privately of opinion—intensely bored. Other figures in the background tell of the costume and manners of the time. Another engraving represents the painter and his wife; and the fourth is taken from a water-colour drawing, representing a German tournament of the sixteenth century. The globular barred fronts of the helmets, and the size of the crests and mantlets, render the scene a very valuable contribution to the history of armour.

The History of Ceramic Art is another work by the same editor as the last, also issued in serial numbers. In No. 65 we have the representation of some very curious Assyrian pottery, ascribed to the seventh century before the Christian era. There is a statuette, about 9 inches high, of most archaic proportions, but marked with much vigour of pose and expression. Deity or king, whichever it may be, it wears an enormous shock of hair, very closely resembling the perukes of the later part of the reign of Louis XIV. There are also a hermetic statuette, a very curious figure with a bird's head, but altogether unlike the Egyptian Ibis-headed and hawk-headed genii; a ram, in a yellowish *terracotta*; and a footed, egg-shaped vase, with incised pattern, of very elegant form.

Another number of the same periodical illustrates Italian sculpture. There is a cockleshell, 6 inches in diameter, supported on three *griffes*, on which is painted a spirited figure of Neptune. It is of Angrano ware, and coloured in pale tints of green, yellow, blue, and *gris brun*, upon a white ground. A saucer and a dish, of elegant forms, accompany this shell, the former being adorned by a coat of arms suspended in front of a landscape—a rather barbarous style of ornament. The plates are "*phototypiques inalterables*," a sort of inferior autotype we should pronounce them to be. It is curious to see the editors of illustrated works content themselves with the grimy shadowings of the silver photographs, which must be costly, and require mounting, when they might avail themselves of the cheap, clear, and unmounted prints effected by the heliotype process.

In *L'Art pour Tous* we have four pages of engravings, printed very sensibly on one side of the paper alone, with short explanatory notes in French, German, and English. In Nos. 258, 259, we have an elevation of the clock of the *Palais de Justice* at Paris. Two statues at the sides, Jurisprudence and Executive Law we take them to be, originally executed by Germain Pilon in 1585, have been replaced by Toussant. Then we have a plate of costumes, representing the secret council of Venice; some bold ornamental casques, in embossed and gilt steel; and a very curious fountain, or rather washhandstand, in forged and gilt iron. This is said to be Venetian work, but it contains, in a sort of pierced flag, a German cavalier fully equipped. A globe contains the water; a little naked nymph is the handle of the tap. The bronze basin beneath is supported on a tripod. Altogether, this is a most interesting piece of iron-work. A Japanese dish is wonderful for the expression of the flight of birds that cross the scene; and a very admirable specimen of cabinet-work is an eighteenth-century bed, beneath a carved alcove. A plate of costumes of the year 1580 closes the number.

GERMANY.

From Germany we have an edition of Schiller's famous *Lied von der Glocke*, or "Song of the Bell," which need not shun comparison even with the exquisite outline illustrations by Moritz Retsch. The twelve illustrations are by A. Müller and Carl Jäger. They are silver photographs, mounted; and represent the delicate shades and touches of the original with great beauty. The scenes are, of course, as prescribed by the process of the Bell Foundry, those with which we are most of us familiar from the designs of Retsch. The first, *Glockenweihe*, which we should have once called the Baptism of the Bell, is by Jäger, full of religious sentiment and picturesque detail. Then come those scenes, by Müller, wherein we recognise the most poetical rendering of those domestic virtues and hopes, of

which it must be acknowledged the Teutonic races afford the finest examples. In *Abschied*, the Departure, the lad goes forth to the battle of life, leaving, together with his father and mother, a girl who in the next scene—*Heimkehr*, the Return—has grown into maidenly beauty. In the next scene, by Jäger, we are shown the *Liebes Frühling*, or Love's Spring; and in the sixth print, again by Müller—*Huldigung*—the youth opens his story by the presentation of a bouquet. *Liebesglück* represents one of those perfectly tranquil scenes of love-making, which in our island we are accustomed to limit to the honeymoon. Then comes the Decking of the Bride, by Jäger, and the arrival of the bridegroom to lead her to church, by Müller. From that incident we pass at a bound to the home of the mother, still comely, though no longer young, with her girls grown up to her shoulders; and, hanging behind her chair, perfectly *en évidence*, an honest birchen-rod, which the exuberant frolic of her noble boys may at times render useful. Two or three of Retsch's scenes are now omitted, and the series concludes with the *Feuer* scene, or conflagration, and an *Erntefest*, or harvest-home, by Müller. This exquisite little gift-book is published by F. Brackmans.

THE HILDESHEIM "FIND."—The reproduction by Messrs Christoffe & Co., of Paris, of the beautiful specimens of ancient silver-work which were found at Hildesheim, in Hanover, in 1868, merits more detailed notice than we have room, this month, to give. The entire series consists of thirty pieces, of various degrees of excellence, but all of extreme interest. The large bell-shaped vase in which some of the minor articles were contained, appears to be a Roman copy of a Greek design. The grace of the arabesques, and the beauty and vigour of the tiny Cupids engaged in an internecine war with the active little *poulpe*, or cuttle-fish, that casts a cloud of silk behind him, on the least alarm, to baffle his pursuers, on the coasts of Greece, Italy, and Southern France, are of undoubted Greek origin. The poverty of design evinced by the repetition of identically the same pattern on the two sides of the vase, is no less clearly Roman. We hope to have an opportunity of giving further details on the subject.

GOthic HUMOURS.—Burlesque is not Art. Yet the grim, quaint, altogether distorted, little figures in which the Gothic artist indulges his humours are ruled by laws of their own, and are certainly within the range of a powerful and peculiar style of Art. It is curious to see how Italian designers, educated in the presence of the beautiful, fail, always and utterly, in caricature. With the German, caricature is at home—not as mere exaggeration, but as truth regarded from some impossible point of view. We are invaded by a herd of little German pictures, each telling a story without words, which are, one may almost say, contemptible as drawings, but contagiously and irresistibly ludicrous. Take the story of the hat. A *Bursch* is arrested before the window of a hatter by the shining objects of his admiration. His own cap is a study in itself. Then follows a colloquy with the hatter. You see the man of felt eloquent on the excellence of his wares—the incomer can do nothing but buy. Out he sallies, in pride and glory, quite another man in attitude, with a cane jauntily swinging, and a red silk handkerchief, faithful to him throughout, protruding from his tail-pocket. Anon he stretches out the back of a very large hand with a considering look. You foresee rain! Then it comes, and comes in earnest. Away rushes the newly-hatted man, with a handkerchief over his head. Then you see him seated beneath a tree, a smile of satisfaction on his face, and the hat safe beneath his legs. A flash of lightning strikes the tree, reverses the German, and, unfortunately, does so on the hat. In the next scene he devoutly expresses gratitude for life and limb saved. The hat works like an accordion. Finally he goes slowly home, not altogether miserable, but with a sort of Chinese lantern on his head. The point of the matter is, that the whole series represents a succession of those incidents and alarms common to us all, which are all felt much more keenly than could be expected, but which we are also ashamed to confess.

ART IN CONTINENTAL STATES.

PARIS.—The Louvre is gradually reclaiming its order, after its double peril of Prussian *obus* and Communist conflagration. Its greatest pictorial treasure has been restored from the Arsenal of Brest, and is again given to public inspection in the old saloons. So also, in its two noblest halls of statuary are found ranged, as of old, its matchless masterpieces of the Grecian chisel. It is a remarkable incident, that all the sculptures of this invaluable collection, with the exception alone of the Milo Venus, remained here, in their sanctuary, whatever evils the times portended. They have not been injured even to a chip. Knowing, as all do now, to what an extent the destructive element existed in the projects of Communism, it seems beyond doubt, that had Paris been within its grasp for but a few days more, all these precious marbles would have been "sledged" into a heap of dust and fragments. By fire they could not conveniently have been "commuted" and destroyed; inasmuch as there was no fuel at hand in these ground-floor halls—the arched roofs, walls, and flooring of stone or marble slabs. Happily the prompt concentrated progression of Mac Mahon's divisions put a timely *veto* upon any such catastrophe.

The special object of interest in this restored sculpture museum, is, beyond doubt, (*place aux dames*), the famous Milo Venus. A train of devotees haunt her secluded pavilion from morn to dewy eve—to be assured that she is actually safe—to dwell on her general grandeur of loveliness, and analyse it throughout its wondrous detail. A curious incident has given rise, at this moment, to a very delicate artistic question in reference to this statue, which has been the subject of a gracefully critical notice, by M. About, in the *Artiste*,—and which has, indeed, been made the subject of a reference to *L'Institut*, on the part of M. Ravaissou, the much esteemed guardian of antique sculpture. It appears then, strange to say, that the statue does not stand erect in the correct line of *pose*, which, according to the strict rule of Greek Art, founded, in truth, upon the law of nature, should descend from the hollow of the throat, to the ankle bone of the foot, upon which the weight of the figure falls. In this case, the line in question would fall abnormally outward to the point of the toe. This was assuredly no solecism in the work originally, but was caused in the following manner. To reveal the secrets of the sculptor, the statue is not formed out of one continuous block of marble, but of two. These were made to join most felicitously, where the drapery commences to fall from the upper nude half of the figure. The union was thus rendered imperceptible. It was made to be as close and enduring as might be, by two strong iron internal clamps. The expansion of this metal had, however, in the course of time, an opposite effect, and the two blocks of marble became severed. This gave an opportunity, at what precise time seems uncertain, for the proceeding to be effected by which the illegitimate change was completed. The upper half of the figure was then bent forward, and so retained by the insertion of two small blocks of wood, which were rendered imperceptible by the introduction of a slender surrounding layer of the finest plaster. M. About does not hesitate to style this transgression a Frenchification in the sense of improvement—it appearing that a finer taste imparting to the statue a graceful bend (something akin to the present *à-la-mode* lunatic *pose* outward of the bust, in the Parisiennes of these days of grace) has a palpable advantage over the rigid, upright original of the Phidian creator. The question is, however, now brought to an issue, and the result will be looked for in the world of Art with unusual interest. M. Ravaissou has, it seems, caused to be prepared two mouldings from the statue; the one after the Greek, the other after the antagonistic suggestion. These will enable a sound judgment to be more easily attained. This question, touching the improvement of a Greek masterpiece, will give, it is anticipated, new life to an old discussion, respecting the probable attitudes of the two lost arms of the statue. The severance of these has been wrought at so high a

point towards each shoulder, as to render the query quite a riddle. One party maintains that this Venus formed one of a group, and that her left hand pressed on the shoulder of Mars, against whom she gently reclined. The opponent theorist has it that this was but another version of the 'Brescia Victory,' in which the right hand is engaged in inscribing a memorial upon the face of a shield, which is sustained for that purpose, by the left arm. It is surely surprising that some copy of this glorious work has not been found amidst the myriads, one might say, of miniature statuettes, which have been rescued from oblivion, and are to be found in all the great museums of Europe. However, what with the one cause of critical contest and the other, it must be anticipated that a civil strife impends over Paris greatly in contrast with that inordinately uncivil one, which has recently passed away, leaving such foul wrecks behind.

Chantilly and the Duke D'Aumale.—The duke, being once again master, of this celebrated *château*, and the clouds, which have lowered above the house of Orleans for so long a period, having been considerably dissipated, seems determined to restore it to much of its former splendour of embellishments. Of these, the most remarkable were the war-illustrations, by Lecomte, which represented the most striking incidents of one of the great Condé's campaigns. These imposing works have had their own campaign of perilous misadventures. Before the menacing revolution of 1789, they had to beat a precipitate retreat, and they disappeared from the sight of friend and foe. In subsequent and better days they were discovered secluded in the roof-lofts of the *Invalides*, and they resumed their old places. The Duke D'Aumale then became their guardian, but, on the Napoleonic restoration and Imperial revolution of 1852, a second disaster befell them; for the duke was compelled to sell his interest in the *château*. He accomplished an exploit on the occasion, and, in his retreat, succeeded in carrying off the *opima spolia* of Lecomte's masterpieces. The Duke is rewarded, and in the roll of events, resuming the occupancy of the regal *château*, he will have the satisfaction of restoring the pictorial records of the great Condé to the walls of the *Galerie des Batailles*. It was this charming Chantilly which, as most of our readers know, drew from the said *Grand Condé* his prompt and most felicitous *bon mot* in reply to Louis XIV., who—fascinated with the place in all its attractiveness, including its range of stables, still existing, and then considered the most princely in Christendom—requested the prince to transfer its ownership to him. "Sire," he replied, "all that your Majesty desires I concede; from the moment you wish it, the place is yours. I have but one favour to beg in return—it is—to be made its *concierge*."—"I understand you, my cousin," replied the king; "Chantilly shall never be mine."

M. Rothschild, an eminent publisher, in Paris, of illustrated books, has in the press a work on the famous Trajan Column, in Rome, of which casts were taken, in 1862, by the Emperor Louis Napoleon; these casts were forwarded to the Louvre, and there galvanised. They are to be reproduced, by the phototypographic process, and will form a series of 220 coloured plates, with many hundred woodcuts. The descriptive letterpress is to be supplied by M. Frohner, Conservator of the Louvre; the work will be published in parts, which it is calculated may extend to as many as one hundred. Only 200 copies are to be printed, and then the plates will be destroyed. The book cannot fail to be of great interest and value to others besides the mere archæologist.

CALCUTTA.—An exhibition of Fine Art, to include paintings, sculptures, drawings, &c., is to be held in this city in December.

DRESDEN.—The "Holbein Exhibition," which was opened some time since, attracted a large number of visitors to this city. It is well known that Windsor Castle and Hampton Court contain many examples of this famous old master, and the Queen's collection contributed numerous pictures to the exhibition. Private galleries on the Continent also furnished supplies on a liberal scale. We hope to give a detailed notice at an early period.

INTERNATIONAL EXHIBITION. SCULPTURE.

OPPORTUNITIES are rare of considering comparatively such an extensive and variously-mixed collection of sculpture as has been displayed at the International Exhibition. The catalogue numbered 300 works, of which 190 were British. The other nationalities represented more or less perfectly were Italy, France, Belgium, Bavaria, and Austria with Hungary. Among the foreign sculptures are marvellous examples of masterly power; but some of the best conceptions which were well worthy of careful finish, are wanting in nice execution. It is impossible that any School of Painting can remain simply heroic and poetic in these days, and whatever may have been upheld of this or that School of Sculpture, we have here an opportunity of learning that all the schools representing are coinciding in feeling with those of Painting. *A propos* of minute execution; a degree of finish proper to one subject would be an impertinence in another. Again we have seen different degrees of finish applied to one group with be the happiest result; and it will never be maintained that the warm *morbidness* of animated nature is not preferable to a surface nothing removed from wood or stone. Yet it is the consideration of the ideal, rather than of the mechanical, that is forced upon us by this exhibition, from which, after all, British artists may draw a large measure of comfort and consolation. But a word or two on reading and thinking, though the same word or two we have repeated wearily for the last thirty years in regard to painting. From no exhibition of sculpture there are ever absent certain "stock" subjects, which cannot be regarded otherwise than as so many apologies for not "taking trouble." Thus we find Margarets, several; Ruths, several; Ophelias, one or two; Undines, two; Andromeda; two Musidoras; Slaves, of different nations; Moses, two groups; Paul and Virginia; and a variety of incident long ago overdone. We are led to these observations rather by the performances of foreign sculptors than by those of our own artists, especially those who stand officially before the world with perhaps a considerable following of pupils, and whose primary rule of duty should be to teach students to think for themselves; and more—to illustrate independent thought by their example. Instead of this, certain professors fall back on these threadbare resources, in each instance of which they furnish material for argument against themselves. We cannot entertain this matter at any length here; we can, however, exemplify what we mean by originality in 'The Daughter of Zion' (2,760), by PROFESSOR SALVINI, of Bologna, and in 'Babylon,' by DU CAJU, of Brussels, or others. The ideas cited are original, whatever shortcomings may be exhibited in execution. There are both foreign and British artists who have not only carefully eschewed such themes as those we mention, but have studiously avoided approaching a second time any subjects which they may once have executed. Such men are the chivalry of the Art, and each shines out with a lustrous reputation. This large gathering, like all others of its kind, contains, with much that is precious, the usual alloy of mediocrity. We proceed, however, to indicate those productions that seem to be the most worthily qualified.

'Edward the Black Prince' (2,474), by her

Royal Highness the PRINCESS LOUISE, MARCHIONESS OF LORNE, is a plaster-cast, half life-size, showing the prince mounted, and in the act of drawing his sword. Although portions of the tilting harness of this renowned warrior are preserved (?) at Canterbury, yet there has been much question as to his complementary equipment: still the enterprise of the princess in entertaining a subject so difficult, is fully justified by the success with which she has carried it out. The prince appears in a suit of three quarter plate-armor, having the *camail*, or fall, of chain-mail, for the protection of the neck and throat. The surcoat is dispensed with, and the little there is of heraldic symbol is strictly proper to the Prince of Wales. The word or words "Houmout" (? hoch Muth) appears on the horse-trappings of the right side, and on the other "Ich Dien," with the three feathers distributively. The equipments and appointments are all historically accurate, and great discrimination has been shown in avoiding all parade of ceremonial gear. The modelling of the horse is skilful and spirited; and that of the figure and the armour admirable; the whole forming a statuette beautiful in character, and in execution worthy of all praise. Mr. J. BELL exhibits a sketch model of his 'Group of America' (2,495) for the Memorial of the Prince Consort; 'The Octoroon' (2,494), a statue in marble; and a small statue of 'Cromwell' (2,496), &c. We are never weary of contemplating those charming *bas-reliefs* by J. EDWARDS, of which there are three, 'The Daughter of Grace—Religion' (2,528), 'The Daughter of Faith—Unfading Hope' (2,529), and 'The Angel of Light' (2,530). Mr. Edwards' line of Art is entirely his own, and these works are of the most exalted type. Two of them have been engraved in the *Art-Journal*. Mr. FOLEY'S (R.A.) 'Youth at a Stream' will always hold its own in any exhibition. It is in marble, and is exhibited by the Royal Horticultural Society. A very perfect example of tinted sculpture by GIBSON (R.A.), 'Venus and Cupid' (2,557), contributed by the Prince of Wales, is worked out in a spirit to show the severity of taste which distinguish Mr. Gibson's works generally. The tinting, in this case done, perhaps, with coffee, gives to the work a very agreeable mellowness of tone. Another contribution by the Prince is a 'Group,' by PROFESSOR JERICHAU (Denmark), to which there is no descriptive title, though the figures evidently illustrate a story. They are apparently two sisters crouching on the ground in apprehension of some approaching danger. The modelling is full, rich, everywhere correct, and the softness of the finish a triumph of execution.

By the late BARON MAROCHETTI, R.A., are two marble busts, those of the 'Duchess of Manchester,' (2,539), and 'Lord Stratford de Redcliffe.' Some of the works sent by J. A. RAEMAEKERS are of a very much higher character than others we have previously seen by him. They are more free from unnecessary accessory; the merit of the work being centred in its expression. There are, also, 'What are the Wild Waves saying?' 'Paul and Florence Dombey' (2,619); 'Ophelia' (2,620), 'Ruth,' &c. 'Elaine' (2,662) and 'Enid' (2,663), are two statuettes by J. S. WESTMACOTT, minutely elaborate in carving, and responding in every way to the spirit of the Poet-Laureate's verse. 'The Dying Clytie' (2,661), G. F. WATTS, R.A., differs from the bust in the British Museum, inasmuch as the head is falling back, and the sun-

flower is not perfectly formed. The idea is more correct than that signified in the ancient bust, as she could not exist in human form contemporaneously with the perfect flower. The 'Undine' (2,593) of W. CALDER MARSHALL, R.A., is, we presume, represented as reclining in the water; the *pose* is elegant and easy, but the features are sorrowful. The idea is original, and difficult to work out in identity with the story, so as to preserve simplicity, yet it has been managed very successfully. The sad story of CEnone is opened to us in a half-length statue, also by Mr. Marshall. We see her as Paris may have seen her, and not oppressed with grief at her abandonment, as she is made to describe it in the most moving of all Ovid's epistles. Hermione would be an excellent subject for a statue—that is the Hermione of Shakespeare, for no such interest attaches to either Homer's or Ovid's Hermione. Mr. E. A. FOLEY limits his treatment of the subject to a bust (2,534), a conception of much grace, and in another bust (2,539) he celebrates 'Spring.' 'The Wood-Nymph,' C. R. BIRCH, executed for the Art-Union of London, in 1864, is here both in marble and in bronze. Mr. THEED's works comprehend a cast of the statue of 'Prince Albert' (2,641), executed, in 1863, by command of the Queen for erection at Balmoral; also his group of 'Africa' (2,638), designed for the memorial of the Prince Consort; with some other works.

In 'Euphrosyne and Cupid' (2,633), a marble group, by E. B. STEPHENS, A.R.A., Cupid is seen tampering with the zone of the Grace, a libel on the fair fame of one and all of the three sisters, for which there is no warranty, although they were attendants of Venus. Other works by Mr. Stephens are 'Blackberry-picking—the Thorn' (2,634), an agreeable figure in marble of rustic character; and 'Saved from the Wreck' (2,631). F. J. WILLIAMSON'S 'Dinah consoling Hetty in Prison' (2,671) is, as our readers know who saw the engraving of it in our Journal some months since, very successful in appropriate expression. In the story of Nausicaa is nothing attractive as a subject, in preference to a hundred others that are nearer home and solicit execution: it is a marble statue (2,682), by E. W. WYON, whose bust of Sir William Fairbairn is a striking resemblance. There are, also, strong objections against 'The Song of the Shirt' (2,676) as a sculptural subject. The poor sempstress, in order to emphasize the force of the poem, must be presented, personally divested of all the points of beauty which it has ever been the especial province of sculpture to illustrate. 'Sunshine' (2,523), 'Girl at a Spring' (2,524), and 'The Grotto-Boy—Only once a Year,' are three works by J. DURHAM, A.R.A., not only of much sweetness, but also, it must be said, very original, although the subjects lie on the very surface of our every-day observation. It is the first time we have ever seen a grotto-boy in sculpture, and it is difficult to see how, in any future version, the impersonation can be excelled. By C. E. VAN DENBOSCH, 'Hush!' (2,648), is one of those common topics which, either in painting or sculpture, is scarcely ever absent from a mixed and moderately extensive exhibition. The face here is the best passage of the composition, the point of which—so obvious is the necessary action—it would be difficult to miss; and here is impressed upon us more sensibly by sculpture than by painting, the incessant repetition of hacknied subjects, because the accessorial means of sculpture are so much more limited than those of

painting. On the other hand, there is much material strikingly original, and very agreeably carried out. In 'Daphne' (2,675), a marble statue by MARSHALL WOOD, the change of the nymph into the laurel is gracefully alluded to by the leaves behind her, and the deathly impress on the features.

'Il Giovane—Dante' (2,567), J. HUTCHISON, R.S.A., is unmistakably the youthful Dante. The face of the immortal author of the "Divina Commedia" is like that of no other man we have ever seen—it will be remembered when those hundreds of other celebrities are forgotten. In the only authentic portrait we have of Dante, the whole of the "Inferno" seems written, and it is scarcely to be believed that even in youth there was any relief to that profound melancholy which is stamped on his features as we know them. This is a bust; but there is a life-sized statue of 'Dante in Exile' (2,582), J. LAWLOR, a figure in loose drapery seated, and looking down. The danger in modelling from Dante's portrait is that of getting the features of a Mephistophelean cast; Mr. Lawlor has succeeded with his 'proposition, which in execution owes everything to its simplicity. Whatever may be the intention in the backward flowing style of the hair in the marble bust 'Hamlet' (2,569), J. HUTCHISON, R.S.A., it will always suggest the head of a woman. To 'Ganymede and the Eagle' (2,535), FANTACHIOTTI, it is extremely difficult to give any interest. It exemplifies here, however, in the carving of the plumage, an extraordinary amount of patience. We have before spoken in terms of high commendation of 'The 'Skipping-Girl' (2,642), MARY THORNYCROFT: of this statue, nothing remains to be said but that it wins upon us on further acquaintance. An 'Eve' (2,563), G. HALSE, is really a charming figure. The text is 'On she came,' &c., and in the great point, the personification of innocence, the artist has succeeded perfectly. The marble bust of the late H. Crabb Robinson (2,483), G. G. ADAMS, is the best work we have ever seen by this artist—it is remarkable for softness of carving. By C. E. VAN DENBOSCH there is a model of a bust of the Princess of Wales (2,645), which is to be repeated in marble for the Guildhall. The head is well set up, and treated in a manner highly picturesque, perhaps too showy, to verify the simple sweetness of the Princess' character—but the cast of feature is not such as is commonly set forth as that of Her Royal Highness. As a sculptural production, it is a beautiful work. In any extensive collection of paintings or sculptures we cannot mingle in the throng without meeting a 'Lurlei' (2,654) C. VOSS. Here, it is a marble statue, presenting her, as we may suppose, on the crest of the Lurleiberg, resting on her harp, and looking down on the river below. The personal dispositions compose with much grace and ease, but in the front view the head looks large, from a certain poverty of proportion in the upper parts of the statue. 'Erinna' (2,584), H. S. LEIFCHILD, is a recumbent marble statue, in which the subject is represented as asleep. Of the story of Erinna, beyond her friendship with Sappho, so little is known, that but a meagre interest is felt in the subject. Many other works are more or less remarkable, some for perfection of mechanism, others for primitiveness of idea, inasmuch that they are attractive because they are almost excellent. To these generally, in justification of any stricture that might be passed upon them, would be due a more particular description than can here be given; the titles,

therefore, only of a selection, are noted as,—'The Maiden's Secret' (2,583), G. A. LAWSON; 'Clio' (2,588), T. MACLEAN; 'Pasquicia' (2,568), J. HUTCHISON, R.S.A.; 'Eve' (2,673), J. WARRINGTON WOOD; 'Happy Days' (2,650), P. VANLINDEN; 'Mary' (2,585), H. S. LEIFCHILD; 'Going to Bathe' (2,651), C. VINOELST; 'The Dream' (2,672); 'Head of a Nymph' (2,658), and others by J. WATKINS, R.H.A.; 'Alarmed' (2,615), E. G. PHYSICK; 'Our Lord' (2,486), S. ALLEN; 'Margaret' (2,503), C. B. BIRCH; 'Hercules strangling Antæus' (2,609), H. MONTFORD; 'Hagar and Ishmael' (2,628), T. SHARP, &c.

At the entrance to the east galleries, where are distributed the foreign sculpture, there is a very fine bronze, 'Ariadne,' which loses much grace and dignity by a knotty composition of the left leg and arm. In whatever way the subject is treated, it must remind us of Danneker's famous work. Very often the effort to establish a difference leads to eccentricities which destroy an otherwise faultless group or statue. 'L'Enfant au Perroquet,' is the old anecdote of the child with the fruit, and the parrot with a menacing air demanding his share. By DAVID D'ANGERS (2,685) is a plaster cast of a bust of Mrs. Opie, the authoress, and wife of the Academician, who seems to have sat for the bust in her neat Quaker cap. 'Pandora with the Box,' GRÜYERE, is a marble statue gracefully modelled according to the antique canon; but of the box too little is made—she holds it before her as a trifle of no importance. 'An Arab Sheik,' by CORDIER, is a very showy composite bust, exemplifying the mixture of bronze with coloured drapery. In the middle of the gallery is a case of small bronzes by CARPEAUX, several of which are of great beauty; they are busts and statuettes. 'Cupid Punished,' LANZIROTTI, is one of those rapid conceits which are sometimes put forth in the hope that they will be accepted at the value put on them by the artist. 'Première Impression,' CORDIER, reminds the observer at once of Newton's picture of a 'Girl at her Devotions;' as here also a girl is holding before her a portrait, on which her attention is fixed: the subject is not pleasing in sculpture. 'Les Amours d'aujourd'hui,' EMILE THOMAS, are two small nude figures intended to satirise the moral laxity of Parisian society; thus the male figure holds up a purse of gold, at which the other glances over her shoulder with a smile which is not to be mistaken. These French works, being recent contributions, do not appear in the catalogue. The numbered works are resumed in 'Daphnis and Chloe' (2,750), a marble group by L. GUGLIELMI, of which the Chloe is much the better figure of the two; this is one of the comparatively few references to the classic which are found among the Italian sculpture here. Time was, and that not many years ago, when everything emanating from the studios of Italy was highly tintured with the spirit of the antique; but now, say of twenty works, not more than two or three are strictly suggestions in narrative and in formal taste from the ancient marbles. Professor CARONI, of Florence, sends two marble statues, 'Ophelia' (2,744), an 'Albanian Slave' (2,746), and a group—'Love Conquering Strength' (2,745); the last, only quasi-antique, a mixture of the noble and the vulgar metals. In thus falling into the common groove, the other two subjects are worn to rags. Professor Caroni does not recognise the grave responsibilities which attach to his position. In 'The Little Shepherdess' (2,749), C. FANTOC-

CHIOTTI, is a lamb which cannot but be remarked as composing indifferently with the figure: the latter is successful, but her woolly charge seems to have been an afterthought. 'Paul and Virginia' (2,747), C. CHELLI, is a very elaborate group in marble, with many beauties, and the superior merit of at once declaring the allusion. A 'Woman and Child flying from Pompeii' (2,742), L. AMICI, of Rome, has the merits of simplicity of treatment and becoming expression. Professor TANTARDINI, of Milan, sends not fewer than six works, of which 'The Orphans' (2,764), and 'The First Grief' (2,763), are impressive and touching. From Professor LAZZARINI, of Rome, is one group, 'Hagar and Ishmael' (2,752), of which the Hagar is in great measure a success.

Professor TORELLI, of Florence, contributes a statue, 'Eva St. Clair' ("Uncle Tom's Cabin"); and from other members of the Italian school are works of conspicuous merit, of which may be signalled 'The Child Moses' (2,690), by BARZAGHI, of Milan, whose conception is novel, and carried out with power and much professional learning to a very successful result. In the 'Flute-Player charming a Lizard' (2,707), A. FASSIN, Belgium, the incident is well set forth; but there is no reason why the modelling of the boy should be so wanting in roundness. It is not too much to say that in 'Göthe's Fisherman' (2,713), J. GEEFS, of Antwerp, does more than sustain his reputation in this charming group. 'At the Waterside' (2,699), DE LEEMANS, of Brussels, is realised by a nymph kneeling and dressing her hair from the reflection in the water. 'Bacchanalia,' (2,716), ROMBAUX, is a pretty group of three boys. Again, A. SOPERS, another Belgian sculptor, in 'A Faun with Shell' (2,717), tells us how the creature got his fingers pinched by a merciless bivalve in a manner to make him dance and sing. This is really equal to the best of the quaint conceits of the ancients. 'A Child with Pigeons' (2,709), C. A. FRAIKIN, Brussels, is a pretty idea: but 'Love Veiled,' by L. VANDENKERCKHOVE, also of Brussels (2,720), has to recommend it only a certain mechanical success in the representation of the veil.

We conclude our brief notice by mention of a large and admirable bas-relief (2,737), by J. J. HALKIN, of Liege, called 'Jesus appearing to his Mother'; but this is a misnomer, for it represents the procession to Calvary; and the Saviour is borne down by the weight of the Cross. Mary Magdalen kneels near Him, and the Virgin stands by weeping; other impersonations proper to the subject are introduced. This work cannot be too highly praised.

ART IN IRELAND AND THE PROVINCES.

DUBLIN.—The building erected for the International Exhibition, held a few years since in this city, is to be converted into a "Museum of Art, Industry, and Manufactures," on the plan of that at South Kensington. Sir Arthur E. Guinness, M.P., holds the greater part, if not the whole, of the property; and it is through him that the change will be effected.

MORPETH.—A marble bust of the late Earl of Carlisle has been placed in the Town Hall of this place. It is the work of J. H. Foley, R.A.

SALISBURY.—A building intended for the use of the Literary and Scientific Institution, and for the School of Science and Art, has recently been opened in this city. It has a hall capable of seating 800 persons; the cost is estimated at about £3,000.

LONDON UNIVERSITY COLLEGE.

ON the 27th of September Mr. E. J. Poynter, A.R.A., Slade Professor of the Fine Arts at the College, delivered his inaugural lecture to a large and attentive audience.

After setting forth the circumstances under which the office of Professor was founded in London, and also at Oxford and at Cambridge, and pointing out the want of schools where the study of Art in its highest branches could be carried on by pupils of both sexes, Mr. Poynter proceeded to explain the system of instruction adopted in the schools of France, which he proposed to use as his ground-work. The prospectus he had circulated would show the plan he intended to follow—giving preference to the living model. The system of instruction which prevailed in England for a long time, and was not yet quite out of date, appeared to be the cause of that want of sound knowledge of drawing and painting so commonly found among our artists, compared with those of the Continent. This system might be defined as a lengthened course of study of the antique before that of the living model. Experience had amply proved the difficulty which a student found in connecting the forms of the antique model with those given in anatomical books and figures before he had learned to understand them properly in the living figure. A different order of things prevailed in France; where, also, a pupil had often the advantage of attending the *ateliers* of painters of repute, a practice more or less allowed by the latter; and which enabled the young beginner to acquire a kind of practical and useful knowledge otherwise unattainable. In England such facilities rarely existed; our best artists, as a rule, having a decided objection to take pupils, though our architects had none. The French and other foreign artists had, moreover, considerable advantage over their English brethren in the possession of a greater knowledge of the practical details of their art. This superiority was partly due to the custom prevailing in their schools of undergoing a thorough course of elementary study, and acquiring a certain amount of practical proficiency in painting before exhibiting to the public; and partly to a plan of instruction that allowed no waste of time on useless or unimportant subjects of study. An adherence to the system of drawing for a lengthened period from antique casts rendered the student practically helpless when he commences working from the life; while, after he had acquired a comprehensive knowledge of the aspects of nature, he was the better able to derive improvement from studying the antique.

The prospectus issued by the Professor states that, "In the Slade Schools the study of the living model will be considered of the first and foremost importance; the study of the antique being put in a second place, and used as a means of improving the style of the students from time to time." He had consequently prepared, with a view to carry out the plan effectually, a general course of instruction in which the students would be under his direction, and would include instruction in drawing from the antique, from the nude model, and from the draped model, at a fixed and uniform fee for all students. In all classes, except those for study from the nude, male and female students would work together. He proposed, too, that the class-rooms for study from the antique and from the living model should be open in the evening, but only for drawing and modelling: painting by gas-light, he considered, led to a false and an imperfect method of using colours. He maintained that constant study from the life-model was the only means of arriving at a comprehension of beauty in nature, and of avoiding its ugliness and deformities. Both amateurs and those intending to become professional artists would, he hoped, undergo the same regular and thorough system of instruction. He looked forward to the institution for female students of a class for study from the half-draped model. The lecture concluded with an earnest appeal to those who intended to become students, to give industry, attention, and perseverance in the pursuit of their labours.

The classes commenced on the second of October.

SCHOOLS OF ART.

BELFAST.—The annual meeting of the subscribers and friends of this school was held on the 25th of September. The institution, which formerly existed under the name of a "School of Design," now embraces a wider field of operations; and the building was enlarged in 1870 at an expenditure of about £816. In October of that year the "School of Art" was opened; and 440 pupils have since attended the classes. Though only a few months at work, the students sent no fewer than 1,500 drawings, designs, &c., to the national competition in London, in April last; of the results, Mr. T. M. Lindsay, head-master, says, in his Report, that they were "successful beyond my expectation, creditable alike to the students and to the school. Short as the time had been for the training necessary to qualify pupils to enter upon the competition, it is most gratifying to find that their diligence and ability secured for them eleven third-grade prizes; and a bronze medal has also been taken for designs." To stimulate and encourage the pupils; and, if possible, to induce a larger attendance, a special local prize-fund has been instituted, apart from the ordinary revenues of the school; it is intended to give, at Christmas next, the sum of £65 in prizes for original designs of various kinds. This amount is independent of, and in addition to, the awards bestowed by the Department of Science and Art. The munificence of one liberal supporter of the institution, Mr. William Dunville, J.P., must not pass unrecorded; this gentleman gives an annual subscription of £100.

BIRKENHEAD.—The new school of Art and Science, erected at the cost of Mr. John Laird, M.P., was opened last month, when the Earl of Derby delivered a long and instructive address on the subject of Art-education. One of the principal points on which his lordship spoke referred to special, or technical, training; theory and practice must go hand in hand, if Art—Industrial Art is here meant—is to make any way with us nationally, and enable us to compete with foreign rivals. It is only the oft-repeated story, that unless you thoroughly educate the artisan in all you require of him, we must rest content to see ourselves left in the rear in competition with other nations, instead of being, as we should, and ought to be—at the winning-post. "I say, then," said the noble earl, "that the teaching of Art, and of Science too, in its practical application—teaching not confined to a few great centres, but so diffused as to reach the whole body of the artisan-class if they choose to avail themselves of it—is one of the requirements of our time." Another topic in relation to the subject on which Lord Derby touched was the almost utter impossibility of the English workman attaining to any right perception of beauty and the picturesque, so long as he is surrounded on all sides, as is commonly the case, by what for the most part is "squalid, dirty, and mean." "It seems to me absolute cruelty to give a man, by artistic training, a keen sense and appreciation of natural beauty, and then set him down to live in the centre—well, I may say even, Liverpool, and still more of such places as the great towns on the coalfield." We remember Professor Ruskin discussing this point most ably and eloquently, a few years ago, in a lecture at the Mechanics' Institute, at Bradford, in Yorkshire, in which he drew a comparison between the glorious views of nature the old Florentine workman had the privilege of contemplating, and those which the British artisan saw in our great centres of industry, where all natural beauty is destroyed or driven away. This, however, is a question of political and social economy, offering many difficulties in the way of satisfactory solution; yet is it a most important one from other than a mere artistic point of view.

ROCHDALE.—The annual meeting of the supporters of this school was held on September 23rd. We ascertain from the report that the total number of pupils attending the Science-classes has been 138; and the Art-classes 68. The whole number of certificates obtained during the session was 98 in Science, and 18 in Art.

CELEBRATED CHURCHES OF EUROPE.

No. XIII.—ST. MARK'S, VENICE.

AFTER an interval of several months we are in a position to resume this series of papers: the delay has been occasioned by the recent calamitous war in France, which, for the time, suspended the labours of the artists of that country entrusted with the task of preparing the engravings that illustrate the text.

We could scarcely recommence our work with a more notable example of ecclesiastical architecture than is presented in the magnificent edifice, St. Mark's, Venice, which for ages has been the subject of the painter's pencil and the traveller's pen. "A medley of Greek, Roman, and Pointed architecture," says the Abbé J. Gaume; "a museum of the richest spoils brought from the Peloponnesus, from Constantinople, Spain, and Syria—from every country, in

fact, where Venice saw her banners waving—a splendid gallery of national paintings, the church of St. Mark's tells, in its way, the whole history of the powerful republic."

Not till the early part of the present century was St. Mark's elevated to the dignity of the chief church in Venice, when Pope Pius VII. transferred to it the patriarchal seat from St. Pietro. Its foundation dates from the year 828, when the Doge Giustiniano Participazio commenced building an edifice to contain the relics of St. Mark, the patron-saint of the city. Giustiniano left it incomplete, but his successors finished it and enriched it greatly. This church stood till destroyed in the conflagration which terminated the life and government of the Doge Pietro Candiano, in 976.

Pietro Orseolo undertook the rebuilding of the edifice: the first stone was laid in 977, but considerably more than half a century elapsed before even the exterior was completed, by the Doge Domenico Cantarini, in 1043. His successor, Domenico Salvo, enriched the church with many

valuable mosaics in 1071: at length, in 1094, or, as some writers state, in 1111, St. Mark's was solemnly consecrated, when Ordelafo Faliero was doge. It has been a question long and frequently discussed, to which of the several eras of construction the present edifice is to be ascribed; but nothing has ever been settled with any certainty. Whatever opinions on the matter may be entertained, there is abundant evidence that this grand work is pervaded by Byzantine taste. Its plan—a regular Greek cross, preceded by a spacious portico—has sustained no alteration, and its ornamentation is without parallel in Italy.

Of all that has been written about this wondrous edifice, no more beautiful and gorgeous description has been given of it than that which is found in Professor Ruskin's "Stones of Venice." The whole is too long for extract; a portion, therefore, must suffice. After speaking of the houses and groups of people in the Bocca di Piazza, the mouth of the square of St. Mark's, he says:—"We will push fast through them



ST. MARK'S, VENICE.

into the shadow of the pillars at the end of the Bocca di Piazza, and then we forget them all; for between these pillars there opens a great light, and, in the midst of it, as we advance slowly, the vast tower of St. Mark's seems to lift itself visibly forth from the level field of chequered stones: and, on each side, the countless arches prolong themselves into ranged symmetry, as if the rugged and irregular houses that pressed together above us in the dark alley had been struck back into sudden obedience and lovely order, and all their rude casements and broken walls had been transformed into arches charged with goodly sculpture and fluted shafts of delicate stone.

"And well may they fall back, for beyond those troops of ordered arches there rises a vision out of the earth, and all the great square seems to have opened from it in a kind of awe, that we may see it far away;—a multitude of pillars and white domes, clustered into a long low pyramid of coloured light; a treasure-heap, it seems, partly of

gold and partly of opal and mother-of-pearl, hollowed beneath into five great vaulted porches, circled with fair mosaic, and beset with sculpture of alabaster, clear as amber and delicate as ivory—sculpture fantastic and involved, of palm leaves and lilies, and grapes and pomegranates, and birds clinging and fluttering among the branches, all twined together into an endless network of buds and plumes; and, in the midst of it, the solemn forms of angels, sceptred and robed to the feet, and leaning to each other across the gates, their figures indistinct among the gleaming of the golden ground through the leaves beside them, interrupted and dim, like the morning light as it faded back among the branches of Eden when first its gates were angel-guarded long ago. And round the walls of the porches there are set pillars of variegated stones, jasper and porphyry, and deep green serpentine spotted with flakes of snow, and marbles that half refuse and half yield to the sunshine, Cleopatra-like, 'their bluest veins to kiss'—the shadow, as it steals back from

them, revealing line after line of azure undulation, as a receding tide leaves the waved sand; their capitals rich with interwoven tracery, rooted knots of herbage, and drifting leaves of acanthus and vine, and mystical signs, all beginning and ending in the Cross; and above them, in the broad archivolt, a continuous chain of language and of life—angels, and the signs of heaven and the labours of men, each in its appointed season upon the earth; and above these another range of glittering pinnacles, mixed with white arches edged with scarlet flowers,—a confusion of delight, amidst which the breasts of the Greek horses are seen blazing in their breadth of golden strength, and the St. Mark's Lion, lifted on a blue field covered with stars, until, at last, as if in ecstasy, the crests of the arches break into a marble foam, and toss themselves far into the blue sky in flashes and wreaths of sculptured spray, as if the breakers on the Lido shore had been frost-bound before they fell, and the sea-nymphs had inlaid them with coral and amethyst."

No. XIV.—SEVILLE CATHEDRAL.



Who has not seen Seville," says an old Spanish proverb, "has not seen a wonder."

Founded by the Phœnicians of a very remote antiquity, enlarged and beautified by the Romans under Julius Cæsar; the capital of the kingdom of the Gauls, till towards the close of the sixth century; rebuilt by the Moors; taken from the latter, in 1248, by Ferdinand III., of Leon and Castile, who was called the Saint; the seat of an ancient archbishopric—Seville, the "Queen of Andalusia," offers in its various monuments of past ages a multitude of noble reminiscences of Spanish history. Most of the Roman remains have yielded to the ravages of time and revolutions; but its Moorsque edifices, on the contrary, are still numerous, and give to the city a most picturesque character. The Guadalquivir rolls its waters at the feet of the ramparts, its banks fringed

with laurel-rose, pomegranate, myrtle, and orange tree; while the streets reveal palaces and mansions in which one recognises the ingenious hand of the Moslem tribes.

The Cathedral of Seville has the reputation of being the largest and grandest in Spain. It occupies the site of a temple erected during the time when the Romans held the city, who dedicated the edifice to Venus: the temple is said to have been subsequently converted into a Christian church. In 712 Seville opened its gates to the Moslems, who erected a splendid mosque where the church of the Christians stood: this mosque is stated to have been burnt by the Normans. It was succeeded by another, built about 1184, by the Emir Abu-Jusuf-Yacub. St. Ferdinand converted this edifice into a cathedral, with Gothic chapels, choirs, &c., which stood till 1401, when at a meeting of the chapter it was resolved to build a church "so large and beautiful that coming ages may proclaim us mad to have undertaken it." The first stone

was laid in 1402, and the last was placed in 1506, but not till 1519 was the noble edifice finally completed.

In Gwilt's "Encyclopædia of Architecture," the latest edition, revised by Mr. Papworth, we find the following reference to Seville Cathedral:—"It was principally rebuilt by Ferdinando Ruiz, who was much engaged in the city, and especially in enlarging or raising the well-known tower called the Giralda. This singular edifice was begun in the eleventh century, the original idea of it being given by the architect, Geber, a native of Seville, to whom the invention of algebra is attributed; and also the design of two other towers, one in Morocco, and the other at Rabata. The tower of which we are now speaking was at first 230 feet high, and 50 feet wide, and was without diminution as it rose. The walls are eight feet thick, of squared stones, from the level of the pavement; the rest for 87 feet is of brick. In the centre of this tower is a smaller one, the interval between the two

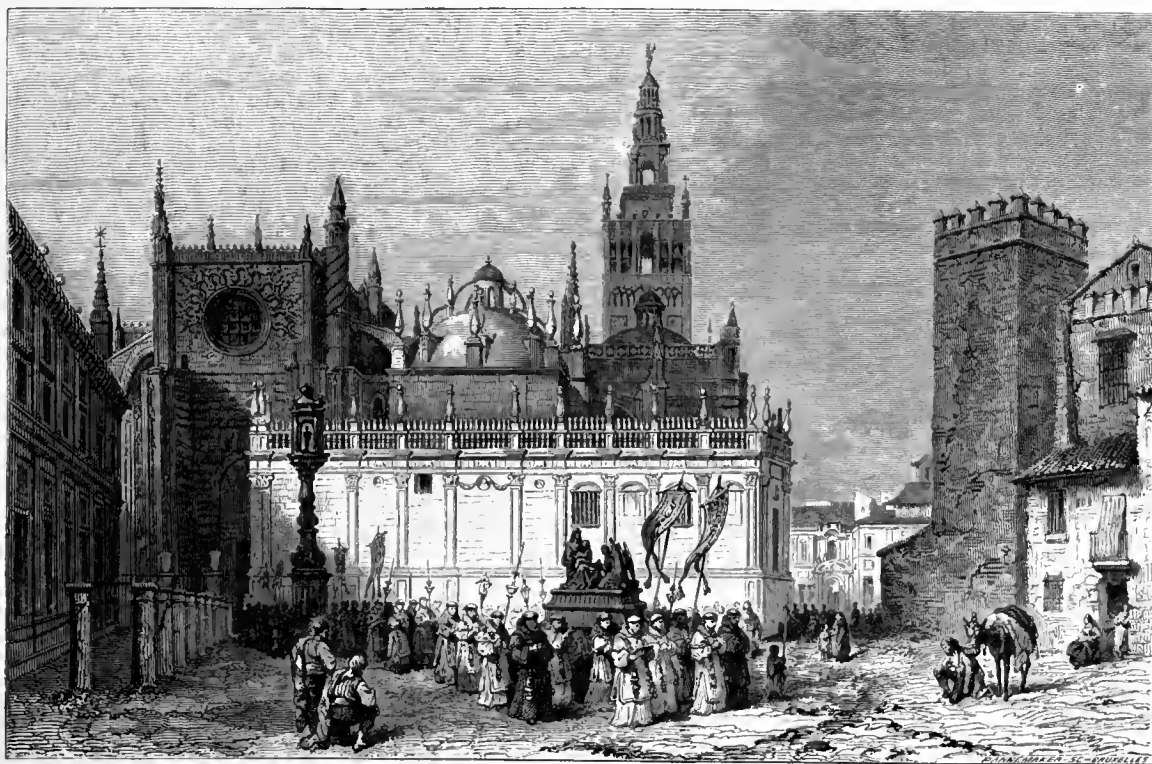

SEVILLE CATHEDRAL.

towers being 23 feet, which serves for the ascent, one so convenient that two persons abreast can mount it on horseback. The central tower does not diminish; but as the edifice rises in height the walls gather over, so as to allow the passage of only one person. Upon the Moors of Seville negotiating their surrender, one of the conditions of it was, that this tower should not be destroyed; to which Don Alphonso, the eldest son of the king, answered, that if a portion of it were touched, not a man in Seville should survive. In the earthquake of 1395 it was partially injured, and remained in the state of misfortune that then occurred until 1568, when, by the authorities, Ferdinando Ruiz received the commission to raise it 100 feet higher. This height he divided into three parts, crowning it with a small cupola or lantern; the first division of his addition is of equal thickness with the tower on a plinth, whence six pilasters rise on each façade, between which are six windows, over which is an entablature surmounted by

balustrades; the second division is lower, with the same ornament; and the third is octagonal, with pilasters, over which the cupola rises, crowned with a bronze statue of Faith, vulgarly called 'La Giralda.' Ruiz by this work augmented his fame; and notwithstanding the earthquakes which have since occurred, it has fortunately enough been preserved. . . . Pictorially speaking, the tower of the Giralda is a splendid object."

Externally the Cathedral shows traces of almost every style of architecture that has prevailed in civilised Europe from the most remote times. "Indeed all the arts seem to have combined, and each in turn at their acme of strength, so as to produce their finest strength here. The Moorish Giralda, the Gothic Cathedral, the Græco-Roman exterior produce variety and repose to the eye. Inside, its numerous pictures are by some of the greatest painters; the stained-glass is among the finest specimens known; the sculpture beautiful; the jeweller's work

and the silversmith's unrivalled in composition, execution, and intrinsic value."

"When we enter it, the primary impression is that of reverence and awe. There is a solemnity in those sombre masses and clusters of spires, whose proportions and details are somewhat lost and concealed in the mysterious shadows which pervade the whole—a grandeur that kindles up dormant feelings, quickens the sense, and makes our very heart stir within us when we stand as lost among the lofty naves and countless gilt altars. Vast proportions, unity of design followed in the main body of the interior, severity, sobriety of ornamentation, and that simplicity unalloyed by monotony which stamps all the works of real genius—render this one of the noblest piles ever raised to God by man, and preferred by many even to St. Peter's of Rome."*

JAMES DAFFORNE.

* O'Shea's "Guide to Spain and Portugal."

SELECTED PICTURES.

THE CORONATION OF THE VIRGIN.

G. Da Udine, Painter. K. Mayr, Engraver.

WERE it not for the information afforded by Messrs. Crowe and Cavalcaselle in their history of the early Italian painters, it would have been difficult to determine the author of this picture—a fresco painted in the church of St. Giovanni and St. Paolo, Venice. This edifice, as many of our readers may remember, was partially destroyed by fire four or five years ago, when Titian's famous picture of 'The Death of St. Peter, Martyr' perished: but whether or not Da Udine's fresco escaped the flames, we do not know. Neither Vasari, nor Lanzi, mentions the name of Girolamo Da Udine; but in the book to which we refer, we find him thus spoken of, and under the name of Girolamo di Bernardino, of Udine: he appears to have lived in the early part of the sixteenth century.

"Friulian by birth and education, he elaborated an ill-cultivated style. . . . What we observe in his 'Coronation of the Virgin,' in the town-hall of Udine, is a timid conception of subject, an antiquated Friulian air, and a paltry adaptation of the models of Cima, combined with that peculiar rawness and heavy flatness of tones which make the latest creations of Giovanni Martini—one of his contemporaries and fellow-workers—"unattractive. It is just such a work as we might assign to a man who had been employed as a journeyman towards the close of the fifteenth century in the *ateliers* of Cima and Carpaccio; nor is it improbable that, when at Venice, he should have received orders for pictures such as the 'Coronation of the Virgin,' called Carpaccio, in San Giovanni e Paolo; or the 'Glory of St. Mark,' attributed to Cima, in the Academy of Vienna."

In some records still existing, introduced as a note in the volumes of Messrs. Crowe and Cavalcaselle, are, among others, entries to the following effect:—Girolamo de Bernardino hires a house at Udine in 1506; lets the dyeing establishments of his father at Udine in 1508: sundry entries respecting valuations of a carved altar, and of a curtain-fall: contracts to paint the choir-chapels of some churches near Udine, &c.

Without assuming to dispute the accuracy of such learned critics and zealous researchers as Mr. Crowe and his coadjutor, we should be more disposed to assign this 'Coronation of the Virgin' to Giovanni Nanni da Udine, who was contemporary with Bernardino, rather than to the latter; and simply because of the Raffaellesque ornament with which the design abounds. Giovanni was a native of Udine, but hearing of the fame of Raffaele, he went to Rome, and was much employed by the great painter in the decorations of the Vatican; and also by Clement VII. in the execution of similar works after the death of Raffaele. On the sacking of Rome, in 1527, he was compelled to flee from the city, and he returned to Udine, and was afterwards engaged in Florence by the Medici family, for whom he executed several works. There is, however, no direct evidence that he was ever in Venice. We do not find that Bernardino knew anything of Raffaele, except, perhaps, by report.

The fresco, though handled somewhat severely, in the passage we have quoted, seems on a par with most of the works executed by the less-known artists of the period: there is rigid dignity in the forms and expression of the figures, and yet considerable grace.

THE PAST AND THE FUTURE
OF
INTERNATIONAL EXHIBITIONS.

THE close of the International Exhibition of 1871 has brought us to a point in the history of these displays from which it is highly instructive to look back on the past, as well as to cast a speculative glance towards the future. We are at a moment of crisis. The attempt is now being made to convert what was intended to be an effort, renewed only after considerable intervals of time, into a portion of the permanent routine of the year. Whether the attempt will succeed or fail, must depend, in a great measure, on the concurrence of other nations. Yet at the very time that the continental manufacturers are invited to compete at London with English producers, one great German capital is arranging to open its gates for a similar undertaking, and that on a scale more vast and comprehensive than has yet been anywhere attempted. Where is this to stop? Are we to have International pitted against International? And how are we to expect that the competing claims of the various exhibiting States will be finally adjusted?

The great Exhibition of 1851 was an event that stands alone in the world's history. Its startling novelty was not less charming than its unrivalled beauty. Everything was new and fresh, as well as rich and rare. The wearers of names that rank high, and will always rank high in the annals of civilisation, men and women who left a blank behind them when they faded from the story of life—thronged those glittering arcades. Everything conspired to exalt and affect the imagination; and people fondly hoped that so unrivalled a display of the power of Industrial Art was the inauguration of a long era of peace.

How thoroughly we reckoned without our host in that respect the events of the last two years have shown. But while war has raged, with a rapid outburst and a sudden fury, producing events of a magnitude that we can yet hardly comprehend, since the Poet-Laureate hailed the Crystal Palace, Industry has, at the same time, made steady and unquestionable progress. How much we owe to 1851 has been illustrated by the department of manufacture, namely, ceramic ware, exhibited this year at South Kensington. Can any one who admired the lovely colouring, bold execution, and admirable excellence of finish displayed by the productions of Copeland, Minton, the Royal Worcester Porcelain Works, and other scarcely inferior producers, sufficiently remember the state of this great national industry in 1851, to measure the progress it has made in that score of years? It is an advance such as that which divides the work of the Greek and Etruscan potters into distinct ages. It is a progress primarily and chiefly due to the spirit awakened, and the knowledge obtained, by the first great Exhibition.

The glorious scene of 1851 has had no parallel. We repeat, it was unique. But the first Exhibition has had children and grand-children. Omitting foreign gatherings of this nature from our present survey, and also passing over the provincial efforts made in our own islands and colonies, we have in London and its vicinity three large and costly palaces, devoted to the illustration, more or less directly, of Industrial Art, which are the direct offsprings of the Hyde Park Exhibition. We refer, as our readers will at once conclude, to the great buildings at Syden-

ham, at South Kensington, and at Muswell Hill. The very stone and timber, or rather glass and iron, of the beautiful conservatory, which Sir Charles Fox, by a *tour de force* then unparalleled, erected in the park, from the rough sketch of the Duke of Devonshire's gardener, Sir Joseph Paxton—an enlarged copy, it might almost be said, of the Great Conservatory at Chatsworth—was carried bodily to the noble site on the summit of Sydenham Hill, and there re-erected into a palace of the people, at the cost, including gardens, fountains, and internal embellishment, of a million and a half sterling. The exigencies created by so lavish an expenditure, made in the form of shareholders' capital, are such as to have militated very seriously against the character of the Crystal Palace as an Industrial Exhibition. In this respect it has descended to the level of a bazaar. But in the charming concerts organised on the spot, and for the performance of which a very successful struggle has been carried on against the radical acoustic defects of the building (which is of a nature essentially temporary), the managers of the Crystal Palace have established an unquestionable claim to public gratitude.

The South Kensington Museum is the second of the institutions to which we refer. In this establishment there is so much of hope and promise for the future, and so much of actual excellence, that men, anxious for the spread of a real industrial education for the people, have made it a matter of conscience to keep silence as to certain grave points open to objection. It has been felt by many of us, that the evils referred to are chiefly due to personal causes; and that with the up-growth of that specially-educated class, to the formation of which the Museum and the attached Schools will so materially contribute, the influence of sciolism will, year after year, become less weighty and less disastrous. Self-appointed censors and uneducated critics must, in due time, become extinguished by the very students whom they collect around them.

The nation has spent £334,000 in new buildings, works, and repairs, under the impulse of the gentleman who styles himself "The Science and Art Department." The Committee of the Privy Council on Education, consisting of two members of the Cabinet of the day, whatever it may be, and of this one permanent secretary, report that £1,640,000 of public money has been expended under their direction. It is not too much to say that no State of Europe can display, in any single palace, museum, or other spot, such a brilliant and costly scene as that afforded by the courts of the South Kensington Museum. This institution, moreover, has the special advantage of serving as a nucleus for the collection of objects, the value of which is enormously increased by the mere facts of aggregation and of display. The sum of £302,000 has been spent by the nation in purchases for museums, libraries, collections, books, and examples. But the acquisitions thus made have been perhaps doubled in value by the gifts and bequests which have been made to the nation in consequence of the existence of the Museum. The value of all these donations is not ascertained; it cannot fall far short of that of the purchases themselves. Five bequests alone are valued at about £140,000. Then the loan-collection is a means of the display of the richest treasures of private collections, by a method that at once imparts novelty and variety to the Museum, exhibits to the world objects that would otherwise be seen



G. DA UDINE. PINXT.

K. MAYR. SCULPT.

THE CORONATION OF THE VIRGIN



by very few, and by none of the student class, and serves the public at no cost to the owners of the treasures. With this fine educational display is associated a library which bids, before long, to become unrivalled as a collection of works of Art.

It is, as our readers are aware, on this national basis that the attempt has been made to engraft,—first, a great musical amphitheatre, in itself a private speculation; and, secondly, an International Exhibition that shall differ from all others in being perpetual. We foresaw, from the very first announcement of these exhibitions, the probability that the character of the establishment at South Kensington would be seriously modified by these means. In our museums, up to 1871, there had been a marked and commendable absence of commercial principle. The nuisance of the day, the tradesmen's lying puffs, were excluded. Even attempts to advertise any important object by sending it for a six months' display in the loan courts, were sternly frustrated by the admirable regulations which were not only made, but *adhered to* for this object; hence the special charm of South Kensington. It was what it pretended to be—a Museum, not a bazaar, an advertisement warehouse, or a shop. The student had every facility afforded him. He could draw, he could read, he could purchase photographs of the chief Art-objects. But the touter was unknown, and the industry of the retail tradesman was undisturbed.

With each new attempt to open a great central exhibition, the indisposition of the manufacturers to tax themselves heavily for the sake of the very doubtful gains they would secure as exhibitors, has become more pronounced. This reluctance was very palpable to those who sought support in this country for the exhibition of the present year. The rapid and unexampled course of the great Germanic war was such as to exclude a large portion of the supplies expected from the Continent. Under these circumstances, the unfortunate expedient suggested itself to the managers of the Exhibition, of inducing manufacturers to come forward by alluring them not only to exhibit, but to *sell*. As to the pettifogging distinction attempted to be made between selling in one room or in another—in what was called "court" or in what was called "*annexe*"—it is neither creditable to its authors, nor satisfactory to the public.

Without repeating what we had to say on this subject in our recent number, let us inquire how the form of the South Kensington Exhibition of 1872 now looms through the November mist. The class of objects by which it is intended to replace the beautiful ceramic display of the past exhibition is that of jewellery. This is defined as "articles worn as personal ornaments made of precious metals, precious stones, or their imitations, but not goldsmith's or silversmith's work, or watches." These articles are to be brought on the 9th of April, 1872, in small cases, to be previously obtained from the Commissioners.

The first thing which strikes one in this announcement is the ambiguous character of the language in which it is made. Do the words "their imitations" apply to precious metals, or only to precious stones? If the former, is it intended that we shall be deluged by a supply of those cheap, gaudy, and altogether worthless, articles which, under such names as Abyssinian gold, Suez gold, aluminium gold, argentine, and the like, are being sold by Hebrew speculators, to their own profit, and to the great injury of our national taste?

The rule followed—at least, up to a certain time—by our own more respectable manufacturers, against the production of sham jewellery (to which the ornaments worn in masonic lodges formed the sole exception) may, we will assume, be that laid down. How, then, will it be about the standard, hall mark, or other means of verifying and declaring the quality of the metal? Our own jewellers have lately been in the habit of stamping the number of carats of fineness on the articles manufactured; an honest and praiseworthy plan, if faithfully carried out. We have 18-carat chains and 15-carat chains. But what standards will be adopted by foreign jewellers? How is the quality of their metal to be tested? In Portugal, gold articles are made of a purity unknown to ourselves. In Italy, on the contrary, 9-carat gold is common; and the rings with which the women of the Neapolitan provinces are wont to load their fingers up to the very nails, are often, we have been told by Italian jewellers, of not more than half that intrinsic value.

When articles in metal are exhibited as works of Art, the intrinsic value of the material is a question that chiefly interests the workman who wishes for examples of his craft. But the moment the educational condition is laid aside—when, instead of an exhibition of works of the jeweller's art, we have a central *depôt* for the sale of all the jewellery, or sham jewellery, of the world—the case becomes widely different. In private shops we have the responsibility of the name of the tradesman. If any one could by any means obtain from the counter of Messrs. Hunt and Roskell or any other well-known jeweller, a piece of fictitious jewellery, he would count on immediate redress. But how will her Majesty's Commissioners meet the complaints of an unwary purchaser, who, thinking that, under their respectable authority he has bought a quantity of charming Italian jewellery, finds himself loaded with trumpery Neapolitan gold?

This is but one out of the very many perplexing questions that will arise if the determination to open a bazaar at South Kensington is unfortunately persisted in. We are informed that a deputation of manufacturers is being arranged in order to lay [the matter fairly before the Commissioners]; as the interview promised by their secretary, and devolved by the major-general on a subaltern of the Royal Engineers, was less than satisfactory. We can tell my lords and gentlemen that they will find they have thrust their hands into a nest of hornets. The union between the manufacture and the trade of this country is too vital and intimate to allow the more respectable manufacturers to support an exhibition that positively cuts the throats of the tradesmen; who, to our certain knowledge, are already beginning to contemplate with dismay the prospect before them. What amount of income moreover, will the shop-keeper in the French *annexe* contribute to the assistance of the British exchequer? How far will the local taxation of the metropolis be affected by the transfer of an important branch of business to the rent-free, tax-free shop of the Commissioners of 1851? We might fill page after page with a discussion of the subject; but the result would be the same. In museums and exhibitions, as well as in other walks of life, THAT WHICH IS MORALLY WRONG CANNOT BE POLITICALLY RIGHT. A rent-free bazaar at South Kensington is an immorality: if persisted in, it will ultimately be a ruin.

LOAN EXHIBITION OF DRAWINGS.

THIS, the second exhibition that will have been held in the gallery of the Institute of Painters in Water-Colours, in aid of the funds of the National Hospital for Consumption and Diseases of the Chest at Ventnor, has, perhaps, been suggested by the result of a similar experiment last year. That occasion merited a full and ample success; because, in the first place, it was an enterprise in the cause of an institution which must have the sympathies of all who acknowledge and deplore the prevalence of the most fatal and insidious malady to which the population of these islands, especially, is subject. Again, it was most satisfactory, as the works of Art which had been collected were of the most select and valuable of their class. Yet that occasion was only a success; this is a triumph. If the exhibition of last year was excellent, the present is more so; not by comparison of works individually, not that the drawings now exhibited are superior, but because the number displaying rare quality is augmented. To the proprietors of such treasures, it must be gratifying to know that in them they possess, in such combinations, a magnetic power which has an affinity for gold, as special as the talisman of an Eastern tale.

It is enough to state here the nature of the Institution in favour of which the exhibition is held. The condition and prospects of the hospital are set forth in the catalogue, whence it appears that assistance is greatly needed. Honour, therefore, to one and all of these gentlemen who have so generously lent works of great value, and have consented to have their walls stripped for a period of six weeks, the brief term during which the exhibition will be open. Among those who have contributed most liberally are Mr. Quilter, Mr. S. Rücker, Mr. E. Sutton, Mr. Henderson, Mr. H. W. Birch, Mr. H. Burton, Mr. F. Lucas, Mr. W. Leaf, Mr. Britten, &c. The value of Mr. Quilter's contribution is about eleven thousand pounds, that of Mr. Rücker's nine thousand; and, according to this standard, are those of other proprietors. We find also on the list His Royal Highness the Duke of Edinburgh, Mr. E. Baring, Mr. Bowman, F.R.S., Mr. Klockmann, Mr. Morley, Mr. De Murrieta, Mr. Sibeth, Mr. C. J. Leaf, Mr. F. H. Leaf, T. Woolner, &c. The first sight of the walls suggests at once that the display is due to much taste and a perfect knowledge of Art. The whole has been got up under the superintendence of Mr. Vokins, through whose influence the drawings have, we believe, been procured; and among the artists of the past and the present who figure here, in their most brilliant periods respectively, are Copley Fielding, David Cox, Barrett, Cattermole, Roberts, R.A., Stanfield, R.A., E. Duncan, Turner, R.A., J. Gilbert, J. F. Goodall, R.A., Carl Haag, J. Holland, W. Hunt, J. D. Harding, F. W. Topham, Dewint, Prout, F. Tayler, T. M. Richardson, W. Müller, J. Varley, B. Willis, O. W. Brierley, Rosa Bonheur, B. Foster, Burton, T. S. Cooper, R.A., J. F. Lewis, R.A., G. Chambers, L. Haghe, &c. In this collection are revived once more memories, fresh and green, of those who have passed away from us, after having won and wielded so long the wand of the enchantress.

'A Highland Dove' (8), F. Tayler, is a very busy scene, describing, with a wonderful play of harmonious colour, all the confusion of the herd, and the consequent agonies of the drovers, together with an expanse of mountain and glen of infinite aerial beauty. 'The Keeper's Daughter' (21), is, as a personal study, very interesting, though very different from the former; and another of the same kind is 'A Highland Gillie' (41), and some others. 'Crossing the Tay' (123), as involving the swimming and ferrying across of a pack of hounds, is a subject quite after Mr. Tayler's heart; and not less so is 'A Hawking Party' (142). For, as the compositions of John Varley have always had an overpowering charm, and we look at them remembering less that by which they have been prompted than that they have suggested. It is impossible to forget how much of the exquisite feeling

of Callcott is due to Varley. Here they are—'Composition' (7), again 'Composition' (172), and same title (175). By Prout are some fine drawings of architectural work—'Abbeville' (9), 'Market-place, Abbeville' (10); 'Chartres Cathedral' (119), and 'Clock Tower' (189). 'Ramsgate Harbour' (11), is an admirable drawing by G. Chambers; by whom also is 'Fishing-Boats' (57); and in the same class of subject 'A Storm at Sea' (27), E. Duncan, is one of the most sublime essays that has ever been accomplished in marine-painting. Others by Duncan are 'Oyster Dredging' (17), 'On the River—Moonlight' (58), &c. In the same direction, are 'A Squall in the Straits of Magellan' (107), and 'The Spanish Armada on the Irish Coast' (52), O. W. Brierley. 'The Interior of St. Gudule, Brussels' (13), and 'Rouen,' (75), are by D. Roberts, R.A. By J. Holland is a drawing under the very general title of 'Venice' (16), one of those narrow canals into which he threw so much of the picturesque, although frequently themselves destitute of that quality; 'Greenwich' (134) is another drawing by him, also 'Frankfort' (202). 'Ave Maria' (18) is a brilliant study of a mother and child, by G. Bach. And to revert to another generation, there are not fewer than fifteen drawings of the first class by David Cox; thirteen of which are the property of Mr. Quilter, whose collection was so recently described in the *Art-Journal*, as to render it unnecessary here further to dilate on these magnificent works. The two exceptions are (51) 'On the Thames—Battersea,' and (204) 'Calais Pier.' Cattermole's name is of frequent occurrence in the catalogue, attached to some of his grandest works, as 'Saying Grace' (6), 'Cellini and the Robbers' (115), 'The Darnley Conspirators' (176), 'The Contest for the Bridge' (96), and many others. A most profitable study is the gradual change registered in the works of J. F. Lewis, R.A.,—progress it must be called, for his microscopic finish leaves all competitors out of sight: see, first, his 'Easter Day at Rome' (31), then 'Caged Doves' (177), 'A Halt in the Desert' (203), &c.

The examples of J. Gilbert are not so numerous as we could have wished to see; his prime essay here is 'The Battle of the Boyne,' a grand and defiant piece of composition, with such portraits as serve to refresh the historical reminiscences of that event; there are also 'The Standard-Bearer' (64), 'To the King's Aid' (166), and some others. By F. W. Burton is a really transcendent impersonation (181), 'A.D. 1660, Ironsides,' and also, charming beyond description, is 'The Virgin's Day' (174), by the same artist. 'Feeding the Swans' (131), F. Goodall, R.A., is a graceful extract from a picture painted by Mr. Goodall some years since; but 'The Coffee-Bearer' (101) refers to his recent visit to Egypt. Birket Foster is prominent with some of his most fastidiously careful drawings, as 'Windsor Lock' (76), and others; and our remembrances of W. Müller are freshened by some of those then novel and remarkable pictures of Oriental subjects which he produced just before his death; and, again, we are reminded of another amphibious reputation, one living equally in oil and water, by 'Cheyne Walk, Chelsea' (187), and 'On the French Coast,' R. P. Bonington. The admirable drawing, called 'Happiness in the Desert' (35), by Carl Haag, is really the most exquisite passage of Arab life we have ever seen, and those productions of L. Haghe, 'The Death of Zurbaran' (88), and 'The Seebel, Cairo' (53), are vigorous and substantial beyond a multitude of more highly-coloured works by their author. The two contributions of the Duke of Edinburgh, by N. Chevalier, illustrate his Royal Highness' experiences in tiger-hunting in the plains of Bengal. 'Waiting for Master' (140), Rosa Bonheur, is a very characteristic group of beagles or other hounds, in manner very different from everything this lady has hitherto done. The drawings by Turner are only two, both small; but the whole collection constitutes an assemblage which worthily sets forth every phase of water-colour Art. Our notice is a monotony of praise; but how can it be otherwise, when the summing up yields such a preponderance of overwhelming evidence in favour of each performance?

MINOR TOPICS OF THE MONTH.

SIR FRANCIS GRAHAM MOON, BART.—The death of this estimable gentleman and valuable public servant took place at Brighton, on the 12th of October. His whole life has been associated with Art: few men have lived in our time to whom it owes so much. We are unable to produce a satisfactory memoir of him this month, but hope to do so in our next.

THE ARTISANS OF FRANCE.—There has been a large exodus of the best and most useful classes of France; and while that unhappy country suffers in consequence, other nations will be enriched by its misfortune. From statistics printed by "authority" we learn that perhaps a hundred thousand of its best hands have either perished or emigrated within the year, the fatal year, 1870. The Report gives these terrible facts:—"In certain branches of industry there is such a scarcity of skilled hands, that the orders given, few as they are, cannot be carried out; and our customers, being thus disappointed, transfer their patronage to England, Belgium, Germany, and even the United States. The third important fact we have to point out, is the excessive emigration of our skilled artisans, who are tempted abroad by seductive and remunerative offers. If this be not checked our foreign competitors will be able to beat us by their superior command of French skilled labour." The evil is rather increasing than diminishing; artists as well as artisans are seeking employment in any country but their own; and the trade of France, in a hundred objects of commerce, is leaving her, perhaps never to return." It is certain that many of the most excellent and experienced of her skilled workmen are finding profitable employment in England; and very soon, no doubt, we shall witness the results of so important an accession of strength, more especially in our manufacturing districts. It is just and reasonable we should profit by the opportunities thus placed within our reach; and, of a surety we shall do so; learning, we trust, a lesson from the sad example of our neighbours, acting in accordance with old counsel:

"Learn to be wise by other's harm,
And you shall do full well,".

HOGARTH.—The best works of this artist are to be reproduced by the process of photography, and published, with new descriptive text. The copy presented to the South Kensington Museum by the late Mr. Dyce will be referred to for the plates.

THE LONDON STEREOSCOPIC COMPANY has issued a series of photographs of works in sculpture contained in the International Exhibition. These, as far as they go, are of much excellence, worthy the high and established reputation of the firm. But they are few in number, and, assuredly, the best selection has not been made; we miss so many objects of interest, beauty, and value, that we are utterly unable to account for the omissions. Surely there could have been no difficulty with the sculptors, who must have desired thus to circulate evidences of their genius. There are, at least, a hundred examples, not in the series, which might have been made better known by the art of photography; we might give a long list of those of which we believe all Art-lovers would desire to possess copies. We have, however, Foley's 'Egeria'; Miller's 'Emily, and the White Doe'; 'Ruth,' by Raemackers; 'Paul and

Virginia,' by Chelli; 'Daphne,' by Marshall Wood; 'The Thorn,' by Fantacchiotti; 'Eva,' by Norchi; 'The Somnambula,' by Fontana; 'The Bathers,' by Jerichau; and some groups in which several are shown together. But the collection is by no means as perfect as it might, and ought, to have been.

FERN DECORATION.—No product of nature has ever been utilised in the way of ornament so successfully as the fern, by Mr. Lee, of 22, Bloomsbury Street. The plant, in its numerous varieties and natural state, is suggestive of endless series of the most beautiful combinations, which can scarcely be enhanced, even by refined taste, when restricting in any way the wild luxuriance of nature. The principle of this adaptation of the natural plant to ornamental purposes is extremely simple, but seems to be susceptible of development into forms and combinations limited only by the capacity of the designer. To describe in a few words the manner of employing the plant, it may be said simply to be arranged on a sheet of plate-glass, and secured in its place by another superposed glass of equal dimensions. Such is the mechanical *rationale* of the process; but so clearly and beautifully is the plant defined, when seen by transmitted light, that the eye is scandalised, if the perfection of artistic composition, or the wild flow of the luxuriant combinations of nature, be wanting to the picture. The plants used by Mr. Lee are exotics and British ferns, and so numerous are the forms, and so elegant the lines, in which they grow, that they afford many phases of natural beauty, inasmuch that it cannot be said that any forms they accidentally assume are otherwise than graceful. The various ways in which Mr. Lee has utilised these plants show us that their application in this direction is but in its infancy. He has already adapted them to *plateaux*, *spandrels*, panels for cabinet work for the ornamentation of halls and corridors, for summer fire-boards, folding screens, *jardinières*, &c. Even when thrown up by silvered glass, and seen by direct light, much of the richness of fern-composition is lost; whereas, when seen by transmitted light, all the beauty and delicacy of the plant are brought out. Thus, especially in town-houses, the fern may be made to perform a useful office, in shutting out from back windows objectionable views, such as most London houses have. Mr. Lee succeeds perfectly in covering staircase and other windows so as to give an appearance of natural growth without obstructing the light. Hence, presenting much beauty of design at a moderate cost, it may be expected that this kind of decoration will, in a great measure, supersede the vulgar glass ornamentation in common use. One of the most effective arrangements that Mr. Lee produces is that on silvered glass; which exhibits all the detail of the graceful fronds, with their different tints; it will, therefore, be understood that in such case the plants most desired are the varieties whence may be formed scales of tone and tint, which will tell admirably by direct light. It is important to state that the ferns are all employed in their natural state; and, as they afford tints from the bright silver fern to the deepest vegetable greens and browns, it is unnecessary to have recourse to chemistry for artificial colour. Among the works already executed by Mr. Lee are some decorations for Sandringham, others for the Duke of Sutherland, and some for the Earl of Dudley. It is impossible to say what directions such a means of ornamentation may take, and to what extent it may be

carried. But, from the specimens of the work we have seen, it bids fair, considering its comparatively moderate cost, to become a style of decoration of great popularity and extensive application.

THE PLAYING-CARDS issued by Messrs. Marcus Ward & Co., for the season, 1871-2, manifest great advance in Art; some of them contain charming pictures, that cannot fail to teach and impress good taste; they are very varied; geometric lines generally, and rightly, prevailing; and exhibiting the best effect in the combination of forms. These cards are known as "Willis's Cards," and are, we believe, in especial favour with whist-players. It is, however, with the exteriors only that we have to do, and these are unquestionably of great excellence.

THE PLAYING-CARDS OF MESSRS. JOS. HUNT AND SONS are also entitled to words of high praise; they are of varied and very beautiful designs, charming examples of good Art, and printed with exceeding delicacy and care: many of them contain pictures that might be framed as specimens of refined beauty. The fame of the cards of Messrs. Hunt and Sons was established long ago; they have been always in high favour with players; it is only recently, however, they have added to their intrinsic value the advantages to be derived from the services of accomplished artists.

A GOLD MEDAL has been exhibited at No. 18, New Bond Street, the establishment of Mr. Harry Emanuel. When it is stated that it weighs 15 ozs., it will at once be recognised as perhaps the largest work of the kind that has ever been successfully executed. It was struck by order of the Peruvian Government to commemorate the repulse of the Spanish Fleet off Callao. The obverse presents a group of four figures representing the republics of Peru, Chili, Bolivia, and Ecuador, taking the oath of alliance. Beneath the group is a shield surrounded by laurel-leaves and warlike trophies, and round the margin is inscribed, "Alianza Americana de 1866." On the reverse is a representation of the town and port of Callao during their bombardment by the Spanish fleet, and above are the figures of Liberty and Justice protecting the town. Four of these medals have been struck in fine gold; three of these are set as centres of magnificent stars, formed of large diamonds of the purest water, and are intended as presents from Peru to the Presidents of Chili, Bolivia, and Ecuador. The designs and models, which are by Mr. Harry Barrett, show great beauty of composition and the utmost delicacy of execution. The work contrasts with recent issues of her Majesty's Mint, to the great disadvantage of the government establishment. The "sovereigns," its latest productions, are perhaps the worst it has ever circulated; worth twenty shillings they may be, but they are valueless as works of Art.

WE hear a project has been set on foot for the purpose of collecting subscriptions to purchase Mr. Melville's large picture, recently in the International Exhibition, illustrating 'The Presentation of the Freedom of the City of London to the Prince of Wales.' As a record of an interesting event in the annals of the Corporation of London, and as containing portraits of upwards of three hundred persons who were present at the ceremony, the painting deserves a place in the Guildhall, where we hope eventually to see it. Our municipal corporations everywhere would do good service to Art by decorating their halls with pictures illustrative of events having a

local as well as a national interest: this the guilds in Belgium and other countries of the Continent frequently do, but the practice is entirely ignored by us in England.

MR. R. A. HILLINGFORD.—With reference to the notice of the works of this painter, which appeared in our number for September, we have been asked to state, in justice to their respective owners, that his 'Julia's Mission' is the property of Mr. F. Turner, of Halifax; and his 'Preparing the Court-Bow' is in the possession of Mr. F. M. Smith, of the same place. The error in the former statement was not ours.

BRITISH POTTERY.—The British potters have been invited by the "authorities" at South Kensington to send contributions in order that an exhibition of their works may take place in Berlin; the project, it is understood, being suggested by and under the direct patronage of the Crown Princess, our own Princess Royal. We believe all the potters have agreed to send specimens of their productions. No doubt much substantial benefit, as well as "great glory," will ensue for the advantage of the contributors. But how it is that the superintendent or "representative" of the manufacturers is a soldier we cannot say; a Major de Winton is to occupy that important and responsible post, and will, no doubt, "read up" to obtain the requisite qualifications. Certainly, the sword is more powerful than the pen at South Kensington; and he is a fortunate gentleman who is also an officer of Engineers.

WORKING MEN'S COLLEGE.—Classes for the study of different branches of Art have been formed at this institution, in Great Ormond Street, under the superintendence of Messrs. W. Cave Thomas, H. W. Brewer, and G. Rosenthal. A series of lectures on Perspective was commenced on the 20th of last month.

MR. T. O. BARLOW is at work on a large engraving from the famous picture, 'La Gloria,' by the late John Phillip, R.A.; and also on a smaller plate from the same painter's 'Prayer in Spain,' his diploma picture presented on his election into the Royal Academy.

THE CRYSTAL PALACE.—A very graceful addition was made to the attractions of the Crystal Palace during the month of October. It consisted of what was called an "Agricultural Trophy:" Messrs. Sutton and Sons, of Reading, the well-known and much-esteemed "growers" of agricultural seed and produce, collected specimens of their varied productions, and exhibited them as evidence of what may be done by care and cultivation—Nature aided by Art. It was really refreshing to see the monstrous yet healthful growth of the several classes of vegetables; turnips bigger than a giant's head; cucumbers three feet long; cabbages, one of which would be a day's food for a bullock; and so forth. It is, however, only with the arrangement of the "trophy" that we have to do. The assemblage, aided by various grasses (to the number of two hundred varieties, green and dried) and other glories of the field, made a novel and charming picture—so striking and so good that Messrs. Negretti and Zambra have photographed it in several views. No doubt the main purpose of Messrs. Sutton and Sons was to show their seeds and the grand births that came from them; and it is certain that the farmers and farm-workers who scrutinised them day after day were profited by the study; but Art-lovers are not the less obliged to them for one of the prettiest and most hopeful sights of the season.

REVIEWS.

ART AND RELIGION. By JOSIAH GILBERT. Author of "Cadore, or Titian's Country." Published by HODDER AND STOUGHTON.

MR. GILBERT's previous writings, of which "Cadore" is the principal, scarcely prepared us for the discussion of such a subject as that he now treats of, in a pamphlet of about seventy pages, forming one of a series of "Essays on Theological and Ecclesiastical Subjects," by various authors. A verse, from the *Book of Wisdom*—"Also the singular diligence of the artificer did help to set forward the ignorant to more superstition"—offers a clue to the arguments he puts forth in treating the matter of Art and Religion in their influence on each other. "Religion will have found in Art large and manifold means of expression; Art will have received from Religion an inspiring motive, and a definite direction. Each will have been modified by contact with the other. We desire to point out the nature of this interaction in the past, as alternately developing and degrading both Art and Religion; and to glance at the limitations a spiritual Religion must impose upon the Art that serves it."

The starting-point of the connection between the two is idolatry. "At the very outset we meet with that oddity the Idol—odd because not only an object of Art, but an object of worship. It is the most pointed instance of the association of Art with Religion, and a problem every way. Was the Idol born of Art? or did Art find the Idol, a shapeless lump, a log, a stone, and by slow degrees invest it not only with the semblance of life, but with beauty and moral expression?" This problem is worked out on the assumption that, though the Fetish would seem to be the natural origin of the Idol, yet the conclusion arrived at is, Religious Art had no such base origin; it did not spring from the Fetish. It was Art that invented the Idol; and to the latter we owe one of the grandest achievements of Art—the Temple.

The subject of ecclesiastical architecture, in which for the purpose of argument must be included Pagan as well as Christian edifices, is briefly traced through the various channels developed in Egypt, Assyria, India, and Greece, till the dawn of Christianity beamed on the world. Race, period, and country effected modifications in Religious Art; each country working in various manners, each influenced by national characteristics, by physical conditions, and by the religious conceptions which these had a hand in moulding.

Before entering upon the subject of the church of the Christian, some reference is made to the Jewish temple and form of worship, the beginning of the period when Art, "while it bodied forth the spiritual, was not to stand in place of the thing signified, but to educate towards its better understanding; and which should supply fitting moulds for thought and language in the future, rather than be itself the product of them." Symbolism here takes up a prominent position, but in the end only to debase the worshipper. "No wonder, then, that this high teaching by means of Art and symbolism should end in that pharisaism which is only a form of fetishism; which counts the letters of the law instead of apprehending its spirit; which binds it on the forehead rather than on the heart; which looks upon the stones of the temple, and the gold of the temple, rather than to Him who dwelleth therein; which makes the temple the seat of man's pride, rather than the place of God's presence."

It was long after the advent of Christ that Art, in its true acceptance, found a home among his followers. "First, because of the intensity of the spiritual life, which could only utter itself through the purest spiritual medium—prophecy, psalm, and hymn. Again, because of the intimate association of Art with Paganism, so that it was at first absolutely forbidden, and an artist was compelled to abjure his Art before he could be baptised. Thirdly, because persecution closed in upon the faith with sword and flame, under which no Art could live. When it did begin to show itself, it was in holes and

corners, and was individual and memorial. It was a silent utterance of faith and hope underground, beside the grave of loved ones, or scratched on the walls of the catacomb sanctuary. Christian Art showed itself at first a tender floweret blooming faint and colourless, without light and air." Gradually it broke forth from its hiding-place till it covered the earth with its temples magnificent in their architecture, and lustrous with the conceptions of the painter, yet all exhibiting "the imaginations of men upon the grandest of themes."

It is to this part of his subject, and especially to what a Christian church of the present day ought to be, that Mr. Gilbert has devoted much thought—and, we will add, much beautiful and eloquent language. We have no space to follow him further: the perusal of his essay has afforded us great enjoyment, both on account of its thorough Art-spirit and the terms in which his views are embodied. We are sure many will share this pleasure with us, and thank us for directing attention to the pamphlet.

MEMOIRS AND LETTERS OF CHARLES BONER. Author of "Chamois-Hunting in Bavaria," &c. With Letters of Mary Russell Mitford to him during Ten Years. Edited by R. M. KETTLE. Two Vols. Published by R. BENTLEY AND SON.

Any record of our friend and occasional correspondent, Charles Boner, the famous "Chamois-Hunter," would have a welcome greeting from us, even were it far less interesting than is this. True, the most considerable portion of the first volume is occupied with the correspondence of Miss Mitford, but these letters are a most agreeable variety to the general contents of the book, and have an interest peculiar to themselves, and no less so as associated with the subject of the memoir.

In the *Art-Journal* of last year appeared a short notice of Charles Boner, soon after his death, which occurred in April of that year. He was born at Bath in 1815; and, at sixteen years of age had made such good use of the educational means afforded him, that John Constable entrusted to him the instruction of his two elder sons. The intimacy thus commenced led to a life-long friendship between the great landscape-painter and his sons, and the tutor of the latter, and, in all probability, it laid the foundation for that love and knowledge of Art which he showed throughout his life. The letterpress to Constable's "English Landscape" was from Boner's pen before he was twenty years of age. Shortly after the death of his parents, between 1833 and 1835, he went to Germany, on the invitation of Baron August Doernberg, Postmaster-General, on whose recommendation he was received into the family of the baron's brother-in-law, Prince Thurn and Taxis, as private secretary and tutor to his sons; the post, which he retained during a period of twenty years, speedily grew into one of great responsibility and confidence. This time was passed chiefly at St. Emeran, near Ratisbon; and we have repeatedly heard him speak of the pleasure and happiness of this term of his life, when he would vary his labours with ranging the Bavarian Tyrol in pursuit of the light-footed chamois.

On one of his occasional visits to England, he made, in 1845, the acquaintance of Miss Mitford, whose writings he had always greatly admired. "For ten years," his biographer says, "he maintained an unbroken correspondence with her, and it is to be regretted that Charles Boner's answers to Mary Russell Mitford's clever, warm-hearted epistles should either have been destroyed or kept back from the public. Notwithstanding every effort to obtain them, they are not forthcoming, and the correspondence must for the present be left imperfect."

The lady evidently held her Bavarian correspondent in much esteem; and the letters she wrote him, and which are here published, show how she opened up her mind upon a thousand matters transacting during those ten years in England; literature, Art, politics, and social life, all are discussed freely and pleasantly, though sometimes caustically, even to undue severity. These letters will be read with much

interest, as containing the thoughts and opinions of a clear-headed, observant, shrewd, and generally kind and amiable writer. Boner possessed these qualities also, and in no insignificant degree; we should, therefore, have liked to see his own views on the same or similar subjects; and especially on what was taking place in the country which he had made his home. To some extent, however, this latter is supplied by the republication of his contributions to various journals and other literary works both in London and America. For example, in 1865 he became special correspondent in Vienna of the *Daily News*; his letters to that paper occupy a very large portion of the second volume; they are well worth reading for the pleasant style in which they are written, his graphic descriptions of places, men, and manners; and for the view taken of the political situation of the times in Germany. Worthy of special notice are the accounts given of the "Seven Weeks War" in 1866; the coronation of the King of Hungary, and the memoirs of the Emperor Maximilian and of Ludwig I. of Bavaria: the service of the latter monarch in the cause of Art was fully appreciated by the writer of these letters for the English journal. Charles Boner's contributions to literature were not, however, limited to newspapers and periodical works; besides his "Chamois-Hunting in the Mountains of Bavaria," a work which obtained a very large circulation, his "Transylvania," a yet more important work, published in 1865, and several minor books; his "Hunt in the Royal Forest," and his "Cain," evidence poetical genius far above the ordinary level. At the time of his death he was preparing for publication the letters of Miss Mitford, which are now given to the public, though without the comments he, doubtless, intended to make on them, and without the history of her life, with which he proposed to preface the correspondence.

Of the man himself, we can, from our own personal knowledge of him, verify the remark of a German writer:—"Charles Boner was the exact opposite of a German's conception of an Englishman; he was truly every inch a gentleman, but, moreover, filled with such wonderful self-sacrifice for others, with such living sympathy for the weal or woe of his friends, as made even the impossible possible. His was a mind without art or falsehood, a noble truth in the fullest sense was his." His only child, a daughter, is the wife of Horschelt, a distinguished Bavarian painter, whose works we specially noticed four or five years ago.

We cordially recommend these volumes as most agreeable reading, full of varied and interesting matter.

GOING TO WORK. Engaved by R. JACKSON, from a Painting by E. EDDIS. Published by ARTHUR LUCAS, Wigmore Street.

Seldom of late years has a print been issued so extremely welcome as this. It is of a class that always gives pleasure; sufficiently large, but not too large, for framing as a "grace" to any drawing-room or boudoir. It represents a young maiden, stepping from childhood into girlhood—a lady born, although her feet are bare. The "work" she is going to do is to search among the rocks and eddies for sea-anemones, or other marvels which the shore yields. She carries her tub and her spade to delve in the sand, over which she paces with joy and hope, redolent of health. It is a lovely face and form the artist has pictured; very pleasant to look upon, either in Nature or in Art. The engraver has done his part well: the spirit of the charming picture has been caught; little labour is apparent, but the full effect which the artist intended to convey is there. We have not, for a very long time, examined a print so altogether satisfactory.

A VILLAGE MAIDEN. By the Honourable AUGUSTA BETHELL. Published by HODDER AND STOUGHTON.

We remember being much pleased with the "Echoes of an Old Bell," and hoping that its fair author would soon present us with another equally interesting volume. "A Village Maiden"

will win many readers, and be admired for its graceful simplicity, and thoroughly good feeling.

The story will especially touch young hearts; the characters of both high and low are well contrasted and cleverly sketched—there are many Lady Seymours in the world; indeed, not only are the characters, as we have said, well contrasted but some manifest a power and knowledge of human nature which is by no means general. We congratulate our readers who make acquaintance with "The Village Maiden."

DRAWING AND MEASURING INSTRUMENTS. By J. F. HEATHER, M.A.; late Mathematical Master at the Royal Military Academy, Woolwich. Author of "Practical Plane Geometry," &c. &c. Published by LOCKWOOD & Co.

Though this treatise is more especially addressed to those whose pursuits are of a strictly scientific nature, there are artists of various kinds to whom it will be found practically useful. It is not a new work altogether, but an enlarged edition, entirely re-written, of one which first made its appearance more than twenty years ago, and has since been continuously used in the military and naval schools of the Government. The instruments brought under notice are those employed in geometrical drawing and in the measurement of maps and plans, and those designed for accurate measurement and for arithmetical computations. The instruction laid down in the text is illustrated by a large number of wood-cuts.

MOOR PARK. By ROBERT BAYNE. Published by LONGMAN & Co.

This very graceful volume describes Moor Park, the seat of Lord Ebury, and gives an interesting biography of the several occupiers through whose hands it has passed, since the manor was owned by the Saxons. The work is thoroughly well done, and the photographic illustrations are good. The plan is after the manner of those with which we have made our readers familiar in our series, "The Stately Homes of England." The mansion has no pretensions to antiquity, and is not picturesque; its history, however, or rather that of its predecessors on the site, is of very deep interest, associated with many of the most remarkable men of past ages, and of times nearer our own: its present owner being a nobleman universally esteemed and respected.

SWISS PICTURES. Drawn with Pen and Pencil. Published by the RELIGIOUS TRACT SOCIETY.

One of the earliest books of the season comes to us long before the frost is on the ground. It is very welcome, its numerous wood-engravings are all of great excellence; charming as pictures, and admirable as examples of Art. Many of them are drawn from nature by Mr. Whymper; other artists have gone to the same source for information; and the result is an immense amount of information, conveyed by the pen and the pencil; for the author, too, has done his work thoroughly well. It is a new, but greatly improved edition of an already popular book. The public is much indebted to the Society for skilfully and happily blending instruction with amusement; teaching as well as interesting a large number of readers, especially the young.

BRITISH HEROES AND WORTHIES. Published by THE RELIGIOUS TRACT SOCIETY.

Our remarks apply with equal force to this very beautiful and instructive book. There are memoirs of twenty British Worthies, beginning with Wycliffe, and ending with Wren. The series is therefore not brought down to a recent period; that, we presume, will be done in a second and a third series. The biographical sketches are written in a sound and healthful spirit. Precept is here teaching by example, and the results cannot be other than beneficial to all readers—young and old.

THE ART-JOURNAL.



LONDON: DECEMBER 1, 1871.



*W*E have again the pleasant duty—in prefacing the thirty-third volume of the ART-JOURNAL—to express our grateful thanks to the public and the many friends by whom we have been assisted and sustained, in our efforts to promote the interests of the FINE ARTS, and the ARTS INDUSTRIAL of our country.

This acknowledgment is due not only to the leading “collectors,” whose galleries have been so frequently placed at our disposal, but to the artists by whom we have been cordially and generously aided; few British painters and sculptors are, therefore, unrepresented in this work; examples of their genius have been here published to the extent of more than a thousand. They have thus been made teachers of the many, as well as ministers of the few.

We may lay some stress on the fact that these engravings are in “the line manner”—the highest order of the art, that would have utterly “died out” in England, but for the sustenance thus accorded it.

To the LITERATURE that illustrates and elucidates ART, we have given continual attention; there is scarcely a writer of eminence on that subject who has not communicated with the public through these pages; the list of such authors is too long for quotation.

Of the articles that first appeared in this Journal, very many have since been issued as books; they had been marked by public approval; and are now valuable acquisitions to the best libraries of the Kingdom.

Of the authors who have aided us, while some have been removed by death, from those who remain we continue to derive valuable assistance; and we record, with gratitude, our appreciation of their services.

While we have assiduously sought to obtain variety, we have taken especial care to promulgate sound principles.

It is, we trust, needless to say that we shall continue by every means in our power—by continual thought and study, by unremitting industry, and by liberal expenditure—to maintain the high position we hold among periodical works, the purpose of which is to gratify and to instruct.

The chief feature of the ART-JOURNAL during the past year has been the ILLUSTRATED CATALOGUE of the leading contents of the INTERNATIONAL EXHIBITION—the eighth thus reported since the year 1844. The efforts made by us—which undoubtedly led to the introduction of such Exhibitions into England in 1851—we have seen crowned with a success that few were sanguine enough to anticipate twenty years ago. British advance in Art-Manufacture is evident in every branch of it. We are justified in believing that the thousands of models engraved in this Journal from the best designs of the best manufacturers of the world, have largely influenced the manufacturers and artisans of these Kingdoms; and that the examples thus supplied have had their natural effect in stimulating effort and promoting excellence.

That is not the only view we are warranted in taking, with reference to the Illustrated Catalogues thus furnished as Teachers. The value of publicity is great; it is a large reward for merit—that which enables it to be estimated and appreciated; the eagerness with which Manufacturers have sought admission to this Catalogue is proof that it produces not only substantial gain but honourable recompense.

The volume for 1871 contains eighty-eight pages of engravings from works exhibited by manufacturers of various countries, chiefly those of England. The objects engraved are about four hundred; less in number than we have given in previous volumes—in 1851-2, in 1862-3, and in 1867-8; but the Exhibition of 1872 was distinct in character, and is to be regarded as but one of a series: moreover, in our issues of preceding years, we found it necessary to lessen the number of steel engravings, or (as in 1851) to charge a larger sum for the publication. We have done neither in 1871: thirty-two pages have been always given with each monthly part, and THREE engravings on steel.

The plan we commenced, and have so far carried out, in the International Exhibition of 1871, we shall continue through the years that follow; giving prominence to the “specialities” of the “division;” but engraving all exhibited works that may be suggestive and instructive, serving as salutary guides to the fabricants of all lands.

While, however, to accomplish this task will necessarily absorb much of our space, and greatly increase the requisite expenditure to produce this Journal, we shall neglect no means that may augment its value in all other departments. We trust an examination of the volume for the year 1871 will be sufficient evidence that while the work is calculated to be useful in the At elier and the Workshop, we by no means lose sight of our duty to make Art popular and prosperous, by rendering the ART-JOURNAL an acquisition to the Drawing-room; that it may be welcomed by the Student, the Amateur, the Collector, and the “Patron,” as well as by the Manufacturer and the Artisan.

16, Southampton Street, Strand.

THE GOLDEN AGE OF ART.

WE propose in the present paper stating facts to show that the last twenty years of our time are worthy of the appellation *golden*, not so much from the excellence of the Art-works produced, as from the unprecedented prices which modern artists obtain for their productions, and the sums collectors are willing to give at sales. The great body of artists were formerly obliged to work for very small remuneration, comparatively, though many paintings for which a miserable sum was paid have subsequently been sold for large amounts since modern Art has been appreciated. There was much truth in Peter Pindar’s advice to Wilson, the landscape-painter:—

“But honest Wilson, never mind,
Immortal praises thou shalt find,
And for a dinner have no cause to fear,
Thou start’st at my prophetic rhymes!
Don’t be impatient for those times;
Wait till thou hast been dead a hundred year.”

Unlike other countries, we can show no native Art till the time of Hogarth. Before that period we were indebted to foreigners for our pictures. Hans Holbein, the German artist, came to England, at the instigation of Erasmus, in 1526, and was introduced to Henry VIII. He died of the plague in 1543, and, it is said, notwithstanding the liberality of Henry VIII., miserably poor. Sir Antonio More visited England in the reign of Queen Mary, but lived the latter part of his life in great magnificence at Antwerp, under the Duke of Alva. Zuccherro and Lucas van Heere gave us portraits of the celebrities of the court of Queen Elizabeth. Charles I., the most enlightened of the royal Art-patrons of England, delighted to heap honours on D. Mytens, the elder, Rubens, and Vandyck. The first of these had enjoyed the patronage of James I., but retired to Holland, when the splendour of Vandyck’s genius became appreciated by Charles I. Rubens, the Titian of the Flemish school, the companion of kings, lived in great magnificence. His splendid portrait, the ‘Chapeau de Paille,’ of a young lady of the Lunden family of Antwerp, has recently been acquired by the nation, being in Sir Robert Peel’s collection. In 1823 it was seen in Old Bond Street by 20,000 people, and Sir Robert gave the large sum of 3,500 gs. for it.* Vandyck came to England soon after Rubens left. He suited the age exactly, was able to live like a great noble, and leave a large fortune, £20,000, a large sum at that time. Charles I. gave him a pension of £200 a year. We, in England, judge this artist for his portraits, but Belgium possesses works of high historic Art by him. Sir Peter Lely and Sir Godfrey Kneller followed. The latter, a native of Lubeck, earned about £2,000 a year by his profession, and is said to have made a remark, the truth of which subsequent details will show. “Painters of history make the dead live, and do not begin to live themselves till they are dead. I paint the living and they make me live.” But all these men, from Holbein to Kneller (d. 1723), were essentially portrait-painters, thriving in the atmosphere of courts. All were foreigners, for until the reign of George I. we find few traces of distinctively English Art, such as the miniatures of Hilliard, and the Olivers, and the portraits of Dobson.

The Art of no country was so completely severed from the ancients. But when the tardy revival did come, we had technical ability and dramatic treatment in Hogarth, appreciation of nature in Gainsborough, and a high style of portraiture in Reynolds. In these men painting found new aims and aspirations. The old masters confined themselves almost entirely to the comparatively restricted field of religious Art, and made painting the “handmaid of theology.” But in the reign of George I., after that of Anne (which, Walpole says, “since the Arts have been in any estimation, produced fewer works that will deserve the attention of posterity”), the

* Rubens in 1635 received £3,000 for the ceiling of the Banqueting House at Whitehall. He told an alchemist that his art was twenty years too late, for he had found out the art of making gold with his pallet and pencil. In 1860 Lord Ward gave 7,500 gs. for a ‘Portrait of a Lady’ (believed to be wife of Sir B. Gerbier).

distinctive characteristics that now charm us in modern Art sprang into existence. In 1726, Hogarth's engravings brought him into notice, and 'The Harlot's Progress' he painted eight years after. Bowles is said to have bought his early etched works at 2s. 6d. the pound of copper! Hogarth studied drawing under Sir James Thornhill, who painted the dome of St. Paul's for about £2 the square yard—a magnificent sum truly! Thornhill asked £1,500 for painting the staircase of the South-Sea House, and received remuneration at the rate of about £1 5s. od. a yard. He was more fortunate with the hall at Blenheim, for which he had £4,000. The six pictures of Hogarth's 'Harlot's Progress' were sold by auction in 1745 at 14 guineas each, being purchased by Alderman Beckford, for Fonthill. Four of these were destroyed by fire in 1755, and the other two were purchased for 750 gs. at the Munro sale, in May, 1867. A portrait, by Hogarth, of Miss Rae made at the sale 530 gs. Beckford bought the eight paintings of the 'Rake's Progress' for 22 gs. each. Sir John Soane, in 1802, was glad to get £27 for the 'Strolling Actresses,' 'Morning,' 20 gs.; 'Noon,' £38 17s.; 'Evening,' £39 18s.; 'Night,' £27 6s. Mrs. Hogarth obtained them for £598. Among other pictures, Hogarth gave 'The Enraged Musician,' and 'The Distressed Poet' to Mrs. Draper, at her death they made only £5 5s. For the six pictures, the 'Marriage à la Mode,' Hogarth only had £110, by selling them by auction in the same manner as before. In 1797 Mr. Angerstein paid £1,381 for them. Sir J. Soane gave 1,755 gs. for four pictures.

Richard Wilson, the English Claude, (1714-82), one of the greatest English landscape-painters, was almost starving when he got £50 a year from the Royal Academy as Librarian. He often received not more than £15 for his large pictures, and took £10 for a portfolio of Italian drawings—eight years' work. In consequence of the death of a brother in Wales, who left him an estate, he was able to end his days in that country in comparative affluence.

Sir Joshua Reynolds was born at Plympton, in Devonshire, in 1723. He finally (after travel and short residences in Devon and London) settled in London in 1753, and there his principal portraits were painted. He is a wonderful example of a successful painter, having made about £6,000 a year, and leaving a fortune of more than £80,000. He sometimes received 150 sitters in a year. He charged about 25 gs. for three-quarter lengths, 100 gs. for half-lengths, and 200 gs. for whole lengths.* The Earl of Carysfort paid Reynolds 50 gs. for 'The Strawberry Girl,' and at the Rogers sale in 1856 the Marquis of Hertford gave forty-two times that sum, or £2,205. Sir Joshua said an artist did not produce more than half-a-dozen really original works, and remarked of this picture, "This is one of my originals." Mr. Timbs, in his "Anecdote Biography," says that the Duke of Rutland gave Reynolds 1,200 gs. for his picture of the 'Nativity,' exhibited at the Royal Academy in 1779, designed for the window of New College Chapel, the Duke saying it was the largest sum ever given for a picture painted in England. It was destroyed by fire at Belvoir Castle in 1826. Two of the emblematical figures exhibited at the same time were, at Lady Thomond's (Sir Joshua's niece) sale, bought by the Earl of Normanton for £1,575 and £1,155 respectively. The seven figures, and other compartments of the Oxford window, offered during Reynolds's life time at £300, after his death made £12,000. Lawrence considered the portrait of 'Mrs. Siddons as the Tragic Muse' the finest female portrait in the world. Sir Joshua valued it at 1,000 gs., but sold it for £700. Earl Grosvenor bought it for £1,760. Reynolds received £840 for the duplicate in the Dulwich Gallery. His executors received £1,500 for the 'Infant Hercules,' painted

for the Empress of Russia in 1786. Mr. Vernon gave 1,450 gs. for the 'Age of Innocence,' 2 feet square. His fine portrait of Miss Penelope Boothby was purchased by Lord Ward for £1,100 at Mr. Windus's sale in 1859; and at the same sale, his portrait of 'Mrs. Hoare' was knocked down to the Marquis of Hertford for 2,550 gs. The poet Rogers got a bargain when he purchased 'Puck,' "an ugly little imp (but with some character) sitting on a mushroom half as big as a milestone," as Walpole called it, for 105 gs., for it was bought at his sale by Earl Fitzwilliam for 980 gs.

Sir Joshua Reynolds said, "If ever this nation should produce genius sufficient to acquire to us the honourable distinction of an English school, the name of Gainsborough will be transmitted to posterity, in the history of the Art, among the very first of that rising name," and Mr. Ruskin went so far as to say that his idol Turner "is a child to Gainsborough." He gained a large income, but was reckless and extravagant. In the height of his prosperity he paid £300 a year for part of Schomberg House in Pall Mall. At first he charged 5 gs. for his half-length portraits, then 40, and afterwards 100 gs. for a whole length. Sir Joshua Reynolds gave him 100 gs. for the 'Girl with Pigs,' when Gainsborough was on his death-bed, though the artist asked but 60 gs. He only valued his 'Woodman' at 100 gs., but it was one of the fifty-six pictures left on his hands, and after his death, Lord Gainsborough bought it for 500 gs. It was afterwards burnt at Eaton Park. 'The Market Cart' was purchased by the governors of the British Institution for £1,102 10s. in 1828, at Lord Gwydyr's sale, and presented to the National Gallery. In 1860 the National Gallery gave £1,000 for his portrait of Mrs. Siddons; and his picture of the beautiful Mrs. Graham, now in the Scottish National Gallery, was added to the Graham collection at a cost of £2,000. In May, 1867, at the sale of the Schockerwick Park Collection, his 'Harvest Waggon,' containing portraits of the artist's daughters, fetched 2,950 gs., and a landscape 1,800 gs.

The prices which Wright of Derby (1734-97) received for his paintings were thought very high at the time, but would appear small for such compositions now. Alderman Boydell gave him 300 gs. for 'Prospero in his Cell,' and 140 gs. for 'The Storm' (from the *Winter's Tale*), for the Shakspeare Gallery. The highest price he obtained for a picture was £420, for the 'Siege of Gibraltar.' The highest price for a portrait was £126, for Mr. and Mrs. Arkwright and their child. Many of his portraits were painted for three guineas.* Mr. Phillips, in the *Monthly Magazine*, Oct., 1797, says, Mr. Wright "repeatedly evinced much liberality by giving valuable pictures to individuals among his private friends, or to persons to whom he thought himself obliged. In various instances these gifts were manifestly disinterested; and they were always conferred in a very pleasing manner, which declined, rather than sought, the expression of gratitude."

Barry (1741-1806) received £300 from the Society of Arts for his six years' labour on the scenes representing the Progress of Human Development, for the room in the Adelphi. It should be mentioned that he volunteered to do the work for nothing, but he began the work with 16s. in his pocket, and frequently after working ten hours a day at these pictures, he was obliged to go to his miserable home and paint for hours more to gain his daily bread. He got £200 by engraving these paintings, and £500 more for exhibiting them, making about £166 a year by them. And yet they were much praised. Critics and nobles flocked to the rooms, and desired to give them their gracious approbation, though they allowed the artist in later years to starve on about £60 a year. He died in 1806 in great distress, his funeral being paid for by Sir Robert Peel, father of the distinguished statesman.

Two years prior to that date, Moilard had

* See Memoir by Mr. Remrose in "The Reliquary," iv., 217, edited by Llewellyn Jewitt, F.S.A., an admirable periodical work far too little known: it is mainly addressed to antiquaries and archaeologists, but contains much matter of interest to the general public.

died in a sponging house; a dreadful wreck, through his own imprudence and low habits; for at one time there was such a rage for his pictures that he could earn 70 to 100 gs. in a week, which he spent as fast as he earned.

Hilton and Haydon were born in the same year (1786). What a melancholy story of genius unappreciated do their lives afford us! The former—according to Mr. S. C. Hall, who considers him the finest historical painter of the age—never had a commission, and did not sell six pictures of size all his life. His picture of 'Edith finding the Body of Harold' was exhibited for a season at the Royal Academy, and returned to him unsold. He cut it from the frame, rolled it up, and had it placed in a cellar. Mr. Hall mentioned the circumstance to Mr. Vernon, who purchased it for £200. It is now in the National Gallery, and would realise £2,000 at least.* Hilton was glad to accept the post of Keeper to the Royal Academy on the death of Fuseli. Haydon was certainly more appreciated than Hilton, but though great men tried to help him, he was always in pecuniary difficulties.

Let us now turn to a very successful man, West (1738-1820), who painted what people liked, and knew the art of gaining patrons. It is true he has been called the "Monarch of Mediocrity,"† but judged by a golden standard, his success was great. West, the successor of Sir Joshua in the Presidential Chair of the Royal Academy, was born in Pennsylvania, and came to England in 1763. He was fortunate enough to attract the notice of Drummond, Archbishop of York, who introduced him to George III. By reason of his great tact he soon stood high in the estimation of that monarch, and executed a number of pictures for him. The Quaker-artist netted £21,700 for his series of twenty-eight pictures representing the Progress of Revealed Religion for the royal chapel. His good fortune diminished when the king became ill; but the British Institution gave him 3,000 gs. for his 'Christ Healing the Sick.'

Fuseli, born at Zurich, 1741, came to England in the same year as West. 'The Nightmare,' his most popular picture, was painted in 1781, and sold for twenty guineas. He suggested to Alderman Boydell the idea of the "Shakspeare Gallery," and painted eight pictures for it. Mr. Coutts, the banker, was a good friend to Fuseli, and paid him considerable sums for his pictures. The "Milton Gallery," however, was a great failure. Fuseli painted forty pictures, which he exhibited, in 1799, in Pall Mall; six friends, two years before, having advanced him £300 a year till he had completed his task. The artist had been looking forward to this exhibition as a great success, but the money taken at the doors was not enough to pay the rent of the rooms.

For many years Sir Thomas Lawrence (1769-1830), earned between £10,000 and £15,000 a year, but was always in difficulties. "I began life wrongly," he said once. "I spent more money than I earned, and involved myself in debt, for which I have been paying heavy interest." His prices, in 1794, were 100 gs. for a full-length, 50 for a half, and 25 for the head; in 1806, 200, 100, and 50 respectively; and in 1810, 400, 200, and 100 gs. According to Timbs's "Anecdote Biography" his latest prices were, for a head size 200 gs., for a kit-cat 300, half-length 400, a bishop half-length 500, full-length 600, and for an extra full-length 700 gs. Lord Gower paid him 1,500 gs. for his portrait of Lady Gower and child, and Lord Durham 600 gs. for that of his son. Williams, in his "Life of Lawrence," says that Sir Thomas was only paid 300 gs. each for the numerous full-length portraits of George IV. in his coronation robes, seated in St. Edward's chair, at the

* "Book of Memories," 468.

† West said, "There are but two ways of working successfully, that is, lastingly, in this country for an artist. The one is to paint for the king, the other to meditate a scheme of your own" ("Anecdote Biography," Timbs). "Herbert's Moses," said Mr. Maclise, is, in my mind, worth all that West ever produced, and yet the nation gives grudgingly a most inadequate price to the painter of such a picture, the result of many years of toil, while West received, it is said, not less than £34,000 from George III. for the work he executed for the king." (O'Driscoll's "Life of Maclise," 208.)

* These are believed to have been the prices in his latter years. Cotton says, when at St. Martin's-lane, for a head, half-length, and whole-length, he charged 10, 20, and 40 gs. respectively; in 1757, 15, 30, and 60 gs.; and in 1766, £30, £50, and £150. Much interesting information respecting Sir Joshua and his works will be found in "Life and Times of Sir Joshua Reynolds," by Messrs. Leslie and Taylor (Murray, 1865).

time when he was receiving twice that sum for full-length portraits.

Constable (1776—1837) was not appreciated by the public. At times he was almost in despair, and driven to write, "The painter is totally unpopular, and ever will be, on this side of the grave." A picture, for which he received £100, has been sold at Christie's for £1,700. His 'Hay-Wain,' that made such a sensation when exhibited in Paris in 1825, formed one of a pair he sold for £250. This picture, in the collection of H. Vaughan, Esq., was recently exhibited among the works of old masters at Burlington House. Sir D. Wilkie (1785—1841) when nineteen painted a picture with 140 figures, but could not obtain more than £25 for it. Next year his 'Village Recruit' was placed in a shop-window soliciting a purchaser at £6. In 1806 his 'Village Politicians' was painted on commission for 15 gs., but later he sold his 'Parish Beadle' to Lord Colborn for 350 gs.; and in 1820 the Duke of Wellington gave him £1,200 for the 'Chelsea Pensioners,' and he received £1,200 more for the copyright. Mulready lived to see his pictures making large prices. In 1861 his 'Punch' made £1,000 at Christie's; in 1863, his 'First Voyage,' 1,450 gs. S. Prout (1783—1852) never valued his best works at more than £60, though one for which he received that sum has been sold at Christie's for £1,400; £6 was the price he charged for his smaller drawings. At the Lancaster sale (March 14, 1868), five of his finest works averaged 528 gs. each; one, 'Nuremberg,' making 955 gs.; Mr. S. C. Hall believes that William Muller (1812—1845) never received more than £100 for any of his beautiful works. They have been more appreciated at recent sales. At that of the collection of Mr. Bullock, May, 1870, his 'Slave Market' made 900 gs., and a landscape, 'Compton Dando, near Bristol,' 1,250 gs. David Roberts (1796—1864) lived to see his works making large sums. The largest price he ever received was 1,000 gs. for the 'Interior of St. Peter's at Rome.' His drawings of the Holy Land, the property of the late Earl of Ellesmere, 122 in number, were sold, April 2, 1870, at Christie's, and made £7,337; one, 'The Chapel of the Annunciation,' realising 200 gs. C. R. Leslie's (1794—1859) 'Sancho and the Duchess,' at Rogers's sale, made 1,170 gs.; Rogers gave £75 for it. At the Bicknell sale, in May, 1863, his 'Heiress' made 1,200 gs., and in 1870 his 'Rape of the Lock,' 1,300 gs. Three pictures by Clarkson Stanfield (1793—1867) at the sale of Charles Dickens's collection made 990, 150, and 175 gs. respectively. They had been painted as scenery for Wilkie Collins's dramas. At the Bicknell sale (1863) his 'Beilstein, on the Moselle' made 1,500 gs., his 'Pic du Midi d'Ossan,' 2,550 gs.; and 'Rochelle Harbour,' sold in 1868, 2,180 gs. At the Flatou sale, in 1867, his 'Grand Tor, Oxwick Bay,' 1,200 gs. Etty's (1787—1849) 'Joan of Arc,' in 1861, made 3,000 gs., and his 'Scene from Comus,' at Mr. Bullock's sale last year, 1,000 gs.

Turner (1775—1851) was enabled by the high prices he received for his works and by "investments," it may also be presumed, to save a fortune of £140,000. Between 1803 and 1815 (his best period) his prices for pictures ranged from 150 to 200 gs. In 1810 Lord Yarborough gave him 300 gs. for 'The Wreck,' which would now fetch at least £2,000 at Christie's. Mr. Thornbury, in his "Life of Turner," tells a story of Mr. Gillott, the Birmingham manufacturer, determining to get into Turner's house in Queen Anne Street; he asked Turner if he had seen their "Birmingham pictures," and then showed him £5,000 of new notes and got pictures in exchange for them. Turner found his best patrons among the manufacturers, and not the noblemen, of England. One enthusiastic merchant offered to buy the whole stock of paintings, drawings, and engravings in Queen Anne St. for £100,000; Turner told him he had refused a similar offer before; and he would not be tempted when Dives offered guineas. This same person offered him £1,000 for his sketch-books, now belonging to the nation. Chantrey bought a "Turner" for £250, which at his death made £1,500 at Christie's. Some noblemen and gentlemen offered to buy his two pictures, representing the 'Rise and Fall of Carthage' for

£5,000, in order to present them to the National Gallery. Turner at other times refused large sums for pictures he intended to leave himself to the nation. The 'Rise of Carthage' was painted for a gentleman for £100, who refused to have it. He received £1,025 for his 'Guard-Ship,' 'Cologne,' and 'Dieppe'; these three, at Mr. Wadman's sale, in 1854, made 5,380 gs. For his 'Grand Canal, Venice,' and 'Ostend,' he had 400 gs.; in 1860 these fetched respectively 2,400 and 1,650 gs. At the Bicknell sale, in May, 1863, ten of his pictures made £17,361, which had cost the owner from 250 to 350 gs. each. The same year Lord Ashburton gave £1,890 at the Allnutt sale for his 'Tivoli.' In 1864 six water-colour pictures made £3,500 gs. at Wheeler's sale. In May, 1867, his 'Modern Italy' fetched 3,300 gs. at Mr. Monro's sale; but when sold again in May, 1868, made 480 gs. less. At the Lancaster sale, in March, 1868, a drawing, 'Oberwessel, on the Rhine,' sold for 900 gs. At Mr. Ruskin's sale (April 15, 1869) forty drawings by Turner made 2,207 gs., the highest fetching 315 gs. Some of those, it should be mentioned, were mere sketches. His 'Slave Ship,' painted in 1840, unengraved, made 1,945 gs. On the same day another collection was sold that contained a drawing of the 'Lake of Lucerne,' which had made 680 gs. at the Bicknell sale, then rose to 980 gs. Two days after, Christie sold sixteen fine drawings by this artist, the property of Mr. Dillon, for £7,800; of these 'Rivaux Abbey' made 960 gs.; 'Folly-hill, Yorkshire,' 890 gs. and 'A Landscape,' 1,200 gs. Twenty-nine other drawings were sold by the same auctioneers later in the same month for £5,000; so that in April, 1869, eighty-six drawings by Turner realised £16,000. At Mr. Bullock's sale, May, 1870, 'The Dogana and Church of Santa Maria della Salute, Venice' made 2,560 gs. Mr. Bullock is believed to have paid the artist £200 for this work in 1844.

With a detail or two from the prices gained by the late lamented Daniel Maclise (1811—70), we shall pass on to consider the remuneration gained by living artists, and shall then find the high prices even of Turner surpassed. Though Maclise received some considerable sums for his works,—such as £2,100, from the Art-Union of London for his 'Death of Nelson,' £2,000 from Lord Northwick for the 'Marriage of Strongbow and Eva,' and £5,000 for his fresco of the 'Death of Nelson,' at Westminster, and £3,500 for the 'Meeting of Wellington and Blucher,'—some of his pictures have, when we think of their high Art-qualities, made low prices. At Mr. Bullock's sale, May, 1870, his 'Alfred disguised as a Minstrel in the Tent of Guthrum the Dane' made only 530 gs.; and at the sale, June 25, last year, of the unsold works left at the decease of the painter, the last picture he ever painted, the 'Earls of Desmond and Ormond,' was bought by a dealer for 500 gs. Many pictures and drawings at the Maclise sale were almost given away.

Mr. Flint gave £1,000 for Millais's 'Black Brunswicker,' but it was sold in 1862 for £819. In July, 1863, it made £840 at Christie's, and at the same sale his 'Carpenter's Shop' fetched £570. In April, 1862, his 'Proscribed Royalist' made £551, and in October, same year (Windus sale) his 'Isabella' realised £682, and his 'Ophelia,' £798. 'Vanessa,' exhibited at the Royal Academy, 1869, sold for £700, and, *on dit*, that the Marquis of Huntley paid £2,000 for the portrait of the 'Marchioness,' exhibited in 1870. T. Faed's 'Sunday in the Back Woods of Canada' sold for £1,700. At the sale of the Somes collection (March, 1867) his 'Train up a Child' made 860 gs.; and in the same year 'Cottage Piety,' 725 gs., and 'From Dawn to Sunset,' 1,700 gs. Holman Hunt received from Mr. Gambart for his 'Finding of Christ in the Temple,' £5,500, but he had spent six years' labour upon it. His 'Scapegoat,' exhibited at the Royal Academy in 1856, was sold at Mr. Windus's sale, in 1862, for 495 gs. In 1861 Gambart bought his 'Hireling Shepherd' for 605 gs. 'Isabella and the Pot of Basil,' which perhaps showed Pre-Raphaelitism in its best aspect, exhibited in 1868 at Gambart's gallery, cost Mr. Hunt two years' labour, but he received £2,000 for it. The finished sketch for this picture sold,

May, 13, this year at Christie's, for 525 gs., and at the same sale his 'Il Dolce far Niente' made 710 gs.

Mr. Hall, in his "Book of Memories," says that so recently as 1849—50, J. Linnell had very rarely been able to sell a picture. Mr. Vernon, at Mr. Hall's recommendation, bought 'The Storm,' in the Vernon Gallery, for £40; it would now fetch £800 or £1,000. Mr. Linnell has seen a picture for which he received £50 sold for £1,200, and his works now command large prices. At Mr. Bigg's sale (February, 1868) his 'Glorious Harvest—Sunset,' made 1,030 gs. In April, 1870, his 'Storm in Harvest,' 1,350 gs.; at Mr. Bullock's sale, in May of same year, 'The Woodlands,' 1,300 gs.; and April 29 this year, at Mr. Brook's sale six magnificent landscapes, a series painted for Mr. Brooks, averaged 758 gs.; the highest making 890 gs. At the same sale two pictures of a like character, by James Thomas Linnell, made respectively 640 and 705 gs., and Sir Noel Paton's 'Christ bearing his Cross,' exhibited at Westminster Hall, where it obtained the 300 gs. prize, made 900 gs.

Mr. Jacob Bell ordered the 'Derby Day' of Frith for £1,500, and Gambart gave £1,500 more for right of engraving and exhibition. It was rather more than a year in hand. Mr. W. Maynard says for the 'Railway Station' Frith had £6,000 altogether, though it is generally stated to have been more; that is, £4,500 for the picture, £750 for a *replica*, and £750 for the right to exhibit. Mr. Graves afterwards purchased it, and "says" it cost him £23,000. The *replica* made 980 gs. at Mr. Flatou's sale, May, 1867. Her Majesty commissioned him to paint the marriage of the Prince of Wales for £3,000, and Mr. Flatou paid 5,000 gs. for the copyright. In former times artists were anxious to get their works engraved, and never thought of asking any sum for the copyright; now, this is sometimes larger than the sum paid for the picture. At the Dickens's sale Frith's 'Dolly Varden' made 1,000 gs. Sir E. Landseer, for the copyright of the 'Highland Drovers,' one of his early successful pictures, received 200 gs. only, and for that of the 'Dialogue at Waterloo,' 3,000 gs. His 'Dead Game,' in 1853, was sold for 1,200 gs. He received 500 gs. for 'Titania with Bottom and the Fairies,' and for this Lord R. Clinton gave, in 1860, 2,800 gs. His 'Peace,' 'War,' 'Refreshment,' and 'The Stag at Bay,' were exhibited at the Academy in 1846, for these he received, including copyright, £6,850. At Flatou's sale, in 1861, 'Deer in the Lake' made 1,000 gs. At the Bicknell sale two years afterwards, three pictures, 'Two Dogs,' 'Highland Shepherd,' and 'Prize Calf,' made respectively 2,300, 2,230, and 1,200 gs. For the first two Mr. Bicknell had given £300 or £350. The same year, 'Attachment' made 1,000 gs., though at a sale soon after a whole length portrait by Vandyke, unsold since the Restoration, could only find a purchaser to give £110 for it. Landseer's picture of the 'Bears,' exhibited at the Royal Academy, was understood to be sold for 3,500 gs. At Mr. E. L. Betts's sale, May, 1868, his 'Braemar Gathering' made 4,000 gs. In 1870 the 'Highland Shepherd's Home,' at Mr. Bullock's sale, realised 1,000 gs., and the 'Swanery,' exhibited the year before at the Academy, was said to have been sold to the Marquis of Northampton for 4,000 gs. *On dit* that Mr. G. D. Leslie sold his beautiful picture, 'Fortunes,' in the Academy last year, to a dealer for £1,000, who before the day was out resold it for £2,000.

Three drawings by Copley Fielding were sold at the Bicknell sale in 1863 for 530, 600, and 760 gs.; they had been purchased respectively for 36, 42, and 25 gs. An example of this artist sold at Christie's, May 13, this year, for 795 gs. Doré disposed of his large picture, 'The Gaming-Table at Baden' to an American gentleman for £2,200. He is said to have produced more than 45,000 designs, *without assistance*. £150,000 has been expended by the French and English publishers, Messrs Hachette and Messrs. Cassell in bringing out his illustrated works. Some time ago the *Gaulois* stated that Doré had signed a contract for five years with an English publisher, by which he undertook to come to London, for two or

three months every year, to make 250 designs on each occasion. For this work he was to receive £10,000 a year, or £40 for each design!

The sums we have quoted as given for works of modern British Art, show that never in the history of the world were such prices paid for paintings in proportion to their intrinsic worth. And this is not only the case with the most popular artists, second and third-rate painters have participated in the advance. The whole scale of artist's remuneration has progressed, and is progressing.

The influence of the dealer is one of the chief characteristics of modern Art. He has taken the place of the patron, and to him has been owing, to a great extent, the immense increase in the prices of modern pictures. When Messrs. Agnew, of Manchester, commenced business the trade in British pictures was very hazardous. This firm, at the Bicknell sale, in 1863, purchased about £30,000 of pictures, and £24,000 at Mr. Bullock's sale in May, 1870; this will give an idea of the magnitude of their operations. The prices realised at the Bicknell sale were large; the 140 oil-paintings made £51,600, or more than £412 each. The entire proceeds of the Bullock sale were £44,250. In 1868 a case in the Court of Probate gave us part of the history of Mr. Flatou, the late picture-dealer. He was a Polish Jew, and in 1854 had not £5 in his pocket. Thirteen years after he had made £50,000, and, according to the defendant's statement, was worth double that amount. He dealt almost exclusively in works by British artists. The pleasant intercourse between artist and patron is, to a great extent, done away with, and the general public have to pay 25 per cent. (often much more) for their pictures.

How few artists there have been who could say with Blake, the Visionary, "My business is not to gather gold, but to make glorious shapes expressing god-like sentiments." Professor Ruskin, in his "Political Economy of Art," believes one of the principal obstacles to the progress of modern Art to be the high prices given for good modern pictures, and that artists are too apt to think "worldly and wealthy eminence" is the goal to be reached by Art. The patron deprives himself, by what he gives for the fashionable picture, of the power of helping the younger men who are coming forward. He thinks prices above 100 gs. for water-colours, above 500 gs. for oils, are in general extravagant. He says, "the real facts of the matter are that the British public, spending a certain sum annually in Art, determines that of every thousand it pays, only five hundred shall go to the painter, or shall be at all concerned in the production of Art; and that the other five hundred shall be paid to the intelligent dealer, who knew what to buy." Here is a piece of capital advice for the buyer. "Look around you for pictures that you really like, and in buying which you can help some genius yet unperished—that is the best atonement you can make to the one you have neglected—and give to the living and struggling painter at once wage and testimonial."

The last ten years we have spent £150,000,000 on our army, so that our legislators need not grudge us the few thousands which go to purchase pictures for our National Collection.* The Angerstein collection, purchased by the government in 1824 for £57,000, formed the nucleus of the present gallery. It may be interesting to note the prices which have, at various times, been given for these pictures. The gem of the Angerstein collection was the 'Raising of Lazarus,' by Sebastian del Piombo. The Cardinal Giulio de Medici commissioned Raphael to paint the Transfiguration, and Sebastian, the Raising of Lazarus. Michael Angelo was so jealous of Raphael, that he made several sketches for Sebastian. Some of these were in Sir T. Lawrence's collection.

* From 1824 to 1855, 96 pictures have been purchased; but 155 were purchased during the next eleven years, at an average cost of £662 2s. 10d. The 155 represent 8 schools of painting and 111 masters, extending over seven centuries (Catalogue Pict. Nat. Gall. by R. N. Wornum). Such purchases as the Blacas collection of Antiquities, &c., in 1867, for £48,000, and the recent one of Sir R. Peel's splendid pictures for £70,000, must not be forgotten.

The Cardinal intended them both for the Cathedral of Narbonne, but he only sent Sebastian's picture there. The Regent Duke of Orleans purchased it for £1,000, and at the sale of his collection, Mr. Angerstein secured it for 3,500 gs. It is stated that Mr. Beckford offered the latter £15,000 for it, but Mr. Angerstein wanted *guineas*.* Rembrandt's 'Woman taken in Adultery' cost him £5,000, and 'Christ Blessing Little Children,' purchased in 1867 for the gallery of M. Swcenardt, cost £7,000. George IV. gave £5,250 for the 'Master Ship-builder,' by the same artist. 'Christ and St. Peter,' by Caracci, was secured for £8,000. Lord Carlisle gave £4,000 for his celebrated picture, the 'Three Maries.' Two Claudes in the National Gallery cost Mr. Angerstein £8,000.† In 1856 we paid the Menzi family of Milan £3,571 for Perugino's 'Virgin Worshipping the Infant Christ;' for Francia's altar-piece, £3,500; and in 1867, £13,650 for the 'Family of Darinus,' by Paul Veronese (1528—88). This was exhibited for many years at the Pisani Palace in Venice. It is said that Paul, when on a visit to the family, left this picture in his room to pay the cost of his entertainment. As a general rule he did not receive large sums for his pictures, many being done for churches. We have had to pay rather dearly for our Correggios; 'Ecce Homo' and 'Mercury instructing Cupid' cost 10,000 gs.; and 'La Vierge au Panier' (13 in. by 10) £3,800. Correggio (1494—1534) received £1,500, or 500 crowns, for his 'Coronation of the Virgin.' Earl Dudley gave £1,600 for a replica of the 'Reading Magdalen,' which was discovered under a water-colour drawing, sold in Rome for a few *scudi*. 'Christ with the Banner of the Resurrection,' by Fra Angelico, bought in 1860, cost £3,500. It is interesting to remember that this chief of the mystic school refused the Archbishopric of Florence. Carlo Crivelli's 'Madonna and Child' was purchased in 1863 from Count Luigi de Sanctis for £2,182; Ward's 'Bull and Cow,' £1,500; and Pesalli's 'Holy Trinity,' £1,200. In 1867 the 'Garvagh,' Raphael, was bought for 9,000 gs. Augustus III. purchased the 'Madonna di San Sisto,' the gem of the Dresden Gallery, for £8,000, from a convent at Piacenza. The splendid example of Crivelli, the altar-piece which decorated the chapel of Prince Demidoff, was secured for £3,360. Two pictures, one by Van Huysum and the other by Cuypp, were sold at Christie's in 1868 for 764 gs., and in the following year were purchased for the National Gallery for £1,800. Up to the middle of the eighteenth century no work of Cuypp had fetched more than 30 florins. What a difference now! £3,000 was offered for an example in the possession of Lord Brownlow. Nine-tenths of his pictures are to be found in England. 'The Entombment of Christ,' ascribed to Michael Angelo, was purchased in Rome for £2,000. At the Delessart sale in Paris, March, 1869, 'Interior of a Dutch House' by De Hoghe, was secured for our collection at the high price of £6,000.‡ We have never given so

* "Jottings from the Note-Book of an Undeveloped Collector," *Coruhill Mag.*, Sept., 1867.

† The Marquis of Hertford gave £4,550 for Claude's 'Rainbow Landscape.'

‡ At the same sale Raphael's 'La Vierge de la Maison d'Orléans' was bought by the Duc d'Aumale for £6,000. In 1763 this was in the Crozat collection; subsequently in that of the Abbé Decamps. M. Hibbert sold it in 1828 for 200 gs. Teniers's 'Fish-Market' made £6,300; a landscape by Cuypp, £3,880; a Wynants, £2,040; Bonington's 'Francis I. and Mary of Navarre,' £1,240; 340 works realised £77,400. At Count Kocheleff-Besborodko's sale in Paris three months after, Grenze's 'Hermit' made £2,200 (bought for the Empress); two Teniers, £1,000 each; a Vander Velde, £1,080, and Paul Potter's 'Fight of Bulls' was bought in for £1,980. The latter was soon after offered in London, but only 1,450 gs. were bid for it. The same month the Marquis de Maison's collection was sold: a Grenze (Madeline Blonde), £1,960; his Madeline Brune, £1,320; and Pater's 'Le Concert Champêtre,' £4,000. At the San Donato sale (April 18, 1868), twenty-two pictures made £54,398. The prices were enormous—Terburg's 'Congress of Munster,' £7,280 (bought at the sale of the Duchess de Berri for £1,450); Cuypp, 'Avenue of Dordrecht,' £5,000 (bought for £750 at same sale); Paul Potter, 'Cattle Grazing,' £4,480 (£1,450 Berri sale); Hobbema, 'A Forest,' £4,400 (£830 Berri sale); Mannheim, 'The Village,' £4,040; other examples of Hobbema, Teniers, and Terburg made £3,920, £3,080, and £2,840. The latter picture ('Curiosity,' by Terburg), actually sold for £48 at the Berri sale. At the sale of the San Donato pictures in Paris, Feb., 1870, eighteen by Grenze made £28,940. The works of the

much for a picture as the French government, who paid 615,300 francs (£24,600) for the 'Ascension of the Virgin' by Murillo, at the sale of Marshal Soult's collection in 1852. We might have had this in 1824 for a small sum; even in 1848 Soult offered, we believe, to take £6,000 of our Government for it.

Thirty or forty years ago was the engravers' golden age, when sums varying from 100 to 200 gs. were paid by publishers for engravings averaging 5 sq. in. in size. Mr. Hall paid Le Keux 180 gs. for an engraving of that size (the 'Crucifixion,' after Martin), and 140 gs. to J. H. Robinson for a portrait no larger, from a painting by the elder Pickersgill. Early engravers earned considerable sums of money. Woollett (1755-85) had £6,000 or £7,000 for his 'Death of General Wolfe.' James Ward, R.A., made £2,000 a year by the engravings from his pictures. In 1819 Messrs. Robinson and Hurst agreed to give Sir T. Lawrence £5,000 a year for the exclusive privilege of engraving plates from his pictures. For the right of engraving the portrait of the Duke of York, the two children called 'Nature,' 'Little Red Riding Hood,' and the portrait of George IV., with one or two others, they paid Sir Thomas £10,000.*

Sculpture has never had its "golden age" in England. Nollekens amassed a fortune, chiefly by making busts and monumental works for the Government, so did Bacon, Banks, and Chantry. Flaxman received for his designs for the "Iliad" and "Odyssey" (39 of one and 34 of the other), 15s. each, and for many of his models for Wedgwood he had only half a guinea. A copy by Wedgwood of the celebrated Portland vase has made at Christie's £200; one sold, however, in July, 1865, for £27. In June, last year, Christie sold nineteen works by the late B. E. Spence, of Rome. The whole realised only £1,425, some only making 28 gs. each.

JOHN PIGGOT, JUN.

SELECTED PICTURES.

GOING TO THE HAYFIELD.

H. Cameron, R.S.A., Painter. E. Burton, Engraver.

THIS is the work of an excellent Scottish painter of *genre*-subjects, who has won his way into the highest rank of the Scottish Academy. Some of Mr. Cameron's latest works are 'The Light of the Fireside,' 'The Village Well,' 'Resting,' 'The Toilet,' 'The Errand,' 'Play,' of which, in our last year's review of the Scottish Academy Exhibition, it was said, that "it must command laudation from all who are familiar with the sweet winning ways of childhood; these two little beings, teaching the kitten to leap, are full of airy grace and innocence." Most of these pictures found purchasers in the painter's studio, before they were exhibited.

The picture here engraved was exhibited in Edinburgh in 1859: the best comment we can make upon it is to quote the observations of our critic in his report of the exhibition. The writer is referring to the young men then rising into notice, and he says,—“First among these youths, Hugh Cameron may be placed; his picture of 'Going to Hay'—two country girls proceeding to the hay-field, and singing as they go—being one of the best specimens of colour and legitimate artistic finish which has been exhibited in Edinburgh for years; and there were very few pictures exhibited in London last year superior to this in the two qualities named. The tone and texture, and simplicity of style achieved, is a high standard from which to make another start.”

old masters sold for comparatively small prices. The collection made £100,000, and the porcelain, bronzes, and furniture, £93,000 more.

* Thornbury's "Life of Turner," i. 249.



H. Cameron
1858-9

HUGH CAMERON, R.S. A. PINXT.

E. BURTON. SCULPT.

GOING TO THE HAY FIELD.



BRITISH ARTISTS:
THEIR STYLE AND CHARACTER.
WITH ENGRAVED ILLUSTRATIONS.

No. CII.—ROBERT THORBURN ROSS, R.S.A.



BEYOND the northernmost part of the United Kingdom the works of this artist are comparatively little known; for, unlike the majority of Scottish painters, he has, we believe, never exhibited either in London, or in the galleries of provincial towns south of the Tweed. Yet in Scotland his works are much sought after, and he holds a good position among the painters of *genre*-subjects; helping to sustain the reputation of the school with which he is associated.

ROBERT THORBURN ROSS, a native of Edinburgh, was born in 1816. At the age of fifteen he was articled to Mr. G. Simson, R.S.A., at that period considered the principal Art-teacher in Edinburgh. While engaged in the studio of this painter, young Ross attended the schools of the Trustees' Academy, which has aided in the education of so many of the best Scottish artists of our day: here he studied for three years under the superintendence of Mr. (afterwards Sir William) Allan, R.A., R.S.A. At the expiration of the term of apprenticeship, Mr. Ross

settled in Glasgow as a portrait-painter, remaining there some years as his head-quarters, but frequenting other principal towns in the west of Scotland to practise his art. In 1842 he went to Berwick, on a visit to his father, who had served in the Royal Artillery, and had been appointed master-gunner of that famous Border-town. Berwick proved such favorable "sketching-ground" for the artist, that he remained there ten years, and then returned to Edinburgh. Prior to his leaving the former place he began to exhibit regularly in the galleries of the Scottish Academy, and has continued to do so ever since, sending each year three or four works on an average. His first picture appeared there in 1845; it was called 'The Spinning-Wheel,' and was very favourably noticed by several members of the Academy. Of his earliest works, one, 'The Dead Robin,' was engraved, and others found ready purchasers in the Royal Association for the Promotion of the Fine Arts in Scotland, and among private individuals; as, for example, his 'Pious Conversation'—not a well-selected title, by-the-by; his 'Courtship,' 'The Mote in the Eye,' 'Blowing Hard,' a group of children playing with a toy-boat, bought by Mr. Potts, of Manchester; 'Cottage-Children,' purchased by Captain Mitchell Innes, of Ayton Castle, and engraved; 'The Sleeping Child,' 'The Lesson,' 'Children and Dog,' bought by the Association.

In 1852 Mr. Ross was elected an Associate of the Scottish Academy. Of his works of the next few years may be mentioned 'The Harried Nest;' 'Hide and Seek,' purchased by Mr. J. Graham, of Skelmorlie Castle, and photographed on a large scale by the Art-Union of Glasgow for their subscribers; 'The Thorn in the Foot,' bought by Sir John Marjoribanks, of Lees, Berwickshire; 'Fishers' Shieling;' 'The Dancing-Lesson,' the property



Drawn and Engraved by

THE RETURN

[Stephen Miller.]

of Mr. J. Scott, Lancaster Gate, Hyde Park; and 'The Bible.' Our recollection of 'The Dancing-Lesson' is, that it is characterised by appropriate expression and excellent colour.

The best picture exhibited by this artist in 1857 was the 'Boathouse near Eyemouth.' One of his works of the same year, 'The Dame's School,' was purchased, when on the easel, by the com-

mittee of the Glasgow Art-Union, and was never publicly exhibited. Among those sent to the Academy were, in 1858, 'Spinning Woo,' and 'Innocence;' in 1859, 'The Broken Pitcher,' bought by Mr. Wilson, of Glasgow; and 'A Country Lassic,' purchased by a brother-artist, Mr. D. McNee, R.S.A. When painters buy works of each other, it is sure evidence of the estimate put on them.

'The Foundling,' exhibited in 1860, was bought by Mr. James Richardson, of Edinburgh; and 'A Highland Interior,' exhibited the following year, was painted for Sir Dudley Coutts Marjoribanks.

'Leaving Home,' as we remarked at the time of its being exhibited, in 1862, was one of the best pictures Mr. Ross had produced up to that date; it was purchased and engraved by the Scottish Association. Next year he exhibited 'HIGHLAND PETS,' another commission from Sir Dudley C. Marjoribanks, which we have engraved; and 'The Old Master-Gunner's Story of Waterloo,' the gunner being no other than the painter's father.

The artist once told us a story with reference to this picture, which would scarcely be credited, except on such authority. We have already stated that the elder Mr. Ross filled the post of master-gunner at Berwick; and he is represented, in the composition, in his semi-official uniform, narrating to his grandson the story of the famous battle, and is directing the boy's attention to a certain passage in a picture of the engagement, hanging over the mantel-piece of the room in which they are assembled. The old gentleman had been long in the service, was present through the whole of the Peninsular war, and also at Waterloo. After



Drawn and Engraved by]

HIGHLAND PETS.

[Stephen Miller.

his death, his son applied to the owner of the picture for permission to have the head photographed, as a loving memorial, and was actually *refused the request*. Certainly, the churlish collector, whose name we do not know, or we might be inclined to give it, is a man utterly void of right feeling.

With several nice little bits of Scottish landscape, Mr. Ross exhibited, in 1864, 'THE RETURN,' engraved on a preceding page, and purchased, when on the easel, by Mr. Robert Crossman, of Cheswick House, Northumberland. There is no novelty in the subject, but it is treated very skilfully and pleasantly. The sailor, who

may have been a "ne'er-do-weel" as a youngster, has grown into a stalwart man during his long absence at sea, so that even his mother, who throws her arms round his neck, scarcely recognises him; while the grandmother peers through her spectacles with a still more dubious look. The sister seems at once to accept him, and with a welcome smile; but his younger brother lifts his head from the porridge-basin with an air of incredulity or of indifference; while the dog, as is the wont of the animal, sniffs round the legs of the stranger, uncertain as yet whether it is his duty to seize them, or to give their owner a hearty greeting. The group

is put together with much ingenuity, and the feeling thrown into its component parts is appropriate and pointed.

'*WHAT'S AT THE WINDOW?*' another of our illustrations, is a humorous representation of cottage-life "over the border." This picture was also bought, when on the easel, by Mr. Gibbons, of Liverpool, and was exhibited in Edinburgh, in 1865. Here, as in the preceding work, the artist has shown great skill, both in the arrangement of the figures, and in their masterly execution. A little bit of courtship, apparently, is going on at the window of the adjoining room, and the curiosity of the venerable grandmother is

excited by hearing voices: hence her query of the little girl. The expression given to the old woman's face is capital, and her attitude, that of attempting to rise from the chair, as if she would judge for herself, is most truthful. Other pictures exhibited with it were, '*The Cotter's Daughter*,' also purchased by Mr. Gibbons; '*Salmon-Fishing*,' &c. '*The Fisher's Home*,' bought by Mr. Crossman, above mentioned, before it left the studio, and exhibited, in 1866, is one of those pleasant and cheerful scenes of home-life, of which the artist has produced so many.

Among more recent pictures may be named '*The Highland*



Drawn and Engraved by

"*WHAT'S AT THE WINDOW?*"

[Stephen Miller.]

Shepherd's Fireside,' purchased by the Scottish Association, and '*The Goswick Salmon-Fisher*,' both exhibited in 1867; '*The First Journey*,' and others, in 1868. The following year Mr. Ross was elected Member of the Scottish Academy, to whose exhibition his principal contribution was '*Salmon-Fishing on the Tweed, at Berwick*,' another work that found a purchaser in the Scottish Association. Last year he exhibited his diploma picture, entitled '*Asleep*,' a cottage-interior; and four subjects of fisher-life, '*Preparing Bait*,' '*Baiting the Line*,' '*Dyeing the Net*,' and the '*Music Lesson*;' and, in the present year, '*Sunshine*,' bought by

Mr. John Scott, of Edinburgh, and several fisher-subjects, both in oils and water-colours: Mr. Ross' works in the latter medium are as popular as those in the former.

This artist has evidently studied Scottish life in the cottage, on the sea-coast, and by the river-side: his pictures are all of this class of subject, which he renders with fidelity, and under the most attractive aspects. He is an excellent colourist, and shows true feeling for the picturesque, both in his figures and their surroundings, whether in or out of doors.

JAMES DAFFORNE.

INTERNATIONAL EXHIBITION,
1871.
THE FAN COMPETITION.

As one of the means by which the suitable employment of educated women could be promoted in a direction consonant with their tastes and domestic comfort, the Science and Art Department commenced, some two or three years ago, to offer prizes for the best designed and painted fan-mounts executed by the female students in the various Schools of Art throughout the country. In addition to the prizes awarded, the Department purchased the best works, and placed them with the growing and now very interesting collection of fans and fan-mounts in the South Kensington Museum.

When the International Exhibition of 1871 was fairly announced to the public, Her Majesty the Queen, being desirous to encourage the art of fan-painting by females, notified to the Royal Commissioners her intention to offer a prize of £40 (1,000 francs) for the best fan exhibited on that occasion, "being either a work of painting or carving, or a combination of both, and executed by a female artist, under twenty-four years of age." Of course, certain conditions were laid down in detail by the authorities of the Exhibition, calculated to promote a proper understanding of the nature of the works to be sent in, and secure a proper adjudication of the several prizes: the example of the Queen having been followed by Mrs. Herbert Taylor, the Lady Cornelia Guest, the Baroness Meyer de Rothschild, and Messrs. Howell, James & Co., all of whom offered prizes varying from £25 to £10 each, on similar conditions to those on which the Queen's prize was to be awarded.

It was very unfortunate that, owing to the late war and the condition of Paris during the winter of 1870-71, the female fan-painters and mounters of that city could take no part in the competition, and thus an important and interesting element in a really successful display of designs was wanting. Still the competition, though limited, was by no means devoid of interest: although the adjudicators felt it necessary to recommend that Her Majesty's prize should be withheld, from the fact that no work of sufficient merit to warrant its adjudication had been sent in competition. The other prizes, however, were awarded in such a manner as appeared to the judges most equitable; Mrs. Herbert Taylor's prize being divided into two parts.

One interesting feature of the friendly rivalry amongst the ladies concerned, was the fact that H.R.H. Princess Louise (Marchioness of Lorne) was one of the successful competitors, and that to a fan-mount, designed and executed by the Princess, the prize of £10, offered by the Lady Cornelia Guest, had to be awarded. The subject is a skating scene on a river. The grouping is exceedingly well managed for the purpose of a fan-mount, as the eye runs agreeably through the composition. The central object is a lady in an ice-sledge pushed along by a vigorous skater, while in the foreground, to the right, are two adepts—a lady and gentleman, who disport themselves pretty much after the fashion that one might imagine Benedict and Beatrice might have done, had Shakspeare introduced a skating-scene into his play of *Much Ado about Nothing*. In the middle distance, and on the opposite side of the composition to the two figures quoted, are illustrations of the timidity of beginners in the art of

skating. The costume is tastefully chosen, and the general tone of the work is silvery and pleasing.

The highest prize awarded by the adjudicators was one of £15, a portion of the £25 offered by Mrs. Herbert Taylor. This prize was given to Miss Henrietta Montalba, who has been a successful competitor on several occasions in the schools' competition of the Science and Art Department. The subject of the fan-mount selected is 'Shooting at the Popinjay,' and is treated in a very spirited and artistic manner, with a quaint touch of mediævalism in the details of the costume. The colouring of the group of ladies on the left of the subject, in the midst of whom a gallant gentleman excites the jealousy of one dame by his elaborate attentions to another, is an admirable episode in the design.

A second prize of £10, the balance of the amount offered by Mrs. Herbert Taylor, is also awarded to Miss Henrietta Montalba for a fan-mount, to which a prize of £5 was awarded in the recent Schools of Art competition, and purchased by the Science and Art Department, in whose name it is exhibited. The subject is a banquet of the olden time in a baron's hall. The grouping is in the manner of Paul Veronese, and the arrangement of the design is very ingenious—the lower portions of the arc of the mount being connected with the banquetting-hall by a flight of steps leading to the kitchen, in which the preparations for the festivities are in progress in right baronial fashion. The corresponding portion of the design on the opposite side shows the cellars, in which attendants are busy "drawing" for the revellers above, or drinking themselves. The idea is very original for the purpose, and is carried out with spirit.

Miss Hilda Montalba takes the prize of £10 offered by the Baroness Meyer de Rothschild, by the admirable design of 'A Water-Party.' A river-bank is represented, and down some marble steps a gallant is handing a lady into a boat which is already occupied by other dames. The sides and foreground of the work resting on the cord of the arc of the mount are admirably filled by swans, herons, and wild fowl, disporting themselves amongst the rushes. The tone of colour in this work is, to our minds, the best in the whole collection. The same competitor takes one of the prizes of £5, into which Messrs. Howell, James & Co.'s prize of £10 is divided, for another design illustrating 'Les Graces.' This work received a prize of £2 in the late schools' competition, and was purchased, and is exhibited, by the Science and Art Department.

The fifth prize awarded in this competition is to Miss Linnie Watt, for a fan-mount to which £2 was adjudicated in the Schools of Art Exhibition of Fan Designs. This work is also purchased for the South Kensington Museum, and is lent by the Science and Art Department. Messrs. Howell, James & Co.'s second prize of £5 rewards Miss Linnie Watt's skill in the production of a very well-conceived work, the subject of which is 'Love attended by Cupids.' This old theme is treated with considerable originality. A lover reclines at the feet of his mistress, who is seated on a bank below which a stream runs to each side of the composition. Cupids sport in the stream and upon the margin, fishing and wreathing flowers for the lovers. The arrangement of the design is good, but the treatment lacks the precision of touch and careful finish so essential in a work to be so closely examined, as a fan-mount must bear to be, when in use. The prize, however,

was well merited by the conception of the design and the general vigour which characterises the execution.

Amongst the designs not recognised by the adjudicators, the best are certainly some of those which obtained prizes in the last competition of the Schools of Art throughout the country, and to which prizes were awarded by the Science and Art Department. That entitled 'Oracles,' by Miss Ellen Montalba, is cleverly arranged and well executed, but the design is a little too mystical in intention to be clearly understood. The figures are treated with considerable skill and power. It received a prize of £3 in the schools' competition.

Miss Susan James, of the Hull School of Art, sends two fans in competition, both the property of the South Kensington Museum, having been purchased out of the recent competition of the Schools of Art. The best is 'Haymaking,' a treatment in monochrome, blue on a pale blue ground of silk, the high lights touched with white in *tempera*. The balance of the parts is well kept, and the artist has not attempted more than she could intelligently accomplish; a point which has been seriously overlooked by the greater number of the competitors. This fan was also rewarded by a prize of £3 in the schools' competition. The other fan is a tastefully and well-executed example of flower-painting, passion-flowers arranged to suit the form of a fan-mount, and was commended in the above-named competition.

A fan-mount by Miss Mary A. McGee, of the Dublin School of Art (Royal Society), is a very satisfactory treatment of birds and butterflies, with an open and well-arranged foliage as a background. The distribution is agreeable, and the theme original. The execution, too, is fairly managed, for the objects, especially the birds, are difficult ones to treat well. This design was awarded a prize of £1 in the School of Art competition, and was purchased by the Science and Art Department.

Miss Maria Eassie, of the Gloucester School of Art, contributed a very prettily-treated fan-mount, arranged in a series of festoons of flowers supported by *amorini*; emblems of music, painting, and sculpture filling up some of the interspaces. The foliage and flowers are elegant in treatment, the touch being crisp and intelligent, whilst the general tone of colour is especially happy in its adaptation to a fan-design.

We have already mentioned that many of the designs were too ambitious in character, and evidently far beyond the powers of the competitors to treat with anything like precision and artistic intelligence. No regard seems to have been had to previous training, practice, and experience. The question was not, "What *can* I do?" but "What *shall* I attempt to do?" Thus many of the designs bear evidence of power, which, if applied to less elaborate work, would have brought the executants out of the competition with credit; although success, as regards the prizes, may not have been possible with the more simple and modest, yet withal sensible, effort.

In this category the fan-mount, the property of the Science and Art Department, and painted by Miss Florence E. P. Spiers, of the Oxford School of Art, must be placed, and which, although unrewarded, was purchased from the late schools' competition. The two mounts, by Miss Mary Jane Bliss, also deserve notice for simplicity of arrangement and perfect adaptation to the uses of a fan.

THE DUDLEY GALLERY.

FOURTH WINTER EXHIBITION.

ON entering a gallery of pictures with an eye ready for the reception of beautiful impressions, the spectator's first thought is often one of unlimited praise for all the works exhibited. After tiring sight and body with an hour's inspection of the works, the second thought may be one of unlimited indifference for both landscape and figure; and, finally, when eye and body have rested for a few hours, praise is modified by judgment, and indifference only remains for inferior works. Let us notice the pictures now hanging in the Dudley Gallery, in this fourth period of observation; and we may, on the whole, consider it an exhibition of average merit, for though there is an absence of striking works, yet there is a fair sprinkling of such as display artistic capacity.

When we see the names of G. F. Watts, G. D. Leslie, H. S. Marks, J. D. Watson, Arthur Hughes, G. Mason, H. Moore, Simeon Solomon, J. A. M. Whistler, Briton Riviere, and Val Prinsep, in the list of exhibitors, we may be sure there will be interesting, if not valuable material. As the hanging committee has given the place of honour to Mr. Watts's finished design for a large picture, 'The Angel of Death' (132), we shall do well to examine the claims this work possesses for its distinguished position. In the first place, we cannot fail to be impressed by the dignity of the subject, and its grandeur of treatment; secondly, we are both surprised and delighted to note that the artist has given us a noble and compassionate female figure for the angel of Death, instead of following in the old fantastic mediæval track of depicting a ghastly grinning skeleton. The ancients, by the way, have said tender things of Death's angel, and represented her on monuments as a soft, lovable figure, half-sister of Sleep. In Mr. Watts's design we see a monarch who lays down his crown; a soldier, who gives up his sword; a cripple, who lays aside his crutch; and a mother, who parts with her child; while raised above the group the angel of Death stands with a calm yet compassionate gaze, half in the act of benediction, half as if she would beckon the figures into the silent land. The feeling of the picture is poetical, and the colour reminds us somewhat of the Venetian school; but a warmer, fuller key would have given the reminiscence more force, though the subject seems to demand subdued tones. The claims of the picture to its place of honour, we think, are well-grounded. Leaving Mr. Watts's noble idealism, let us turn one pace to the left, and we have Mr. J. D. Watson's charming fancy, 'When Lubin is away' (120), the single figure of a peasant-girl seated on a bank that overlooks the sea; admirable drawing, subtlety of colour, simplicity of treatment, combine to make us delighted with a very slight matter. The blue haze of distant sea is tenderly given, and in fine harmony with the dreamy, abstracted expression of the girl. How different is Mr. J. M. Burfield's 'Das Kammerkätzchen' (145), which is cleverly painted. This *kammerkätzchen* is as saucy and pert as Kotzebue's *Lischen*, in 'Der Wildfang,' and as natty as any of the naggiest *soubrettes* in a Paris theatre. The artistic skill displayed in portraying a bold, forward chambermaid, might have been better bestowed on a worthier subject. Mr. Briton Riviere deserves high praise for his touching episode, 'His only Friend' (62); and if the dog that caresses his poor little vagrant master, lying dead-tired by the wayside, is not crying, we never saw a dog so near shedding tears.

Mr. J. E. Hodgson's 'Disputed Move' (39) is full of vigorous action and brilliant colour, with a quaint touch of humour besides. The position of the nearest disputant is somewhat Z-shaped, if we may hazard such an expression. The hooded friar-like individual in the right-hand corner of the picture seems to enjoy the dispute amazingly in a sleek, quiet way, and by his easy repose forms a good contrast to the animation of the chess-player. Mr. Simeon Solomon takes not un-frequent delight in the gloom of dark interiors; but, like Rembrandt, he

also delights in the contrasting glory of strongly lighted surfaces. 'Carrying the Law in the Synagogue at Geneva' is, except to Jews, an uninteresting, and, to all, an undramatic, subject; but nevertheless he has made it interesting and grateful by the full richness of colour given to this little cabinet-piece. The rendering of yellow surfaces worked over with gold thread is a favourite study with this artist, and one in which he excels. The glimpse of blue sky through the synagogue is a happy suggestion of freedom from this dim interior. Had Mr. Solomon named his 'Marguerite' (217) 'A Reverie,' we should have been better satisfied, but as the title stands we feel there is something lacking to complete our ideal of Goethe's Marguerite. Nevertheless, the modelling of the face is very beautiful, and the half-shut eye is tender and full of love.

Mr. Hemy never idealises the faces and figures of his models; if perchance they happen to be somewhat ill-favoured, he bates not a jot of their plainness of feature or unconvexity of form when he transfers them to canvas. It would seem scarcely requisite for the truthful rendering of mediæval scenes, that the artist should insist on such a general and unflinching lack of beauty; but we feel that these are the unfortunate conditions on which 'The Evening Promenade on the Ramparts of Tongres' (234) was painted. There is, moreover, such a dreary expression in the faces of his figures, that we might almost fancy the personages of this mournful promenade were in hourly expectation of being besieged by an enemy, instead of taking the evening air for health, and a gossip for pleasure. This persistent gloominess mars the pleasurable effects of Mr. Hemy's work, despite his powerful colour and his originality of treatment. His study of 'Porlock Weir' (189), though full of light and very true to nature, bears some of the severity of his mediæval subjects. Turning to Mr. H. S. Marks, we are led to believe that some few hundred years ago the world was not actually blank and void of laughter and smiles. His 'Village Gossip' (206) contains a touch of nature—good-humoured, garrulous old age being drawn to the life. "A good old man, sir—he will be talking," is the key to the whole picture.

Mr. G. D. Leslie, A.R.A., is determined that the Dudley Gallery shall have one sweet face to glorify and brighten it, and therefore, with the kindest instincts for the necessities of this exhibition, sent 'The Chorister' for our admiration and delight, and we must fain admire her for her bright innocent face and soft dove's eyes. 'The Chorister' is twin-sister evidently to Nausicaa, whose beauty charmed so many visitors to Burlington House this past summer. The painting is firm, good, and masterly, the drapery well drawn, and the undefinable piece of background an artistic triumph. What shall be said of Mr. Arthur Hughes's 'Ophelia'? We remark that it shows very tender poetical feeling: that there is beauty of line in Ophelia's figure and drapery; that her eyes are wild and strange, yet full of melancholy; that the quiet spot where the will "grows aslant the brook, and shows his hoar leaves in the glassy stream," is steeped in the same tender melancholy that dwells in the eyes of "poor Ophelia." We commend the artist for having chosen the prelude to the tragedy rather than the tragedy itself for representation. We could almost find fault with Mr. Hughes for his careful finish of the quilted satin of Ophelia's dress, but in this case we should have to be severely critical with the delicate elaboration of flowers and grasses, and this we have not the heart to do. Mr. Val Prinsep is generally powerful in his conceptions, but he is so often abrupt, and uncompromising. 'Sir Harry Wildair' (67) has a bright face full of intelligence, with a dash of mischief in it; but the figure seems to be growing out of the wall, and the yellow whip has something of an impertinence about it.

The 'Study of a Spanish Gipsy' (34), by Mr. J. B. Burgess, is brilliantly painted; but why do Spanish and other gipsies eternally show their teeth on canvas? A smile is grateful, but a grin is simply a grimace; and beginning with Murillo in his beggar-boys, and going down through long generations of Art to Mr. Burgess, we enter our

protest against widely-parted lips and displays of teeth.

We must not omit to notice a small picture by Mr. Alfred H. Tournier, 'After You' (276). Two highly-bred gentlemen stand at a doorway bowing and waving hands, each intimating by their gestures that death could cheerfully be suffered rather than the dishonour of committing a breach of etiquette. Which of these courtiers had the audacity to pass first through the door, Mr. Tournier has yet to tell us. The humour of this piece is most excellent.

The landscape-element is not very strong in this Exhibition, the most noticeable works coming from the hands of Mr. George Mason, A.R.A., Mr. C. J. Lewis, Mr. H. Moore, Mr. S. Walton, Mr. A. Ditchfield, Mr. A. S. Grace, and Mr. J. A. M. Whistler. Mr. C. J. Lewis sends a charmingly-fresh picture, 'Hay-making' (31), with an admirable study of pollard willow, and a suggestion of meadow that brings with it the scent of new-mown hay, and the happiness and promise of spring, "the swoote season of the year." The 'Berkshire Mill-Race' (125) contains some fine qualities of colour, and there is a windy look about the sky and trees; but the rushing water of the mill-race we feel is scarcely as light and bubbling and buoyant as it should be. Mr. George Mason contributes four masterly sketches, of which 'Angmering' (315), and 'Bridge below Tivoli' (326), are the finest in intention. An occasional sketch or two in an exhibition of this kind is a grateful relief after seeing much highly-finished work, like a light passage in one of Beethoven's sonatas. Mr. Whistler, however, has quite made up his mind to be a contributor of sketches only; in his 'Variations in Violet and Green' (225), and 'Harmony in Blue Green' (265), we certainly are treated to some subtle gradations of colour, and perhaps there are few artists who could have expressed so much in so few touches of the brush; but still we think there are few artists who would have had the audacity to let those touches of the brush remain so rudely and raggedly visible. We are dissatisfied, for when we see so much has been achieved with ease, it is but fair to expect that more should have been attempted. We cannot close our eyes either to faults or to beauties. When an artist has great gifts like Mr. Whistler, the more jealous should he be of sullying by indolence or neglect a beautiful artistic instinct. Of Mr. Frank Walton's three pictures we give the palm to 'Cover Wood' (32), with its rosy flush of sunset-sky, its autumn woodlands, and its purple line of distance. 'In the Crimson Evening Weather' (46), by the same artist, is noticeable for a careful study of sky, and a burst of warm light, on the rise of a Surrey moorland; but the foreground is inclined to be harsh and uninteresting. Mr. A. J. Grace gives us a delightful shudder in his idea of 'A Cool Afternoon,' (83); wherein the effect of wind and misty rain is most ably rendered, presenting an English meadow cheerless in aspect, as Mr. C. J. Lewis has given it a cheerful one in his 'Haymaking.' But in his 'Sussex Homestead' (164), Mr. Grace makes the *amende honorable* in showing how warm, and tender, and amiable an English field and farmstead can look, if only taken in the right light. "All things in order stored, a home of ancient peace." In Mr. A. J. Ditchfield's modest, unpretending little picture we see how charmingly grey-green can tell in the making of a landscape. It is really soothing to the eye to come upon this artist's works, after being dazzled by the glow of flaming sunset skies, yellow whins, and purple heather. We scarcely think Mr. H. Moore is as strong as usual this year: of his three contributions to the gallery we prefer his 'Sawpit, Sunset, Sussex,' (216), for it is full of poetry, and yet has more of decided artistic purpose than his other pictures. Mr. C. P. Knight's 'Weathering the Land before nightfall on the granite coast of Cornwall' (173), shows a sky that has partially cleared after heavy gales, but it is one of those rapidly-shifting skies that will blot out both moon and stars in an hour or two, what with the accompaniment of tremendous gusts of wind, and the roar of maddened breakers. Mr. Knight's conception is fine. There is still good work to be looked at in the gallery, but space will not permit of our pointing it out.

AN EXHIBITION OF THE ARTS, INDUSTRIES, AND MANU- FACTURES OF IRELAND:

THERE is no country in the world for which Art could do so much as it could do for Ireland. With its enormous natural wealth, its thousand appliances for manufactures, Ireland does "next to nothing" in augmenting the national wealth. It would, alas! be easy to show the why and the wherefore—why capital is kept away from it, and wherefore the energies of its people lie dormant or run to waste. It is indeed, and in sad truth, a country of capabilities that produces comparatively nothing. Yet its resources have been developed, and its means convincingly shown by a few men of enterprise, some of whom prosper as a consequence. The productions of Messrs. Fry, not only of Tabbinets (for which they have long been famous), but of "Terries," that find their way into hundreds of residences—through the upholsterers of England mainly, who do not say they are Irish—have introduced into Ireland a new industry; and the porcelain establishment at Belleek promises competition with the potteries of Staffordshire; the linens and diapers of Belfast maintain their supremacy; but the list of industrial products into which Art enters is terribly small. Year after year passes, and little or no improvement is made. The country retrogrades rather than advances, and hope in its prosperity is vanishing with time. All other people are moving forward; Ireland still keeps in the background.

It is entirely certain that Ireland has been pushed back by the foolish or wicked cry for "home rule," by thrusting farther and farther off that intercourse with England by which only Ireland can prosper. In proportion as these veritable enemies of Ireland work for its degradation, should be the efforts of its true patriots; they may render the evils nugatory, and will certainly make them less, by showing that when capital develops the resources of Ireland, there is surety of an abundant harvest.

We welcome, with much satisfaction, the programme which announces an "Exhibition of the Arts, Industries, and Manufactures of Ireland," about to open in Dublin in what is called the "Exhibition Building"—an admirable and very spacious structure erected in 1865, which, not long ago, was rescued from ruin by the sons of a most liberal and patriotic gentleman—Mr. (afterwards Sir Arthur) Guinness.* They purchased the structure which "all Ireland" was unable or unwilling to buy; and this is one of the ways whereby they hope it may be utilised.

The manager and secretary of the proposed Exhibition is Mr. Edward Lee, who made for himself a high character as acting secretary at the Crystal Palace. He has energy, activity, experience, and much general knowledge—with suave manners calculated to make him popular in Ireland. The superintendence could not be in better hands; and we have reason to believe the experiment will be eminently successful.

Valuable aid may be given by England. There may be a small section of the Irish people who will consider English help an insult, and who would refuse it altogether; but the great mass in Ireland, knowing they need assistance, will ask for it and receive it gratefully. We venture to assure Mr. Gladstone that he has the power greatly to conciliate as well as benefit Ireland; and that a fair share of the money-grant to South Kensington transmitted to Ireland would do more real service in promoting friendship between the two countries than a score of acts of Parliament to meet the demands of this party or of that.

It is small sores that irritate most; and it is certainly an Irish grievance that South Kensington gets the lion's share and keeps the residue. It is neither wise nor just that the Irish capital should be required to do for itself what is done for the English Metropolis out of the public treasury.

We shall give details of this most praiseworthy project when it is more advanced.

* Sir Arthur Guinness, Bart., and Edward Cecil Guinness; the building is now their joint property.

ART IN CONTINENTAL STATES.

PARIS.—The two months, just past, have renewed the annual young artistic competitive struggles for the *Grand Prix*, as it is appropriately termed—the mission to Rome—which, as indicative of how the order of things is resumed after the late monstrous interruption, deserves a passing note. They were preceded by the "Troyon" bonus, a prize of 1,200 francs, liberally dispensed each year by the widow of the late eminent artist, for the production of an original landscape oil-painting. As that sum in times like the present is not unworthy the yearnings of the student-class, which, in this instance, is allowed to embrace all under thirty years of age, a richly productive struggle might have been anticipated. No such result, however, has been realised. The subject was 'An Inundation,' and the absence of merit in nine out of the ten canvases exhibited was truly pitiful. The prize was awarded to Louis Henry Saintin, a pupil of M. Pils. The *Grand Prix* inspirations have, happily, been of much better promise. In Painting, the subject was drawn from the Greek tragedy,—the blind *Œdipus*, led at his command, by his daughter Antigone, to the spot where lie the bodies of his wife slain by her own hands, and his sons slaughtered by their foe. In woe unutterable he bids them farewell. This was surely a most difficult subject for composition, drawing, colour, and expression. Its treatment by the ten competitors was creditable for all, without eliciting any such speciality of original *verve*, as might suggest the agency of genius. In the successful work of M. Toudouze is strong expression, and in its general effect a subtle poetic impression in which he stood alone.

In Sculpture, the subject was also difficult, but most appropriate for *alto-relievo*, 'The Flagellation of Christ in Prison.' This is a familiar and favourite theme on the Continent. It takes its place, either in painting or sculpture, in the illustrations of the Passion which are presented in the interiors of all the Roman Catholic churches. The blemish of eight out of ten of the groups produced on this occasion, was, apart from feebleness of expression in the chief figure, accessory groups of thoroughly disgusting, grinning, and scowling ruffians. In avoidance of this, the work which gained the award of the judges is eminently conspicuous. It is characterised throughout by energy and elevation, quite contrasted with the proximate illustrations, which seem to emulate the grotesque wood-carvings of the Art ante-renaissance period. We shall be surprised if the name of the author, M. Marqueste, does not hereafter take a place of honour among French sculptors.

In Architecture, the subject given was that of a House of Legislature, quite uncalled for at the present time. The chief work here, by M. Ullmann, unites to an elaborately ornate centre, two wings distinctly apart, and comparatively simple. Much elegance of conception, in the composite order,—without, however, grandeur of effect,—distinguishes the whole drawing. Looking back to similar exhibitions, it may be concluded that the young French school is rallying with good heart to meet the future now opening before it.—The *Académie des Beaux Arts* has awarded the architectural prize of Achille de Clère to M. Desliquères, pupil of M. Questel.

Apropos of architecture in connection with Paris, it is of interest to note that the reconstruction of the column in the *Place Vendôme*, is on the eve of commencement. This task has been committed to the very competent hands of Messrs. Etex and Reynard, and its rapid completion may be anticipated. Whether it is to be surmounted by an allegorical statue of France, or the *Redingote Gris* is to have a restoration, seems to be still an undecided point. It may be remarked, that one of the most incomprehensible proceedings of the third Napoleon was the deposition and exile of this truly historic monument to Courbevoie, where its Trajan column elevation was exchanged for a low pitiful pedestal in an unfrequented locality; while to its place was hoisted up, with laborious engineering, the mockery of a Roman emperor. Nor is the consolation left that it was thus

preserved from the insult of a downfall by the hands of Communists, inasmuch as it was subjected to that purposed degradation in the purlieu of Courbevoie.

With regard to the great public buildings, monuments as they are termed in French, which have been so thoroughly injured by conflagration, they also will be subjected to restoration, in accordance with that elastic energy which is so obvious, and so worthy of admiration in the proceedings, on all sides of Paris, for repairing the vast ruins of a double bombardment. The official architects of the municipal council have been entrusted with the heavy duty of ascertaining to what extent the destructive process has been carried out, and upon their several reports, which, duly printed and constituting an immense volume, are to be presented to each member of the body; the proximate estimates of restoration will be attained. One item in this anticipated exposition has already been put in course of realisation. The municipal authorities are already occupied in recruiting an absolute *corps d'armée* of building operatives. It is roughly estimated that their number will be not less than fourteen thousand men, with engagements for three years. The restoration of the Tuileries will, it is understood, have the preference: indeed, it appears that these ruins are no longer to be allowed to disgrace the city. M. Thiers has decided forthwith to have the business of their re-edification undertaken. M. Lefuel was commissioned to draw up a plan for adapting the building to the purposes of public offices, and it has received the approval of M. Thiers. An immediate application will be made to the Legislative Assembly for the first instalment of funds required for this undertaking.

The Gobelins.—With the authorisation of M. Campenon, the contractor of this celebrated manufacture, the following list of the losses sustained in the Communist contest has been published:—*Ancient Tapestry*: 'The History of St. Crispin'; a fragment of the hangings known as 'The Parnassus'; 'The Months'; a fragment of 'The School of Athens'; a fragment of 'The Triumph of the Gods'; a fragment of 'The Wars of Alexander.' *Modern Tapestry*: 'The Aurora' of Guido; 'The Assembly of the Gods,' after Raffaele; 'The Assumption of the Virgin,' after Titian; 'Sacred and Profane Love'; 'The Air,' a fragment from Lebrun's 'Elements'; 'Elysium' (the Seven Senses), after the designs of Baudry and Dieterle; a tapestry after Boucher, &c.

MADRID.—Spain has recently lost one of her most distinguished artists, the sculptor Piquer. As far back as the Paris Exhibition of 1840-41, he won a very high repute for a statue of St. Jerome, which united grandeur of conception to a bold, accomplished style of execution. In it general contemporaneous criticism recognised a production of the highest promise. From that period his merits were thoroughly recognised in his native country, and his works were eagerly sought for to decorate many of her chief cities. Amongst them were a marble statue of Queen Isabella II.; the tomb of General Mina, at Pampeluna; an equestrian statue of King Ferdinand, at Barcelona; a group of the Trinity in the Carmon church at Madrid; a statue of the Virgin for Porto Rico; besides several statues for the cathedrals of Tolosa, and St. Jacques de Galicia. His chisel was also abundantly prolific of finely characteristic busts. In all, Piquer has achieved for himself a monument *à se rennissus*.

NEW YORK.—Under the name of 'The Metropolitan Museum of Art,' this city is preparing to erect a Museum of Painting and Sculpture: the undertaking will be defrayed by means of public subscriptions on a large scale. The civic authorities have set apart a considerable plot of the ground in the Central Park for the edifice, which will consist of a single storey, the ground-floor being set aside for sculpture. The central apartments will be devoted to business purposes. Ultimately it is intended to assign certain portions of the building to a museum of Industrial Works. At the present time the city possesses about 250 pictures, including examples of Velasquez, Lucas Cranach, Van Dyck, Isaac and Adrian Ostade, Terburg, Mieris, Hobbema, Rubens, Greuze, and others.

NATURE PICTURES.*

THIS book is well worth all it will cost: a more perfect volume, in so far as Art is concerned (and it has nothing else to depend upon), has never been submitted to the public. It shows us what Art can do, when artist, engraver, printer, and publisher combine to produce excellence. Those who have doubts as to the value of engravings on wood, and as to their power of giving delight to educated minds who require approach to perfection when Art

copies nature, will have their doubts entirely removed after inspecting this delicious volume. We have seen nothing of the kind so admirable heretofore: and it is not likely we shall see anything so entirely exquisite again; unless, indeed, there is a public of sufficient spirit to recompense fitly those who have produced it. Several years must have been occupied to complete it. Let us examine any one of the thirty: take, for instance, that of 'The Hayfield;' nature has supplied the materials, and has brought them together with consummate skill; no doubt the points are made up from many studies, but the whole

composition is in perfect harmony. Turn to another—'The Heath;' how true it is! how absolute a transcript of what all have seen! So of 'The Waterfall;' water has never been better rendered. And how grandly faithful is the rainbow that over-spans 'The Lake.' So with two seascapes, 'The Storm' and 'Calm.' So indeed, with all the thirty prints; each is perfection of its kind, including those in which the figures "come large—" such as the 'Rabbit-Hutch' and the 'Market-Cart.'

Messrs. Warne afford us the opportunity of offering a specimen of these very charming



THE FOREST.

woodcuts. 'The Forest' may be accepted as a type of all the others: our readers cannot fail to recognise the peculiar beauty both of the drawing and the engraving; it shows the crisp yet delicate character of a first-class etching by one of the old Dutch masters. Each of the thirty subjects exhibits the same poetic feeling in the artist and skill in the engraver.

* NATURE PICTURES; a Series of Thirty Original Illustrations. Drawn on Wood, by J. H. DELL; engraved by R. PATERSON. Published by FREDERICK WARNE & CO.

The merit of drawing these on the wood, from his own sketches, appertains to Mr. J. H. Dell; but his efforts would have been comparatively *nil* if he had not been so ably seconded by Mr. R. Paterson—an Edinburgh engraver, we believe—who is entitled to equal honour with the draughtsman. Obviously, they have worked heartily and zealously together, and their works will bring them honour and fame, and we hope substantial reward. They are not the only "makers" of this book to whom merit must be awarded; the publisher has

produced it "regardless of cost;" the binders, Straker and Son, of Farringdon Street, deserve warm praise; the printer's name we do not find, but it ought to have been prominently placed. It is clear an immense amount of thought, labour, and expense must have been incurred by all.

The volume would have been improved by accompanying each engraving with some quotation from one of her poets. The total absence of letter-press (except the title of the print on a separate leaf,) gives a degree of baldness to the book which is not altogether pleasant.

A VISIT TO THE CALCUTTA SCHOOL OF ART.

AMONG the rapid strides "Young Bengal" is making towards European advancement the departments of Art are not neglected. There are young men being trained who should diffuse an influence through the arts and manufactures of the country, which must go far to lift them out of the barbarity into which ages of ignorance have plunged them. The imagination, without knowledge as its foundation, paints forms at once grotesque, hideous, absurd; forms which, by the side of realities, are as nightmares to healthy life and action. All Indian art is neither trivial nor absurd, as I shall presently show; but the mass of what we see, everybody knows to be utterly valueless. I venture to think there are some who feel an interest in the progress of Art in India, as the word is received among us, and to such readers I hope my narrative may not be uninteresting.

The Calcutta school is well situated in the native quarter of the city. The building is not spacious, but the most is made of the accommodation it affords. The students, when I first visited it, were away for the Durga-puja holidays, and Mr. Locke, the principal, had prepared me for almost an empty house; but, in truth, I saw more than I ever dreamed of in Calcutta. All the requirements and furniture of art were to be found here. Busts from the antique, and casts from ancient architectural remains in India, and drawings from these in crayon, carefully stippled and remarkably correct. A few students, anxious to earn something, were hard at work drawing from casts on stone or with pen and ink, while close by a window a young man, with a range of bottles containing serpents in spirits, was at work copying, in water-colours, the head of a serpent, stippling the whole in with great care and neatness, scale for scale. In Mr. Locke's room I was shown a multitude of drawings made by the students. A collection of folio drawings of serpents executed with almost mathematical precision attracted my particular attention. These drawings were for Dr. Fayer.

I have since seen the School during the whole of one of its most active days, when the pupils were busy in the preparations of the contributions now in the Calcutta International Exhibition. On entering the modelling-room I encountered a Bengali removing a waste mould from the cast of a *cobra de capella*. The snake was in the act of striking,—his hood was expanded, and his throat swelled; the rest of his body so disposed as best to support his attitude. With immense care and wonderful patience he was chipping away the *matrix*. He had been some days at this work, as I was informed. Mr. Locke is of opinion that the Bengalis rival, if they do not surpass, the Italians in their delicate handling of plaster-casts. One cast of the snake, which was drying outside, represented the *cobra* in the act of locomotion, with his head raised above the ground, and his hood contracted; the muscular action represented in the tortuous body was admirably brought out. There were other models in different stages of completion, with students and workmen engaged about them. The adjoining room contained a "feast" of Art. All the fruits procurable in Calcutta were here, in plaster, but coloured so well that nothing short of touch would convince one they were not edible. Students were at work painting other casts of fruit, and, with unlimited patience, putting down tint for tint and line for line from the original fruit; their performance could scarcely fall short of perfect imitation.

A cage containing a couple of *cobras* attracted my attention for a moment. The venomous creatures were waiting to be experimented on. It is not to be imagined that the live creature is embedded in the plaster, and is thus entombed for a while to perpetuate itself in the cast taken from his *quondam* tomb, while his own carcass is bottled up in spirits of wine for the curious to admire. No! this process would not be practicable, and

the method adopted must be referred to the ingenuity of the workman.

My next visit was to the "room of horrors." The "horrors" are specimens of false taste; most of them, of course, from Indian monuments. What is not unique in ornament, what is false in sentiment or not in keeping with the type of the work of which it is a portion, is to be found here. Here it is the student is taught what to avoid; while that which is pure in design, and is true to all the conditions of Art, and fulfils all the requirements of taste, is constantly before him as his guide and his model. From this he practises his pencil, and he trains his eye—he draws it—he paints it—he sketches it upon the lithographic stone, and imprints it as indelibly on his mind as he does on the paper which brings away the imprint from the stone.

In the large hall down-stairs are the fine casts brought from Orissa some short time ago, with a vast number of other casts, moulds, &c. The cast of a *bhisti*,* with his *mussak*,† appears to have been one of the few works in the place copied from a living "model." A curious little history attaches itself to this figure. He had been standing some time before the students while the clay was assuming his shape. An anatomical figure was near him, and the Principal, drawing the attention of the students, to the *tendon Achilles*, touched the "model" with his pointer behind the ankle, and bade the students watch the effect as the man drew up his leg. The man, alarmed at the action of the instrument on his leg, took fright and decamped. Never since has Mr. Locke been able to secure a model, for it was reported of him that he had by some magical means communicated a disease to his victim's ankle from a certain terrible figure of a skinned man, and that it only succumbed to the most powerful applications. The pain in the poor fellow's leg for a day or two after the occurrence bore out his statement well, and no wonder, for he had stood long enough in all conscience.

The last room I visited down-stairs contained the finished casts, and here again the patient delicate hand of the Bengali was at work, covering the surface of the cast with a fine coating of oil-colour to protect it.

The ceilings in different parts of the house were covered with designs the effect of which had been first tried here. Several of the buildings in Calcutta bear witness to the skill of the workmen and the excellent designs of the Principal.

On ascending the stairs I came upon a large class of Bengali youth learning to draw, not sketching, but accurate drawing: the sixth class contained better draughtsmen than English schools in India can train in six years, after the manner in which drawing is taught in most of the public schools I know. The style is unmistakably referable to the South Kensington School of Art. Teachers were of course superintending their several classes.

The hall on the second floor is a fair sized room, and well appointed with finished casts from the antique; busts of gentlemen, modelled at the school, were ranged on pedestals on both sides of the room; while drawings from these were hung on the walls.

In another apartment students were at work stencilling on lithographic stones; others were at their easels; and others again at their modelling stools, working the plastic clay. All seemed intent on the art they had made their vocation; not an idle hand did I see in the house.

One of the most important features of the instruction here imparted, is the feeling with which the young men regard the Art-productions of their own country. Who can deny that India has produced giant architects, whose works are as unique in design and ornament, notwithstanding their wonderful complications, as many of the finest structures in Europe, and more so than nine-tenths of the great buildings erected by Europeans within this century, and that these architects had skilful workmen under them to complete their designs? The reader has only to turn over the leaves of "Ferguson's Tree and Serpent Worship" to be convinced of this. The students here are taught to discriminate be-

tween the true in Art and the false; to appreciate the beauties of their own perfected art in ornament; to reject at once what bears the stamp of empiricism; to abstain from incongruous combinations; and to follow whatever is elevated in taste, or refined in sentiment.

I do not speak of painting, please remember. That has not yet been taken in hand, nor yet again sculpture. The tenets of his religion teach the Hindu he is defiled if he touch a corpse; and the Mahomedan, if he creates the image of anything in the heavens or in the earth, or in the waters under the earth, makes himself a debtor to the law. But the reign of these taskmasters will not be long. In the hall of the Bethune society, or rather, the theatre of the Medical College, hangs the portrait of a young man, a native *baboo*, in the act of dissecting the corpse of an able-bodied man. This is the portrait of the first native who dared to break through his prejudices and take up the scalpel. Painting does not exist as an art in this country, nor will it ever, until some native with a natural talent strides far in advance of his countrymen, and becomes a painter, an interpreter of nature on the canvas. Such a one would command a princely patronage among the Art-patrons of his own country, of whom there are not a few in India; and if so disposed, the School of Art would develop his genius. Here, to his imitative faculty would be added a ready hand, a correct eye, a cultivated taste, and a knowledge of Art, such as should keep his fancy replete with forms he would be taught how best to represent.

Lucknow.

ALEX. E. CADDY.

SELECTED PICTURES.

FROM THE PICTURE IN THE POSSESSION OF THE PUBLISHERS.

THE HAMOAZE, DEVONPORT.

H. Dawson, Sen., Painter. E. Brandard, Engraver.

MR. DAWSON and his son, whose picture of 'Men-of-War at Sheerness' we engraved some months ago, appear to claim a kind of monopoly of our royal sea-ports and navigable river-scenery; and especially of the former. Since the days of Clarkson Stanfield there has been no painter who has done so much Art-business in the neighbourhood of our chief dockyards as these gentlemen; and all they do is well done. Of all the English ports which form the nursery and the rendezvous of our naval forces, not one is more picturesque, or even as much so, as that at Devonport, whose harbour is flanked by the magnificent woods attached to Mount Edgcumbe on one side, and by the varied and numerous buildings, &c., appertaining to the royal dockyards of Plymouth and Devonport on the other.

Lying at anchor on the right is a screw-steamer, in whose wake is a "three-decker" of the old order of ships, now, altogether ignored for fighting purposes. In the middle distance is a paddle-steamer, almost as much out of fashion as a sailing war-vessel; and behind all rise almost from the edge of the water the grounds of Earl Mount-Edgcumbe's noble mansion: facing these are the sheds, &c., of the dockyard. The sky is very effectively treated; the gentle ripple of the water, and the steadiness of the small craft on its bosom, indicate but little wind; yet there are heavy clouds rolling up, as if a storm were about to pass over the scene, and convert the quietude into agitation. The only object we wish absent is the huge buoy, which is far too obtrusive to be agreeable to the eye, though of practical value by throwing the vessels back into their due position.

* Bhisti—Water-carrier. † Mussak—Water-bag.



E. BEANTON

H. LAWSON SCULPTOR

THE GREAT BRITAIN



THE FLEMISH GALLERY.

AN exhibition of Belgian and other foreign pictures has been opened in a building of which the memories are rather notorious than celebrated. We mean that at the top of St. James's Street, which in Florence or Venice would be a *palazzo* with some melodious name, but which has been known, for the better part of two generations, by the historical, though plebeian patronymic of "Crockford's." Since it ceased to be Crockford's *de facto*, it has been put to other uses, but whatever changes come over the place, its old aroma will hang round it still. The pressure of this place into the service of Art suggests curious reflections, of which one conclusion that for the moment overrides all others is—that within the area claimed by Art-exhibitions there is no gallery now to be had sufficiently well lighted, and otherwise commodious enough for showing a collection at all numerous, of good pictures. This is in effect true; and it is a question worthy of grave consideration, as bearing with all its contingent circumstances on the advance of painting. The collection which is now to be seen at the gallery in St. James's Street is well worthy of its abiding place, as numbering not fewer than one thousand pictures from different parts of the continent, setting forth especially the living school of Belgium, of which we think every eminent member is here amply represented. It is to the energy and enterprise of M. Everard, of Brussels, that we are indebted for such a display of works of Art as never before under similar conditions has been seen in this country. The Flemish pictures have been limited to the productions of living artists; and in order to the proper observance of this rule, very fine works by deceased painters have been rejected. Although the rooms are full, and valuable works are necessarily placed in indifferent lights, it has not been found possible to hang even the half of the collection. We are ignorant of the intentions of the proprietor, but it is presumable, that, as the season advances, portions of those now shown will be removed, and their places supplied by others. As this notice was written before the catalogue was printed and the numbers were affixed, the titles, in some instances, may be wanting, yet the descriptions will serve to identify the pictures. There are, we have said, besides Belgian pictures, works by members of other schools, deceased as well as living. To mention indiscriminately some of those who are especially signalled here, there are—Gallait, Portaels, Ary Scheffer, Horace Vernet, Rosa Bonheur, Stevens, Carolus, E. Frère, Coomans, Chavet, Pecrus, Meissonier, Escosura, Toulmouche, Madou, Plassan, Roybet, Verboekhoven, Schlesinger, Van Schendel, Slingeneyer, and a host of others all famous in their respective departments. Such an assemblage of modern pictures, the result of private enterprise, we never remember to have seen. The display dwarfs all others of the exhibitions now open—in a word, like Aaron's rod, it swallows them all up.

But to particularise, there is 'The Star of Bethlehem,' by Portaels, which in conception differs largely from most renderings of the subject. The scene is an extensive plain, with an indication of Bethlehem in the distance, lighted by the star. The three wise men are grouped at the right extremity; they are hastening onward with "exceeding great joy." The composition is not vulgarised by any state circumstance; the novelty, beauty, and power of the work consist in its perfect simplicity. To the star is assigned its important part according to the sacred text. But a much greater work than this, also by M. Portaels, is 'The Drought in Egypt,' according to the 7th chapter of Exodus, ensuing on the turning of the Nile into blood. Women in their search for water are assembled round an exhausted fountain, wailing, fainting, and dying; and incapable of further exertion. Moses is prominent among the figures, and to him they appeal for relief. One with a frantic menace holds up her dead child; another offers him her jewels and ornaments for a draught of water; others can only appeal to him by their looks; but the rare merit of the

whole is, that it is a purely original conception of a subject most difficult to treat. It proclaims at once its source and argument, and, although perfect in its unity, each separate figure or group would of itself form a distinct picture. We have not space to dilate on its numerous points of excellence, but of the works of M. Portaels generally, it is only just to say, that the dignity of originality is not their least distinguishing characteristic.

Those who study the complexion of modern Art will not be surprised to observe the paucity of works historical, and even quasi-historical, everywhere. Here, by Schaeffels is a very elaborate picture, representing Queen Elizabeth knighting Drake after his voyage round the world. The ceremony takes place in his ship, the *Pelican*, in presence of the Court. How well soever it may be known, we must not omit mention of Thirion's 'Christian Martyrs,' which renders a grateful return for repeated visits. Very elaborate and fraught with appropriate character is Koller's 'Pillage of the Convent, a scene during the Insurrection in Wurtemberg in 1524,' 'The Arrest of the Princes,' three very substantially-painted figures, by Horace Vernet, are all that are left of the well-known picture that was nearly quite destroyed at the sack of the Palais Royal in 1848. In 'Gretry presenting Bouilly to Marie Antoinette,' Houze recalls memories of the Court of Louis XVI.; and Robert Fleury, in his 'Marie de Medicis and Rubens,' alludes to an earlier period, and to circumstances to which the public collections in Paris owe some of their finest works. 'Washington and Rochambeau,' by J. L. Brown, embodies a suggestion from the American War of Independence; and by the same artist, 'Marshal Saxe,' is another military situation not dissimilar in the bias of its conception. The name of Courbet having been so intimately associated with recent events in Paris, much curiosity has been expressed in reference to the quality and line of his Art; this feeling may now be gratified by inspection of a large picture by him, called 'The Death of the Stag.'

'Tasso in Prison,' by Gallait, is a work which will contribute, among artists, more to the painter's reputation than perhaps anything he ever painted. Many men may have contemplated such an effect, but few could carry out the idea. The picture has been already described in the *Art-Journal*—it is enough to say it is that wherein a sympathetic sunbeam, in doing its charitable best for the prisoner, succeeds only in lighting up his hands, and by its presence deepens the gloom that wraps the unhappy poet and his surroundings. The picture is a text for a long argument. There is also by M. Gallait a 'Neapolitan Flower-Girl,' a subject so commonplace that it must have been taken up by him for an especial purpose. It is in nowise like Murillo's Flower-Girl, yet the presence reminds us of it; and at the same time adds to the mass of evidence in favour of the fact that none but a man of undoubted genius is safe in painting a hacknied subject. M. Gallait has the rare power of giving to his work a charm of which the source is masked. In reference to this picture, Murillo has been mentioned, although it suggests nothing of Spanish Art. We are, however, more broadly reminded of the Spanish school by 'The Page,' a picture by Roybet, wherein is a youth in the doublet and hose of the sixteenth century, holding two greyhounds, one of which proposes a too proximate survey of a dish of fruit, from which he is warned off by a screaming cockatoo. This picture we have seen before, but not in a light so good as that in which it is now placed. You cannot consider it without being thronged by a crowd of comparisons, which take you back centuries, and finally lead to the conclusion that the painter has been sitting at the feet of one Diego Velasquez; and this is something to say for a modern work. 'The Flower of Joy,' and 'The Flower of Sorrow,' are pendants which should not be separated. They are by Emile Saintin, and are already well known. The story is of a young wife, who, in the former, is about to present to her husband a bouquet on his birthday. She holds the flowers in her right hand, and anticipating the pleasure of the surprise, is about to

open the door of his room. In the other she is also about to open a door, but here she wears deep mourning, is in tears, and the flowers of sorrow form a wreath of *immortelles*, which she is about to place on her husband's coffin. All this is told with admirable perspicuity, and nothing can exceed the *finesse* with which the figure in both situations is made out. In 'The Young Widow,' also by Saintin, there is nothing that does not contribute to the narrative. Her dress, and everything about her, bespeak her recent loss; and all leads up to, and sustains the point of the situation, which is the widow's repusal of the letters of her late husband. The delicacy of the work here is extraordinary. For many years the works of Madou have been known in England. He is considered the Wilkie of the Belgian School, and is represented here by two pictures, 'The Politicians,' and 'Courtship.' Certainly the subject, arrangement, treatment, and general feeling of the former remind the observer of Wilkie. The period indicated is about that of the first French Revolution, and the politicians, four in number, are assembled in argument round a table in a tavern. The figures and material are well drawn and firmly painted; and another great merit in the work is its simplicity of composition. In the latter picture a *garde champêtre* is talking soft nonsense to a pretty milkmaid, who evidently does not encourage his sallies. The relations between these persons are most satisfactorily established. We have known Madou's works for more than thirty years, and contemplate these with wonder as the productions of a man verging towards eighty years of age.

In 'Le Jour de Fête,' Gustave de Jonghe, appears a young lady gladdened by the receipt of numerous birth-day presents. The incident is realised in the spirit of that refined *genre* which now prevails so extensively in the French and Belgian schools. It is a successful example of its class. Another single figure, called 'The Model,' by Alfred Stevens, shows a figure costumed and set, from which the artist must be supposed to be working. The subject is certainly remarkable for novelty of treatment, and the painting is that of a skilful and experienced hand; indeed, it may well be so, for M. Stevens ranks high among his brethren. 'A Roman Girl at a Fountain' is one of the best studies that has been recently produced by Charles Landelle. The subject is common enough, but hence the greater difficulty to give it the interest which attaches to it here. It is really very fine. As a remarkable contrast to the quietude of these, there are two elaborately-painted works by Cesare dell'Acqua, one called 'Le Jeu du Diable,' which the title renders it necessary to describe in order to avoid false interpretations. It is simply a lady amusing herself by means of the trick, innocent enough, although known by a name so questionable. The draping is a study in nowise akin to modern costume. The action and the personal dispositions give a movement and flutter to the figure, which if it was the intention of the painter to communicate, he has fully succeeded. The other is a lady with a *clavicorde* on her lap—the drapery here, also, is a main point in the picture. In these latter-named subjects we have descriptions of a variety of feminine moods, but we now turn to a picture of a woman entirely thrown off her rational balance by her wild and headlong passion. It is by Portaels, and its great merit is the utter absence of all approach to theatrical rant. It is entitled 'Ill he revenged!' The fierce resolve of a wife, it may be, of the middle or upper class, who sees her husband lavishing his caresses on a rival—but this does not appear in the picture. The vow is not assisted by any tragic properties, the artist relies for his narrative only on the dire menace of the woman's face; and this summons up in dread array the phantoms of all the human tigresses whose names and deeds have befouled the pages of history.

In another direction we have 'Juanita,' a head and bust study, by Bouguereau, as of a Spanish lady, extremely simple, but earnest, penetrating, and full of interest. Again, descending the social scale, there is, by Slingeneyer, 'A Souvenir of Calabria,' in the person of the wife and child of a brigand. She does not affect the gay attire of the wife of a stage brigand, but wears a very

plain workday costume, which claims no distinctive nationality. She is either looking out for unconscious travellers, or watching to guard against surprise by soldiers or police. The features indicate a nature equal to any atrocity. By the same painter is also 'A Souvenir of Tunis,' being an orange-girl wearing a loose wrapper, apparently made out of a blanket. As in the former case, the dress puts forth no distinctive national pretension—both figures are of the size of life. 'Before Dinner' and 'After Dinner' are by a German painter, Baumgartner, but very different in character and point from the above, as bespeaking the different condition of a burly priest at the two periods signified by the titles, 'Anticipation—before Dinner,' and 'Retrospection—after Dinner.' In the former he is visiting the kitchen, and with the assistance of his servant, looking at a roast capon, which he pronounces sufficiently done. In the latter he is seen in his post-prandial condition, asleep in his chair, and in person conspicuously more bulky than before, to account for which, we see that the plates have been cleared. While he sleeps, two Tyrolean peasants have called to settle matters about getting married, and are greatly chagrined at finding he is on no account to be disturbed. There is a strong tone of satire in the story, which is admirably detailed in the two situations. The well-known architectural painter Springer has here a work of great merit. The subject is the 'Town-Hall and Market-Place, Brunswick,' a large picture with a complication of public and domestic architecture, which the painter has worked out with infinite patience, and all the success due to so much perseverance. The market-place is thronged with figures; indeed, nothing is wanting to give movement and reality to the scene. 'A Young Girl at a Fountain,' and 'The Armet,' are two very elegant conceptions by Pinchant. In the former appears a woman in almost white drapery, stooping before the fountain. There is really nothing in the person or the act; but the sculptural grace of the dispositions appeals at once to the eye and the taste. As we rarely find even pendant pictures coincide in the same degree of excellence, the second, although of great merit, is by no means so striking. It represents simply a lady fitting an ornament on to her right arm. The works of Coomans are remarkable for an extreme delicacy of manipulation, which renders indispensable the utmost accuracy of drawing. 'A Pompeian Lady at her Toilette' is a most favourable example of the manner of this artist, who, we need scarcely say, paints domestic incidents of the Roman period with much success. There are, also, by Coomans, four other works, all distinguished by points equally original, and effect: not less brilliant. These are, 'The Portfolio,' 'Expectation,' 'The Toilette,' and 'Leuconoe,' a fictitious personage, to whom Horace addresses one of his odes.

'Demanding the Toll,' by P. Joris, is a very agreeable example of the modern Italian school. It is brilliant in colour, and remarkable for the perspicuity with which the artist develops his plot. On the outskirts of an Italian village a procession of maidens, in the costume of the country, is stopped by a barrier held firmly by two lovers of mischief, who propose to the party the alternative of paying the toll or leaping the barrier, much to the amusement of the bystanders.

The works of Toulmouche are always pleasing, but there are here two of wonderfully simple interpretation, yet charming in the ease, certainty, and perfect propriety of their execution. One is 'Will Papa consent?' the other 'A Sweet Temptation.' Nothing proclaims the master so much as the endowment of ordinary material with such exquisite quality as we find in these two pictures. The interrogative title of the former declares the passing thought of a young lady who is knocking at the door of her father's room, in order to learn his decision on the question of a proposal of marriage which has been made to her. The flutter of a momentous painful suspense has never been better expressed. The latter expounds itself as the simple act of the same young lady offering from her mouth a piece of sugar to a cockatoo. The

latter occurrence takes place in a conservatory, which itself, and without any personal presence, would form a picture. The surface mechanism of these pictures is simply marvellous. The works of Carolus are distinguished for perspicuity of narrative. In 'The Fortune-Teller,' the proposition is clearly enough set forth by the two girls, who consult respectively the aged sibyl as to the turn of their future destinies; and to the 'Ecrivain Public' there is no need of a title to explain the matter in hand between M. Loroy (the public writer) and the maid-servant from whose dictation he is so carefully inditing. There are seven other works by Carolus, and all are made out with the same neat handling which marks this. 'The Visit to the Nurse,' Dansaert, is full of detail skillfully painted: there are five others by the same artist not less perfect in their manipulation. The 'Guitar-Player,' Tony de Bergue, although the subject be so often repeated, is remarkable for the delicacy, especially, of the flesh-painting. By Gerard is another subject of an ordinary kind rendered interesting by the reminiscences it bears with it of the old schools of painting. It contains only three girls, one of whom is feeding a dog. Another, by M. Gerard, is called 'Winding the Skein,' wherein a little boy holds the skein his elder sister is winding off. It is not the action in these works which is so attractive, but it is the perfect coincidence they show with the genius of some of the best works of the Low Country schools of the past. There are four other pictures by this painter. Knowing Corot principally as a landscape-painter, he surprises us here as a figure-painter, carrying into his performances all the careful dash which prevails in his landscapes, of which the only example here shows the outskirts of a forest. His personal studies are four in number.

Such a collection as this is not wanting in examples of small figures, and works of minute finish—that class of picture wherein French artists are so great, and in which painters of other nations have followed them not without a great measure of success. In one of these, 'The Spy,' by Escosura, a man is brought under escort into an officers' guard-room and all appear interested in hearing his report. The dress of the figures is the picturesque equipment of the seventeenth century, and it is impossible to speak in exaggerated terms of the singular nicety of all the work in the picture. Of this painter there are four other examples. In 'The Amateur'—a charming little picture by Chavet, we are introduced into the cabinet of a gentleman, who with his friend is examining prints. It is full of accessory, but this is by no means obtrusive; and otherwise it is distinguished by all the qualities giving value to such compositions, which seem to us to be brought together with greater perfection than in larger studies. There are two other works by this painter. In the same line of incident there is, by Bottini, 'The Connoisseur,' with more fulness of touch, and perhaps less of that perfect maturity of mechanism we see in the others. In a small figure the utmost generosity of touch with the brightest sparkle of colour is shown in 'The Order of the Day,' by Roybet, a portly officer in cavalier dress, standing with his hands behind him, reading a notice posted on the wall of the guard-room. There are altogether four by Roybet, and in contrast to all these, both in execution and colour, 'Out in the Rain,' by Edward Frère, shows how a picture may be rendered interesting, even without colour. The subject is only a little girl in a drenching shower, under an umbrella; but it is painted with all the easy garrulous address of E. Frère's characteristic manner. There are four others by this eminent artist. In minutely speculative work some French artists are really surpassing all their established antecedents—as may be seen in M. Plassan's 'Little Brother,' an oil-picture, with details so minute as to require a microscope to understand in any-wise the argument. It is the most perfect miniature in oil we have ever seen. This category is continued by Ceriez, by whom is a very careful figure called 'Enjoying his Pipe,' also in 'The Necklace,' by Baklowicz, and by the same, a lady playing the guitar; by Monfallet, in 'The Fencing Master,' and 'The

Musician,' by Rossi, and others, all of which exhibit the very perfection of that small class of cabinet-picture, suggested in the first place by the Dutch masters, but of which the softness and mellow sparkling quality the Dutch masters have not as a rule always reached.

A perfect example of inspiration from the Dutch or Flemish is seen in a picture by Hove, which but for its freshness might be assigned to one of the northern magnates of the seventeenth century. The principal person is a lady in a corridor dressed in a white satin gown as lustrous as the famous satin gown by Terburg; but of this kind of painting there is a more attractive example by Pecrus, a lady also in a white satin gown—simple in arrangement, but most forcible and brilliant in effect. Among the studies of animals we have seen with pleasure an early production of Rosa Bonheur, 'The Repose,' which, curiously careful in colour and work, transcends her more recent productions; and by the sister of this lady, Madame Peyrol, 'Sheep on a Moorland,' is the best production she has perhaps ever exhibited. We have known her principally as a painter of poultry, but here we have a flock of sheep under an admirably defined effect of sunlight. Anything equally successful in this way is very rarely seen. Again the veteran Verboekhoven surprises us by the variety and number of his works. When we remember that M. Verboekhoven is more than seventy years old, we look with pure astonishment at his miniature minikin sheep. Besides many of these he has a large picture representing a flock of Scotch mountaineers, in their native hilly pasture; a large composition made out with as much firmness as the finest productions of what is commonly considered his best time; although to us he never appeared to paint better than he does now. By the brothers Tschaggeny are several animal-pictures of great merit. The works of Charles Tschaggeny, who paints horses with much power and knowledge, have been known to us for years; his subjects here are, 'A Hard Pull up Hill,' and 'The Return from the Fair,' in both of which appear teams of horses perfectly designed for heavy draught. Edmond Tschaggeny excels as a painter of sheep, and the manner in which he situates them evinces more knowledge of landscape than professors of animal-painting usually possess. His fleeces also are less crisp and more thoroughly woolly than such textures are commonly represented. His pictures here are, 'The Repose,' and 'Returning to the Fold.' There is also by Mauve a very spirited sketch, 'The Shepherdess,' and akin to these is, by Pittara, of Rome, a 'Scene in the Corso,' containing a number of horses in a pen; from these is made a selection for the races in the Corso. Of Noterman, the well-known painter of dogs and other animals, there are favourable examples. 'The Sick Man of the East,' by Verlat, is a pungent satire upon the state of things before and about the time of the Crimean war, the parties to which are personated by monkeys.

It will at once be seen that the works noted above, have been taken almost indiscriminately; for where all is so good it is unnecessary to search for quality. In truth, such is the excellence of many of those of which we cannot even give the titles, that a column would scarcely suffice to do some of them justice. In confirmation of this it is only necessary to name Brion, Duverger, Van Hamme, Schlesinger, Lasalle, Zuccoli, Dillens, Van Schendel, Boldini, Merino, Verhas, Joris, Duval, de Jonghe, Levy, Meissonier, Tenkate, Klombeck, Ribot, Richter, Serrure, Delacroix, Thom, Flenry, Portielje, Ruiperez, Moormans, Campotosto, J. Vernet, Seignac, &c. Among those who distinguish themselves in landscape, marine, and other subjects, are the Baron Gudin, Lambinet, Musin, Ziem, Unterberger, de Beul, Koekkoek, Domersan, Artan, Van Leenw, Timmermans, Feyen, Deshayes, Dupré, Lacombe, Francia, Robie, Esbrat and Troyan, Daubigny, Porcher, Diaz, Trayer, Boulanger, de Haas, Jacque, and others. There is moreover, a small and good selection of water-colour drawings by well-known artists. In conclusion we must repeat our admiration of this foreign exhibition, which is certainly, in its speciality, the most attractive that has yet been seen in this country.

THE FRENCH GALLERY.

THE nineteenth annual Winter Exhibition of Pictures by British and foreign artists, is now open, at 120, Pall Mall.* The catalogue numbers upwards of two hundred paintings, the productions of 143 artists, of whom above 60 are foreign. Of some of the smaller figure-studies, or rather sketches,—for between the two there is a wide interval,—it must be remarked that they are endowed with a point and purpose worthy to appear as large and highly-finished works; whereas in some of the larger examples the results can scarcely have reached the standard of the painters' expectations. That there is a proportion of highly attractive works in the collection is attested by the names of David Roberts, R. Ansdell, R.A., Alma Tadema, E. Frère, A. Yvon, T. S. Cooper, R.A., W. P. Frith, R.A., T. Faed, R.A., J. D. Harding, Koekkoek, Schlesinger, E. Nicol, A.R.A., F. W. Hulme, B. W. Leader, and many others. The landscapes are not numerous, but, in almost all, the proposition of the artist is at once intelligible, and in many cases very successfully brought out. But to turn to some of the instances of personal incident: the eye is attracted at once by 'The Unexpected Return,' Carl Hoff, a brilliant picture, in which appears a gentleman, in the military gear of the seventeenth century, who surprises his family and friends by his sudden appearance among them. To say nothing of the knowledge shown in grouping and arrangement, M. Hoff has a wonderful facility in accessorial design, and of his work it may be said that literally a richer composition is rarely seen.

When the name Yvon occurs in a catalogue, it has an inevitable fascination that impels one to search out that to which it attaches. In this case it is a portrait of the Emperor Napoleon III. (25), a head dated 1868, and realising in everything the best attributes of the Emperor's character. In the 'Miranda' (73) of T. F. Dicksee, the heroine is seated on a rock on the seashore. Between this and all else Mr. Dicksee has painted, there is a marked difference. Both wind and sea are temperate, and there is an airy and lightsome character about the idea which takes it even out of sight of his more elaborately substantial works. All the pictures of M. Tadema are founded upon very original bases—none is more so than 'Pottery Painting' (67), which crowds you with recollections of what remains to us of this Art. A woman is the principal in this antique studio. M. Tadema's assertions and suggestions may be true or otherwise; under any circumstances it is a very remarkable picture. In 'Spanish Courtesy' (81), S. Jimenez, we see a mixed company of men and women dressed in their holiday-gear, and one of the former spreads his cloak for a lady to walk over. The subject would have told well in a larger picture. 'An Agape' (92) is the title given to a group of a couple of chorister-boys eating chesnuts—a third figure is the girl who deals in the fruit. The title, we fear, will be a mystery to many as applied here. It speaks a love-feast, one of the ceremonies of the earliest Christian church, and practised, perhaps, even before the fall of Jerusalem. 'Où est mon Père?' (101), Mrs. K. Bisschop, is a touching incident very clearly told. A sorrowing widow with her child is looking at the portrait of her husband, lately deceased, and her grief is, of course, greatly embittered by the innocent question of her little daughter. W. Maw Egly draws on Molière's fund of broad humour in 'Le Malade Imaginaire,' from which he has pointed the scene wherein Argan chases Toinette round the chair. The motive, it seems, to us would have admitted of a greater degree of lightness. The subject of the next picture we note is one of those picked up on the margin of history, being 'Edward VI. surprising his Cousin, Lady Jane Grey, studying in the Privy Gardens of the Tower' (130), G. F. Folingsby. There are only two persons present. The conception of the king is precisely that con-

veyed to us by portrait and description, and if we do not hail the lady as Lady Jane Grey, it is because she is so much confused, that for the moment she is not herself. 'Reviendra-t-il?' (116), W. M. Wyllie, is the question asked by a fond and anxious mother when her son, about to march with his regiment against the Germans, takes leave of her and his father. The persons in their several relations speak for themselves. The picture 'Forfeits—What's to be done to the Owner of this pretty Thing?' (153), J. Morgan, shows spirit, manipulation, power, and perhaps such a facility, or at least aptitude, for grouping and arrangement as might sometimes betray the painter into over-charging his combinations. 'Good Counsel' (181), E. Long, is well drawn and carefully painted. Without a title, but obvious enough by its circumstances, there is (188), by S. B. Dowling, that scene from *Romeo and Juliet*, in which the former takes his leave at daybreak. It is the last embrace, and he "must begone and live, or stay and die."

'The Haunted Wood' (189), J. Pettie, A.R.A., is a novel idea, the essence of which he has succeeded in conveying into his picture by two girls, who are passing through a deeply-shaded wood, having their attention drawn in a direction more gloomy and mysterious than the rest. In default of any title at all, there is a ghostly story to be read in the well-expressed fears of the girls. Hanging near that, (194), in 'Blessed are they that remember the Poor and Needy,' J. B. Burgess, is set forth the custom of almsgiving at the church-doors on the Continent. The local supposition here is one of the churches in Spain, after mass, where an old lady is relieving a little beggar-boy, while two haughty dames pass without a thought of the poor woman, who entreats them for God's sake to assist her. It is in every respect an excellent work. Few men have been more widely celebrated than Mr. E. Nicol's Irish friend. We have him here again, 'Perplexed' (2), and with all his usual vigorous and life-like expression. Rusty, patched, and ragged vesture is superlatively the vocation of this artist. 'Clearing up' (3), J. W. Oakes, is a composition with less of detail, though much more powerful in effect than are Mr. Oakes's works generally. 'A Storm Brewing on the Belgian Coast' (5), R. Burnier, is a cattle-picture of much merit; and of the same class is 'A Warm Day on the Zuyder Zee,' (18), G. Stortenbeker,—bright, luminous, and atmospheric. Even more bright and more impressively tranquil is the river, by B. W. Leader (6), after the verse of Tennyson.

'Scene on the Thames' (8), D. Roberts, R.A., is one of that admirable series of river-views which Roberts painted just before his decease. 'The Cooper's Children at Breakfast' (34), E. Frère, has some of the better qualities of M. Frère's works, but it has the appearance of having been hurried in execution. No. 51 (without title) is one of those small studies, a country-girl, by T. Faed, R.A., to which he has the rare power of giving such fascinating character. 'The Invalid Doll' (68), a grotesque satire upon tender mothers, is painted by Schlesinger, with all the significance of that pleasant manner we recognise in others of his works here. 'Amy Robsart' (53), W. P. Frith, R.A., is a small bright picture, looking much like an initiative essay for a larger work. In No. 83 we come to a sad memorial of a premature departure, in a picture of 'Sophia Western at the Spinnet,' by the late Trevelyan Goodall, from which, together with what has preceded it, a brilliant future was to be foretold. No. 84, 'A Parisian Home in 1870,' T. E. Saintin, is a picture which reflects hundreds of other homes equally desolate. Here is a young widow brooding in silent affliction over her calamity. No. 111, 'Black Game,' although a small picture, will be esteemed one of the best of the productions of R. Ansdell, R.A. It is, generally, so good as to induce the perhaps hypercritical wish that the sportsmen had been omitted. By H. Le Jenne, A.R.A., are two small but interesting works, called respectively, 'So Cold' (45), and 'Strangers Coming' (78). Other pictures of excellence which well repay investigation are,—'Tiss

Polly' (107), G. E. Hicks; 'Ruth' (146), W. Gale; 'Where's Master Algy?' (141), J. Hayllar; 'Music' (158), E. Lacreteille; 'On the Thames near Dorney—Moonrise' (163), G. F. Teniswood; 'Watching the Boats' (172), W. McTaggart, R.S.A.; 'Clearing the Woods in Spring,' R. Beavis; 'Morning on the Banks of the Derwentwater' (175), B. W. Leader; 'Landscape with Waterfall' (195), E. Gill; 'Cader Idris, from Barmouth Valley—Moonrise' (192), A. Gilbert; 'Rock Study—Langland Bay' (33), G. Sant; 'The Young Musician' (37), M. Arnoux; 'The Welcome' (55), R. Hillingford; 'A Breeze on the Coast—Holland' (59), H. Koekkoek; and certain pastorals, cattle and sheep, by T. S. Cooper, R.A., Brissot, Peel, &c., with others of much interest in various departments. This, it will be understood, as a winter exhibition does not attain to the recognised standard of that of the spring and summer, yet there are works here that would do honour to any collection, and the gallery cannot fail to prove very attractive.

MR. MCLEAN'S GALLERY.

MR. MCLEAN'S display of drawings (7, Haymarket) contains this year some examples that have never been surpassed. The collection is mixed, that is, the works are English and foreign, new and old. John Gilbert, in his version of 'Guy Fawkes before King James' (38), places us on the grotesque side of the king's character. Fawkes has been dragged in to the Audience Chamber bound with ropes, and is on his knees, while the king examines him at a safe distance, as he would a wild beast. There are two other drawings by the same artist, 'A Wandering Arab and his Family' (38), although painted previously by Carl Haag, confronts us here with a change of feature that makes it a new conception. 'Reading the Koran' (41), also by Mr. Haag, is an excellent drawing. 'A Genuine Toledo' (86), A. Gow, is the judgment pronounced by one who is the oracle of the company—the time may be that of Elizabeth, and the place a tavern. We see in the gallery on the part of some of the foreign artists, instances of manner which approach the utmost limits of licence, yet by no other means could the very powerful effects in a 'Cathedral Interior, Rome' (48), Y. Spanaro, and 'A Man-at-Arms' (66), Fortuny, have been produced. The former is really well worth examination. Here the end is firmness and opposition; while with sketches made at home the object is colour and sweetness, as appears in a 'Hawking Party' (71), 'The Escort' (91), and others, by F. Tayler. We should not have accused David Cox of committing himself to architecture, yet we find by him, 'The Rue St. Martin, Paris' (2), and an 'Interior at Haddon' (81), painted in conjunction with F. Tayler; but the feeling of neither is apparent in the drawing, nor is the spirit of the former conspicuous when he strays into classical ideal, as in No. 87. There is great sameness in the elements of classical composition, yet Barrett frequently escapes this, as in his drawing No. 6. Another example of this fancy-free kind of description, which seems to be more fascinating on paper than on canvas, is a very elegant garden-scene (30), by Dodgson, whose merits in this line are certainly not understood.

The very antipodes of all styles, apparently loose but fastidiously careful, is 'An Italian Lake Scene' (44), W. L. Leitch; and there are two other Italian views, 'The Bridge of Sighs,' and a view in Venice, by W. Wyld, of whose works too few are seen in England. By F. W. Topham are, 'A Flower from Paddy's Land' (52), and 'The Roadside Call' (58). In the Sussex Downs, no artist saw any picturesque quality until it was developed by Copley Fielding, of whose interpretations No. 69 is a brilliant instance. Of the versatility of E. Duncan are two substantial evidences, both widely different in their directions, respectively they are 'A Squall' (67), and 'Sunset in Wales' (3). 'A Sunny Afternoon' (32), Rosa Bonheur, is a pastoral, dealt with rather more freely than this lady usually treats her water-

* As we announced some months ago, Mr. Henry Wallis has retired from this concern, which is now conducted by his son.

colour studies. In 'A View in Brittany,' F. Goodall, R.A., the life of the scene is a girl at a fountain, and so serious is its tone that but with little change it might be made a scriptural subject. 'The Turkish Coffee-Bearer' (36) is a study of a well-marked head and bust of a Nubian slave carrying a tray and coffee; and 'The Portrait' (51), both by E. Lundgren, presents two girls looking with much interest at a portrait which one holds before her. Other very successful drawings are 'Lake Scenery in Switzerland' (17), B. Foster; and by the same, 'Lake Scenery' (18); 'The Bruthorn from Mürren,' D. H. McKewan; 'Shore Scene' (21), G. Chambers; 'The Pet Dove' (26), W. C. T. Dobson, A.R.A.; 'On the Tiber' (27), W. W. Deane; 'Water-Lilies on the Thames,' (49), H. Baker; 'On the Northumberland Coast' (55), J. Mogford; 'Harlequin and Columbine' (63), F. Worms; 'Sheep' (64), T. S. Cooper, R.A.; 'A View in Scotland' (68), T. M. Richardson; 'Lake Scenery—Evening' (72), E. Hargitt; 'Church at Antwerp' (72), L. Haghe; 'The Cottage Door' (78), J. Trayer; 'Near Capri' (102), T. L. Rowbotham; 'Easter—Interior of Rome' (106), W. W. Deane; 'Entering Yarmouth Harbour—Ship and Crew Saved' (109), G. H. Andrews; 'Autumn' (126), C. Davidson; 'Stepping Stones' (109), B. Foster; 'The last New Novel' (4), F. Walker. And of some of those who have passed away, but who were stars in their time, there are memorials in 'Emigrants' (7), and 'Market Place in Spain' (20), S. Prout; 'The Fortress of Akabah in Arabia' (13), D. Roberts, R.A., and 'The Pirate' (82), C. Stanfield, R.A. Two drawings by Zichy, a Russian artist enjoying the patronage of his Emperor, have been removed from their places and sent by command to the Prince of Wales. The number of works is 143.

THE
NEW BRITISH INSTITUTION,
39, OLD BOND STREET.

THIS, the fourth exhibition at the gallery, shows, in oil-pictures, a marked improvement on the gatherings of preceding years. Formerly the collection numbered a large proportion of drawings, now it consists almost entirely of oil-paintings, some of which are of great excellence, especially certain of those by foreign artists. By Van Lerius is a charmingly sculptural conceit, which he calls an 'Idylle' (149), pictured by a woman semi-nude standing in a pool, or river-nook, overshadowed by rocks and foliage. She stoops forward, very warily, as if to catch a silly gudgeon that is swimming at her feet. The drawing and flesh-painting are both masterly, and the idea is carried out with all the chastity of an elegant piece of sculpture. The title of 'The Golden Hour that faded into Night' (59), P. R. Morris, would suggest the setting forth of many things poetical, but not a small company in which a couple of white calves are, if not the leading, certainly the most conspicuous, *personæ* of the scene. But it is so; and when it is said that the calves are driven by a couple of country-girls, the story as to its animated nature is told. But all this is only the basis of the superstructure alluded to by the fanciful title. The hour is certainly twilight, and the whole of the material is brought down, so as to describe the phase of daylight fading into night. But the sentiment and the terms of the narrative exalt the picture into just comparison with even very successful versions of sacred subjects. There is a solemnity and depth of suggestion in it which carries it beyond rustic incident. In the animals this picture is akin to a large painting of a herd of cows, by De Haas. They are distributed in groups on the sea-shore, over an expanse of sand and shingle, broken by pools. It is a cattle-picture of the very highest merit.

The perfection of drapery-painting, a rare accomplishment in these days, is exhibited in 'After the Storm' (172), by Vander Ouderaa, in which a young lady is seen deploring the havoc a

heavy shower of rain has wrought upon her flowers. The materials of the lady's dress are most perfectly described; indeed, the whole of the picture bears the impress of an experienced hand, guided by good taste. 'Charles Surface selling the Family Pictures' (56), C. Calthrop, proclaims at once its source—indeed, neither in play nor novel is there any such interesting auction as this. It is an excellent subject, and in the spirit in which the artist has taken it up he has done ample justice to it. 'By the Waters of Babylon' (39), J. Cuthbert, has been often painted, but the captives have always been represented very properly in profound affliction. Here we have a new reading, which but for the title might be interpreted rather an occasion of festivity than of sorrow; apart from this, however, there are many valuable qualities in the work. 'Jeune Fille de la Hesse et son Chien' (13), by Professor Verlat, is a little girl hugging her canine favourite; the head of the girl is a very successful study. 'Puddling' (92), J. Hayllar, is also a picture from the early spring-tide of life—a little boy wading on the shingle just within the spent scour of the foaming waves. To the unusually sturdy and firm person of the child, ample justice is done in the substantial manner of its representation. 'The Coquette' (158), Haynes Williams, is readily distinguished as a Spanish woman, and it seems that the women of that nation are especially selected to figure as coquettes. 'The Hour, but not the Man' (6), W. Holyoake, has the merit of telling its story without any broad or vulgar sign of what is meant. The picture simply shows two girls so described in attitude and expression as to indicate their impatient expectation of the arrival of some one. Such circumstances are frequently painted, but the insinuations are not always so delicately conveyed. Again, in 'Bakhshish' (20), W. Gale, is a poor Turkish mendicant—a girl standing with her hand extended in a begging attitude. This figure would be entirely unintelligible were it not that near her is a portion of a pipe, whereby it is indicated that she is begging of the smoker, some wealthy traveller seated on a bit of carpet just out of the area of the picture.

Over the fire-place in the gallery are hung numerous small pictures following the lead of that class of Art to which French painters have given so much celebrity. The feeling, however, given to the first that arrested our attention was directed, 'L'Attente' (26), V. Lagye, suggests rather the ancient German schools, but with much more refinement than is found in the productions of that time. It is a very excellent study of a single figure. 'A Rough Student' (17), J. W. Chapman, is also a small figure agreeably painted; and in 'A Political Discussion' (18) are two very spirited small figures. 'The Tasters' (25), D. Col, although a common incident, has uncommon point in its breadth of description. 'Adios' (32), Haynes Williams, tells us of a parting of lovers: the man wears the full dress of a *matador*, or *picador*; at least, of one who is about to figure actively in a bull-fight. He is taking leave of a girl, who seems to apprehend danger to him. The impersonations and their costume appear to be strictly national. In 'Dull of Hearing' (78), J. Smetham, the Saviour is seen addressing his disciples. Without any title the argument were plain enough, for the situations in the New Testament are countless that could be rendered by a company of upright figures. If he intended it as the initiative essay for a larger picture, the arrangement is one that has succeeded many times already; still, this is but a small portion of the difficulty. 'For some must Watch while some must Sleep' (73), J. Haynes, is perhaps a title too ambitious to describe the circumstance to which it alludes—a girl sitting by the cradle of a sleeping infant. It is, however, extremely well brought together, every object keeps its place, and nothing affects the prominence of the main point. We have also in 'Rent Day' (102), C. M. Webb, a picture of a good tenant, who comes prepared to discharge his liability; and on the other hand a steward or landlord, who, by his placid manner, shows himself satisfied. Certainly No. 107, by G. E. Nichol, will be accounted perhaps the most fragrant and graceful

flower-composition of the season. It is called 'Game, Flowers, and Fruit.' The game and the fruit, very good in their way, are only supplementary—nothing is looked at but the brilliant bouquet.

'A la Campagne' (115), E. J. Boks, may be accepted as describing the amusement of children in the country;—two, brother and sister, are feeding and playing with pigeons; it is a bright and well-drawn picture. Although the figure be carefully drawn and firmly painted, there is not enough of identity in 'Maria composing the Letter to entrap Malvolio' (134), A. F. Patten, to afford a key to the subject. In subtle expression and other valuable points, the picture has many claims to commendation. 'Our Rendezvous' (143), Professor Verlat, is an example of clear and good colour in head-painting—firm, round, and life-like. In 'Returning Home' (150), Madame Henrietta Ronner, we see a poor donkey, assisted by a dog, dragging a heavily-laden cart, on which, further to tax the powers of the animals, sits the owner or driver. The manner of the work betokens knowledge and experience. A 'Souvenir des Ardennes' (152), J. Van Luppen, is a landscape of infinite power and sweetness. 'The Market-Folk' (35), J. Peel, is a piece of roadside landscape without the slightest interesting feature, but worked into a picture very agreeable in colour, and very substantial in manner. In 'Moonlight' (40), C. Adloff, is seen a work claiming kinship with those of the Dutch professors of this effect. The sky of the 'Abbey Sands' (60), G. Bearne, wants detail and force, otherwise there is the material for a pleasing view. By G. F. Teniswood, 'A Cornish Headland—Moonlight' (65), and by the same, 'On Dartmoor—Evening' (131), are two small pictures which claim for the painter, as a student of evening and night-effects, credit for accomplishments of rare acquisition. There are other interesting paintings by J. C. Thom, A. Wust, N. O. Lupton, S. Worsey, Jacob Jacobs, E. Feyen, G. Gleig, E. Hughes, Von Thoren, A. Gilbert, and others. In water-colour are praiseworthy drawings by F. Claxton, C. J. Barraud, C. W. Chapman, V. Bromley, &c. We repeat that the quality of a proportion of the oil-pictures is superior to that of earlier exhibitions.

THE GUARDIAN ANGEL.

FROM THE GROUP OF SCULPTURE BY
J. S. WESTMACOTT.

THIS spirited example of sculptured Art—one of small size—is the property of Mr. A. C. Burnand, Lowndes Square; who is also the possessor of a fine and extensive gallery of modern pictures, which obtained due notice in our columns last year. Mr. Westmacott's 'Guardian Angel' is not only bold in design, but the sentiment of the work is appropriate, and most expressive of the theme. It may assume to represent a little child who, weary with wandering in pursuit of wild flowers, has thrown itself down on a grassy bank, and has fallen asleep. Over it is seated a faithful watcher from above, whose eye detects the approach of danger; and, involuntarily, as it seems, she stretches her hand over the little sleeper to shield it from harm. The action of the angel expresses this idea; and not alone in that of the hand, but in the bending of the lower limbs, as if to form a covering of drapery out of its ample folds. The face of the figure is fair, though stern. At her feet lies the child, in an easy, unconstrained posture, and heedless of any danger; dreaming, perhaps, of flowery glades, and blue skies, and singing-birds—visions of which may be passing over its closed eyelids. There is much poetical fancy and artistic merit in this charming little group.



THE GUARDIAN ANGEL.

ENGRAVED BY W. ROFFE FROM THE SCULPTURE BY J. S. WELLMACOTT.



SCHOOLS OF ART.

BURSLEM.—At the last annual meeting of the Wedgwood Institute School of Science and Art, the report of the Committee expressed surprise at the extraordinary apathy in quarters where ready co-operation might have been looked for; and that in a vast population, pursuing occupations necessarily artistic and scientific in their character, there should be so small a percentage desiring intellectual advancement, and so large a proportion content with an unquestioning and stolid dependence on traditional usage. The Committee felt they had some reason to complain of stinted payments by the Department of Science and Art on the results of examinations, as compared with what previous experience had led them to expect. The report congratulated the friends of the Institute on its being at last free from debt; and indulged in confident expectations, as the necessity for technical education becomes increasingly apparent, of a support of the school worthy of the enterprise and public spirit of the district.

HANLEY.—The annual meeting of this school took place on the 30th of October. The report of the Committee, read by the honorary secretary, after expressing satisfaction with the appointment of the new head-master, Mr. Bradbury, referred to the result of the last National Competition, in which the pupils of the institution carried off one silver, and two bronze medals; the examiners, in their report to the Department, remarking that they regarded with satisfaction the marked improvement in the studies forwarded from Hanley. The number of pupils attending the classes during the year was 174; the average monthly attendance of artisan-students being 82.

LEEDS.—In the early part of September an exhibition of drawings, &c., by the students of the Leeds School of Art was held in the Mechanics' Institute, and was attended by a very large number of visitors. Since the exhibition of last year the school has had a large accession of pupils, and the works produced show considerable advancement under the able superintendence of Dr. Puckett, head-master, who was himself an exhibitor of paintings on this occasion, when no fewer than 468 works were selected to be hung out of more than 2,600 of all kinds: many of them are highly meritorious.

NOTTINGHAM.—Three students of this school have recently received appointments as Art-masters: namely, Mr. J. Harris, to the head-mastership of the Salisbury and Andover School of Art; Mr. J. S. Tyrer to Mansfield; and Mr. R. Harris, assistant drawing-master at the Manchester Grammar School.

OXFORD.—The Vice-Chancellor of the University distributed, at a meeting at the Town-Hall, on the 31st of October, the prizes and certificates of merit to the pupils of this school. Addressing his audience, he congratulated the students on the great advantages opening up before them in consequence of the establishment, by Professor Ruskin, of an enlarged system of Art-training within the Taylor Buildings. With the utmost liberality the Professor had offered them the princely sum of £5,000 for the endowment of the master of the school, and had undertaken to provide it with all necessary drawings, models, casts, &c. The fund had been placed in the hands of Dr. Acland and himself, to be employed hereafter according to rules and regulations not yet drawn up. The very rev. gentleman complimented the students in both departments—those of Science and Art—upon their proficiency; and he expressed a hope that the artisan-classes would compete more successfully with the lady-students, enlarging upon the benefits, to the former especially, of artistic and scientific training.

YARMOUTH.—The annual distribution of prizes to the pupils of the Great Yarmouth school was made on the 20th of October. In consequence of a change of masters at the beginning of the year some difficulties in the way of regular study appear to have occurred; added to which, the Department had raised its standard of merit, and instituted several tests at the annual May examinations. Notwithstanding these facts, the school had obtained many favourable results.

OBITUARY.

JOHN HENRY ROBINSON, R.A.

ONE by one the men who have maintained the art of engraving, in its highest development in England, are leaving us; and their loss is the more to be deplored, because none are rising up to take their places. Line-engraving, as we have frequently had occasion to remark of late, is rapidly dying out; and the decease of Mr. Robinson, on the 21st of October, is the snapping asunder of one of the few remaining links that were left out of a long chain of engravers of a high class, from Woollett and Strange to the present time.

He was born at Bolton, Lancashire, in 1796; and coming up to London in his youth, was articled to the late James Heath. One of his earliest plates, engraved while yet a young man, was Mulready's 'The Wolf and the Lamb,' the copyright of which the painter of the picture presented, in 1823, to the Artist's Annuity Fund, an institution partly founded by him. The price paid by the Committee of the Fund to Mr. Robinson for the plate, was, we believe, £500; though it is stated by one of our contemporaries to have been 800 guineas. However, the result arising out of the sale of the print enabled the Annuity Fund to make an additional allowance to its pensioners of £3 annually. Among his other more important works may be mentioned 'Napoleon and Pope Pius VII.' after Wilkie; 'The Mantilla,' a portrait of Mrs. Lester; 'The Marchioness of Abercorn;' 'Little Red Riding-Hood,' after Landseer; 'Sir Walter Scott,' after Lawrence; 'The Emperor Theodosius rejected by St. Ambrose,' by Van Dyck—the picture now in the National Gallery; 'Portrait of the Queen,' after Partridge; 'Portrait of Rubens,' after Van Dyck; 'The Spanish Flower-Girl,' after Murillo's well-known picture; 'Mother and Child,' after Leslie; and 'The Sisters,' after Stephanoff. To these must be added a considerable number of book-illustrations. His last, and certainly not the least valuable, work was the 'Portrait of the Countess of Bedford,' from Van Dyck's famous picture. This was undertaken as a labour of love, so to speak, occupying his time just whenever he felt disposed to use his graver; for Mr. Robinson was not, pecuniarily, dependent on his art: had he been so, he would in all probability have left behind him more numerous examples of his talents. On the other hand, this independence enabled him to bestow on his plates all the time and labour he considered requisite to render them what they are, *chefs-d'œuvre* of engraving.

In 1856 he was elected an Associate Engraver of the Royal Academy; and in 1867, under the new regulations which then came into action, a Royal Academician. Mr. Robinson was among the eminent engravers who, in 1836, petitioned Parliament for an inquiry into the state of the art of engraving, and particularly its position in the Academy. He died at Petworth, where he had long resided, and was in the commission of the peace for the county of Sussex.

THOMAS ROBSON.

The late Mr. Thomas Robson, of Warrington, merits a place in the *Art-Journal* obituary from his talent, and also his connection with the art of a past generation. This gentleman, by his mother, was descended from the family of Hogarth, though

he has not told us whether this fact led to his love for painting. At an early age he was instructed by a Mr. Fothergill, then resident in Warrington, and on making progress, the late Dr. Kendrick obtained permission for the young artist to study from the pictures at Knowsley Hall. He went to London in February, 1818, and became a student of the Royal Academy, then at Somerset House, where he was complimented on his work by Fuseli, R.A.; shortly afterwards the Society of Arts awarded him its silver palette. On leaving home for London, Mr. Roscoe, of Liverpool, gave him a letter of introduction to Sir T. Lawrence, P.R.A., to whom he eventually submitted a specimen of his work, and at once became associated with him as an assistant; in a like capacity he made the acquaintance of the late John Jackson, R.A.

Mr. Robson exhibited at intervals at the Royal Academy so early as the year 1824, his pictures being invariably well hung. He made many fine copies (chiefly at the British Institution) from the works of Reynolds, Rembrandt, Titian, and Correggio, as he had a keen appreciation of their texture, colour, tone, and light and shade. When the late B. R. Haydon once lectured in the Warrington Theatre, Mr. Robson lent two of his copies from Reynolds; Haydon extolled their high merits as proving such a thorough appreciation of the originals and the master. For many years Mr. Robson lived a very retired life in his native town, his return to which was caused by failing strength. He died after a brief illness, October 17, 1871, aged 73 years.

FRANCOIS GASPARD AIME LANNO.

The death of this French sculptor occurred last month. He was born at Rennes, in 1800, and studied under Cartellier, having previously attended in the *atelier* of Lemot, and in the *Académie des Beaux Arts*, where, in 1827, he obtained the *Grand Prix de Rome*: in 1843, a medal of the second class was awarded to him. Lanno's principal works are the figures of *Æsculapius* and *Telaphus*, which ornament the *Ecole de Médecine*; the busts of *Poussin* and *Le Sueur*, on the *façade* of the *Ecole des Beaux Arts*; the statue of *St. Gérôme*, in the *Madeleine*; that of *Marshal Brune*, in the *Versailles Museum*; and that of *Montaigne*, in the town of *Périgueux*.

ART IN SCOTLAND AND THE PROVINCES.

EDINBURGH.—The Royal Scottish Academy has recently elected Mr. J. Pettie, A.R.A., and Mr. W. Q. Orchardson, A.R.A., Members of the Society; and Mr. W. Beattie Brown, Mr. J. Smart, and Mr. W. E. Lockhart, Associates. Messrs. Brown and Smart are landscape-painters; Mr. Lockhart is a painter of *genre* subjects.

LEICESTER.—A colossal marble statue, by Mr. Birnie Phillips, of the late eminent Non-conformist preacher, Robert Hall, has been erected in this town, where during several years his ministerial labours were carried on.

WINDSOR.—Baron Triqueti has forwarded to the Castle two of the marble *tableaux* intended to decorate the walls of the Albert Memorial Chapel. The marbles in question were locked up in Paris during the late siege; and as some of the materials used in them are procurable only from Germany, the work was necessarily delayed till the restoration of peace. One of the marbles, representing 'The Entombment of the Saviour,' is now being placed in position on the north interior wall at the east end of the chapel.

SALES AT SOUTH KENSINGTON.

WE have received, in common, we are informed, with the editor of every newspaper in the kingdom, a printed copy of the correspondence between Major-General Scott, R.E., and Alfred J. Copeland, Esq., on the proposed scheme for converting the International Exhibition into a gigantic bazaar. Having been, as our readers are aware, among the first to direct public attention to the unfortunate subject of this correspondence, nearly the whole of which, from time to time, came under our notice, we are yet compelled to remark that we re-read it with surprise. To every question there are two sides. Such, of course, is the case with the present dispute. But that the merit of the case should be palpable on the very face of the correspondence, is rare indeed. On the one side there is a plain, business-like, pointed, but not uncourteous, adherence to the actual terms of a published contract with the English Exhibitors. On the other hand there is a discreditable shuffling, to use a very euphuistic phrase, and a cool neglect of the most simple rules of business, such as we never remember to have before observed in any English correspondence of an official nature. Thus the Secretary of the Commissioners refers Mr. Copeland to the Journal of the Society of Arts, No. 918—which he states to be "the official record of the International Exhibitions" (a somewhat unintelligible phrase)—as the place where the origin of the tergiversation of the Commissioners is fully set forth. Three weeks afterwards the Secretary expresses his regret that he cited "a wrong number," and encloses another, No. 920, as containing "the report to which Mr. Copeland's attention was directed." In this substituted Journal Mr. Copeland, in common with other people, "fails to find one single word relative to the origin of the concessions made by Her Majesty's Commissioners."

With this damaging correspondence before the public, and on the very day on which a large and crowded meeting of West-end tradesmen was held to protest against the injury to their legitimate business that must ensue from the abandonment of the true principles on which alone International Exhibitions are deserving of support, we regret to observe the report of a meeting of three of the Commissioners, with Mr. Cole and General Scott, to sanction the policy of the red minute, and, in point of fact, to set the manufacturers at defiance. We regret that the Marquis of Ripon and his two colleagues should have thought themselves justified in taking so serious a step while forming so small a *quorum*. We do not hold the office of standing counsel or of consulting engineer to the associated manufacturers; nor did we consider it to be the part of the representatives of the artistic press to be present at this meeting. In fact, we could not but deprecate the tone of angry hostility, which, not unnaturally, but, we think, unwisely, characterised the invitations to the meeting. A public expression of sentiment, to be followed up by a numerous deputation to the Commissioners, should, as a matter of diplomatic wisdom, have been postponed until the matter had been quietly and clearly laid before the Commissioners themselves by a competent and duly authorised negotiator. In this case, in our opinion, the Commissioners would have felt bound either to satisfy the English exhibitors, or to retire from their position. In any event, the English exhibitors could not then have been reproached for the vigour of any subsequent steps. But the very appearance of a numerous deputation coming to clamour for what they hold to be right, puts every official person in a posture of self-defence. It cannot be otherwise. If the exhibitors find the Commissioners committed to a false course, it will be owing to this mistake. On the other hand, we deeply lament the unconciliating, evasive, and unjust way in which proper reclamations have been ignored. We feel sure that no one will suffer from this line of conduct so much as the promoters of the Exhibition. And we fear that the results of this persistent self-will will prove substantially damaging to the welfare of the establishment at South Kensington.

MINOR TOPICS OF THE MONTH.

THE NATIONAL GALLERY.—The question is often asked—and it has now been put by a powerful section of the Press—how it happens that the National Gallery is, every year, closed for two months. Its "staff" may require a holiday—but public, as well as private, servants must not let the interests of their masters suffer; there are, or ought to be, sufficient *employés* in Trafalgar Square to take their pleasure "turn and turn about:" and although it may be necessary now and then to have time for cleaning, that can hardly be a reason why all the Gallery rooms should be locked and bolted at once. But the "Trustees" are generally content with the honours that go with the gratuitous offices, and associate with them no duties; while the officers do just as they like, and are not cognizant of any responsibilities.—In our number for May, 1870, we noticed an assumed picture by Raffaele, then exhibited in the Louvre for sale. It belongs to Count Bermudez de Castro, who is understood to estimate its value at £40,000 sterling. The work, however, found no purchaser in France; probably, in part, on account of the enormous sum asked for it; and, partly, from the war which broke out soon after its appearance in the Gallery. Rumour states that the picture is to be brought over to England and placed in our National Gallery, to elicit the opinion of our Art-critics, and to effect a sale, if possible.

SIR RICHARD WALLACE is now occupied in building at his *château*, at Bagatelle, near Paris, a superb gallery for the Art-treasures bequeathed to him by the late Marquis of Hertford, perhaps the richest private collection in existence. Of these treasures, one most valuable picture has, through the munificence of Sir Richard, become the property of the British nation, to be added to the National Gallery. This is Terburg's famous 'Congress of Munster,' purchased by the Marquis of Hertford, at the sale of the San Donato collection, belonging to Prince Demidoff, in 1868, for the large sum of £7,280, though of very small size. No picture of its class has so high a reputation throughout Europe: its liberal donor is, therefore, entitled to the gratitude of the country to whom he has presented it. We could write a page of descriptive matter about this wonderful little picture—a portrait-gallery in itself—had we space.

THE INTERNATIONAL EXHIBITION.—The Commissioners of the French Department have sent in their report to the Minister of Commerce in Paris. It states that the actual sales effected by them amounted to more than £20,000; and that "orders" had been received which would realise double that sum. For works of Art upwards of £5,000 had been paid. One can scarcely wonder—seeing the peculiar privileges enjoyed by French manufacturers and tradesmen, which have brought them such satisfactory results—that our countrymen have taken alarm, and are organising measures for their own future interests.

THE ROYAL ACADEMY.—A third exhibition of the works of the old masters and deceased British painters will, it is said, be opened at Burlington House early next year.

MR. WOOLNER has completed a statue of 'Guinevere,' intended as a companion to one executed some time since representing 'Elaine.' Both subjects were suggested by Tennyson's "Idylls of the King."

THE GRAPHIC.—At the recent annual general meeting of this society at University College, the following artists were

lected members; *Painters*, Mr. W. Davis, and Mr. G. F. Teniswood, F.S.A.; *Architects*, Mr. G. Aitchison, and Mr. G. H. West, M.A. The first *Conversazione* of this season was held on the 8th ult. On the occasion of the next *Soirée*, December 13, it is proposed to exhibit a large number of the works of the late James Holland. The dates fixed for the four remaining nights of meeting are January 10, February 14, March 13, and April 10.

MR. FOLEY'S statue of the late Lord Canning has just been erected in Westminster Abbey.

MR. A. BACCANI is engaged on a full-length portrait of H.R.H. the Duke of Edinburgh.

MR. F. S. BARFF, the newly-elected Professor, commenced a series of six lectures on Chemistry at the Royal Academy, on the 2nd ult.

A PORTRAIT OF SIR WILLIAM TITE, M.P., F.R.S., &c., ex-president of the Royal Institute of British Architects, has been placed in the rooms of that society. It is painted by J. P. Knight, R.A., the cost being defrayed by subscription of the members.

MR. MILLAIS, R.A.—Encouraged by the success which this artist's 'Chill October' met with in the Academy Exhibition of the present year, he has been at work during a portion of the autumn months in Scotland, sketching the scenery of the Tay; the result of which we shall probably see next May. We hope, however, that in the fascination of landscape-painting Mr. Millais will not forget his "old love:" the author of 'The Black Brunswicker,' 'The Boyhood of Raleigh,' 'The Gambler's Wife,' 'Moses,' &c., &c., will not, we trust, be tempted to give up all his time to the picturesque in nature.

A STATUE OF THE LATE SIR JOHN BURGOYNE is proposed by the officers of the Royal Engineers, with which branch of our military service he was so long associated. If the necessary subscriptions be forthcoming, the statue will be placed in the School of Military Engineering at Chatham.

DR. G. G. ZERFFI commenced, on the 7th of last month, at the South Kensington School of Art, a course of forty lectures, "On the Historical Development of Ornamental Art, with special reference to Architecture, Sculpture, and Painting."

A PORTRAIT OF GARIBALDI, from life, at Caprera, has been very recently painted by M. de Brock, and is exhibited at the Flemish Gallery. As a painting, it is of very high class, broadly wrought, yet minutely painted. The patriot-soldier wears the traditional red shirt, the left hand rests on the pommel of a sword, and he stands erect, in the pride of conscience and right. Men may differ as to the estimate they form of the man, but he will be for ever classed with Washington and the other true heroes who fought for a cause they accepted as just, and gave freedom to their country. M. de Brock has produced a portrait that would do him credit if it had no name. It is a high privilege to give to the world and to posterity the features and form of such a man as Garibaldi; it is described by those who know him, as an admirable likeness: we may add our own testimony to that of others better able to judge. It is, however, Garibaldi; in his best time and mood, "flattered," it may be, but it will recall him as his friends wish him to be recalled. It is a good picture of a great man, the work of an accomplished artist, and its value is enhanced by the fact that the hero, now the recluse of Caprera, never actually sat for any other.

M. DE BROCK has also painted a companion picture—"the philosopher-statesman, Mazzini." Seen together, the contrast is very striking—the soldier and the politician side by side—the energetic, and yet benevolent head of Garibaldi, and the solemn, thoughtful features of his neighbour. The distinctive characters of both are seen and estimated at a glance. M. de Brock has been not less successful in picturing the one than he has in presenting the other. Both are admirable works of Art, and cannot fail to place the name of the artist high in the list of portrait-painters.

THE SOCIETY OF THE PAINTERS IN WATER-COLOURS opened their Winter Exhibition of Sketches (so-called), on the 18th of November—too late for our usual notice this month. In the January number we will give it due attention.

THE AQUARIUM AT THE CRYSTAL PALACE.—The Palace has rarely presented so interesting a sight as that witnessed by about 500 invited guests on the evening of the 10th of November. The Aquarium was then publicly "opened" and "inaugurated" by Professor Owen and Mr. Frank Buckland, who delivered addresses to the audience, highly complimenting Mr. Lloyd, whose long and continuous efforts to promote the study of marine-produce have been at length crowned by success. The speakers dwelt much on the great benefit that may, and ought to, arise from this introduction of a new pleasure: it will increase the enjoyment of visitors—but it will do far more, it will stimulate inquiry, and probably procure important results as a school in which to study the ways of creatures, many of which live a thousand fathoms deep beneath the surface of the sea. It may do more than that: it may teach how to multiply the means of supplying human-kind with wholesome food at a tithe of the cost buyers are now compelled to pay for fish. Regarded merely as a source of amusement, the Aquarium is an immense addition to the attractions of the Crystal Palace.

THE PICTURE-GALLERY AT THE CRYSTAL PALACE maintains its attraction for visitors. It is always "open"—a great advantage—when other galleries are closed; and, although winter now gives us almost as many picture-exhibitions as spring, the Gallery at Sydenham has some advantages which they have not. It is seen by a thousand people daily, admission is always free, and if there be some inferior, there is a large number of good, pictures—pictures that cannot fail to gratify and instruct. The indefatigable Curator, Mr. C. W. Wass, is continually astir to increase its power; he is not as well supported as he ought to be, considering that annually he effects a large number of "sales," and would do much more in that way if pictures of first class were supplied to him; and that medals, in gold, silver, and bronze, are liberally awarded by the Crystal Palace Company to artists who send works in competition. As it is, however, the Picture Gallery is a boon of magnitude to artists, to Art, and to the public.

FRENCH PICTURES FOR ENGLAND.—No pictures can be transmitted to England or to any other country from France, without being *visé* by appointed authorities. The reason assigned is that so many have been stolen from public depositories and from private collections, that a strict *surveillance* is requisite to detect and punish transgressors. Notwithstanding it is well known that many productions, not "honestly come by," have been brought to, and sold in London. Persons to whom works are offered

should, therefore, make inquiries before purchasing.

THE GUILDHALL.—Mr. McDougall, a prominent member of the Court of Common Council, has offered to defray the cost of a handsome stained-glass window for the Guildhall. The gift has been accepted, and the work will be executed under the direction of the City Lands Committee. Another window, presented by Mr. Alderman Cotton, is expected to be ready for placing about the same time.

MARCUS WARD'S CHRISTMAS CARDS.—The heralds of Christmas are with us already. The famous Art house of Belfast has issued an extensive supply of graceful, beautiful, and some of them exquisitely pictured cards for the "merry season"—merry, though it be in the gloomy month of the year. They are of "all sorts," flowers generally environing agreeable verses to recall "friends far off or near." Several are associated with apt music, others are quaint borrowings from mediæval games and costumes, others are embroidered in the loom, others are pure Christmas Carols of the olden time: in short, there is enormous variety—the only difficulty being to know where to choose. Though to give enough of colour seems a principal aim of Mr. Ward's artists—to make the gifts gay and sparkling—the cards are, for the most part, excellent examples of Art, well-drawn, and decorated with much taste. It is certain that this Irish firm of brothers have done much to popularise Art: they have educated a number of young men—and, we hope young women also—who have given to Ireland a new and prosperous trade; and they deserve well of their country, which so much needs—not home-rule, but home-manufactures.

THE MURANO GLASS.—Of all the gifts at Christmas there are, perhaps, none so novel or so graceful as those which Signor Salviati exhibits in St. James's Street, produced for "The Venice and Murano Glass Company, Limited." They are shown in immense variety—drinking-glasses, chandeliers, tazze, cups, candlesticks, bead necklaces, and other personal adornments—in a word, the collection is so numerous, that to give a list would be to fill a column. An hour may be pleasantly and profitably spent in their examination. They are sold at singularly small prices, when not "palmed off" as specimens of old Venetian glass—which, undoubtedly, they are, when they get into the hands of some dealers in curiosities, for it is by no means easy, except by connoisseurs, to detect the difference between the Ancient and the Modern.

LOOM-PICTURES.—Among the prettiest of all Christmas gifts are the pretty book-markers, and a score other productions of the loom, issued by Mr. Stevens, of Coventry. They may be justly called "pictures," for they are well and accurately drawn, and effectively coloured; yet they are evidently the work of machinery, although they will, to the uninitiated, seem productions of delicate hands, such as in the olden time wrought the tapestries that are now regarded among the most valuable, as well as rare, Art-efforts the dames, our ancestors, bequeathed to us. The machine was shown at work in the Exhibition Hall at Islington: we hope it may be seen at South Kensington in 1872. The productions of Mr. Stevens are very varied as well as numerous, and comprise brooches and earrings, "sachets," Christmas-cards, purses, and so forth, very gracefully designed and manufactured.

REVIEWS.

RAPHAEL OF URBINO AND HIS FATHER, GIOVANNI SANTI. By J. D. PASSAVANT, formerly Director of the Museum at Frankfurt. Illustrated. Published by MACMILLAN & Co.

It is matter of surprise that Passavant's life of Raphael, or, as we prefer writing the name, Raffaele, has not appeared in an English dress until now; yet in the very elegant volume lying before us, we have only an abbreviation of what supplied the German biographer with materials for three octavo volumes, whereof two were published so far back as 1839, and the third in 1858. The translators of the writings of Vasari and De Quincy, and Dr. J. S. Harford's comparatively brief memoir—reviewed in our Journal for 1857—give the leading facts of the great painter's history, but Passavant's work is by far the most comprehensive biography that has yet made its appearance. In 1860, a new edition, in German, corrected and much enlarged by the author, was published; this was translated into French by M. Jules Luntenschutz, and with many valuable annotations by M. Jules Lacroix, Curator of the Library of the Arsenal, Paris, was published in that city, in two closely printed volumes. It is from these that the work we are called upon to notice has been compiled: we should have been pleased to see the whole re-produced in our own language; but doubtless the publishers had sufficient reasons for the limitation they have adopted.

The portions of the original work omitted in the English edition are the Essay on the Genius of Raffaele, the Dissertation on the Works of his Pupils, the History of the Santi Family, as well as the Catalogue of Raffaele's Sketches and Drawings; but the valuable descriptions of all the known paintings by him, and the Chronological Index, the latter of so much service to all who desire to study the progressive character of his works, have very judiciously and wisely been retained. Thus there will be found in the volume almost all that the ordinary student or critic would require to learn.

It must suffice for our purpose that we point out the plan adopted by Passavant in his history as it is here brought forward. The contents are divided into four chapters; of which the first is dedicated to Raffaele's father, Giovanni Santi, of Calbordolo, a small town in the ancient Duchy of Urbino, at that time under the rule of Federico, Count of Montefeltro, under whose auspices and those of his successor Guidubaldo, the Art of the locality made great progress; Giovanni himself sharing in the patronage of these princes.

In the second chapter Raffaele is introduced, after the death of his father; and we trace him to the studio of Perugino, noticing the works he executed when there; thence to Florence, Bologna, and finally to Rome. In the latter city the third chapter opens, with a short dissertation on the influence of Julius II. on the Art of the city; this chapter is, in fact, entitled, "Raphael under Julius II.," the fourth and last being called "Raphael under Leo X." In these two sections of the book we have, of course, the most important period of the painter's life, with a critical examination of his principal productions.

In his preface to the German edition, Passavant states that he had examined for himself almost every known work written about Raffaele in whatever language, and had visited nearly every collection of pictures where an example of his accredited pictures was to be found. "We have visited," he says, "Urbino, the birth-place of Raphael, and all the places where he lived and worked. We have searched through all the libraries of Italy, Germany, England, and France, to collect materials. The archives of Rome, and those of the Medici at Florence, are the only ones that have remained closed to us, as to so many others." By the way, it is much to be desired, and more to be hoped, that under the present government of Italy, these absurd restrictions may be removed. Passavant's "persevering researches," he continues, "have not only given us a succinct understanding of the subject in general, but have brought out such

precise and numerous documents that they enable us to bring the whole of the life of Raphael into full daylight."

Independent of the value attaching to the book as a concise history of the painter, it is illustrated with a number—amounting to thirty—of photographs of certain of his most famous works: these prints are not all of equal merit as photographs, but, taking into account the admirable manner in which the volume is produced, as to binding, printing of the text, &c., nothing more attractive will, we venture to say, come before the public at this season, as a book fitted for the drawing-room or a Christmas gift.

SKETCHES AND STORIES OF LIFE IN ITALY.
By an Italian Countess. Published by the
RELIGIOUS TRACT SOCIETY.

This is published by a Society whose first principle it is to inculcate pure and high religious and moral sentiments: but Art is by no means neglected in the books it issues; the engravings are always good and sometimes of excellence unsurpassed. This volume is, in that respect, not so much entitled to praise as other books of the Society have been, or the engravings are badly printed. The "stories" are better than the "sketches," they are all deeply interesting; occasionally so exciting as to be "sensational." They illustrate life in Italy, its manners and customs, with graphic descriptions of scenery and romantic incidents that have chanced in the highways and by-ways of a country that will be always attractive to readers. If the stories be translations, the translator has done his or her work thoroughly well. They are written with some taint of "sectarianism;" the "religion" of the Italian people is described as so utterly bad as to be revolting: but we imagine it is difficult to reside in, or even to visit, Italy without arriving at conclusions such as those the writer so often puts forward—perhaps with more zeal than discretion.

OLD MERRY'S ANNUAL—1872. Published by
HODDER AND STOUGHTON.

If pleasant and well-written stories, knowledge so conveyed as to be easily acquired, and good engravings of good pictures, can attract and satisfy our young friends, they will cordially welcome a book that gives them all these at Christmas.

The contents are very varied: here are essays, tales, anecdotes, and "puzzles,"—not to name the score of other subjects comprehended in the plan. If "Old Merry" strives to make his readers happy, it is by making them wise; there is nothing dull in the book, but much that is exciting; all is, however, in good taste and sound morality; parents may, without fear, place the book in the hands of their children; there will not be many "issues" of the season more pleasantly and practically useful.

'IN DANGER:' 'ABANDONED.' Engraved by C. H. TOMKINS, from Paintings by ADOLPHE SCHREYER. Published by PILGERAM AND LEFEVRE (successors to Gambart and Co.).

A pair of very interesting prints, excellently engraved, from pictures by an artist who is well-known and largely "patronised" in England; one of the many foreign painters who are indebted to Mr. Gambart for the fame and more substantial recompense they have obtained in this country. 'In Danger' shows a night party in a war-waggon drawn by eight horses, overtaken by a snow-storm in a wood; 'Abandoned' shows a mortally wounded soldier left to die beside his dead horse; his comrades have passed on, his fate is settled. Both pictures are admirably drawn; the horses especially so. The sad episodes are touchingly told; the prints will be welcomed by all collectors.

ILLUSTRATED
JUVENILE LITERATURE, 1872.

PUBLICATIONS OF GRIFFITHS AND FARRAN.

WE cannot perceive any special change in the character of juvenile literature—it seems to be much as it has been for some years past; perhaps inclining a little more towards utility—and disposed occasionally to set aside amusements, or, it may be, to give them a scientific turn. The young ones of our acquaintance are by no means disposed to accept a change that would mingle improvement with their pleasures: the little women are certainly more devoted to "fastness" and liliputian "small talk," and, so to call it, "dress" than when we were young, and taught to consider a pretty white frock with a blue sash and sleeve knots the highest-bred frock in the world; and boys in jacket and trousers, white waistcoats and turned-down collars, fitted for the drawing-room. In those days the Christmas juvenile party began at four and ended at nine, and "papa" would have stared with astonishment if saluted as "governor."

The present race of boys and girls ape the habits and manners of their elders: the boy-child tries a cigar or a "clay pipe," and "miss" still far away from "her teens," flirts her fan, and decides as to what tint of pink or blue best suits her complexion. Sometimes we meet with a story that holds up the affected manliness, or womanliness, of childhood to condemnation or ridicule (both mingled are the most effective); but books for the playroom or nursery are inclined to keep in the track which Miss Edgeworth so firmly made, when she overthrew "Jack the Giant Killer," and sent "Valentine and Orson" to the shades.

GRIFFITHS AND FARRAN continue to issue their beautifully "got up" volumes from the traditional, as well as the actual, Corner of St. Paul's Churchyard. The first we inspect is, A JOURNEY TO THE CENTRE OF THE EARTH, from the French of JULES VERNE, author of "Five weeks in a Balloon." Jules Verne has written other juvenile romances, but they have not come in our way. We have a great objection to large books for children, they are, generally speaking, the most ill-used volumes in the play or school-room. No book intended for the amusement of our young friends should contain more than 200 pages; that size can be easily carried and may escape having its back broken—a fate which we fear must attend the "Journey to the Centre of the Earth," which contains 384 closely-printed pages, and is too heavy for a child, or indeed for any one, to hold. Why not print such a quantity of delightful matter in two volumes? dividing the fifty very clever illustrations—twenty-five in each volume. The book is a perfect treasure-house of adventure; it will set every boy who becomes its possessor wild to follow the footsteps of Professor Hardwigg and his nephew Harry. The affection of these two for each other despite the difference of age is a beautiful lesson in itself.

Girls will like the "journey" as much as boys, their delight being tempered by the knowledge, that they can never enjoy the adventures practically—though Harry and Bob—may!

The illustrations of this over-full book are by Riou; and many of them are very original both in conception and treatment; they are admirably engraved as well as designed.

AUNT JENNY'S AMERICAN PETS will find favour with young and old who have the love of natural history beating in their hearts. "Aunt Jenny" has only cultivated an acquaintance with the feathered favourites of our Trans-Atlantic neighbours.

We have not seen Miss Hopley's "Life in the West," which, if tinted with the same fidelity as

her ornithological favourites, must be full of interest. The lady begins with the "Humming Birds," which, after all, from the impossibility of keeping them alive in captivity, can hardly be called "pets," though they must be considered "favourites" of the highest order, when we recall their beauty and brightness, which enhance the loveliness of the American flowers. "The American Robin," which by the way, is not a robin but a thrush, will be in high favour with our young friends. The story told of him and his "ways" is very amusing; though our fair author does not seem quite clear-headed in her description of lace, as "Brussels-point" is certainly not a thick, but an exceedingly thin and delicate fabric, that washing in "soap and water" would destroy. Whatever the young ladies in "Maine" understand, they do not understand the art of "getting up" "point-lace," if Miss Hopley's description of their proceedings is correct. "Clear starching" is a refined and by no means an easy art, and young ladies in old times used to be instructed therein: but we do not wish to deteriorate from the interest it is impossible not to feel in this charming collection, of what a little friend of ours, who enjoys a peep into our Christmas volumes, calls "a book full of 'dicky-birds' and all about them." The illustrations are excellent.

THE YOUNG GOVERNESS, by the Author of "Gerty and May." This book we are told is intended for "girls;" and now that girls in and out of their teens read love-tales without restraint, there can be no objection to their reading such a pure and interesting story as "The Young Governess." The sketches of "young lady character," with their "ins and outs," their vanities and virtues, are cleverly and truthfully managed; and the winding up of a very well-conceived story is perfectly satisfactory.

A CHILD'S INFLUENCE, by Lisa Lockyer, is another of Messrs. Griffiths and Farran's very pretty romances for the young. At first, Kathleen seems unfit to bring about any change in her very peculiar, but kind-hearted "Great Uncle;" but truth and tenderness, and the watchful lovingness of a child, have within our own knowledge wrought improvements even more remarkable than those so prettily told by "Lisa Lockyer," whose name we have seen for the first, but we hope not for the last time.

THE OAK STAIRCASE, by M. and C. Lee, trenches upon the historical, and is, therefore, more ambitious than the ordinary juvenile Christmas book.

The authors say in the introduction that in their story they have made use of two entirely distinct narratives—the history of "the Maids of Taunton," which is an episode in the Duke of Monmouth's rebellion, and the ultra-romantic story of the marriage between Lord Sunderland's daughter and the Earl of Clancarty. To wreath those into one garland, and from the combination to depict the adventures of the young Lord Desmond and Frances Dalrymple, has been no easy task; but it has been accomplished with less confusion than we anticipated, and makes a very interesting story, a mingling of history and fiction cleverly combined.

ALDA GRAHAM AND HER BROTHER PHILIP is one of Mrs. Maryat Norris's best tales. She delights in getting her heroes and heroes into trouble, it would seem for the mere pleasure of getting them out again, and her style is free and animated. Her books are great favourites with boys. In this story she has taken more than usual pains in developing Alda Graham; but we shall not attempt to unravel it—our young friends will prefer to do it for themselves.

These varied books from the Old Corner are all admirably got up, and the illustrations, though of different degrees of merit, as a whole deserve the highest commendation.

FINIS.

THE INTERNATIONAL EXHIBITION

OF the productions of the ROYAL PORCELAIN WORKS AT WORCESTER, which, under the

manner of the blue and white enamel of Limoges; | alone, in England. They were painted by the
a class of Art in which the establishment stands | late admirable artist, Thomas BOTT. The sub-



direction of Mr. R. W. BINNS, F.S.A., have even surpassed their ancient renown, we give two examples—a EWER and a SALVER, in the



jects which decorate these examples of Art-manufacture are taken from the designs that illustrate the Norman Conquest, by D. Maclise, R.A.

In all respects—design, modelling, colour, gilding, and painting—they will be accepted as among the very best examples of ceramic art.

THE INTERNATIONAL EXHIBITION.

BY GEORGE WALLIS.

KEEPER OF THE ART COLLECTIONS, SOUTH KENSINGTON MUSEUM.

TWENTY years have passed since the Great Exhibition of 1851 solved the problem of the practicability and utility of International Exhibitions of Art, Science, and Manufacture, and, by a brilliant and almost exceptional success in its administration, gave an impetus to similar undertakings in various parts of the World.

As a matter of course, many objects were admitted to that first great Industrial gathering of the Nations which would not be considered admissible at the present time; and thus people who

unconsciously owe much of the knowledge they possess of Industrial and Decorative Art to the influence exercised on the various classes of society in England to that Exhibition, will be found quite ready to criticise what they assume to have been the shortcomings of an effort without parallel in the previous history of industry. In spite of all this, however, the fact remains, that its influence for good was enormous, and that as an exhibition, it left an impression on the minds of all old enough and perceptive enough to understand and grasp its purpose, which no subsequent exhibition has equalled.

The classification adopted in 1851 was a model upon which no subsequent exhibition has improved, except by an extension of the same principles. Its division into four great sections—raw material, machinery, manufactures, and the Fine Arts—was at

B

LUIGI FRULLINI, a renowned wood-carver of Florence, established his reputation at the Paris

this page two CHAIR-BACKS, part of a carved PANEL, and a CABINET wrought for Sir William Drake, to contain the cup and plateau of Cortelazzo, of which we give engravings on the

sitions. As models, they may furnish sugges-



Exhibition. His works are now appreciated in England: they are of the highest merit, both in de-



sign and execution. The workman is a true artist; hence his supremacy. We have chosen for



page that succeeds. Frullini's productions are very varied; they include, indeed, nearly every class and style of which the art is capable, the style "Italian" usually prevailing in his compo-



tions to very many orders of Art-producers.

once comprehensive and complete; for although pictorial Art proper was excluded for special reasons, which were undoubtedly based on sound conclusions, arising out of the circumstances of the time, the arts of design in their application to industry were especially provided for; as at that period so little had been done in Great Britain to supply its own wants in this direction, that the strong evidence of our shortcomings in comparison with our continental neighbours was of immense value; and it was not desirable to distract attention from this special point by the exhibition of pictures, the periodical display of which was already amply provided for.

Here, then, was an effort worthy of an industrial nation, conscious of great and almost unrecognised power in some direc-

tions, even amongst its own people; equally uncertain, and it may be said ignorant, of its shortcomings on other points. To prove its power where it existed, to learn its deficiencies where it needed the lesson, was a brave and wise thing to attempt; and it accomplished it, despite the croakings of those who desired to stand still, preserving a happy oblivion of their real position; or the selfish and exclusive spirit of the more enterprising who desired to monopolise the advantages which fortuitous circumstances, rather than their own skill and knowledge, had given them.

With raw materials shown as the basis of industrial operations; machinery as the means by which that material could be best wrought into form for the use of mankind; manufactures as the result of the application of machinery to raw materials; and the

This page contains three examples of the works of ANTONIO CORTELAZZO, of Vicenza, a self-made

artist, whose productions are chiefly remarkable for the process of inlaying iron with gold and

patron in Mr. Layard; the result is that his best works are in England. For Sir William Drake he designed and executed the two on this page—a BACILE, or



silver, which he claims to have re-discovered. It is termed by the Italians *gemina*, and was known

to the goldsmiths and metal-workers of the best period of Italian Art. Fortunately he found a

deep dish of steel; and an ANFORA, or ewer of steel. These specimens, as well as the CLOCK, belonging to William Spottiswode, Esq.,—a portion of which we en-



grave,— will give an adequate idea of Signor

Cortellazzo's singular skill, taste, and artistic

feeling. They are the gems of the Exhibition.

arts of design as the means of embellishing this result, thus adding beauty to utility—an arrangement of means to ends was realised, which could not fail to produce effects more or less striking according to the readiness of perception and aptitude in taking advantage of the opportunities presented to those most concerned. It would not be a difficult matter at this time to instance within our own knowledge, industrial establishments which arose almost entirely out of a first success in the Exhibition of 1851, or others which were "cramped, cabined, and confined" in their operations, from the fact of their existence being little known, but which are at the present day an honour to the country.

There can be little doubt that the happy thought of Mr. (afterwards Sir Joseph) Paxton, which resulted in the construction of a building mainly of glass and iron, so appropriately designated the

"Crystal Palace," from the outset, had much to do with the success of the undertaking. Certainly this alone gave a greater impetus to the employment of iron in architectural constructions than would probably have been arrived at for many years; while the fact that the building, when removed to Sydenham, and there re-erected with many improvements, has finally become one of the most legitimate sources of pleasure and instruction to the masses of the population of London, is by no means to be overlooked as a most important social and educational result of the Exhibition of 1851.

The system of prizes adopted in this Exhibition—which it is only right to say the Royal Commissioners inherited from the early promoters of the movement connected with the Society of Arts—was more or less a mistake, and that too of a grave character. Originally copied from the plan which had been followed in the

We engrave three of the many beautiful works contributed by Messrs. W. T. COPELAND AND SONS, the produce of their renowned works at Stoke-upon-Trent. In the first, a



STATUETTE of white porcelain sustains a tazza for flowers, the dish containing water either for flowers or gold fish. The second is a gracefully composed and skilfully modelled portion of a DESSERT SERVICE. The third is a VASE of large

size, being three feet high by three feet wide, an example of rare merit. As a



specimen of workmanship it has seldom been surpassed, while the flower-painting



is certainly as perfect as aught that has, at any period, been produced in England.

periodical national exhibitions of France, the suggestion of the Society of Arts that £20,000 should be expended upon prizes raised extraordinary expectations among one class of persons, and produced an equal antipathy to exhibit in such a competition in others. These latter were, however, the most numerous and influential of the manufacturers. Unhappily the suggestion, for it was in reality nothing more, was regarded as a distinct pledge to the public. The Royal Commission when formed had to adopt it. The more so as the Prince Consort being the President of the Commission, had been at the head of the preliminary movement.

The error was in a measure seen and recognised, and instead of large money-prizes being adopted, as originally suggested, medals only of certain grades were to be given. The late Sir Robert

Peel appreciated the difficulty and the danger of prizes recognising grades of merit, and he, as a member of the Royal Commission, largely influenced the final decision. This was, to have none but bronze medals, and to recognise only *kind*, and not *degree* of merit. Thus the Council-medal was given only for distinguished inventions, novelties of application of Art and Science to industry, raw materials, or modes of manufacture or important revivals in this direction. The prize-medal was awarded for excellence, not in relation to something else, but for positive excellence and perfection in the speciality represented. A jury-medal was also awarded to the members of the juries, and to the deputy-commissioners who administered the affairs of those juries.

So far the matter was much simplified, and as far as possible in any prize-system, invidious and injurious distinctions were avoided ;

We engrave on this page a CARPET, exhibited by Messrs. JACKSON AND GRAHAM—the renowned Upholsterers and Decorators. It is a

work of rare excellence, produced from a design specially prepared by Owen Jones. It is of the kind called “patent Axminster,” and is, we be-

lieve, the finest specimen of that fabric ever manufactured. Some idea of the delicacy of its texture may be arrived at when we state that there

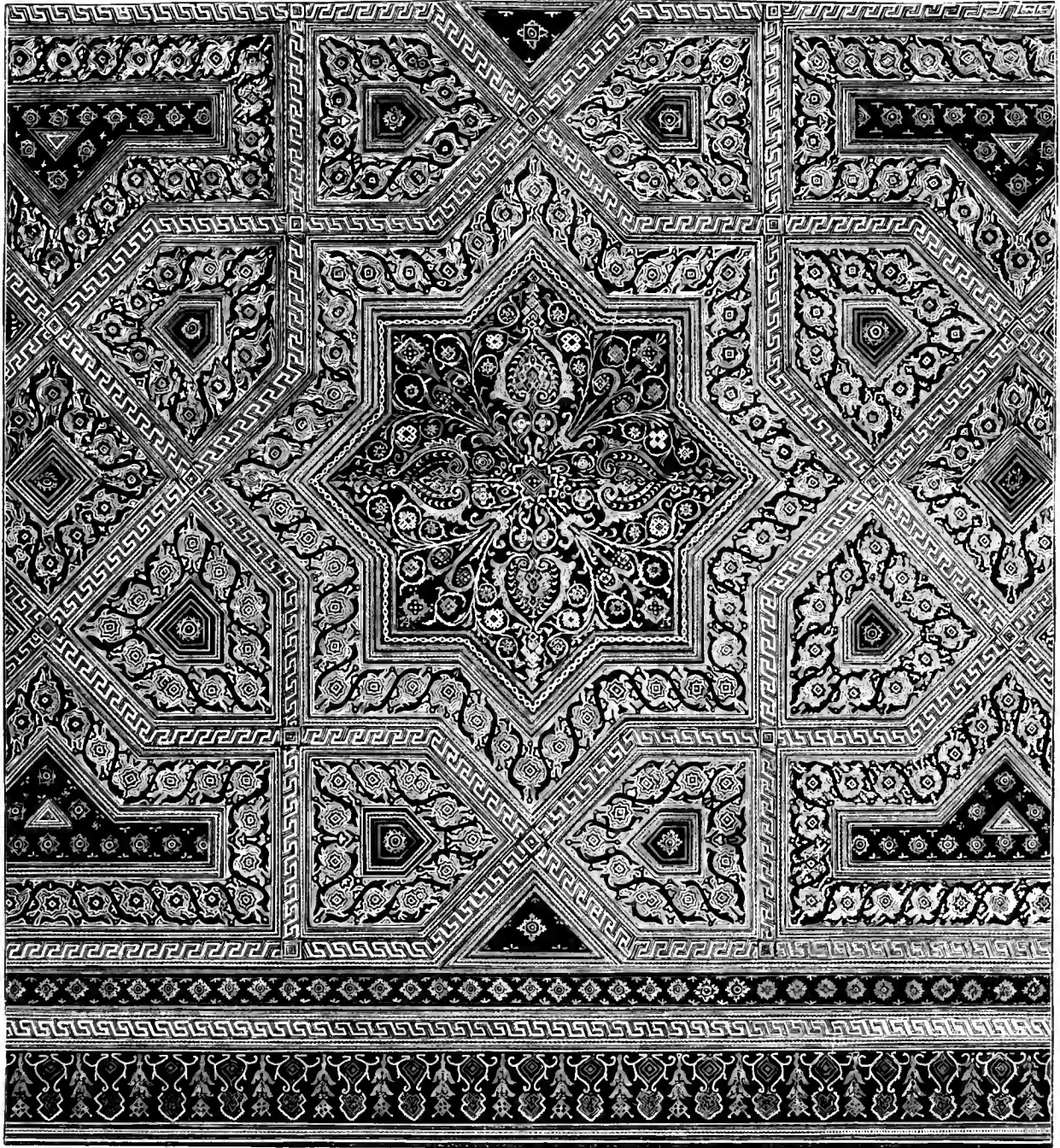

are two hundred and fifty-six points (or separate tufts of wool) in every square inch of surface. The drawing of the carpet, which is in the Persian style, is very elaborate; it has been exceed-

ingly well rendered in the manufacture, and the colouring is in the highest degree harmonious. As, this year, one of the “specialities” of the Exhibition consists of “woollen goods,” it is

exceedingly satisfactory to know that England has produced a work that may defy competition. We may engrave other productions of merit, to supply evidence of our great advance in this art.

but it *was* a prize-system after all, and, as such, had innumerable drawbacks which no administration could overcome.

The lesson of this and subsequent exhibitions has had the proper effect, and in the International Exhibition of 1871, no prizes are offered or will be awarded, except in certain special but comparatively, unimportant sections—such as designs for fans, in which it has been thought desirable to stimulate activity in a new direction by the offer of a suitable reward to female competitors. These prizes, however, are not offered by the Royal Commissioners, but by her Majesty the Queen, whose example has been followed by other distinguished personages.

The Great Exhibition of 1851 resulted in a surplus of £173,896; but in this sum was included £68,000 obtained by subscription from the various great towns and provincial districts of the three

kingdoms. This amount was not *surplus* in any sense, but *capital*, and as such ought to have been invested separately from the true surplus, in accordance with a pledge given by the Royal Commission, “that should any surplus accrue it would be used to the promotion of similar exhibitions in the future.” Happily this pledge is at length fulfilled in the International Exhibition of 1871, as the Royal Commissioners of 1851 have taken the responsibility of the whole management. Not so in 1862; for on that occasion a new commission had to be formed, a guarantee-fund raised, and although the amount received at the London International Exhibition of 1862 exceeded the amount received in 1851 by nearly £11,000, no surplus accrued, chiefly from a reckless and unnecessary expenditure in building, which the Royal Commissioners of 1851 never would have sanctioned had the original capital

The two works engraved on this page are the productions of Messrs. HANCOCK & Co., the eminent



goldsmiths and jewellers. The first is the TESTIMO-

NIAL presented by his constituents to W. H. SMITH, Esq., M.P. for Westminster. The highly ornamented body and handles are designed by OWEN JONES; the Medallion and figures are modelled by Signor MONTI. The other engraving is of the BRIGHTON CUP—



1870. Both are works of great merit and beauty, fine examples of design, and admirable specimens of Art and Art-manufacture. The artist of the latter, as of the former, is Signor MONTI.

subscribed in 1850, with the additions which would have accumulated in the intervening ten or eleven years, been employed as it ought to have been in the promotion of the undertaking of 1862. But we anticipate.

One thing is perfectly clear: the Great Exhibition of 1851 exposed the deficiencies of British manufactures in the great and important element of Art. In perfection of manipulation, in integrity of structure, and skilful use of material, in finish, in fact in all that gives quality and substantiality to industrial products, England was in the main pre-eminent; but when the question of embellishment by the addition of beauty in form or decoration came in, it was apparent that we had at once very much to unlearn as well as learn. Greatly misled by the prevailing tendency to test all designs, especially industrial design, by a

French standard, which had grown up so largely during the period that had elapsed since 1830, from the growing intercourse of the two countries, the English manufacturer almost repudiated everything like originality. He cried out for something new, but that something was inevitably the latest product of a French loom, the decorations of a French *salon*, the conceits and abominations which were habitually produced as "*objets d'Art de Paris*." The skilful *technique* misled both the English manufacturer, designer, and purchaser. The fitness of form to use, the suitability of the material to the purpose to which it was applied, or the means by which it had to be wrought, never seemed to be considered, or at least so rarely, that when these elements were visible it was the exception and not the rule.

Now we do not hesitate to say that although, on the one hand,

The carved MIRROR FRAME is the work of V. BESAREL, of Venice: it was produced for one of his English patrons, Sir William Drake,

by whom it is contributed to the Exhibition. It

is needless to say that the carver is also the designer—a true artist, who conceives and executes, and creates objects of surpassing excel-

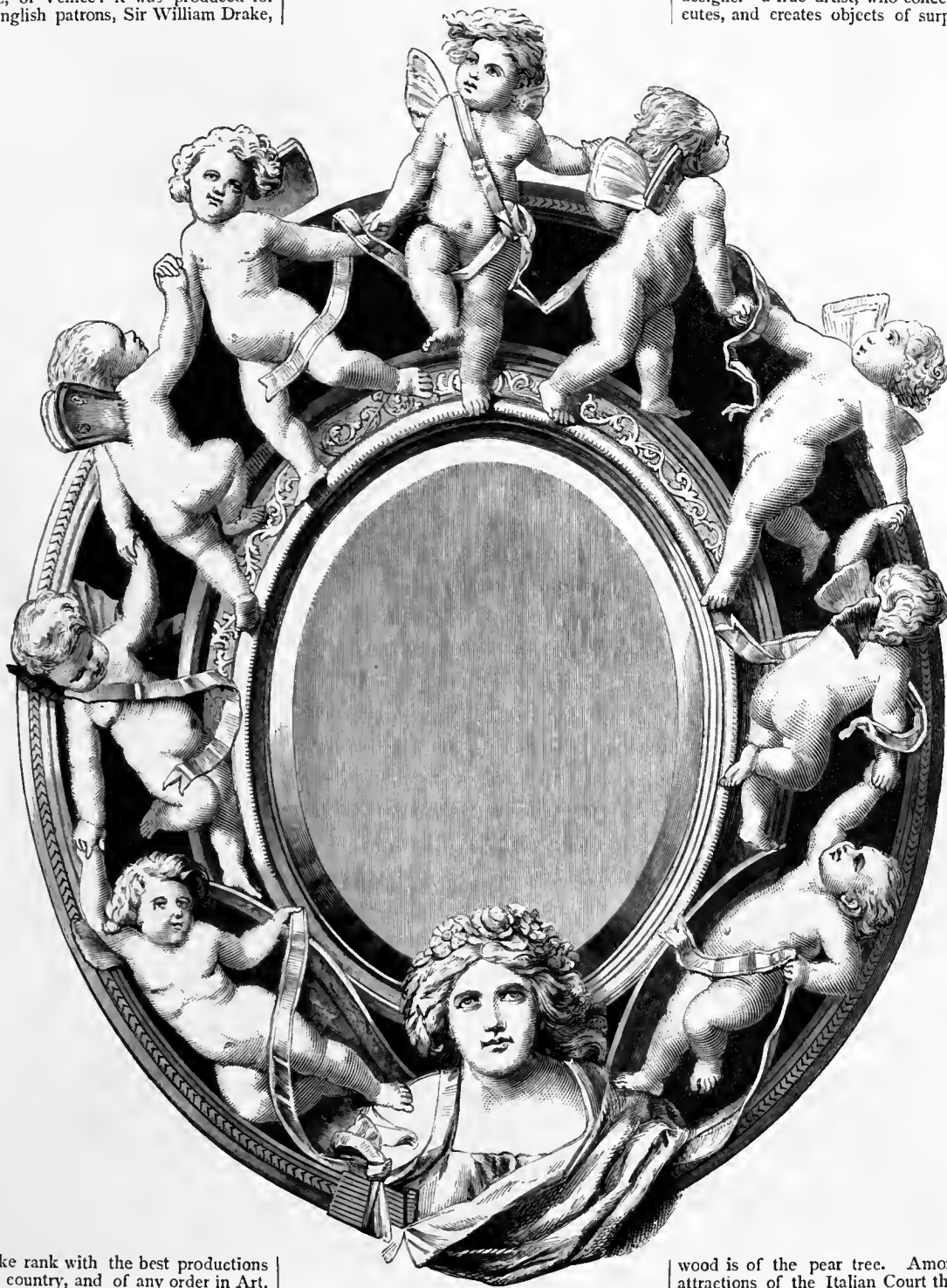

lence that take rank with the best productions of any age or country, and of any order in Art. The composition here is admirable; the dancing Cupids seem absolutely to move. The carving

is graceful yet firm; it is in high relief, and the

wood is of the pear tree. Among the many attractions of the Italian Court this is unquestionably one of the most perfect. But to Italy the Exhibition of 1871 is very largely indebted.

the Great Exhibition of 1851 gave a great impetus for a time, to the production of decorated objects in France suited, as it was supposed, to the English market, it also led eventually to the reconsideration of the whole question of design as applicable to manufactures and industry generally, and laid the foundation for considerable originality, a shaking off of the trammels of French design, and a seeking to start upon something like sound principles.

Of necessity, the fruits of the seed thus sown were long in showing themselves; in fact, in many directions they are not visible now; and it is only to the more perceptive, and those who, having opportunities seek to utilise them, that these results are at all visible. One great and radical difficulty has stood in the way, and indeed still stands in the way. It is this. The popular

love of Art is distinctly directed to pictorial and sculptural Art, mainly to the former; and while the growth of a love of modern pictures, and its liberal patronage of late years, is a subject for congratulation, the fact must not be overlooked that the ornamental and decorative Arts have not had their fair share of attention; and Art-students who might have done honour to themselves and their country by the application of their ability to industrial and ornamental design, have been led away by the, to them, more fascinating pursuits of pictorial design, in which, without becoming famous painters they have been enabled to obtain a livelihood. Thus we are compelled to say at this time—and the conviction is a very disagreeable one—that ornamental and decorative Art is not popular as a study in our Schools of Art; and, therefore, is not making that progress in connection

We give on this page two examples of the long-renowned establishment—MINTON & Co.—of Stoke-upon-Trent. The first is a JARDI-



NIERE, or Fountain, treated in the style Lucca della Robbia, in blue and white enamel. The objects of the composi-

tion are borrowed from marine subjects. The general ornamentation is bold and free; and it has the recommendation of novelty. The second is also a JARDINIÈRE—oval; it is gracefully and effec-

tively composed. Both are designed and modelled by artists of the firm, and each is an admirable specimen



of the perfection to which the style has been carried by energy and indefatigable perseverance to obtain for such productions large popularity.

with British manufactures, that every one interested in this question (and who is not?) ought to expect. Nor are we certain that the manufacturer, who complains that he cannot get that assistance which he has a right to expect from our Schools of Art, is blameless in this matter. In too many instances suitable encouragement has not been given to rising ability even on his own premises, and the foregone conclusions and prejudices of foremen and managers have caused real improvements to be "pooh-pooched" and neglected.

It must be quite clear that Art is a plant which requires a fostering hand. It is easier chilled and discouraged than developed. Its application to industry requires no ordinary tact and perception, and therefore the decision as to the possibility and practicality of any improvement should never be left simply to

foremen or managers, who, whatever may be their ability in technical matters, may really be as ignorant of any true principle of Art in its application to their own industry as the youngest apprentice placed under them. No doubt the cry, "It won't sell," is a very potent one, and the economies of every trade have to be deeply considered. Frequently the "it won't sell" really means, "I won't sell it;" and if the true cause were known, it would be found that the addition of the words "because it is not my design, or suggestion," would give the "why and wherefore."

Still, progress has been made and goes on, slowly it may be, but we trust, surely. Certainly, periodical International Exhibitions, with all their drawbacks and shortcomings, help forward this progress.

This CABINET, the *chef-d'œuvre* of the famous upholsterers and decorators, JACKSON AND GRAHAM, has not been surpassed by any production

throughout at the establishment in Oxford Street. Its purpose is to serve as a casket for jewels: it is very rich and elaborate, yet harmonious in detail,

skilfully combining a variety of different woods, in combination with a liberal use of ivory. It is in the centre panel that the greatest richness is concen-

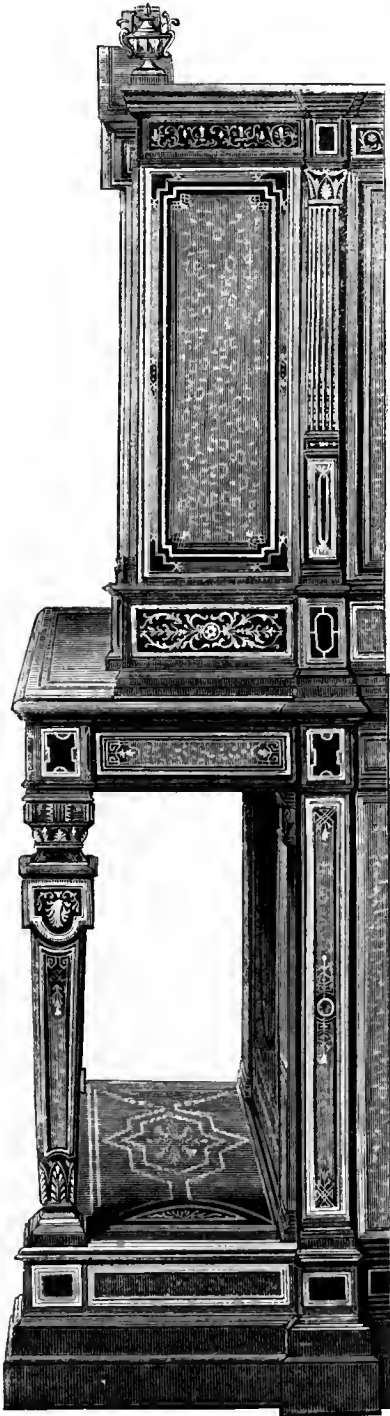

of its class, at any period. It is designed by ALFRED LORMIER, and has been "worked"

trated, and there the artist has aimed at riveting attention. Our space will not permit us to

describe this very beautiful production of Art-manufacture. It is, in all respects, perfect.

The Dublin Exhibition of 1853, admirable as it was in its illustration of Fine Art, was too near the effort of 1851 to produce any distinct result. The International Exhibition held at New York, also in 1853, and supposed to be, what it was not, an exposition of the industry of the United States of America, in combination with important contributions from the several states of Europe, had little effect.

Its recognition by the Federal Government, so far as it could be recognised, gave it a certain *status* in the eyes of the British Government; and a commission was appointed to go out to New York, not to represent or in any way interfere with British interests at the Exhibition, but for the purpose of reporting upon the expected gathering of the industries of the Federal Union. Finding that these were only partially represented in the Exhibition, the

members of the commission visited the various great cities, seats of manufacture, and localities of industrial and agricultural enterprise, and reported upon what they saw in manufactories, mines, farms, arsenals, ship-building yards, and public institutions.

Much of the information embodied in these reports has not been utilised in this country to this hour, for it happened that they came before the public at the period when the Crimean War was about to commence. The report on the manufacture of fire-arms came in *apropos* enough; but the system reported upon as in full work at Springfield, in Massachusetts, by Mr. (now Sir Joseph) Whitworth, was treated as a *chimera*, utterly impracticable; and that, too, by the producers of small-arms in this country, who, a few years afterwards, founded a public company to adopt this very system and carry it out at Birmingham.

D

The Silk and Wool "figured TERRIES," of which we give four examples on this page, are for curtain-hangings and other upholstery



purposes. They are the manufacture of Messrs. WILLIAM Fry & Co., of Dublin, who have thus introduced a new and very successful trade

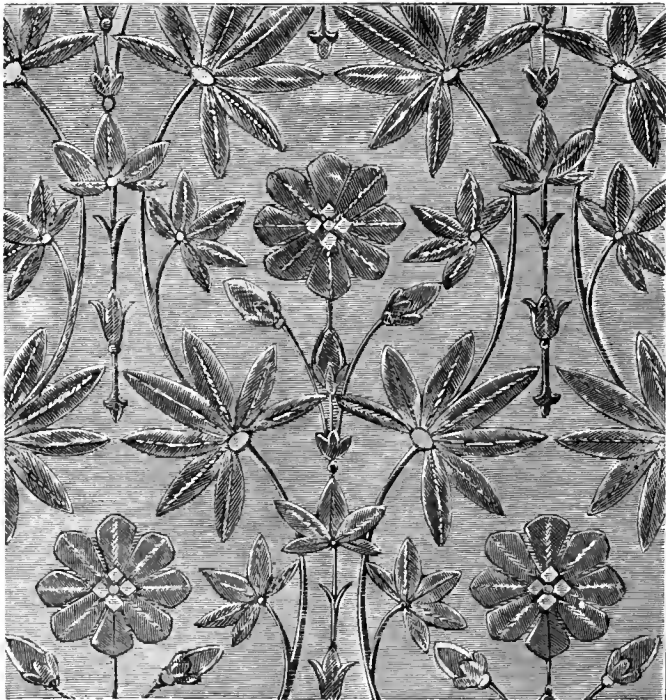

into Ireland—a country in which manufactures are greatly needed, but where few exist. These productions of this eminent firm (whose Poplins

have so long maintained supremacy) supply the stock of all the prominent "furnishers" of England and of the Continent. They obtained medals



at all recent competitions, including that of Paris, "for excellence of manufacture and superiority of design." The material has a peculiar



richness and metallic lustre, that render it superior to the "all silks" made for similar purposes,—with the advantage of being very much lower in price.

Nothing can afford better evidence of the value of exhibitions than the fact, that people who would be utterly sceptical as to the possibility of an improvement, or invention, if simply reported upon by the most trustworthy authority, are compelled, by the examination of facts, to believe, and ultimately to utilise what they see, when it is placed before them. In the case of a mere report, their very knowledge and experience seem to be against the facts stated; in the case of an examination, this knowledge and experience enable them to appreciate the more fully the accomplishment of the improvement or invention which they would have otherwise deemed impracticable.

In 1854 the period arrived for holding the usual quinquennial exhibition of French Industry—the two last having been held in 1844 and 1849. Both of these displays had done much towards

arousing attention to the necessity for similar gatherings in England, which culminated in the Great Exhibition of 1851. In 1849 a proposition was even made to throw the Exposition open to all nations, but it was overruled. In 1854, however, an International Exhibition was decided upon, to be held, in 1855, at Paris; and a great effort was made to rival, and, if possible, surpass, the gathering of 1851. A special building, the Palais de l'Industrie, was erected in the Champs Elysées, intending to be, as it has since been, a permanent centre for various expositions of Art, Science, and Industry in France. A variety of annexes supplemented the space afforded by the main building. One of these annexes extended along the banks of the Seine, some three quarters of a mile, from the Pont Royale to Chaillot, and was chiefly devoted to machinery and raw materials.

The CHURCH PLATE, of which Messrs. COX AND SON are the "makers," includes every possible variety—patens, chalices, flagons, spoons, alms-dishes, offertory-basins, portable

sets of communion-plate, &c. &c.; and also other objects for church uses—pulpits, fonts, lecterns,

coronas, gas-standards, revedos, altar-tables, tomb-rails, carpets, &c. &c. We give on this page groups of their more recent issues; they are in all instances admirable as works

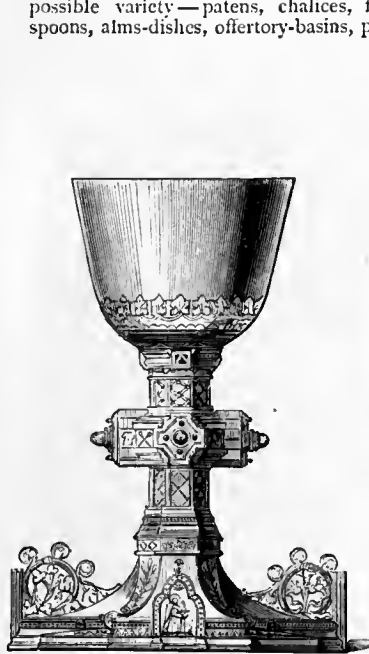

of Art—in design, modelling, chasing, engraving, and in ornamentation derived from the introduction of costly gems. Messrs. Cox and Son have been joined in the Art-manufacture of church-plate by Mr. JOHN KEITH, whose long experience and practical knowledge will be



largely beneficial to them. They have received several prize medals; very recently that awarded by the Society of Arts, accompanied by strong commendation of the "well-directed and intelligent spirit of enterprise that has led to the production of works of an artistic character."

An important feature of this Exhibition, as compared with that of 1851, was the recognition—most wisely in this case—of the Fine Arts of painting and sculpture; and a separate temporary building forming a series of galleries was erected, affording ample space for a magnificent display of modern European Art. England, for the first time, put in a practical claim to be considered to have a school of painting. Very fierce was the battle of the critics, but the juries confirmed the general impressions of mankind that the English school really had an existence, and was worthy of honour and encouragement. The French critics, however, were not quite satisfied (if indeed they are so to this day) until after the Exhibition of 1862, in London, when the whole century of British Art was fairly illustrated.

We are not at all disposed to regard the display of British

industry at Paris in 1855 with more favour now than we did at the date of the Exhibition. Whole sections of our manufactures were comparatively unrepresented, or worse still, misrepresented. By an attempt at over-refinement in the classification on the part of the French commission, a comparative break-down occurred in the organisation and administration; British interests were placed at a very serious disadvantage, and the contributions so scattered, that it may be recorded as a fact, that productions of the British Islands could be found in almost as many places as there were provinces in France.

The industries which made the most impression upon the French people, standing as they did upon their own ground, were the pottery and porcelain of Staffordshire and Worcester, the machine-made lace, especially curtains of Nottingham, and

Messrs. HOWELL AND JAMES supply us with two examples of the LACE of Honiton. beautiful in design and exquisitely perfect in execu-

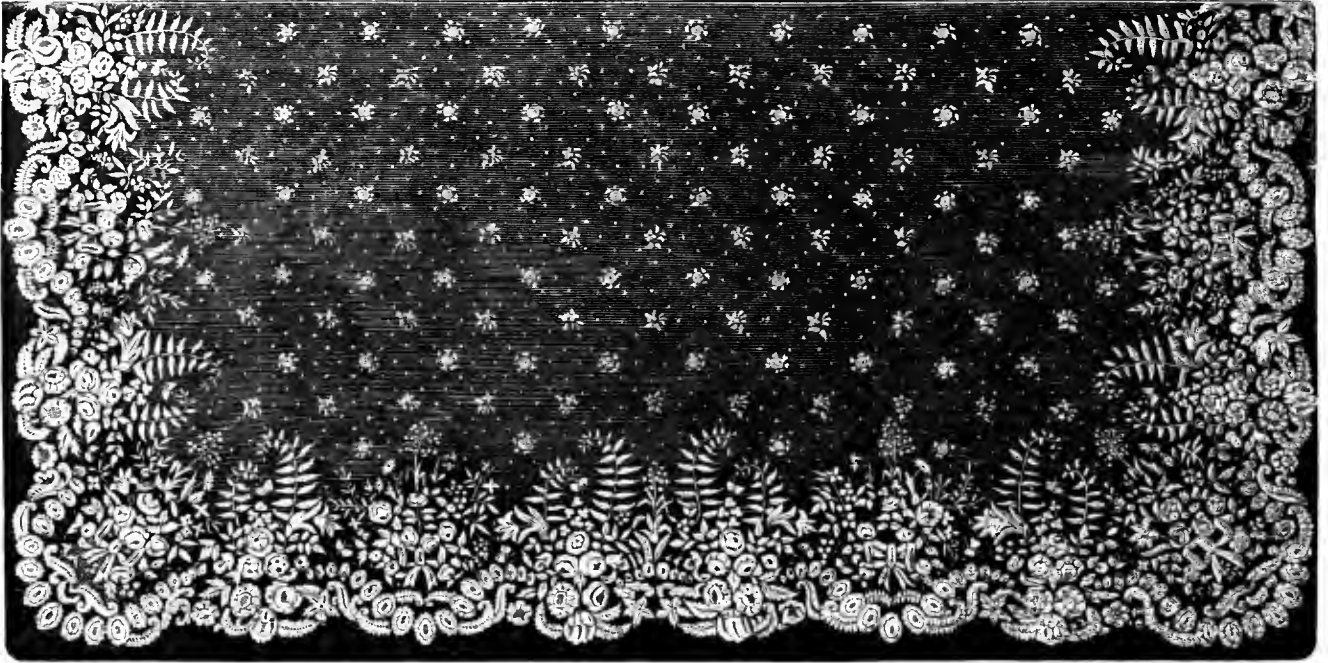

tion. Finer specimens of the art have never been produced in England. The VEIL was made for, and worn by, her Royal Highness

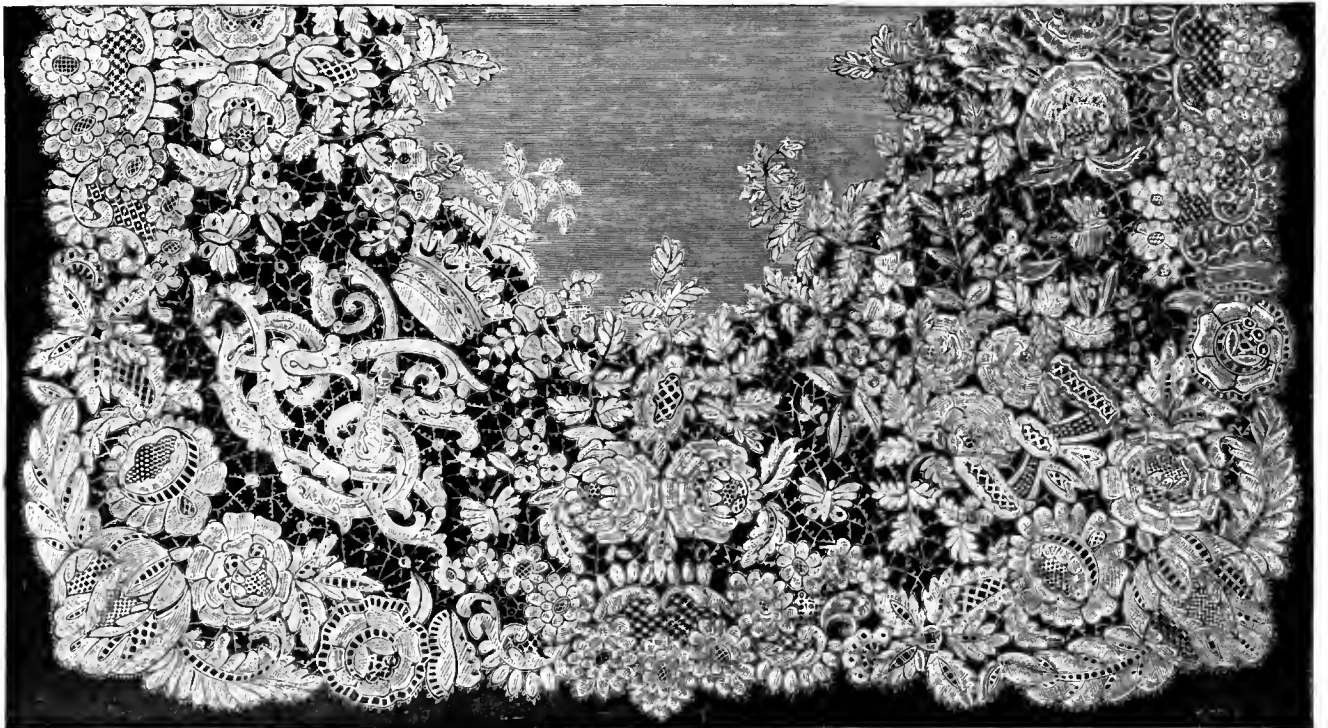

the Princess Louise at her auspicious marriage with the Marquis of Lorne; it was worked from a sketch by the Princess. The other engraving is from the HANDKERCHIEF of her Royal Highness. These engravings will, therefore, have an interest beyond that they derive as works of Art.

the cotton-manufactures of Manchester; the latter being most systematically displayed as compared with the very meagre illustration of this great national industry in the Exhibition of 1851.

Minton's display of porcelain and earthenware, backed as it was by Copeland's and others, took Sèvres by storm, so to speak, and the Director of the Imperial Manufactory had to look to his laurels, and proceed to take speedy steps, by the production of special works, in order to maintain anything like the position which Sèvres, as of right, claimed for itself; but which was now so seriously assailed by the private firms of England.

The prices too at which useful and decorated earthenware could be produced, was something so utterly unexpected by the French public, that in combination with similar results in other branches

of manufacture, the pending treaty of commerce was rendered much more easy of accomplishment than it otherwise would have been, had no such Exhibition taken place.

The machine-made lace-curtains of Nottingham were, in the eyes of the French, marvels of cheapness; and, thanks to the recent improvement in design in that city, arising mainly out of the well-utilised action of the School of Art, the majority of the designs were of a character very far superior to anything which had previously emanated from the machines of Nottingham, and the commercial result was in accordance with the success attained in this direction. Of the cotton-fabrics of Manchester little need be said. In all the more useful qualities, the Exhibition proved British supremacy alike in quality and price. Mulhouse surpassed Manchester in the beauty and elegance of its first-class printed

Engraved on this page are four figures that illustrate "The Months,"—MAY, SEPTEMBER, MARCH, and JUNE,—part of a series designed and

ROWLAND J. MORRIS, is very young, yet he has created works that have at once placed his name among those of the most famous of our sculptors.



produced in *terra-cotta* for the Wedgwood Institute at Burslem, a build-

The series consists not only of the twelve months, life-size, but of a



ing erected in the chief town of the potteries, to honour the memory of the great benefactor of the district, Josiah Wedgwood. The artist,

frieze in ten parts, describing, by finely modelled figures, the avocations of the potter, from the mixing of the clay to the finishing of the vase.

muslins and the lighter cotton fabrics, but in the substantial character of their fast madder-prints, the Lancashire printers carried all before them.

The prize-system was carried to the verge of absurdity in this Exhibition. Not only were the distinct gradations of gold, silver, and bronze medals recognised, but a "Grand Prix," in most of the important sections of both Industry and the Fine Arts, together with the distinction of the Legion of Honour, was given in such profusion that in some respects the most distinguished persons were those who escaped reward: especially, as was not uncommon where they were unknown and unfriended, when they had really done something worthy of recognition. England had no cause to feel that she had been in any way neglected, in the aggregate, in the distribution of honours, barren as they were of the higher dis-

tinctions. That, however, was no fault of our French neighbours, but rather of the insular feeling which so largely prevails amongst us, that inasmuch as we are not very liberal in our recognition of public services other than military, it is considered an offence and a reproach for any foreign nation to express its appreciation of the ability and usefulness of a British subject by honours which we ourselves refuse to give; and we invoke orders in council to repudiate them when given by others. On the whole, the English contributors to the Paris Exhibition of 1855 had no special reason to congratulate themselves, except in the matter of helping forward the Treaty of Commerce.

It was always well understood by those most intimately connected with the Great Exhibition of 1851, that a similar gathering would take place in London after ten years had elapsed, and

The renowned establishment at Murano, Venice, which has now its *depôt* in London,

very often, indeed, the latter will be preferred to the former; but of late years the manufactory

has issued productions of greatly improved character, stimulated by the aid of an English com-



exhibits chandeliers and others of its varied works. They are, for the most part, copies from ancient examples of the skill of the earlier



pany, and a consequent supply of capital to render its resources available, educate the workmen, and encourage the enterprising "restorer,"

Dr. SALVIATI, under whose direction it is conducted. Of the specimens selected, attention need be drawn to only one: the PLATE is a



"makers" of Venice; an experienced critic only could determine the old from the new:



very beautiful design, and a most successful example of workmanship, requiring to "burn" in

the painted drawing a rare combination of knowledge, judgment, and the best manipulative skill.

a proposal was accordingly made for holding such an Exhibition in 1861. The Italian war, and the general uncertainty of public affairs on the continent, together with some dissatisfaction with the preliminary arrangements, led to the postponement of the undertaking to 1862. To the disappointment of many persons the commission for the Exhibition of 1851 declined the responsibility of the proposed work, in spite of the fact, which has been already alluded to, that not only the surplus funds resulting from that effort, but also the subscribed capital, was held in trust by that body for this very purpose, as, to our minds, a primary consideration, taking precedence, when necessary, of all others. Unhappily the duty was not acknowledged, and another Royal Commission was issued for conducting the proposed International Exhibition of 1862. The Prince Consort was president of this body as well as

of that of 1851, and this, together with a selection of other members, afforded a guarantee that the experience of the past effort would not be altogether ignored. The difference in the pecuniary results of the two Exhibitions has been already noticed.

The formation of a large guarantee fund was a necessity of the undertaking from having no capital to start upon, as after the experience of 1851, it would have been useless to attempt to obtain subscriptions again. Happily, although there remained no surplus, the guarantors were saved from meeting their responsibilities, chiefly through the forethought of the contractors for the erection of the building, with whom, however, a compact was made of such a character as effectually excluded any chance of a final surplus to the commission.

The character of the Exhibition, and the general scheme of the

We engrave on this page the last work of THOMAS BOTT—a VASE from the Royal Porcelain Works at Worcester. It is one of a pair, painted by the artist shortly before his lamented death. The

subjects are taken (by permission of the Art-Union of London)

from the marvellous drawings by MACLISE which illustrate the Norman conquest. Of the vases, one is termed "the William," the other "the Harold;" distinguished by medallion portraits of the



Norman and the Saxon kings. The most interesting points in the history have been chosen: that shown in our engraving represents the coronation of Harold in the Abbey of Westminster. Royal eagles

form the handles. The style is the well-known style of pro-

ductions of this class, after the manner of the old Limoges. The works at Worcester have produced many grand examples of ceramic art: they have never issued at any time any superior to these.

classification, was similar to that of 1851, with the important addition of a section of Fine Arts which embraced paintings of the English school from 1762 to 1862, in other words, the whole century within which the school may be said to have arisen. As works of great value, both in oil and water-colours, had to be borrowed from the nobility, gentry, and others who possessed them, it became a necessity to erect permanent galleries of such a character as to give every possible security against injury, especially by fire, and these galleries formed a serious item in the expenditure of 1862. The fatal cost, however, arose from the erection of a pair of domes, of which all that could be said was that they had a greater span than any other dome in existence! The site selected for this Exhibition was not far from that part of Hyde Park in which the Crystal Palace of 1851 was erected, and the land belonged to the

Royal Commission for that Exhibition, having been purchased with the surplus. So far then there was an appropriateness about the arrangement, which was further enhanced by the fact that the commissioners of 1851 undertook to complete the buildings between the site of the proposed Exhibition and the Royal Horticultural Gardens, to whom they had leased a portion of the estate. This, being permanent, remained after the final removal of the buildings of 1862, when it was found that no means existed for their retention, and they are again utilised in the present Exhibition of 1871.

That the International Exhibition of 1862 was popular is a fact which cannot now be disputed. That it was valuable in an important sense is also undeniable. It showed a most decided improvement in many important branches of British industry subse-

The firm of "GILLOW," upholsterers, has been famous for more than two centuries: it maintains its high repute in the present Exhibition as

it has done in so many exhibitions of the past. The design we engrave is intended to suggest the treatment of a DINING-ROOM in the later

English style; the framing is ebonised, the arras a figured silk, and the furniture of light oak. The arms and monograms of owners are to



occupy panels in coved canopies, with paintings in those below. The sideboard has choice carvings in boxwood, and the sconces at the

sides, and other metal work, are of beaten brass, the chairs being covered with embossed and gilt morocco. The bevelled plate-glass is in a

richly-carved frame of pear-tree and ebony wood. The whole has been designed by Mr. B. J. TALBERT, and executed by Messrs. Gillow & Co.

quent to 1851. The application of artistic design to manufactures was so apparent in textile fabrics, especially in carpets and lace, porcelain and pottery, furniture, wall-papers, and in certain important branches of metal-work, that the foreign jurors and manufacturers who visited the Exhibition, especially the French, came to the conclusion that England had stepped out of the slough of ugliness, inappropriateness, and ignorance of common-sense principles in Art, which were exposed so plainly in 1851; and, better still, that she had begun to think for herself in many directions; no longer taking for granted that a design must be good because it had been executed in Paris, or at Lyons, or at Mulhouse, but seeking to find originality in a certain encouragement, tardy and hesitating as it was, of the ability which the recently-founded Schools of Art had been the means of developing. Not, perhaps, to the full extent

which had been hoped for, and might reasonably have been expected, but still of a character to give promise, under favourable circumstances, of better things in the future. Our French friends were not altogether mistaken when they took alarm, in 1862; for their supremacy in the production of designs for the English market being shaken, they acknowledged that our progress was unmistakable.

In the matter of prize awards the general precedent of 1851 was followed, with the important change that no Council medal was instituted. The recognitions were, therefore, limited to a prize medal of bronze and "honourable mention;" a praiseworthy attempt to get rid of the latter doubtful distinction being found impracticable, so long as the principle of rewards as recognitions of merit was retained at all.

MESSRS. HOWELL AND JAMES exhibit the works engraved on this page: the first is a TEA-SERVICE set, in silver, with foliated ornamentation



illustrating the special use to which each object is applied. The two branches, supported by sea-horses and surmounted by the river-god;



CLOCKS are of English *or-molu*: the one decorated with shells and coral



the other is of Oriental design. The designer of both is Mr. E. FINLEY.

In the Fine Art section no awards were made. Possibly numerous foreign artists were disappointed, but this wise decision saved an enormous amount of heart-burning and petty jealousy, and relieved the administration of the Exhibition from a most difficult and thankless task, which infallibility itself could not then get through with anything approaching to a satisfactory result.

We now come to the last great International effort, that of Paris in 1867. In this colossal undertaking it was impossible not to see the practical end of these gatherings on anything like the same scale which had hitherto prevailed; and it became evident that some important change must be made in the method of bringing together the products of various countries of the world, or such gatherings must be abandoned altogether.

The Champs de Mars, Paris, presented, in 1867, the spectacle of an exhibition so extensive and so varied, that it was impossible for any person to avoid being in some measure bewildered with the display; and amidst an affectation of precise and comprehensive classification and arrangement, it was a matter of the greatest possible difficulty to be sure that the whole of the illustrations of any one section of industry had been properly seen. Based upon a plan originated in England in anticipation of the Exhibition of 1862,* the promulgators of this arrangement hoped to carry out a scheme by which the objects in any one section of industry could be practically seen country by country for a final

* See the proposal of Mr. E. J. Payne, of Birmingham, and Mr. G. Maw, of Broseley.—*The Builder*, Feb. 16, 1861, pp. 106—108.

The two beautiful vases engraved on this page form part of the contributions of Mr. PERCIVAL DANIELL, of New Bond Street; they are the



manufacture of Coalport; that which contains a portrait after Greuze, is designed by M. PALMÈRE, the other by M. LUDOVICCI; the paintings

are, in both, the work of M. Palmère, the picture of Ondine being his own composition. The vases are of a very high order: they advance claims



to originality of treatment, and are veritable Art-works, as well as fine examples of ceramic art—in colour, gilding, manufacture, and finish.

comparison. Had the relative proportions of the various industries been fixed in geometric ratio, this might have been accomplished; but while the geometric quantities in the building were fixed, as regards the space for each section, the demands of the corresponding industries varied to such an extent that to carry out the idea in its integrity would have involved, and indeed in a measure did involve, a fearful overcrowding at one point, and comparatively empty space at another. The necessary compromise was fatal to the practical working of the arrangements, which in many instances collapsed, and produced an amount of confusion which those whose fate or duty it was, as juror or reporter, to endeavour to arrive at a satisfactory and, of course, systematic idea of the various contributions can alone conceive.

Of the wonderful variety of productions, the extent of the

arrangements, and the occasionally remarkable effects of those arrangements, it is impossible to speak without satisfaction mixed with regret. All things considered, the Paris Exhibition of 1867 was a climax in international gatherings, including, as it did, the Fine Arts in all its phases of painting and sculpture, together with a marvellous collection of antique objects, artistic, historical, and archæological, illustrative of the annals of labour, from the earliest times to the beginning of the present century.

The extent of the space available, not only in the great erection itself, but within the *enciente* of the Champs de Mars, tempted the promoters to carry out and practically exhaust, so far as they could, all available resources. The end of the effort was the conviction in the minds of all who gave themselves the trouble to study the bearings of these international gatherings, that, to render

We engrave on this page a PIANOFORTE CASE, in satinwood, manufactured by COLLMANN, of London. Mr. Collmann is better known as a

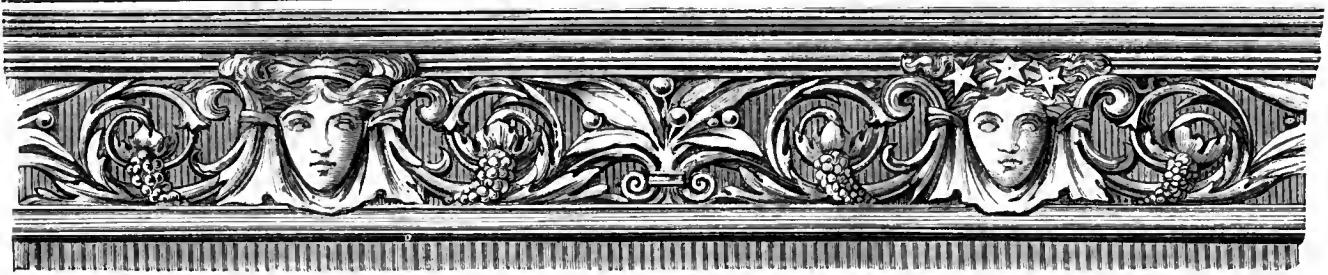

decorator than as a cabinet-maker. The British Museum, the Royal Academy, and other public and private buildings in the Metropolis and the

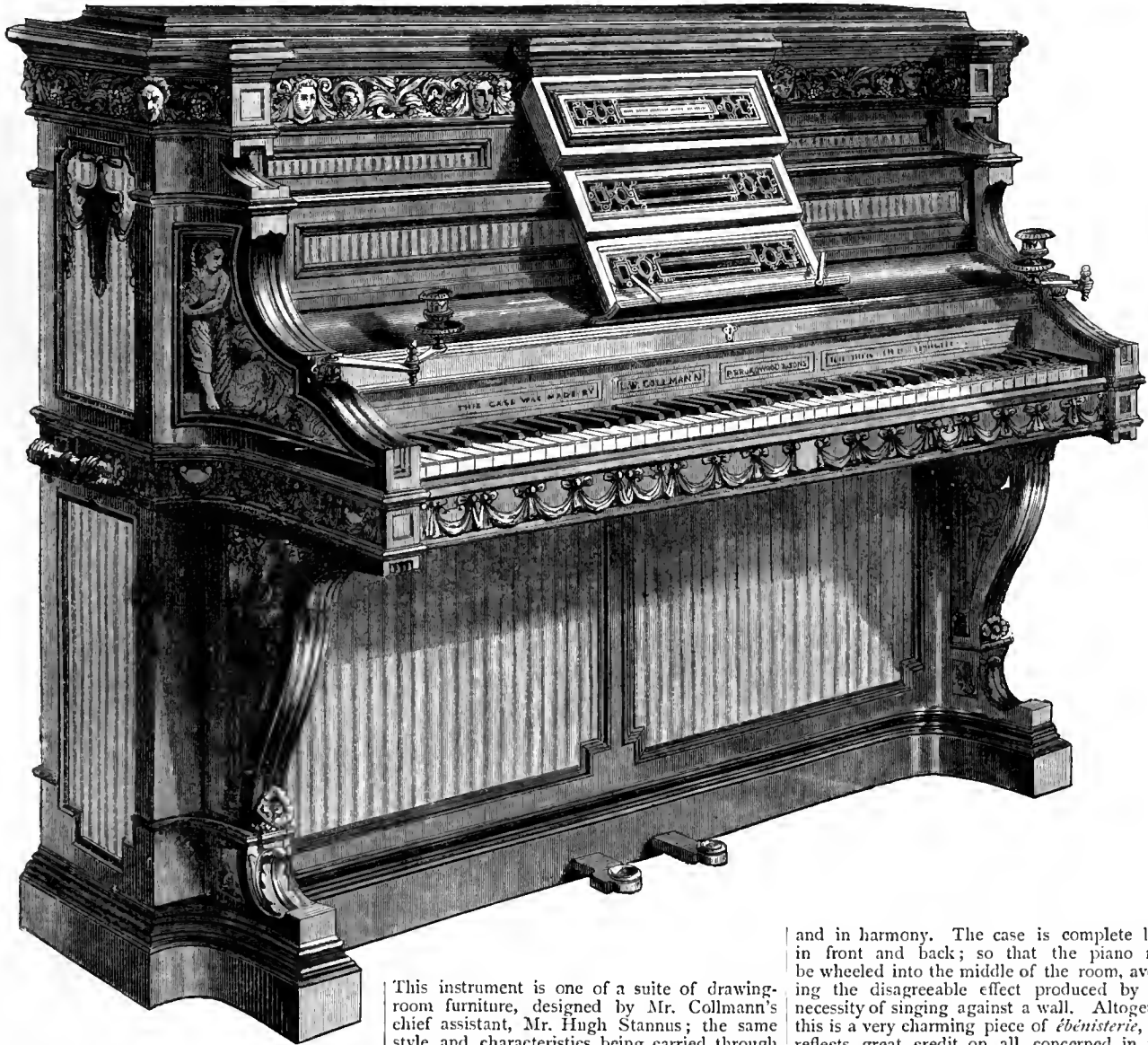

Provinces are evidences of his skill and taste.

This instrument is one of a suite of drawing-room furniture, designed by Mr. Collmann's chief assistant, Mr. Hugh Stannus; the same style and characteristics being carried through the other objects, thus making the effect whole

and in harmony. The case is complete both in front and back; so that the piano may be wheeled into the middle of the room, avoiding the disagreeable effect produced by the necessity of singing against a wall. Altogether this is a very charming piece of *ébénisterie*, and reflects great credit on all concerned in it—whether in the conception or the execution.

them practically useful in future, instead of merely sensationally striking, it would be necessary to sectionise them, so to speak, and taking up special industries, well and clearly defined, associate them with the most important inventions of the day. By adding to this a liberal exposition of everything appertaining to the Fine Arts, the Exhibition might be made a place of study and general instruction, rather than a mere show, in which amusement and a vacant admiration of objects too numerous to examine or understand, formed the main feature, in spite of all efforts to the contrary.

It is then to such a concentrated effort we have come in the present Exhibition of 1871, in which arrangements have been made for the proper and systematic display, from year to year, of selected Industries, in combination with such illustrations of Fine Arts as may serve to keep alive and encourage the love of beauty,

and the application of sound principles of design to the utilities of life.

This Exhibition, then, presents itself with a new and distinct feature. It is International without claiming to be Universal. Most fittingly, as already mentioned, the Royal Commissioners for the Exhibition of 1851 take the whole responsibility and practical direction of the undertaking. The permanent buildings, in connection with the Royal Horticultural Gardens and the Albert Hall of Arts and Sciences, have been erected by them, and the funds so happily placed at their disposal twenty years ago, are now, it is hoped, to be utilised in the promotion of Arts and Industry in that cosmopolitan spirit which characterised the efforts of their first president, the Prince Consort.

The first of a proposed series of annual Exhibitions, in each of

We give on this page an engraving from a large size, and illustrates the Sermon on the Mount. The work is drawn with great ability, and the colours are brilliant and effective. The artist is M. CASOLAIN. The manufacturers claim to have introduced into this production, and others of its class, "a new style of glass staining."



WINDOW of "stained" glass, executed and exhibited by Messrs. COX AND SON. It is of



Mount. The work is drawn with great ability, and the colours are brilliant and effective. The

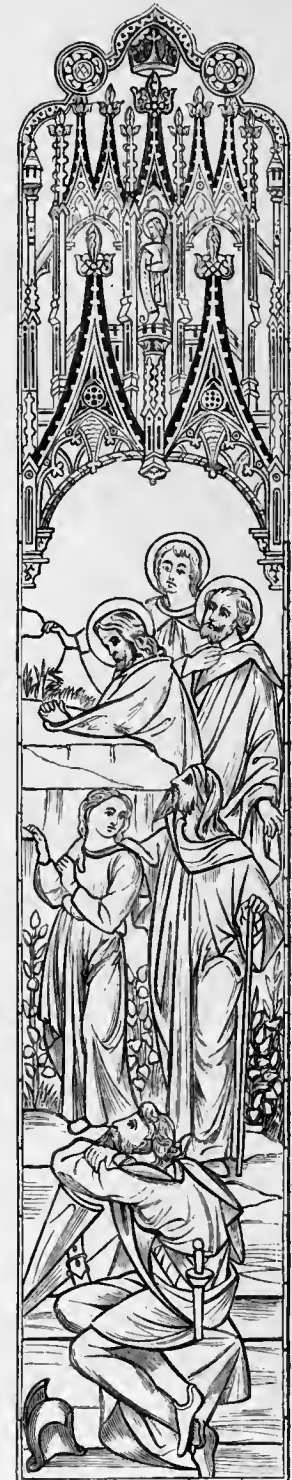

to have introduced into this production, and others of its class, "a new style of glass staining."

which two or three selected Industries can be fully illustrated by contributions from the various countries where they are carried on, the present effort may be regarded as altogether more or less experimental. Many new features are introduced, of which experience alone can prove the value. One very important innovation is the provision of fittings and glass-cases by the authorities; by this means securing a great uniformity of arrangement and economy of space, while at the same time relieving the exhibitor of a serious responsibility, and from incurring an outlay which frequently ran beyond anything the most liberal calculation could have anticipated.

The prize-system, so troublesome and unsatisfactory in previous Exhibitions, is abolished; and, instead of juries, committees of

selection are appointed to examine and decide upon the fitness of the objects sent in under systematic regulations for inspection prior to exhibition. Reporters are appointed for the various divisions; and their reports it is intended shall be printed and ready for issue to the public in about a month after the opening of the Exhibition. This, if carried out, will be a great boon alike to exhibitors and visitors. The more original and valuable objects will thus be pointed out by experts capable of distinguishing the more salient points of the objects which in their opinion are worthy of attention; and although the opinions expressed may not be always accepted, yet the very consideration and discussion of the merits or demerits of an object from an intelligent stand-point will have its value. Jury reports published long after the Exhibi-

This page is occupied by a few of the many works produced for the CERAMIC ART-UNION—a society which ought to be better known than it

duction in ceramic art. Some idea may be formed from our engravings of the character of these productions: they are very varied, con-

sisting of fancy busts, statuettes, vases, flower-holders, ink-stands, &c.: without exception they are all in pure taste, while some are of



is. After the plan of the Art-Union of London, it distributes prizes, and delivers to each subscriber (when subscribing) of one guinea a pro-



rare excellence, each being amply worth the guinea paid. The society is controlled by a committee, the leading members of which are Sir F. G. Moon, Dr. Doran, Mr. E. M. Ward,



R.A., and Mr. S. C. Hall. We have no space to describe the objects selected; but we may induce visits to the collection, which admits a choice of no fewer than fifty articles: they might grace the wealthiest drawing-room and boudoir, while brought within the reach of all Art-lovers.

tion reported upon had ceased to have existence were a species of record, useful undoubtedly as such, but having little value except to those who had well studied the speciality reported upon, and were, therefore, glad of something to remind them of what they had seen, correct their impressions, or astonish them by opinions which the presence of the objects themselves would infallibly contradict.

The present Exhibition is divided into four divisions—Fine Arts, Manufactures, Scientific Inventions and new Discoveries of all kinds, and Horticulture.

In the division of Fine Arts all works of Art are comprised, whether applied to works of utility or not; and thus we have within its range seven classes, which include paintings of all kinds in oil and water-colours, distemper, wax, or enamel; on glass,

porcelain, or mosaics, &c., In sculpture, every kind of carving, chasing, or modelling in any material or by any method, is comprised. Then follow engraving, lithography, and photography, as reproductive arts; and architectural designs, models, &c., may be said to complete the first group of the division of Fine Arts.

After these come carpets, tapestries, shawls, lace, and embroideries exhibited as specimens of artistic design and not as examples of manufacture; while in connection with these are designs and models of all kinds applicable to decorative manufactures. The second group of Fine Art—for as such it must be regarded—is completed by copies and reproductions of ancient pictures and wall-decorations, painted or mosaic, enamels, &c.,—the sculpture and metallic arts of the past being represented by casts in plaster, fictile ivories, and electrotypes.

The CABINET engraved on this page is one of the contributions of

eminent upholsterers and decorators of London. It is intended to show the application of high-class,

painted ornament, distributed throughout—coloured decoration being introduced on both the moulded



Messrs. COLLINSON AND LOCK, and plain surfaces. The artist is Mr. WOOLRIDGE, and the woodwork is designed by Mr. CALCUTT.

The ground thus covered is enormous, and in itself affords scope for an Exhibition of great value, instructive in a high degree alike to the artist, the archæologist, the antiquarian, and the Art-student; while it opens up to the manufacturer, and the designer for industrial purposes, a field of study which we trust may be largely and profitably cultivated during the period the Exhibition remains open.

The division of manufactures, machinery, and raw materials is, as already stated, limited to two special classes, with a third class devoted to industries engaged in the production of educational appliances. The two first named are pottery, and woollen and worsted fabrics.

In the class of pottery are comprised porcelain, parian, earthenware, stone-ware, &c.; terra-cotta, as used for garden decora-

tions and in building, with any new raw materials, novel applications of machinery, and processes employed.

With the woollen and worsted fabrics of all kinds, from the finest to the coarsest, is shown all new machinery brought into use in the manufacture of yarn or cloth, or the preparation of wool, together with examples of all new raw materials, or when prepared by any new process.

The class of educational works and appliances includes all the various contrivances for facilitating education and school-work generally—models of school-buildings and arrangement of schools, specimens of school-fittings, furniture, &c.; books, maps, globes, instruments of various kinds and appliances for physical training, games and toys. These, with specimens of school-work as illustrating results, make up, at the present time, a valuable contribu-

Messrs. TOMKINSON AND ADAM are extensive RUG manufacturers of Kidderminster. The article is a necessity in every British home; it

is, therefore, especially requisite that it be made refreshing to the eye and instructive to the mind, for it is never absent from an English fire-side.

The two examples we engrave may be accepted as evidence that taste and Art are the appliances of one of the largest establishments in the

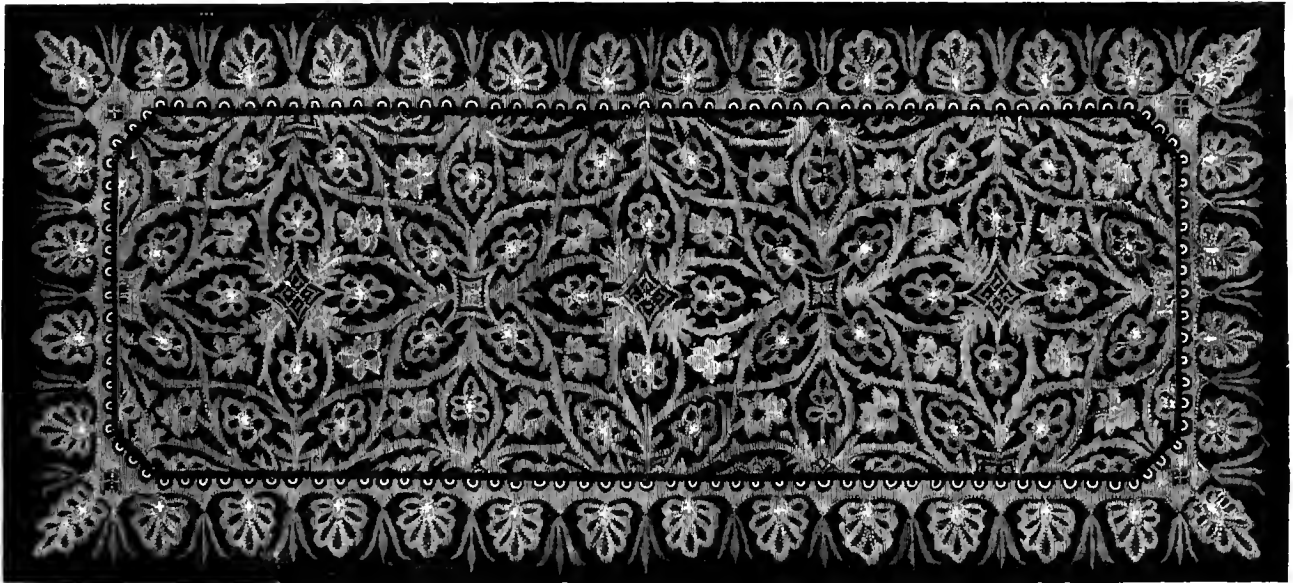

famous town from which they emanate; which, indeed, issues a large supply annually for exportation as well as home consumption, pro-

ducing such as are very low in price and such as are calculated only for the rich—the costly “Axminster.” Messrs. Tomkinson and Adam

have made liberal use of the fern; and perhaps there is no object in nature that can be resorted to with better assurance of satisfactory result.



The designers are on the staff of the firm, and many important improvements have been introduced into the process and produce by Mr.

Adam, who has had great experience as a manufacturer of this class of Art, having established much repute for a peculiar rug which is termed

the “Uhlán rug.” As this year is in a measure devoted to the production of “woollen goods,” we hope to engrave other examples of the class.

tion to the great problem of the day in England—How best to educate the people.

The division devoted to scientific inventions and new discoveries covers a wide field of operation, inasmuch as it embraces all kinds of invention in mechanics or discovery in science, which have been thought worthy of admission. There can be little doubt that such an opportunity as these Exhibitions will continue to afford, annually, for the ready promulgation of inventions practically applicable to the Industrial Arts, must prove of immense value to future inventors. The various points of a discovery or invention—its ingenuity, its superiority over existing methods, its novelty, its commercial, artistic and scientific value, and its economy—can be at once illustrated and determined, to the profit alike of the inventor and the general public.

The fourth division is that of horticulture, and from the association of the Royal Horticultural Society with the Royal Commission which directs the Exhibition, and the arrangement of the various buildings in connection with the Royal Horticultural Gardens, it may be reasonably expected that during the season various special shows of new and rare plants—of vegetables, fruits, and flowers,—will be held: these will largely enhance the attraction and special usefulness of the Exhibition in an industrial and scientific point of view, and form an immense attraction to a very large number of persons which otherwise might not be interested in the artistic and industrial portions of the Exhibition.

There is one point in the avowed purpose of the promoters of these proposed series of International Exhibitions, with which we have no hesitation in avowing a most decided sympathy, but which,

We supply another page of engravings

selecting a group of STATUETTES in "statory porcelain," and other objects that

show the variety of their productions, which, indeed, include every branch of



from the many excellent works, the manu-

ceramic art—from the cheapest plate that is called "common," to the rarest and costliest

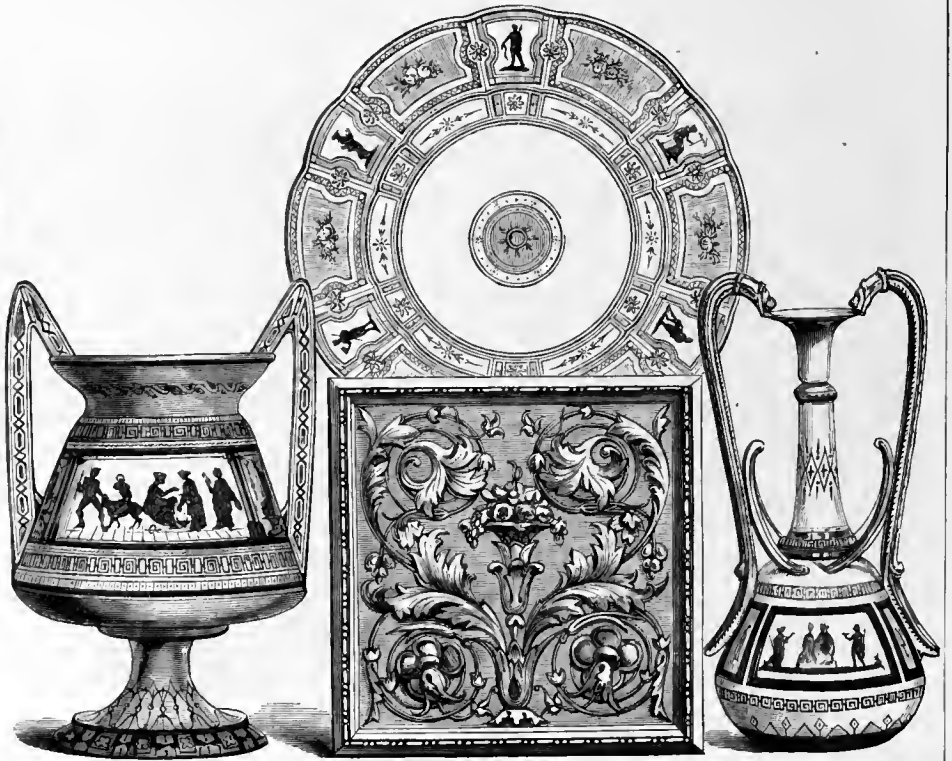

facture of Messrs. COPELAND AND SONS,

creations of the potter aided by the artist. Their works cannot fail to receive universal approval.

we trust, will be impartially carried out, and that is the effort to give the artist-workman his true position in connection with the works exhibited. We know that this is a sore and much-disputed point on the part of manufacturers, whose idea is that, having employed the artist-worker and paid him for his labour, the contract is at an end, and that the individuality of the producer or producers of an object of industrial Art should be completely sunk in that of the manufacturing firm which employs him.

Nothing has hitherto been more fatal, in our opinion, to the progress of the arts of design as applicable to industry than this practice of ignoring the skilled workman, and refusing, whatever may be his ability, to permit his name to be associated with the product of, perhaps, his own brain, certainly in many instances his own hand.

It is right and healthy and true for the artist in any department of the Arts to desire distinction. To many minds it is almost the only stimulant to exertion. It is but justice that distinction, when deserved, should follow the success achieved. Let the capitalist, the manufacturer, the director of industrial operations, have the credit due to his enterprise, forethought, and business tact; but all this is quite consistent with giving the artist-workman his true meed of honour for work done, inasmuch as all the capital, all the enterprise, all the forethought, and all the business tact which has built up successfully so many industries, would have been of no avail without the cunning hand of the worker, and the teeming brain of the designer. Why then damp the enthusiasm, or chill the efforts of these, by treating them as the mere helots of industry, to be used, worked like machinery, and thrown aside or ignored

V. CHRISTESEN, of Copenhagen, goldsmith and jeweller, has received



high honours in various exhibitions. We engraved several of his produc-

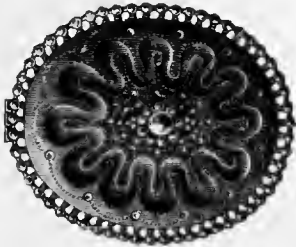

tions in 1367, and have now the pleasure to engrave others. The prin-



incipal piece is a CANDELABRUM in silver, admirably executed, and of

charming design—the work of a thorough artist. The page contains some of the many JEWELS for which M. Christesen



has obtained much and deserved repute; they are of pure gold, unornamented except by Art—depending for patronage on the graceful forms, which are often borrowed, whole or in part,

from the works of far-away ancestors—workers in precious metals of ancient Scan-



dinavia. It is to the credit of M. Christesen that he has reproduced these venerable an-



tique models to give delight to “wearers” in modern times; without being costly they

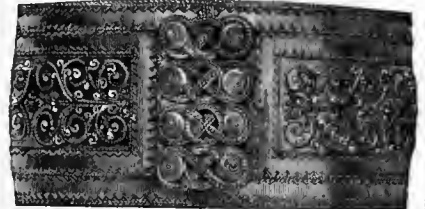

are of very great excellence—refreshments to the eye and mind. Their popularity has been established in all parts of the World.

when the object on which they have toiled, and over which they have thought, is once completed?

Nothing, in our opinion, has driven ingenious young students of our Schools of Art from the healthy and profitable pursuit of the practice of design in connection with the industry of the country, so much as the conviction, that by following such a pursuit, however successfully, they could never hope to distinguish themselves before their fellow-men, from the fact that whatever they did was overshadowed by the Colossus of trade-custom, which sank the artist-workman to the level of the day-labourer in everything except mere payment.

Urged by a personal ambition which every generous mind must appreciate if allied to ability, good conduct, and industry, many young and rising designers have been lost to the Art-

manufactures of the country, because they preferred the risk of gaining an individual reputation as a painter or as a sculptor to finding themselves buried alive under the absorbing reputation of the wealthy and enterprising manufacturer who employed them.

This matter requires looking to and correcting, if we are to make true progress in Industrial Art. It is the secret of much of the success on the Continent, that the artistic and social standing of the designer for manufactures is very much higher than it has ever yet been in this country, or is ever likely to be, unless the credit due to individual merit is more thoroughly recognised and appreciated.

In the International gatherings at Paris in 1855 and 1867, the French authorities enunciated the necessity for rewarding the

Messrs. J. W. and C. WARD, of Ellen Royde Mills, Halifax, are extensive manufacturers of "BROCADES," the material composed of silk and



wool, so extensively used by upholsterers for various purposes. These are substantial, refined, and of great excellence, yet not so costly as to

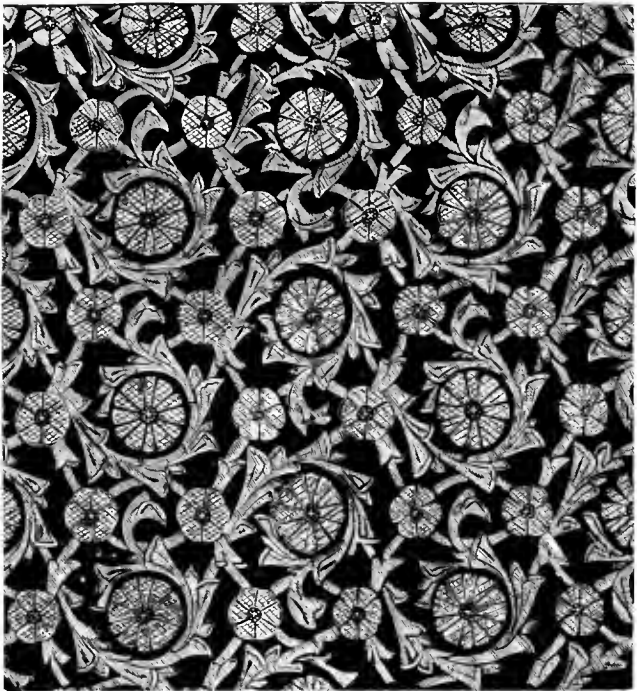

exclude them from most English homes. The material has a peculiarly soft and "cloth-like" feel, and hangs in full and graceful folds. The

skilled worker side by side with the manufacturer; and in the prize decrees of both Exhibitions, designers, Art-workmen, managers, foremen of works, &c., were recognised and rewarded. The difficulty frequently lay in getting the proper information as to who were best entitled to the recognition sought to be given. So far as England was concerned, it is quite true many of these rewards went to Frenchmen, especially in the Arts of design; but *all* did not go to foreign workmen, as had been asserted would be the case. In 1867, for instance, several English painters of porcelain and designers in other industries were recognised, while in the textile classes and in metallic industry, managers of works, &c., received suitable memorials of their scientific knowledge and its practical application to their speciality.

In some respects we regard this as a great redeeming feature of

designs, worked in wool and silk, are varied in "colourings," the ground being generally black; but the darks are in all cases subdued and



harmonised by the lights. We give some idea of these designs; they are furnished to Messrs. J. W. and C. Ward, of Halifax, by Dr. DRESSER,



whose designs have been of great practical value to many classes and orders of British manufacturers, especially to designers of floral ornament.

any prize-system, but we equally regard a prize-system which does not seek out and reward the actual producers of important works, as deficient in the very first element of a truly national reward, and therefore to be avoided rather than encouraged. On the whole, it is a subject for congratulation, that on this occasion no award of prizes will be made. The principle is by far the more healthy one, and we trust that its success will be fully assured in all future Exhibitions of the same kind. Public opinion has gone "hand in hand" with that of the Commissioners. To the exhibitors who really merit distinction honour will be awarded.

We shall now proceed to consider the various industries, and to show in what way the exhibition illustrates the present position of each in relation to the past, giving priority to the most complete of two great industrial classes—

The works, engravings from which adorn this page, are contributions of the ROYAL PORCELAIN MANUFACTORY OF BERLIN, sent by the accomplished director, Herr G. MÖLLER. They are of great merit as productions of Art: especially the principal piece we engrave—a JARDINIÈRE—is composed and modelled by Herr JULIUS MANTEL, chief of the plastic department of the Factory.



page, are contributions of the ROYAL PORCELAIN MANUFACTORY OF BERLIN, sent by the accomplished director, Herr G. MÖLLER.



are of great merit as productions of Art: especially the principal piece we engrave—a JARDINIÈRE—is composed and modelled by Herr JULIUS MANTEL, chief of the plastic department of the Factory.



LAIN MANUFACTORY OF BERLIN, sent by the accomplished director, Herr G. MÖLLER.



posed and modelled by Herr JULIUS MANTEL, chief of the plastic department of the Factory.

PORCELAIN, POTTERY, ETC.

It was not until about the beginning of the present century that much attention was paid to what may be called historic pottery. The collectors of Etruscan vases, &c., during the latter half of the eighteenth century were not numerous, and confined their attention to those types of classic Art which to them embodied all that was worth preserving of the fictile productions of the past. Still this was a decided beginning, and it is now patent to all how much influence the taste of those collectors, and, above all, the examples which they had brought together, had upon the efforts of Josiah Wedgwood in his early career. Happily for the future of Ceramic Art in England, Wedgwood was no mean imitator. He sought

rather to catch the spirit of the past, and adapt it, in new forms and methods, by new materials and mechanical appliances, to the wants of his own time. He succeeded so well that, as time advanced, all he did became as much an object of interest as the works he sought to rival, not by mere reproduction, but by a revival of the principles on which they had been originally produced.

The stagnation of everything like true Art-feeling or power, as applied to pottery and porcelain, which prevailed in England so late as 1840, seems difficult to realise, even to those who from personal observation can bear witness to the fact. One seems to doubt the possibility of the utter neglect of all the Art-qualities in design, except in a few exceptional instances of flower-painting, which prevailed in the Staffordshire potteries in 1837, for instance,

Messrs. SIMPSON AND SONS hold foremost rank as decorators: there are many departments of a building to which they have applied



taste and skill, and matured Art-knowledge,—to wall-papers more especially. The several objects we engrave on this page are “ART-TILES:”



i.e., paintings on earthenware or porcelain burnt in, and used for various purposes—panels, friezes, pilasters, chimney-pieces, as wall-linings

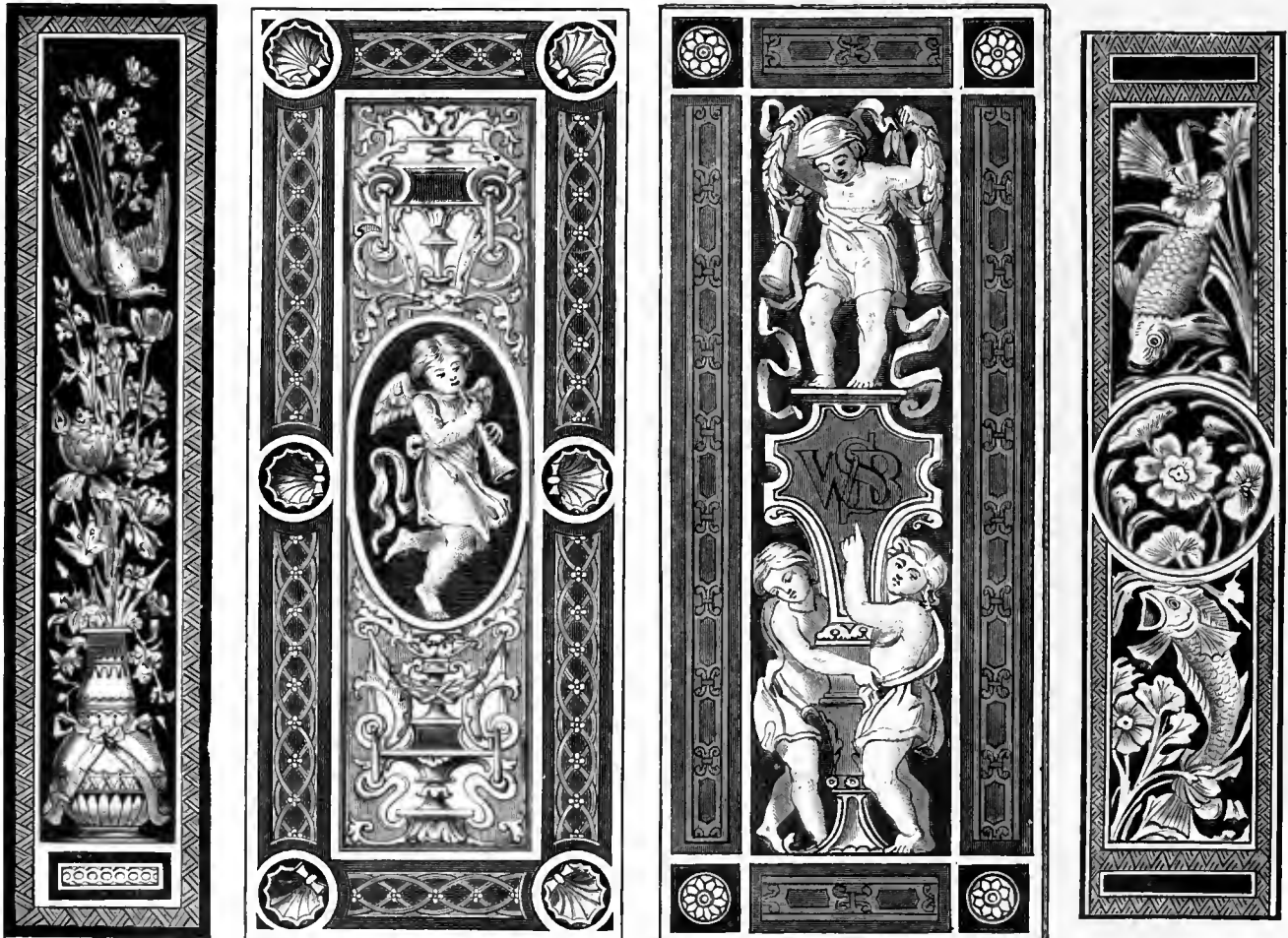

very often, and sometimes as reredoses in ecclesiastical structures. Those we give will furnish evidence that Messrs. Simpson avail themselves of the talents of excellent artists, not only in design but in execution. Their productions are drawn and painted with considerable ability.

when a personal visit opened up the wide range and capabilities of a vast industry to one's perceptions, only to shock them by the utter worthlessness and ugliness which prevailed. To think that in this district Josiah Wedgwood had lived, laboured, and died, leaving a heritage of beauty and scientific knowledge to all around him; and yet to find such an utter wilderness of vulgarity, outrageous conceits, and a defiance of every sound principle of design pervading a manufacture, in which the beauty of the materials alone might be supposed to offer some security against the ugliness which had usurped the place of beauty and common-sense, was astounding.

So much for casting our memory backward to what *was*, in order to make the very legitimate comparison with what *is*, at this hour, by the evidence of this International Exhibition, the state of the Arts as applied to porcelain and pottery in England.

Nor do the public opportunities which have been afforded from 1851 to the present time, of marking the gradual development of improvement, lessen in any degree the interest it excites. On the contrary, to those who have followed it step by step, almost year by year since the date we have quoted, the value of the change is enhanced by a thorough perception of it; inasmuch as this change is an earnest of greater improvements to come, as sound principles are better understood and more loyally acted upon, and an advanced state of public taste demands a more strict obedience to the law of use, rather than the whims and caprices of fashion or the foregone conclusions of *dilettanti* collectors, whose notions are based upon results obtained under totally different circumstances and by totally different means to those which exist in our day.

So far our observations apply specially to England, as the

Messrs. WIRTH BROTHERS, of Paris and London, are eminent manufacturers of furniture in carved wood: their

productions are, generally, fine works of Art, of a high order. First-class medals have been awarded them for

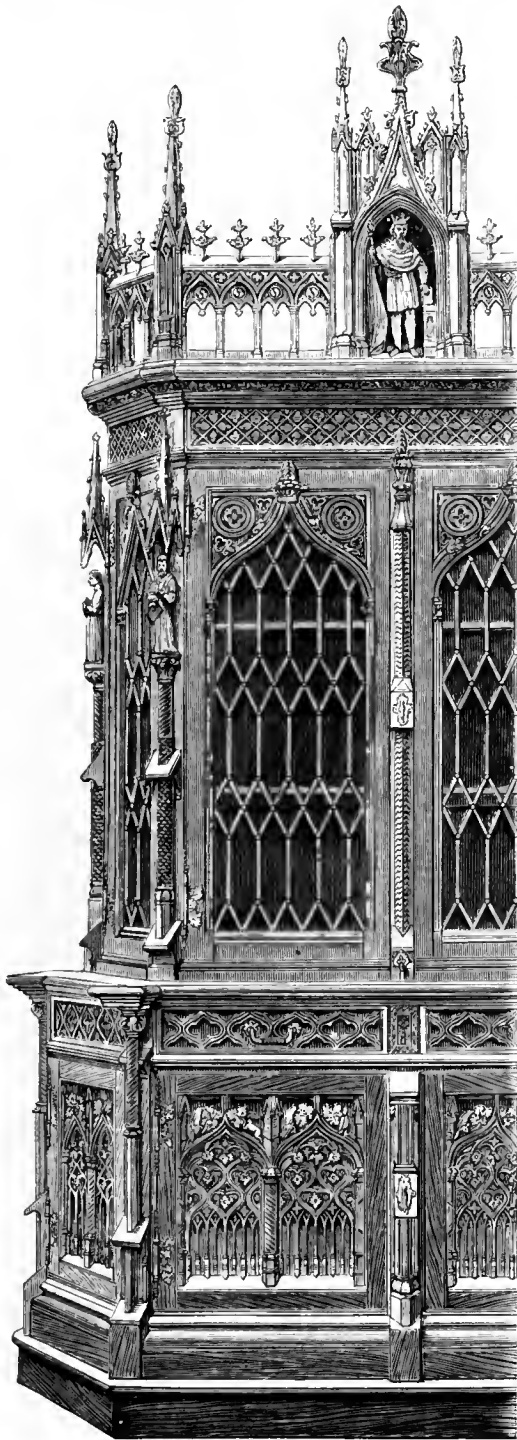

productions are, generally, fine works of Art, of a high order. First-class medals have been awarded them for

bition of 1871 fully sustain their fame. We engrave one of their CABINETS and part of another. They are the productions of very skilful workmen as well as of able artists.

principal exponent of Ceramic Art in this Exhibition. The foreign contributions are numerous as a whole, and partly representative of the countries which produce pottery and porcelain. Specimens more or less characteristic are to be found in the exhibition galleries, from Japan, China, India, Russia, Sweden, Denmark, Holland, Belgium, Prussia, Hungary, Spain, Portugal, Italy, Egypt, and Western Africa (Moorish), but very nearly two-thirds of the whole display is contributed by Great Britain and Ireland. The contributions from France are exhibited in the special building erected by the French for their collections as a whole.

Notwithstanding considerable shortcomings, as compared with some previous exhibitions, in the specimens from France, Austria, Italy, the German States generally, the collection is a very fine one, and specially interesting from the fact that it may be

considered as representative rather of the best character of examples in regular demand, than of those exceptional *tours de force*, which are rather calculated to astonish and mislead than to gratify and instruct. Let us hope that the day has gone by when the folly of expending large sums of money, misdirected skill and ability, in the production of an altogether useless object, and one which being once produced, the manufacturer would never think of producing again; instead of wisely distributing the same expenditure of means, alike of money and skill, upon a series of less ambitious objects, useful in themselves, valuable as illustrations of current work, and consequently likely to require repetition in one form or other, to the increase of real reputation, and the solid profit of the producer.

The waste of capital, skill, and energy on the production of large

Mr. PERCIVAL DANIELL exhibits, among other very admirable VASES, those we engrave—the Art-manufacture of Coalport. They are adap-

tations from Sevres models, with original paintings—the birds by RANDALL, the cattle by HARTSHORN, the fruit and flowers by COOK. We

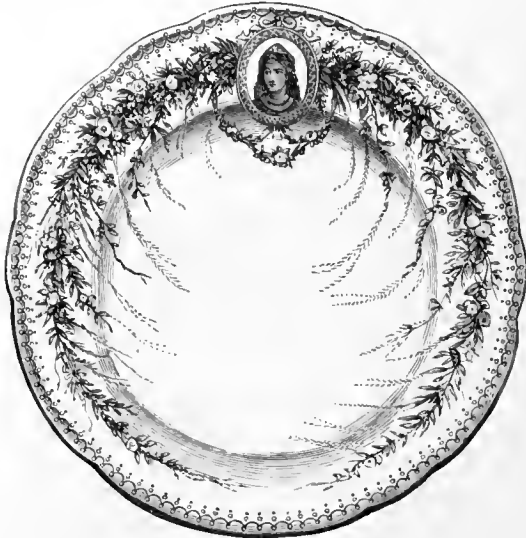

engrave also two of the PLATES of a dessert-screen of the heroines of Shakspeare, set in festoons is by Mr. DANIELL and Mr. CHARLES J.



vice; they are graceful and beautiful, and also novel. Each plate contains a fancy-portrait of

of flowers. They are very refined examples of Art applied to manufacture. "The general design

ROWE," and the portraits are painted by M. PALMÈRE. Each bears an entirely distinct design.

and exceptional objects for previous Exhibitions, simply because they were exceptional or difficult, or not likely to be again attempted, has been a great evil. The present Exhibition is comparatively free from such examples of folly and waste.

The arrangement of the collection, as a whole, in the ground-floor of the eastern galleries of the special buildings erected, in connection with the Royal Horticultural Gardens and the Albert Hall, for the purposes of the proposed annual gatherings, is very satisfactory so far as its inspection by visitors is concerned. It is well lighted, and placed in glass-cases of suitable dimensions, constructed upon the model of those in use in the South Kensington Museum. So far experience has been used as a guide. As regards the classification, however, if we understand correctly what has been attempted, it is a failure; and the result is most

satisfactory where the theoretical division of the various objects into technical groups breaks down the most. The object appears to have been primarily to destroy the individuality of manufacturers, and, to a certain extent, of countries. Now the most satisfactory and perfect portions of the arrangements are where the individuality of the producer and the country has been best preserved by the very necessity of the grouping not allowing of the theoretically minute division. In a retailer's shop or warehouse, there is no doubt a great advantage, in a business and economic sense, in bringing one class of goods together, irrespective of the maker, such as plates and dishes, tea and breakfast services, decorative vases, Parian statuettes, &c., but we must take leave to doubt the application of this principle to an Exhibition of this kind, and prefer, for the purposes of this essay at all events,

Messrs. CLABBURN, SONS, AND CRISP, of Norwich, are of established renown as manufac-

turers of Paramattas and various textile fabrics, for which that city has long been famous;

while their shawls have been known everywhere, obtaining medals at the several Exhibi-

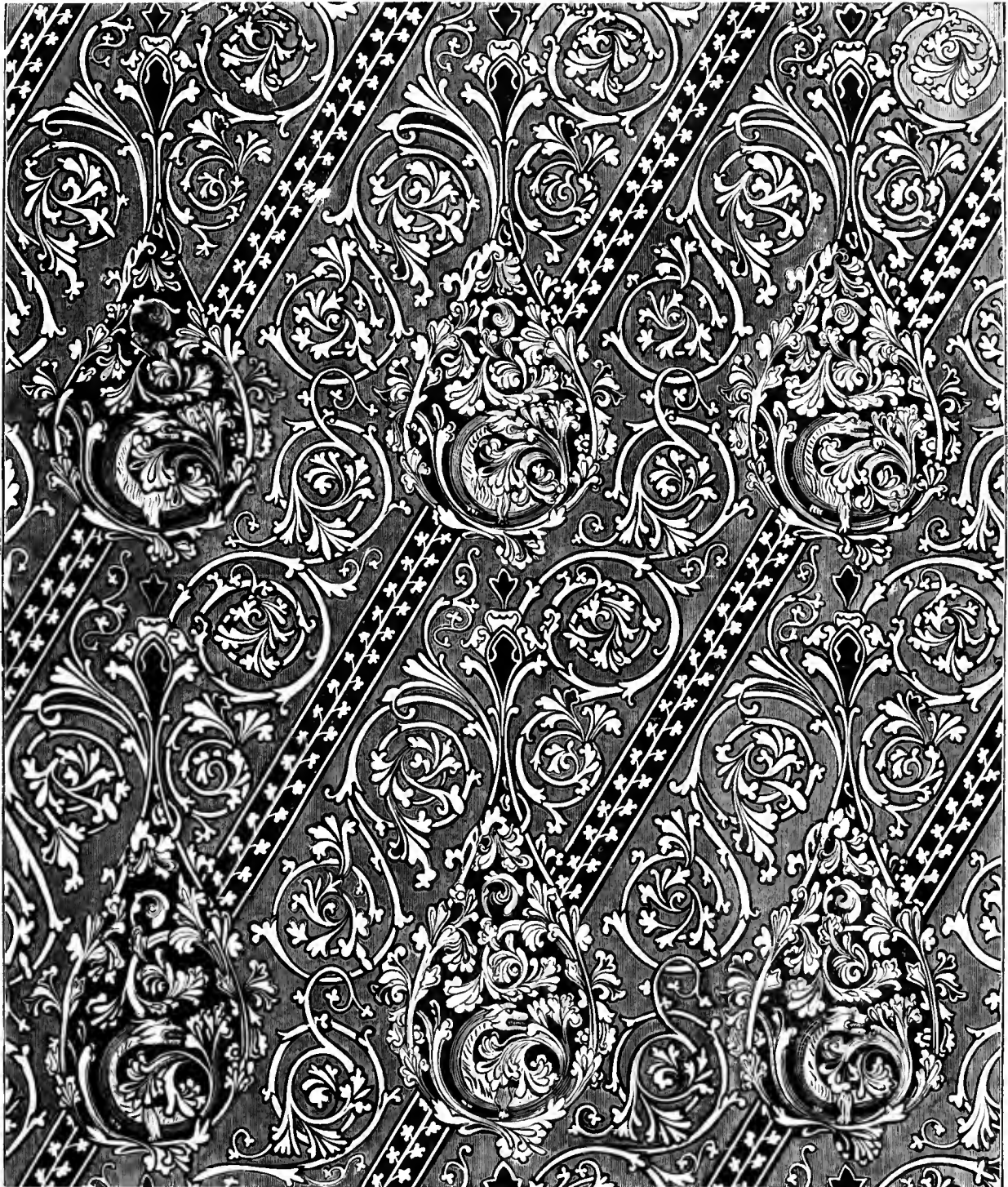

tions. The article we engrave, however, is an example of their TAPESTRIES (of worsted and

silk), in the production of which they aim to attain, and have attained, the highest excellence.

This design is by Mr. J. FUNNELL, the artist who has directed the Art of the establishment.

to discuss the products of each exhibitor under a grouping more consistent with the recognition of the individual producer, and the distinctive characteristics of each country. Commencing with British porcelain and pottery, it is certainly not too much to say that in no previous Exhibition have the various ceramic productions of England been so thoroughly or so successfully represented. From the highest examples of decorative porcelain, down to the most useful stoneware and earthenware, we have a series of objects almost without a break in the chain of production, which prove unmistakably how thoroughly both Art and Science have been combined to produce an industrial result that reflects honour on all concerned. With few exceptions the work, too, is as legitimately useful in its aims as the skill employed has been successful in results.

By right of historic precedence the varied contributions of Messrs. Josiah Wedgwood and Sons claim our first attention, since the evenly-balanced excellence of the principal English exhibitors gives us no choice except that of seniority.

There can be no doubt that the efforts of the present representatives of this firm to restore its traditional reputation as producers of the now famous Jasper-ware have been attended with marked success, and the evidence before the public, as concentrated in this Exhibition, must convince the most sceptical that the old skill has been revived to an extent which could not have been anticipated a few years ago. Here is a complete collection of the light blue and white Jasper-ware in all its delicacy and beauty, together with examples of sage and white, sage, citron, and white, in charming combination. The vases after the old

Messrs. W. P. and C. PHILLIPS AND PEARCE exhibit, among other very beautiful examples of ceramic art, specially produced for them, and from the designs of Mr. Pearce, a charming CHANDELIER of porcelain, of which this engraving affords a satisfactory idea, except that

here the colours are absent. These are skilfully and harmoniously blended, so as to refresh the eye. It is made for this firm at the Worcester Works, and is one of their best considered and executed productions—very perfect in all its parts. It is not easy to connect lightness in

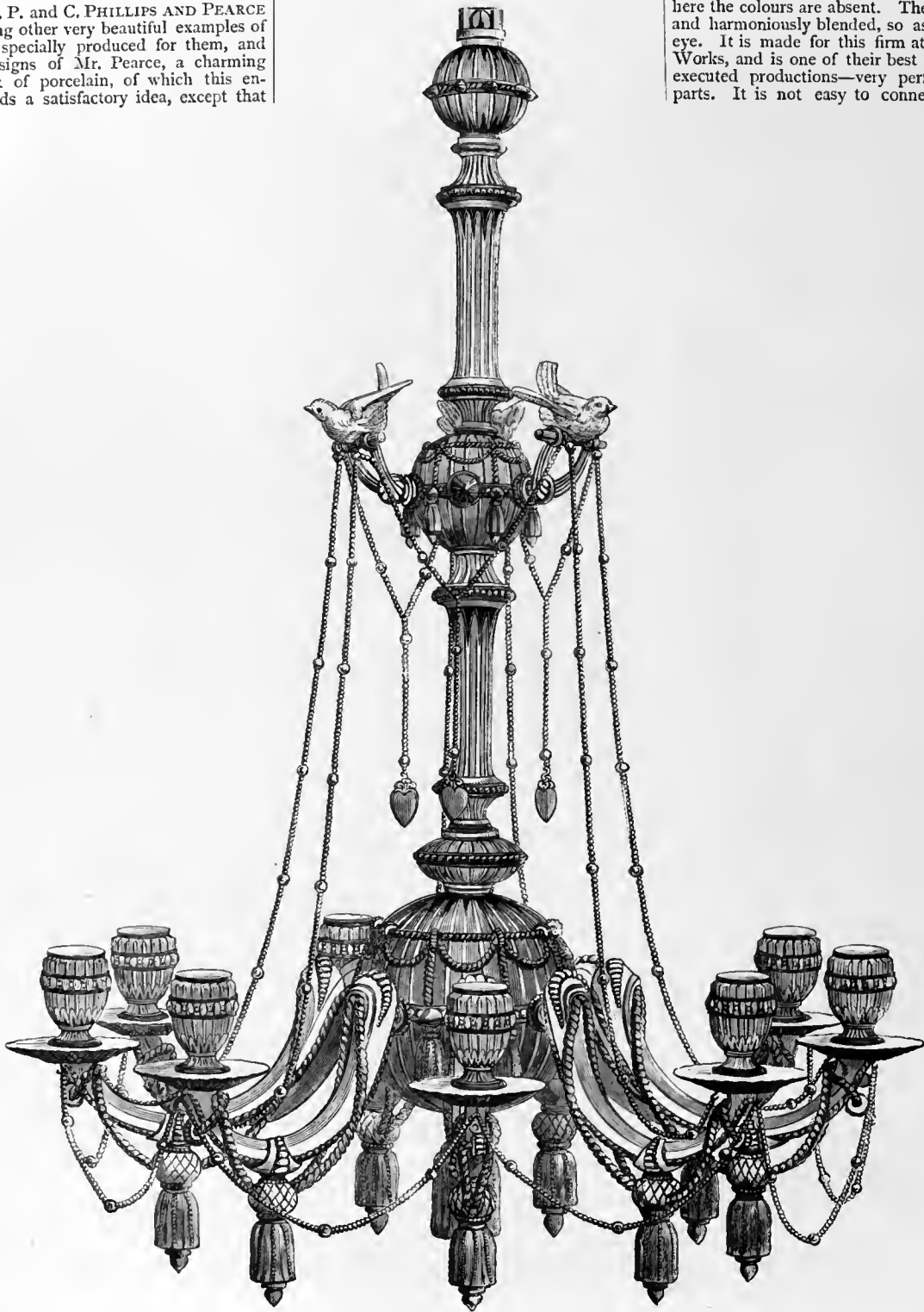

form and ornamentation with porcelain designed | to hang in the centre of a room; in this case, | however, a thorough triumph has been achieved.

favourite types are admirable in form, the decorations and classical subjects in relief being executed with a sharpness and artistic precision which invites, as it will bear, the closest scrutiny. In short, as revivals, both the producers and those who admire this special phase of Ceramic Art are to be congratulated; while in an educational sense the gain is very great, as the distribution of these objects,—so free from the meretricious colour, gilding, and the meaningless conceits which formerly characterised a considerable portion of modern productions in pottery and porcelain, cannot fail to have an elevating effect upon public taste.

The specimens in the black basalt body are also very good. We certainly miss the true bronze-black tone of some of the old basalt ware, so suggestive of the tone of a fine old Italian bronze—an effect which, to our mind, gave great value to busts and

roundels in high relief. This tone is reproduced in some measure in two of the roundels exhibited; these have much less of the greyish tone which prevails even in the best of the recent examples of the basalt. An excellent copy of the Portland vase in this ware, with white figures, is quite a success. The semi-transparent portions of the draperies, foliage, and other details, are evidence of the mastery over the material, which has resulted from the recent efforts in this direction.

Next to these reproductions, as works of Art, must be classed an important series of vases, comports, plateaux, &c., embellished with paintings by the free pencil of M. Lessore. The special power of this accomplished painter is admirably illustrated in the series now exhibited. From the largest and most important plaques and plateaux, placed in the British Fine Art Galleries as works of Art,

The FOUNDRY AT COALBROOKDALE has long been



tions since 1851 inclusive. By employing artists of ability, and artisans of skill, experience, and knowledge, it has advanced and maintained its

original character, admirably modelled by Mr. E. BENNETT, sculptor; and part of a GATE, executed for the Earl of Craven, to



claims to the high position it occupies. We engrave two HAT and UMBRELLA HOLDERS, produced in great variety; a LECTERN of

be erected at his mansion, Coombe Abbey, Warwickshire. It is in this class of Art that the supremacy of Coalbrookdale is

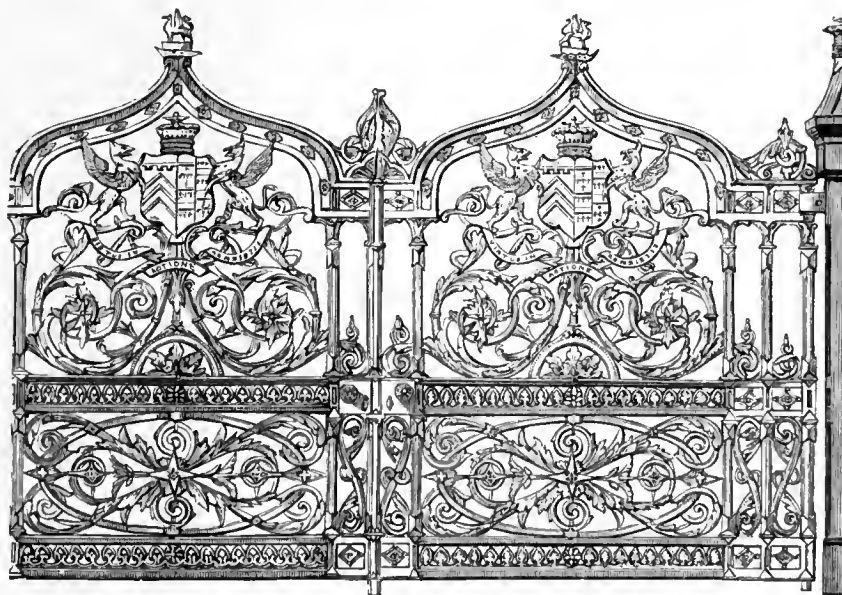

famous for issues of Art-objects in cast-iron, the establishment having received honours at all Exhibi-

chiefly shown. The gates exhibited in 1851, and presented by the Company to the Nation, have

been long admired: they have recently been placed where they can be seen to advantage.

down to the smallest tray, a few inches in circumference, of which examples are also to be found arranged as they deserve to be with Fine Art proper, there is the same successful application of sound artistic and technical knowledge, and the same happy choice of subject. Slight and simply suggestive as some of these works are, destitute of the chromatic effects which are so usually associated with painting on porcelain or pottery, yet they are all that the educated eye can wish for, since they are complete in the best sense of completeness; the artist himself has succeeded in all he aimed at—his aims being higher in thought than in the mere material effects of colour and light and shadow. In many respects the slight and comparatively sketchy examples are preferable, artistically, and certainly as ceramic decorations, to the more highly elaborated works.

We could have wished that Messrs. Wedgwood's specimens of majolica partook more of the quality of colour, as shown in those paintings of Lessore. Generally well designed, and in forms admirably adapted for use, the modelling being also good, the colour is, for the most part, too much localised to be satisfactory in point of harmony. A few jugs and a tobacco-jar, together with a centre-piece by Carrier, having Bacchante and Fauns as supporters, are exceptions to this rule. The tobacco-jar is an appropriate memorial to Sir Walter Raleigh, and is a gem in its colouring. One or two of the jugs, decorated in relief, with the details of the flowering reed, are also exceptionally successful in general tone, and the combination of tints.

In the course of this essay we shall have more to say upon the important question—the treatment of majolica in broken and

From the numerous and

factured by Messrs. MINTON, HOLLINS

are of admirable "make" for all of the

for fire-places, hearths, stoves—for a



beautiful collection of ART-TILES exhibited and manu-



AND Co., of Stoke-npon-Trent, we

many purposes to which they are ap-

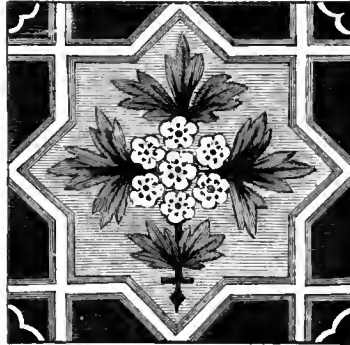

have selected the several that grace this

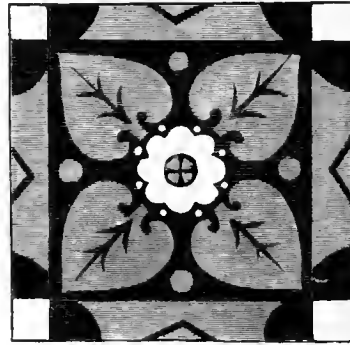

plied—not only in halls, in churches,

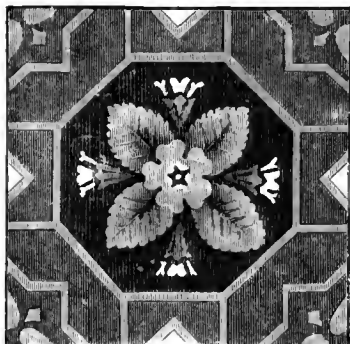

page. They are of great beauty, for



and in large and long passages, but as

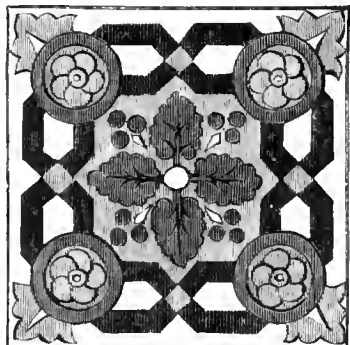

the most part original in design, the productions of accomplished artists, and

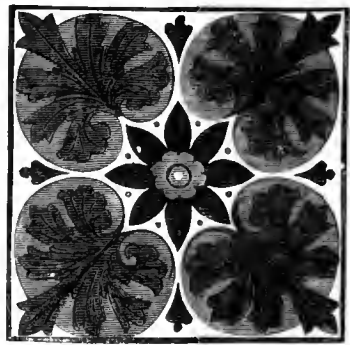

decorations of dining-rooms, drawing-rooms, and all "home apartments;"



hundred uses, indeed, where elegance and comfort are objects of study.

unbroken tints, when discussing the results produced by other exhibitors.

In addition to the examples painted by M. Lessore, it is necessary to state that a series of plaques in Jasper-ware, blue and white and sage and white, are placed in the Fine Art Gallery as illustrations of the application of high-class sculpture and the purposes of industry. Here also is placed the Wedgwood "centre-piece," or rather pieces (which we shall describe when we engrave it), exhibited by Messrs. Phillips and Pearce, of New Bond Street, the design of Mr. Pearce, whose skill and taste in this direction are so well known to all who interest themselves in industrial Art, especially in its connection with the manufacture of high class glass. The effect is charming, as the light blue and white of the Wedgwood-ware details contrasts so agreeably with the flowers

and mirrors of the plateaux. As regards the execution, Messrs. Wedgwood have left nothing to be desired. The candelabra alone are notable examples of skill in treating such adjuncts to any similar design.

On the whole, it is a matter for sincere congratulation to see a house like that of Messrs. Josiah Wedgwood and Sons steadily reviving all the traditional power of the last century, not merely by reproductions, but in well-directed efforts in new fields of design. This is evidenced in the Lessore paintings and some of the specimens of majolica, as also in some very pretty objects, such as trays, basins, spill-holders, &c.; in which Oriental colouring is arrived at in a rather novel form. As tentative examples they are worthy of notice: those based on Siamese design being quaint and ingenious in arrangement and treatment.

Mr. WILLIAM WALKER is a famous cabinet manufacturer of London "city:" his contributions to the Exhibition are of an excellent order,



manifesting good taste and Art-know-

ledge in design, and great skill in workmanship. The production engraved on this page—a drawing-room CABINET of satin-wood—is designed, and also painted, by Mr. JOHN TURNER, the artist of the firm. The form is graceful, with some claim to originality,

and the parts are well put together.

Having adopted the principle of seniority in the consideration of the various British contributions, the Royal Worcester Porcelain Manufactory next claims attention.

The position taken by the productions of these Works in 1862, and the progress effected under the direction of the able manager, Mr. R. W. Binns, F.S.A., during the previous ten years, was such as to justify the friends of British Industrial Art in expecting a complete illustration of the capabilities of the Royal Worcester Porcelain Manufactory in the International Exhibition at Paris in 1867. Our surprise and regret were, therefore, so much the greater when we found that, for all practical purposes, so little had been done by this concern to sustain the honour of the "Faithful City" and English ceramic art on that occasion. In the present Exhibition, however, all this is more than compensated for by an effort which

proves how thoroughly the reputation of Worcester is sustained by the productions of to-day, while the individuality of those productions is as well preserved and as marked as ever they were, to say the least. It is simply a change and an advance in style and true Art-treatment.

Paintings on porcelain, in the manner of the famous works in enamel of the Limoges artists of the fifteenth century, have been a speciality of Worcester for many years. Those exhibited on this occasion are the best works of the artist, the late Mr. Thomas Bott, to whose ability their success is to be attributed. His death is a loss that will not be easily replaced, since he brought large experience and a well-trained eye and hand to bear upon work which required all these in combination to ensure satisfactory results.

Mr. JAMES PULHAM, of Broxbourne, an eminent and very extensive manufacturer of WORKS IN TERRA-COTTA, exhibits in the Arcade and Horticultural Gardens a great variety of Vases, Fountains, and other objects for the



garden and conservatory. But not these only; his productions include many for balustrades, mouldings, &c. He has devoted much time, thought, and labour, to the introduction of novelties in his (guaranteed to bear any amount of frost), have long been under his superintend-



the architect and the builder—window-dressings, columns, angle-groins, piers, Art; and several of the pleasure-grounds, conservatories, ferneries, fish-ponds, and other attractions of palatial houses ence; his experience and intelligence having been of great value to their owners.

Selecting the admirable series of designs by Maclise, illustrative of the story of the Norman Conquest, several works of great beauty have been produced, in which the peculiar treatment required in the method of painting white enamel on a dark blue ground, has been perfectly wedded, so to speak, to the noble designs of the able Academician, of whose powers England will be prouder by-and-by, in spite of apparent negligence now.

A large pair of vases, the form of which is admirably adapted to the purpose, are embellished with four subjects from the Norman Conquest. On the side of one vase is depicted Harold's oath of fidelity to William over the concealed relics of the saints; on the other side, the departure of William in his galley from Normandy. On one side of the other the subject selected is the coronation of Harold as King of England, with the Battle of

Hastings as the end of the story. In the upper part of each vase are medallions—William and Matilda, Harold and Edith.

Much reduced as these works are from the original designs, and even from the engravings published by the Art-Union of London, the spirit and expression are admirably preserved throughout. The touch of the artist is clear and intelligent, showing a full appreciation of the theme, and the most perfect mastery over method and material.

A smaller vase and plateau, with illustrations from the same series of designs, are very admirable; indeed, this may be said of all the works, in the manner in which the decorative effects have been confined to the purely white enamel in relief on the dark blue ground, with a judicious introduction of gold, dead and burnished, in the adjuncts and smaller details.

Mr. JOHN W. SINGER, of Frome, a well-known and highly esteemed manufacturer in brass and wrought-iron, principally for

conveying no idea of the grace and beauty it derives from colours in enamel.

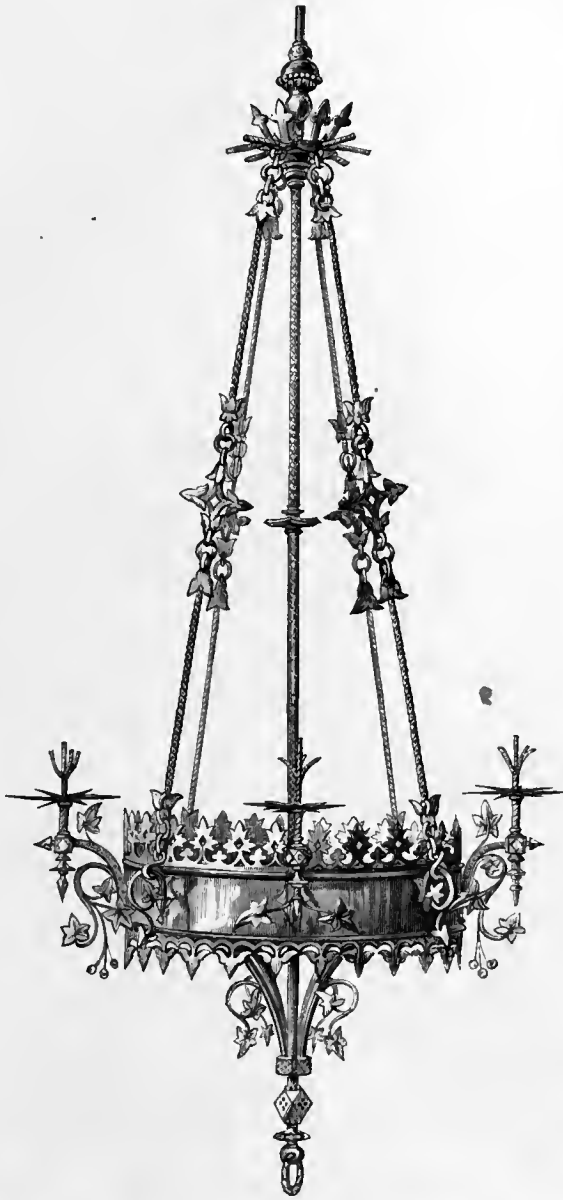

church uses, enables us to engrave some of his always admirable

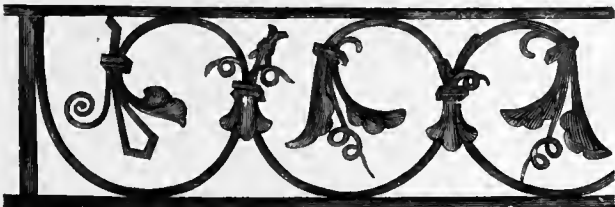

works: the principal object is a PULPIT, of mingled brass and iron, designed, as well as made, by Mr. Singer. We give but the form,



The PULPIT CORONA is also a design from the same master-hand. A SCREEN, of which we engrave two portions—the scroll



and a long border—is admirably wrought. It is a great thing to find in a provincial town an artist-manufacturer of ability such as Mr. John W. Singer.

The introduction, however, of coloured works, as in the instance of the vases on which the subjects of the Sibyls are painted, we do not regard as so successful in result. The work is admirably done, but the effect is *bizarre* rather than tasteful and harmonious.

We may remark here that the vase presented by the ladies of Worcestershire to H.R.H. the Princess of Wales, on the occasion of her marriage in 1863, executed in the purer style of the first-mentioned examples—the principal decoration being a charming version of Thorwaldsen's 'Morning'—is exhibited in the Fine Arts Gallery, as a contribution from the Prince of Wales. So far this may be regarded as complimentary to the Royal Worcestershire Works, but, viewed from a critical stand-point, it is not equal as a work of Art to the vase and plateau quoted above.

In the ordinary productions of high-class porcelain the Worcester specimens are of the first order: well-considered and elegant forms, embellished with appropriate and admirably-executed decorations. Some of the flower-vases are very vigorously painted, while one or two *déjeuner* services, and some breakfast and tea cups, are characterised by extreme delicacy and finish. One square tray, decorated with a branch of heather and a wreath of roses, is a gem in execution and finish.

The varied examples of ivory-ware, celadon and ivory, and also the tinted and lusted examples, all show progress of a novel kind. In statuettes Worcester keeps its ground, so far as design and modelling are concerned; but we are not enamoured of the polychromatic experiments. Some of the more vigorously-painted statuettes are good, alike in treatment and effect. Others look too

L

Mr. GEORGE JONES, of Stoke-upon-



Trent, contributes largely to the Exhibition.



His works are of the class known as "Ma-

jolica," a style that has been very "fashionable" of late years. His "exhibits" are, generally, of a "domestic" character, often very

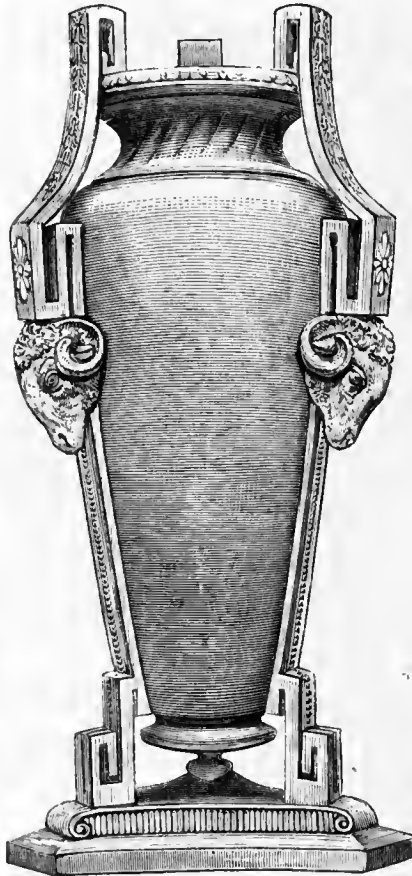

graceful, and frequently good, examples of Art. Many of them are trifles for the boudoir or



the drawing-room table—pretty and pleasant FLOWER-HOLDERS, and so forth. His productions, however, are very varied, and, for

the most part, of a sound and good order, well mo-



delled, carefully coloured, and displaying much taste



in treatment and harmonious arrangement of subject.

much like a compromise in tinting, and although individually harmonious, they contrast unfavourably with each other in the grouping.

The best example of coloured treatment is a majolica *jardinière*. The body is square, with a *naturalistic* treatment of the convolvulus, arranged and modelled with great taste. The colouring of the flower in harmony with the blue tone of the body is excellent, and affords a proof of what can be done in giving effect to decorations in relief, when the artist-workman understands his work, and the simple law of chromatics as applied to masses of colour, and to the details in direct contact with those masses.

We might have quoted more individual examples of well-directed judgment in the form and objects in relation to use or special

purposes of decoration, but it is sufficient for the record of the time to say, that the Royal Worcester Porcelain Works has proved by its contributions that its career during the last ten years has been one of successful and steady progress, in which the results are marked and unmistakable.

Of course, we are quite aware that under the supposed guiding genius of the market, and the misguided zeal of the dealer, concerns like this have to submit in many things to the dictation of those who only buy to sell. Happily, even these persons are to be taught, and the lessons will only be the more rapidly acquired if the public, out of the teachings of what is shown in such Exhibitions as this, learn not only what to ask for, but to demand that it shall be supplied: since it gets proof-positive that there is no lack

The CHALICE COVER, of which we give an engraving, is a finely-wrought example of Devonshire lace, contributed by Mrs. TREADWIN,

of Exeter, under whose immediate superintendence it has been designed and worked; and as a specimen of the fabric for which the

county is famous it has rarely been surpassed. The manufacture has been greatly promoted by the efforts of this lady, and to her exertions for

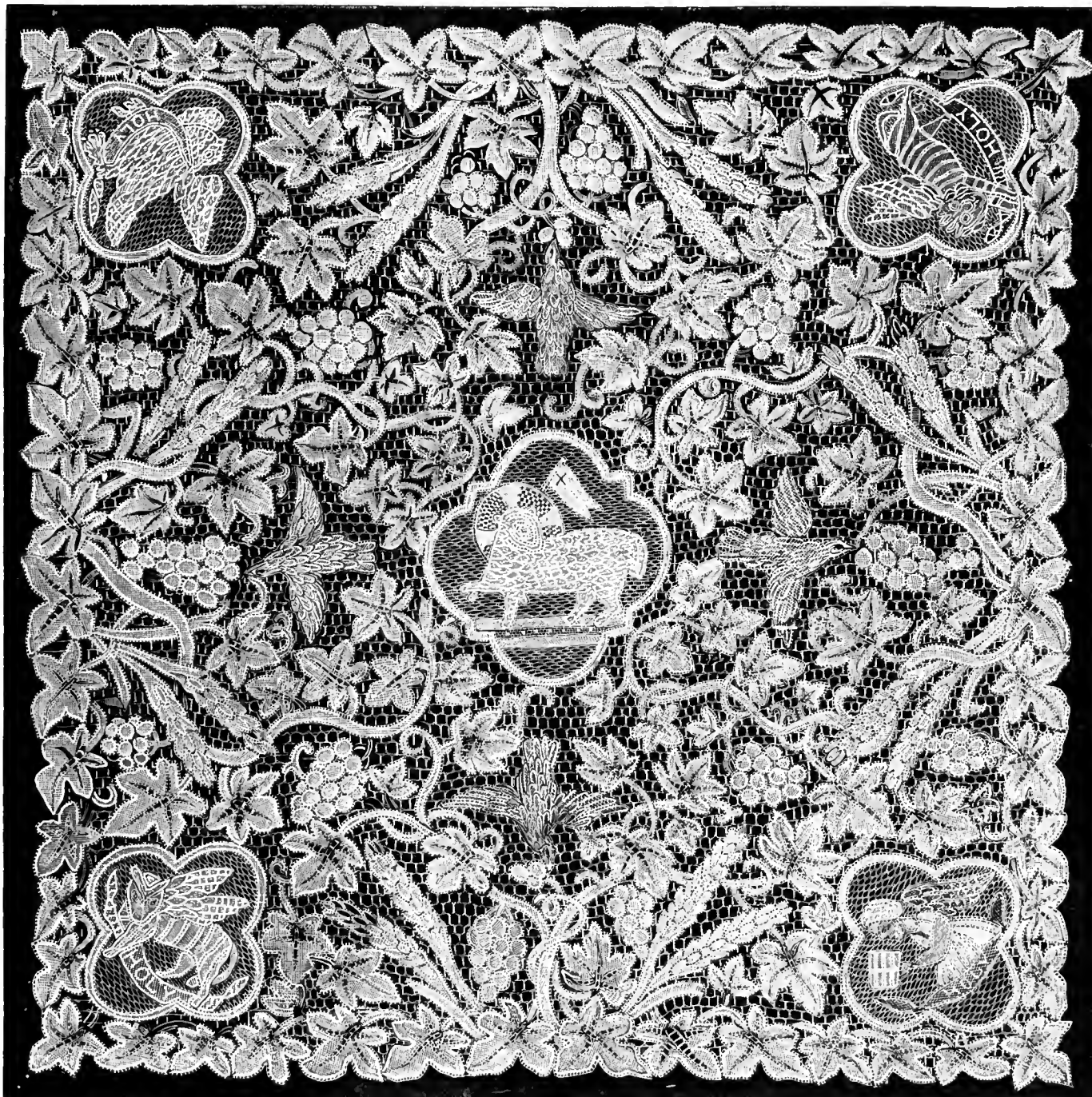

its advancement we may attribute much of its prosperity. The Chalice Cover may be thus described;—in the centre is the Lamb, with

nimbus and flag; in the corners are the symbols of the four evangelists; on each side, descending from the centre, is a dove. Mrs. Treadwin

claims to have treated these symbols "in an entirely new way,"—parts being represented by a process that may be termed "lace-embossing."

of power to supply it, when the will and sufficient intelligence exist on the part of the shopkeeper to do so.

In connection with the products of Worcester we may fitly consider those of the old-established manufactory at Coalport, Salop. Messrs. J. Rose & Co. exhibit in their own name a very interesting collection of vases. These are happily brought together in one glass case, and afford a fair means of comparison not only with similar works produced by this house, and exhibited on former occasions, but also with the works of other producers. The effect of the whole is such, that while taking exception to some of the details as being rather mechanical and traditional than artistic, especially in the treatment of some of the flowers, it is impossible not to feel that a high standard of excellence has been aimed at and achieved, and that the effects produced are essentially ceramic in

the best sense. The turquoise and *rose-du-barry* grounds are very pure, the gilding is of the highest character, and executed with great taste and skill in the minuter details. The landscape-painting is especially free and artistic, with a success in colouring which is exceptional in works of this class. Then, in addition to these admirable details, the style and forms of the objects are well chosen to carry out the predominant idea of the producer; evidently a bold rivalry of the best examples of a similar character produced by such establishments as Sèvres, Berlin, or Dresden. Such works as these would have been considered simply impossible in England twenty years ago.

To-day they take their place as the pleasing realities of a sound progression from the vulgarisms of the Bond-Street standard of taste of the period anterior to 1851.

This page is devoted to a Majolica EWER and PLATEAU, contributed by Messrs. GOODE. It is manufactured and "baked" by Messrs. MINTON, but made expressly for this firm: it holds a high

and so forth. The plateau contains symbols—Pastoral Poetry, Comedy, Satire,



place among the best productions of ceramic art contained in the Exhibition. The design is from the graceful and skilful pencil of Miss ELLEN MONTALBA, and the painting is entirely the work of



Mr. W. J. GOODE. The subject consists, mainly, of three figures which represent Epic, Tragic, and Lyric Poetry; the Cupids which surround the ovals typify Heroism, Grief, Victory, Love, Despair,



&c. The engravings on the column are of the two figures which do not



appear in our print of the Ewer. Every part is elaborately and effectually filled.

The well-established reputation of Messrs. Copeland and Sons, of Stoke-upon-Trent and London, is always a guarantee that whatever they contribute to a gathering like the present International Exhibition will be worthy of consideration, and however much difference of opinion may be evoked as to the choice of subject and perfect appropriateness of design, yet that the work shall be well and thoroughly done, and the quality of the ware above all suspicion.

On the present occasion Messrs. Copeland have, to say the least, sustained their position as a whole; while, in some special points, they have shown such a marked advance, alike in choice of subjects and in the treatment of the objects selected, as to give an

earnest of future movement. As a proof of this we would especially note the specimens of a dessert-service—a series of plates. These have perforated borders in the manner of a Japanese fret, which at once suggest, without imitating, an Oriental detail. The centres are decorated in raised enamel, with admirably treated and charming representations of birds, flowers, fruit, and insects, coloured with oriental brilliancy, but harmoniously subdued in effect. In short, without being an imitation in any way of Oriental porcelain, we have here conveyed to us all the general effect of Eastern colour with a decidedly Western rendering of nature, in a form adapted to the special use of the objects decorated.

As the selection of these special examples has led us to notice

The SHIELD engraved on this page was "the Doncaster Prize" of 1865. It is one of the many famous works of Messrs. HUNT AND ROSKELL. They are not large contributors to

the Exhibition, but show sufficient to uphold the high reputation they have established not only in England but throughout Europe; their renown is, indeed, closely associated with that

of the century—in Art that gives enormous value to the precious metals. The shield represents, in *alto-relievo*, the meeting at Doncaster, in 1339, of Henry of Bolingbroke on his return from



banishment, and the Earl of Northumberland, with his son Percy, the Earl of Westmoreland, and the Lords Willoughby, Ross, D'Arcy, and

Beaumont. The compartments in *bassi-relievi* illustrate the Greek, the Roman, and the modern races, and are divided by medallions, with

figures of the Genii, Victory, and Fame, holding shields, the whole surrounded by a framework of elaborate and refined *repoussé* ornament

the dessert-plates in the first instance, it may be as well to point out other plates which illustrate improvement in the embellishment of these important adjuncts to a well-furnished table.

As a rule, plates are either over decorated, or they present such instances of baldness in ornamentation as to suggest that it would have been better to have foregone all decoration aiming at more than a definition of the form. Most commonly, the plate seems to have been made for the purpose of carrying a certain amount of ornament, and not to have been in any way looked upon as an object for a particular use, requiring a treatment appropriate to that use. Now, in most of Messrs. Copeland's examples of this class of objects, this important point has been achieved in a very satisfactory manner.

Those already named are special illustrations of richness of

effect without going beyond the modesty of tasteful ceramic art; and, among a great variety, may be mentioned as peculiarly worthy of attention, examples of a series of dessert-plates having a broad border of light celadon green of exquisite tint, relieved with raised gold, and a light green ribbon edging—the centre being occupied by exquisitely-treated flowers. As specimens of refined work in porcelain, they leave nothing to be desired. Equally satisfactory are some plates painted with figure-subjects of a high character, in which the brilliancy and purity of the colour is enhanced by a pearly grey tone and a precision of touch in the handling of the subjects rarely found combined with so much delicacy and tenderness.

The cups and saucers, *tête-à-tête* services, &c., of Messrs. Copeland, all partake, more or less, of the same general character.

M

Messrs. H. R. WILLIS & CO., eminent manufacturers of CARPETS and RUGS at Kidderminster and also at Coventry, contribute many

examples of their always admirable works. They are renowned for their "Three shute Wilton" carpets (the name is perpetuated,

although the town in which it originated has ceased to be famous for productions of the class); and Messrs. Willis and Co. have so reduced the

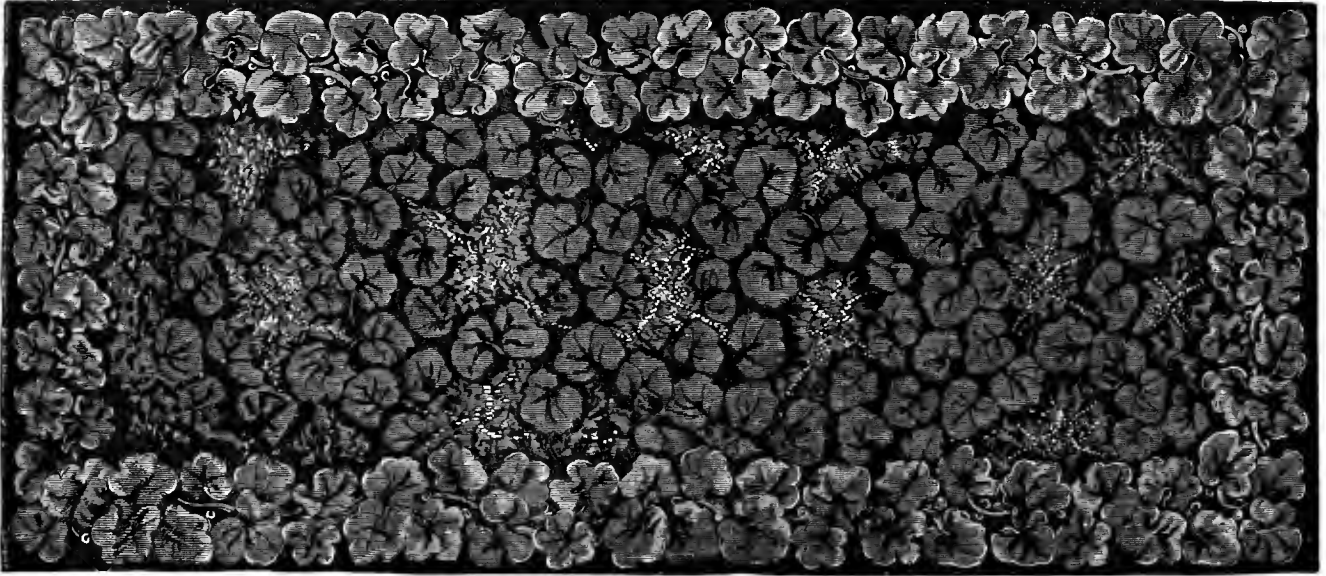

cost of the fabric as to bring it within the reach of ordinary purchasers. We engrave on another

page examples of their carpets: this page contains two of their rugs: they are far better

in the originals than they are in the engravings, for we fail to give any idea of the bill-

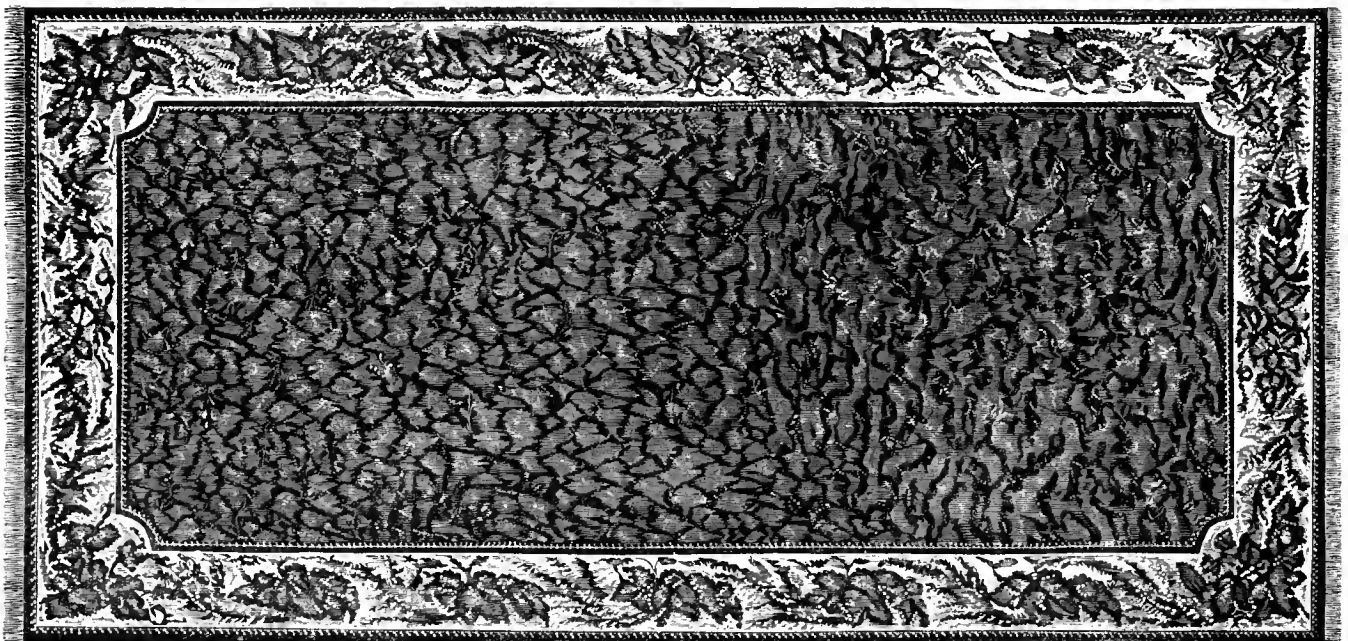

liant dyes and the peculiarly soft and pleasant "feel" of the fabric. To represent fairly this order of produce is very difficult, so much de-

pends on matters *extra* the patterns. In all that ministers to comfort and elegance in the home-furnishing so essentially English, Messrs.

Willis excel. Their important productions have found their way wherever Art-manufacture of a high order—and for extensive use—is appreciated.

They are mostly elegant in form, and the decorations are well considered; the execution of the details being skilfully managed without being over-elaborated.

A pair of *seaux* may be quoted as special examples of this quality. These are decorated with primroses and violets growing round the body of each *seaux*. The manipulation has been just carried to the point necessary to express all the artist intended, and to convey a perfect suggestion of the flowers in their growth. Here the work has stopped. Mechanism has not gone on until it has destroyed sentiment and artistic feeling,—by no means an uncommon result in porcelain-painting.

The general elegance of form which characterises Messrs. Copeland's vases is enhanced by satisfactory flower-painting as a decorative detail. It is satisfactory to see that the tendency

to rely upon good form in the first instance, and less upon gilding and painted decorations, is extending itself, and, indeed, may be said to be a general characteristic of English work of this class in the present Exhibition. In this respect, in spite of the very admirable flower-painting by Hürton, which gives it great artistic value, we could have wished the largest vase, showing great skill in manufacture, had been absent. The heavy gilt details in the form of handles, &c., simply imitate metal, and had better, for every purpose, have been produced in that material. So much ability and skill should not be thrown away in the imitation of one material in another, purely for the sake of overcoming a difficulty which, when overcome, does not satisfy the mind of any thoughtful person.

Most of the smaller objects are very successful in treatment;

The large CIRCULAR FOUNTAIN is a work in Terra-cotta, the manufacture of DOULTON AND Co., of the Lambeth Pottery. It was designed by Mr. JOHN SPARKES, the head-master of the Lambeth School of Art, and modelled by Mr. GEORGE TINWORTH, late a pupil of that school, but now artist to the esta-

blishment. It is but one of many admirable

works produced by the eminent firm; some are fine specimens of Art, others are utilities, chiefly for the architect; but all are marked by great excellence of design and finish, and are guaranteed to bear any extremities of frost—a necessary advantage, for a number of their issues are for out-door positions—for gardens,



lawns, pleasure-grounds, and so forth. The work we engrave is as excellent an example of the art as has yet been produced in this country.

nothing can be more so in colour than several jewelled vases and bottles. In colour they rival oriental richness of effect, the harmonious contrast between the turquoise ground of the necks and bases of the bottles, with the jewelled details, being very complete. The handles, however, ought to have had some consideration from a common-sense stand-point. Petrified ropes are not satisfactory handles, even in common ware: but when introduced as adjuncts of works like these, they become positively annoying.

For novelty, we must notice as an effort in the right direction, some vases, of quaint but elegant form, painted in a manner which brings to mind a style of ceramic decoration of a very similar character which we have seen on Neapolitan ware, made about 1800. It is suggestive of the Pompeiian style without the

excess of colour. Groups of classical figures treated *en silhouette*, on white grounds, with *patere*, frets, &c., in gold and secondary tints; small groups of vases, &c., being introduced as decorative details, as in Pompeiian wall-pictures. The pure tone of these examples gives a great charm to them, as they look fresh and brilliant by the side of the more highly-coloured specimens. Some plates and a tray for a *déjeuner* service, decorated in the same manner, are very creditable specimens of porcelain.

Messrs. Copeland's reputation as producers of high class works in Parian and statuary porcelain is admirably sustained by the specimens exhibited, which all show great discrimination in choice of subject and artistic treatment of the material. A novel contrivance, by Mr. F. Battam, for a flower-stand and Parian figure combined—the latter being changeable or removable at pleasure,

M. SNYERS-RANG, of Brussels, is the most



extensive and the best of the many manufac-



turers of furniture—*simples et riches*—of Bel-



gium, and holds high rank among the leading

ebenistes of the Continent. We engrave of his works two CHAIRS, a SCREEN, and a CABINET. The cabinet is a production of great merit: in

design an example of true Art, and admirably carved, of oak. It is in that "mediæval style" which is popular not only in England but in all



countries: yet is by no means a copy: the artist has taken his "manner" from sound authorities, but the treatment is his own. The emi-

nent firm is represented in London by Messrs. Bontor and Collins, Oxford Street, who are themselves upholsterers of high and deserved repute.

having a trellis-work for creeping plants running over the figure and forming an arcade, also removable—is an elegant, and will be a popular adjunct to the drawing-room embellishments, as it comes within the reach of persons of moderate means.

As regards the character of the earthenware for more ordinary use, contributed by Messrs. Copeland, it will be quite sufficient to say here, that it is of the usual excellence in make, with a decided improvement in the general character of the decorations in transfer-work, both in single colour, and painted, or tinted.

We now take up the very varied, and certainly very excellent, display of Messrs. Minton & Co., of Stoke-upon-Trent; premising that the firm originally known as that over which the late Mr. Herbert Minton presided for so many years, and with such impor-

tant results, not only to himself, but to others, is now divided into two concerns, one known under the above title, and the other as Minton, Hollins, & Co. The latter house, however, confines its productions to floor and wall tiles of various kinds, and to porcelain mosaics, and mosaic *tessere*.

As our present business is with the porcelain, and high-class pottery, we must notice the tiles of Messrs. Minton, Hollins & Co., with other works of that class.

It is impossible to over-rate the excellence and practically suggestive character of the remarkable collection of examples contributed by Messrs. Minton & Co. The maiolica alone is of such artistic quality, in spite of certain drawbacks in colour, as to stamp the production as one far above the average. Happily, there are no works of such an exceptional size as to put them out of the

Messrs. ELKINGTON are not extensive con-

ment. We engrave two FLOWER-STANDS of glass

of iron, with silver and copper enrichments,



tributors to the Exhibition; what they have sent are fine and very beautiful examples of Art—the productions of two great artists, M.M. MOREL LADEUIL and WILLMS—attached to the renowned establish-

and metal, both designed by M. Willms. The TAZZA

is exhibited as a new decorative process. The large ROSE-WATER DISH (one of a pair, representing the months) is from a design and model of M. Morel Ladeuil. The silver TAZZA, the



subject "Prudentia," is modelled by A. RIVEY; the VASE, associated with it, is by the same artist—the figures representing Music and Poetry.

ordinary market for first-class objects suited to the conservatory or garden.

The two largest examples are a fountain for a conservatory, and a wine-cooler, both admirably designed and modelled. The wine-cooler is supported at each end by standing *amorini*. One is crowned with wheat and poppies, and the other with the vine. The effect of the whole is artistic, in spite of a little too much localisation of tint. The fountain is equally good, and equally open to the same objection. The masks of Fauns, the *amorini*, and the vine running round the periphery of the basin, form an agreeable composition.

In connection with the maiolica, the incised, or Sgraffito-ware may be noticed as a speciality of Messrs. Minton's current pro-

ductions. The able designs of Mr. Alfred Stevens, the sculptor, have been realised in a manner so perfect as to leave nothing to be desired. All the forms and details are wrought out with a skill worthy of the period of the *cinque cento*, and the colouring is superb in its rich deep tones. Thoroughly well considered in all the minutiae of the decoration, those productions certainly stand alone as works of ceramic art.

The revival, or imitation, when not carried too far, of any of the historic styles of pottery, is always to be commended; inasmuch as it brings modern methods and skill face to face with the past. The examples in the manner of the famous so-called Henri Deux ware, which Messrs. Minton have produced from time to time of late years, are well illustrated by the specimens exhibited. A pair

We engrave on this page one of the most meritorious works in the Exhibition—a TOILET-TABLE, the contribution of Mr. ARTHUR FOLEY,

of Salisbury; it is of American birch and ebony,

with circular inlays of various woods, and incised coloured ornaments, the panels containing pictures photographed on wood by a newly



patented process, the patentee being the manufacturer: these are so effective as easily to be mistaken for actual paintings. The table, designed by Mr. H. DICKENSON, is a very charming production.

of candlesticks, a tazza, a ewer, and a biberon, are all generic types of the ware imitated; the details of inlaid-coloured clays being skilfully and most artistically managed in the whole series. The cost of these examples will always limit their production, and render them exceptional enough for the collector of the rich and rare originals, no longer, however, associated with Henry II. and Diana of Poitiers, as it is quite clear that the myth which gave this ware its name is no longer tenable. Still, from its artistic excellence and peculiarity in production, together with the rarity of known examples, some fifty-three or fifty-five only, it will ever hold its position as an important link in the chain of historic ceramic art.

In spite of the great excellence in colour, glaze, and decorative effect of the specimens exhibited, we are not prepared to glorify

the policy, viewed from an æsthetic stand-point, of reproducing so many Japanese and Chinese forms. Even with the very successful variations of colour under which they appear, one feels that the skill and power evidenced in their reproduction might have been turned to better account. Of course, we are aware that fashion is omnipotent in these things as in dress, &c., and when once the dealer has taken his idea from some fashionable collector of pottery, or has hit upon some eccentric whim which he thinks will pay, or has made up his mind that it *shall* pay, the manufacturer, the artist, and those whose taste leads them to avoid eccentricity, are powerless to prevent the whim running its course.

Happily, in these Oriental reproductions, imitations, or quasi-revivals of Oriental design, there is nothing to object to on the ground of extravagance, in form or colour. All are, without excep-

M. JULES HOURY is a prominent decorator of

skill and talent much of the supremacy of the establishment is due. Three brothers, MM.

Jules, Charles, and Emile, Houry, are respectively the artist, manufacturer, and merchant



porcelain in Paris, and his works attract desc:red

of the eminent firm. Their *spécialité* is the application of Faïence to furniture—tables,

cabinets, flower-stands, and so forth. They are well known as graceful and agreeable



attention in the International Exhibition. His

additions to our English drawing-rooms, and are generally appreciated; for the *plaques*

and *plateaux* of M. Charles Houry are often pictures, and may be valued as rare works of



brother, M. CHARLES HOURY, is the artist to whose

Art. It is this power of associating elegances with utilities that gives so much power to the fabricants of France—a system far too much

neglected in England. By such means mere "nothings" often become valuable aids to taste and important teachers of true Art.

tion, alike excellent; and some specimens are exceedingly interesting, as showing how thoroughly the western potters of the present day can compete with the best productions in the Oriental ware of the past. In some of these Oriental forms, especially some square caskets, the colouring employed is of the highest taste. Celadon, white and gold, white and blue with gold lines, simple white and celadon, and a light blue glaze, supplemented in the details with a dark blue glaze of rich tint, all present effects of a most charming character.

In the more original specimens, especially of vases, there is a series with rich turquoise grounds, having raised enamel flowers, insects, &c., painted in a vigorous manner; which in combination with highly satisfactory forms, produce rich and excellent effects. A cylindrical vase, mounted in the Oriental manner upon a stand,

with this rich turquoise ground, having birds and apple-blossoms painted on coloured enamel, and in high relief, is probably the finest piece of keramic colouring in the Exhibition.

Messrs. Minton exhibit some admirably painted vases, of the more ordinary porcelain types, wherein the general forms and decorations fully sustain the well-earned reputation of the producers, but which it would be useless to individualise.

In plates, cups, and saucers, are examples which could not be readily surpassed. All are well considered in the treatment of the decorations, which are rarely overdone. One series of plates may be mentioned as exceptional examples of purity of colour.

The examples of *pâte sur pâte* are generally very bold and effective; but they are certainly wanting in that delicate gradation in the shadows which characterise the very best examples of our

We engrave on this page three examples of the CARPETS of Messrs. JOHN BRINTON & Co., of Kidderminster,—the largest private firm of

and Axminster fabrics : and the excellence of their productions, both in design and workmanship, has been acknowledged at all the principal

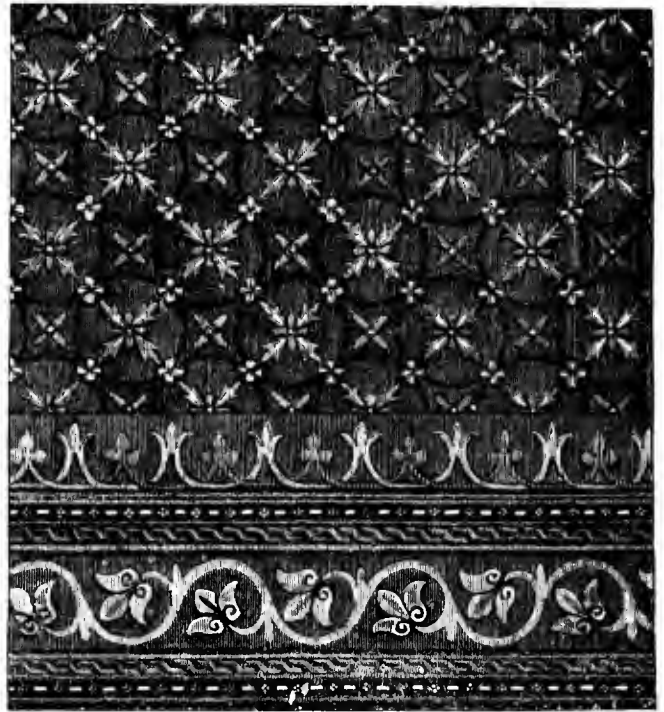

carpet-manufacturers in the Kingdom. Their manufacture extends from the raw wool to the finished goods, which comprise the Brussels, Wilton,

Exhibitions which have been held : prize and juror's medals were awarded to them for their carpets in London in 1851 and 1862 ; in



Dublin in 1865 ; and the Gold Medal at the Paris Exhibition in 1867. We select from their "exhibits" two specimens of the "Wilton," and

one of the "Axminster;" the Axminster being designed for an English dining-room, where the warmer tints are the most commonly employed.

neighbours the French. There is a certain hardness and coarseness in several of the specimens exhibited, which, in spite of the great skill shown in their execution, constitutes a drawback which cannot be overlooked ; especially as it is of importance to encourage so artistic and legitimate a method of decoration, and one which we shall be glad to see our English potters taking up earnestly ; not so much by the employment of foreign workmen, as by seeking to utilise the artistic power around them among the best class of students from our Schools of Art ; since in this method we have the skill of the painter and the modeller combined, if the result is to be really artistic.

We have reserved Messrs. Minton's most distinguished and successful novelty until last,—the combination of porcelain and metal-work in the production of vases in the Moresque style.

Here we have a most elegant result produced by a legitimate combination of materials. The forms of the vases are so designed that the damascened metal alternates with the porcelain portions ; these latter being so treated in gold and colour as to produce an homogeneous effect of the most tasteful character.

Of course, Messrs. Minton exhibit largely in decorative tiles, especially wall-tiles. It will be sufficient here to say that they are calculated in every instance to extend the great and well-earned reputation of the house in this speciality. One series, of Persian design, is the perfection of wall-decoration of its class.

Having mentioned the tiles of Messrs. Minton & Co., it may be as well to notice at once the exhibits of tiles, alike for walls and pavements.

When we reflect, that prior to the great Exhibition of 1851, the

Messrs. WEDGWOOD AND SONS, of "Etruria" (honoured be the names of

original in design and of very considerable merit in execu-

this page; the chief is a EWER of majo-



the family and of the place) are extensive and very valuable contributors to the



Exhibition; their principal productions are of the class known as "Jasper,"



and many of them are copies (some with marked alterations) from the glorious models of the great Josiah. Others are



tion, a large proportion of them being painted by a true



artist—M. LESSORE. We have selected a few to fill

lica. The other objects are ordinary produc-



tions of the firm—vases, flower-pots, and so



forth, and a very charming tête-à-tête tea-set.

important industry, which on this occasion takes so prominent a position among ceramic products, had practically no existence, except in the costly and exceptional experiments of the late Herbert Minton, and the designs of A. Welby Pugin, it is not too much to say that the skill and enterprise of Mr. Minton has produced a result which few could have anticipated; and it is not a little remarkable, that, in the special direction in which Mr. Minton moved, there is scarcely to be found, among the varied designs and treatment of encaustic floor and wall tiles, a bad or unsuitable design; although, of necessity, many designers and manufacturers have been engaged in the works produced. This is a triumphant evidence of the value of good example; but above all, of a sound, well-understood principle to begin with. You have a

wall to decorate with tiles in constant repetition? Good! Let it be the decoration of a smooth vertical plane, a flat boundary to a given space. You have a floor to decorate? Let us have common-sense, and remember that the floor is a horizontal plane to be walked upon, and the repeated pattern, from the simple tessellated red and white, to the most elaborate *tessera*, is under the governance of a condition which, if attended to, must keep the designer in the right direction, whatever his invention in form or colour may be.

Messrs. Minton, Hollins & Co., of Stoke-upon-Trent and London, thoroughly illustrate the extent to which the special production of high-class tiles is now carried on by them, as the successors in this section of industry of the late Mr. Herbert Min-

We give examples of the admirable works of

oak, designed, modelled, and executed by Mr. MARK ROGERS; a FRAME of walnut wood, by the same artist;

the heads representing the four Seasons are of pear-tree wood. The column contains a small CABINET (one of



Messrs. TROLLOPE AND SONS, the renowned up-



the panels of which is enlarged), executed in Messrs. Trollope's new process, termed "Xylotechnography,"—a

work is one of many shown by the firm, de-

process that gives it all the effect of combined ebony and ivory. This



ho'sterers and decorators: a CLOCK CASE of carved

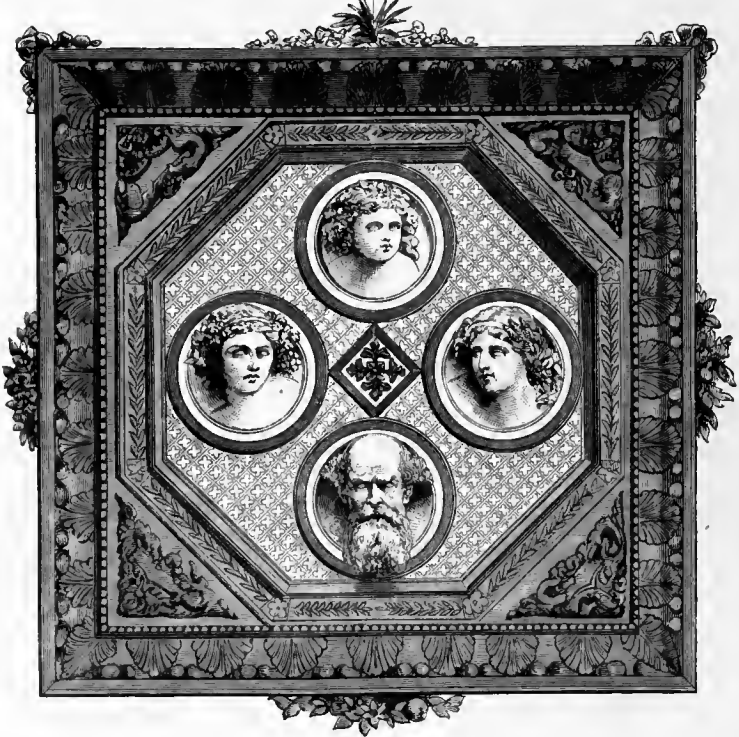

corated by their novel process; it is designed by Mr. BROPHY, and executed by Mr. G.

CLAUSEN, both artists of the establishment, and both gold medallists of South Kensington.

ton. The examples are, unfortunately for the producers, much scattered, but they comprise specimens of all kinds of embossed, inlaid, and encaustic tiles. The colour is generally well selected and harmonious, and, in the glazed examples, the brilliancy and richness of the vitreous surface are perfect. Some of the bordering tiles, suitable for flower-stands and long boxes, are decorated with admirable treatments of flowers and plants in repeats of conventional arrangement, at once architectural without stiffness, and artistic without being an inappropriate imitation of nature. There can be no doubt, however, that this class of ceramic productions is seen to great disadvantage in an exhibition like this, the very nature of which necessitates the division

of the various designs into sections, but wholly unsuited to give the true result when seen in connection with the buildings they are designed to decorate.

Of the porcelain mosaic examples and the mosaic *tesserae* manufactured by Messrs. Minton, Hollins & Co., we can only say that, in variety of tint, perfection of colour, and thorough adaptation to the purposes for which they are designed, they cannot be readily equalled, certainly not surpassed. Of course, they have not at first sight that brilliant look which comes of vitreous or glass mosaic, but in the solid quality of purity of tint and general tone, they are to our minds unrivalled. In one or two examples glazed and unglazed *tesserae* have been used with great

From the many admirable and valuable contribu-



tions of M. EMILE PHILIPPE, we select the four that adorn this page. The artist is also the manufacturer,



and, we believe, the artisan and the merchant—a

combination unknown in England. He has established much repute in this country as well as in Paris, and is highly estimated by

all who appreciate Fine Art: at the Exhibition of 1867 he obtained a gold medal, and occupied a first place among the exhibitors



as an artist of taste, knowledge, and judgment. He maintains his reputation in 1871:

the jewels and plate he exhibits are of the best order. The objects we select are mounted

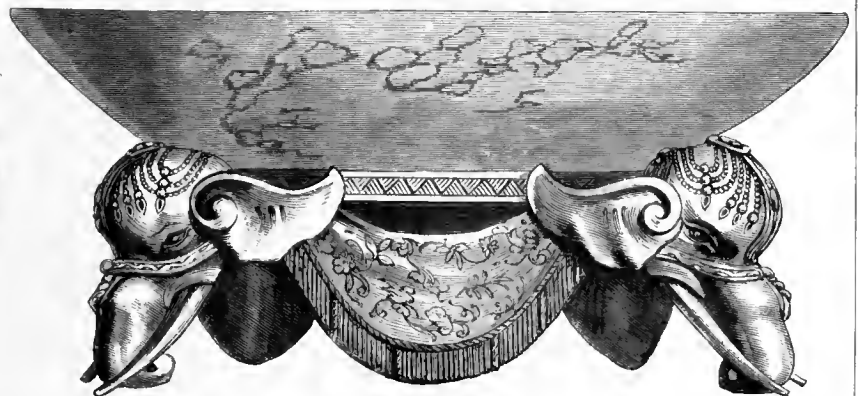

rock crystals, the crystals being sometimes cut. One is in the style of Louis Quatorze; the others in the Chinese and Persian styles;

the silver and gold being variously coloured, and judiciously harmonised or contrasted. They are pure examples of Art.

effect. The contrast in tone thus obtained between the dead or unglazed surface, and the bright tint brought out by the glaze, is very satisfactory.

We could have wished the series of tiles decorated with transfers, in colours, of subjects of a similar character to the old Dutch tiles had not been exhibited. They are unfortunate even to eccentricity, and it would be a misfortune for any family of young children to have to look at them from day to day, imperceptibly imbibing their notions of colour from examples which cannot fail to pervert the vision in a manner by no means pleasant to reflect upon.

An essay might be written on the question raised by this simple illustration of the harm which is done to the Arts, pictorial and industrial, by the carelessness so commonly shown in the sur-

roundings of young children in this matter of articles of pottery and porcelain alone. For ourselves, we have still vivid recollections of a prettily-decorated tea-service, in which a treatment of the corn-flower played an important part; to say nothing of some precious Wedgwood cameos, cracked and battered withal, which were more than an Art-gallery to our childhood. These, in contrast with some hideous Dutch tiles, the horror of the same period of our existence, prompt the denunciation at all fitting opportunities of the eccentric abominations which are thought good enough for the use of children.

Yet these children are to grow up and become the men and women purchasers of a future period. Can it be wondered at, then, that the more sensitive of the two sexes so often display the effects of their early surroundings by the selection of vulgarly-

Messrs. GRINSELL AND BOURNE. of Bir-

are original, others are copies from classic models, and others

and graceful designs, and excellence of workmanship; our space



tingham, hold high rank among the best



are from esteemed examples of Continental Art. We give six



does not permit us to supply details. The few engravings we



electro-platers of England. Most of their works



specimens of their works, merely to show their varied character. They are renowned for good



give will convey an idea of the character of these productions.

coloured and gilt objects for the adornment, or rather disfigurement, of their houses; and show an eccentricity of colour in the adornment of their persons which can only be accounted for by a hideous perversion of their perceptions of colour;—ringing of the changes, ding dong bell, upon the brightest red, blue, and yellow they can obtain; to say nothing of blotchy fabrics and pretentious jewellery.

In further illustration of the admirable character of the wall tiles contributed to this Exhibition, those of Messrs. Maw & Co., Benthal Works, Broseley, must be mentioned. The coloured architectural decorations of this firm are of an excellence in design and general treatment which a few years back it would have been hopeless to have expected from any producer of pottery in Eng-

land. The series of embossed wall tiles, with white "slip" surfaces giving value to the colour, is remarkable for excellence of general tone and richness of effect. This arises in the first instance from carefully-selected tints of good colour in themselves, and rendered still more effective by judicious contrast. Thus the tints are in broken, and not in the solid and somewhat harsh, masses of which we complain in those examples of maiolica we have already quoted. These broken tints combine like the judiciously-broken touches of colour in a good picture: mechanical harshness and localised tints are avoided, and the whole unite to produce harmony of tone in the mass. This, it must be remembered, is a very different thing to the careless, broken, and "streaky" effect we occasionally see in some examples of

The TABLE-TOP of exquisite marqueterie is the property of his Grace the Duke of Northumberland, for whom it was designed by Mr. C. P.

SLOCOMBE, of the Government School of Art at South Kensington: the commission was given on the express understanding that the design

should be approved by Daniel Maclise, and it received that artist's "high commendation." The inlay was intrusted to, and mainly executed



by, Mr. HENRY BLAKE, who unfortunately died before its completion, and it was finished by Mr. VERT. The subject of the composition is the Five Senses. Both in design and execu-

tion it may be pronounced the most perfect object of its class that has been produced in England; indeed, altogether, perhaps, it is unsurpassed by any modern work. The artist

holds a prominent position; South Kensington supplies ample evidence of his great ability. This is an effort of genius of a high order, and is justly entitled to the admiration it excites.

modern foreign imitations of Palissy ware, in which the colour combines rather by accident than by Art.

Messrs. Maw's collection of small flower-vases, &c., the forms of which are generally well selected and elegant, are also excellent specimens of colour and glaze. The tones of some of these simple but effective articles are all that could be desired, and are preferable, as the decorative adjuncts of the drawing-room, to more ambitious but less suitable repositories of the floral wealth of the garden or conservatory. Nor should a series of specimens of incised or Sgraffito ware, placed in the same glass-case with Messrs. Minton's admirable examples already named, be overlooked, since they lose nothing in colour by contrast with their more highly-finished rivals. On the contrary, the bold, if somewhat rude, treatment gives them a charm which more than com-

pensates for an apparent lack in finish. The design, the thought, the full intention is carried out, and that is enough. We only wish that this was more frequently achieved in the more ambitious articles.

The tiles of Mr. R. Minton Taylor, of Fenton, Stoke-upon-Trent, fully come up to the best examples of encaustic wall and pavement tiles. The designs are well adapted to the purposes for which the tiles are manufactured; and, except that we observe a tendency to the exaggerated use of a very brilliant and solid yellow or amber tint which strikes the eye at times rather harshly, the colouring of Mr. Minton Taylor's tiles is undoubtedly good. In every other quality they are unexceptionable specimens of sound manufacture.

The Architectural Pottery Company, St. Martin's Lane, London,

We engrave another selection from the admirable works of MINTON & CO., of Stoke-upon-Trent; three of them (the three first on the page) are imitations of the ware known as "Henri



Deux,"—a CANDLESTICK, inlaid with coloured clays; a SALT-CELLAR, also of coloured clays; and a VASE, composed of coloured clays, mounted in damaskeen metal-work, by ZOLUAGA,



of Madrid. The style is original, and cannot fail to command attention: Signor Zoluaga has justly obtained renown as the only reproducer of the damaskeen work made by the Saracens in the

olden time. These imitations are specially produced by Messrs. Minton. The



fourth engraving is of a large JARDINIÈRE in Graffito, or, as it is sometimes called, Perugia ware. One clay is laid upon another, and the pattern engraved



with a tool, until it is "shown up" by the different colours of the lower strata.

and Poole, Dorset, where the works are carried on, exhibits a series of excellent examples of tessellated pavements. The designs are good, and in great variety. Following the lead set so emphatically by the early producers of those important architectural details, some of the mosaic effects are most excellent, being very distinct in character. The whole series of contributions by this house is of a thoroughly good vitreous quality, which promises well for durability and strength.

In connection with this important question of vitreous and ceramic adjuncts to architectural decorations, it may be well to notice at once the very remarkable series of contributions of painted wall-tiles, and kindred productions by Messrs. W. B. Simpson and Sons, West Strand, London.

As an illustration of the value of seeing these decorative details

in situ, the section of a staircase, with wall decorations in connection therewith, may be quoted. In this example we have a complete arrangement placed before us, and the relation of each portion and detail to the whole work is seen at a glance. The treatment of this staircase, and the wall, which practically forms the background, is very satisfactory. The general effect is lively and harmonious, and the minuter details are admirably designed and painted. No portion is over-wrought, nor is any work thrown away, yet there is a look of completeness which satisfies the eye. The "subject" panels of the wall-tiles are incidents in rural life, pleasant to look at, and appropriately selected. The balustrade and hand-rail are admirable in design and modelling, while as specimens of pottery of its class, nothing can be more thoroughly sound in execution and glaze.

Messrs. HUNT AND ROSKELL, the renowned jewellers and goldsmiths, exhibit a case of



jewellery, the value of which consists in the

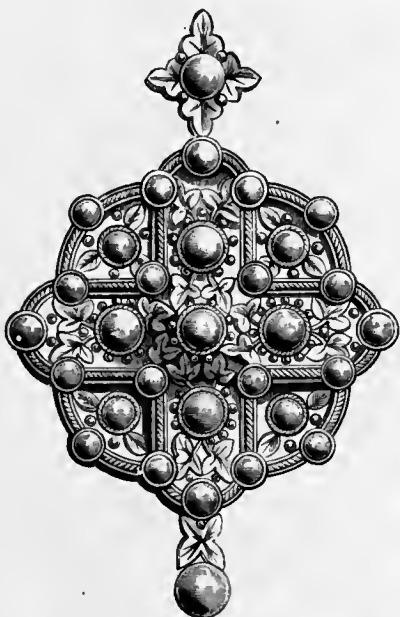

pure and very beautiful application of Art to

the most precious of the metals—"refined gold,"

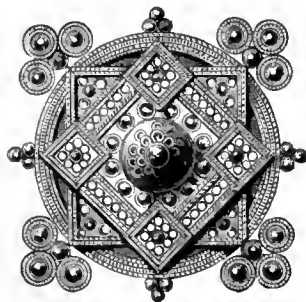

depending almost solely upon this feature for attrac-

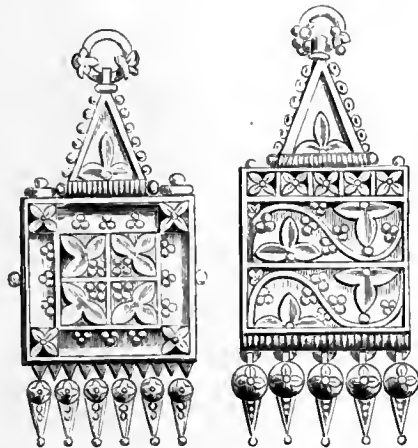

tion; few or none of them being made costly by

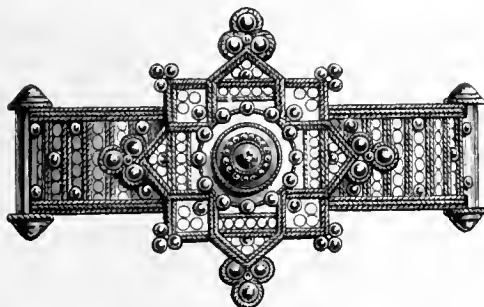

gems. The forms are graceful, and the ornamentation is

simple yet effective; the objects are original



in the best sense of the term, although no

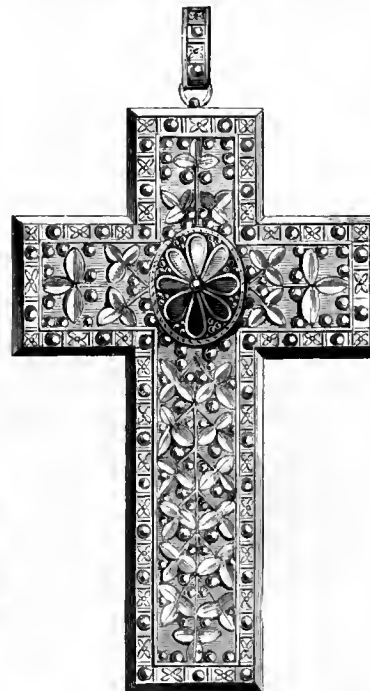

doubt the artists obtained suggestions from

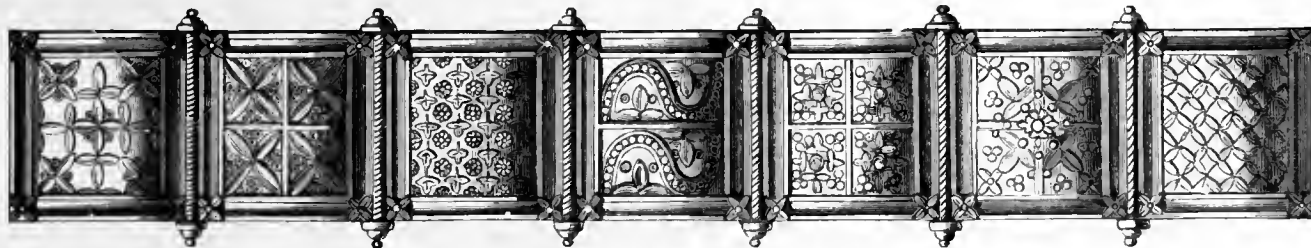

the great designers and modellers of long-ago times. As will be seen, the objects comprise nearly all the varieties, BRACELETS, LOCKETS,

EAR-RINGS, CROSSES, NECKLACES, &c. &c. Some are based on Byzantine models, others on Gothic, others on relics of ancient Scandinavia. The ornamentation

consists of geometrical forms and conventional arrangements of leaves and flowers. Such works as these should be the "fashion."

Messrs. Simpson illustrate the application of painted tiles, as also mosaics, in a variety of forms. Some of the figure-subjects are quaintly designed, and very rich in colour; indeed, the same may be said of many of the ornamental and floral specimens. All are of superior finish, tone, and surface-glaze. The application of painted tiles to chimney-pieces is effectively shown in four examples, in which the tiles are mounted in appropriately designed chimney-pieces of wood or marble. The results in three of these are very satisfactory; but the fourth, which is intended, as we suppose, to suggest the cool depths of an aquarium, or to illustrate life in the artistic effects to be discovered in the depths of a fish-pond, is more eccentric than beautiful or pleasant to look upon. The frantic fish in the central roundel of the frieze is only equalled in absurdity by the fish in a fainting fit at the base of one of the

sides. The ducks may well look astonished, and be in a hurry to get away, although one of them has a strong expression of contempt in his eye and movement for the foreshortened creation of the roundel.

Now we hold that the fireside is the household shrine in this England of ours, and protest against all decorations which do not suggest repose and pleasant associations in connection with it. The charming subjects with which two plates are decorated, placed over another chimney-piece, of swallows sporting against the sky, and an open floral background, or the dead game, and fish of five quatre-foil tiles placed with them, suggest subjects which will always be looked upon with pleasure, and even instruction.

A roundel of tiles, "Spring," placed above the eccentric chimney-piece, is a bold and vigorously-executed example of

CUPS AND SAUCERS are the needs of every



household in all parts of the civilised world;



they are especially so in England. All our

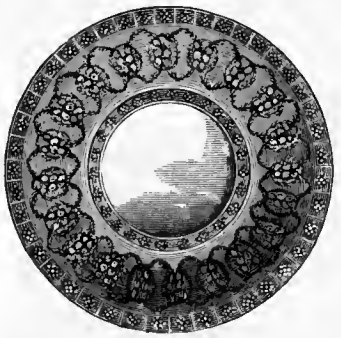

manufacturers produce them; but in one Case at



the Exhibition there is a collection of these

objects only: they are the productions of Mr.



THOMAS BARLOW, of Longton, and manifest much taste and artistic skill, being highly credit-



able to the manufacturer and the artists in his employ: the designs, both shapes and decora-



tions, are by Mr. H. J. KANE, and the whole of the flower painting is by Mr. THOMAS SIMP-



SON. The subjects are by no means exclusively floral; they are frequently arabesque, sometimes

have heraldic devices, and often are ornamented



with raised gold. The DESSERT PLATES (of

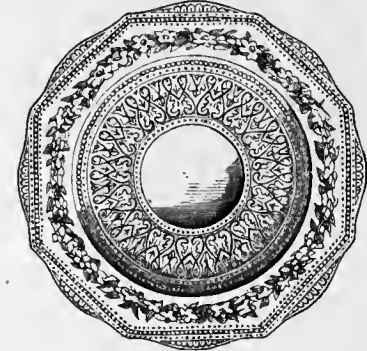

which we give four specimens) are principally of



one pattern—an agreeable novelty—the centres



being varied; they are excellent Art-productions.

original ornament; while a considerable number of illustrations of the mosaics with which Messrs. Simpson illustrate their productions in this direction, are proofs that rapid progress is being made in this country in the manufacture of *tesserae* suited to every exigency of mosaic decoration; and it is pleasant to see the reputation of an old-established house so thoroughly sustained on an occasion like the present.

Dismissing tiles and mosaics we return to the consideration of the contributions in porcelain and earthenware; and proceed to complete our estimate of the exhibits from the Staffordshire Potteries.

The name of Adams is so much associated with the productions

of jasper-ware by Josiah Wedgwood, as to give an interest to the examples of this class contributed by Messrs. John Adams & Co., of Hanley. Unhappily, we cannot think the *tours de force*, in the shape of two very large scent-vases in blue and white jasper, together with a pedestal, as artistically satisfactory. As specimens of skill in pottery, and mastery of material in finish, &c., they are very exceptional; but when we turn to the elegant cheese-stand and cover, a cold-water jug, and other smaller examples in light blue jasper and white, it is only to regret that more had not been done in this direction. The specimens of maiolica exhibited by Messrs. Adams are too cold in colour to be effective in this style of ceramic production, nor can we say much in favour of the general tone of the

The engravings on this page are from works exhibited by M. P. J. BROCARD, of Paris.

Eastern prevailing in the greater number of the examples. The enamelling is of many colours,

but they are composed or contrasted with much harmony. The productions are those of an



They are of GLASS ENAMELLED. It is difficult to convey an idea of their exceeding grace and



esteemed artist, well acquainted with the materials used, and of their capabilities for the pur-

poses to which they are applied. The case of M. Brocard attracted very general attention in



beauty: the forms are varied, but their merit consists in the ornamentation to which they have been subjected: that is of several styles—the



the court allotted to France at the Exhibition; the productions were novelties in modern Art.

The process by which so much of beauty is attained is, of course, a secret of the inventor.

maiolica contributed by Mr. George Jones, of Stoke-upon-Trent; although there are some admirably designed and modelled examples to be found in his display. Notably, the biscuit-boxes are elegant, being prettily tinted with delicate colour. In some of the examples the use of a vivid dark blue upsets the scale and makes the other tints look weak by comparison. In short, the richness which gives value to this kind of ware, and the broken tints already so emphatically insisted upon, are not here. The ultra-imitation of nature, too, skilfully managed as it certainly is in some instances, is not a thing to be carried too far. The true decorative artist uses and adapts nature by a species of reconstruction, following the theme which nature suggests, but remodelling it to the purpose he has in view,—the use to which the object he is designing or modelling has to be put; and thus,

while the idea is taken from a natural form, that form is not so much followed as adapted to the new material in which it is to appear, and the use to which the object, wherein nature's suggestion is embodied, is to be put when manufactured.

In addition to the examples of maiolica, or imitation Palissy ware, Mr. Jones exhibits some excellent specimens of earthenware in the form of ewers and basins for toilet-purposes, and also of dinner-services, the decorations of which are generally tasteful, and well executed.

An admirably-decorated series of porcelain cups and saucers, of excellent form and make, are contributed by Mr. Thomas Barlow, of Longton; and also a collection of plates, together with some dessert centre-pieces of good design, tastefully coloured. Of the cups and saucers, apart from the fact that they are a little over-

Messrs. MAW, of Broseley, have long established a very high reputation as manufacturers of TILES, for all purposes to which they can be applied. Their tiles are, indeed, so well and



largely known, that any description would be superfluous; we engrave three of them. They have recently produced objects of a more ambitious character—works in Majolica or in plain

clays, for interior decorations, and especially for the conservatory. These are graceful as composi-

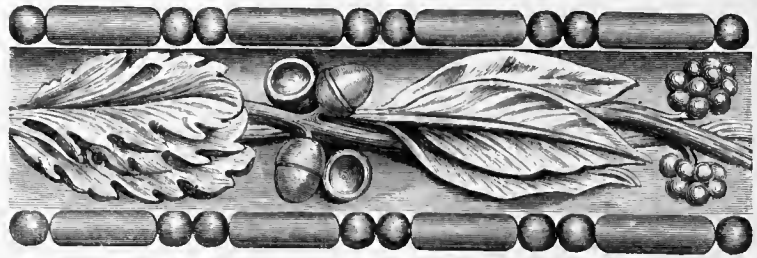

tions, and of pure Art; admirably modelled, so | as to compete with the best productions of their

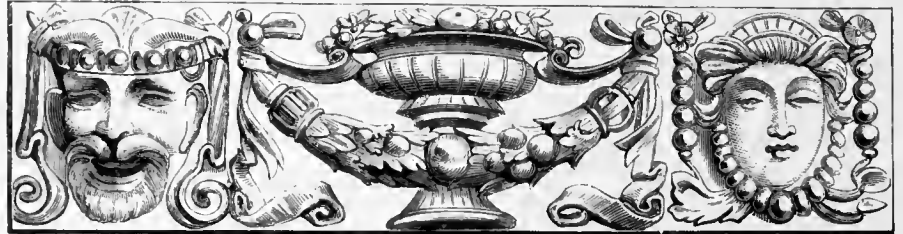

class. We engrave two examples of the many | they exhibit; they are both good; the Jardi-

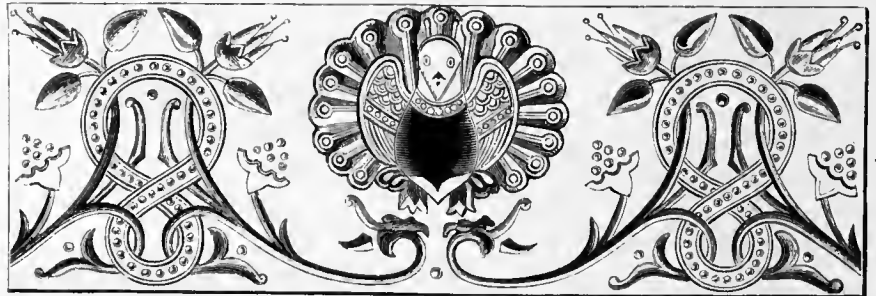

nière especially. With the great capabilities | of the establishment, its staff of experienced



artists, and its other appliances, they are sure to | attain success; or, rather, they have attained it.

done in the ornamentation, we can say, that in point of careful execution of the details, in the general tone of colour and effect, they are admirable. There can be no doubt, however, that the effect of the external decoration of some of them would have been greatly enhanced had the insides been left to the pure white of the "body," which is of excellent quality, as proved by an example without decoration, and, in itself, an exquisite specimen of manufacture. Among the plates, one may be quoted, in which the border consists of an admirably-painted wreath of dog-roses and violets: but for an inner border of gilding, which is too heavy, this plate would have been perfect.

Messrs. Battam and Son, Gough Square, Fleet Street, London, contribute some admirably-executed vases, chiefly painted in monochrome. The forms are elegant, and better considered in

relation to the general effect than objects of this class usually are: but the most novel and successful feature of Messrs. Battam's display are the vases decorated in the manner of the Limoges enamels. One large ewer—which we understand has been purchased for the National Museum at Berlin, now being established as a Prussian rival of our South Kensington—is a clever and successful example of its class. The *cinque-cento* ornamental details are treated in a very happy style, and the classical subject—Apollo and Daphne—which forms the principal decoration, is most spirited, but perhaps a little hard in the shadows. A ewer-shaped vase, decorated with *cinque-cento* masks and scrolls, is also an elegant example; but to our minds the small ewer, of a somewhat lighter tone of blue in the ground, is the gem of the collection. It is perfect in its distribution of the details of the

M. TH. DECK, of Paris, takes the lead in ceramic art, the production of the capital of France. He is an artist of great, recognised, and appreciated ability, whose works acquire



ciated ability, whose works acquire

he is a ripe scholar in his art; his researches into the manufactures of the East—Persia, China, and Japan—have enabled him to adopt their colours and also their "reliefs." Their varied types, remarkable for the richness, boldness, and transparency

ware are pictures of a high order, the



renown wherever exhibited. Moreover,



of the colouring, have been happily applied by M. Deck to this branch of the Art-manufacture of France. He has also successfully imitated the "Henri Deux ware;" and to him is attributed the introduction of the metallic lustre on French ceramic ware. Moreover, his paintings on porcelain and earthen-



productions of a true artist, who can invent as well as execute.

decoration, and in form and treatment. A bottle-vase, with cameo effects, with portions of the ground deadened as decorative details, is also a very successful specimen; as also is a ewer, of a medium tint of blue, and full ornamental details, enamelled in grey and white, with gold details. The bust and ornaments are thoroughly well treated. A pair of Parian vases, painted in light unglazed colour, with figure-subjects, are very elegant specimens of their class. The grey and gold ornamental details are most suggestive and satisfactory.

Irish industry seems almost a thing of the past, except in the production of linen. The sewed muslins of the north of Ireland, which, at the period of the great Exhibition of 1851, formed so important a part of Ireland's display on that occasion, and gave employment to thousands in their own homes, died out through a

change of fashion. It is, therefore, gratifying to find that a manufactory of a very interesting and special kind of porcelain has been established at Belleek, co. Fermanagh; and that Messrs. MacBirnien & Co. illustrate its characteristics very fully. It is not too much to foretell its success, if the spirit and enterprise which have brought it to its present position are maintained. In the examples exhibited are a considerable variety of forms, but we are not disposed to be over critical when the intention is so honest, even though it may not always be realised. A breakfast service, similar to one purchased by H.M. the Queen, is very elegant, and somewhat original in its treatment. The effect on a table would be undoubtedly most agreeable. Some of the flower-holders and shell-salts are very pretty; indeed, the material and the peculiar lustrous glaze is well adapted to the use of shell forms;

We engrave three examples of CURTAINS manufactured and exhibited

very successful result of an attempt, originated by these manufacturers

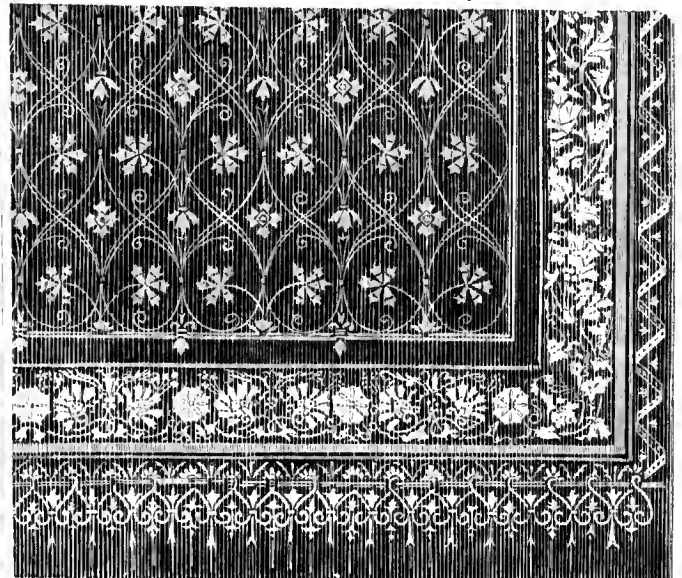
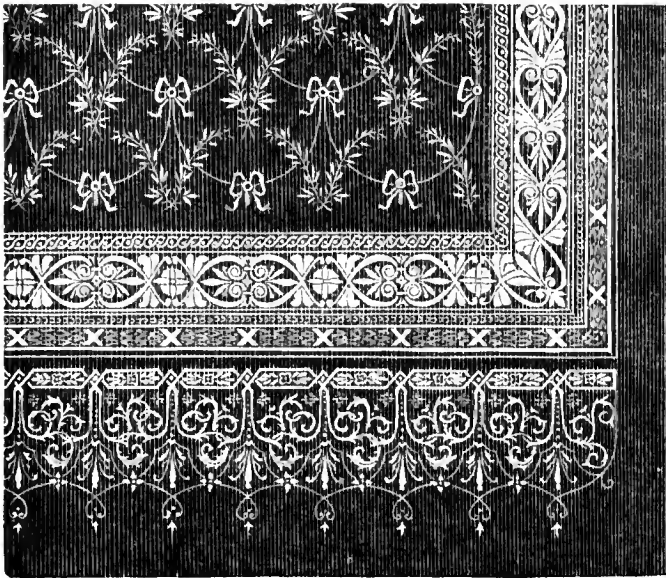

by Messrs. J. and J. S. TEMPLETON, of Glasgow, a branch of the eminent firm of James Templeton & Co. This class of curtains is the

some years ago, to weave the curtains as a *complete whole*, instead of attaching the parts, or border, by sewing—a marked and manifest

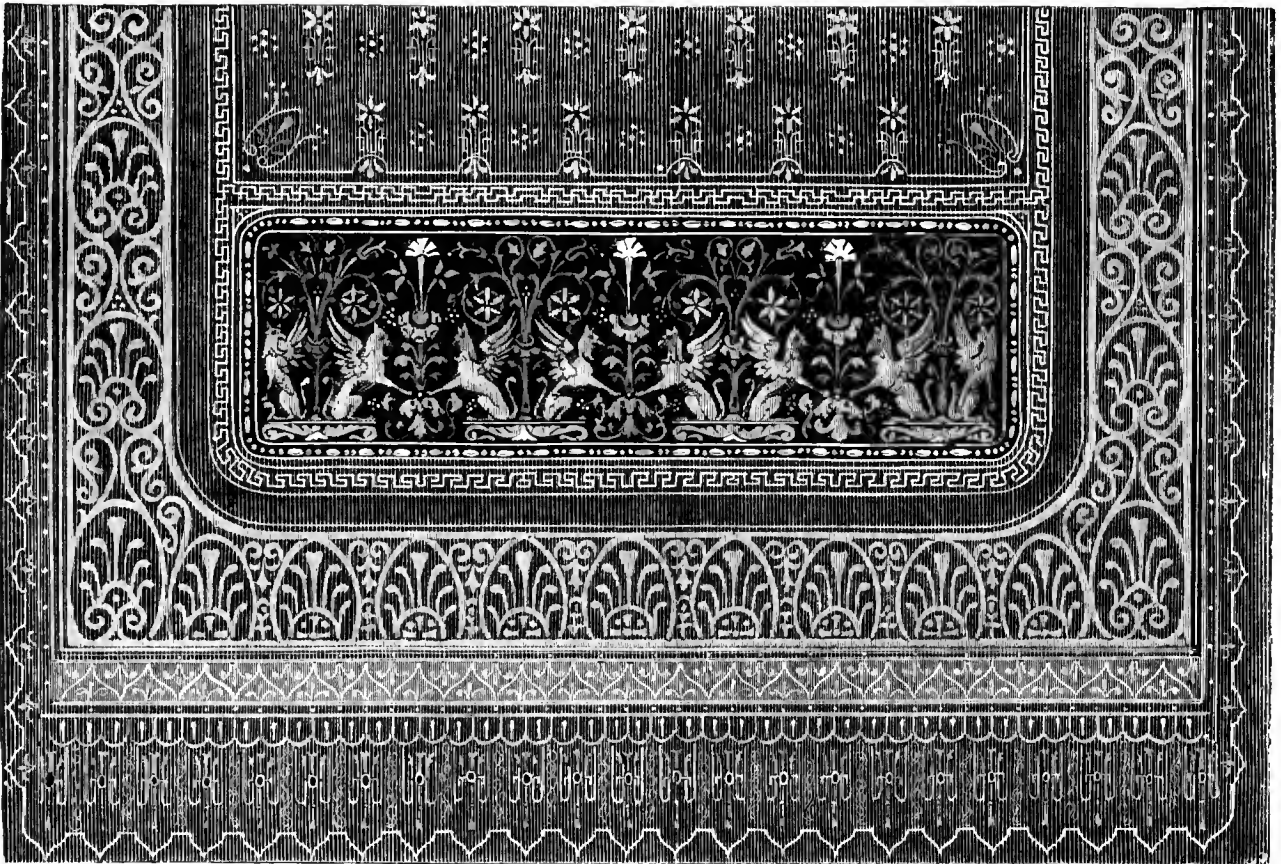

improvement. These curtains afford admirable subjects for graceful and effective designs, and for judicious and harmonious blending of various

colours. The artists thoroughly comprehend their work, displaying taste and knowledge, and rendering their productions valuable Art-teachers.

and a centre-piece of shells and sea-horses is very good, except that the base is unnecessarily heavy in treatment. The most successful examples, with the exception of the trays, are two *déjeuner-services*. The forms of the vessels are very novel and successful; and if the key-note struck in the treatment of these is followed up, much more may result than can at present be foreseen. The elegance and good taste of the tinted and gilt examples render them especially satisfactory, while the plain specimens do not at all suffer by the contrast. The trays are heavy in the form and treatment of the details, which are a little too naturalistic, when in contrast with the admirably conventionalised cups and saucers, not to mention the pretty teapot and cream ewer, so unexceptionable in every way.

So far we have treated of the contributions by manufacturers. The dealers who contribute do certainly not add in any very material degree to the illustration of the present position of this now wide-spread and important industry; and, with the exception of the example of etched decorations by Mr. W. T. Goode, exhibited in connection with Messrs. T. Goode's contributions, there is nothing which has not been fully illustrated by the manufacturers themselves. No doubt Mr. Mortlock and the Messrs. Daniel contribute admirable specimens of the wares it is their business to bring before the public as dealers; and they are entitled to credit for their enterprise and public spirit in supporting an exhibition like the present by their contributions.

Messrs. Phillips and Pearce, New Bond Street, exhibit a

From the case of JEWELS exhibited by Mr. JOHN BROGDEN we selected those that are engraved on this page. Mr. Brogden has

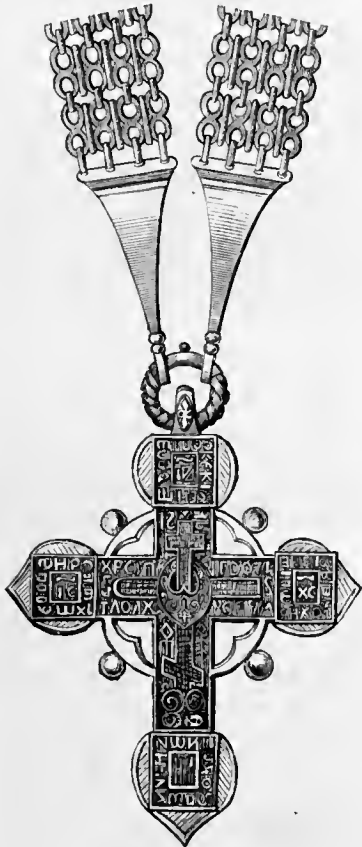

established high renown for the production of works that manifest taste, skill, and "learn-



ing;" generally they are original in design, but sometimes adaptations from the antique—from the masters who have left us models that

may be equalled, perhaps, but not excelled. Thus, among his reproduc-



tions, are examples of the genius of great artificers of Greece, Etruria,



Rome, Venice, Naples, Russia, and other countries; copies from precious

relics of past time—treasures of the several renowned museums of the world. Of some of these we convey an idea, in so far as form is concerned. The delicacy, grace, and



elegance, with which the gems are arranged—the colours harmonised and contrasted—and the refinement and finish of the workmanship, are conspicuous in this small collection,



as they were when Mr. Brogden exhibited largely at Paris in 1867, and obtained the strongly expressed "applause" of the critics and connoisseurs, as well as of the general public. The

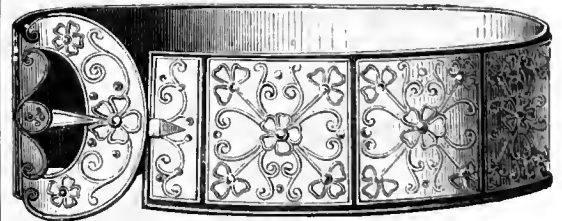

"honours" he obtained then and since have, no doubt, acted as stimulants: Mr. Brogden is a scholar in his profession, and his learning is shown in all the works he produces.

distinct application of porcelain, which claims attention, even apart from the fact that they are designed by Mr. Pearce. We have already alluded to the Wedgwood Trophy, exhibited in the English Fine Arts Gallery. Following in the same course, the contributions exhibited with the pottery and porcelain further illustrate a speciality of Messrs. Phillips and Pearce in table-decorations. A chandelier and candelabrum are both specially noticeable for their elegance in design and colour. The turquoise, white, and gold tell with great effect. The arrangement of the details of the sconces are very pretty, and thoroughly adapted to the material, but we cannot say so much for the pendent tassels, inasmuch as they are untrue to the material, and overweigh the chandelier with a metallic effect. Two or three tazzi in white and gold, and turquoise, white, and gold, are also very elegant and original

examples of their class. Their application to stands for cut flowers is well illustrated in the tazza and vase in celadon and white: itself an elegant object. A *jardinière* in white, turquoise, and gold, is also very successful alike in form, decoration, and colour.

The porcelain and earthenware exhibited by Bates, Elliot & Co., Dale Hall, Burslem, especially the specimens of coloured transfer-work, in which the tinting is admirably delicate and artistic, and the examples of Messrs. Powell and Bishop, of Hanley; Messrs. Brownfield and Son, of Cobridge; and Messrs. Pinder, Bourne & Co., of Burslem, all deserve much more detailed attention than space will permit us to give. It must be sufficient then to say, that while there is a decided improvement in the general character of the decorations, which happily is rarely over-

We engrave another of the very excellent works of Mr. WILLIAM WALKER, cabinet-maker, of London. It is a satin-wood WARDROBE,

"for a lady's boudoir." The distinguishing feature of this production is the ivory marqueterie, relieved with raised ivory carvings, designed

with much taste and executed with considerable skill. The centre compartment has two drawers, adapted from the wedding-coffers of the Italians.

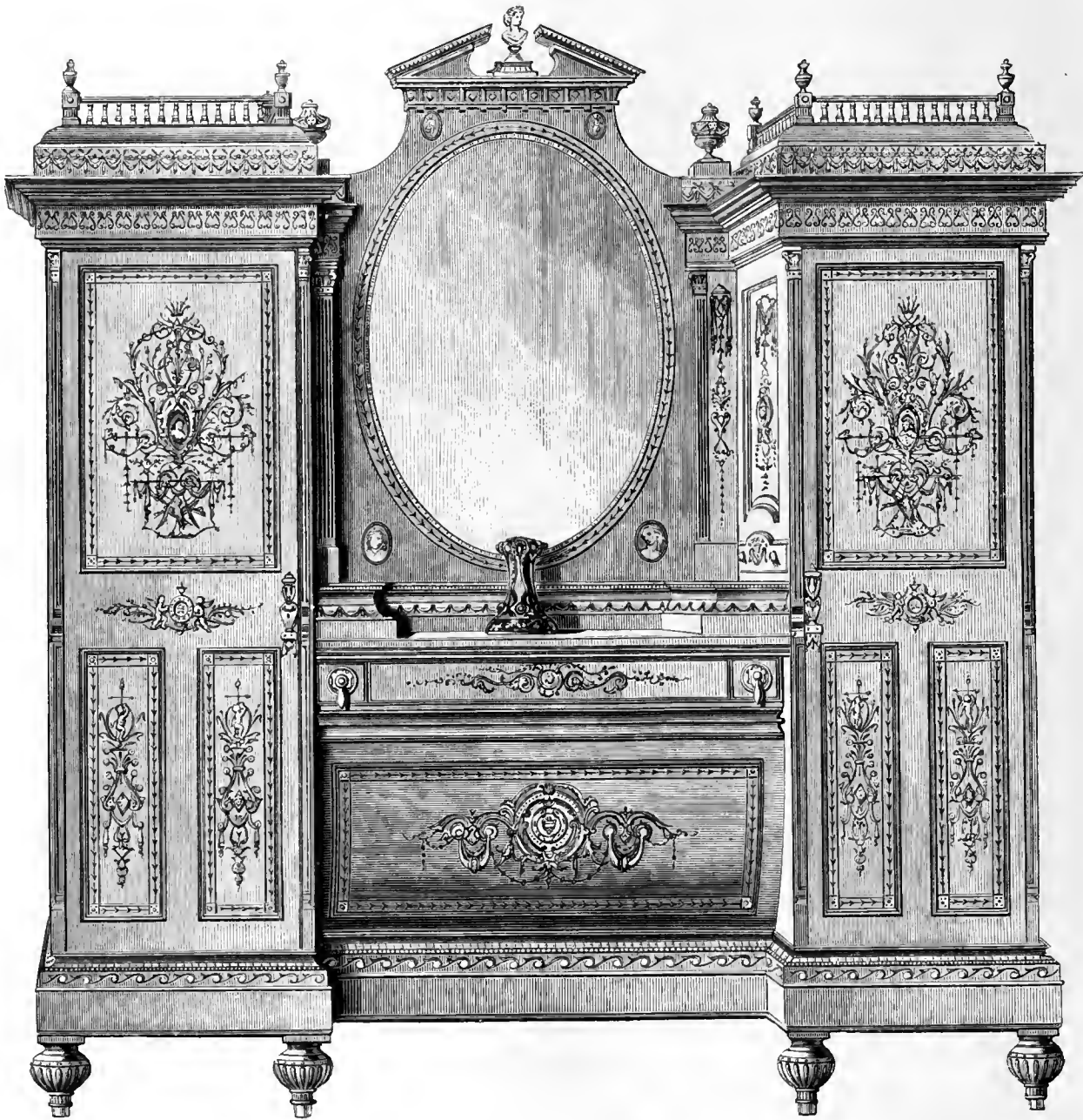

It is designed by Mr. R. CHARLES, an artist who has been often distinguished in the department of Art to which he has dedicated his abili-

ties. It is to be lamented that the example is not more frequently followed. As in all the productions of Mr. Walker, evidence is obtained of

good and sound workmanship: his establishment is in the heart of London, and he sustains the position "the City" has long held for cabinet work.

done, the quality and character of the ware is of the best class, showing that the potters of Staffordshire maintain their old position for the solid excellence of their earthenware for regular use." Some dinner-plates decorated with transfer-work designed by Mr. H. Sherwin, and exhibited by Messrs. Pinder, Bourne & Co., are the best articles of their kind in the Exhibition. Mr. Sherwin himself exhibited specimens of his skill as a designer and engraver for transfer-work in the International Exhibition of 1862. They were the most perfect things of their kind on that occasion, but received little or no attention. They have never been brought into the market, simply because they were too thoroughly what they ought to be to suit the dealers' notions. These now exhibited are not so good, but they are a clever compromise between sound ornamentation and popular notions.

We must now record our impressions of the very remarkable and useful display of stoneware and *terra-cotta*, in the production of which a very marked improvement has taken place, even since 1862. The application of sound principles of decorative design, especially in architectural details, is becoming more and more evident. Of course, there is still a good deal of the old leaven manifest in the ultra-naturalesque and pseudo-classic garden decorations, but these are certainly not in the ascendant on this occasion.

Of the foreign examples we must speak in connection with other ceramic products of each country.

In English stoneware nothing can surpass the small specimens of Messrs. Doulton & Co., of Lambeth. This remarkable series of useful and artistic articles in stoneware consists of jugs, mugs,

The works of Messrs. BATTAM AND

of which are of great excellence in form and ornamentation;

with the best productions of modern Art.



more especially such as are based on the old Limoges. They

are conspicuous among the best exhibits of the Ceramic Court; they con-

It should be recorded that several of them



sist almost exclusively of VASES, some

are correct in drawing, display judgment and taste, and vic

are purchased for the Museum of Berlin.

with or without metal mounts, vases, flower-holders, &c. The forms are admirable, and the decorations, whether incised or in relief, are always thoroughly well considered, and especially adapted to the material, the mode of production, and the use of the object. There are no affected imitations of antique types. The spirit of true design is caught with admirable perception and insight; and it is not too much to say that in Messrs. Doulton's case of stoneware in the Pottery Gallery there is not an article which can be deemed in any sense common-place. When colour is introduced it is done sparingly, and with a view to enhance the form of the object and the natural beauty of the material, rather than to conceal either the one or the other.

The chief portion of the works in fire clay *terra-cotta* are placed in the eastern arcades of the Royal Horticultural Gardens, and in

immediate connection with the pottery and porcelain in the galleries; Messrs. Doulton & Co. here exhibit a most important series of their current productions. The principal artistic work is a colossal vase—the Amazon Vase, of which an illustration is given. The body is admirably designed and modelled, but we cannot say so much for the stem and foot, which are weakened in appearance by an elaboration of detail. Some of the smaller vases of Messrs. Doulton are very good, and the garden-decorations are excellent examples of their class; but on the whole we think the architectural details are the most successful in point of good taste in ornament; while several of the roundels, large and small, modelled by students of the Lambeth School of Art, are bold and effective productions. A *terra-cotta* wall-fountain is an elaborate and well-executed specimen of the application of the material to

Messrs. JAMES TEMPLETON & Co., of Glasgow, hold high rank among manufacturers of carpets; they obtained first-class medals in all Exhibitions, and the gold medal at Paris in 1867. They have attained supremacy not only by due attention to manufacture, but by



obtaining the aid of true artists (for example, the first of the two carpets we engrave is designed by OWEN JONES), and they have

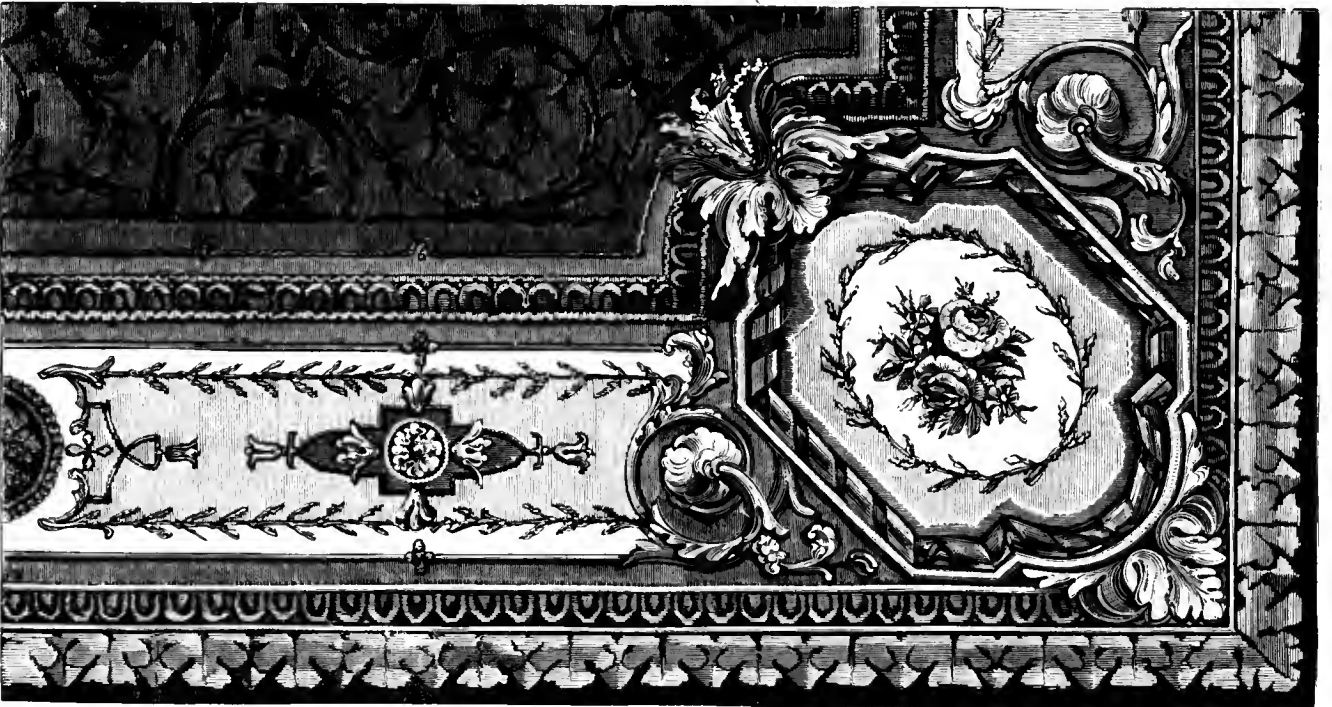

attained success mainly by adhering to correctness in design and colouring, and by associating quiet and simple "fillings" with rich and suitable borders. These carpets, the "patent Axminster," have the advantage that they are woven without seam to any shape of room.

this purpose, and is a triumph of manufacture in fire-clay. A portion of an arcade, and a window jamb and centre, the latter with incised decorations, are very excellent examples of sound ornamentation admirably executed.

Messrs. J. Stiff and Sons, Lambeth, further sustain the character of the Lambeth stoneware by contributions of useful domestic articles, architectural decorations, and enrichments, as also garden vases, &c., all thoroughly well manufactured. The Fulham Works, Baily & Co., are also ably represented, by excellent examples of domestic stoneware; but they have not much pretension to an artistic character, although of excellent make, glaze, and finish.

Mr. James Pulham, of Broxbourne, illustrates the application of *terra-cotta* to building purposes in connection with brickwork in

a very practical manner. The decorations of a window jamb and lintel, built into a section of red brickwork, are very simple and effective as architectural details. Two thin columns are excellent in manufacture and admirable in modelling and design. The contrast between the light red and the buff tint of the *terra-cotta* in one or two of the columns is very suggestive of varied effects. Some vases, a fountain,—the base of which is composed of tritons and dolphins,—and other examples suitable for gardens or conservatories, show the extent and variety of Mr. Pulham's productions.

Messrs. Standen and Marten, Nine Elms; Mr. W. J. Holland, Llanelly; the Whitwich Colliery Company, Coalsville, near Leicester, all exhibit good examples of architectural details. In decorative bricks the specimens in red clay, exhibited by Mr. G.

M. BARBEDIENNE is, perhaps, the most exten-



sive, and certainly takes rank among the foremost,



of the bronze manufacturers of Paris : his produc-

tions are always excellent, generally original, but occasionally based on the most approved of ancient models and the classic



periods of France. They comprise every variety of the art, clocks, candlesticks, candelabra, lamp-stands, mirrors ; in short, there is no object suited for production in



bronze, from the largest to the smallest, that does not issue from this establishment. They are the suggestions of a presiding

mind of high order ; but the best artists of France produce the designs and models, which are executed by the most accomplished of its artisans. On this page we give engravings of some of them,



selected almost at random, but all excellent in design : in fact, there is no article on the stall of this eminent manufacturer that might not be copied into our Catalogue as an example of pure and good taste.

Gunton, Cossey, Norwich, are decidedly the most ingenious and ornamental productions of their class ; and are, in every way equal to the best specimens of the Tudor era, as seen at Hampton Court and Hardwick Hall. The artistic application of red bricks to decorative construction is well illustrated by Mr. W. Cante, Farnham, Hants, to show the quality of his "rubbed" bricks. The design is taken from the cathedral of Crema, Italy, and has been erected by workmen employed in the buildings in progress at the South Kensington Museum, where red "rubbed" bricks play an important part in the structures being erected.

Messrs. R. H. Blanchard & Co., Blackfriars Road, London, exhibit a very excellent illustration of a highly decorative cornice, executed by them in *terra-cotta*, from a design by Mr. Edgar for the Wedgwood Memorial Institute at Burslem, of which he is the

architect. It is an effective and satisfactory piece of work in every respect, and shows the extent to which *terra-cotta* may be employed in architectural works of refined structure and the richest embellishments.

We have reserved our notice of probably the most perfect examples of red *terra-cotta* ware exhibited, so far as skill in manipulation and the perfection of the material is concerned ; and we regret that they are not shown as they ought to have been in a special glass case, placed side by side with the exquisite stoneware of Messrs. Doulton. We allude to the contributions of the Watcombe Terra-cotta Company, near Torquay. In these specimens the application of the finest possible quality of material in red clay is illustrated in a most exhaustive manner in two groups of flowers, arranged in flower-baskets of the same material. The manipula-

The object engraved on this page is, perhaps, the most remarkable of all the examples of Ceramic Art contained in the Exhibition, and has certainly attracted universal attention; we believe the British manufacturers of porcelain have accorded to it the palm of excellence. It is an oblong decorative *plateau* for the dinner table, for fruit, flowers, and candles, formed of

jasper porcelain, style Louis XVI., designed by Messrs. PHILLIPS AND PEARCE, of New Bond Street, manufactured for them by Messrs. WEDGWOOD AND SONS, of Etruria, and is a choice and perfectly unique specimen of their famous ware. The piece engraved forms the centre group, having a smaller one at each end, standing on a sheet of silvered plate-glass, with



a narrow trough for flowers running all round, and surmounting a frieze, enriched with proces-

sional figure-groups, after FLAXMAN, &c. The work speaks for itself by its severe elegance,

lightness, purity, and adaptation to its purpose. It is readily taken to pieces to be cleaned, &c.

tion and imitative reproduction is equal to the finest examples of flowers in biscuit-porcelain, and thus the perfect comminution of the particles of the material is proved, and the character of the clay as a "body" demonstrated at once. The flower-pots and water-bottles with enamelled decorations are all of excellent form and skillfully executed, not only as regards the objects, but in the tasteful character of the ornamentation. One large jet vase is an excellent example of its class, alike in form and surface glaze. A few good busts, roundels, and bas-reliefs, still further illustrate the excellence of the clay as a material; but the larger exhibits of the Watcombe Company are to be found in the arcades of the Royal Horticultural Gardens, with other large examples of *terra-cotta*. These consist chiefly of an important series of garden-decorations, vases, flower-pots, a long *jardinière* for windows, all admirably

modelled. There are also some well-designed key-stones for arches or window-lintels with incised decorations. The ornamental features of all these works are thoroughly well considered in adaptation to the uses of the objects decorated. With the smaller examples of the Watcombe Company, as being exhibited in the ceramic gallery, we may mention some artistic examples in red clay, designed and modelled by Messrs. Wills Brothers, as they have escaped attention at an earlier period. They are a boldly and effectively treated series of small vases, &c., a little rude in some points, although very suggestive in style. There may, however, be an affectation of free finish, without the result being so intelligible as it ought to be, which every true work of Art really is; and we could have wished that the excellent general forms had been supplemented with more care in the subject details.

The contributions of the renowned firm of

therefore, known throughout the world. It is needless to state that they have won the highest



CHRISTOFLE & Co., of Paris, are of great excellence, whether in the precious metals, or as "elec-



tros," which derive their value solely from Art. That Art is invariably of the first order, admirable



in design and perfect in execution; the best artists of France, and the most finished of its artisans,



being engaged in their production. The name is,



honours at the Exhibitions since 1851. We have given engravings of their works in all the Catalogues we have issued. Those on this page are from examples that uphold their reputation.

FOREIGN POTTERY AND PORCELAIN.

After the very remarkable display of British pottery, &c., the perfection of which can only be realised by a most painstaking examination, but which impresses us more now that the work of examination is over than at the beginning; we are compelled to express disappointment with the very inadequate representation of our continental neighbours. As a national display, the ceramic section of the Exhibition is a triumph in every way. Internationally it is not the success we could have desired, but it is, after all, more than in the circumstances of the past year we had a right to expect. It must, therefore, be taken with all its shortcomings; and the unavoidable and unforeseen causes of meagre and unequal contributions should be borne in mind.

FRANCE.—In ordinary circumstances France would have stood next to England in the display of porcelain and *faïence*, but with Sèvres absent, and important private producers also, the representation of the ceramic arts and industry of that country is, with a few exceptions, unrepresented in its highest phases. M. Deck contributes some admirable examples of painted plaques and *plateaux*, executed in that free style of pencilling and brilliant harmony of colour which always attracted attention to his products in previous exhibitions. Some of the vases contributed by him are excellent in style and decoration. There is nothing, however, which adds to our previous high estimation of M. Deck's productions, or to the sum-total of knowledge in relation to ceramic design. The lustre-porcelain of M. J. Brianchon is fairly represented,

Of the many works of rare excellence in Terra-cotta, exhibited by Messrs. DOULTON & Co., of Lambeth, we have engraved a Fountain; on

lities of the well-known firm. It is called the Amazon Vase: the figures are borrowed from



this page we give engravings of other of their productions—two VASES of the ordinary class,



a PLAQUE for "letting into" places where such objects are required, and a large VASE of great merit—manifesting, indeed, the large capabi-



a sarcophagus found near Ephesus, but the vase is both designed and modelled by Mr. GEORGE



TINWORTH. The work is of large size, nearly 6 ft. in height, and is admirably suited for "grounds."

and a certain advance in the manufacture is evident since 1867. The small examples, however, are still the most satisfactory in form and colour. A *déjeuner* service is very elegant: a large centre-piece, in a fountain-like form, is a striking example of the application of this style of porcelain to the production of large works. On the whole, however, we think it best adapted to the smaller objects.

M. Jules Houry, of Paris, exhibits some very striking specimens of enamelled *faïence*, generally highly ornate, and well adapted to ordinary demand, but not rising to the usual standard of high-class works. He also contributes a varied series of reproductions of Nevers and Rouen ware, really excellent as imitations; but this is their highest quality.

M. Jean, of Paris, has a very fine display also of imitation

Nevers and Rouen ware; some of the larger examples—vases, centre-pieces, and a clock, together with some *plaques* and *plateaux*—are exceptionally good examples of their class. The treatment and colour are thoroughly ceramic in style, that is to say, there is no attempt to force the effects in the direction of the ultra-pictorial,—a decided mistake in principle, whatever may be the result in other directions.

The examples of French *faïence*, exhibited at Paris in 1867, by M. E. Rousseau, Rue Coquillière, Paris, were of such a character as, unfortunately, to raise expectations in association with his name which his display in the present Exhibition provokingly disappoints; so much so that it would have been almost better to have been absent altogether. The few *plaques* illustrating a speciality of his, a bold kind of *pâte sur pâte*, a series of vases imitative of

We have engraved examples of Hearthrugs manufactured by Messrs. H. R. WILLIS & Co., of Kidderminster; we now give four speci-

to the arrangement of the whole. The productions of this eminent firm are in great variety; they are renowned for superiority and soundness of

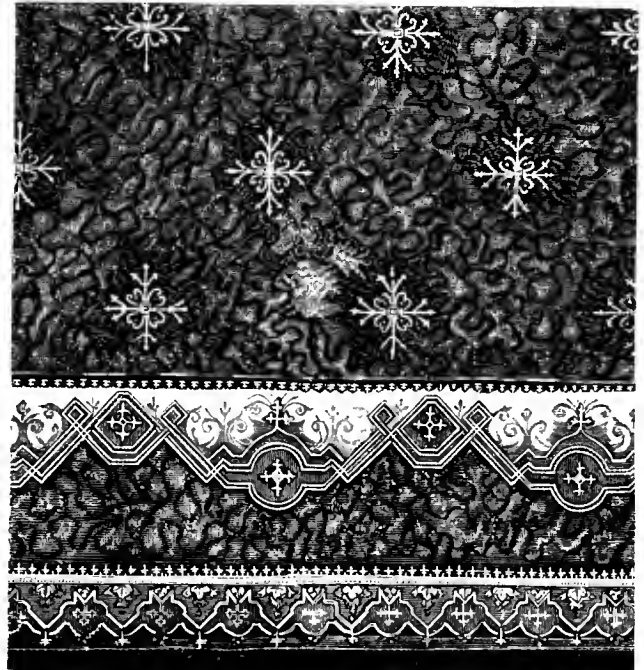

mens of their CARPETS. They are all "Wiltons, five frames with

materials, and for purity of design, holding high rank among the most

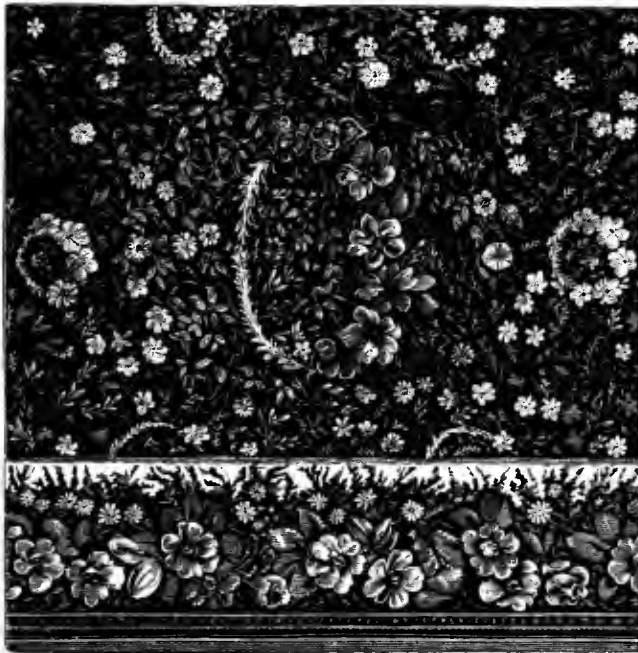

borders." The base of the composition in three of those we have selected is moss, which throws up the flowers, giving brilliancy and yet harmony

excellent as well as the most estimable carpet-manufacturers of the kingdom, and successfully competing with the best issues of the Continent.

Japanese details, without the colour; and a variety of earthenware for ordinary use, painted with fish, insects, birds, &c., similar to some novelties introduced in 1867, are a very inadequate representation of M. Rousseau's usual productions.

Ordinary examples of commercial *faïence*, together with a large collection of imitation Rouen ware, are exhibited by M. L. Ernie, Paris. These latter have all the characteristics of the old Rouen productions.

Other exhibitors also contribute collections of good specimens of imitation Nevers and *Faïence de Lorraine*. Many of these are quaint and interesting reproductions, and as such will have an interest with the collectors of historic pottery—but they add nothing to the Exhibition as a lesson, except in some instances as to what to avoid.

In the few, unhappily very few, examples of French *terra-cotta*, we have the true *esprit* of French plastic art. Two spirited busts by Carpeaux are excellent examples of free treatment, very clever in manipulation and happy in expression. One is a reproduction of the head of a nymph, in a bas-relief from the Pavillon de Flore, at the Tuileries, of which a copy in plaster, coloured to imitate *terra-cotta*, is also in the French division.

In the picture-gallery of the French Annexe, a small bust of Stella, by Eugène de la Planche, is excellently modelled. The child-like expression and repose of the whole is rather exceptional in French Art. Two spirited examples by Itasse, 'La Clef des Champs,' and 'Le Sabot de Noel' are full of the best characteristics of the French school of modelling, and deserve the especial attention of students as lessons in freedom of treatment and

T

We engrave another of the excellent contributions of Messrs. COLLINSON AND LOCK, a CABINET of satin-wood, designed

tion being enclosed by two doors, in which some very excellent marquetry work is inserted. The

ends of the upper part are richly panelled, and four charming little paintings are introduced, re-

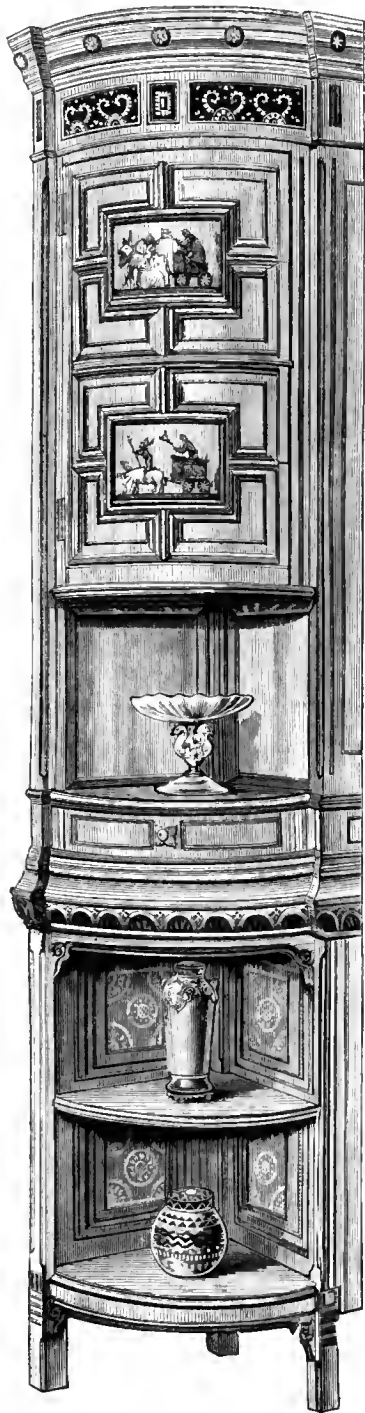

by M. TALBERT; it is inlaid with woods of various colours, and partly gilt. The lower part has open ends, the centre por-

presenting the Seasons. These were executed by Mr. ANDREW B. DONALDSON. The two centre doors of the upper part are divided prettily by gilt

wood bars, fitted with bevelled-edge glass. The cabinet is not only original in design, but also an admirable example of sound Art-workmanship.

accuracy of drawing in clay. A smaller work by the same artist, 'Le Jour et le Nuit,' composed of two *amorini*, is equally effective, while there is more finish in the details.

We deeply regret that France is so imperfectly represented in ceramic art, but the fact must be taken as it stands, in the hope that in happier circumstances a more perfect illustration of an important speciality will compensate for the want of it on this occasion.

BELGIUM.—The Belgian contributions consist of some very artistically-painted vases and *plateaux*. The most important works are painted by A. de Mot and E. Fourteau in an exceedingly bold and free manner. The pencilling and treatment, as also the tone of colour, are in the style which M. Lessore has made familiar in England. A small oval *plateau*, with a finely composed Holy

Family in the centre, is an excellent specimen of De Mot's manner. The whole of the works show high artistic power, and one large *plaque* by this artist, exhibited in a frame near the glass-case, is a fine example of academic treatment of the human figure. It is an admirable specimen of vigorous drawing and perfection of glaze in colour; the sweep of the brush in the handling is very suggestive of a treatment which we should be glad to see our English painters emulate more frequently.

PRUSSIA.—The Royal Berlin Porcelain Works contribute some excellent examples of its current productions as a State manufactory. One glass-case is entirely filled with admirable works in biscuit-porcelain of great purity of texture and colour. A *jar-dinière*, elliptical in form, with a *chimera*-mask on each side, supported by a merman and mermaid, with masks under the handles

The ROYAL PORCELAIN WORKS AT



WORCESTER, directed by R. W. BINNS, F.S.A. supply us with materials for an-

tributed from this fertile source, for they are all of great excellence,



competing with the very best that have been produced in England or in France. It is not surprising that the cases of this firm have

articles—of luxury or necessity—issued by these Works deserve the



highest commendation that could be accorded them. The merit of these



other page: we might, indeed, with advantage, engrave all the works con-

attracted universal attention and excited intense admiration. Our selections have been in a great degree limited to vases; but all the

admirable paintings on porcelain is accorded to the artist, Mr. RUSHTON.

flanked by lizards, the handles themselves being surmounted by a serpent coiled round them, is a very bold and effective piece of ceramic design, admirably modelled, and finished with excellent effect. The design is essentially German in character, but there is more freedom than usual in the treatment. It is supported by an ebony-stand, designed and carved in the spirit of the object itself.

A group of 'Moses, Aaron, and Hur,' is a very classical treatment of the subject. The figure of Hur is especially fine in conception and treatment. A figure of Penelope is not above the average in Art-quality of good Parian statuettes, as produced in England.

Some portrait-busts of Prince Frederick William, Bismarck, and Moltke, are treated with great skill. The first-named is especially good as a bust. A jug, with a medallion of the Empress-Queen

Augusta, and a vase and cover are not equal in Art-quality to the other works.

A series of vases, elaborately ornate in character, are painted with considerable artistic power. A suite of these vases, which appear to have been named "Victoria," in honour of H.R.H. the Crown-Princess of England, are very able examples of flower-painting, freely handled, and pure in colour. The imitation-gilt metal-mounts are well designed and modelled, but are none the less false in principle on that account. A centre-piece, which accompanies a pair of vases decorated with roses, is admirably designed and still more admirably painted, and deserves special attention as a lesson in the treatment of that frequently-painted, but often much-abused, flower.

A series of *amphora*-shaped vases, deep blue, gold and white,

We engrave two of the SHAWLS, and one example of the LACE, con- out Europe and in America; there is no establishment that has produced



tributed by Messrs. VERDE DE LISLE & Co.—the “Companie des Indes”—of Brussels and Paris. The firm holds the highest rank through-

works more perfect: they are models of grace and beauty, and exquisite as specimens of the art. In 1867 the firm had many competitors, in 1871



it has none. The same artistic skill is manifested in the shawls. There is

nothing of the class in the International Exhibition to compete with them.

with gilt handles and feet, decorated with imitation enamels in the Limoges manner, are very tasteful in effect, but they are wanting in the bold relief of the English specimens exhibited by the Worcester works and Mr. Battam.

We must conclude our notice of the Prussia Porcelain by simply recording that the examples, filling a glass-case of imitations of old Dresden ware, are interesting, as showing how thoroughly the Berlin works can reproduce historic types of this class, all executed with skill, and rivalling the best Dresden in the purity of the body.

In *terra-cotta* the examples exhibited by Ernest Marche and Son, Charlottenburg, near Berlin, are of the first class, alike in yellow and red clay. In the latter, the decorative architectural details

suitable for window lintels, arches, &c., are admirably designed and modelled, as are some roundels, *paterae*, and brackets. Two columns, also in red clay, one Classic, the other *Renaissance*, in design, together with a highly-decorative stringcourse, are remarkable as examples in every sense. A statuette, intended to represent Goethe, but, we should suspect, modelled by a French sculptor who has lost the character of the original, and disguised him as a French *savant*, is an excellent specimen of *terra-cotta* work, however deficient as a portrait. Another application of *terra-cotta* to the higher purposes of sculpture, is shown in a figure of a seated angel. This work shows a perfect mastery over the material, in its application to the figure. A decorative panel of large size, having a very cleverly-designed and executed

The collection of Art-works in bronze and marble, exhibited by M. CORNU, of Paris,

rarely or never found in England; and his productions manifest the value of training and study

to attain pre-eminence. The *spécialité* of M. Cornu is the application of the onyx of Algeria



to articles of commerce. Taste and judgment | artist-manufacturer thoroughly understands; few are essential to regulate the union, and that the | of the *objets de luxe* contributed by France are



attracted large and merited attention. He is the artist as well as the manufacturer, a combination

so excellent as those he exhibits. We have engraved some of them; they suffice to show the

beauty of his productions, and to convey an idea of their rare merit. They are in great variety.

alto-relievo in a central roundel, with flat ornaments on an incised brown clay background, is a remarkable example of its class. The treatment of the whole is very architectural, alike in the details as in the general effect. It is also very suggestive, and deserves the special attention of all engaged in the production of decorations in *terra-cotta*. A few good vases, and some smaller architectural details, make up this very satisfactory illustration of German *terra-cotta* work.

DENMARK.—The Danish contributions are most characteristic, but there is no evidence of any special advance upon works shown in previous exhibitions; except, perhaps, that the colouring, never carried too far, is even more subdued than usual. The specimens exhibited by the Royal Porcelain Manufactory at Copenhagen are excellent in taste as regards decoration, the

quality of the porcelain being very fine, and the make skilfully managed. The forms, too, of the useful articles are all good. A breakfast-service, having a ribbed surface decorated with a free treatment of pencilled scrolls in blue, is especially noticeable for its simplicity and purity. A few egg-shell examples are also noteworthy. A good series of examples of statuettes in biscuit-porcelain, are evidence of skill in this direction. They are generally well modelled and perfectly "fired."

Messrs. Bing and Gröndael, of Copenhagen, exhibit largely, and in considerable variety. Their statuettes and *plaques* in biscuit-porcelain are good examples of their class, alike in modelling, purity of body, and texture. They are generally well adapted for reproduction in a vitreous material, which is not always the case with Parian and biscuit-porcelain figures. The influence of

We give on this page an engraving of one of the most recent productions of Messrs. JAMES TEMPLETON & Co., of Glasgow. The CARPET—"patent Axminster"—is brought out in drab ground, with border, corners, and centre in white; the flowers and festoons in natural

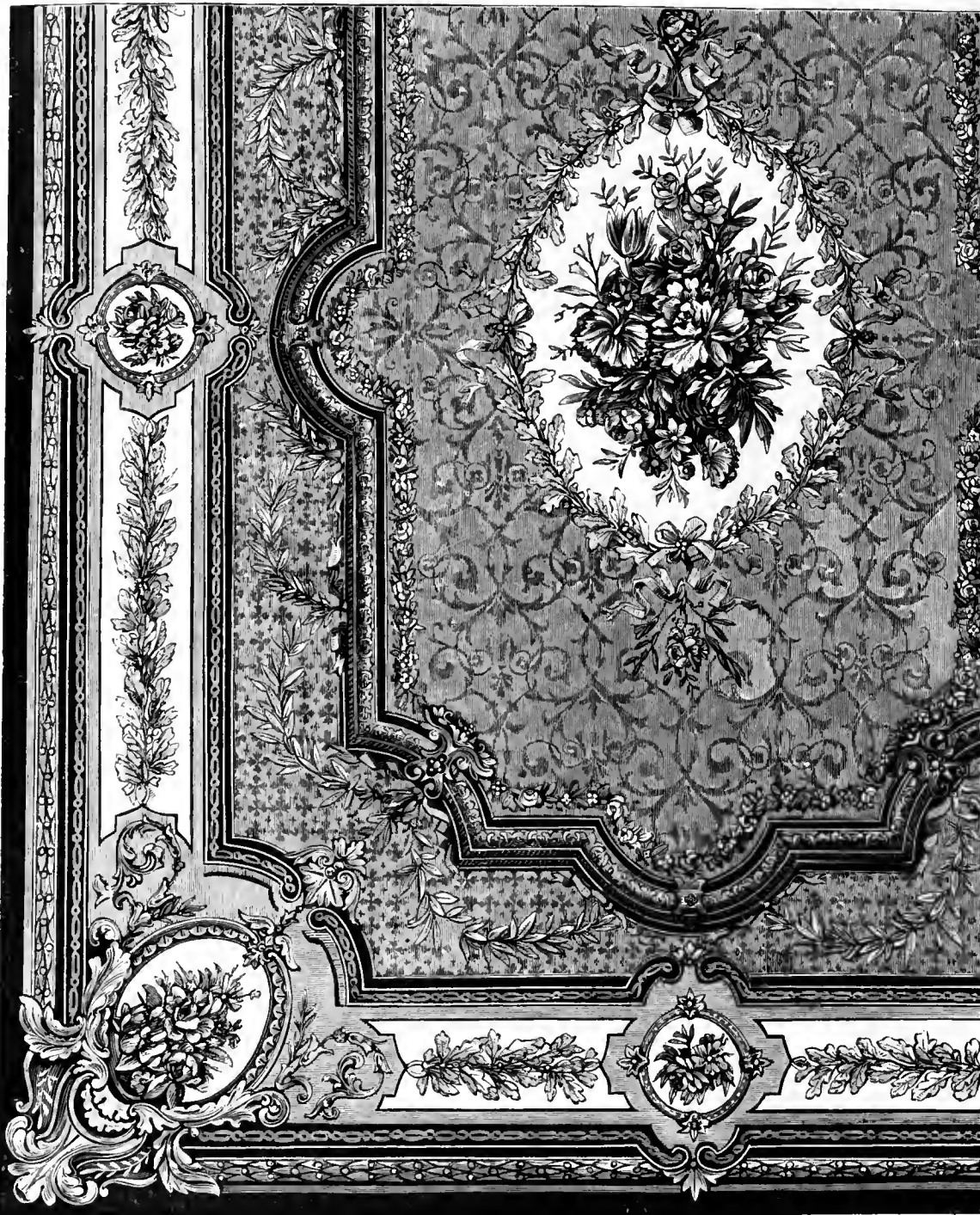

colours, and the ornamental work in quiet golds, all softly and harmoniously blended. These carpets are woven, without seam, to any shape

and size of room; sometimes they are of enormous length and breadth. To Messrs. Templeton we are largely indebted for evidence that

this country can successfully compete with the best efforts of foreign fabricants—not only in execution, finish, and material, but also in design.

Thorwaldsen is very marked, for the best of these Danish works are reductions of his statues and bas-reliefs, and it is well that works of so much purity in design and good taste in plastic art find their way by these means into the houses of the people.

The coloured, painted, and gilt examples of porcelain, exhibited by Messrs. Bing and Gröndaël, are generally good, and are sometimes very suggestive of purity of treatment and harmony of colour. In some instances, however, the ornamentation is overdone, and the forms are not always so well considered in relation to utility as they might be. This firm exhibits a few specimens of fine porcelain cups and saucers, with the ribbed surface and blue running ornament similar to those contributed by the Royal Porcelain Manufactory, but the decorations are of a more refined character as regards treatment of the details.

Reproductions and revivals of Etruscan design in the form of vases of *terra-cotta*, &c., are well illustrated by a series of interesting examples contributed by Mrs. R. P. Ipsen. The forms are in almost every case successful copies of the antique. Mrs. Ipsen also exhibits a few *terra-cotta* statuettes, fairly treated, but not calling for special notice.

SWEDEN.—Messrs. Roostand & Co., of Stockholm, contribute characteristic examples of painted and enamelled earthenware, somewhat rudely coloured, but of good quality of body and make. Some *Maiolica* vases are well designed, and the colouring in tertiary tints is harmonious, if rather cold. A black glazed earthenware jug, with painted flowers in white enamel, is admirable in form and treatment. A few specimens,—for example, a large two-handled bowl with ladle, and a cigar-ash box, designed

The several objects on this page illustrate the variety of MINTON & Co.'s productions. The two Persian TILES at the top are admirable for

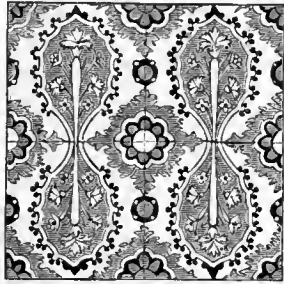

wall-decoration. The Greek VASE, in *pâte sur pâte*, is one of the works of the eminent artist, M. SOLON; as is also the small BOTTLE. The

VASE WITH CUPIDS is a very fine specimen,



remarkable for the softness and brilliancy of its

colour. The decoration is original, and Mr. YAHN, the artist, is entitled to great credit. *Pâte sur pâte* was the only process which had

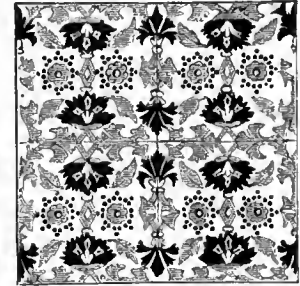

not been tried in England; and it was a fortunate circumstance that Minton & Co. were able to secure the services of M. Solon; it is also a



matter of congratulation that he could find in their establishment new



materials, which even surpass those used in the Imperial Manufactory.

and decorated after the old Scandinavian manner, are very interesting and suggestive. Our friends of the Belleek Pottery might take a hint from these, and utilise the Keltic ornaments and forms so characteristic of early Irish Art.

In porcelain Messrs. Roostand & Co. also contribute a few clever examples. A vase and cover, in which biscuit is admirably treated in the decorative details, and the skill with which the flowers are wrought, almost reconcile us to the ultra-naturalesque method. A few plates, generally good, but less ambitious in design, are the best; they complete Messrs. Roostand's display. The flower-painting in some of these plates is very freely handled, and excellent in colour.

The Gustaffsberg Company exhibits Parian figures, well

designed and modelled. A statuette of Charles XII. is very spirited and characteristic. The costume is admirably treated. Another statuette of a Neapolitan Fisher-boy is a fine example of its class. A fountain and a card-stand, also in Parian, are good specimens of skill in the production of such works.

SPAIN.—The Spanish pottery is confined almost entirely to that in use by the common people. Full of character, which is always more or less suggestive of its Moorsque origin, there is considerable interest attached to some of the examples; and the contents of the two glass-cases contributed from the South Kensington Museum certainly illustrate a phase of historic pottery which ought necessarily to form a part of a national ceramic collection. In addition, however, to these, the Commissioners of the Exhi-

We have engraved some of the works of the renowned firm of CHRISTOFLE AND Co.; we engrave others; from their extensive, interesting, and highly-meritorious collection we might have

successive exhibitions it has been our privilege to make it better known in England. The sub-

enamel applied to objects of ornament or of utility—or, rather, of both—for into all the pro-

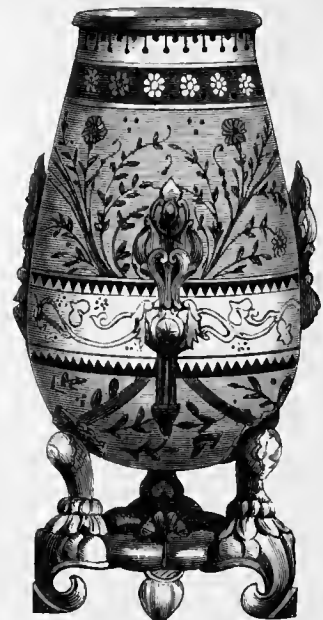

jects which adorn this page are examples of productions of this establishment Art enters as the



selected very many that would do honour to the eminent manufacturers; the name is familiar throughout Europe and America: the fame of "the House" was established long ago; in

first and most essential part. The designs are furnished by the best artists of France; and the objects themselves are of exquisitely finished workmanship, the artisans being artists also.

tion exhibit a series of red *terra-cotta* examples, the characteristics of which are as decidedly Roman, in form at least, as the enamelled ware is Moorish.

PORTUGAL.—The specimens of Portuguese pottery are characteristic illustrations of *Maiolica*, treated with exceptional boldness, approaching, in some instances, to rudeness, but always intelligent, and with a thorough adaptation of means to ends. Here we have no affectation in the way of imitation of other periods or countries, on the one hand, or any compromise with modern refinements in modelling, on the other. The ducks, fish, dogs, and cattle represented are all treated with a certain unsophisticated Art-power which is quite refreshing. The colour is always rich and harmonious, varied, but never carried to extravagance; and in this direction we have a wholesome lesson to the producers of similar

ware; at the same time, we should be sorry to see ultra-imitations of these works attempted; it is rather the spirit in which they are conceived and executed that it is desirable to emulate.

Mr. G. Maw lends a series of Portuguese wall-tiles, which are characteristic examples of a rude but perfectly legitimate treatment. They are almost primitive in their method, and in the simple details of which the decorative parts are composed; yet the effect is far from being unsatisfactory.

ITALY.—With the exception of an interesting contribution of Italian pottery from the South Kensington Museum, the only representative of ceramic art from Italy is a small series of examples of *Maiolica*, more curious and characteristic than beautiful. None of them call for special notice. Among the objects from the National Museum, the whole of which formed part of the

Messrs. W. and J. R. HUNTER, eminent upholsterers of London City, exhibit a TOILET TABLE of graceful character, sound and substan-

tial workmanship, and ornamented with much taste; its principal decorations being the *plaques* of Wedgwood. It is of Hungarian oak, with

panels of harewood. As with many of the articles of British upholsterers, much attention is given not only to finish, but to convenience, in the



construction of drawers, and in the multiplicity of arrangements which supply facilities at once

elegant and useful. Messrs. Hunter have long held a prominent position among manufacturers

of the Metropolis; in this work they fully sustain it. It is designed by Mr. G. W. FAIRBANK.

Italian pottery sent to the Workmen's International Exhibition of 1870 by Signor Castellani, of Rome and Naples, are some admirable forms, very suggestive in many points. They were collected by Signor Castellani with a view to present them to the South Kensington collections; and this was done after the Workmen's Exhibition closed.

Italy contributes no *terra-cotta*, but a bust of unfired clay, modelled by Erneste Salari, a young Italian artist now in London, is a remarkable example of originality and power. This bust is life-size and to the waist. It represents a laughing gipsy, or Bohemian, with hat and feather; it is full of character and expression. The handling is vigorous and unconventional, and although *naturalistic* in treatment, it is not objectionably so—the character of the material and mode of production being most intelligently

borne in mind by the executant, who, it is to be hoped, will apply his ability to similar works in connection with some of our more enterprising potters.

HUNGARY.—The Hungarian exhibits consist of a collection of plates, cups and saucers, a few flower vases, and a *déjeuner*-service, contributed by Moritz Fischer, of Farkashawa. They are chiefly good imitations of Oriental designs, the enamel and colours being exceptionally good. There are one or two remarkable reproductions of old Chelsea designs, but nothing specially suggestive is to be seen in any of the specimens; except that they show how skilfully the best effects of the pottery and porcelain of the past may be imitated, even to absolute reproduction.

AUSTRIA.—No porcelain has been sent from Vienna, but an interesting series of examples of domestic pottery, manufactured at

We associate with one of the principal works contributed by MM. FANNIERE, Frères, renowned goldsmiths of Paris, some of the lesser, yet graceful productions of M. PHILIPPI, his representative in London, and also a goldsmith and jeweller of Paris. The former is a



RACING CUP of silver, charming in design and execution. The eminent

contributed by them (aided by experienced artists and artisans) go far to

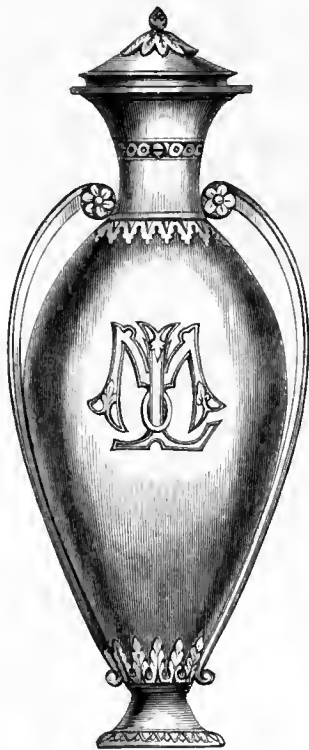

artists, MM. Fanniere, hold the highest rank attainable in their country,



having been decorated by the "Emperor," and received

for them. We are in-

debt to MM. Fanniere for efforts to maintain the supremacy to which



honours at all the Exhibitions where they have competed

debted to MM. Fan-

France lays claim; and it is certain that many of the works



uphold the position the great Capital of Art has occupied during the century.

Inznaim, is exhibited by A. Klamurth. These are very original and suggestive in their form and treatment, and convey a lesson by which we trust English producers of pottery will profit. The ware is of brilliant and warm cream-colour relieved with brown. The designs, though simple, are artistic without pretension—the decorative details appearing an essential part of the form of each vessel. These forms are admirably adapted to the use of each article, and, with the decorations, are practically suited to the exigencies of the material and mode of manufacture. As examples of common pottery they are the most original things of their kind in the Exhibition; and the most tasteful too, in the best sense.

A series of blue and white ware, contributed by F. Slowake, further illustrate the production of Inznaim. They are such forms and decorations as might have been produced in England 200 years ago.

The application of *terra-cotta* to decorative purposes is admirably illustrated by V. Brausewetter, of Wagram, in a series of well-executed statues and statuettes suitable for gardens and conservatories, together with vases, all of a classical type. These, with some details of capitals, brackets, portions of mouldings and string-courses, constitute an important display of Austrian *terra-cotta* work, as adapted to garden and architectonic decorations. The colour of the fired clay is a peculiarly rich and warm fawn tint, several shades deeper than any of the English specimens, which look somewhat "chalky" by comparison. Its texture is very close and firm, and the firing has been skilfully managed.

Here we must close our detailed remarks upon decidedly the principal feature of the present Exhibition in its industrial aspect. Space will not permit us to do more than mention that a collection

ROBERT MINTON TAYLOR, of Fenton, near Stoke-upon-Trent, is an eminent and extensive manufacturer of TILES: the Art he applies to

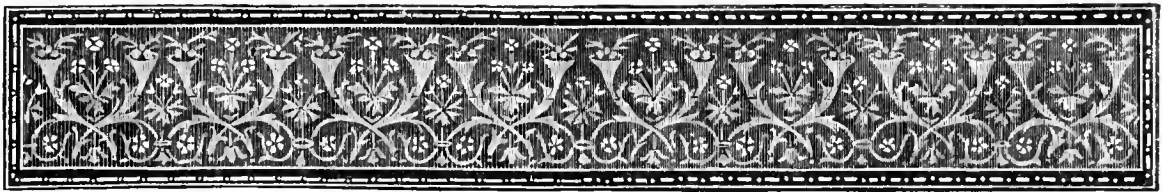

them is of the best order, and in material, substance, and enduring qualities, they are surpassed by none. The designs are of the highest

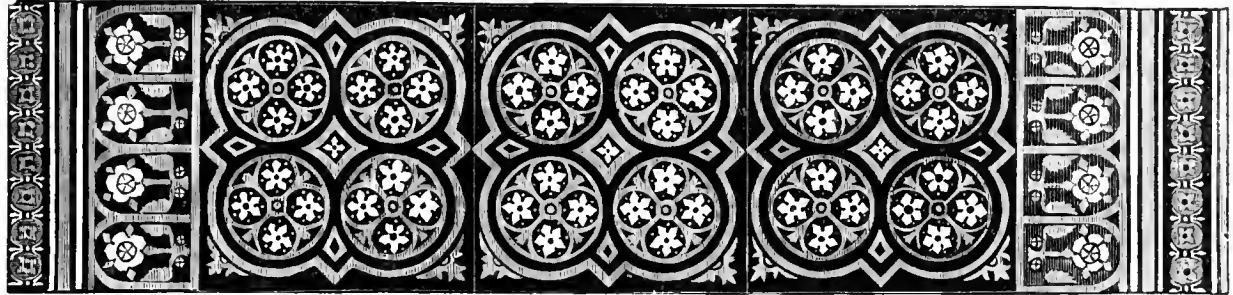

excellence; as our examples show, they are of all classes and orders, for exterior and interior use and decoration—for halls, corridors,



conservatories, and, more especially, for churches. But the common kinds, for out-door positions, are also of much merit, often graceful, and

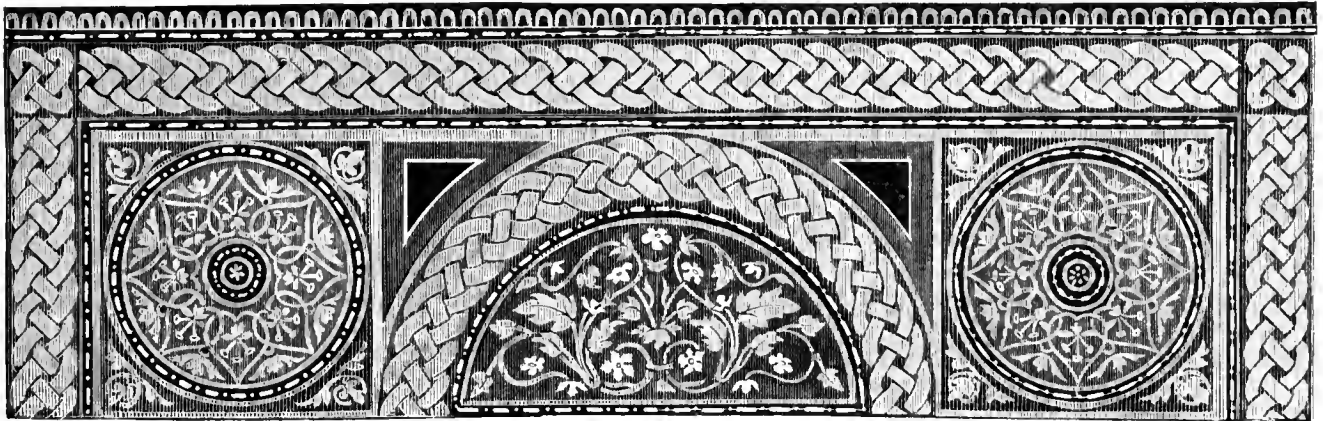

always appropriate, and harmonious in contrasts. They obtained at the Exhibition the strong approval of critics. Of the designs here shown, the first and fourth are by Mr. GEORGE EYRE, the second by Mr. JOHN GIBBS, of Oxford, and the third by Mr. E. WELBY PUGIN.

of ordinary pottery in use by the common people of various countries forms an interesting feature of the display; and it is to be regretted that something of this kind was not attempted in England many years ago, when more primitive examples were in the course of production. As it is, a very fair beginning has been made, which we trust may be further extended, either by her Majesty's Commissioners or by the South Kensington authorities.

We have not alluded to the examples from Japan or China, nor to the ruder specimens from Egypt and North Africa. The objects exhibited add nothing to our knowledge in this direction, although some of the Japanese and Chinese vases are of great excellence in form, material, and decoration.

Some very exceptional and remarkable porcelain decorations, for use in Chinese temples, exhibited by the Royal Commissioners,

and added to the collection at almost the latest period of the Exhibition, present peculiar and interesting features; they are very characteristic of Chinese skill in the manipulation of porcelain.

WOOLLEN AND WORSTED MANUFACTURES.

As an *international* representation of a great and important Industry, the contributions to the second great class of the present Exhibition are anything but satisfactory. Even *nationally* it is by no means a fair exposition of the current productions of the various localities in Great Britain in which woollen, worsted, and mixed fabrics form the staple manufacture.

For this reason, and the fact that the special purpose of this essay is to bring out the more distinct and salient points of recent

Although we have allotted three pages to the works of Messrs.

vases, jardinières, articles for household uses, of rare elegance and beauty, and their statuettes especially, are of the highest merit—

to the eminent firm that has so long maintained supremacy among the porcelain



COPELAND AND SONS, we have



by no means exhausted the supply of subjects for engraving; their



designed, modelled, and painted by accomplished artists. The examples we here give will suffice to justify the praise we accord



manufacturers of Europe. The principal object on this page is a copy in statuary



porcelain of the BACCHUS AND INO of Foley, one of the achievements in sculpture of which England may be justly proud. Perhaps

no work of its class has been so successful. It is of great excellence in all respects.

and Messrs. Fry, both of Dublin, take the lead; and in perfection of dye and finish, the few specimens exhibited are quite enough to justify the reputation of both firms.

In printed woollens, the only English productions which call for notice are printed flannels, exhibited by Messrs. T. Williams & Co., Vale Mills, Rochdale; and Messrs. G. Lawson and Sons, Micklehurst. These are evidently the production of the old print-works at Crayford, Kent, and are worthy specimens of what the now bye-gone skill of the famous Swaisland could produce. Well designed, accurate in fit, perfect in harmony of colour and brilliancy of tint, these flannels will sustain the old reputation of English fabric-printers.

French printed woollens are represented by some half-dozen specimens from the famous house of Steinbach, Kœochlin & Co.,

of Mulhouse. The chintz patterns are the perfection of treatment in heavy fabrics for curtains; while the printed Cashmere designs are of the greatest excellence in colouring and harmony of combination. These may be considered as the last productions of Alsace as a province of France.

Austrian printing is more largely represented than either French or English, and M. J. Brossi, St. Veit, near Vienna, exhibits some excellent specimens of printed shawls; while the examples contributed by Messrs. V. Mayer and Son, of Vienna, in the form of piece-goods, confirm the impression that in Austria printing has greatly advanced of late years, as these latter goods recall to mind the best English prints of this class exhibited in 1851, when these fabrics were so much in vogue.

SHAWLS.—Having alluded to printed shawls, the woven

Engraved on this page is a MIRROR, one of the contributions of M. BARBEDIENNE, of Paris, whose collection of works in bronze attracted,

and merited, marked attention at the International Exhibition, fully sustaining the high position occupied by France in that department

of Art. It is a composition of much grace and beauty, and of great refinement in finish. The figures are borrowed from the famous gates of

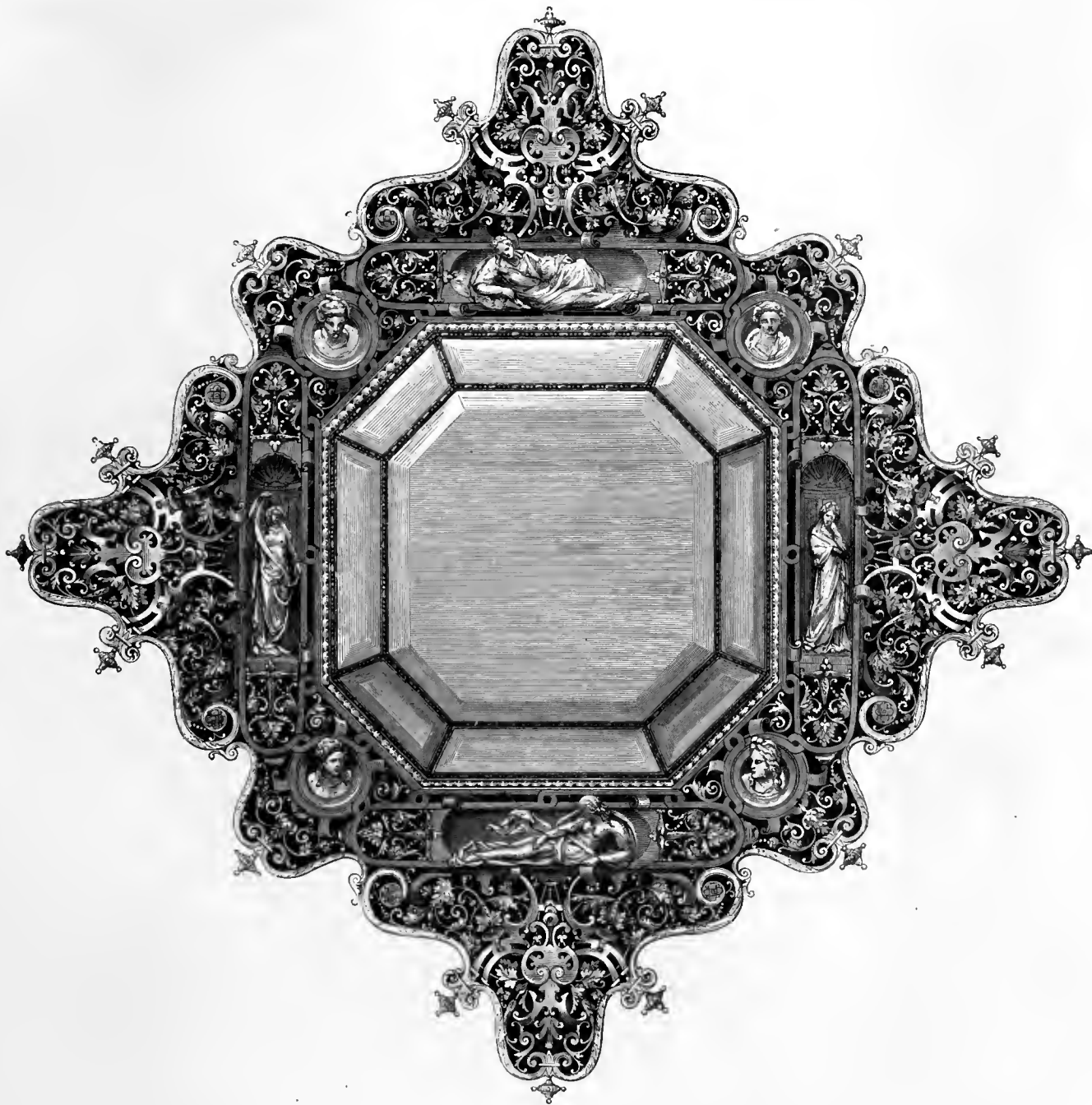

the Baptistery at Florence—the gates, renowned for centuries, the work of Ghiberti—of which Michel Angelo is reported to have said they were worthy to be the gates of Paradise. M.

Barbedienne was a large contributor to the Exhibition; he has achieved the highest distinction in Paris; obtaining Medals of Honour in all the exhibitions at which he has competed. It

has been our privilege to make his productions better known in England, by the engravings and descriptions we have given of them from time to time. They are often works of high Art.

specimens of this class may now be considered. Change of fashion has had its effect upon this important industry, and the Exhibition reflects the change. The Paisley and Norwich houses are unrepresented in this speciality.

Messrs. Norton, Bros., of Clayton West, Huddersfield, contribute a fair representation of the shawls, &c., for which the house has been so long noted. These are in a variety of patterns, chiefly stripes, in the manner of Indian borderings. The colourings are generally very excellent as regards brilliancy and harmony in combination. In quality of make and finish it is impossible to conceive goods of a better quality. With the shawls, Messrs. Norton, Bros., exhibit excellent examples of seal-skin mantlings, and other kindred fabrics. Messrs. J. C. Taylor, Bros., of Newsome and Huddersfield, exhibit a small but very elegant

series of examples of fancy wool and silk shawls of charming texture and finish, the colourings being very artistic and effective.

Messrs. W. Bliss & Son, Chipping Norton and London, give a very practical illustration of this new branch of their old-established business. The designs and colouring of their fancy-striped shawls are very effective and harmonious, and the "make" quite worthy of the reputation of the house. They also contribute specimens of their well-known "make" in fine wool plain shawls. Messrs. Claburn, Sons, and Crisp, Norwich, exhibit none of their usual productions in high-class shawls, but contribute a small, and effective, illustration of their carriage-shawls. As a matter of course, the taste and skill which distinguished their finer fabrics is brought to bear upon these coarser productions.

Messrs. HANCOCK & Co., the renowned jewel- | lers and goldsmiths, Bruton Street, Bond Street, | contribute not only examples of "PLATE," some

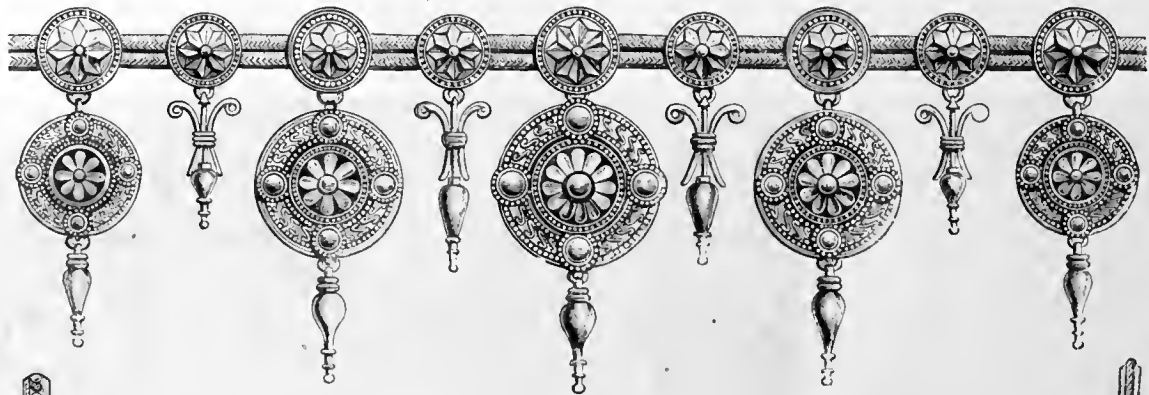

of which we have engraved, but also a small case of "rich and rare" JEWELS, the value of which has been largely augmented by the influence of pure taste and sound Art. We selected those which grace this page; they are, for the most part, based on ideas borrowed from antiques, without being actual or slavish copies; and they comprise all the varieties of personal adornment—NECK-

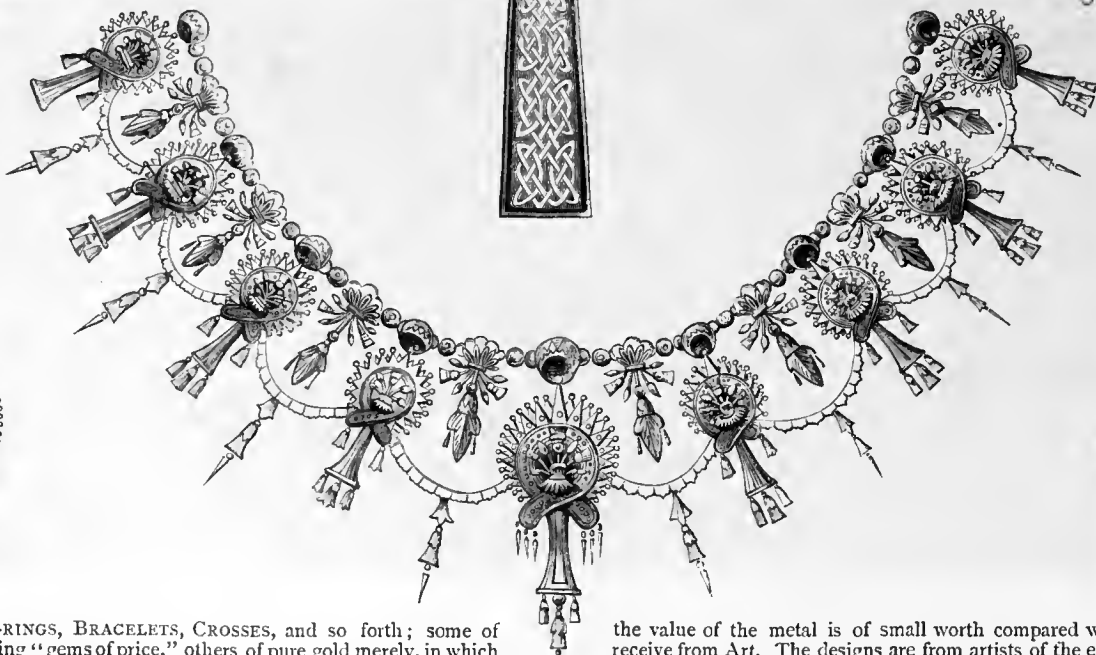

LACES, EAR-RINGS, BRACELETS, CROSSES, and so forth; some of them containing "gems of price," others of pure gold merely, in which

the value of the metal is of small worth compared with that they receive from Art. The designs are from artists of the establishment.

The foreign production in figured woven shawls is illustrated by a single specimen contributed by Hlawatsch and Isbury, of Vienna, the design being in imitation of Cashmere. The weaving rivals the true fabric in fineness and perfection of surface.

From Belgium there are a series of specimens of small plaid summer-shawls, exhibited by Messrs. H. Rolin and Son. They are generally good.

FURNITURE FABRICS.—The contributions under this head do not by any means represent this important branch of textile industry. Messrs. Claburn, Sons, and Crisp, Norwich, contribute a few specimens of their figured tapestry for curtains, all of admirable design and harmonious colouring. In these goods we see the influence of the teachings of the past twenty years in

relation to fitness of design for fabrics of this class. Original in treatment, but upon a sound principle, there is no affectation of antique types and models, as if the mediæval weavers had exhausted all invention in this direction, and all that the producers of the present day can do is to slavishly follow them.

Messrs. Norris & Co., London, also exhibit some superior fabrics of fine design, and some very ably-designed borders for curtains. The Irish firms, Messrs Pim, Bros., and W. Fry & Co., both of Dublin, surpass all their former efforts in the production of brocaded poplins for furniture purposes. The designs are, as a whole, very elegant, and especially well adapted to the material and mode of production. Messrs. J. and J. S. Templeton, of Glasgow, exhibit specimens of their patent brocade curtains, with

We engrave on this page another of the CARPETS manufactured and exhibited by JOHN BRINTON & Co., of Kidderminster, whose extensive and long-established Works produce the most perfect and beautiful floor-coverings that supply half the world, finding their way



into every country where they are necessary, or comfortable luxuries. This carpet is of the "patent Axminster," a class to which their attention is mainly directed. We convey an idea of its ornamentation, but none of its harmony in colours, and the delicacy of the material.

borders made up complete, in use in the Fine Art Gallery. This fabric is admirably adapted to its purpose, and capable of bold as well as very refined effects in the brocaded design. The filling alone, without borders, can be made two yards wide.

Mr. J. W. C. Ward exhibits examples of heavy-curtain fabrics in brocaded patterns, of excellent treatment in design.

The best foreign contributions are from Vienna, and Messrs. P. Haas and Son fully sustain their great reputation by their furniture fabrics. Some of these are superb in design and colour.

CARPETS.—This important section of decorative woollen fabrics is not so largely represented as might have been reasonably expected. Our space will only permit of a brief notice of the English productions, premising that a very great and healthy change has taken place in the character of the designs em-

ployed. Twenty years ago, nothing could possibly be more inappropriate than the whole mass of designs executed in carpets; but now the fact that the floor is a horizontal plane to be walked upon, and that the design ought not to contradict these facts, seems to be pretty generally understood and acted upon, thanks to the incessant iteration of a few simple rules and conditions, and the consistent action of a few able artists, such as Mr. Owen Jones, Sir M. D. Wyatt and Dr. Dresser, whose attention to this department of industrial design has had a marked influence on its present position.

The specimen carpet-patterns exhibited by Messrs. Jackson and Graham, illustrate this change very distinctly. They are exceptionally artistic in treatment and novel in effect.

Messrs. JOHN ADAMS & Co., of the Victoria Works, Hanley, Staffordshire Potteries, are ex-



tensive and highly meritorious manufacturers of



earthenware, whose productions in the style



known as "majolica" have a wide circulation: for the prices at which they are supplied bring

them within the reach of ordinary purchasers: they may be, and are, the acquisitions of "the



million." But though cheap, they are good; good in design and excellent in manufacture.

We have selected from their large stock, GARDEN-SEATS and FLOWER-POTS, and also a JAR-

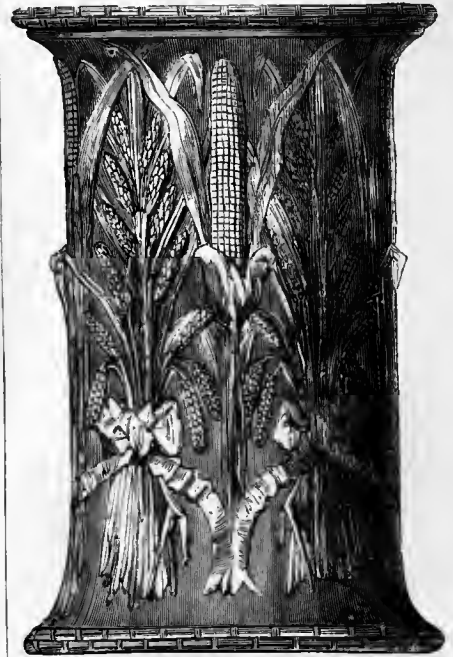

DINIÈRE of much grace and beauty. These are products of need in all gardens and conserva-



tories, that may be, as we have intimated, acquired on easy terms. The ornamentation is generally borrowed from natural forms; but they

add to, rather than take from, the value of the fern or plant the flower-pot may contain, serving as a base to the "greenery" that nature supplies.

A large and important carpet, exhibited by Messrs. Turberville, Smith & Co., London, is a remarkable specimen of patent Axminster. The design (by Sir Digby Wyatt) is a panelled one, the quantities being well distributed.

Messrs. Templeton & Co. contribute some excellent examples of their patent Axminster. One specimen is especially rich in tone and the perfect harmony of the colouring.

Messrs. J. Crossley and Sons, Halifax, exhibit the most complete series of carpets, with borders, all of Wilton pile. They are all well designed, mostly, as we are informed, by Dr. Dresser. The general tone of most of them is subdued, and while brilliancy is not sacrificed, they harmonise well in the mass.

The Kidderminster manufacturers do not exhibit very largely. Messrs. Willis & Co., John Brinton & Co., Mr. Charles Harrison,

and Messrs. Woodward and Grosvenor, are all represented, some by a single example only. We have no space to particularise, but all give evidence of a very decided advance in the quality of design and more perfect adaptation to use.

In concluding this essay upon the classes of Industrial Art in which design and artistic skill play so important a part, we feel but too sensibly that there are many other points of this interesting international gathering to which, had space permitted, we might have profitably called attention, and utilised as lessons in the principles of design. The pottery and the woollen products were, however, our special theme. The machinery and certain processes connected with both classes might have been usefully considered, since both illustrated a decided advance in the scien-

The CUP engraved on this page was presented by the Empress Eugénie to M. DE LESSEPS, whose famous work in Egypt has given him renown throughout the world, and obtained for him the gratitude of millions who

will profit by his labours. It is the production of MM. FANNIERE, FRÈRES, of Paris, and was one of the leading attractions of the Art-Court at the International Exhibition. As will be seen, it represents a Nile boat, the



figures and the reliefs on the side being illustrative accessories to the story of one of the many marvellous achievements that Science has accomplished in our age. The boat is enamelled, the figures being of pure gold. The gift is worthy of the giver and the receiver.

tific and mechanical methods in vogue twenty or twenty-five years ago. The improvements in the machinery now applied to the preparation and manufacture of wool have been numerous and important, and to our minds are to be attributed to the complete suspension of the manufacture of machinery, as applied to cotton, during the cotton famine occasioned by the civil war in the United States. The attention of skilled mechanics was of necessity directed to those industries, woollen and flax, which sought to make up for the dearth of cotton, and the complete suspension of nearly all operations therein. The result is visible in the novel and ingenious machines which have given such an interest to the mechanical section of the Exhibition.

The lessons imparted to all who desired to learn have been, for the most part, of a solid character, calculated to produce

good results in the future; and the means now placed at the command of her Majesty's Commissioners for the Exhibition of 1851, to carry on the work inaugurated with such *éclat* and success twenty years ago, are such as to render their task a comparatively easy one in the future, if sound principles, experience, and technical knowledge guide the work in hand. Experiments for the sake of novelty, and catering to the crude and unpractical notions of *dilettanti* committees, or the ultra-commercial greed of mere buyers and sellers, whether of home or foreign growth, will have to be carefully avoided; otherwise a noble ship may become an ignominious wreck from lack of skill, or a reckless impatience in handling and steering her.

We have engraved, on another page, some of the works of M. ARMAND BOURDON DE	BRUYNE, an eminent Flemish artist-manufacturer (chiefly of objects for church uses). This page	contains a "CORONA LUCIS," presented by the Belgian Catholics to "the Church of the Holy
--	--	--



Name of Jesus," at Jerusalem, in memory of Godfrey of Bouillon. The angels bear roses, representing the emblems of the Passion. The	inscriptions have reference to the same sacred subject, as also the objects on the enamelled shields. The balls of the suspending chains are	of crystal. The shields of the upper circle are emblazoned with the Belgian lion, in enamel. The work is designed by M. VAN DEN POLLE, of Ghent.
---	--	--









U. C. BERKELEY LIBRARIES



C049768688

