



This is a digital copy of a book that was preserved for generations on library shelves before it was carefully scanned by Google as part of a project to make the world's books discoverable online.

It has survived long enough for the copyright to expire and the book to enter the public domain. A public domain book is one that was never subject to copyright or whose legal copyright term has expired. Whether a book is in the public domain may vary country to country. Public domain books are our gateways to the past, representing a wealth of history, culture and knowledge that's often difficult to discover.

Marks, notations and other marginalia present in the original volume will appear in this file - a reminder of this book's long journey from the publisher to a library and finally to you.

Usage guidelines

Google is proud to partner with libraries to digitize public domain materials and make them widely accessible. Public domain books belong to the public and we are merely their custodians. Nevertheless, this work is expensive, so in order to keep providing this resource, we have taken steps to prevent abuse by commercial parties, including placing technical restrictions on automated querying.

We also ask that you:

- + *Make non-commercial use of the files* We designed Google Book Search for use by individuals, and we request that you use these files for personal, non-commercial purposes.
- + *Refrain from automated querying* Do not send automated queries of any sort to Google's system: If you are conducting research on machine translation, optical character recognition or other areas where access to a large amount of text is helpful, please contact us. We encourage the use of public domain materials for these purposes and may be able to help.
- + *Maintain attribution* The Google "watermark" you see on each file is essential for informing people about this project and helping them find additional materials through Google Book Search. Please do not remove it.
- + *Keep it legal* Whatever your use, remember that you are responsible for ensuring that what you are doing is legal. Do not assume that just because we believe a book is in the public domain for users in the United States, that the work is also in the public domain for users in other countries. Whether a book is still in copyright varies from country to country, and we can't offer guidance on whether any specific use of any specific book is allowed. Please do not assume that a book's appearance in Google Book Search means it can be used in any manner anywhere in the world. Copyright infringement liability can be quite severe.

About Google Book Search

Google's mission is to organize the world's information and to make it universally accessible and useful. Google Book Search helps readers discover the world's books while helping authors and publishers reach new audiences. You can search through the full text of this book on the web at <http://books.google.com/>





3-VBA
T



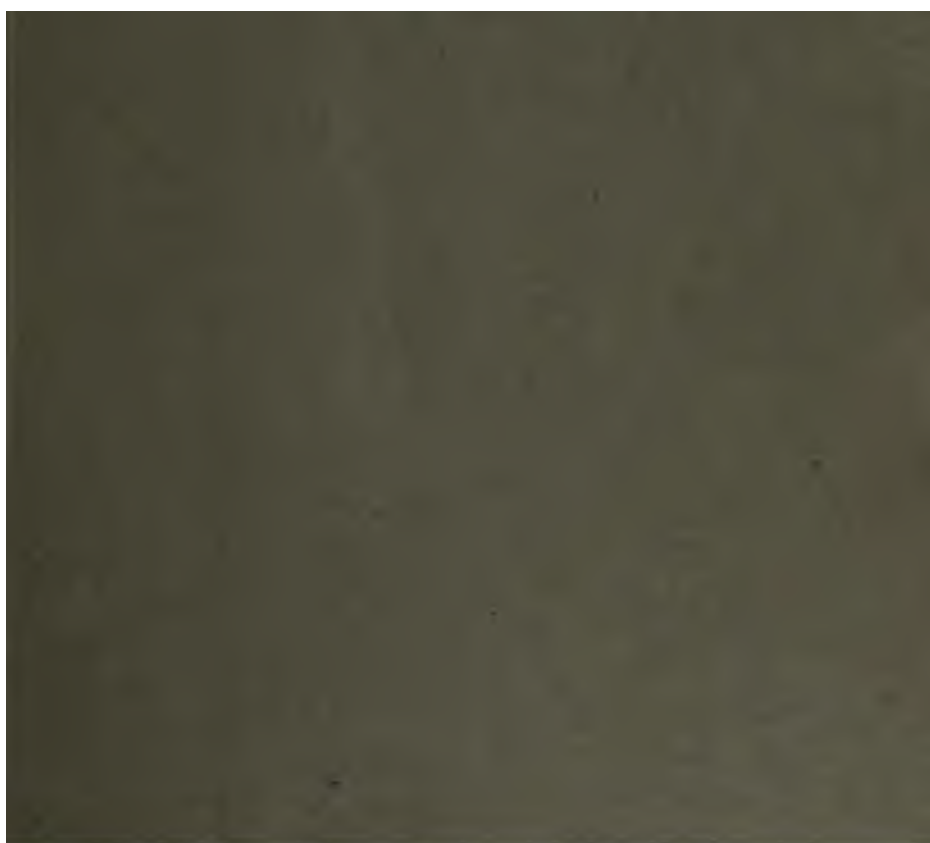

3. VIB
Intermittent



✓

10/20/11

INTERNATIONAL LIBRARY OF TECHNOLOGY

A SERIES OF TEXTBOOKS FOR PERSONS ENGAGED IN THE ENGINEERING
PROFESSIONS AND TRADES OR FOR THOSE WHO DESIRE
INFORMATION CONCERNING THEM. FULLY ILLUSTRATED
AND CONTAINING NUMEROUS PRACTICAL
EXAMPLES AND THEIR SOLUTIONS

DYNAMO DESIGN
MOTOR DESIGN
ALTERNATING CURRENTS

534

NEW YORK
PUBLISHED BY
INTERNATIONAL

SCRANTON:
INTERNATIONAL TEXTBOOK COMPANY

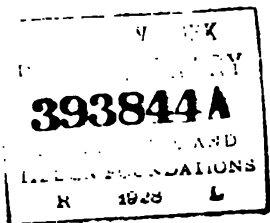

Copyright, 1897, 1898, 1899, by THE COLLIERY ENGINEER COMPANY.

Copyright, 1902, by INTERNATIONAL TEXTBOOK COMPANY.

Dynamo-Electric Machine Design: Copyright, 1898, by THE COLLIERY ENGINEER COMPANY.

Motor Design: Copyright, 1898, by THE COLLIERY ENGINEER COMPANY.

Theory of Alternating-Current Apparatus: Copyright, 1899, by THE COLLIERY ENGINEER COMPANY.

Design of Alternating-Current Apparatus: Copyright, 1899, by THE COLLIERY ENGINEER COMPANY.

All rights reserved.

XROY WAB
CLUB
VYAGU

1712a

Press of EATON & MAINS
NEW YORK

PREFACE

The International Library of Technology is the outgrowth of a large and increasing demand that has arisen for the Reference Libraries of the International Correspondence Schools on the part of those who are not students of the Schools. As the volumes composing this Library are all printed from the same plates used in printing the Reference Libraries above mentioned, a few words are necessary regarding the scope and purpose of the instruction imparted to the students of—and the class of students taught by—these Schools, in order to afford a clear understanding of their salient and unique features.

The only requirement for admission to any of the courses offered by the International Correspondence Schools, is that the applicant shall be able to read the English language and to write it sufficiently well to make his written answers to the questions asked him intelligible. Each course is complete in itself, and no textbooks are required other than those prepared by the Schools for the particular course selected. The students themselves are from every class, trade, and profession and from every country; they are, almost without exception, busily engaged in some vocation, and can spare but little time for study, and that usually outside of their regular working hours. The information desired is such as can be immediately applied in practice, so that the student may be enabled to exchange his present vocation for a more congenial one, or to rise to a higher level in the one he now pursues. Furthermore, he wishes to obtain a good working knowledge of the subjects treated in the shortest time and in the most direct manner possible.

In meeting these requirements, we have produced a set of books that in many respects, and particularly in the general plan followed, are absolutely unique. In the majority of subjects treated the knowledge of mathematics required is limited to the simplest principles of arithmetic and mensuration, and in no case is any greater knowledge of mathematics needed than the simplest elementary principles of algebra, geometry, and trigonometry, with a thorough, practical acquaintance with the use of the logarithmic table. To effect this result, derivations of rules and formulas are omitted, but thorough and complete instructions are given regarding how, when, and under what circumstances any particular rule, formula, or process should be applied; and whenever possible one or more examples, such as would be likely to arise in actual practice—together with their solutions—are given to illustrate and explain its application.

In preparing these textbooks, it has been our constant endeavor to view the matter from the student's standpoint, and to try and anticipate everything that would cause him trouble. The utmost pains have been taken to avoid and correct any and all ambiguous expressions—both those due to faulty rhetoric and those due to insufficiency of statement or explanation. As the best way to make a statement, explanation, or description clear is to give a picture or a diagram in connection with it, illustrations have been used almost without limit. The illustrations have in all cases been adapted to the requirements of the text, and projections and sections or outline, partially shaded, or full-shaded perspectives have been used, according to which will best produce the desired results. Half-tones have been used rather sparingly, except in those cases where the general effect is desired rather than the actual details.

It is obvious that books prepared along the lines mentioned must not only be clear and concise beyond anything heretofore attempted, but they must also possess unequaled value for reference purposes. They not only give the maximum of information in a minimum space, but this information is so ingeniously arranged and correlated, and the

indexes are so full and complete, that it can at once be made available to the reader. The numerous examples and explanatory remarks, together with the absence of long demonstrations and abstruse mathematical calculations, are of great assistance in helping one to select the proper formula, method, or process and in teaching him how and when it should be used.

The numerous questions and examples, with their answers and solutions, which have been placed at the end of each volume, will prove of great assistance to all who consult the Library.

This volume gives an unusually clear explanation of the principles involved in the design of electrical machinery for direct and alternating currents, together with a detailed treatment of the theory of alternating currents and alternating-current apparatus. In presenting the latter subject the graphical method has been freely used, since it is more easily grasped and conveys a clearer idea of the principles involved than the analytical method. By using specially prepared diagrams and supplementing them by practical examples, this usually difficult subject is here made exceedingly simple without sacrificing thorough treatment. In connection with the design of electrical apparatus, all the fundamental principles and methods involved are given, and the manner of applying them fully illustrated. No attempt has been made to give data on a large number of machines, as such data soon becomes obsolete and, moreover, is of little use when applied to special cases.

As mentioned above, this volume is printed from the plates used in printing the Reference Libraries of the International Correspondence Schools. On account of the omission of certain papers, the material contained in which is given in better form elsewhere, there are several breaks in the continuity of the page numbers, formula numbers, article numbers, etc. This, however, does not impair the value of the volume, as the index has been reprinted and made to conform to the present arrangement.

CONTENTS.

DYNAMO-ELECTRIC MACHINE DESIGN.	<i>Page.</i>
Factors Limiting Output - - - - -	2391
Heating of Machine - - - - -	2391
Speed of Armature - - - - -	2395
Heating of Field Spools - - - - -	2395
Armature Reaction: Smooth Core - - - - -	2397
Current Density in Armature Conductor - - - - -	2415
Armature Reaction: Slotted Core - - - - -	2415
Armature Reaction: Constant-Current Dynamos	2419
Magnetic Densities - - - - -	2421
Calculation of Field Ampere-Turns - - - - -	2423
Design of 12-Horsepower Dynamo - - - - -	2426
Characteristic Curves - - - - -	2449
Efficiency - - - - -	2457
Mechanical Construction - - - - -	2468
Connection Diagrams - - - - -	2513
Assembled Machines - - - - -	2515
MOTOR DESIGN.	
Principles of Operation - - - - -	2517
Dynamos and Motors Compared - - - - -	2518
Action of Motor - - - - -	2519
Classes of Motors - - - - -	2529
Shunt Motors - - - - -	2530
Series Motors - - - - -	2533
Differentially Wound Motors - - - - -	2539
Starting Rheostats - - - - -	2540
Automatic Switches - - - - -	2544
Series-Motor Connections - - - - -	2545
Regulating Rheostats - - - - -	2546

MOTOR DESIGN— <i>Continued.</i>	<i>Page.</i>
Methods of Reversing Motors - - -	2546
Design of Continuous-Current Motors - - -	2549
Railway-Motor Armatures - - - - -	2557
 THEORY OF ALTERNATING-CURRENT APPARATUS.	
Theory of Alternating Currents - - - - -	2559
Cycle, Frequency, Alternation, Period - - -	2562
Sine Curves - - - - -	2564
Two- and Three-Phase Systems - - - - -	2574
Composition and Resolution of Currents and E. M. F.'s - - - - -	2577
Maximum, Average, and Effective Values of Sine Curves - - - - -	2579
Self-Induction - - - - -	2584
Components of Impressed E. M. F. - - - - -	2588
Circuits Containing Resistance and Self-Induc- tion - - - - -	2590
Effects of Capacity - - - - -	2599
Circuits Containing Resistance and Capacity -	2607
Circuits Containing Resistance, Self-Induction, and Capacity, - - - - -	2611
Power Expended in Alternating-Current Circuits	2619
Transmission Lines - - - - -	2628
Alternating-Current Measuring Instruments -	2632
Power Measurement - - - - -	2643
Single-Phase Alternators - - - - -	2646
Revolving-Field and Inductor Alternators -	2667
Polyphase Alternators - - - - -	2670
Two-Phase Alternators - - - - -	2671
Three-Phase Alternators - - - - -	2676
Monocyclic System - - - - -	2687
Transformers - - - - -	2688
Alternating-Current Motors - - - - -	2713
Synchronous Motors - - - - -	2713
Induction Motors - - - - -	2716
Phase Splitting - - - - -	2725
Rotary Transformers - - - - -	2726

CONTENTS.

ix

DESIGN OF ALTERNATING-CURRENT APPARATUS.	<i>Page.</i>
Alternators - - - - -	2735
Limitation of Output - - - - -	2736
Relation Between C^2R Loss and Output - - - - -	2739
Core Losses - - - - -	2740
Radiating Surface of Armature - - - - -	2744
Armature Reaction - - - - -	2746
Armature Windings - - - - -	2752
Construction of Armatures - - - - -	2762
Magnetic Densities - - - - -	2776
Design of 100-Kilowatt Single-Phase Alternator	2778
Armature Winding for Two-Phase Alternator -	2791
Armature Winding for Three-Phase Alternator -	2793
Design of Field Magnets - - - - -	2799
Design of Field - - - - -	2806
Mechanical Construction - - - - -	2821
Connections - - - - -	2834
Transformers - - - - -	2841
Design of 8-Kilowatt Transformer - - - - -	2850
Induction Motors - - - - -	2869
Limitation of Output - - - - -	2870
Induction-Motor Windings - - - - -	2873
Design of 10-Horsepower Motor - - - - -	2878
Field Winding and Connections - - - - -	2892
Mechanical Construction - - - - -	2894
QUESTIONS AND EXAMPLES.	
Dynamo-Electric Machine Design - 1648, 1711, 2919	
Motor Design - - - - - 1712, 1747, 2925	
Theory of Alternating-Current Apparatus	1748, 1840, 2931
Design of Alternating-Current Apparatus	1841, 1918, 2945

DYNAMO-ELECTRIC MACHINE DESIGN.

(CONTINUOUS-CURRENT.)

FACTORS LIMITING OUTPUT.

3541. The output of a constant-potential dynamo is limited by two factors: the carrying capacity of the armature conductors, and the distortion of the field by armature reaction. The evidence of a machine having reached the limit in the first of the above cases is the development of serious heat in the armature; distortion of the field is indicated by excessive sparking at the commutator.

3542. The question of sparking must be considered fully in the design of a dynamo; for it is not merely a matter of shifting the brushes which should be relied upon to prevent sparking, nor yet an excessive strength of field, as this is wasteful of energy. In a well-designed dynamo, sparking should not occur within the limits of the working range, which may include an overload above the rated output of 15 or 20 per cent.

HEATING OF MACHINE.

3543. The heat that is being continually generated in the machine, owing to the resistance which the conductors present to the passage of current, is given off from the surface of the armature and of the whole machine to the surrounding air. This giving off of heat can occur only when the dynamo is hotter than the air, for if two bodies are equally hot, one can not give any heat to the other. Conversely, the greater the difference in temperature between two bodies, such as a dynamo armature and the

For notice of copyright, see page immediately following the title page.

surrounding air, the more heat will be given from the hot body to the cold.

When a dynamo is first started, it is at about the same temperature as the surrounding air, so that when the losses in the armature begin to generate heat, this heat can not pass off to the air; but, instead, it raises the temperature of the armature until it is enough hotter than the surrounding air to cause all the heat being generated to be given off.

With a constant load, the amount of heat generated will become constant, and it will be given off as fast as it is developed; but with an increase of load, the temperature will again rise until the armature is enough hotter than the air to give off all this increased amount of heat.

35-14. The copper and iron parts of the machine can stand a rather high increase of temperature without serious effects; but the insulating materials, such as cotton, silk, shellac, paper, etc., will become *carbonized*, that is, charred, or otherwise rendered useless for their specific purpose. For a short time these materials will withstand a temperature considerably above the boiling-point of water (212° F.), but it has been found that if they are continually subjected to a temperature greater than about 180° F., they will gradually become carbonized. Hence, as armatures are expected to last for several years, they should never be subjected to a continual temperature greater than about 170° F. Consequently, the amount of current which will cause a dynamo armature to heat to about 170° F. is the limiting amount which that armature can safely give.

35-15. Since, for a given output, the temperature of the armature will rise a certain amount above that of the surrounding air, it is evident that, if the air is originally of a high temperature, the armature will actually have a higher temperature when giving off a certain amount of heat than if the air were cooler; that is, for a certain amount of heat generated, the temperature of the armature will rise to a certain number of degrees above the temperature of the air. The average temperature of the air in

places where dynamos are installed is often as high as 90° F., so the allowable rise in temperature of the armature above that of the air is about 80° F., and dynamos are usually rated according to this rise in temperature.

HEATING IN ARMATURE.

3546. The chief source of heat in a dynamo is usually that due to the flow of current through the armature. This being proportional to the square of the current and to the resistance, is frequently termed the $C^2 R$ loss. In order to reduce this loss, the armature resistance should be made very low. It is not possible to go beyond certain limits, however, in the size of conductor, as the winding space can not be indefinitely increased. The watts lost in heat generally vary according to the size of the machine, a smaller dynamo being less efficient in this respect than a larger one, owing to the lack of suitable ventilation and the high resistance of the winding. It is usual to provide a certain proportion of armature surface per watt expended in heating, in order to allow of the heat being radiated at a sufficiently high rate to prevent excessive rise in temperature. A safe figure to use, and one which is confirmed in practice, is 1.11 square inches of surface per watt lost, equivalent to .9 watt per square inch, for peripheral speeds ranging from 2,500 to 3,500 feet per minute. A rule given by Esson, applicable to rise of temperature for any particular case, is the following:

$$t = \frac{99 w}{s(1 + 0.00018 v)}, \quad (559.)$$

where t = temperature rise in degrees Fahrenheit;

w = watts expended in heat;

s = surface of armature in square inches;

v = peripheral velocity in feet per second.

The rise in temperature of an armature is equal to 99 times the watts lost, divided by the exposed surface in square inches multiplied by 1 plus 0.00018 times the velocity in feet per second.

3547. Loss Due to Heating.—After the armature winding has been designed, its resistance can be calculated, and the C^2R loss determined approximately. In general, it will be found that the resistance is somewhat larger than the calculated value, owing to the effect of joints between the conductors. The C^2R loss will, however, be found to nearly agree with the values as given in the curve of, Fig. 134.

It will be seen that the losses due to this cause fall off quickly when passing from the small sizes to machines of

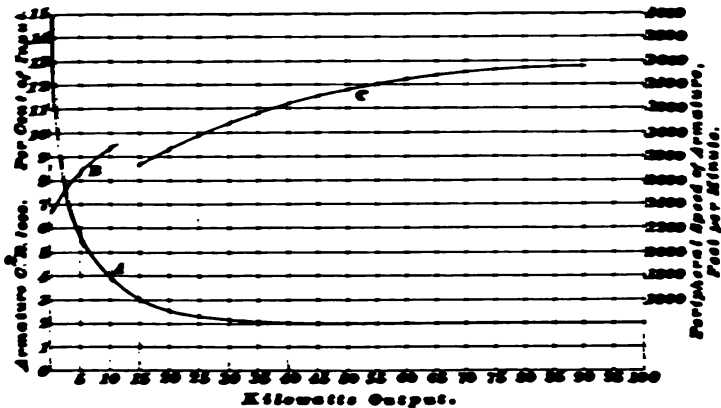

FIG. 134.

larger capacity, a 100 K. W. dynamo having a C^2R loss of about 2 per cent. of the input.

3548. Heating of the armature is due, not alone to the C^2R loss, but also to convection from the copper conductors, to eddy currents in them, and to hysteresis. Ring armatures usually present a greater surface to the cooling effect of the air than do drum-wound armatures, for it is not only the outer cylindrical surface which is to be considered, but likewise the ends of the cores and all exposed portions of the winding. The inner turns of the ring armature are not, however, as efficient in dissipating heat as the outer turns.

SPEED OF ARMATURE.

3549. In Fig. 1347 are given the peripheral speeds of armatures in feet per minute. Curve *B* shows the speeds adopted by a well-known manufacturer for dynamos of $\frac{1}{2}$ kilowatt to about 10 kilowatts, all of bipolar construction. The general range of larger machines is from 2,800 to 3,600 feet per minute, as indicated on curve *C*. It need not be considered indispensable that a steady increase of speed should accompany increase in size. Some manufacturers adopt a fixed peripheral velocity which is adhered to through a wide range; for the smaller sizes, up to, say, 25 horsepower, the velocity may be 3,100 feet per minute, and for all larger machines a velocity of about 3,500 feet per minute. All these figures are for the usual high-speed type of dynamo; the moderate-speed type is run at about two-thirds of the above velocity.

Large direct-connected multipolar dynamos of 100 kilowatts and upwards have usually a peripheral velocity of 2,200 to 2,500 feet per minute, as, for instance, those built by the General Electric Company. Railway generators for belt-driving are frequently designed for a surface speed of 5,000 feet per minute; the pulleys, however, should be of smaller diameter than the armatures, as the belt should not run at a higher speed than about 4,500 feet per minute. The adoption of a high peripheral speed for the armature is to be commended, on account of a reduction in weight for a given output; but due consideration must be given to mechanical strength. A very high speed also demands very careful balancing of the rotating parts, in order to avoid injury to the insulation through vibration.

HEATING OF FIELD SPOOLS.

3550. The field spools of the dynamo must be designed with a view to presenting sufficient surface to the air to dissipate the heat developed. The ends of the spool assist materially in radiating heat, as does also, to some extent, the inner surface which lies against the magnet core. A

2396 DYNAMO-ELECTRIC MACHINE DESIGN.

useful formula, taking into account the cooling effect of a little space at least on one side between the spool and magnet, is the following:

$$t = \frac{80 w}{s}, \quad (560.)$$

where t = temperature rise of spool in degrees Fahrenheit;

w = watts expended in coils;

s = surface of spools (wire only) in square inches.

Expressed in words, this formula states that *the rise in temperature of the field spools is equal to 80 times the watts expended in the coils, divided by the exposed surface of the wire in square inches.*

With a permissible rise in temperature of 75° or 80° F., it will be found that about 1.1 square inches per watt will be required. Such a proportion is, in fact, frequently used, although it is perhaps a better plan to allow 1.5 or 2 square inches per watt, because the lesser rise in temperature thereby occasioned will cause less variation in the exciting current during the time when the machine is slowly warming up. In any case, it must be remembered that the shape of the spools and their position with regard to neighboring portions of the magnetic circuit will have considerable influence in determining the allowable surface of winding. The formula given above refers to magnet spools as ordinarily constructed. It is also most important that the depth of winding should not be too great—not over 2½ inches, as a rule—as the temperature of the inner turns may otherwise become very high. For small machines the usual depth of winding is considerably less than this figure, being from 1 inch to 1½ inches.

3551. The advantage attending the use of short spools with comparatively small winding volume is that a compact magnetic circuit is secured and the weight of copper is reduced. On the other hand, since a given magnetizing force is required, the ampere-turns must remain the same; if, then, the number of turns is reduced, the current must be increased. The losses are, however, proportional to the

square of the current, and only vary directly with the resistance; so that it is more economical to reduce the current and increase the resistance than the reverse. It will then be seen that here the number of square inches of winding surface per watt lost in the coils is a compromise between efficiency of the machine on the one hand, and first cost of copper on the other; for if we desire the loss in heating to be small, we must use a greater weight of wire. It will be shown in the following pages that compromises of this kind must be made continually through the entire subject of dynamo design.

3552. In shunt-wound dynamos, the loss of energy in the field winding is from about 10 per cent. for a 1 K. W. machine to about 1.5 per cent. for a 100 K. W. machine.

ARMATURE REACTION—SMOOTH CORE.

EFFECT OF ARMATURE AMPERE-TURNS.

3553. The subject of armature reaction has previously been referred to in a general way, and we will now consider

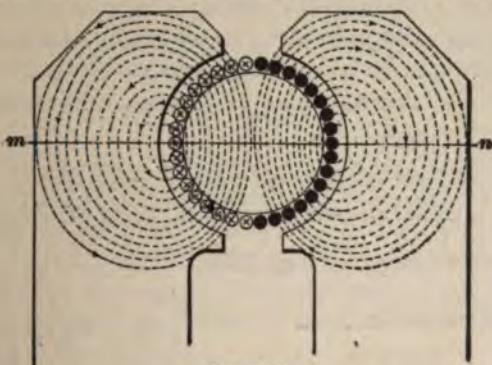

FIG. 1348.

it more in detail with reference to actual design. We have seen that the magnetic effect of the armature ampere-turns is at right angles to the direction of the lines of force due to the field winding, so that a cross-magnetization is produced.

393844A

2398 DYNAMO-ELECTRIC MACHINE DESIGN.

For the purpose of studying the field induced by the armature current, we will show the distribution of the lines of force as it would occur if the disturbing effect of the field ampere-turns were not present. In Fig. 1348 are represented the armature and pole-pieces of a bipolar dynamo; the conductors are indicated by the small circles on the periphery of the armature, and the direction of the flow of current in them is shown by their marking, the cross representing a current flowing upwards through the paper, and the full black circle representing a current flowing away from the observer. The lines of force, it will be noticed, spread evenly over the pole-pieces and complete the circuit through the iron of the armature core. The reluctance of the path through the iron of the pole-pieces and core is almost negligible, compared with the reluctance offered by the air-gap, so that it is evident that the magnetomotive force (M. M. F.) of the armature ampere-turns is almost wholly expended in driving the lines of force through the air-gap. The greatest difference of magnetic potential due to the armature ampere-turns is at the pole-tips at nearly diametrically opposite points, and the least difference of potential is at the horizontal center line, where it is reduced to zero. This maximum difference of magnetic potential is, then, proportional to the armature ampere-turns, or to the cross M. M. F., and may also be expressed in terms of any angle. For example,

Let C = current flowing through armature;
 c = number of conductors on periphery of armature.

Then, for any angle l , Fig. 1350,

$$\text{cross M. M. F.} = 3.192 \times \frac{C}{2} \times c \times \frac{l}{360}.$$

Since the greatest magnetic difference of potential exists between the upper and lower ends of the pole-pieces, that is, at opposite ends of the armature, the cross M. M. F. will be

$$3.192 \times \frac{C}{2} \times c \times \frac{180}{360} = 3.192 \times \frac{Cc}{4}. \quad (561.)$$

This cross M. M. F. may be considered as expending nearly all its force on the air-gaps at the ends of the pole-pieces, at top and bottom, since the effect diminishes to zero at the horizontal center line, provided also that the area of the pole-pieces is sufficiently great to allow of practically unobstructed passage of the lines of force.

EFFECT OF CROSS AMPERE-TURNS.

3554. We may now proceed to an investigation of the effect of field distortion. Fig. 1349 shows the resulting field when armature ampere-turns and field ampere-turns are simultaneously acting upon the magnetic circuit.

The direction along which the M. M. F. of the armature ampere-turns acts is shown by the heavy dotted lines. It will be seen that this is directly opposed to the M. M. F. of the field ampere-turns at the leading pole tips *a* and *e*, with the result that a decided neutralization of induction occurs; but at the following pole tips *c*, *f* the induction is strengthened, because the two M. M. F.'s act in conjunction and build up a stronger field. It should be pointed out that the total number of lines of force in the air-gap is not changed, but their distribution is altered, so that the density varies accordingly.

3555. In the calculations to determine the ampere-turns necessary for the field-magnets, a certain number is taken for each portion of the magnetic circuit, as will be explained in due time. Let At_g represent the field ampere-turns required to overcome the reluctance of the air-gaps (twice the radial distance from pole-piece to core). Then the M. M. F. at *one* air-gap, due to the field ampere-turns, is equal to

$$3.192 \times \frac{At_g}{2}. \quad (562.)$$

We have found, however, by formula **561**, that the cross M. M. F. of the armature over the two air-gaps *a b* and *c d* is

2400 DYNAMO-ELECTRIC MACHINE DESIGN.

$3.192 \times \frac{Cc}{4}$; therefore the cross M. M. F. for one air-gap will be

$$3.192 \times \frac{Cc}{4} \times \frac{1}{2} = 3.192 \times \frac{Cc}{8}. \quad (563.)$$

The algebraic sum of these two equations will, then, give us the resultant M. M. F. at the pole tips. We must have regard to the sign of formula **563**, as it is in one case positive and in one case negative. At the upper end of the left-hand pole-piece, the cross M. M. F. opposes the field M. M. F., so that for the air-gap $a b$ at the leading pole tip the resultant M. M. F. is

$$3.192 \left(\frac{At_g}{2} - \frac{Cc}{8} \right). \quad (564.)$$

At the lower end of the same pole-piece, the M. M. F.'s are in the same sense, and the resultant M. M. F. for the air-gap $c d$ is

$$3.192 \left(\frac{At_g}{2} + \frac{Cc}{8} \right). \quad (565.)$$

3556. From the above equations we may directly obtain the values of the induction in the air-gap, since it is, in such a case, represented by the M. M. F. divided by the length of the circuit. Then,

If B'_g = density of lines of force per square inch in leading pole tip;

l_g = length of single air-gap in inches,

$$B'_g = \frac{3.192 \left(\frac{At_g}{2} - \frac{Cc}{8} \right)}{l_g}. \quad (566.)$$

The density of magnetic lines of force under the leading pole tip is equal to 3.192 times the difference between the field ampere-turns required for one air-gap and one-half the cross ampere-turns, divided by the length of the single air-gap;

3557. Also, if B'_g = density of the following pole tip,

$$B'_g = \frac{3.192 \left(\frac{At_g}{2} + \frac{Cc}{8} \right)}{l_g}. \quad (567.)$$

The density of the magnetic lines of force under the following pole tip is equal to 3.192 times the sum of the field ampere-turns required for one air-gap and one-half the cross ampere-turns, divided by the length of the single air-gap.

3558. At the horizontal center line it has been shown that the cross M. M. F. is zero; therefore, the density in the air-gap at this point will be due only to the ampere-turns of the field. Let B_g represent the induction at the center line; then

$$B_g = \frac{3.192 \frac{At_g}{2}}{l_g} = \frac{3.192 At_g}{2l_g}. \quad (568.)$$

That is, the density of magnetic lines of force at the center of the pole-piece is equal to 3.192 times the field ampere-turns required for the gap, divided by twice the length of the single air-gap.

3559. The air-gap between the armature core and the right-hand pole-piece (Fig. 1349) may be considered in exactly the same manner, the magnetic density being least at the leading pole tip e and greatest at the following pole tip f .

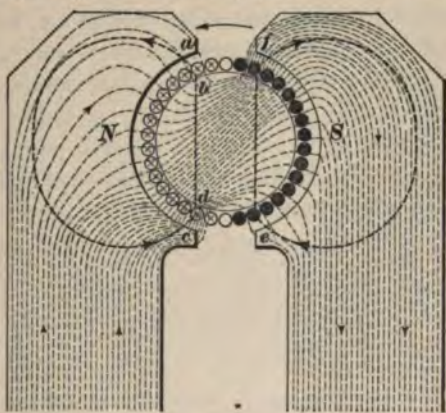

FIG. 1349.

EFFECT OF BACK AMPERE-TURNS.

3560. We have thus far referred only to the effect produced by the *cross* ampere-turns of the armature. It is not

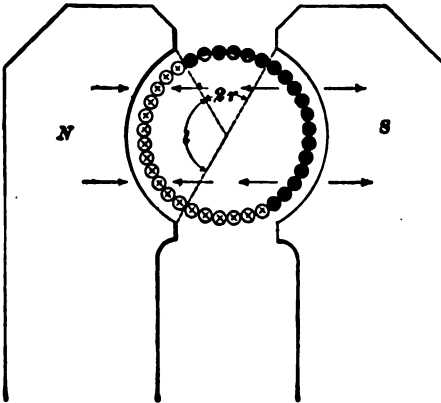

FIG. 1350.

possible, however, to run the dynamo with the brushes set exactly midway between the pole tips, and a certain angle of lead must be given, as shown in the discussion, in a previous section, of the theory of the dynamo. In Fig. 1350 the angle of lead = r , or one-half the angle represented by $2r$, this being the

angular distance through which the brushes must be moved in order to obtain sparkless commutation. The turns embraced within twice this angle r , multiplied by the current which each conductor carries, constitute the *back* ampere-turns. The direction of the lines of force induced by these turns is indicated by the small arrows on the armature core, and the direction of the field lines of force is shown by the small arrows on the pole-pieces. It is evident, then, that the back ampere-turns neutralize a certain equal number of ampere-turns on the field-magnets, so that this must be borne in mind later, when the total field ampere-turns are calculated.

3561. For a bipolar dynamo, the value of the current flowing through any one conductor is one-half the total armature current, there being only two circuits. Also, the number of conductors enclosed within the double angle of lead $2r$ is equal to $\frac{2r}{360}$ of the total number, since r is expressed in degrees, and there are 360 degrees to the circle. Then the value of the back ampere-turns of the armature

$$At_b = \frac{C}{2} \times \frac{2r}{360} \times c = \frac{Cr c}{360}, \quad (569.)$$

where C = total armature current ;
 r = angle of lead of brushes ;
 c = total number of conductors.

The back ampere-turns of the armature of a bipolar dynamo are equal to the armature current in amperes multiplied by the angle of lead and the total number of conductors, and divided by 360.

VALUE OF CROSS AMPERE-TURNS.

3562. The cross ampere-turns are included within the angle l , Fig. 1350, which is equal to $180^\circ - 2r$, that is, to the whole number of armature ampere-turns less the back ampere-turns. We may then write the following expression for the value of the cross ampere-turns :

$$At_c = \frac{C}{2} \times \frac{l}{360} \times c, \quad (570.)$$

where C = total armature current ;
 l = 180° less twice the angle of lead ;
 c = total number of armature conductors.

The cross ampere-turns of the armature of a bipolar dynamo are equal to half the armature current multiplied by the number of conductors enclosed within an angle equal to 180° less twice the angle of lead.

3563. Although, as we have seen, the cross ampere-turns do not change the total number of lines of force, but only deflect them, the tendency of this cross M. M. F. is to weaken the field at the leading pole tip by diverting the lines of force from that point. A certain strength of field is, however, necessary for commutation, so that there exists in all cases a critical value of cross M. M. F. beyond which it is impossible to go without causing destructive sparking. We have found, by formula **561**, that if the angle embraced by the conductors producing the cross ampere-turns is 180° , their magnetomotive force = $3.192 \times \frac{C}{2} \times c \times \frac{180}{360}$. If we

2404 DYNAMO-ELECTRIC MACHINE DESIGN.

now substitute for 180 the angle l , the M. M. F. of the cross ampere-turns = $3.192 \times \frac{C}{2} \times c \times \frac{l}{360}$, and this M. M. F. is expended over two air-gaps, one at the upper pole tip and the other at the lower pole tip. The value, then, of the cross M. M. F. at one pole tip is

$$3.192 \times \frac{C}{2} \times \frac{c}{2} \times \frac{l}{360}. \quad (571.)$$

If this value should equal the magnetomotive force of the field ampere-turns of the air-gap, the field at this pole tip would be entirely neutralized, in which case the machine would be unworkable owing to the excessive and violent sparking at the brushes. It follows, therefore, that, for the leading pole tip,

$$3.192 \frac{At_g}{2} > 3.192 \times \frac{C}{2} \times \frac{c}{2} \times \frac{l}{360}. \quad (572.)$$

The magnetomotive force of the field ampere-turns for the single air-gap must be greater than the magnetomotive force due to one-half the cross ampere-turns of the armature.

LIMITING VALUE OF AIR-GAP DENSITY.

3564. We may also specify the above requirement in terms of the density in the air-gap, since this density is equal to the M. M. F. divided by the length of air-gap. The following value, then, must be a positive quantity :

$$B'_g = \frac{3.192 \left[\frac{At_g}{2} - \left(\frac{C}{2} \times \frac{c}{2} \times \frac{l}{360} \right) \right]}{l_g}, \quad (573.)$$

where B'_g = density of field under leading pole tip ;
 At_g = field ampere-turns required for air-gap ;
 C = total armature current ;
 c = total number of conductors on periphery of armature ;
 l = 180° less twice the angle of lead ;
 l_g = length of single air-gap, in inches.

It is not enough to make this equation a positive quantity only; the field at this point must be sufficiently strong to overcome the self-induction of the coil which is being short-circuited and generate in it a current in the opposite direction. To ensure satisfactory working, the M. M. F. in the gap, due to the field, should be at least $1\frac{1}{2}$ to 2 times the cross M. M. F. applied to the gap, even when a large angle of lead is employed. It might appear that the demagnetizing action of the back ampere-turns would prevent a position of sparklessness being found, when a heavy current necessitated a large angle of lead; but it must be remembered that, as the back ampere-turns are increased, the cross ampere-turns are decreased, so that, although the field is reduced in strength, its distribution is more uniform. A point is, therefore, usually found where the reversing field is sufficiently strong for commutation, and it is only when an excessive current is taken from the machine that the back ampere-turns weaken the field to such an extent as to preclude sparkless operation.

3565. A further disadvantage of a weak field at the leading pole tip is that a large angle of lead is required, thereby bringing the short-circuited coil very close to the edge of the pole-piece. At this point there is a more or less abrupt change in magnetic density, and any uneven spacing of the conductors will cause them to be short-circuited at different points, relative to the pole-piece, thereby causing sparking. A variation in load will also be more likely to give rise to sparking when the point of commutation is under the pole tip.

3566. We will now find it convenient to introduce another method of denoting the value of the cross ampere-turns. The back turns extend only to the point where commutation occurs, and this is at the entering fringe of the pole-piece. Then, we may say that the cross-turns are those conductors which lie under the pole-piece and under the magnetic fringe at the edges. For all practical purposes, we may designate this fringe as equal to about four-fifths

of the length of the air-gap. The value of the cross ampere-turns At_c , still remains the same as in formula 570, only substituting this more correct definition of l , which takes into account the commutating fringe and dispenses with the reference to the value of the back ampere-turns.

3567. We have said that the M. M. F. in the gap, due to the field, should be at least $1\frac{1}{2}$ to 2 times the cross M. M. F. of the armature. We may compare the ampere-turns in the two cases, since they are proportional to the magnetomotive force. The field ampere-turns expended in the gap (At_g) take into account both the air-gaps, and the cross ampere-turns (At_c) also act through two air-gaps, at the top and bottom of the pole-pieces, respectively (see Fig. 1349). Then, we may say that the field ampere-turns for the air-gaps must be $1\frac{1}{2}$ to 2 times the cross ampere-turns. The smaller value is to be used in calculations for drum armatures, and the larger value for ring armatures. The difference in these coefficients is due to the fact that in the ring armature there is a greater amount of self-induction in the coils when short-circuited, and this requires a greater angle of lead, thereby reducing the total effective field and requiring at the same time a more powerful field for reversal, with the same number of conductors and coils as a drum armature. In order to counteract this effect as much as possible, a high density is used in the core of the ring armature, so that the self-induced current can not reach a high value, as the collapse of the extra lines of force, due to its current before short-circuiting, develops only a low E. M. F. Nevertheless, the self-induction is higher than in the loop of a drum winding. When a ring armature is constructed with many turns to a section, it may become necessary even to exceed the figure given. Another reason calling for a higher coefficient in the case of ring armatures is that the extra amount of lead which must be given to the brushes would bring the short-circuited coils very near to the pole tip, where the change in magnetic density is abrupt. To avoid this, a stronger commutating fringe is required.

Also there are some lines of force which leak across the inside of the core. With a drum winding, these lines are of no account; but they cut the inner turns of the ring coils, inducing an E. M. F. which opposes that of the outer turns.

—————

LIMITING VALUES OF CROSS AND ARMATURE AMPERE-TURNS, DRUM WINDING.

3568. Returning to the consideration of the cross ampere-turns, we have found that they should be limited to a value equal to two-thirds of the field ampere-turns required for the air-gap in the case of a bipolar drum armature; for At_g equals $1\frac{1}{2} At_c$, whence

$$At_c = \frac{2}{3} At_g = \frac{At_g}{1.5}, \quad (574.)$$

where At_c = cross ampere-turns, drum armature;

At_g = ampere-turns of field required for two air-gaps.

For a drum-wound bipolar armature, the limiting value of the cross ampere-turns is the value they have when they are equal to two-thirds the field ampere-turns required for the air-gaps.

3569. We may here introduce an expression for the total ampere-turns of the armature, which are equal to the sum of the cross ampere-turns and the back ampere-turns; or, the **armature ampere-turns**

$$At_a = At_c + At_b.$$

We have seen (formula **570**) that the cross ampere-turns

$$At_c = \frac{C}{2} \times \frac{l}{360} \times c;$$

then formula **574** may be written:

$$\frac{C}{2} \times \frac{l}{360} \times c = \frac{At_g}{1.5}. \quad (575.)$$

But the total armature ampere-turns are obviously equal (for a bipolar machine) to one-half the total number of

conductors on the surface of the armature multiplied by the current carried by each, that is, by one-half the total armature current. We may then write

$$At_a = \frac{C}{2} \times \frac{c}{2}. \quad (576.)$$

Each term of formula 575 may be divided by 2, so that

$$\frac{C}{2} \times \frac{l}{360} \times \frac{c}{2} = \frac{At_g}{3},$$

whence
$$\frac{C}{2} \times \frac{c}{2} = \frac{At_g}{3} \times \frac{360}{l} = \frac{120 At_g}{l}.$$

Since
$$At_a = \frac{C}{2} \times \frac{c}{2} \text{ (see formula 576),}$$

$$At_a = \frac{120 At_g}{l}. \quad (577.)$$

The maximum number of ampere-turns which a bipolar-drum armature may carry is equal to 120 times the field ampere-turns required for the air-gaps, divided by the angle embraced by one pole-piece.

LIMITING VALUE OF CROSS AND ARMATURE AMPERE-TURNS, RING WINDING.

3570. In the case of a bipolar ring-wound armature, we have seen (Art. 3564) that the field ampere-turns required for the air-gap must be equal to twice the cross ampere-turns. Then,

$$At_o = \frac{At_g}{2}, \quad (578.)$$

where At_o = cross ampere-turns, ring armature;

At_g = ampere-turns of field required for two air-gaps.

For a ring-wound bipolar armature, the limiting value of the cross ampere-turns is when they are equal to one-half the field ampere-turns required for the air-gaps.

3571. In the same manner as has already been proved,

it may be shown that the cross ampere-turns are equal to $\frac{C}{2} \times \frac{l}{360} \times c$, and, therefore, that

$$At_a = \frac{C}{2} \times \frac{c}{2} = \frac{At_g}{4} \times \frac{360}{l} = \frac{90 At_g}{l}. \quad (579.)$$

That is, *the maximum number of ampere-turns which a bipolar ring armature may carry is equal to 90 times the field ampere-turns required for the air-gaps, divided by the angle embraced by one pole-piece.*

3572. For the same total number of conductors on the periphery of the armature, the ring-armature core carries twice as many ampere-turns as the drum-armature core. It must be remembered, however, that the density of the lines of force due to these turns would remain the same; so that, if the two cores were of the same cross-sectional area, as, for instance, in the annular construction of core disks, the induction would be the same in both cases. As another example, suppose a magnet requires 500 ampere-turns to develop an induction of 50,000 lines of force per square inch, and it is then split in two longitudinally; each of the separate parts will require 500 ampere-turns to give the same density of lines of force as before.

LIMITING VOLUME OF CURRENT.

3573. For the purpose of determining the maximum possible output of a dynamo, we will adopt an expression for the total amount of current which the armature carries. Let c = number of conductors on periphery of armature, and C' = current flowing in each conductor. We will call the whole sheet of current flowing across the armature the **volume of current**, and represent it by the letter V . Then,

$$V = C' c. \quad (580.)$$

The volume of current is equal to the current flowing in one conductor multiplied by the number of conductors on the periphery of the armature.

2410 DYNAMO-ELECTRIC MACHINE DESIGN.

3574. We may arrive at once at a figure for the value of V for bipolar armatures. We have seen, by formula **576**, that the ampere-turns of the armature are equal to one-half the total number of conductors multiplied by the current carried by each, that is, equal to $\frac{C}{2} \times \frac{c}{2}$. But in this case, $\frac{C}{2} = C'$, so that the armature ampere-turns

$$At_a = C' \times \frac{c}{2}.$$

By formula **580**, $V = C' c$;

therefore, $V = 2 At_a$. (581.)

We have seen, by formula **577**, that for a bipolar drum winding the armature ampere-turns may have a maximum value of $\frac{120 At_g}{l}$; wherefore,

$$V = \frac{240 At_g}{l}. \quad (582.)$$

The maximum volume of current which a drum armature may carry is equal to 240 times the field ampere-turns required for the air-gaps, divided by the angle embraced by one pole-piece.

3575. We have also found, by formula **579**, that for a bipolar ring winding the armature ampere-turns may have a maximum value of $\frac{90 At_g}{l}$; wherefore,

$$V = \frac{180 At_g}{l}. \quad (583.)$$

The maximum volume of current which a ring armature may carry is equal to 180 times the field ampere-turns required for the air-gaps, divided by the angle embraced by one pole-piece.

3576. It will be noticed that in expressing in words the above formulas (**582** and **583**) for volume of current, we have omitted mention of the term "bipolar." It will be shown presently that these formulas are true, not only for bipolar machines, but also for those of multipolar construction.

ARMATURE AMPERE-TURNS; MULTIPOLAR DYNAMO.

3577. In Fig. 1351 the cross turns on a multipolar armature are shown by the full-line curves, and the back turns are represented by the dotted curves. The same notation is used as in the case of the bipolar armatures,

$2r$ being the double angle of lead and l the angle embraced by one pole-piece. The cross ampere-turns and back ampere-turns together constitute the armature ampere-turns, as before; that is, $At_o + At_b = At_a$. The cross ampere-

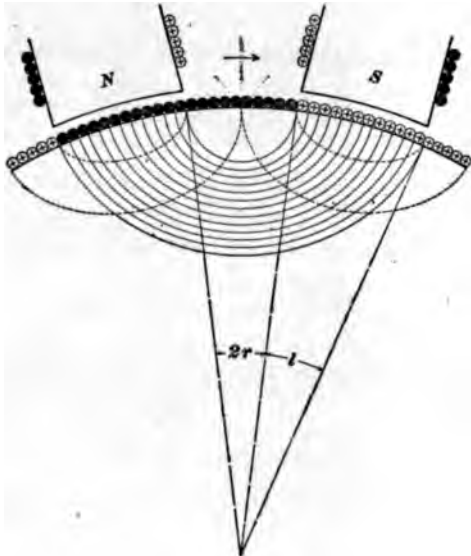

FIG. 1351.

turns, by formula **570**, are equal to $\frac{C}{2} \times \frac{l}{360} \times c$; $\frac{C}{2}$, being one-half the armature current, represents the current carried by the conductor, so that we may substitute C' , and rewrite formula **570** thus:

$$At_o = C' \times \frac{l}{360} \times c, \quad (584.)$$

where

- At_o = cross ampere-turns;
- C' = current carried by each conductor;
- l = angle embraced by pole-piece;
- c = total number of conductors.

The cross ampere-turns are equal to the current carried by one conductor multiplied by the number of conductors within the polar embrace.

2412 DYNAMO-ELECTRIC MACHINE DESIGN.

3578. The back ampere-turns may in like manner be written

$$At_b = C' \times \frac{2r}{360} \times c. \quad (585.)$$

The back ampere-turns are equal to the current carried by one conductor multiplied by the number of conductors enclosed within the double angle of lead.

3579. In the case of a bipolar dynamo, the sheet of current on one side of the armature, that is, opposite one pole-piece, constituted the armature ampere-turns, and comprised the cross ampere-turns and the back ampere-turns. In the case of a multipolar dynamo the same reasoning holds good, and the armature ampere-turns $At_a = At_c + At_b$. The armature ampere-turns are also evidently equal to the current in one conductor multiplied by the number of conductors per pole-piece; that is, $At_a = \frac{C'c}{P}$, where P = number of poles. We have seen, by formula **580**, that $C'c$ is equal to the volume of current V , so that we may say

$$At_a = \frac{V}{P}. \quad (586.)$$

The maximum number of ampere-turns which an armature may carry is equal to the volume of current flowing through the conductors divided by the number of field-magnet poles.

This formula is true of all machines, whether bipolar or multipolar, and whether the winding be in many parallel circuits or whether it form a two-circuit series, or wave, winding.

3580. If a parallel or multiple-circuit winding is used, the current in each conductor is equal to the total current divided by the number of poles, for there is one circuit for each pole-piece; thus, $C' = \frac{C}{P}$. In the case of a two-circuit winding, the current C' in any conductor is one-half the

armature current; or $C' = \frac{C}{2}$. Then, for a multiple-circuit winding, the armature ampere-turns

$$At_a = \frac{C'c}{P} = \frac{C}{P} \times \frac{c}{P} = \frac{Cc}{P^2}. \quad (587.)$$

The armature ampere-turns for a multiple-circuit winding are equal to the armature current multiplied by the number of conductors, and divided by the square of the number of poles.

3581. For a two-circuit winding,

$$At_a = \frac{C'c}{P} = \frac{C}{2} \times \frac{c}{P} = \frac{Cc}{2P}. \quad (588.)$$

The armature ampere-turns for a two-circuit winding are equal to the armature current multiplied by the number of conductors, and divided by twice the number of poles.

3582. Since the same number of magnetizing ampere-turns are used on the field whether the winding be multiple or two-circuit, the above values of the armature ampere-turns (formulas **587** and **588**) must be the same in each case. That it actually is so may be proved by a simple example. Let us take a 6-pole dynamo with 90 conductors on the armature, and let us suppose a current of 10 amperes to flow through any one conductor. Then, for a multiple-circuit winding, there will be 6 circuits; the armature current C will be 60 amperes; the number of poles P will be 6; the number of conductors c will be 90. By formula **587**, the armature ampere-turns

$$At_a = \frac{Cc}{P^2} = \frac{60 \times 90}{36} = 150.$$

For a two-circuit winding, the armature current will be $2 \times 10 = 20$ amperes, and by formula **588** the armature ampere-turns

$$At_a = \frac{Cc}{2P} = \frac{20 \times 90}{12} = 150.$$

2414 DYNAMO-ELECTRIC MACHINE DESIGN.

We may also apply formula **586** to this case, and we have

$$At_a = \frac{V}{P} = \frac{C'c}{P} = \frac{10 \times 90}{6} = 150.$$

3583. The maximum value which the cross ampere-turns may have is found by the same formula as was applied to bipolar dynamos. For a drum-wound armature, formula **574** shows that $At_o = \frac{At_g}{1.5}$. By formula **584**, we know that $At_o = C' \times \frac{l}{360} \times c$; therefore,

$$C' \times \frac{l}{360} \times c = \frac{At_g}{1.5},$$

$$\frac{C'c}{P} = \frac{At_g}{1.5} \times \frac{360}{Pl} = \frac{240 At_g}{Pl}.$$

We have seen that $At_a = \frac{C'c}{P}$;

then, $At_a = \frac{240 At_g}{Pl}$.

By formula **586**, $At_a = \frac{V}{P}$;

therefore, $V = \frac{240 At_g}{l}$.

3584. In the same manner, the maximum value of the volume of current for a ring-wound multipolar armature is found to be $V = \frac{180 At_g}{l}$.

It must be remembered that these values for the volume of current are not to be exceeded, and a margin should be allowed, suited to the work required of the machine, for cases of temporary overload.

3585. By the above formulas, which are identical with formulas **582** and **583**, it will be seen that the permissible volume of current varies directly as At_o , the field ampere-

turns required for the air-gaps, that is to say, as the length and density of the air-gap—but inversely as the polar embrace.

This latter is generally of an average value in bipolar dynamos, so that the volume of current is affected only by the length and density of the air-gap. In this type of machine, therefore, increased capacity may be obtained by increasing the size of the armature; but a longer air-gap or a greater density must also be provided to overcome the effect of the increased volume of current. With a multipolar field, however, the angle of polar embrace may be reduced, so that the same armature may be made to furnish a greater output, although both the length and the density of the air-gap remain the same.

CURRENT DENSITY IN ARMATURE CONDUCTORS.

3586. The current densities used in armature conductors vary within considerable limits, some makers preferring to keep to a low value and others using high densities. Much depends upon the mechanical construction of the winding and upon provision for ventilating, also upon the conditions under which the machine will operate. In ordinary cases it is not usual to go below 600 circular mils per ampere, and 600 to 700 is a safe figure. For special purposes, a density of 500 circular mils per ampere may be used, and again, when conditions are such that a heavy overload is to be carried at times, or the temperature of the engine room is very high, a density of 1,000 circular mils per ampere may be employed.

ARMATURE REACTION—SLOTTED CORES.

3587. Many devices have from time to time been suggested for eliminating armature reaction; but an effective method of reducing it, and one which is universally used, is to construct the armature core of slotted disks. The different

2416 DYNAMO-ELECTRIC MACHINE DESIGN.

forms of teeth, due to this slotting, will be described in their proper place, but, for the present, we will consider a representative form, as shown in Fig. 1352.

The teeth t , t , etc., taper somewhat towards the root, as the slots between them must be parallel, to allow of symmetrical winding. With this construction of core, it will be seen that the density of the lines of force in the teeth must be considerably greater than the density in the air-gap, and, in fact, a very appreciable reluctance is thus added to the magnetic circuit. The density is usually carried to 100,000

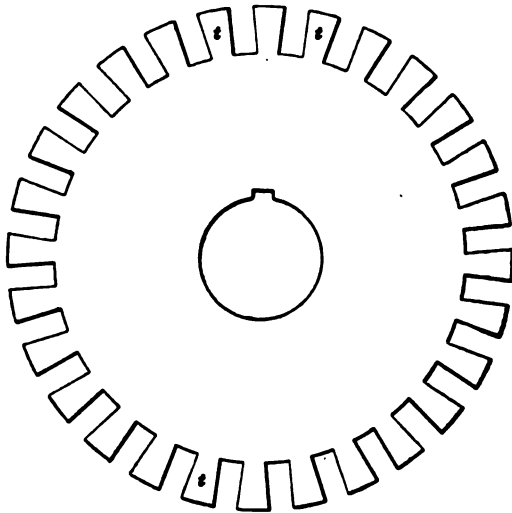

FIG. 1352.

lines per square inch, or more, so that, saturation being so nearly attained, the effect of the cross ampere-turns of the armature is far less noticeable. This saturation of the teeth, by introducing reluctance into the magnetic circuit, obviates the necessity for a large air-gap between the armature core and the pole face. The clearance is then determined, not only by the relation of the cross ampere-turns acting on the air-gap to the field ampere-turns required for the air-gap, but also by the effect produced on the magnet faces by the moving teeth.

In considering armature reaction with reference to slotted cores, we can allow a larger volume of current than could be permitted with a smooth core, on account of distortion of the field being so much less, and conditions favorable to satisfactory results will usually be secured by allowing sufficient cross-section in the armature conductors and a high density in the armature teeth, together with a well-proportioned air-gap. In general, we may allow a volume of current equal to about $1\frac{1}{2}$ times that carried by a smooth-core armature of the same class.

LENGTH OF AIR-GAP.

3588. Fig. 1353 shows the distribution of lines of force along the pole face. It will be seen that the induction is not even, but is more dense opposite the teeth.

When the armature is revolved; the rapid changes of magnetization produced by the motion of the teeth result in the heating of the pole faces by generation of eddy currents. The eddy-current loss may assume serious proportions when the changes in magnetic density are large. When the air-gap is long, that is, when the distance from the surface of the teeth to the pole face is great as compared with the width of the slot, the lines of force spread out and the density at the pole face becomes more uniform. It will be evident that the ratio of length of air-gap to width of slot must vary somewhat, according to the density in the air-gap, a higher density requiring a longer air-gap for the same width of slot. In small dynamos the density in the air-gap is rarely over 32,000 lines of force per square inch, and in such cases the length of air-gap should be not less than

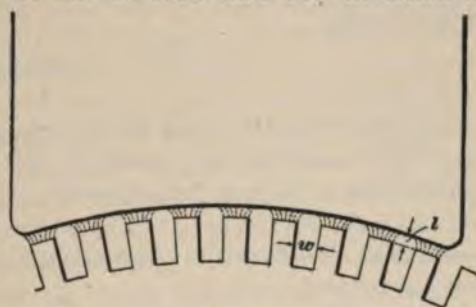

FIG. 1353.

of eddy currents. The eddy-current loss may assume serious proportions when the changes in magnetic density are large. When the air-gap is long, that is, when the distance from the surface of the teeth to the pole face is great as compared with the width of the slot, the lines of force spread out and the density at the pole face becomes more uniform. It will be evident that the ratio of length of air-gap to width of slot must vary somewhat, according to the density in the air-gap, a higher density requiring a longer air-gap for the same width of slot. In small dynamos the density in the air-gap is rarely over 32,000 lines of force per square inch, and in such cases the length of air-gap should be not less than

2418 DYNAMO-ELECTRIC MACHINE DESIGN.

one-third the width of the slot. For higher densities, this length of air-gap is not sufficient; in large machines the density may be carried even as high as 60,000 lines of force per square inch, and in that case the length of air-gap should be more than one-half the width of slot, while for an intermediate value, such as 50,000 lines per square inch, it will be safe to make the length of air-gap equal to one-half the width of slot.

3589. We will repeat the above determinations in the shape of a formula for more ready reference.

Let l = length of single air-gap (see Fig. 1353);
 w = width of armature slot (see Fig. 1353).

Then, for densities approximating 32,000 lines of force per square inch,

$$l > \frac{w}{3}. \quad (589.)$$

The length of the single air-gap must be greater than one-third the width of slot, when the air-gap density is about 32,000 lines of force per square inch.

3590. For densities approximating 50,000 lines of force per square inch,

$$l = \frac{w}{2}. \quad (590.)$$

The length of the single air-gap should be equal to one-half the width of slot, when the air-gap density is about 50,000 lines of force per square inch.

3591. Also, for high densities,

$$l > \frac{w}{2}. \quad (591.)$$

The length of the single air-gap must be greater than one-half the width of slot, when the air-gap density is about 60,000 lines of force per square inch.

ARMATURE REACTION—CONSTANT-CURRENT DYNAMOS.

3592. We may compare some of the foregoing principles with reference to their application to constant-current dynamos. In these machines armature reaction is made use of as a regulating influence, so that it is not advisable to counteract it, as in the case of constant-potential dynamos. The armature ampere-turns have almost as high a value as the field ampere-turns, so that any increase of current will produce considerable distortion and even induce a partly negative field by reason of the lines of force crossing the intervening space between the magnet poles and entering the armature. When a constant-current dynamo is short-circuited, a rise of current takes place; but its value can not increase to a dangerous extent before the field is completely neutralized and the current dies out. A constant-current dynamo is, therefore, radically different from a constant-potential dynamo, and in some respects a good design for the former type of machine would prove an exceedingly poor design for the latter. The field-magnets of an arc dynamo are large in area at the air-gap, and present a weak field, which is very susceptible to effects of armature reaction; on the other hand, as we have seen, the field of a constant-potential dynamo is strong, being designed to resist distortion by the armature current.

SMOOTH AND SLOTTED ARMATURES.

3593. Both smooth-core and toothed-core armatures have special features which make it desirable or necessary to use one or the other form in any particular case. The distinguishing characteristic of the toothed armature is its small armature reaction; so that when carbon brushes are used to take off the current, it does not become necessary to change the angle of lead for variations in load, as the high resistance of carbon will effect sparkless commutation under these conditions, as already explained in Arts. **3110** to **3112**. Further, since the smooth-core armature requires

7170 DYNAMO ELECTRIC MACHINE DESIGN.

that the position of the brushes be changed for every change of load, it will be at once understood wherein lie the special applications of the two types of machines. For electric-lighting dynamos, where the load comes on at a steady rate, without sensible fluctuations, and always at the same hour of day, the smooth core armature is preferable; but in railway central station work the load is constantly varying, sometimes within very wide limits, and as it is impossible to move the brushes to suit such a load, the toothed armature is adopted for these machines. It may further be said that for this class of work the toothed armature *must* be used. It might be supposed that the advantages of a stiff field—that is a field free from distortion, would be so evident that a toothed armature should be used under all circumstances. This form of armature has, however, its disadvantages. The coils being wound between projecting iron teeth considerable self-induction occurs when the coils are short-circuited, which, of course, tends to produce sparking. This effect may be counteracted to a large extent by making the density in the teeth very high. There will then be a change in the number of lines of force when a coil is short-circuited at the leading pole tip, owing to the saturation of the teeth by lines of force from the field-magnet. In a smooth core machine, comparatively little self-induction takes place, and since in an electric light station an attendant is always at hand, the brushes can easily be adjusted, at intervals, to the load as it rises or falls.

1501. For electroplating, where heavy currents are carried, it is important that the self-induction should be kept as low as possible, and smooth core machines are therefore used for this work.

1505. In a toothed core armature the lines of force sweep suddenly across the intervening spaces between the teeth, so that eddy currents are almost entirely eliminated to the conductors. In smooth core machines, on the other hand, the conductors come more gradually under the influence of the pole piece, so that if they have much width, eddy currents are set up in them, and the loss due to this cause

may even in some cases be as great as the armature $C^2 R$ loss. When the conductors on a smooth-core armature must necessarily be of large area, in order to carry the current, they may be stranded and twisted into a cable, or they may be twisted once at a point midway across the armature face, so that the strand which is the first to enter under the pole tip at one portion of the active length shall be the last to enter at the second portion. This will prevent longitudinal currents being set up in the different strands, which, being connected together at the ends, would form closed loops in which a current would circulate when the conductor was entering under or leaving the pole tips.

3596. A considerable advantage offered by the toothed-core construction is that the conductors are driven positively and directly by the projecting teeth, making a specially valuable construction for cases in which an essential requirement is that a powerful torque shall be exerted. In the smooth-core winding, the conductors may be prevented from slipping by the insertion of driving pins; but this method of building can not be used when heavy loads are frequently applied. Another advantage of the toothed armature is the ease of ventilating, for the armature core is exposed at the teeth, and ventilating spaces may be provided which conduct streams of air radially through the core. The smooth-core armature being entirely covered, this system of ventilation can not be followed.

3597. The toothed armature requires somewhat less ampere-turns for the air-gap and teeth than the smooth-core armature for the air-gap; but the greater advantage lies in the lesser distortion of the field.

MAGNETIC DENSITIES.

DENSITY IN TEETH.

3598. We have seen that there are two reasons which call for a high density of lines of force in the teeth of a slotted armature: the introduction of reluctance into the magnetic circuit of the cross ampere-turns, and the dampening

2422 DYNAMO-ELECTRIC MACHINE DESIGN.

of self-induction in the short-circuited coils. The usual density in the teeth is about 100,000 lines of force per square inch; but it is frequently much higher, and may reach 120,000 lines per square inch.

In the design of quite small dynamos with toothed armatures, it is not advisable to use a very high density in the teeth, because a too large percentage of the possible output of the machine will be required to maintain the field, the efficiency being, at the best, rather low.

DENSITY IN MAGNET CORE.

3599. The density is carried to a rather high point in the field-magnet core, in order to guard against instability of E. M. F. If the working point is situated below the knee of the curve, any slight drop in speed will cause an appreciable decrease in the number of lines of force, which will react on the armature and lower the E. M. F. When the working point is higher up on the curve, slight variations in speed are not so noticeable. It is, however, sometimes desirable to work rather low on the curve, in order to allow for the effect of series turns in compounding; when a dynamo is considerably overcompounded, it becomes necessary to have a comparatively low density at no load. The magnet cores may be made of cast iron, cast steel, or wrought-iron forgings. Cast iron may be worked up to about 40,000 or 50,000 lines per square inch, although, since the curve of magnetization is rather straight, we may go above this latter point when necessary. Cast steel and wrought-iron forgings run quite close together, the working density being about 95,000 to 105,000, or more, lines per square inch.

DENSITY IN YOKE.

3600. The density in the yoke should not be as great as in the core, as there would be too much energy expended in maintaining the field, and no useful purpose is served by having a high reluctance in this part of the magnetic circuit. For cast iron, the density should be about 30,000 lines per

square inch; for cast steel, about 75,000 lines per square inch; and for wrought-iron forgings, about 85,000 lines per square inch.

DENSITY IN ARMATURE CORE.

3601. It is well to keep the density somewhat lower in the armature core than in the teeth, in order to avoid loss due to hysteresis; for the density is continually changing from zero to a maximum in any one part of the armature. The lines of force from the field-magnet divide where they enter the core and pass through the upper and lower halves to the farther pole-piece, producing, therefore, a minimum density at the point of division and a maximum density opposite the neutral space between the poles. The density in the armature core may be taken as about 85,000 or 90,000 lines of force per square inch, for drum armatures. For ring armatures it is usual to adopt a higher density, for the same reason that the teeth should be saturated, namely, to prevent the generation of large currents due to self-induction. The same values for density may then be taken, that is, from 100,000 to 110,000, or even as high as 120,000, lines of force per square inch.

CALCULATION OF FIELD AMPERE-TURNS.

3602. We will now consider the calculation of the ampere-turns on the field-magnets. Curves of magnetization and of permeability have already been given in the section on the Principles of Electricity and Magnetism. In the design of dynamos it is, however, much more convenient to replace the magnetizing force H in the magnetization curve by the ampere-turns per inch length of circuit. The curve, with this modification, is laid out in Fig. 1354, and the required value of the ampere-turns for any magnetic circuit can be read off at once, being simply dependent, for any given metal, upon the length of circuit and the density of the lines of force. Suppose, for example, a wrought-iron ring has a circumference of 6 inches, and a cross-section of

2424 DYNAMO-ELECTRIC MACHINE DESIGN.

1 square inch; then, to produce a density of 100,000 lines of force per square inch, it would be necessary to wind on

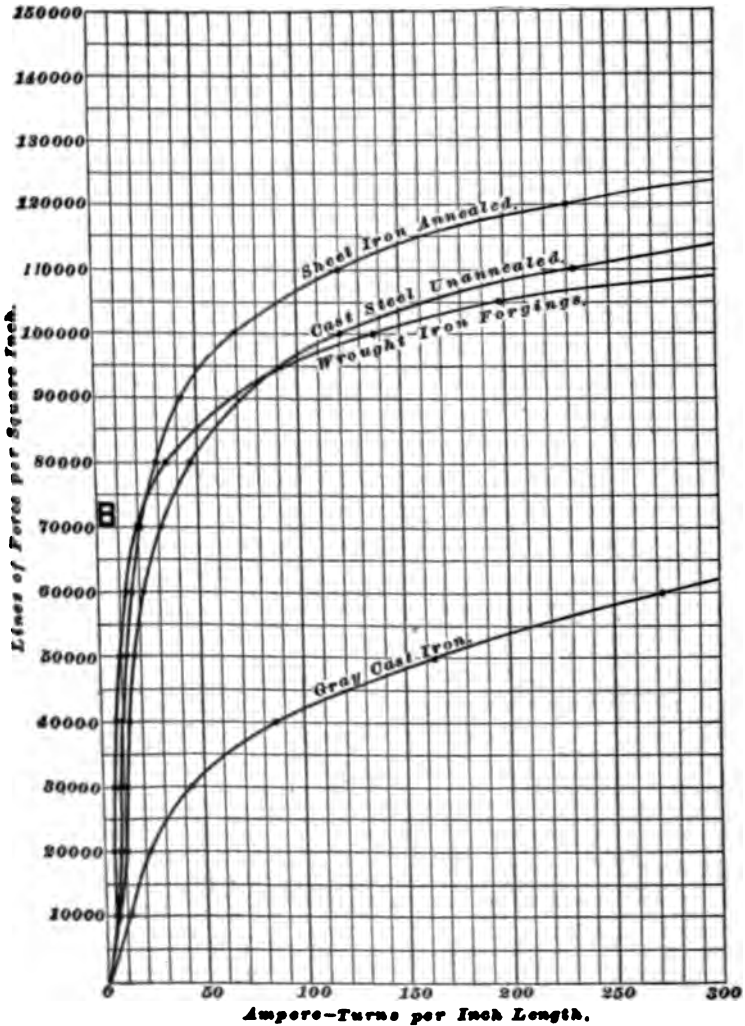

FIG. 1354.

$137 \times 6 = 822$ ampere-turns. The figure 137 is found at the intersection of the ordinate 100,000 with the curve marked

"Wrought-Iron Forgings," by following the vertical line downwards to the lower line of numbers.

3603. In discussing the theory of the dynamo, we found that the fundamental equation for E. M. F. is based on three variables: the number of conductors on the armature surface, the number of lines of force cut by those conductors, and the speed of rotation in revolutions per minute. In a smooth-core dynamo, the depth of armature winding should not ordinarily exceed $\frac{5}{16}$ inch or $\frac{3}{8}$ inch, as the heat generated is not quickly given off with a deep winding, unless special ventilation is provided; also, the area of conductor should not be less than 500 circular mils per ampere, and may require to be more in large machines. Therefore, the number of conductors for any particular armature may usually be closely approximated at first, and changed subsequently if it should be found necessary. In designing a dynamo of a similar type to some already built, it is usually possible to determine the number of conductors at once, with very little preliminary work.

3604. The diameter of the armature being known from the space occupied by the winding, the revolutions per minute at which the machine should run may be determined as soon as the peripheral speed is decided, which, as we have seen, may be from 2,000 to 3,000 feet per minute. In the formula for electromotive force above referred to, we find, therefore, that the number of lines of force may be more or less accurately predetermined. It then remains to find the number of field ampere-turns which will be required to force these lines through the several paths composing the magnetic circuit of the dynamo.

3605. These paths in the magnetic circuit may be divided under well-defined heads, namely, the magnet cores, the yoke, the pole-pieces, the armature core, the teeth, and the air-gap. An additional number of ampere-turns must also be added, to counteract the effect of the back ampere-turns of the armature.

DESIGN OF 12-HORSEPOWER DYNAMO.**ARMATURE CONDUCTORS.**

3606. For purposes of illustration, it will be convenient to consider an actual example, and we will therefore work out the field ampere-turns required for a bipolar 12-horsepower dynamo, shown diagrammatically in Fig. 1355. This, it will be seen, is the familiar horseshoe type of

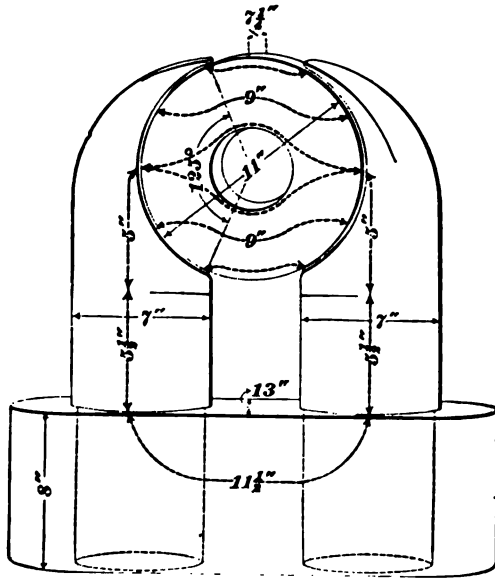

FIG. 1355.

machine, with the armature above the magnet frame. The field-magnets are wrought-iron forgings, fitted closely into a cast-iron yoke. We will first determine the size of conductor in the armature. If the E. M. F. is to be 115 volts, the current corresponding to 12-horsepower is about 78 amperes. We will allow for a supposed field loss of 2 per cent., so that the shunt current will be about 1.5 amperes. The total current will then be 79.5 amperes. We will suppose conditions are such as to require a very low current

DYNAMO-ELECTRIC MACHINE DESIGN. 2427

TABLE 110.
COPPER WIRE TABLE.

Number, American or B. & S. Gauge.	Copper Conductor.			Single Cotton-Covered Wire.			Double Cotton-Covered Wire.		
	Diameter in Mils.	Area in Circular Mils.	Resistance, Ohms per 1,000 Feet at 75° F.	Maximum Diameter in Mils.	Turns per Linear Inch.	Turns per Square Inch.	Maximum Diameter in Mils.	Turns per Linear Inch.	Turns per Square Inch.
0000	460.000	211,600.000	0.04904	472.000	1.80	3.60	478.00	1.70	3.21
000	409.600	167,800.000	0.06182	423.600	2.08	4.81	429.00	2.00	4.44
00	364.800	133,100.000	0.07798	376.800	2.38	6.29	384.00	2.32	5.98
0	324.900	105,500.000	0.09833	336.900	2.72	8.22	342.90	2.65	7.80
1	289.300	83,690.000	0.12400	301.300	3.07	10.37	307.30	2.99	9.93
2	257.600	66,370.000	0.15640	269.600	3.48	13.45	275.60	3.36	12.54
3	229.400	52,630.000	0.19720	241.400	4.00	17.33	247.40	3.80	16.04
4	204.300	41,740.000	0.24860	216.300	4.52	22.70	226.40	4.28	20.35
5	181.900	33,100.000	0.31330	193.900	5.05	27.22	207.90	4.83	25.94
6	162.000	26,250.000	0.39530	172.000	5.60	34.84	189.00	5.44	32.45
7	144.300	20,820.000	0.49840	154.300	6.23	43.12	173.30	6.08	41.07
8	128.500	16,510.000	0.62850	137.500	6.94	53.51	157.50	6.80	51.38
9	114.400	13,090.000	0.79200	122.400	7.68	65.53	142.50	7.64	64.96
10	101.900	10,380.000	0.99950	117.900	8.55	81.22	127.90	8.51	80.47
11	90.740	8,234.000	1.25900	96.740	9.60	102.40	112.70	9.58	101.97
12	80.810	6,530.000	1.59000	86.810	10.80	129.60	94.80	10.62	125.30
13	71.960	5,178.000	2.00400	77.960	12.00	161.60	80.96	11.88	156.80
14	64.080	4,107.000	2.52700	70.080	13.45	201.00	73.08	13.10	190.70
15	57.070	3,257.000	3.18600	63.070	14.90	246.60	66.07	14.68	239.40
16	50.820	2,583.000	4.01800	56.820	16.60	306.10	59.82	16.35	300.00
17	45.260	2,048.000	5.06700	51.260	18.20	368.10	54.26	18.08	363.20
18	40.300	1,624.000	6.38900	46.300	20.20	448.00	49.30	19.90	440.00
19	35.890	1,288.000	8.29000	41.890	22.60	567.10	44.89	21.83	528.50
20	31.960	1,022.000	10.16000	37.960	25.30	763.00	40.96	23.91	634.80
21	28.460	810.100	12.81000	34.460	28.60	998.80	37.40	26.20	762.70
22	25.350	642.400	16.17000	31.350	31.00	1,065.00	29.12	28.58	907.00
23	22.570	509.500	20.37000	28.570	34.30	1,307.00	30.60	31.12	1,075.00
24	20.100	404.000	25.69000	26.100	37.70	1,579.00	28.10	33.60	1,254.00
25	17.900	320.400	32.39000	23.900	41.50	1,914.00	25.90	36.20	1,456.00
26	15.940	254.100	40.85000	21.940	45.30	2,280.00	23.94	39.90	1,770.00
27	14.200	201.500	51.50000	20.200	49.40	2,711.00	22.20	42.60	2,016.00
28	12.640	159.800	64.94000	18.640	54.00	3,240.00	20.64	45.50	2,300.00
29	11.260	126.700	81.89000	17.260	58.80	3,841.00	19.36	48.00	2,560.00
30	10. 30	100.500	103.20000	16.030	64.40	4,608.00	18.03	51.10	2,901.00
31	8.928	79.700	130.20000	14.930	69.00	5,290.00	16.93	56.80	3,585.00
32	7.950	63.210	164.20000	13.950	75.00	6,250.00	15.95	60.20	4,027.00
33	7.080	50.130	207.10000	13.080	81.00	7,290.00	15.08	64.30	4,594.00
34	6.305	39.750	261.10000	12.310	87.60	8,527.00	14.31	68.60	5,230.00
35	5.515	31.520	329.20000	11.620	94.20	9,860.00	13.61	73.00	5,921.00
36	5.000	25.000	415.20000	11.000	101.00	11,330.00	13.00	78.50	6,847.00
37	4.453	19.830	523.40000	10.450	108.00	12,960.00	12.45	84.00	7,392.00
38	3.965	15.720	660.00000	9.965	115.00	13,580.00	11.96	89.10	8,821.00
39	3.531	12.470	832.40000	9.531	122.50	16,670.00	11.53	95.00	8,805.00
40	3.145	9.888	105.00000	9.145	130.00	18,780.00	11.15	102.50	11,650.00

2425 DYNAMO-ELECTRIC MACHINE DESIGN

density, and we will allow 1,000 circular mils per ampere. We shall thus require a total area of 79,500 circular mils. The armature current, however, divides into two circuits, so that the required area of the conductor is $\frac{79,500}{2} = 39,750$

circular mils. By referring to Table 110, it will be found that No. 4 wire is the nearest to this size. It is rather above the area required, and would also be hard to wind and to connect to the commutator, so we will see if we can not use another size. Two No. 7's may be substituted, or three No. 9's, the latter size giving the closest approximation to the desired cross-section.

3607. We will adopt as a preliminary estimate a total number of 252 conductors, and we will wind the armature according to the diagram in Fig. 1171, in the section on Applied Electricity. A difference of potential of about 15 volts between commutator bars will call for, say, $\frac{11}{3} \times 2 =$ about 8 segments clear between brushes, or a total of 18 segments for the whole commutator, so that the winding spaces on the armature are $18 \times 2 = 36 = w$. By formula 483 in the section referred to, $w = 2y \pm 2$, whence the pitch $y = \frac{36 \pm 2}{2} = 17$ or 19. As pointed out in connection with this formula, the smaller number (17) should be used.

SIZE OF TEETH.

3608. Having decided on the number of winding spaces, that is, on the number of *slots*, for this style of winding, we will see how we can get the wires in. On consulting the table of sizes of wire, we find that if we put three turns of No. 9 double cotton-covered wire side by side, they will occupy a space of about .43 inch. Allowing for a thickness of insulation of .035 inch each side between the wire and the teeth, we have $.43 + .07 = .5$ inch. We have taken 36 slots for the armature; therefore, the turns per slot will be $\frac{252}{36} = 7$, which means that we must provide 7 layers of the three conductors. The wires will not bed down between each

other, as there is only sufficient width in the slot to accommodate the three wires, so that the 7 layers will occupy a depth of about 1 inch. Then, allowing for insulation and for a piece of hard wood which is driven in above the wire, the depth of the slot will be 1.25 inches.

3609. Knowing the dimensions of the slot, we may now calculate the width of the tooth. Since the slot is parallel-sided, the teeth must taper; let us then take as the average width of the tooth that at a point $\frac{5}{8}$ inch from the edge. The circumference of a circle passing through this point, concentric with the outer edge of the disk, will be $9\frac{3}{4} \times \pi = 30.63$ inches. Each slot being .5 inch wide, the total figure will be $36 \times .5 = 18$ inches. Then, $30.63 - 18 = 12.63$ inches, which is the space available for the teeth. There are 36 teeth; therefore the average width of each is $\frac{12.63}{36} = .35$ inch.

3610. The tooth and slot are drawn to scale in Fig. 1356, which also shows a method of securing the strip of wood *w*. Notches are cut in the teeth, and the wood is shaped so as to drive in, making a dovetail joint. Binding wires must, however, not be omitted, as explained later on.

3611. The effective length of the armature is not $7\frac{1}{4}$ inches, as given in

the diagram, Fig. 1355; each disk is separated from its neighbor by some insulating substance, whether it be paper, or varnish, or simply the oxide which is upon the surface, so that the actual length of armature iron is reduced by about 12 per cent. In this case, therefore, the effective length is $.88 \times 7.25 = 6.38$ inches. The average area of one tooth will be $.35 \times 6.38 = 2.233$ square inches.

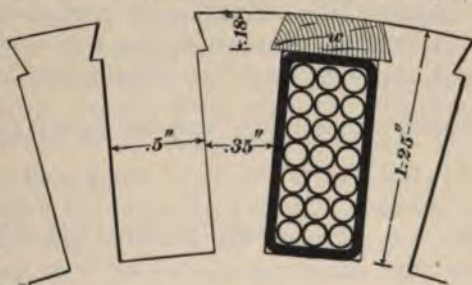

FIG. 1356.

2430 DYNAMO-ELECTRIC MACHINE DESIGN.

3612. The average polar span, Fig. 1355, is 125° ; then, the number of teeth under one pole will be $\frac{1}{2} \times 36 = 12$. The total area of the teeth under the magnet pole will be 12×2.233 equals, say, 26.8 square inches. The density of lines of force in the teeth must be, as we have seen, about 110,000 lines per square inch; therefore, the total number of lines of force in the teeth, and also in the air-gap, will be $110,000 \times 26.8$ equals, say, 2,950,000.

It is sometimes desirable, in order to avoid the necessity for a large number of slots of small size, to place two coils in one slot. One side of each coil will then occupy the lower half of one slot, and the other side of the coil will be laid in the upper half of a slot under the succeeding pole. With this arrangement, the coils should first be wound on a form to the proper shape, then taped, shellaced, and dried, after which they may be put in place, with a layer of insulating material between coils in each slot, because there will be a large difference of potential between them.

SPEED OF ROTATION.

3613. The preliminary values are now determined, with the exception of the speed of rotation of the armature. This we can obtain by modification of formula 480 in Applied Electricity, and we have $S = \frac{E \times 60 \times 10^9}{cN}$, where E is the total E. M. F. of the dynamo, c is the total number of conductors, and N is the lines of force from one pole-piece. We may calculate the probable amount of drop in E. M. F. through the armature, which it is necessary to determine before we can tell what E is. There are six No. 9 wires in multiple, which carry the total armature current of 79.5 amperes. The length of one wire on the armature surface is 7 inches, to this we add the length of one of the end connections, say 14 inches, making a total length of $21\frac{1}{2}$ inches for each of the 333 conductors. As a means of simplifying the calculation, we will take one of the six wires, and find its resistance. Each of the six circuits passes through 18 slots

before it reaches the opposite point on the commutator, and there are 7 turns per slot. Then the length of one circuit is $18 \times 7 \times 21\frac{1}{2} = 2,677$ inches = 223 feet. The resistance of No. 9 wire is .792 ohm per thousand feet; then, 223 feet = $.223 \times .792 = .1766$ ohm, and for the whole armature it will be $\frac{.1766}{6} = .0294$ ohm. Allowing for a temperature rise of 70° F., the resistance becomes .0338 ohm, and the drop in potential will be $C \times R = (78 + 1.5) \times .0338 = 2.637$ volts, allowing 1.5 amperes for the shunt. There is some resistance in the commutator connections, also in the brushes at the contact point; if the brushes are of carbon, there will be additional resistance, due to their length. If we then take an armature drop of 4 volts, we shall have sufficient margin.

We may now write out the formula for the speed :

$$S = \frac{119 \times 60 \times 10^6}{252 \times 2,950,000} = 960 \text{ rev. per min.}$$

3614. The diameter of the armature is 11 inches, and the circumference is 34.55 inches = 2.88 feet. The peripheral velocity will then be 2,765 feet per minute.

3615. We might use either 40 or 32 slots in this armature, but it would be found that a higher speed would be required in each case, and the teeth would be rather thin at the root if there were 40 of them. Also, when the number of teeth is small, the current is not likely to be so steady.

DENSITIES IN MAGNETIC CIRCUIT.

DENSITY IN AIR-GAP.

3616. In determining the density in the air-gap, we may assume a length of $\frac{1}{4}$ inch. The bore of the fields will then be $11\frac{1}{2}$ inches, and the circumference = 36.13 inches. The average polar span is 125°, therefore the width of face will be $\frac{1}{3}\frac{2}{5} \times 36.13 = 12.5$ inches. The length of face will be $7\frac{1}{2}$ inches, allowing $\frac{1}{4}$ inch for fringe, and the area of the air-gap = $7.25 \times 12.5 = 90.625$ square inches. Then the

2432 DYNAMO-ELECTRIC MACHINE DESIGN.

density will be $\frac{2,950,000}{90.625} = 32,550$ lines of force per square inch. By formula **589** we see that, when the density is about 32,000 lines of force per square inch, the length of air-gap should be greater than one-third the width of slot. The slot is .5 inch wide, so that the air-gap should be greater than $\frac{1}{3} \times \frac{1}{2}$ inch = $\frac{1}{6}$ inch = .167. We may therefore safely adopt a length of $\frac{1}{4}$ inch = .1875.

DENSITY IN MAGNET CORE.

3617. We are now in a position to find the number of lines of force in the magnet core. There will be a greater number of lines required than are used in the armature, on account of magnetic leakage, and the coefficient by which the armature induction is multiplied varies with different designs of magnetic circuit. For this form which we have under consideration we may use a coefficient of 1.25. The lines of force, then, in the field core will be $1.25 \times 2,950,000 = 3,687,500$. The core is wrought iron, 7 inches in diameter, the area being 38.48 square inches, and the density is $\frac{3,687,500}{38.48} = 96,000$ lines per square inch.

DENSITY IN YOKE AND IN POLE-PIECES.

3618. The yoke is cast iron, 8 inches by 13 inches, the area being 104 square inches. The density is $\frac{3,687,500}{104} = 35,500$ lines of force per square inch.

The average length of path of the lines in the pole-pieces is 5 inches in each, or a total of 10 inches. The density may be taken as about one-half that in the core, or, say, 50,000 lines per square inch.

AREA OF ARMATURE CORE.

3619. In the armature the value of the induction may be taken as 85,000 lines per square inch, net. The actual width of the core is 7.25 inches, but we have only 88 per cent. of iron, the effective width being 6.38 inches. The

area of the armature core is $\frac{1,475,000}{85,000} = 17.35$ square inches, half the lines of force passing above the shaft and half below. Then the radial depth of the core is $\frac{17.35}{6.38} = 2.72$ inches, or, say, $2\frac{3}{4}$ inches. Subtracting double this length and double the length of teeth from the diameter of the armature, 11 inches, we have a 3-inch circle in the center of the disks, which will serve for the shaft.

TOTAL AMPERE-TURNS.

3620. The densities in every portion of the magnetic circuit being known, we may calculate the total ampere-turns. We find the ampere-turns required for the magnet cores, the yoke, the pole-pieces, the armature core, the teeth, and the air-gaps. To these we must add the back ampere-turns of the armature. When a slotted armature is used, the armature reaction, as we have pointed out, is comparatively slight. This requires only a moderate displacement of the brushes, and since, in the machine under consideration, the pole tips are pointed, we may find a sufficiently strong field for reversing without the necessity of providing a large angle of lead, especially when carbon brushes are used, as we have supposed to be the case. We will allow, then, for two slots within the double angle of lead; there are 7 turns per slot, and each set of three conductors carries one-half the armature current, or 39.75 amperes; calling this, in round numbers, 40, the back ampere-turns will then be $2 \times 7 \times 40 = 560$. The length of the two magnet cores is 11 inches, and the density is 96,000 lines of force per square inch. By reference to the magnetization curves of Fig. 1354, we find that wrought-iron forgings at this density require 100 ampere-turns per inch length, or a total of $100 \times 11 = 1,100$ ampere-turns. The cast-iron yoke requires 66 ampere-turns per inch at the density we have given, namely, 35,500 lines per square inch; the length of

2434 DYNAMO-ELECTRIC MACHINE DESIGN.

circuit being 11.5 inches, the required ampere-turns are $66 \times 11.5 = 759$. The pole-pieces, which are part of the magnet forgings, have a total average length of 10 inches, and, at a density of 50,000 lines per square inch, require 10 ampere-turns per inch, or a total of $10 \times 10 = 100$. In the armature core we have a density of 85,000 lines per square inch, for which we must provide 34 ampere-turns per inch length, or $34 \times 9 = 306$ ampere-turns. The teeth have a higher density, namely, 110,000, and the ampere-turns per inch must be 118. The total length of the teeth is $2 \times 1.25 = 2.5$ inches, and the ampere-turns will be $119 \times 2.5 = 297$. For the determination of the ampere-turns of the air-gap we will refer to the section on Principles of Electricity and Magnetism, Art. 2400, where, by transposition of the formula for density **B**, we find that for air, which has a permeability of 1, the ampere-turns required for a given density are equal to the density multiplied by the length and divided by 3.192; or, ampere-turns = $\frac{\mathbf{B} \, l}{3.192}$. In this case the density is 32,550 lines of force per square inch = **B**; the length of double air-gap is $\frac{3}{8} = .375$ inch = *l*; and the ampere-turns for the air-gap = $\frac{32,550 \times .375}{3.192} = 3,824$

3621. We will now sum up the total ampere-turns required for the magnetic circuit, as follows:

	Length.	Area.	Density.	Ampere-Turns per Inch.	Total Ampere-Turns.
Magnet Core	11	38.48	96,000	100	1,100
Cast-Iron Yoke	$11\frac{1}{2}$	104	35,500	66	759
Pole-Pieces	10		50,000	10	100
Armature Core	9	17.35	85,000	34	306
Teeth	$2\frac{1}{2}$	26.8	110,000	118	295
Air-Gap	$\frac{3}{8}$		32,550		3,824
Back Ampere-Turns					560
Total Ampere-Turns for Field					6,944

SIZE OF SHUNT WIRE.

3622. In determining the size of wire to be used for the shunt winding, we know, approximately, the length of one turn, as we can allow a certain amount for depth of winding. In any case, variation in this dimension will not affect the size of wire necessary for the machine, which size is always the same for any given dynamo, whether the *amount* of wire used be great or small. The explanation is that, if double the number of turns be put on, this will approximately double the resistance, thereby reducing the current by one-half, so that the total number of ampere-turns remains the same. There is, however, a disadvantage in using a small amount of wire, as this necessitates a larger current. The loss in the field coils is proportional to the square of the current and only directly proportional to the resistance; therefore, it is better to increase the length of wire, so that the watts lost in heating may be as few as possible. On the other hand, an excessive amount of wire is expensive, and the weight to be used must therefore constitute a mean between cost of energy for maintaining the field and cost of copper in the field coils.

3623. Another consideration may also influence the amount of wire used, namely, the available space for winding. In machines of special construction, space may be so limited that only a little wire can be wound on the cores. In that event it is necessary to point out that ample ventilation should be provided to carry off the heat produced. The particular disadvantage, from a working point of view, of a small amount of wire is that the regulation of E. M. F. is troublesome; for the difference in resistance when hot and when cold is considerable, which causes a continual falling of E. M. F. as the fields become warm, so that a constant difference of potential is obtained only after the machine has been running for some time.

3624. The size of the shunt wire may be found at once by the following formula:

$$A = \frac{12 \times l_m \times At}{E_b - e}, \quad (592.)$$

2436 DYNAMO-ELECTRIC MACHINE DESIGN.

in which A = area of cross-section in circular mils;
 l_m = mean length in feet of one turn of wire;
 At = ampere-turns for the magnetic circuit;
 E_b = E. M. F. at the brushes;
 e = drop of potential through field regulator.

The cross-sectional area of the wire for the shunt winding of a dynamo is found by multiplying 12 times the mean length of turn by the ampere-turns and dividing this product by the E. M. F. at the brushes, less the drop in volts through the field regulator.

In this formula the factor e may be omitted when it is not proposed to use a field regulator in ordinary working, after the field coils are heated up.

3625. The coefficient 12 is derived from the resistance of 1 mil-foot of copper, which, at 75° F., is 10.8 ohms. In this formula we have allowed for a rise in temperature of 55° F., which increases the value of the coefficient to 12. This will be found to be a good general figure to use, but it may of course be modified to suit any other rise in temperature.

3626. In applying the formula to the present case, we will determine the probable length of one turn, to give the value of l_m . The diameter of the field core is 7 inches. The inside diameter of the spool is perhaps $7\frac{1}{8}$ inches, and the diameter on the winding surface $7\frac{1}{2}$ inches. We have a total winding length on the core of about $5\frac{1}{2}$ inches, and if we allow $\frac{1}{4}$ inch at top and bottom for spool flanges, there will be a net length available of $4\frac{1}{2}$ inches. With a flange $1\frac{1}{4}$ inches deep, we may wind to a thickness of about $1\frac{1}{8}$ inches, and the average length of turn will be $8\frac{3}{8} \times 3.1416 = 27.1$ in. = 2.26 feet. Allowing for the use of a field regulator only until the field coils are warm, and dispensing with it after that, the size of shunt wire will be, by formula **592**,

$$A = \frac{12 \times 2.26 \times 6,944}{115} = 1,638 \text{ circular mils.}$$

From Table 110 it will be seen that this area corresponds almost exactly to No. 18 B. & S., which is, therefore, the cor-

rect size to use. A slight variation from the exact size determined by the formula is immaterial; for if the wire is a trifle small, a very little increase in speed will suffice to bring up the E. M. F. to the required point.

3627. When designing a dynamo which is to be built on original lines, it is well to allow some margin for regulating, about 15 per cent. drop through the regulator being desirable. For standard machines, however, the less external resistance is used the better.

VALUE OF SHUNT CURRENT.

3628. We may now determine the current in the field. If we wind the spools to a depth of $1\frac{1}{8}$ inches, the cross-sectional area of the single spool will be $1\frac{1}{8} \times 4\frac{3}{4} = 5.34$ square inches, or for two spools the area = 10.68 square inches. By reference to the table of magnet wire, the wire being usually single cotton-covered, we find that we can put in 448 turns of No. 18 wire to the square inch. We would then have a total number of $10.68 \times 448 = 4,784$ turns = 2,392 turns per spool. The winding will have about 20 turns to the inch, or, for the full length of spool, about 95 to a layer. Then, since it is desirable to have only complete layers, we will choose 25, and the turns per spool will be $95 \times 25 = 2,375$, or, for both spools, 4,750 turns. The total number of ampere-turns is 6,944; therefore, the current to be used is $\frac{6,944}{4,750} = 1.46$ amperes, this being controlled by the field regulator.

3629. We are now able to determine the actual temperature rise by the application of formula **560**. The outside diameter of the spools, when overlaid with a layer of cord, will be about level with the edge of the flange, or 10 inches, and the circumference is 31.4 inches. The width being $4\frac{3}{4}$ inches, the radiating surface of each coil is $31.4 \times 4.75 = 149.3$ square inches, and for the two spools there is a radiating surface of wire of 298.6, say 300 square inches. The watts

expended in the winding are $1.46 \times 115 = 168$. Then, by formula **560**, the temperature rise

$$t = \frac{80 \times 168}{300} = 44.8 \text{ degrees Fahrenheit.}$$

It will be seen by this result that we might use less wire on our fields without an excessive rise in temperature; but the amount we have chosen will probably be more satisfactory.

3630. No material modification is introduced if we substitute for the coefficient 12 in formula **592** another coefficient based on a rise of 45° F. This would be about 11.8, and would alter the size of wire only in corresponding ratio; the area would be about 1,605 circular mils.

3631. We might allow for the permanent use of a field regulator for this dynamo by taking the next larger wire, No. 17; but its resistance is such that it would be necessary to introduce too much external resistance in series with it to produce an efficient machine. It is therefore much better to use No. 18, and, if necessary, to slightly increase the speed; or, if the speed is fixed, a combination winding can be made of Nos. 17 and 18.

RESISTANCE OF SHUNT.

3632. It is a simple calculation to determine the resistance of the shunt winding. We have found the average length of turn to be 2.26 feet; the number of turns we use is 4,750, therefore the total length is $2.26 \times 4,750 = 10,735$ feet. The resistance per 1,000 feet of No. 18 wire, at ordinary temperature, is 6.39 ohms, and the total resistance is $10.735 \times 6.39 = 68.37$ ohms. Applying formula **461** in Electrical Measurements for increase of resistance with temperature, $r_2 = 68.37 (1 + .002156 \times 45) = 75$ ohms with $t = 45$ degrees. The E. M. F. at the terminals being 115 volts, the maximum possible current after the temperature has risen will be $\frac{115}{75} = 1.53$ amperes. We require only a current of 1.10 amperes, so that this size of wire will allow of controlling E. M. F. by means of a field regulator.

RELATION OF SHUNT TO ARMATURE RESISTANCE.

3633. We have said that the question of electrical efficiency is affected by the amount of wire used in the shunt, a higher resistance giving better efficiency. The result of a high shunt resistance in parallel circuit with a low armature resistance, as in a shunt dynamo, is a smaller proportion of current subtracted from the total output; therefore, it is desirable that both these ends should be attained. The following formula is given by S. P. Thompson as showing the efficiency, with a favorable resistance in the external circuit:

$$E = \frac{1}{1 + 2\sqrt{\frac{r_a}{r_s}}}, \quad (593.)$$

where E = electrical efficiency;
 r_a = resistance of armature;
 r_s = resistance of shunt.

The electrical efficiency of a dynamo is equal to the reciprocal of the sum of 1 and twice the square root of the quotient obtained by dividing the armature resistance by the shunt resistance.

3634. We may apply this formula to the machine we have been designing as a check on the efficiency. The formula is useful rather as a means of finding at once what the resistance of the shunt should be, in order to give a certain predetermined electrical efficiency. In our case we have supposed there is a fall of potential of 4 volts through the armature at full load, so that the resistance will be $\frac{4}{79.5} = .05$ ohm. The shunt current is 1.42 amperes, and the terminal E. M. F. being 115 volts, the resistance = $\frac{115}{1.42} = 81$ ohms. Then, by formula **593**, the electrical efficiency

$$E = \frac{1}{1 + 2\sqrt{\frac{.05}{81}}} = .95, \text{ or } 95 \text{ per cent.}$$

3635. Taking formula 593 as a basis, and an electrical efficiency of 90 per cent. as a low figure, we find that, to obtain this efficiency, the resistance of the shunt must be at least 324 times that of the armature.

MAGNETIZATION CURVES.

3636. In order to demonstrate graphically the behavior of a dynamo and to assist in determining the additional ampere-turns required for the series coils in compound winding, it is convenient to lay out a **curve of magnetization**. This is obtained from the known values of the

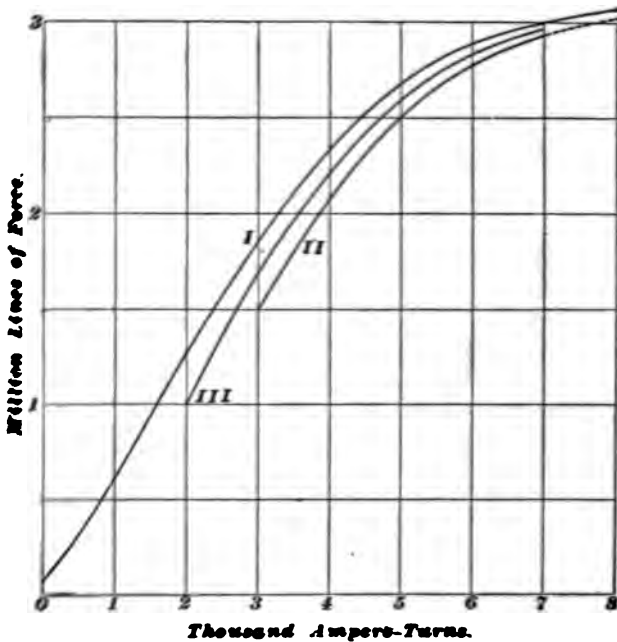

FIG. 1357.

induction in the armature and the corresponding ampere-turns required, and is extremely useful, as showing what the performance of the dynamo is likely to be, and whether the E. M. F. will be stable.

3637. A magnetization curve is given in Fig. 1357, which illustrates the action of the dynamo we have been considering. Of the curves shown, that marked *I* is the no-load curve and *II* is the full-load curve (80 amperes). It is possible to lay out these curves either by calculation or by experiment. Taking the full-load curve first, the value of the ampere-turns is marked on the scale of abscissas at the bottom—such, for instance, as the full number 6,944 previously calculated—and on the scale of ordinates the corresponding value of the induction in the armature. This would be 2,950,000 in the case supposed; the intersection of vertical and horizontal lines drawn from these points gives one point on the curve. The required ampere-turns are also calculated for other values of armature induction, and, the points being laid off, form the curve. A value may be taken, for example, of 2,500,000 lines of force in the armature; then, by the same methods of reasoning as those already explained, the total ampere-turns are to be calculated. The termination of the curve at the lower end indicates the probable point where the field would become too weak to prevent destructive sparking.

3638. The no-load curve is laid off in the same manner as the full-load curve, except that the back ampere-turns are omitted, the curve lying, therefore, higher for a given magnetizing force. This curve does not in actual practice come down to the origin θ , as there is always some residual magnetism in the iron, and we have therefore shown the outward curvature at this portion, although theoretically we might consider the curve to end at θ . We may also work out the magnetization curve for any other load, which will then lie between the limits of curves *I* and *II* in Fig. 1357.

MAGNETIZATION CURVES FROM TESTS.

3639. Magnetization curves may be plotted from readings taken when testing a dynamo that is already built. The curves are developed from the fundamental formula for E. M. F., $E = \frac{cNS}{60 \times 10^8}$, from which $N = \frac{E \times 60 \times 10^8}{cS}$.

When the no-load curve is required, the E. M. F. at the brushes may be considered to be the same as the total E. M. F., E , which takes into account the armature drop. The only current through the armature is that for the shunt, and the resistance being so low, the drop is negligible. The armature is then run at different speeds, and readings are taken of the E. M. F. at the brushes, of the speed, and of the shunt current. From the first two of the above the number of lines of force in the armature is calculated, and the number of turns on the shunt coils being known, the reading of the shunt current enables the corresponding ampere-turns to be determined. For example, suppose the speed of the machine is 850 revolutions per minute, and simultaneous readings show that the E. M. F. at the brushes is 90 volts and the shunt current is .96 ampere. Then the corresponding number of lines of force in the armature is $N = \frac{90 \times 60 \times 10^8}{252 \times 850} = 2,521,000$. There are 4,750 turns in the shunt winding, therefore the ampere turns are $.96 \times 4,750 = 4,560$. If these values for induction and ampere-turns are laid off to a suitable scale, as was shown in Fig. 1357, their intersection will give a point on the no-load curve.

3640. When the curve for full load or for any intermediate load is desired, the same readings are taken as for the no-load curve; but between the readings taken at the different speeds, the resistance of the external circuit must be changed, in order to keep the current at the constant value represented by the curve.

3641. We see that the curves of Fig. 1357 resemble the saturation curves of iron and steel in Fig. 1354, and in fact they constitute saturation curves for the magnetic circuit of the dynamo as a whole, and are frequently called by that name. It is necessary for the machine to be worked above the knee of the curve in order to give stability to the E. M. F. When, however, it is necessary to allow for the

series turns of compound winding, such a high point of saturation is not desirable with the shunt alone, but may be reached at full load.

CURVES APPLIED TO COMPOUND WINDING.

3642. The magnetization curve may be used in determining the series ampere-turns necessary for compound winding. The induction in the armature for any given E. M. F. and speed may readily be calculated, as we have shown, and the corresponding field ampere-turns may be found by reference to the curve. The values of the ampere-turns are thus found for no load and for full load, the E. M. F. and speed being usually specified for these two points. Then the difference between the values for the ampere-turns constitutes the ampere-turns required for the series winding.

3643. In order to facilitate the application of such calculations, we will consider a compound winding for the dynamo of Fig. 1355. Let us suppose the following specifications are laid down: The dynamo is to have an E. M. F. at no load of 110 volts, the speed being 1,040 revolutions per minute. At full load the E. M. F. must be 120 volts, the current output 75 amperes, and the speed 1,000 revolutions per minute. The number of conductors c in the armature is 252, as before; then the number of lines of force at no load

$$N = \frac{E \times 60 \times 10^8}{cS} = \frac{110 \times 60 \times 10^8}{252 \times 1,040} = 2,518,315.$$

By referring to the no-load curve in Fig. 1357, we see that this induction corresponds to 4,500 field ampere-turns. At full load the armature loss may be taken as 4 volts, and we will allow for the series winding a further drop in potential of 1 volt; so that the E. M. F. at full load = 120 + 4 + 1 = 125 volts. For the induction in the armature at full load we then have

$$N = \frac{125 \times 60 \times 10^8}{252 \times 1,000} = 2,980,000.$$

On the full-load curve of Fig. 1357 we find the corresponding ampere-turns to be 7,600.

3644. There is a choice of two ways in which the shunt coils may be connected; the two methods are the **long shunt** and the **short shunt**. For purposes of comparison,

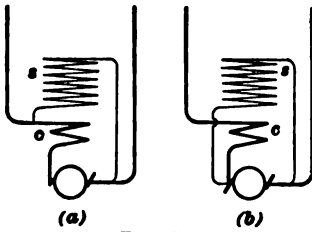

FIG. 1358

the two styles of connection are shown diagrammatically in Fig. 1358. The long shunt (a) shows that the shunt current passes through the series coil *c*, then through the shunt coil *s*; while in the short shunt (b) the shunt coil is entirely independent of the series coil, being connected directly across the brushes. In the present example we will suppose the short shunt (b) to be employed, as this is the more usual method.

3645. We have taken the armature drop as 4 volts, at full load; then, the total E. M. F. generated being 125 volts, the E. M. F. at the shunt terminals is $125 - 4 = 121$ volts. We found that for 110 volts at the terminals the ampere-turns were 4,500; then, for an E. M. F. of 121 volts the shunt ampere-turns will be $1\frac{1}{10} \times 4,500 = 4,950$. The full-load ampere-turns are 7,600; therefore the required number of series ampere-turns is $7,600 - 4,950 = 2,650$. The full-load current is given as 75 amperes, and the series turns will therefore be $\frac{2,650}{75} = 35.4$, or, say, 36 turns, 18 turns on each spool.

PROPORTION OF SHUNT AND SERIES WINDINGS.

3646. The simple number of ampere-turns for shunt and series windings is not sufficient as a guide to the actual number of turns of each which must be supplied. There must be a proper proportioning of the two windings, so that the total loss of energy is suitably divided; for if the series coil, for instance, were to be designed for an extremely low

loss, the weight of wire would be excessive, and if the wire were made too small, the rise in temperature would be too great. The easiest manner of winding is to determine the size and weight of the shunt wire according to the directions and formulas already given, and then to wind over it the series coil and proportion it with this rule in view:

Rule.—*The energy loss, in watts, of the shunt and series windings of a compound dynamo should be proportioned to the respective ampere-turns carried by each coil.*

Suppose, for example, that the shunt coils have 2,000 ampere-turns, and the loss in watts is 100; then, if the series coils have 500 ampere-turns, the loss in them should be, approximately, 25.

3647. It is not quite so easy to calculate the series winding if it is to occupy part of the spool at one end, but it is on some accounts a better way of arranging it. Suppose, then, for our dynamo we decide on this method of winding. Our spool is $4\frac{3}{4}$ inches long, and we may wind to a depth of about $1\frac{1}{2}$ inches. Then, the mean length of one turn is $8.625 \times 3.14 = 27.1$ inches, or 2.26 feet, and the ampere-turns to be supplied being 2,650, the area of cross-section of the wire is, by formula **592**,

$$A = \frac{12 \times 2.26 \times 2,650}{1} = 71,800 \text{ circular mils.}$$

A wire of this size would have to be made to order, which is out of the question; but it would in any case be too large for convenient use, and it is better to choose two or three smaller wires of equivalent cross-section. We might choose two No. 5's, but their combined areas would be rather too small; No. 6 has an area of 26,250 circular mils, and three of this size will be the best to use. In order, then, to have an even winding, we must have the width of coil such that the wires of one layer are a multiple of 3; also the number of turns is to be 18, that is, the total number of wires will be 54. If we choose 9 wires for one layer, we shall have exactly 6 layers. By reference to Table 110, we

2446 DYNAMO-ELECTRIC MACHINE DESIGN.

see that we can wind nearly 6 turns to the inch, and 9 wires will lie in a space of $1\frac{1}{2}$ inches.

3648. Allowing for a piece of vulcanized fiber $\frac{1}{2}$ inch thick between the shunt and series coils, the available space for the shunt winding will be $4\frac{1}{2} - 1\frac{1}{2} = 3$ inches. The shunt ampere-turns are 4,950, and the E. M. F. at the terminals is 121 volts. Then, by formula **592**,

$$A = \frac{12 \times 2.26 \times 4,950}{121} = 1,108 \text{ circular mils.}$$

This size of wire is between Nos. 19 and 20, but the difference is too great for us to take either one, and it is not good engineering to require special wire drawn. If we use No. 20 we can not obtain the necessary ampere-turns, and if we take No. 19 we must keep a field regulator or external resistance constantly in circuit. The most usual method of overcoming the difficulty is to use the smaller wire and increase the speed. If, however, it should be necessary to keep to the speed specified, we may effect such a combination of the two wires on each spool that the number of turns will be correct as well as the resistance, hence, also, the ampere-turns. The winding area is $3 \times 1\frac{1}{2} = 3\frac{1}{2}$, or 3.375, square inches, and we shall divide it between the two sizes of wire in inverse proportion to the resistance of each.

Let A = total winding area in cross-section•

A_1 = required area for larger wire;

A_2 = required area for smaller wire;

R_1 = specific resistance of larger wire,

R_2 = specific resistance of smaller wire;

R = sum of the specific resistances of the two wires.

$$\text{Then, } \frac{A_1}{A} = \frac{R_2}{R}, \text{ whence } A_1 = \frac{A \times R_2}{R}, \quad (594.)$$

$$\frac{A_2}{A} = \frac{R_1}{R}, \text{ and } A_2 = \frac{A \times R_1}{R}. \quad (595.)$$

The resistance per 1,000 feet—which we may call here the specific resistance—of No. 19 wire is 8.29 ohms = R_1 ; the

DYNAMO-ELECTRIC MACHINE DESIGN. 2447

resistance per 1,000 feet of No. 20 wire is 10.163 ohms = R_2 ; the sum of these is 18.45 = R . The total winding area = 3.375 square inches = A . Then, by formula 594, the area to be wound with the larger wire

$$A_1 = \frac{3.375 \times 10.163}{18.45} = 1.86 \text{ square inches.}$$

By formula 595, the area required for the smaller wire

$$A_2 = \frac{3.375 \times 8.29}{18.45} = 1.515 \text{ square inches.}$$

No. 19 wire winds about 567 turns to the square inch; therefore the turns required will be $567 \times 1.86 = 1,054$. No. 20 wire has about 763 turns per square inch, and the turns of this size will be $763 \times 1.515 = 1,157$. The total turns per spool = 2,211.

3649. In order to check these figures, we will calculate the resistance of the coil. The average length of turn is 2.26 feet. The resistance of No. 19 wire is 8.29 ohms per 1,000 feet, and that of No. 20 is 10.16 ohms. Then, the resistance of each is :

No. 19, $1,054 \times 2.26 \times .00829 = 19.7$ ohms, cold; or, 22.16 ohms, hot.

No. 20, $1,157 \times 2.26 \times .01016 = 26.5$ ohms, cold; or, 29.8 ohms, hot.

Resistance, hot, per spool = 51.96 ohms.

Resistance, hot, two spools = 103.92 ohms.

The hot resistance is calculated for a rise in temperature of 58° F. The maximum possible current which will flow through the heated shunt coils is $\frac{121}{103.9} = 1.16$ amperes.

The number of turns is $2,211 \times 2 = 4,422$, and the ampere-turns would be 5,129, which allows a slight margin over the required number of 4,950. The working current in the shunt coils = $\frac{4,950}{4,422} = 1.12$ amperes, and the watts expended = $1.12 \times 121 = 135.5$.

3650. The diameter of the outside of the coil, when covered with a layer of cord for the sake of neatness of

finish, will be 10 inches. Then the radiating surface of the coil = $31.4 \times 3 = 94.2$, and for two spools = 188.4 square inches. By formula **560**, the rise in temperature

$$t = \frac{80 \times 135.5}{188.4} = 57.6^\circ \text{ F.}$$

3651. Returning to the series coils, we have a surface for radiation of $31.4 \times 1.625 = 51.1$ square inches per spool, or 102.2 square inches total. Then the watts lost in the series coil will be $75 \times 1 = 75$, and the rise in temperature

$$t = \frac{80 \times 75}{102.2} = 58.7^\circ \text{ F.}$$

3652. If the increase in temperature involved with this winding is not considered desirable, a lower final temperature may be obtained by using a larger size of wire for the series coil, leaving the width of coil the same, but having a depth of winding of perhaps 1.5 inches. The shunt coil may be increased to the same depth, the additional wire being added in the same proportion of the two sizes. The rise in temperature under these conditions will be only about 40° F.

3653. An exact predetermined drop in potential through the series coils can not be obtained with ordinary sizes of wire, and when it is important that this should be the case, a length of strip copper is used instead of wire. This is, indeed, a more usual proceeding, and we might use such strip copper in the dynamo we have under consideration, by which means we could obtain the exact drop of one volt, which we have specified. A difference, however, of a fraction of one volt is not sufficient to debar us from using the round copper, which is more easily obtainable, unless we were considering the design of a line of machines of various sizes, or unless we desired to construct a large number of one size.

3654. When designing the series winding for an over-compounded dynamo, it is frequently the practice to allow for much larger increase in potential than that which is to be used, and to provide a shunt across the terminals of the

series coil, which may be varied as required. This shunt must be of large carrying capacity, as it may have to allow 30 per cent. of the full output to pass.

3655. Compound-wound dynamos which are worked on the upper portion of the curve of magnetization give a more uniform increase of potential than those worked on the lower portion, although, as has been pointed out, a larger number of ampere-turns is required than would be the case if a lower part of the curve were selected. When the lower part is used, the effect is to cause the E. M. F. to rise rapidly at the outset; but with heavier loads the increase in E. M. F. is more gradual. In the design of generators for power circuits, a large amount of over-compounding is required, and it is then necessary to use the lower portion of the curve, as a large range is covered, and it would otherwise call for an excessive weight of wire on the field.

CHARACTERISTIC CURVES.

THE METHOD OF DERIVING EXTERNAL CHARACTERISTICS.

3656. From the formula for electromotive force, $E = \frac{cNS}{60 \times 10^9}$, it is evident that the E. M. F. is proportional to the number of lines of force N , provided that the speed is kept constant. The shunt ampere-turns may be expressed as $At = \frac{E_b}{R} \times t$, where E_b = the E. M. F. at the brushes, which is the same as that at the shunt terminals in the short-shunt connection, R = resistance of the shunt winding, and t = number of shunt turns. It follows, therefore, that the E. M. F. at the terminals of the shunt field winding is proportional to the ampere-turns, when the resistance, which is the only other variable, is kept constant. After the machine has been running for some time, a steady temperature is attained, and the resistance then remains unchanged. It

2450 DYNAMO-ELECTRIC MACHINE DESIGN.

will therefore be seen that it is possible to lay out the values of lines of force and corresponding ampere-turns, expressed in the curves of Fig. 1357, in terms of E. M. F. generated and E. M. F. at field terminals. Such a transformation has been effected in Fig. 1359, which shows the three curves of Fig. 1357. Curve *I* is the no-load curve and curve *II* is the full-load curve. Intermediate between them is curve *III*,

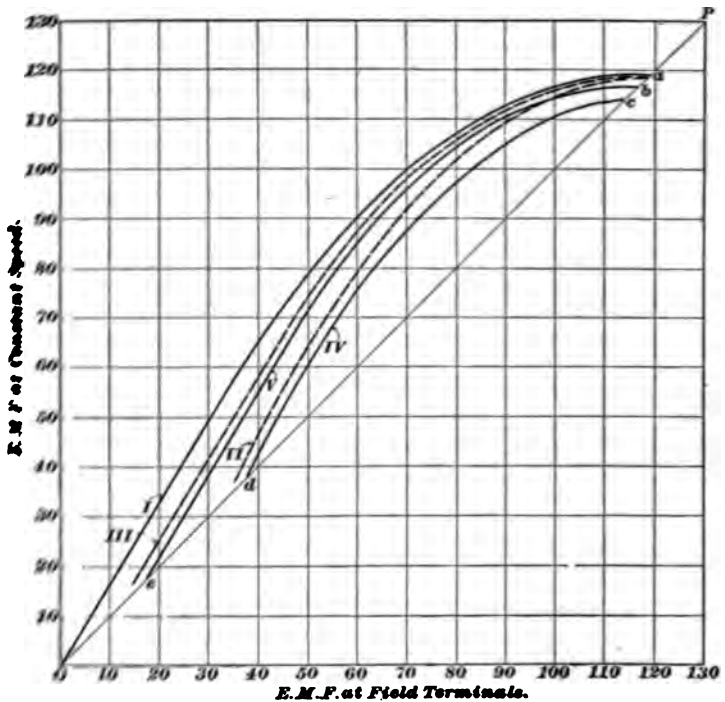

FIG. 1359.

representing half load. It will be noticed that this line is slightly nearer to the no-load curve than to the full-load curve, which is accounted for by the fact that the number of ampere-turns is less than at full load, so that a higher voltage is produced for the same field excitation. At first glance it may be supposed that the E. M. F. at the armature terminals and that at the field terminals must necessa-

rily be of the same value, when laid off by the magnetization curve. Nevertheless this is not the case, for we should then have simply a straight line for the curve of Fig. 1359, running diagonally across from O to P .

3657. We will look into the method of construction of the curves. Let us take, for example, the following values from curve I of Fig. 1357: $N = 2,000,000$; $At = 3,250$. In the machine we are considering, the number of armature conductors is $252 = c$, and the speed $S = 960$ revolutions per minute. Then, $E = \frac{252 \times 2,000,000 \times 960}{60 \times 100,000,000} = 80.6$ volts.

The field winding has 4,750 turns, with a resistance of 75 ohms, hot. Then, the E. M. F. at the shunt terminals will be

$$E_b = \frac{At \times R}{t} = \frac{3,250 \times 75}{4,750} = 51.3 \text{ volts.}$$

These two values for E. M. F. are laid off on the ruled sheet, and the point is marked where the lines drawn from the marginal numbers meet. In this manner, by taking any corresponding values of lines of force and ampere-turns from the magnetization curves, those curves may be transferred to this sheet.

3658. In a shunt-wound dynamo, the E. M. F. at the armature terminals is of course the same as that at the field terminals; therefore it follows that there are only two possible values of E. M. F. with any particular current, and these are at the points where the curves cross the diagonal OP . Curves II and III give the value of the full armature E. M. F. for the corresponding loads; but when it is desired to know the external E. M. F., that is, the E. M. F. available for the external circuit, it is necessary to subtract the loss of volts through the armature. For the full load of about 80 amperes (inclusive of shunt current) we have taken a drop of 4 volts; then the full-load curve, Fig. 1359, modified in this respect, becomes that which lies below curve II , namely, curve IV , and the half-load curve is that marked V .

2459 DYNAMO-ELECTRIC MACHINE DESIGN.

The intersection, then, of the full-line curves of Fig. 1359 with the diagonal OP shows the external E. M. F. which the machine in question will give under varying loads.

EXTERNAL CHARACTERISTICS OF SHUNT DYNAMOS.

3659. The performance of a dynamo under load may be more graphically shown by means of what is called a **characteristic curve**, or, simply, **characteristic**, which may be at once constructed from the data given in Fig. 1359. The external characteristic of the shunt dynamo described is drawn in Fig. 1360. The ordinates represent the external

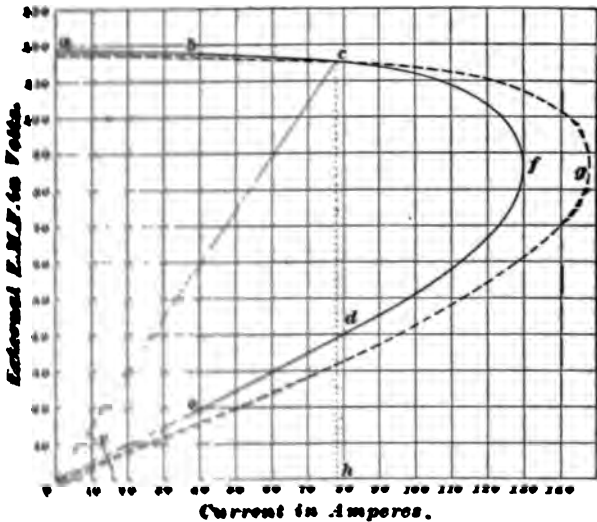

FIG. 1360.

E. M. F. in volts, and the abscissas the current in the external circuit in amperes, these values being ordinarily laid out on the same scale, as shown, as this ensures uniformity in the general appearance of the characteristics.

The points on the no-load curve are at a and o . In determining the points on the curve for any load, as, for example, half-load, the intersection of the half-load curve in Fig. 1359

with the diagonal is noted; from the half-load current of, say, 40 amperes is deducted the shunt current, and the values for E. M. F. and current are marked on the characteristic at *b*. In the same manner the full-load current less the shunt current is marked at *c*. The lower values of E. M. F. for these external currents are also laid off at *d* and *e*. If still larger currents were shown on the curves of magnetization, they might be transferred to the curve of the external characteristic, but a limit is reached after a time, when no further decrease in the external resistance will cause the current to increase. This is at the point *f*, where the characteristic begins to bend around and fall very rapidly.

RESISTANCE IN THE CHARACTERISTIC.

3660. The current and E. M. F. being, as we have said, laid off to the same scale, the slope of a line drawn from the origin *o* to any point on the curve, such as *c*, gives the value of the external resistance with that load. The resistance is equal to the electromotive force divided by the current. Suppose that, at the point *c*, the E. M. F. is 115 volts, and the current is 78 amperes; then the resistance is $\frac{115}{78} = 1.475$ ohms. But in the triangle *c o h* the side *c h* represents 115 divisions, and the side *o h* 78 divisions; also, $\frac{c h}{o h}$ is the tangent of the angle *r*; therefore, *the resistance of the external circuit corresponding to any point on the characteristic is equal to the tangent of the angle of slope of a line drawn from the origin to that point.*

3661. It is usually not possible to so overload a dynamo as to cause it to work on the rounded portion of the curve, because there would be great trouble from heating, and the armature would be in danger of destruction. It is certainly not advisable to so design the machine as to require working beyond the comparatively straight portion of the characteristic. When the machine is delivering the maximum current, its performance will be unsatisfactory, for any slight

2454 DYNAMO-ELECTRIC MACHINE DESIGN.

change in the external resistance will greatly affect the E. M. F., the field magnetism being unstable. If the resistance should fall so that the slope of the line coincides with the line od , which is almost a straight line, the E. M. F. and current will vary within wide limits, even though the resistance remains practically constant. This is called the **critical resistance**.

3662. The fall of the characteristic from the point of no load, when the E. M. F. is highest, is due to drop of potential through the armature and to the weakening and demagnetizing action of the armature current. In laying out this curve, we have taken the armature drop at full load as being 4 volts. This is allowing a good margin, since we found the actual resistance of the copper conductors to be only .0338 ohm, corresponding to a loss of 2.7 volts. It is possible that, if the drop at full load were measured after the machine is constructed, the loss might be less. The effect on the shape of the characteristic would then be to lengthen out the curve, so that it might pass through the point g . It is, then, evident that by lowering the resistance of the armature we increase the range of the dynamo; not that it becomes advisable, necessarily, to carry more load, but the working range becomes more extended, so that a heavy overload may be taken with less fall in E. M. F. at the terminals of the external circuit. Also, the critical resistance is reduced, as is seen by the slope of the lower portion of the curve.

CHARACTERISTIC FROM TESTS.

3663. The characteristic may be constructed by test on the machine itself. The dynamo is run at a constant speed, and the external resistance is varied, thereby producing variation in the current output. Simultaneous readings are then taken of the E. M. F. and current by means of a voltmeter and an ammeter, and these readings furnish

points on the required curve. There are two possible values of E. M. F. for each value of the external current, except the maximum, these values depending upon the resistance of the external circuit. At no load, for example, the E. M. F. may be 119 or 0, the resistance being in the first case infinitely large, and in the second case the armature terminals would be short-circuited, giving a resistance practically equal to zero. If the resistance is gradually increased from 0, the shunt current will begin to energize the field as soon as the critical resistance is passed, which, in the dynamo under consideration, would be in the neighborhood of .5 ohm.

3664. The characteristic of Fig. 1360 has been calculated for a speed of 960 revolutions per minute, and it is correct for that speed alone. With the same magnetizing ampere-turns and a higher speed, the induction in the air-gap being the same, the E. M. F. would be higher; this in its turn would increase the field ampere-turns, again raising the external E. M. F. by a slight amount. For a higher speed, therefore, the characteristic will lie higher on the upper part than for a lower speed, will make a smaller angle with the horizontal line at the lower portion, and will extend correspondingly outwards towards the right-hand side of the sheet, as shown by the dotted line. An increase in speed will, then, increase the output of the machine; for if the current is limited, as before, by the heating of the conductors, the product of electromotive force and current will be greater, that is, the watts output will be a higher figure.

3665. The value of the falling characteristic is that if the machine is short-circuited by accident, the E. M. F. will fall to zero and the output will cease. If the engine is well governed no harm will result, except it be through sudden discharge of the field, which may be a serious matter in the case of a high-voltage machine with many turns in the field winding.

CHARACTERISTICS OF SERIES DYNAMOS.

3666. The shape of the characteristic of a series dynamo is quite different from that of a shunt dynamo.

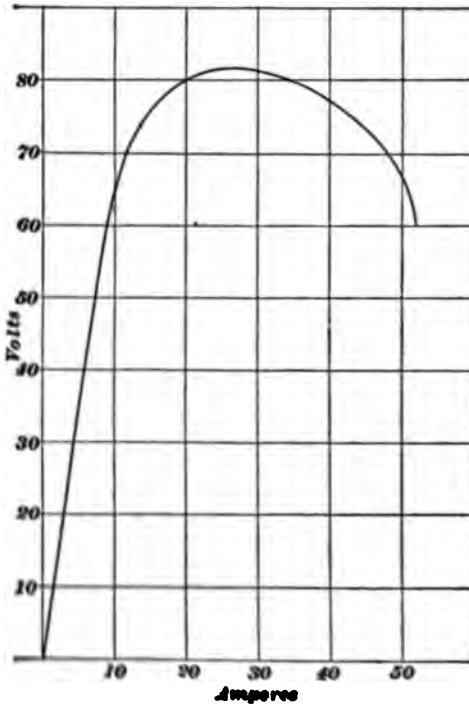

FIG. 1361.

Since almost the only use to which a series dynamo is put is to supply constant current for arc lighting, a characteristic must be chosen of such shape at the working point that variation in the resistance of the circuit will have little effect upon the current. Entire reliance can not be placed upon this method of regulation, however, and the usual current regulators must always be employed. Fig. 1361 shows the general form of the series external characteristic for a dynamo giving a current of 45 amperes at 75 volts.

3667. It will be noticed that the critical resistance is one which is *greater* than the working resistance, instead of less, as in the shunt dynamo. The general form of the characteristic is similar to a curve of magnetization, and it would approach it more nearly if the total E. M. F. were laid off, instead of the external E. M. F. The droop of the characteristic is due to loss of potential through the armature, owing to its necessarily high resistance and its self-induction; also to the fact of the armature being highly saturated before

the field-magnets reach that state, and to the demagnetizing action of the back ampere-turns, as in a shunt dynamo. These effects increase with the current, but the increase in E. M. F. being continually smaller, it reaches a point where the losses overpower it, producing thereby the droop in the curve.

EFFICIENCY.

ELECTRICAL EFFICIENCY.

3668. The electrical efficiency is the ratio of the useful output to the total output, and is therefore usually high. This ratio may be expressed in percentage as follows:

$$E = \frac{100 e C}{E C_a}, \quad (596.)$$

where

e = E. M. F. at brushes;

E = total E. M. F. generated;

C = current available for outside circuit;

C_a = total current in armature.

The electrical efficiency of a dynamo is equal to 100 times the product of the E. M. F. at the brushes and the current in the external circuit, divided by the product of the total E. M. F. of the dynamo and the total armature current.

3669. In applying this formula to our dynamo, we should get the same result. Then,

$$E = \frac{100 \times 115 \times 78}{119 \times 79.42} = 95 \text{ per cent.}$$

COMMERCIAL EFFICIENCY.

3670. The commercial or net efficiency is always lower than the electrical efficiency, because it expresses the relation between the useful output $e C$ and the power required to drive the machine, which latter is required to overcome all inherent losses caused by friction, hysteresis, and eddy currents, as well as the $C^2 R$ losses of armature and field.

2458 DYNAMO-ELECTRIC MACHINE DESIGN.

It is usually understood, when the term efficiency is applied to a dynamo, that commercial efficiency is referred to, and it is to be so taken in connection with the discussion following.

In a dynamo the mechanical energy delivered to the armature shaft is usually called the **input**; the electrical energy appearing in the external circuit from the brushes is called the **output**; and the energy converted into heat directly or indirectly in the dynamo itself is termed **energy losses**, or simply **losses**. This last term is not a strictly true one; for the energy converted into heat in the dynamo is lost only in relation to its utility—it can not be utilized to an advantage, and, if too intense, endangers the life of the machine.

From what has been stated, it will be seen that the *input* to a dynamo is always equal to the *output* at the brushes plus the *losses* in the machine itself; or, in other words, the *losses* in the dynamo are equal to the difference between the *input* and the *output*. It is assumed in the above statement that the *input*, *output*, and *losses* are reduced to the same units. For example, suppose that 20 horsepower is delivered to the armature shaft of a dynamo where the *output* from the brushes to the external circuit is 13,428 watts. Reducing the 20 horsepower to watts gives $20 \times 746 = 14,920$ watts; hence, the losses in the dynamo are equal to the difference between the input of 14,920 watts and the output of 13,428 watts, or $14,920 - 13,428 = 1,492$ watts.

3471. It is more convenient, however, to express the relation of the *input*, *output*, and *losses* of a dynamo in percentages; that is, the output as well as the losses may be expressed as a certain per cent. of the input.

I = the input of a dynamo, or the power applied at the pulley;

O = the output;

E = the per cent. commercial efficiency.

Then, the per cent. efficiency of a dynamo may be found by the formula

$$\mathbf{E} = \frac{100 \times O}{I}. \quad \mathbf{(597.)}$$

That is, to find the per cent. efficiency of a dynamo, divide the output in watts by the input in watts and multiply by 100.

For instance, in the above example, the efficiency, by formula 597,

$$E = \frac{100 \times 13,428}{14,920} = 90 \text{ per cent.}$$

3672. The relation of the input to the heat losses in a dynamo, expressed in percentage, is termed the **per cent. loss**.

Thus, letting L = the per cent. loss, the per cent. loss in a dynamo may be found by the following formula:

$$L = \frac{100(I - O)}{I}. \quad (598.)$$

To find the total per cent. loss in a dynamo, divide the difference between the input and the output in watts by the input in watts and multiply by 100.

EXAMPLE.—(a) What is the per cent. efficiency of a dynamo, if 10 horsepower is delivered to the armature shaft and the output from the brushes is equivalent to 6,841 watts? (b) What is the total per cent. loss in the dynamo when running under these conditions?

SOLUTION.—Reducing the input of 10 H. P. gives $10 \times 746 = 7,460$ watts input. (a) By formula 597, the efficiency

$$E = \frac{100 \times 6,841}{7,460} = 85 \text{ per cent. Ans.}$$

(b) By formula 598, the total loss

$$L = \frac{100(7,460 - 6,841)}{7,460} = 15 \text{ per cent. Ans.}$$

3673. When the output of a dynamo and its corresponding efficiency are given, the input necessary may be found by the following formula:

$$I = \frac{100 \times O}{E}. \quad (599.)$$

The input necessary to drive a dynamo, when its output and efficiency at that output are given, is obtained by

2460 DYNAMO-ELECTRIC MACHINE DESIGN.

dividing the output by the per cent. efficiency and multiplying the quotient by 100.

EXAMPLE.—The efficiency of a constant-potential dynamo is found to be 85% when giving an output of 6,341 watts; find the input in horsepower necessary to drive its armature shaft under these conditions.

SOLUTION.—By formula **599**, the necessary input $I = \frac{100 \times 6,341}{85} = 7,460$ watts. The equivalent of 7,460 watts in horsepower is $\frac{7,460}{746} = 10$ horsepower, which is the power required to drive the armature shaft of the dynamo under the stated conditions. **Ans.**

3674. When the input of a dynamo and its corresponding efficiency are given, the output may be found by the following formula:

$$O = \frac{I E}{100} \quad (600.)$$

The output of a dynamo, of which the input and the efficiency at that input are given, is obtained by multiplying the input by the per cent. efficiency and dividing by 100.

EXAMPLE.—An input of 35 horsepower is delivered to the shaft of a dynamo; if its efficiency at that input is 89.5%, find its output in watts.

SOLUTION.—The equivalent of 35 horsepower is $35 \times 746 = 26,110$ watts. By formula **600**, the output of the dynamo under these conditions, $O = \frac{26,110 \times 89.5}{100} = 23,368.45$ watts. **Ans.**

3675. The efficiency of a dynamo depends upon its character, construction, condition when tested, its capacity (or output), losses, and various other conditions; in fact, two dynamos of the same construction and capacity seldom show exactly the same efficiencies. The following list, however, will give the student a general idea of the approximate per cent. efficiencies which should be obtained from constant-potential machines of different capacities, or outputs, under ordinary conditions to be met with in practice:

From 750 to 1,500 watts output, inclusive, about 75% efficiency.

From 3,000 to 5,000 watts output, inclusive, about 80% efficiency.

From 7,500 to 10,000 watts output, inclusive, about 85% efficiency.

From 15,000 to 100,000 watts output, inclusive, about 90% efficiency.

From 150,000 watts output and upwards, from 91 to 93% efficiency.

LOSSES.

3676. The total loss of power in a dynamo can be separated into smaller losses, depending upon the manner in which the loss is produced and the part of the dynamo in which it occurs. In ordinary cases, all the losses will come under one of the following heads:

1. Mechanical friction loss.
 2. Core loss.
 3. Field loss.
 4. Armature loss.
-

FRICTION LOSSES.

3677. The larger part of the loss due to mechanical friction takes place usually between the bearings and journals. The brushes rubbing on the commutator also produce friction, in some cases this being equal to bearing friction and air friction combined. The per cent. of power lost in mechanical friction necessarily depends upon the construction and condition of the bearings and journals, upon the size of the machine, and to some extent on the method of driving the armature shaft. Under ordinary conditions, the loss in mechanical friction should not exceed 5% of the input of dynamos from 1,500 up to about 10,000 watts output, and 3% of the input of dynamos from 15,000 to 100,000 watts output. For example, suppose that a dynamo has an efficiency of 88% at its rated output of 22,000 watts, and a test shows that 2.5% of the input is lost in mechanical friction. The total loss in the machine is $100 - 88 = 12\%$, of which 2.5% is lost in friction; the remaining 9.5% loss is due to other causes. The total input to the machine, from

formula 600, is $\frac{22,000}{88} \times 100 = 25,000$ watts; hence, the power lost in friction is $\frac{25,000 \times 2.5}{100} = 625$ watts.

CORE LOSSES.

3678. The *core loss* is the energy converted into heat in the iron disks of the armature core when they are rotated in the magnetic field. A small portion of this loss is due to eddy currents generated in the revolving core disks; the larger portion of the loss is due to a *magnetic friction* which occurs whenever the direction of the lines of force is rapidly changed in a magnetic substance. When the magnetism of an electromagnet is rapidly reversed, that is, when the direction of the lines of force is suddenly changed several times in rapid succession by reversing the direction of the magnetizing current, the iron or steel in the core becomes heated, which necessitates a certain amount of energy being expended. This effect is called **hysteresis** (pronounced his-ter-ee'-sis).

3679. The energy expended by hysteresis is furnished by the force which causes the change in the magnetism, and, in the case of an electromagnet where the magnetism is reversed by the magnetizing current being reversed, the energy is supplied by the magnetizing current.

The same effect is produced when the iron of the armature core is rapidly rotated in the constant magnetic field of the dynamo; this case differs from the electromagnet only in the fact that the magnetic lines of force remain at rest and the iron core is made to rotate. Since the core is rotated from the armature shaft, the energy lost in hysteresis is furnished by the force which drives the shaft.

The loss of energy due to hysteresis depends (1) upon the hardness and quality of the magnetic substance in which the magnetic change takes place, (2) upon the amount of metal in which the reversal takes place, (3) upon the num-

ber of complete reversals of magnetism per second, and (4) upon the maximum density of the lines of force in the metal. Building the core of iron disks does not affect the hysteretic loss; it only reduces the eddy currents. Hysteretic loss is greatly reduced by using soft annealed iron, which exhibits only slight traces of residual magnetism; for where the residual magnetism is large, the loss due to hysteresis is large in proportion. The hysteretic loss increases in a certain ratio with the magnetic density and the number of reversals per second; hence, these quantities are kept within reasonable limits. The magnetic density in the armature rarely exceeds 85,000 lines of force per square inch; and the maximum number of complete reversals of magnetism in the armature core is about 133 per second. In bipolar dynamos the number of complete reversals of magnetism in the armature is equal to the number of revolutions per second at which the armature shaft is driven; in multipolar machines the number of reversals is equal to the number of revolutions of the armature shaft multiplied by the number of *pairs of poles*. For example, if the armature of a four-pole dynamo is driven at 600 revolutions per minute, or 10 revolutions per second, the number of complete reversals of magnetism in the armature core is $10 \times 2 = 20$ per second.

In a well-designed dynamo, the core loss, including eddy currents and hysteresis, should not exceed 2% of its input when delivering its rated output from the brushes.

FIELD LOSSES.

3680. In self-exciting dynamos, a portion of the electrical energy generated in the armature is required to excite the field-magnets. This energy is considered as one of the losses of the dynamo, since it does not appear in the external circuit and is entirely dissipated in the form of heat.

In a series-connected dynamo, where the total current from the armature passes through the magnetizing coils, the power in watts is equal to the square of the current,

2464 DYNAMO-ELECTRIC MACHINE DESIGN.

multiplied by the resistance of the series turns. If, then, C is the total current from the armature, r is the total resistance of the series coils, and W is the watts lost in the series coils, then, $W = C^2 r$. For example, suppose that a series dynamo generates 200 volts between its terminals when a current of 100 amperes is flowing from its brushes through its series coils and through the external circuit. The total output of the dynamo is then $100 \times 200 = 20,000$ watts. If the total resistance of the series coils is .1 ohm, then the number of watts (W) required to excite the field-magnets is $C^2 r = 100^2 \times .1 = 100 \times 100 \times .1 = 1,000$ watts.

3681. In a shunt dynamo which generates a nearly constant potential for limited strengths of current in the armature, the field coils usually consist of a large number of turns of fine wire, offering a high resistance compared with the field coils of a series dynamo. The power in watts $W = C E$; that is, it is equal to the current in amperes flowing through the shunt coils multiplied by the difference of potential in volts between the terminals of the shunt coils. We will suppose, for example, that the current $C = 2$ amperes and the E. M. F. $E = 110$ volts; then $W = 2 \times 110 = 220$ watts, which represents the power required by the field-magnets.

Since the power in watts can be expressed in terms of resistance and electromotive force, or resistance and strength of current, the number of watts dissipated in the shunt coil may also be expressed as $W = C^2 R$, or $W = \frac{E^2}{R}$ where $R =$ resistance of shunt.

3682. All other conditions being similar, the same number of watts will be dissipated in a shunt field coil as in a series coil, provided an equal amount of magnetizing force is produced in the two cases.

3683. In a compound-wound dynamo, the field loss consists of two losses, one in the series coil and the other in the shunt coil. The loss in the series coil depends upon the strength of current flowing from the dynamo, as in the case

of a simple series dynamo; while the loss in the shunt coil is constant, irrespective of the load on the machine; provided, of course, the dynamo generates a constant electromotive force for all loads. This can readily be understood from the following example: A dynamo is compounded to generate 220 volts between its terminals for all loads up to its rated capacity; that is, when the current from the armature becomes stronger and the difference of potential between the terminals tends to fall, the current in passing through the series coil strengthens the field-magnets sufficiently to keep a difference of exactly 220 volts between the terminals of the dynamo. Assume the resistance of the shunt coil to be 275 ohms and that of the series coil to be .055 ohm. At a rated output of 4,400 watts, the current flowing through the series coil and into the external circuit is $\frac{4,400}{220} = 20$ amperes (assuming the connections are made for a *short shunt*). At all loads, the current in the shunt coil is $C_s = \frac{E_e}{R_s} = \frac{220}{275} = .8$ ampere; and the loss of power in the shunt coil is $W_s = E_e \times C_s = 220 \times .8 = 176$ watts; even when the external circuit is open the loss in the shunt coil remains constant, or 176 watts in this particular case. The loss in the series coil, however, varies directly with the square of the current passing through it. In this example, the loss in the series coil is $W = C^2 \times r = 20^2 \times .055 = 22$ watts; at half load, or 10 amperes, the loss is $W = 10^2 \times .055 = 5.5$ watts, etc.; at no load there is no current in the series coil, and, consequently, no loss. The total field loss in a compound dynamo is the sum of the losses in the series and shunt coils. For instance, in this example, the total field loss at full load is 198 watts; at half load 181.5 watts, and at no load 176 watts.

ARMATURE LOSSES.

3684. The principal armature loss is that produced by the current in flowing against the internal resistance of the armature, that is, the resistance of the armature *conductors*. The *core losses* previously described could also be classed as

part of the armature losses; but it is usual to consider them apart. The armature loss proper is usually termed the *copper* or *wire loss*, since it is due to the resistance of the armature conductors, which are composed of copper wire or bars. The internal resistance of an armature is an exceedingly variable quantity, depending upon the form, construction, size, number of conductors, size of conductors, etc. In constant-potential dynamos, generally speaking, the internal resistance of the armature must necessarily be comparatively small, since it determines the maximum strength of current that can be obtained from the dynamo, as will be seen subsequently.

3685. The armature loss depends upon the amount of internal resistance and upon the strength of current flowing through the armature conductors. In a given armature the internal resistance remains constant at equal temperatures, while the strength of current varies with the load upon the dynamo at that particular moment; in other words, this loss occurs only when there is a current flowing through the armature—the stronger the current, the greater is the loss, and *vice versa*. In an armature the number of watts lost in the armature conductors is equal to the square of the current in amperes flowing through the armature multiplied by the internal resistance in ohms of the armature, from the positive to the negative brush.

EDDY-CURRENT LOSSES.

3686. Aside from the four principal losses mentioned, other small losses occur in some machines when the armature is revolving. If large conductors are used in the winding of the armatures, a difference of potential is sometimes generated between the edges of the conductor in such a manner as to give rise to small eddy, or local, currents in the conductors themselves, but the currents do not appear in the external circuit and are useless. In some cases these local currents dissipate considerable energy and heat the arma-

ture badly when the machine is not loaded; but in a well-designed dynamo they are too small to be considered.

3687. In a slotted armature the projecting teeth have a tendency to disturb the position of the lines of force where they enter and leave the polar faces, as we have already seen. As in the previous case, a well-designed dynamo will show but few traces of these eddy, or Foucault currents, as they are called in honor of the man who first recognized their existence. Other local currents may occur in various parts of some dynamos on account of bad design, but it is only necessary here to treat specifically upon such losses as are common to all dynamos and impossible to eliminate.

3688. From the previous articles, the following summary will be a help to establish the rules of efficiency and losses :

Input = the power driving the dynamo, which is derived from some outside agency.

Output = input minus the total losses.

Total losses = the sum of the friction, core, field, armature, and other losses.

Per cent. efficiency = $\frac{\text{input minus total losses}}{\text{input}} \times 100$,
or $\frac{\text{output}}{\text{input}} \times 100$.

Per cent. loss in friction = $\frac{\text{friction losses}}{\text{input}} \times 100$.

Per cent. loss in core = $\frac{\text{core losses}}{\text{input}} \times 100$.

Per cent. loss in field = $\frac{\text{field losses}}{\text{input}} \times 100$.

Per cent. loss in armature = $\frac{\text{armature losses}}{\text{input}} \times 100$.

MECHANICAL CONSTRUCTION.

MAGNETIC CIRCUITS.

3689. In our calculations for finding the required ampere-turns for a dynamo, we have considered in detail the different parts of the magnetic circuit. In a bipolar dynamo of the type we have considered there is but one such circuit. Although this subject has been referred to in the section on Applied Electricity, it may be well to repeat a few of the important remarks there made respecting the number of circuits in different styles of field frames.

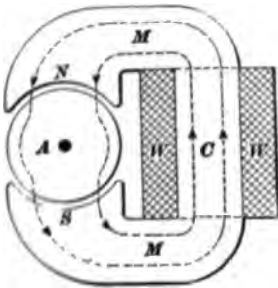

FIG. 1362.

3690. The single-circuit salient-pole type shown in Fig. 1362 has one magnetizing coil *W* which drives the lines of force through the circuit *M* and the armature *A*. If, now, we divide the field frame into two portions, each of one-half the cross-section of the frame in Fig. 1362, we shall have two circuits, in each of which the density will be the same as in Fig. 1362. The appearance of the frame will be as drawn

in Fig. 1363, where the two circuits *M*, *M'* take the place of the single circuit of Fig. 1362. Suppose Fig. 1362 requires a field winding of 10,000 ampere turns; it is all in one coil, and the difference of potential across its terminals is that of the armature,

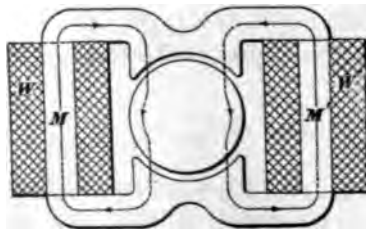

FIG. 1363.

say 120 volts. Now, in Fig. 1363 each of the coils *W*, *W'* requires 10,000 ampere-turns (approximately), because the densities are the same, also the lengths, except the length of $2d$, which is a trifle less. But two circles whose areas are equal have circumferences of a ratio 1 to .707, so that the total length of wire for the double circuit will be about 1.414 times that required for a single circuit. The size of wire

may be found by applying formula **592**. If only one magnetic circuit is considered, it will be necessary to take 60 volts as the E. M. F. across its terminals, because the two coils are to be connected in series.

3691. In the four-pole dynamo of Fig. 1364 (*a*), there are four paths along which the lines of force flow; but the

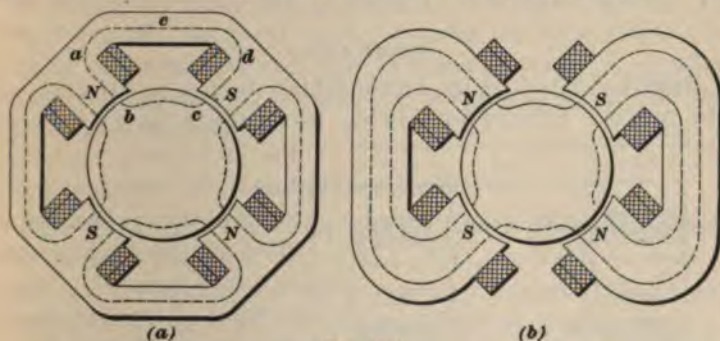

FIG. 1364.

magnetic circuits to be considered in determining the ampere-turns are only two. Another disposition of the field frame and yokes, as at (*b*), does not change the number of circuits through the armature, or the distribution of the lines of force; yet in this case there are evidently only two magnetic circuits for which the ampere-turns are to be calculated. If, therefore, we determine the densities in the different materials forming the path *a b c d e*, we may calculate the ampere-turns required for the length of that composite path or circuit, and double this number of ampere-turns will be required for the whole machine, or one-half this number will be placed on each of the four coils. In like manner, a six-pole dynamo may be considered as having three magnetic circuits, or as requiring for the whole machine three times the number of ampere-turns calculated for a single complete magnetic circuit; an eight-pole dynamo will have four magnetic circuits, and so on.

3692. It is possible to construct a bipolar dynamo for any output, but this form is not advisable for machines of more than about 15 or 20 horsepower, as they become too

heavy. There is a saving in iron by subdividing the circuits, and we have already pointed out how the volume of current may be increased by the multipolar construction. In small machines, the extra expense of multipolar fields is not warranted, as the labor bears a much greater proportion to the weight than is the case with large machines.

LEAKAGE.

3693. The leakage factor which determines the size of the magnet core is not always to be taken as 1.25, as in the foregoing calculations. In those machines having the yokes lying close to the pole-pieces, as, for example, that shown in Fig. 1365, there may be considerable leakage across from the pole tips, along the circuits indicated by the dotted lines.

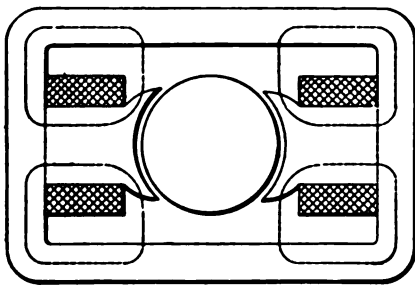

FIG. 1365.

A factor of 1.5 may then be necessary, or even a higher figure. Leakage is increased by proximity of iron or steel masses, such as bearings and their pedestals; hence, they should be placed as far away from the pole-pieces as is convenient, or if they are necessarily close, the castings should be of non-magnetic metals. With a high degree of saturation in the armature, leakage is increased. Some loss in magnetizing force due to leakage is unavoidable, but even a comparatively large leakage represents but a small per cent. of the output of the machine, so that the loss in this regard is not excessive.

ARMATURE CORES.

3694. The ratio of the diameter of an armature to its length is usually readily determined by the peripheral speed at which it is desired to run and by the density of lines of force in the armature core. For purposes of comparison, it

may, however, be stated that a proportion of about $1\frac{1}{2}$ or 2 to 1 for diameter to length will be found suitable for dynamos of about 5 horsepower and under, while the proportionate length of armature may be somewhat less for machines of about 100 horsepower, four-pole construction. Direct-connected dynamos are usually of large diameter and narrow across the armature, in order to economize space. In this type, the diameter may be three or four times the length of armature, and the peripheral speed is usually between 2,000 and 3,000 feet per minute, as in the smaller belt-driven machines.

ARMATURE DISKS.

3695. Armature disks may be either plain or slotted. The disk is punched out of the sheet, and a hole for the shaft, or the spider, is usually made by a second operation, a keyway being also cut out at the same time. When a slotted armature is required, the disk is then placed under a punching-press with a revolving table for the disk, which is automatically moved a certain distance between each stroke.

3696. Some forms of armature slots are shown in Fig. 1366. The plain slot is at (a), and a disk with round holes

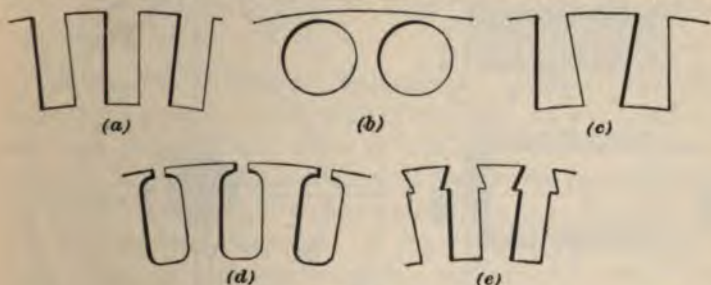

FIG. 1366.

to contain the conductors is at (b). Form (c) is a simple modification of (a), and is used for small ring-wound armatures. Form (d) is a compromise between (a) and (b). The conductors are held securely by means of a hardwood strip, which is driven in above them and is held by the projecting

2472 DYNAMO-ELECTRIC MACHINE DESIGN.

edges of the teeth. The cutting away of the connecting bridge has the effect of lessening the self-induction of the coil, which is rather large when the pierced disk (*b*) is used. The form shown at (*c*) is that which was mentioned in connection with the dynamo for which calculations were made.

3697. Disks are made of one piece up to a diameter of 25 or 30 inches, or whatever width of sheet may be obtainable. When the diameter is so great, it is of course necessary to cut another circular piece from the center, forming the disk for another and smaller machine. The thickness of the disk is usually about .022 inch, and the material should be the best soft charcoal iron, specially manufactured for the purpose. The outer disks being usually unsupported at the outer edge, thicker sheets should be used, about $\frac{1}{16}$ inch thick. Three of these at each end will be enough to hold up the teeth and prevent them from spreading.

ARMATURE SPIDERS.

3698. Fig. 1367 shows the method of mounting the disks for a ring armature of about 12 inches diameter. The inside diameter of the disks being perhaps 7 inches, they

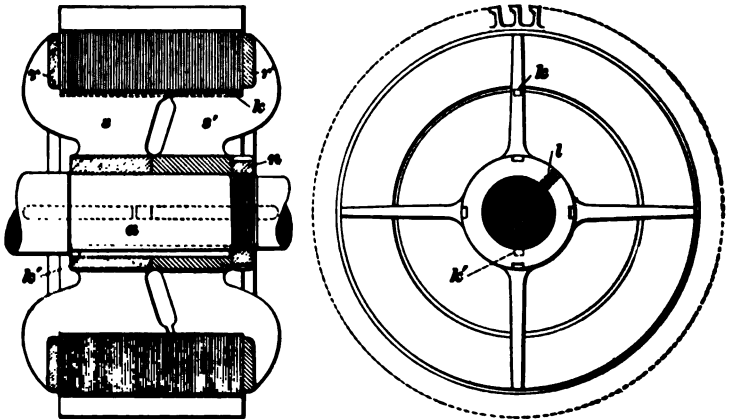

FIG. 1367.

are threaded over two spiders *s, s'* having each four arms. Each spider has a ring *r r'* at the back, which is faced up in

the lathe, and the edges of the arms are also turned true, so that the disks will slide over them and fit accurately. A small key k runs the full width of the armature, in a keyway cut in corresponding arms of both spiders, and a similar keyway in the disks enables them to be securely held in the proper position, so that they will not shift when the machine is working. The spider arm is only about $\frac{5}{16}$ inch wide at the part where this key is fitted, in order to allow space for the winding; therefore the key is made about $\frac{1}{8}$ inch wide, but the thickness is about double, measured radially. At the point where the arms join the hub, they should widen, in order to give strength to resist the twisting action communicated through the shaft. It will be noticed that the arms are continued outwards in the form of wings; these are intended to give strength to the rings r, r' , that they may hold up the disks tightly without bending at the outer edge. The wings should not project beyond the line of the winding, in a horizontal direction. The arms are shown in the end elevation as being spaced equally, and for convenience in making shop drawings they may be so put in; but it is important to remember that the arms must be exactly opposite teeth. If, then, an armature has, for example, 57 teeth, the pattern must be so constructed that the arms are opposite 1, 15, 29, and 43.

3699. It is always necessary to carefully check the winding volume on the inside of the core, to see that there is room between the arms of the spider for the armature wires. It should be remembered that space is required for insulation between the winding and the core and between the winding and the arms. A sixteenth of an inch of mica and calico, or micanite and calico, will usually suffice. This must be very carefully put on and shellaced. When computing the number of turns which will lie on the inside, sufficient clearance must be allowed for winding and manipulation, so that the actual net volume can not be counted on.

3700. In order that the disks may be readily slipped over the spiders, which is done before they are put together,

each spider is provided with two lengths of arm. Opposite arms are of the same length, as seen in full lines in the cross-sectional view of Fig. 1367; but two are shorter than the other two, as is indicated by the dotted lines at a . Each spider may thus have a number of disks laid over it, up to the full extent of the longer arms, and the two spiders are then pressed together with clamps. It is better to leave a small clearance space between the ends of opposite arms, and allow the hubs to meet on the shaft. The small key k should be shorter than the width occupied by the disks by a little less than the thickness of one of the end disks. After the disks are all in place, the spiders containing them are pressed on the shaft, and the nut n is screwed up to hold them, instead of the clamps, these being then removed. A set-screw l should be used to prevent the nut from loosening.

3701. For the purpose of reducing magnetic leakage, the spider is nearly always made of bronze for small machines. A key k' is fitted in the shaft for driving; suitable sizes for keys will be given when we take up the design of shafts. For large armatures, bronze would be too expensive, and cast iron may be used. In such cases, however, the arms should connect between poles of the same sign, so that lines of force will not leak across, as would occur if the arms were opposite N and S poles at one time.

3702. It is only in small machines that it is advisable to use a nut on the shaft for holding the spiders in place and clamping the disks. When the diameter of the armature is large, this method of construction should give place to a more secure means of fastening. In Fig. 1368 is shown a design in which bolts are used to draw up the disks to a solid body. In other respects the manner of assembling is the same as in Fig. 1367. The spiders are cast with thickened arms at the part a where the bolts are intended to pass, and holes are drilled through, into which the bolts are fitted. It is cheaper to use through bolts, as shown in the figure, than to put in cap-screws, which would require that one of the holes be drilled smaller and tapped. The arms should

be faced at those parts where the head of the bolt and the nut are to bear. The washer under the nut is a lock washer, split and bent in such a way as to prevent the nut from loosening after it is once tightened up. The bolt itself must then also be held from turning, which may be

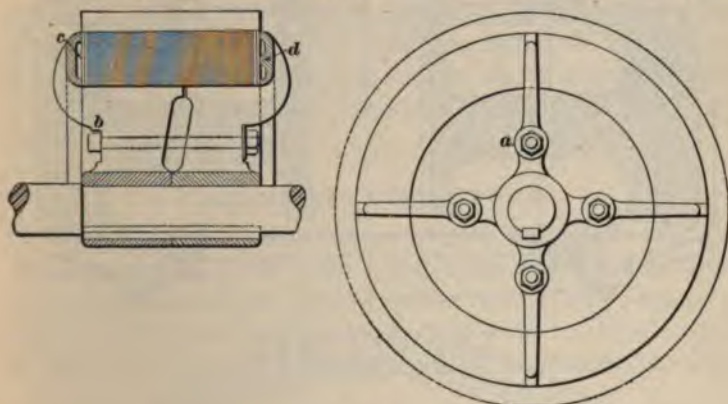

FIG. 1368.

accomplished by using a square-headed bolt and so shaping the spider arm at *b* as to almost touch the flat side of the bolt-head.

3703. In order to prevent, as far as possible, the generation of eddy currents in the spider rings, these may be cut away on the inner side, as at *c*, without thereby sacrificing any necessary strength. A central rib *d* may be left, if the ring is so large as to be likely to bend between the supporting arms.

3704. A method of strengthening the spider rings when used in connection with drum winding is shown in Fig. 1369, which represents a complete armature for a direct-connected machine. This consists in the addition of a flange *b*, following the curve of the spider arm *e*, and continued around the full circle. On the other side is a separate ring *c*, held in place by tap-bolts *d* at each arm. The armature winding *h* is drawn in, to show the space occupied by it, and

2476 DYNAMO-ELECTRIC MACHINE DESIGN.

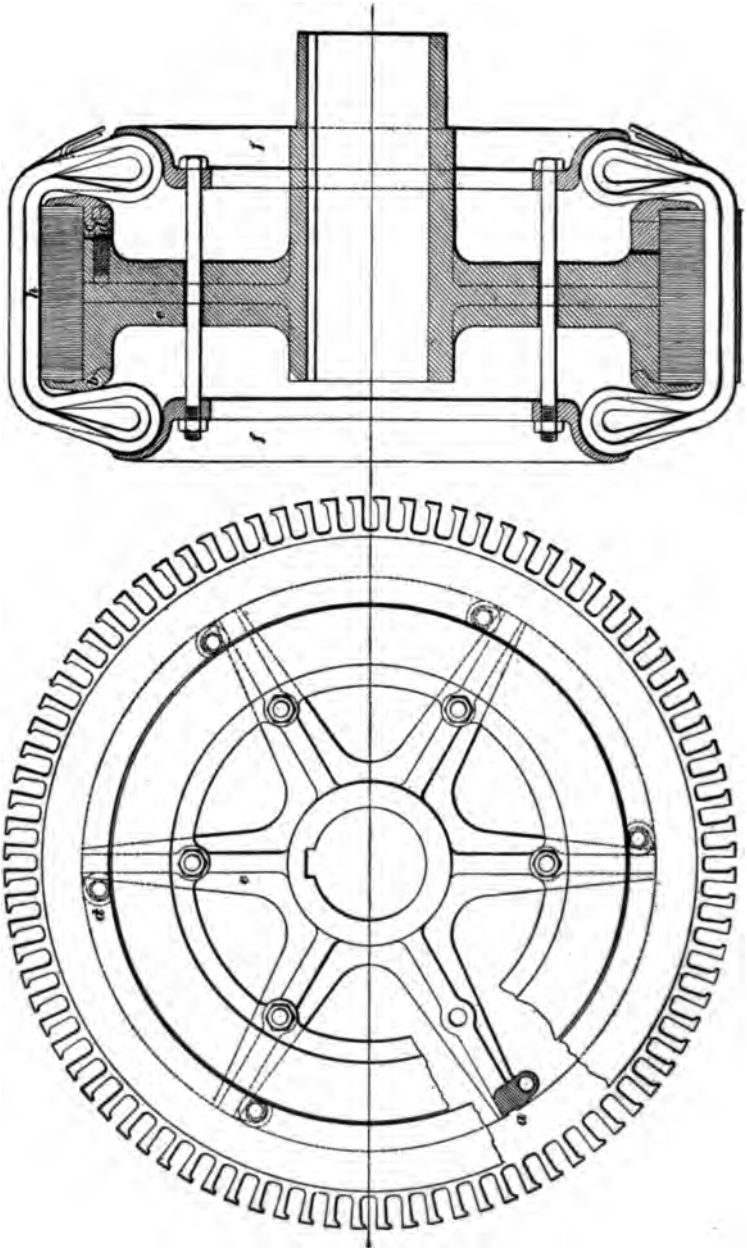

FIG. 1869.

not the exact shape of one coil, for the coils are bent around through an angle of 60° to enter the fields of two pole-pieces simultaneously. Two iron flanges f, f are used to press in the inner portions of the coils and hold them in position. At the end of one of the arms a , a groove is milled, into which fits a corresponding tongue on each disk, thereby dispensing with the use of a key. The resulting notch in the central stamping cut from this disk is cut out again when the slots are punched for a smaller armature, so that the disk is not spoiled.

ARMATURE CONDUCTORS.

3705. When armatures are of such a diameter that the disks can not be made in one piece, some method of building up the core must be devised. The iron sheets may form segments of a ring, with holes very close to the inside edge, as shown in Fig. 1370, through which insulated steel pins



FIG. 1370.

are passed. Each sheet has two such holes, a, b , Fig. 1370, so spaced that adjoining layers of disks may overlap at the joints. Another plan is to make dovetailed notches in the lower edges and to use steel keys of the same shape, which fit into these notches and are held at the outer ends in the spider rings.

3706. The insulation of the armature conductors must be very thoroughly carried out. The slots should have a lining of mica and calico, with an aggregate thickness of about .035 inch each side. Micanite may be substituted, this material being usually reliable.

2473 DYNAMO-ELECTRIC MACHINE DESIGN.

For bar windings, the conductors should be of such a size as to fit closely in the slot, after the insulation is laid in.



Fig. 1371 shows a slot having two conductors. This is a section of a two-layer winding; therefore, as explained in Art. 3154, the two conductors have between them the full difference of potential of the dynamo and must be well insulated from each other. In the sectional view shown, the conductors are separated by a strip of $\frac{1}{4}$ -inch vulcanized fiber *f*. The hard-wood strip *w* secures the conductors in place; usually this is in two pieces, each of one-half the length of the armature, and they are pressed in from each end, meeting in the middle.

3707. The use of end connectors has already been explained in Art. 3152. The end connectors need not have the same sectional area as the conductors, as they are exposed to the air. We may allow 600 or 700 circular mils per ampere, which would give us for the conductor shown in Fig. 1371 a width of $\frac{5}{8}$ inch and a thickness of, say, $\frac{3}{16}$ inch. With an armature of 19 or 20 inches diameter, these dimensions would be about correct, allowing for a four-pole magnet frame. As already stated, the end connectors should be laid out on the drawing-board, and the most suitable curve found for the spiral. This must be such that the space between succeeding spirals is as regular as possible; but it should not be necessary to construct the spiral of more than three or four curves. The copper strip, about $1\frac{1}{8}$ inches wide, has a $\frac{3}{16}$ -inch cut carried down from one end to within, say, $\frac{1}{8}$ inch of the other end, and the two ribbons so formed are bent on a form to such curves that, on springing loose, they will have the shape intended and laid out on the drawing.

3708. There is a choice of two methods of securing the end connector to the bar. One side of the bar may be milled off, as at (*a*), Fig. 1372, or the bar may be cut through, as at (*b*), and the connector inserted. The connectors are held by rivets, and the joint should also be care-

fully soldered, in order to reduce the armature resistance as much as possible. Of the two methods, the first is easier to

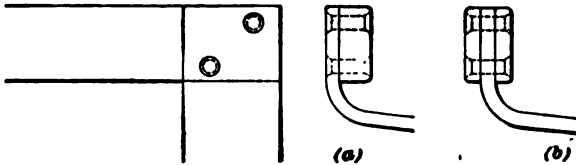

FIG. 1372.

manipulate, but the second may form a more rigid connection.

Fig. 1373 shows how the connections are drawn in for a bar-wound armature. The conductor bars are *b, b*, the end

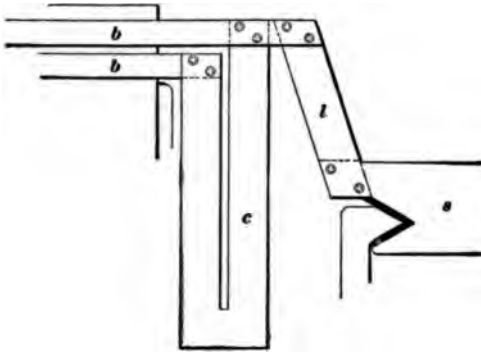

FIG. 1373.

connector is *c*, and the commutator connection is *l*; a commutator segment is shown at *s*. The connector is not actually put in as drawn, but one end, in the case of a four-pole machine, is carried around to a conductor situated 90 degrees beyond. The shape of this connector is a double spiral, as has already been pointed out.

3709. Since the commutator is a rigid body, and the bars *b* are also firmly held, it is not an easy matter to make the connections with the strips *l* if they also are rigid. It is therefore better to make these pieces of a number of thin strips of copper and to corrugate them slightly, in order that they may make a flexible connection. They are soldered and riveted on the commutator segments before assembling

the commutator, and are made fast to the projecting armature conductors after the commutator is placed in position on the shaft.

3710. An armature designed for a high E. M. F. has generally several turns per coil. It has been shown that these coils, as far as the inactive portion is concerned, are bent round in the same way as the end connectors just mentioned. The ends of the wire are then secured to the commutator segments by means of screws, or are soldered, as will be explained later.

3711. A peculiar form of winding has been introduced, in which the end connectors are carried out in line with the winding surface of the armature, thereby giving the armature a much greater length. Its peculiar shape has suggested the name of **barrel winding**. A strong claim made for this winding is that its connectors are more thoroughly exposed to the cooling action of the air, so that the armature will stand a greater load per pound of weight than can otherwise be secured.

ARMATURE VENTILATION.

3712. Ventilation of the armature should be promoted as far as possible. On this account it is inadvisable to cover

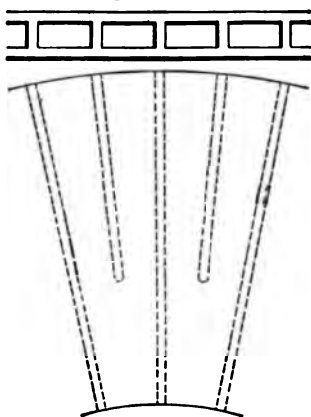

FIG. 1874.

up an armature with a canvas heading, except when the machine is likely to give trouble from sparking before it will heat excessively. The utility of the canvas covering is that it prevents the entrance of copper dust from the commutator, or carbon dust from the brushes, and on this account it is to be recommended. This covering is stretched tightly across from the edge of the armature core to the commutator ears, and is bound down closely at each of these places.

Some method of internal ventilation is necessary for slotted armatures that have a very high carrying capacity. One means of accomplishing this is to put in one or more brass castings of disk form at a little distance apart along the armature core. These disks may have radial ribs which allow of a clear space through the core, through which air is forced by centrifugal action when the armature is turning. The space occupied by these ventilators is as little as possible, consistent with the accomplishment of their purpose, and they are about $\frac{1}{4}$ inch wide. Fig. 1374 shows the general appearance of an armature ventilator, but there are many different forms.

BINDING WIRES.

3713. After the winding is in place, it must be secured with bands of wire. The material used is steel, hard brass, or phosphor-bronze, varying in thickness from No. 18 to 21 or 22. This is wound on at intervals of four or five inches along the armature, each winding being about half an inch wide. The turns are secured against working loose by soldering together, and small strips of tinned brass are sometimes introduced beneath the turns and their ends bent over and soldered to prevent the wires from spreading.

THE COMMUTATOR.

3714. The commutator is a most delicate part of a dynamo, requiring, as it does, to be built up in a solid manner when part of the material used is ill fitted for the purpose. A commutator for a small dynamo is shown in cross-section in Fig. 1375, an end view also being given. The main casting is the **shell** *a*, which at one end supports the segments *s*; at the other end a thread is cut, upon which the nut *n* screws. A wedge-shaped piece *b* is the **ring**, which fits into the segments in the same manner as the shell at the other end. The prolongation of the segment at the back end is called the **ear** or the **lug**. Its purpose is to afford a means of securing the leads from the armature.

2482 DYNAMO-ELECTRIC MACHINE DESIGN.

The segment at the level of the brush surface is not, as a rule, sufficiently wide to accommodate the screws which are used to tighten the leads, and the diameter must therefore be increased by means of the lugs. The lug at the point e is only of sufficient width to give the necessary rigidity to

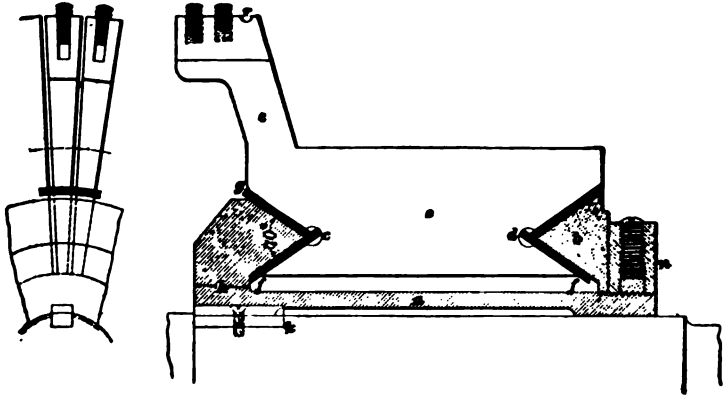

FIG. 1875.

this part, but at the upper end it must be expanded in the direction of the shaft, in order to allow room for the two headless screws and for the recess r . This is used for binding on the calico which is used to protect the winding, as previously described.

COMMUTATOR SEGMENTS.

3715. The segment is of hard copper. Plenty of metal should be allowed for turning down the commutator on the surface covered by the brushes. The bars are made to order, generally, but some standard sizes are carried in stock by large dealers. If bars are required for a commutator which is to be 6 inches in diameter at the brush surface, and the insulation between bars is .035 inch, then it is best to allow in the estimate of size for a diameter of about $6\frac{1}{2}$ inches. Suppose there are to be 60 segments. The circumference of a circle $6\frac{1}{2}$ inches in diameter is 19.242 inches.

This allows for each segment $\frac{19.242}{60} - .035 = .286$ inch

of width. If we allow for a depth of $1\frac{1}{4}$ inches below the finished surface, the thickness of the segment at its lower edge will be $\frac{3.5 \times 3.14}{60} - .035 = .148$ inch. If the required width of the lug for the armature leads is .35 inch, the diameter at this point will be $\frac{(.35 + .035) \times 60}{3.14} = 7\frac{3}{8}$ inches.

The segments are finished so carefully by a reliable manufacturer that they need no machining, except after they are set up with the insulation between, when the exposed portion is turned all over.

3716. The slots in the lugs for the armature leads should be made just wide enough and deep enough to accommodate the wires; but there must be enough material left for the screws to be securely held, and they must not penetrate the side of the lug so as to reach the insulation. The shell, ring, and nut are made of bronze.

3717. In the design shown in Fig. 1375, the angle of the head and ring where they close in upon the segments is

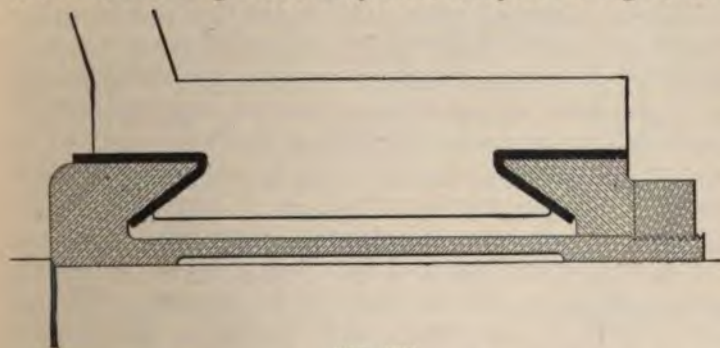

FIG. 1376.

70° . This angle has been found in practice to give good results; but there are many other designs of commutator in which some different angle is used, as, for example, that shown in Fig. 1376. Here, only a single bevel is employed, which construction effects a possible saving in the machine-shop, although it is more or less a question of personal fancy whether the single or the double bevel is used.

COMMUTATOR SHELL.

3718. To return to Fig. 1375: The segments may be cut out at the corners at c , d , to prevent the head of the shell or the ring from coming in contact with the segments by reason of the insulation being pressed aside. On this account, also, it is well to allow the insulation to project into this corner, as drawn. It will be noticed that the insulation is made to extend beyond the segments at f , f , also at g , beyond where the head of the shell touches it. The reason is that this method of construction allows of higher insulation resistance being obtained, by providing a larger surface of insulating material between the segments and the body of the commutator. It will be seen that considerable clearance is allowed between the shell at a and the segments; this space should not be less than $\frac{1}{8}$ inch, and may be $\frac{1}{4}$ inch, or more. Any unevenness in the setting of the segments will, then, not cause them to approach too nearly to the shell.

3719. It is most important that the shell at h be strong enough to withstand firmly the severe pressure which is brought to bear on it when the commutator is tightened up; for if the head should spring back, the segments are no longer held along the whole width of the bevel, and the insulation is liable to be crushed at those points where the pressure becomes concentrated. It is unnecessary that the shell should bear on the shaft throughout its whole length, and to save boring it should be cored out as shown, leaving about an inch at each end for support. It is not well to trust to the commutator holding in place on the shaft by making a close fit, for it is quite likely to work loose, and would drag at the armature connections. A small key k should therefore be set into the shaft, and may be held in place by means of a flat-headed machine-screw.

3720. The nut n may be hexagonal or may be round and provided with holes for a spanner. It may be advisable in some cases to add a second nut. The set-screw should

not press directly on the thread, as this will injure it, but a brass plug should be interposed between them.

3721. The insulation may be mica or micanite. The latter is very useful and well adapted for commutators. For use in the bevels, the thickness should be about $\frac{1}{16}$ inch, and the shape of each ring, at top and bottom, should be carefully ascertained by laying out on the drawing-board. The insulation between the bars should be about .035 inch to .04 inch and should completely fill the space between segments.

LARGE COMMUTATORS.

3722. Commutators for large machines, especially of the direct-connected type, require to be mounted on a spider, somewhat after the manner of an armature. A commutator of this type is drawn in Fig. 1377. A cast-iron spider *a* also forms the shell and extends round to one side of the segments. The ring *b* is turned to fit over the shell, and is drawn up into place by means of the tap-bolts shown. Lock washers are used, as previously described, in order to prevent the bolts from working loose. The bolts may be placed on the outside of the commutator or on the inside. The advantage of having them outside is that they are more accessible; but when they are placed on the inside they effect a saving of space, as will be seen by the figure, and this is a very desirable object in direct-connected machinery. The spider is intended to be fitted to the hub of the armature spider, which enters at *c*, and they are locked together by a suitable key. Other details on the drawing will be readily understood by reference to the preceding articles explaining the smaller commutator.

3723. Commutators for constant-potential dynamos should not have more than 15 or 16 volts difference of potential between bars, and it is better to make it less. If we provide 7 or 8 bars for each 100 volts that the machine gives, multiplied by the number of pole-pieces, this will give a safe working rule. Thus, a 500-volt four-pole dynamo will

2486 DYNAMO-ELECTRIC MACHINE DESIGN.

have $7 \times \frac{500}{100} \times 4 = 140$ bars, and, the maximum difference of potential being between adjacent poles, the number of bars spanning 500 volts is $\frac{140}{4} = 35$, giving a difference of

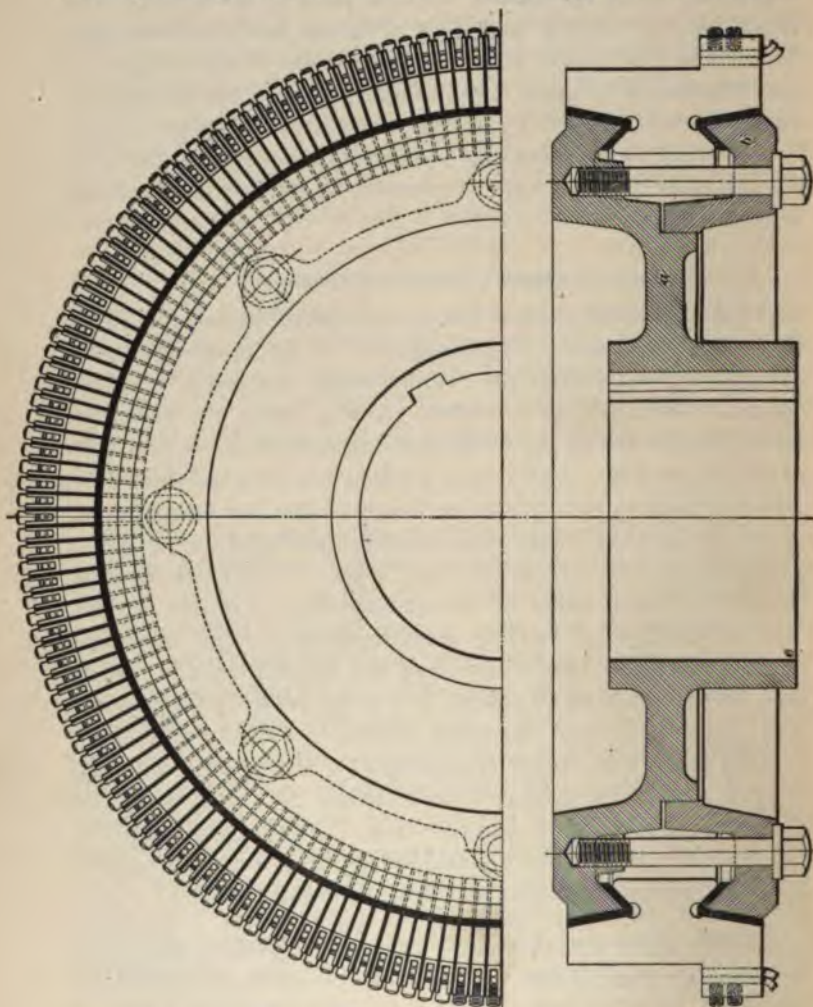

potential between each of 14.28 volts. For a ring-wound arc-light dynamo, the number of bars should be four or five for each lamp.

3724. In deciding upon the clearance between armature and commutator, enough space must be left for fastening the armature leads, so that repairs may be easily accomplished and the wires be not too much crowded together.

3725. The question of the required surface of commutator may be considered under the head of brushes. A certain clearance beyond the edge of the brush is necessary, to allow for longitudinal motion of the armature; about one-quarter of an inch is usually sufficient. For direct-connected machines the brushes may run within an eighth of an inch of the edge, as there is no relative motion in the direction of the shaft.

3726. The ratio of diameter to length of commutators for belted machines may be taken as about 1.2 to 1; that is, the diameter is 1.2 times the length. For a diameter, then, of 6 inches the length would be $\frac{6}{1.2} = 5$ inches. This rule may be observed for machines up to about 75 horsepower; but beyond this it may be advisable to increase the ratio, in order to save in total length of machine.

BRUSHES.

3727. Commutator brushes may be made of brass, copper, or carbon. The brass and copper may be in the form of leaf metal or gauze. Copper-gauze brushes are useful in the case of constant-potential dynamos for lighting, when the E. M. F. is low. These machines require constant attention, so that no advantage is secured by the use of carbon brushes, which add resistance to the circuit without it being possible to fully profit by the lesser sparking at commutation. The current density at the contact area should ordinarily not exceed 150 amperes per square inch for copper brushes, 100 amperes for brass brushes, and 30 amperes for carbon brushes.

Single brushes should never be used to collect the current,

as it should be possible to take out a brush while the machine is running, in order to trim or replace it.

3728. Since carbon brushes may be relied upon to commutate a large part of the current, they are more used than copper brushes, being smoother in their action and less wearing to the commutator. Gauze brushes are made from sheet gauze folded on itself a number of times until the required thickness—about $\frac{5}{16}$ inch—is obtained. The folding is diagonal, so that there is no trouble from wire threads slipping off at the ends. After being compressed and hammered into rectangular shape, four or five inches long and perhaps one and one-half inches wide, the end which enters the brush holder is dipped into solder to cause it to hold its shape. The commutator end is then filed to a bevel, and the brush is ready for use.

3729. Carbon brushes are simply blocks, copper plated or plain, which are fitted into a clamp and press directly down on the commutator. It is the general practice to make the brushes radial; but some manufacturers adopt an inclined position, somewhat between that of the tangential copper brush and the radial brush.

SIZE OF BRUSHES.

3730. The thickness of carbon brushes varies with the size of machine. On small dynamos the brushes are generally larger in proportion than on large dynamos, as it is not necessary to economize space to the same extent. The thickness might be about $\frac{5}{16}$ inch or $\frac{3}{8}$ inch on the smallest sizes, with a width of about 1 inch and a length of 2 inches. On larger dynamos, 10 horsepower and upwards, the thickness should increase to one-half or three-quarters of an inch. The rule already given, that the density per square inch should not exceed 30 amperes, will be a guide to the thickness required.

The thickness of a copper-leaf brush is generally from $\frac{1}{8}$ inch to $\frac{1}{4}$ inch.

BRUSH HOLDERS.

3731. The brush holder should be designed with the following points in view:

1. The carbons must be held firmly, so that they will not rattle or afford poor contact with the metallic frame.

2. An adjustable spring pressure must be provided, in order to keep the carbons down to the commutator with just enough pressure to prevent cutting of the surface while maintaining good contact.

3. The brushes must be capable of being raised and held clear of the commutator.

4. Working joints must not be relied upon to carry the full current from the brush.

3732. The really perfect brush holder has doubtless yet to be designed, for there are some faults to be found

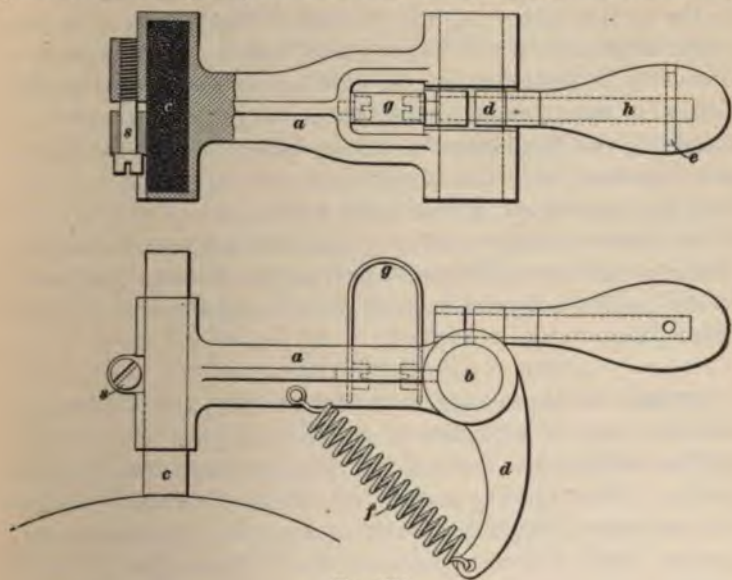

FIG. 1378.

with nearly all forms. The brush holder shown in Fig. 1378 is a fair specimen, but we will suggest, as useful exercise for the student, that he design one himself, and try to

embody in it all the points mentioned above, and, in addition, perhaps a parallel motion for the brush.

3733. With regard to the first condition, as exemplified in Fig. 1378, the carbon *c* is held firmly in a clamp in which it is an easy fit when the screw *s* is loose. On tightening the screw, the carbon is pressed in at the two ends and also, by reaction, at the sides. The brass casting *a*, of which this is part, extends back to a stud which supports it, passing through the hole *b*, upon which stud it is free to move. The frame *a* is cut away in the middle sufficiently to allow a central casting *d* to enter, which may be clamped to the stud by means of the screw attached to the handle *h*. A pin *e* is passed through the screw and handle to prevent the screw from turning in the handle. The ends of the pin should be below the surface, in order to avoid giving a shock to the person adjusting the brushes. The clamp *d* is provided with an arm at its lower side, and a tension-spring *f* connects it to the frame *a*, thereby covering the second condition mentioned above, regarding adjustment. By loosening the handle and pressing it downwards, the spring is compressed and the brush may be raised from the commutator, as required by the third condition. Then, in order to provide adequate carrying capacity without having recourse to movable joints, a strip of copper braid *g* is screwed to the casting *a* at one end and to the central clamp *d* at the other end.

3734. A brush holder which has been put to considerable use is one in which a simple frame like that of Fig. 1378 is used for the carbon, but without any such clamping device. The frame is stationary, and the carbon is pressed downwards through it to the commutator by means of a spring above, operating a lever arm. This type of brush holder is liable to rattle, as the carbon is not properly held, and, furthermore, the contact between the brush holder and the carbon is not good, so that additional resistance is introduced into the circuit at this point.

3735. A form of brush holder coming into very wide use is what is called the **reaction brush holder**, illustrated in Fig. 1379. The principal feature of this holder is that the brush *b* is wedged in between it and the commutator, without any support on the outer side, as in the more general forms of holders. The brush is beveled on the top, and a curved lever *l*, pressing downwards, forces the brush against the flat surface at the end of the holder. The lever is actuated by a spring *s*, which may be set into any one of the notches *n* on the lever, thus providing for different degrees of tension. The frame *f* is cast in one piece and carries as many levers and springs as may be needed—one for each brush. It is essential that the brushes be quite flat on the side which is pressed against the holder, and on this account it is best to use carbons which are ground or sawn true and well plated. The angle *a* between the bevel of the brush and the surface of the holder should be about 45° , and the angle *c* between the surface of the holder and the tangent to the commutator at that point should be about 60° . These angles may be varied, as is done, for instance, by the C. & C. Co., who use a much larger angle between the commutator and the holder, and put straps around the brushes.

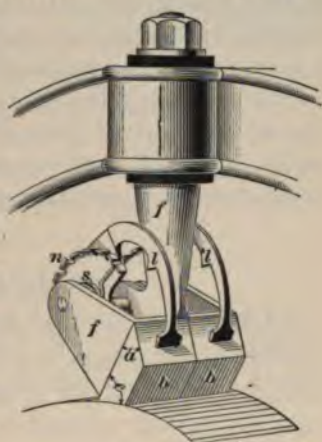

FIG. 1379.

The direction of rotation is intended to be right-handed when put on as shown in Fig. 1379; that is, from the holder towards the brush. Some builders run the armature in the reverse direction, but the brush works well either way. When the brush is worn down, the lever is held by a projecting tooth which rests upon the edge of the frame and is prevented from touching the commutator. A very light pressure may be used with this type of brush holder, and carbons last a long time.

Some of the advantages of the reaction brush holder are : it may be set very close to the commutator, thereby introducing a minimum of resistance into the circuit; the movement of the brush is in a straight line, so that there is always a bearing over the whole of the end surface; the brushes may be placed alongside and touching each other, thus utilizing the whole width of the commutator; and they may be very easily and quickly removed, for when the lever is raised the brush may be slipped out, even while the machine is running.

BRUSH-HOLDER STUD.

3736. The stud for the brush holders described in Art. **3732** is shown in Fig. 1380. This is a brass casting, and should be large enough to give rigidity to the brush holders

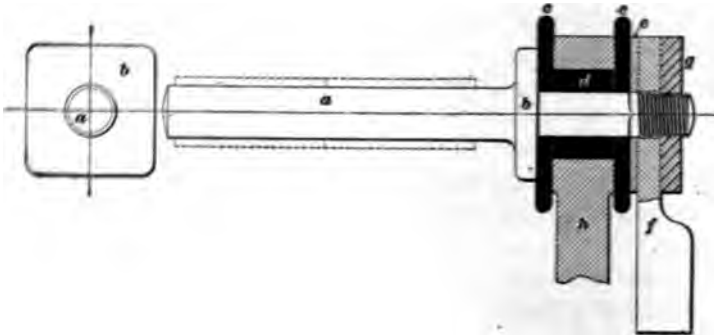

FIG. 1380.

and prevent undue vibration. The stud *a* is circular in cross-section, two brush holders being shown in dotted lines in position. It may here be remarked that the width of the holder at the part where the stud passes through should be about $\frac{1}{8}$ inch greater than the width of the carbon holder at the other end, and in drawing the brush holder, additional allowance must be made for machine finish at the stud end.

3737. The stud has a square collar at *b*, as seen in the end view, and the part beyond is square as far as the two lines which indicate a return to the circular cross-section. The insulating washers *c, c* are also square, with rounded

corners, and the bushing d is square. The washers and bushing are of hard rubber, the former about $\frac{3}{16}$ or $\frac{1}{4}$ inch thick, and the latter $\frac{1}{4}$ or $\frac{5}{16}$ inch, except in very large machines, where these dimensions may be suitably increased. At e is a circular washer of brass, and f is a **cable tip**, which is used to make connection with the main leads which carry the current to the point of distribution. A nut g is put on last to hold the stud firmly in place. It may be necessary to put an additional nut on, for the sake of greater security.

ROCKER-ARM.

3738. The brush-holder studs are held in position by means of a **rocker-arm** h , which is shown again in Fig. 1381. This represents a rocker-arm for a bipolar dynamo. It is to be fitted over the end of the bearing next to the commutator, and is provided with a wing nut w , by means of

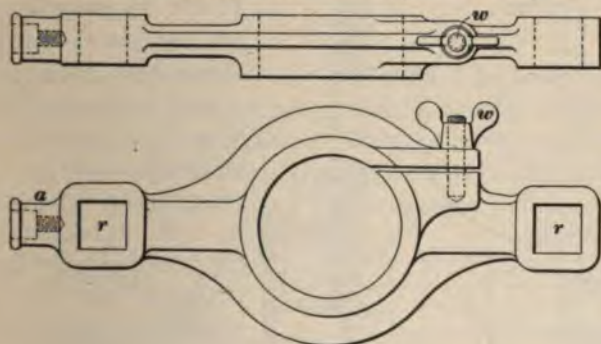

FIG. 1381.

which it may be clamped in any desired position. The square recesses r, r are seen, into which the studs are fitted. The reason for this shape is that the studs must be prevented from turning, as they would if simply clamped in a circular hole, owing to the reaction of the brushes when pressed against the commutator.

3739. At one end is a projecting boss a , tapped for a screw which holds the handle in place, by means of which

the rocker-arm is moved when it is necessary to change the position of the brushes. In Fig. 1382 is given a view of the handle alone. It is made of maple or some such wood, and

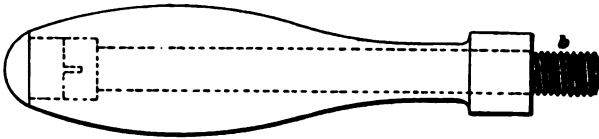

FIG. 1382.

has a bolt *b* through the center, which screws into the rocker-arm, the lower part of the handle itself entering also a little distance.

CABLE TIPS.

3740. In the description of Fig. 1380 the cable tip was briefly mentioned. Fig. 1383 shows one of these more fully.

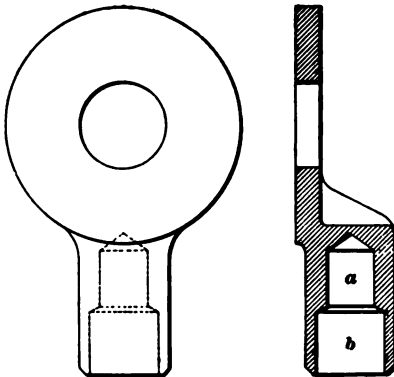

FIG. 1383.

It will be seen that there are two sizes of recesses; the smaller recess *a* is intended to receive the bare wire of the cable, which is soldered into place, and the recess *b* is made larger in order to accommodate the insulation. By this means a neat and strong connection may be made to the main leads, and if for any purpose it may be

necessary to remove the cables, the tips are easily disconnected from the studs. The cable tips are of cast brass; they should be made light, so that they do not require extreme or long-applied heat to solder in the wires. The usual diameters for the stranded cable, bare, are from $\frac{3}{8}$ inch for, say, 8 or 10 amperes to $\frac{5}{8}$ inch for about 300 amperes, and the thickness of insulation at one side will be from $\frac{1}{16}$ for the smaller sizes to $\frac{1}{8}$ of an inch for the larger sizes.

SHAFT.

3741. The design of the armature shaft should be undertaken with a full recollection of the principles explained in the section on Mechanics. Beyond this, it is only necessary to point out some of the details of construction. To begin with, then, the diameter and length of the bearings should first be decided upon; for if we were to determine the diameter at the armature first, we might find that the bearings came out much too small. We must throughout have good proportions to give the prime requisite, stiffness; the shoulders at the bearings must be large enough to prevent any possibility of the shaft being driven in if the bolts of the bearings are slackened; there must be sufficient end play between bearings to avoid any liability of the shaft expanding sufficiently to hold fast and in order to produce a smooth wearing of the commutator, which is promoted by a slight oscillation of the armature while running.

3742. The journals of the shaft should be as small as possible, consistent with proper strength, as the friction is proportional to the diameter of shaft, other things being equal. In Fig. 1384 we have given the dimension of a shaft such as would be suitable for a 10-horsepower dynamo. We

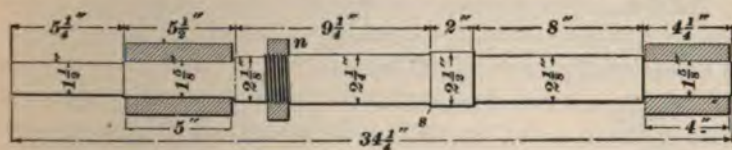

FIG. 1384.

have taken a diameter at the journals of $1\frac{5}{8}$ inches, and a length at the pulley end of three times this diameter, or 5 inches. At the commutator end the journal need not be so long, and we have made it 4 inches in length. The shaft should be turned down a little smaller than this diameter for the pulley, and we may make it $1\frac{1}{2}$ inches diameter, and about the same length, say $5\frac{1}{4}$ inches. There must be a

good shoulder at the journal, and we will increase the diameter by half an inch at the part where the commutator is driven on, making it $2\frac{1}{8}$ inches. For the other journal we will provide the same amount of shoulder, making the shaft for a short distance $2\frac{1}{8}$ inches diameter. The armature is driven on at this end up to a shoulder s , and a thread is cut on the shaft to take a nut n , by which the armature is held in position. It is not well to cut the thread down by the shoulder for the journal, and an addition to the diameter must be made, such that the bottom of the thread will be a larger diameter than $2\frac{1}{8}$ inches. We may in the present example take a diameter for the shaft of $2\frac{1}{4}$ inches at this part. Since the armature is pressed up to a stop at s , we will allow a further increase of diameter at this part of a quarter of an inch, making $2\frac{1}{2}$ inches. This largest diameter may be that of the rough forging, because nothing has to fit over it, and if it were turned, it would mean turning so much more metal from the whole length of the shaft.

3743. The shoulders at the journals must be carefully rounded, sharp corners being always avoided, as this introduces a serious weakness by concentrating the strain at one point instead of distributing it over a larger area.

3744. The ratio of length to diameter of journal at the pulley end should be, for machines of about 10 horsepower, 3 to 1; for machines of 100 horsepower, about 4 to 1; and for still larger machines it is well to increase the ratio still further. A 100-horsepower dynamo would have the diameter of journals about 4 inches.

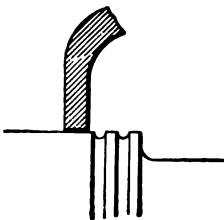

FIG. 1385.

The shaft should be provided with oil-throwing ridges, in order to prevent oil from reaching the commutator or armature. The shape of these ridges is shown in Fig. 1385. They should be covered by the cap to the bearing, as indicated in the sketch, so that the oil that is

thrown off will fall within the casing and be returned to the oil-well, if self-oiling bearings are used, or to the waste pocket when sight-feed lubricators are employed.

3745. We must caution the student against making use in his designs of the very bad construction of shaft shown in Fig. 1386, in which the end of the shaft carrying

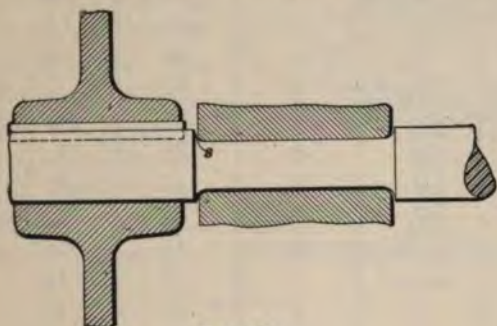

FIG. 1386.

the pulley is larger in diameter than it is in the bearing. The result of such design is that the continual pull of the belt produces in the shoulder's violent strains, constantly changing from one direction to the opposite, as the shaft revolves, and these reversals of load produce in time a crystallization of the metal which will cause it to break down at probably the most important time, that is, when the load is heaviest. If the shaft must be of such a small diameter in the bearing, let the size be the same under the pulley, but not greater. By far the better plan is, as we have drawn it in Fig. 1384, to make the journal sufficiently large that there shall be no necessity to have the shaft larger at the pulley end.

KEYS.

3746. The following table gives the sizes of steel keys for different diameters of shafts :

TABLE 111.
SIZES OF KEYS.

Diameter of Shaft.	Width.	Thickness.	Diameter of Shaft.	Width.	Thickness.
$\frac{1}{8}$	$\frac{1}{16}$	$\frac{1}{16}$	$3\frac{1}{8}$	$\frac{3}{4}$	$\frac{7}{16}$
$\frac{3}{8}$	$\frac{3}{16}$	$\frac{1}{16}$	$3\frac{1}{4}$	$\frac{3}{4}$	$\frac{7}{16}$
$\frac{1}{2}$	$\frac{1}{8}$	$\frac{3}{16}$	$3\frac{3}{8}$	$\frac{7}{8}$	$\frac{1}{2}$
$\frac{5}{8}$	$\frac{3}{16}$	$\frac{3}{16}$	$3\frac{1}{2}$	$\frac{7}{8}$	$\frac{1}{2}$
$\frac{3}{4}$	$\frac{1}{8}$	$\frac{1}{8}$	$3\frac{5}{8}$	$\frac{7}{8}$	$\frac{1}{2}$
$\frac{7}{8}$	$\frac{1}{8}$	$\frac{1}{8}$	$3\frac{3}{4}$	$\frac{7}{8}$	$\frac{1}{2}$
1	$\frac{1}{4}$	$\frac{5}{16}$	$3\frac{7}{8}$	1	$\frac{5}{8}$
$1\frac{1}{8}$	$\frac{1}{4}$	$\frac{5}{16}$	4	1	$\frac{5}{8}$
$1\frac{1}{4}$	$\frac{1}{8}$	$\frac{1}{8}$	$4\frac{1}{4}$	1	$\frac{5}{8}$
$1\frac{3}{8}$	$\frac{1}{8}$	$\frac{1}{8}$	$4\frac{1}{2}$	$1\frac{1}{8}$	$\frac{5}{8}$
$1\frac{1}{2}$	$\frac{5}{16}$	$\frac{1}{4}$	$4\frac{3}{4}$	$1\frac{1}{8}$	$\frac{5}{8}$
$1\frac{5}{8}$	$\frac{5}{16}$	$\frac{1}{4}$	5	$1\frac{1}{4}$	$\frac{3}{4}$
$1\frac{3}{4}$	$\frac{5}{16}$	$\frac{1}{4}$	$5\frac{1}{4}$	$1\frac{1}{4}$	$\frac{3}{4}$
$1\frac{7}{8}$	$\frac{5}{16}$	$\frac{1}{4}$	$5\frac{1}{2}$	$1\frac{1}{4}$	$\frac{3}{4}$
2	$\frac{3}{8}$	$\frac{1}{8}$	6	$1\frac{1}{2}$	$1\frac{1}{8}$
$2\frac{1}{8}$	$\frac{3}{8}$	$\frac{1}{8}$	$6\frac{1}{2}$	$1\frac{5}{8}$	1
$2\frac{1}{4}$	$\frac{3}{8}$	$\frac{1}{8}$	7	$1\frac{3}{4}$	$1\frac{1}{8}$
$2\frac{3}{8}$	$\frac{3}{8}$	$\frac{5}{16}$	$7\frac{1}{2}$	$1\frac{7}{8}$	$1\frac{1}{8}$
$2\frac{1}{2}$	$\frac{3}{8}$	$\frac{5}{16}$	8	2	$1\frac{1}{4}$
$2\frac{5}{8}$	$\frac{3}{8}$	$\frac{5}{16}$	$8\frac{1}{2}$	$2\frac{1}{8}$	$1\frac{1}{4}$
$2\frac{3}{4}$	$\frac{3}{8}$	$\frac{5}{16}$	9	$2\frac{1}{4}$	$1\frac{3}{8}$
$2\frac{7}{8}$	$\frac{3}{4}$	$\frac{7}{16}$	$9\frac{1}{2}$	$2\frac{3}{8}$	$1\frac{3}{8}$
3	$\frac{3}{4}$	$\frac{7}{16}$	10	$2\frac{1}{2}$	$1\frac{1}{2}$

PULLEYS.

3747. The pulleys used to drive high-speed armatures must of necessity also run at high speed; therefore it is important that they be as perfectly balanced as possible. To ensure this, it is best to employ webbed pulleys, which may be turned all over, and this design may be used on all sizes of dynamos up to 100 horsepower. The ratio of diame-

ter to length may be taken as about 1.2 to 1 for very small machines, while for sizes above 5 horsepower a ratio of 1.3 : 1 to 1.45 : 1 will be found to conform to good practice.

Fig. 1387 shows a webbed pulley such as would be suitable for a 10-horsepower dynamo. The peripheral speed of webbed pulleys may be taken as 2,200 to 3,000 feet per minute, the higher figure corresponding to the larger sizes of machine.

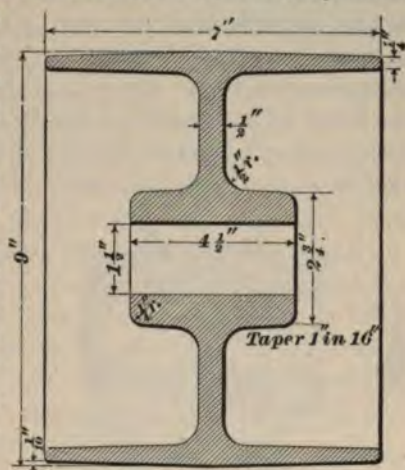

FIG. 1387.

BEARINGS.

3748. Bearings for dynamos are usually made self-oiling, instead of being fitted with sight-feed lubricators. A self-centering bearing with oil-rings is shown in Fig. 1388, which gives two views, one being a longitudinal cross-section and the other a transverse section through the bearing at one of the oil-rings. The bearing proper, or box, is composed of two parts *a* and *b*, the upper and the lower, which are supported by the pedestal *d* and secured by the cap *c*, which is held in place by four bolts *e*. Two oil-rings *f, f* are introduced into openings cut for this purpose in the upper box, and rest upon the shaft, dipping into the oil contained in the reservoir below. When the shaft is revolved, the rings take up oil and carry it to the shaft. The boxes should have oilways cut in them, as shown by the dotted lines, and their arrangement should be such as to lubricate the whole of the bearing with one ring, in case one of the rings should become immovable. It is possible that a ring may adhere so closely to the edge of the slot by the capillary action of the oil as to stop turning. On this account it may be

2500 DYNAMO-ELECTRIC MACHINE DESIGN.

advisable to make the ring of a winding form so that it can not lie close against the box. A small cover *g* is provided to span the top of the slot, to guard against the ring climbing up on the top of the box. The two halves of the bearing are fitted with a tongue joint, so that they can not slip sideways. It will be seen that the upper box is not cut through by the oil-ring slot, but that a small connecting bridge *h* is

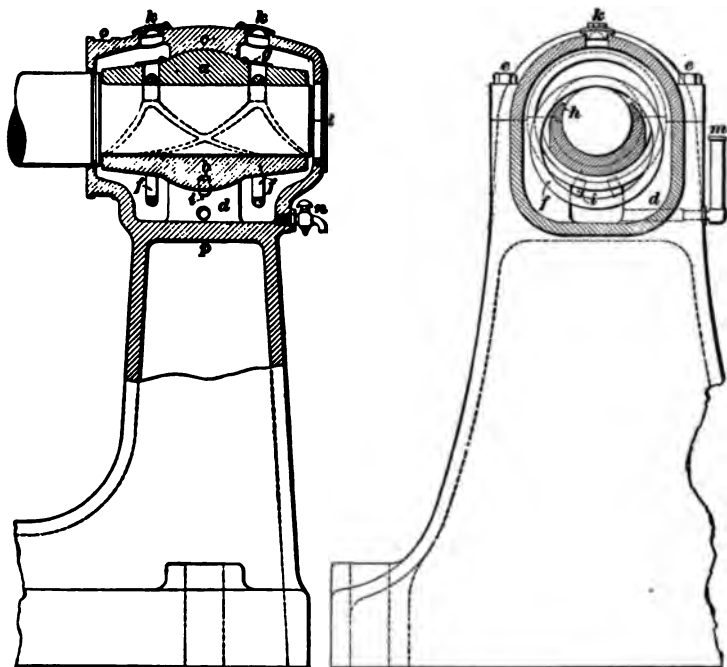

FIG. 1368.

left, which holds the three parts together. The oil-rings should not be so large in diameter as to be in danger of touching the sides of the oil chamber; it must be remembered that a theoretical static clearance is not sufficient, as the ring, when turning, is carried over slightly to one side. If the box were allowed any twisting motion, such as it might derive from the shaft, the bridges *h* would touch the

oil-rings and prevent them from turning; therefore the lower box is fitted with two pins, i, i , which are so spaced as to touch against the walls of the central oil chamber. For purposes of inspection of the rings and for supply of oil, two openings k, k are made in the pedestal cap, which may be covered by small hinged lids to prevent the entrance of dust or other foreign matter. With the same end in view of keeping the oil clean, a plate l may be screwed on the end of the pedestal; it should not be made fast to the cap also, as it would have to be moved every time the cap was taken off. An oil-gauge m , to show at a glance the amount of oil in the reservoir, will be found to be a valuable addition, as there is then much less possibility of the level of the oil falling below the edge of the rings. A drain-cock n should be provided for, in order that the oil may be drained off and filtered, or fresh oil supplied.

3749. The pedestal and cap for the commutator end are turned at o to receive the rocker-arm. At the pulley end of the machine the bearing is symmetrical at both ends. It will be observed that a greater thickness of metal is allowed at p than at other parts of the pedestal. The reason for this is that the cores of the oil chamber and of the interior of the pedestal may vary a little in setting, and the extra clearance is allowed in order that the iron may not be too thin at this part.

3750. In the drawing we have supposed the two boxes to be held together by the clamping of the outer bolts on the cap. In addition to this, we might wish to bolt the boxes together independently. This should, indeed, be done in the case of a long bearing, and is a simple matter of design. Care should be taken that the tap-bolts used do not come too close to the inner surface of the cap, and due allowance must be made for side play. It would probably be necessary to cast small bosses on the upper and lower boxes, the upper ones to bear against the heads of the bolts, and the lower ones to form a sufficiently solid mass to tap into.

2502 DYNAMO-ELECTRIC MACHINE DESIGN.

3751. The bolts in the cap should fit closely, that the cap may not move from its position. The holes after being drilled should be reamed out to the correct size.

3752. Babbitted bearings are generally used on large machines, where the boxes are of cast iron. The Babbitt lining should be very thoroughly secured by dovetailed joints, so that there will be no possibility of it stripping off at the edges.

FRAME.

3753. The dynamo frame may include the pedestal, as in Fig. 1388, or the pedestals may be separate castings. For bipolar machines, it is necessary that the pedestals should be removable, in order that the armature and shaft may be entered between the pole-pieces. In the multipolar construction, however, the field is cast in two parts, the upper

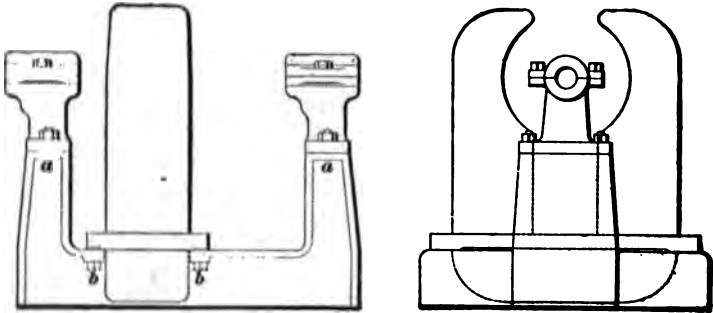

FIG. 1388.

one being bolted to the lower, and the armature may at any time be removed by taking off the upper field and the pedestal caps.

3754. Fig. 1389 shows two elevations of a bipolar frame with wrought-iron fields bolted down, the bolts entering from below at *b, b*. For the sake of convenience in handling, the pedestals are made only large enough to allow room for the armature to pass when they are removed. The

centers of the bearings are not directly over the centers of the supporting pillars *a, a*, but are set to one side. On the commutator end this is done to allow clearance for the brush-holder studs and cable tips when the rocker-arm is moved round, and on the other end this construction allows the rim of the pulley to come closer to the center of the machine than would otherwise be the case.

3755. The frame of a circular field four-pole dynamo is shown in Fig. 1390. The bearings are of different

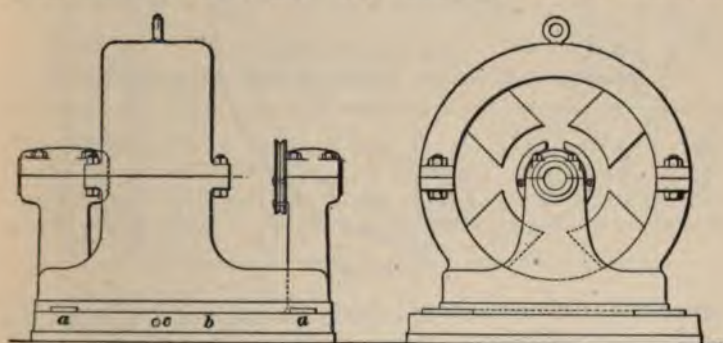

FIG. 1390.

lengths, the commutator bearing being shorter. It will also be noticed that the rocker-arm is supported in a rather different manner from that described in connection with smaller machines. The frame as a whole is fitted to a base-plate *b*, and slides along it in a direction perpendicular to the line of shaft, being guided by planed tongues *a, a*, which fit into corresponding recesses in the frame. This movement is intended to take up the slack in the belt, and should be provided for in all belt-driven machines. A screw passes through the hole *c* and engages in a nut fastened to the frame. A ratchet-and-pawl mechanism is used in connection with a lever to turn the screw and move the machine back and forth.

3756. The rocker-arm support is a separate casting, and is independent of the pedestal cap, so that the cap may

be removed without disturbing the rocker-arm. A detail of the rocker-arm support is given in Fig. 1391. Being open at the top, it allows of the removal of the shaft without taking off this support, and being fastened only below the

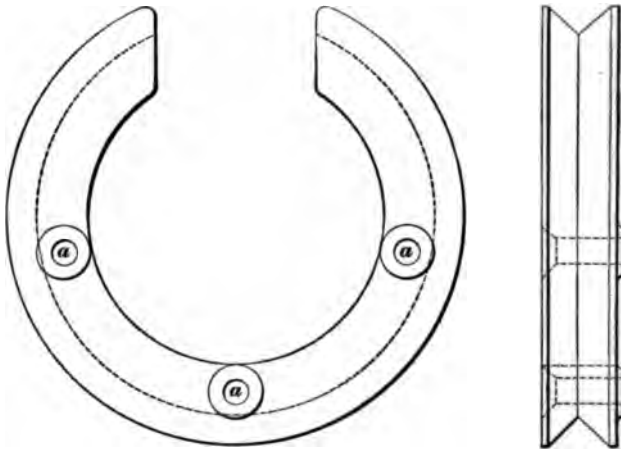

FIG. 1391.

center line, the cap may be loosened or taken off without the necessity of dismantling the rocker-arm. Flat-headed screws are used in the holes *a, a*, and they pass through and enter into bosses cast on the pedestal. The groove for the rocker-arm is V-shaped.

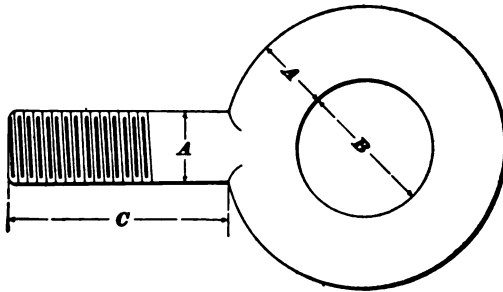

FIG. 1392.

3757. The following are dimensions for eye-bolts for screwing into the frame, such as is shown in Fig. 1390 and detailed in Fig. 1392.

TABLE 112.
SIZES OF STANDARD EYE-BOLTS.

<i>A</i>	$\frac{3}{8}$	$\frac{1}{2}$	$\frac{9}{16}$	$\frac{5}{8}$	$\frac{3}{4}$	$\frac{7}{8}$	1	$1\frac{1}{4}$	$1\frac{1}{2}$	2
<i>B</i>	$1\frac{1}{4}$	$1\frac{1}{4}$	$1\frac{5}{16}$	$1\frac{1}{2}$	$1\frac{9}{16}$	$1\frac{5}{8}$	$1\frac{1}{2}$	$2\frac{1}{8}$	$2\frac{3}{4}$	$3\frac{1}{8}$
<i>C</i>	$1\frac{1}{8}$	$1\frac{1}{2}$	$1\frac{1}{16}$	$1\frac{7}{8}$	$2\frac{1}{4}$	$2\frac{5}{8}$	2	$2\frac{1}{2}$	3	4

3758. The lengths and diameters of standard tap-bolts, given in the accompanying table, will be found useful in actual designing of the parts of dynamos.

TABLE 113.
STANDARD HEXAGONAL HEAD TAP-BOLTS.

Diameter of Screw	$\frac{1}{4}$	$\frac{5}{16}$	$\frac{3}{8}$	$\frac{7}{16}$	$\frac{1}{2}$	$\frac{9}{16}$
Short Diameter of Head	$\frac{7}{16}$	$\frac{1}{2}$	$\frac{9}{16}$	$\frac{5}{8}$	$\frac{3}{4}$	$1\frac{1}{16}$
Long Diameter of Head	.51	.58	.65	.72	.87	.94
Length Under Head	$\frac{3}{4}$ to 3	$\frac{3}{4}$ to $3\frac{1}{4}$	$\frac{3}{4}$ to $3\frac{1}{2}$	$\frac{3}{4}$ to $3\frac{3}{4}$	$\frac{3}{4}$ to 4	$\frac{3}{4}$ to $4\frac{1}{4}$

Diameter of Screw	$\frac{5}{8}$	$\frac{3}{4}$	$\frac{7}{8}$	1	$1\frac{1}{2}$	$1\frac{1}{4}$
Short Diameter of Head	$\frac{7}{8}$	1	$1\frac{1}{8}$	$1\frac{1}{4}$	$1\frac{3}{8}$	$1\frac{1}{2}$
Long Diameter of Head	1.01	1.15	1.30	1.45	1.59	1.73
Length Under Head	1 to $4\frac{1}{2}$	$1\frac{1}{4}$ to $4\frac{1}{4}$	$1\frac{1}{2}$ to 5	$1\frac{3}{4}$ to 5	2 to 5	2 to 5

POLE-PIECES.

3759. The shape of the pole-pieces is an important matter. In a two-pole field there must be plenty of metal at the ends of the pole-pieces, that is, they must not be tapering. The object is to diminish the reluctance as far as possible, so that the lines of force will distribute themselves evenly over the whole air-gap and not be concentrated near the end where they emerge from the magnet core. This effect may be produced by placing the armature a little out of the center, in the direction of the pole tips. When an inverted form of dynamo is used, such as the Edison bipolar, the pole-pieces must be separated from the base-plate by a footstep of zinc, usually four or five inches deep, in order to diminish the leakage.

2506 DYNAMO-ELECTRIC MACHINE DESIGN.

3760. The pole tips must not end abruptly, as we have already pointed out, but a commutating fringe must be provided. The shape of the pole tip may be as shown in Fig. 1393, with pointed ends at the leading and following tips, or

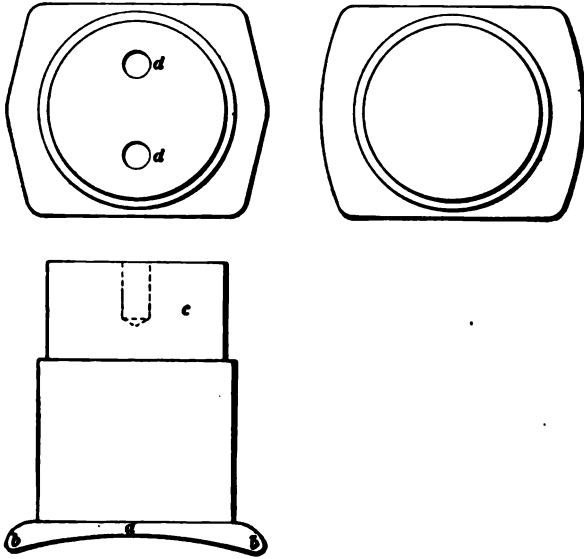

FIG. 1393.

with rounded ends. The thickness at *a* should be comparatively small, as this dimension affects the diameter of the frame; but it should not be so small as to cause the pole tips *b, b* to be thin, as they extend farther from the core and are intended to carry a large number of lines of force. Also, if the pole tips are made thin, the casting is liable to be hard at those parts and to have a lower permeability. The upper part of the core *c* is to be fitted to a hole bored in the yoke, unless, as presently to be described, the yoke is cast around it. The surface of the cylinder *c* must be greater than the area of cross-section of the magnet core, in order that there may be no throttling of the lines of force as they pass into the yoke. When the yoke is of cast iron, the density will not usually be more than 35,000 or 40,000 lines per square inch, so that the area of contact between the

core and yoke should be nearly double the cross-sectional area of the core.

The pole-piece is intended to be secured by means of two bolts at d, d . These should fit closely in the holes in the yoke, in order that the pole-piece may not shift. In case one bolt is used instead of two, a dowel-pin should also be provided to guard against any twisting of the pole-piece.

3761. When the pole-piece is to be cast into the yoke, it is usually a wrought-iron forging, and the shape must be such as to be firmly held in place. Any design may be adopted that is likely to secure this end. The end of the pole-piece may be hollowed out, as in Fig. 1394 at a , as this will afford a little more contact surface than if it were flat, and will also reduce the weight of the forging. Plenty of metal must be left around the top of the pole piece and on the sides, in



FIG. 1394.

order that the castings may be sound and strong. In such a design as this, pole tips can not be used unless they are bolted on after the spool is in place. The pole tip then forms a flange as shown in Fig. 1395, which supports the spool.

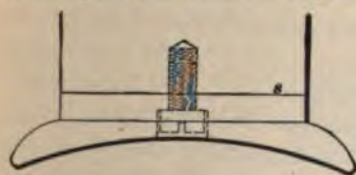

FIG. 1395.

The surfaces at s must be well fitted, in order to eliminate all unnecessary reluctance. The two screws which hold the pole tip in position should be well fitted, in order that the tip may not move, and the

clearance holes around the head must be as small in diameter and as shallow as possible, while allowing the head of the screw to be beneath the surface. If the pole tip is so small that only one screw is considered necessary, a dowel-pin should be used to prevent the pole tip from turning.

LAMINATED FIELDS.

3762. There may be considerable loss of power due to eddy currents in the fields as the teeth of a slotted armature move past the pole tips. This loss is made evident by a local heating, and may be almost entirely removed by laminating either the whole pole-piece or simply the pole tips. One method proposed is to use a mass of laminated sheet iron for a pole tip such as that described in connection with Fig. 1395. Some makers prefer to construct the whole pole-piece of laminated iron firmly bolted together and cast into the yoke. It is probably sufficient to provide lamination for the pole tip alone.

CROSS-SECTION OF CORES.

3763. Magnet cores should preferably be made circular in cross-section, as the circle encloses a larger area for a given periphery than any other geometrical shape. For purposes of comparison, therefore, the following table, given by S. P. Thompson, will prove useful, as it shows the relative lengths of wire required to wind around sections of various forms enclosing equal areas:

Circle	3.540
Square.....	4.000
Rectangle 2:1	4.240
Rectangle 3:1	4.620
Rectangle 10:1	6.910
Oblong, made of one square between two semicircles.	3.760
Oblong, made of two squares between two semicircles.....	4.280
Two circles, side by side.....	4.997
Two circles, but wire wound around both together.	4.100
Three circles, wire wound around each separately.	6.130
Four circles, wire wound around each separately.	7.090

SPOOLS.

3764. Magnet spools should be substantially built, in order to stand handling and perhaps rough usage without risk of falling apart. Fig. 1396 shows the details of con-

struction of a spool such as would be suitable for a 10-horse-power dynamo. The actual frame of the spool consists of two sheet-iron cylinders *a*, *b*, one within the other, having

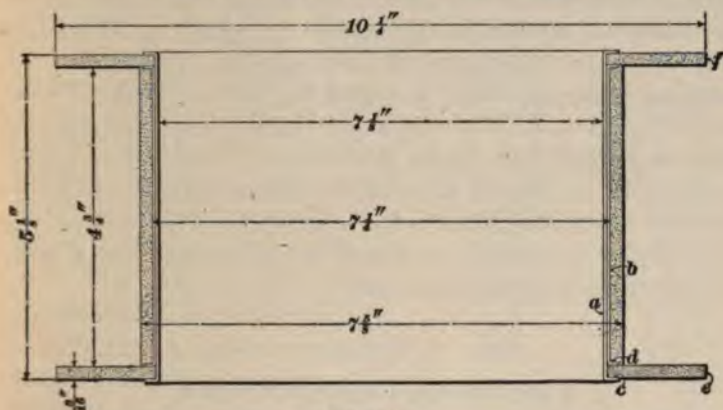

FIG. 1396.

flanges *c*, *d* which are pressed close in to the end rings *e*, *f* and hold them securely in place. These rings are made of hard vulcanized fiber for small spools. The surface of the outer cylinder *b* is then covered with thinner fiber wound on to a thickness of about three-sixteenths of an inch, after which the wire is put in place. The inner end of the wire may be brought out through a hole in the end ring *e* or *f*, on a level with the first layer. An even number of layers will result in bringing the ends out close together, and will render connections easily made.

3765. For heavy spools, it is best to

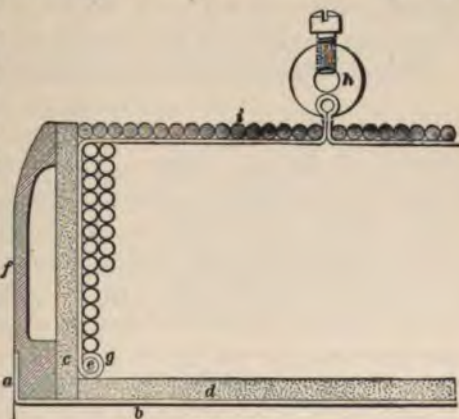

FIG. 1397.

2510 DYNAMO-ELECTRIC MACHINE DESIGN.

have metal flanges, preferably of brass, in order to prevent leakage around the coil. Fig. 1397 shows the construction of a flange of this description, also the manner of bringing out the inner end of the wire. The flange *f* is cored out on the inside for the sake of lightness. A slight recess is turned at *a*, to receive the flange of the sheet-iron cylinder *b*. Insulating linings *c*, *d* are provided, as in Fig. 1396, to hold the wire. The end of the wire is at *e*; before winding, a narrow strip of thin copper *g* is soldered to it and wrapped throughout its length with tape. After the spool is filled, this end is bent over, and a brass connector *h* is soldered on, as shown. The strip is then held in place by the cord *i*, with which the whole spool is served.

TERMINAL CONNECTIONS.

3766. The connections between the dynamo and the external circuit are made on a **terminal board**. This is a piece of wood shaped to receive the terminals, and may be of the form shown in Fig. 1398, although there is a large

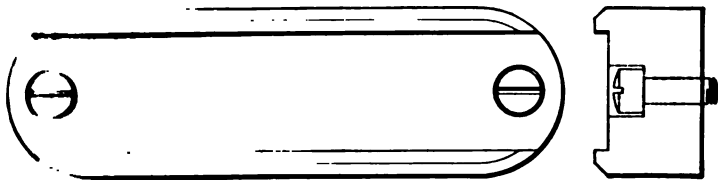

FIG. 1398.

variety of designs used. The terminals are cast brass blocks, of the same width as the terminal board in the groove, and are secured to the board by means of screws entering from beneath and countersunk sufficiently to be well clear of the metallic support. To further ensure the connection against accidental contact with the frame, a piece of thin fiber may be cut to the shape of the board, and placed under it, holes being made to pass the two holding-down

TERMINAL BLOCKS.

3767. In Fig. 1399 is shown a terminal block which would be suitable for the board in Fig. 1398. Two holes *a, a* are drilled through from side to side, and the cable tips to which the leads are soldered are turned to fit these holes, the set-screws being used to secure them. The screw *s* holds the terminal block in place. When it is necessary to have an extra connection for the shunt, a small hole must be drilled, as shown at *s*, in Fig. 1400, for the accommodation of the cable tip.

3768. A different method is given for the clamping of the main lead cable tips. Slots are cut through at *a, a*, Fig. 1400, so that, when the screws *b, b* are tightened, the tips are held firmly. The terminal block can not now be fastened by one screw, as there is no room

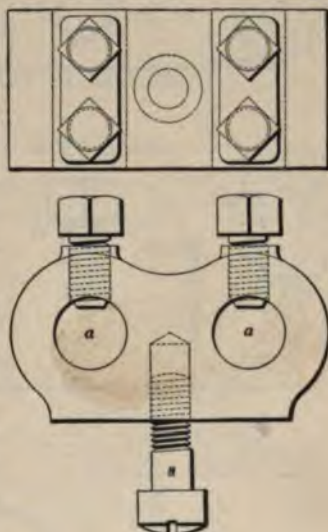

FIG. 1399.

in the center, so two screws are used, located near the outer edge at *c, c*. In laying out the holes for the cable tips, sufficient clearance must be allowed for the body of the tips, so that they will not touch each other when all are in place.

3769. The cable tip used for the terminal blocks is shown in Fig. 1401. The end *a* is of such a size as to enter easily into the hole in the block, and is intended to be flush with the edge of the block when in position. The lead is soldered in, as already described. The edge *e* should not be left square, but must be rounded, as shown, in order that the insulation of the cable be not damaged. The cable tips are brass castings.

3770. For shunt connections the terminal block shown in Fig. 1402 is suitable. It is designed on the same lines as

SECTIONAL VIEW OF THE DESIGN.

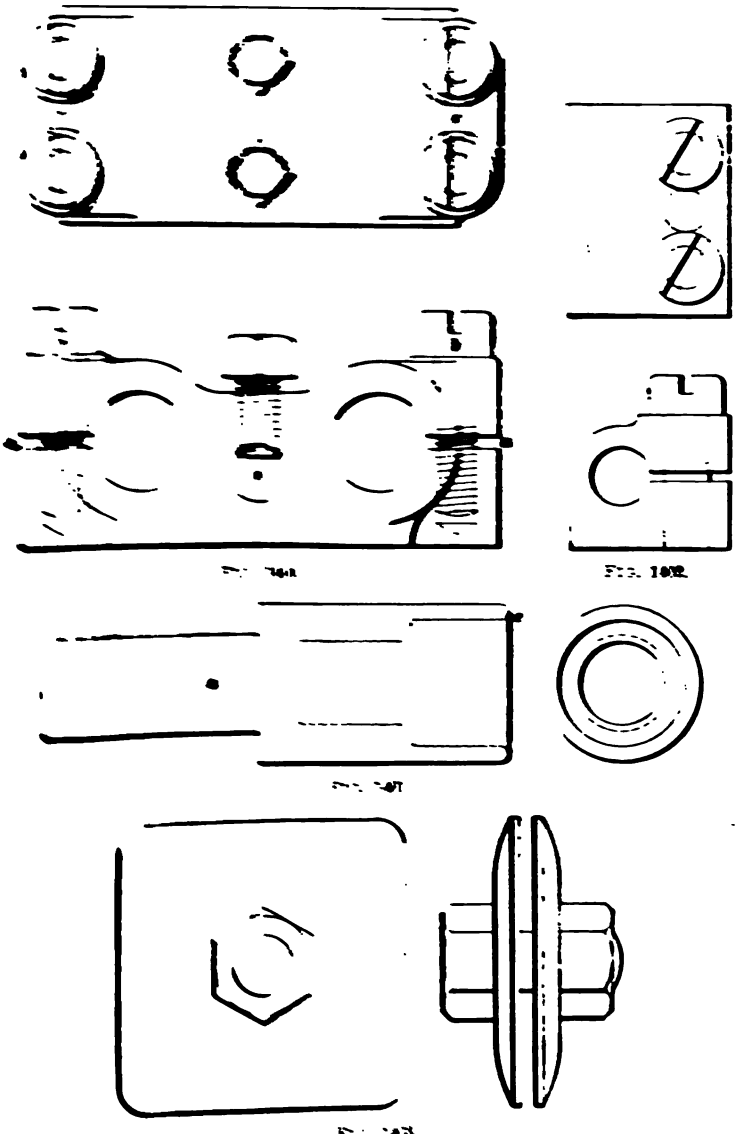

Fig. 100, but the cable tips enter only half the distance hence two may be used—one from either side.

3771. For a compound-wound dynamo, the connections of the series coils to each other are made with cast-brass clamps, like that shown in Fig. 1403. These should be thick enough to stand the pressure of the bolt without bending back, so as to afford good contact and diminish the resistance.

CONNECTION DIAGRAMS.

SHUNT-WOUND DYNAMO.

3772. A connection diagram is given in Fig. 1404 for a shunt-wound dynamo fitted with terminal boards and

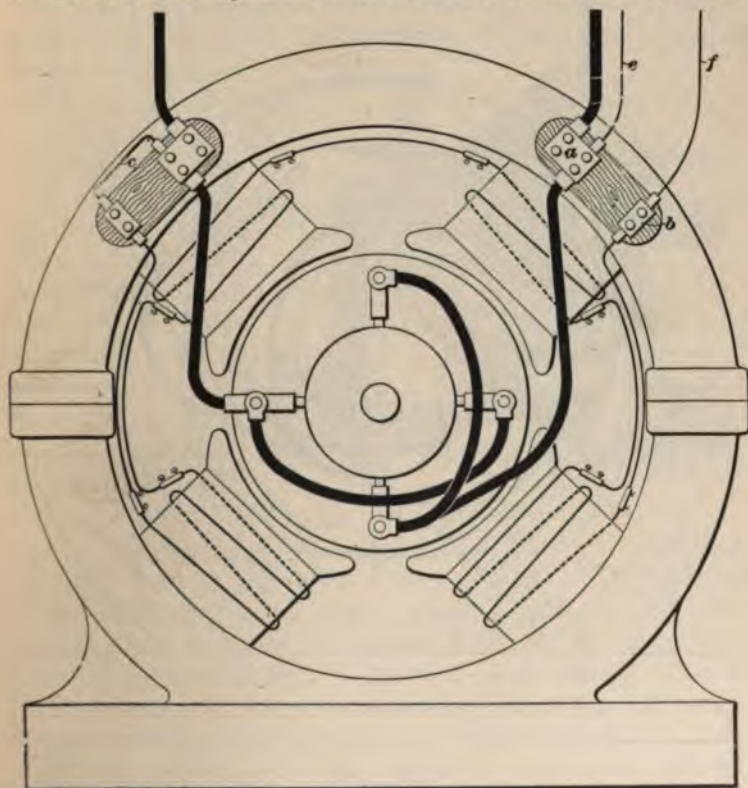

FIG. 1404.

2514 DYNAMO-ELECTRIC MACHINE DESIGN.

terminals, as described in the preceding pages. The right-hand board has two blocks: one, that at *a*, being similar to Fig. 1399, and the other, lettered *b*, like Fig. 1402. On the other terminal board are similar blocks. A permanent connection is made at *c* to complete the shunt circuit; this is done in order that the field regulator may be inserted on either side of the machine, as may be convenient. The two wires *e*, *f* go to the regulator, as drawn. The system of connection will doubtless be quite clear from the diagram.

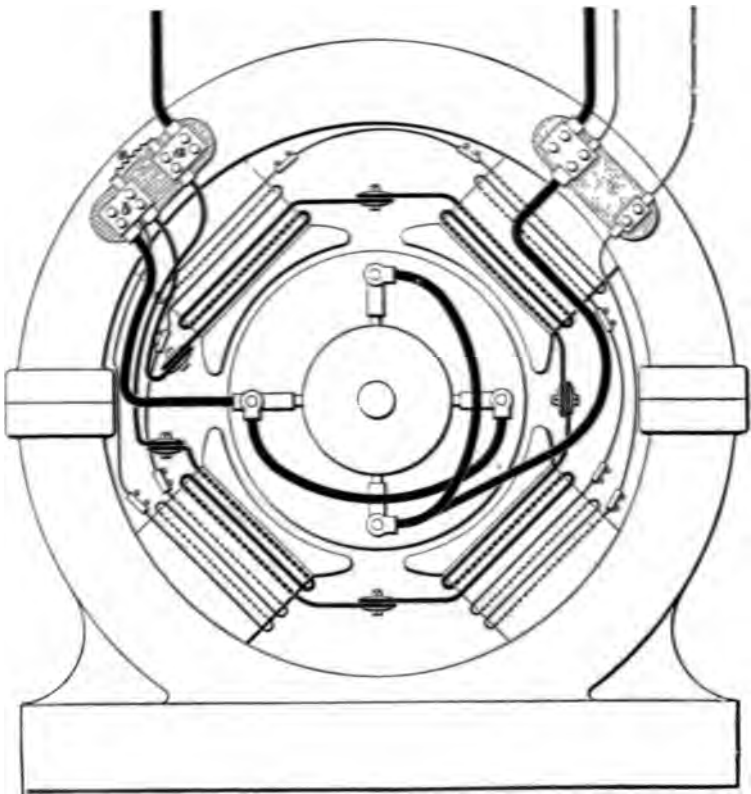

FIG. 1405.

COMPOUND-WOUND DYNAMO.

3773. Fig. 1405 shows the connection for a compound-wound dynamo. On the left-hand board the series shunt s is shown by a wavy line. This may be connected by soldering to special tips. The terminal a is detailed in Fig. 1399. The series cable tip is only half-length, because the shunt tip occupies the rest of the hole. The same applies to the cable tips in b , which is similar to Fig. 1400.

ASSEMBLED MACHINES.

3774. A perspective view of a standard bipolar dynamo is shown in Fig. 1406. In the figure the machine is represented as ready for operating, and is mounted upon sliding rails, which are attached to the wooden bed-plate. Two adjusting screws, one on each side of the machine, are used to move the dynamo along the rails, thereby loosening or tightening the belt, as the circumstances may require.

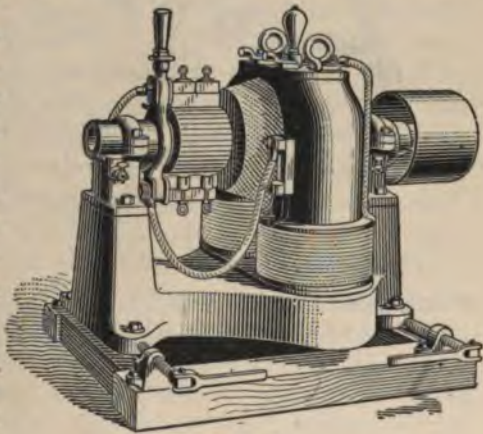

FIG. 1406.

An incandescent lamp is connected between the main terminals of the connection board, placed on top of the machine, and is used to indicate when the machine is generating its normal E. M. F. A lamp used for this purpose is usually called a **pilot lamp**. This is really nothing more than a cheaper substitute for a voltmeter.

3775. In Fig. 1407 is shown a four-pole dynamo mounted on a cast-iron bed-plate, with a belt-tightening

517 DYNAMO-ELECTRIC MACHINE DESIGN.

method is similar to that in the preceding figure. In this case, however, only one screw is used, it being placed in a

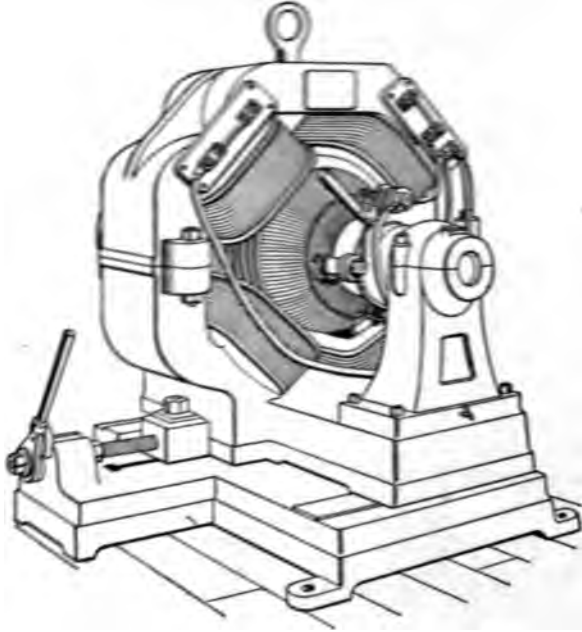

FIG. 1407.

central position. The details of construction will readily be understood from the preceding description.

MOTOR DESIGN.

(CONTINUOUS-CURRENT.)

PRINCIPLES OF OPERATION.

3776. Electric motors designed to be operated by continuous current were in use before the dynamo was invented. Such motors were operated by batteries, and usually were made up by arranging pieces of iron so that they would be successively attracted by electromagnets, and thus give rise to motion. Several styles of such motors were made, and although they operated after a fashion, they ultimately proved failures, and attempts to utilize electricity as a source of mechanical energy by this means proved fruitless. The cause of this failure was twofold. In the first place, batteries proved to be a very expensive means of generating the current necessary, and, secondly, motors built on the lines indicated above were very inefficient, delivering only a very small amount of power at the pulley compared with the amount of power supplied to them. The invention of the dynamo afforded a cheap and convenient means of generating current, so that after its invention attention was again given to electric motors. Shortly after the invention of the dynamo, it was found that the same machine which operated as a dynamo could also be run as a motor if it were fed with current from an outside circuit; in other words, that the ordinary continuous-current dynamo was reversible in its action. It was also found that an electric motor designed on the same lines as the dynamo would convert electrical energy into mechanical energy quite as efficiently as the

For notice of copyright, see page immediately following the title page.

dynamo would perform the reverse operation. Direct-current motors came into rapid use for transmitting power, and although the alternating-current motor is beginning to take their place in some cases, there are still large numbers of them used. The most extended use of direct-current motors at present is probably in connection with street-railways, the alternating current having been used very little for this purpose as yet.

DYNAMOS AND MOTORS COMPARED.

3777. A dynamo may be defined as a machine for the generation of an electromotive force and current by the motion of conductors through a magnetic field. This motion and the force necessary to maintain it must be supplied by a steam-engine or other source of power. On the other hand, a motor may be defined as a machine for supplying mechanical power when supplied with an electric current from some outside source. The motion and the force necessary to maintain it is in this case supplied by the reaction between the current flowing in a set of conductors and the magnetic field in which the conductors are placed.

3778. As far as the electrical features of a continuous-current motor are concerned, they are almost identical with those of the continuous-current dynamo. The differences in the two which occur in practice are very largely differences in mechanical details which are necessary to adapt the motor to the special work which it has to do. This is notably the case with street-railway motors, motors used in mining and hoisting work, etc. The class of work which such motors have to perform renders it necessary that they should be enclosed as much as possible. No matter what the mechanical design of such motors may be, they all consist of the same essential parts as the dynamo, namely, field-magnet, and armature with its commutator, brush holders, etc.

ACTION OF MOTOR.

3779. It is necessary to consider carefully the forces acting in a motor, in order to understand clearly the behavior of different kinds of motors when operated under given conditions. In order to do this, we will consider the force acting on a conductor which is carrying a current across a magnetic field. Suppose the arrows, Fig. 1408,

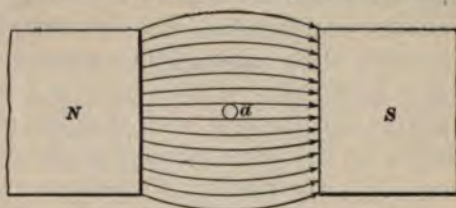

FIG. 1408.

represent magnetic lines of force flowing between the pole faces of the magnet $N S$, and let a represent the cross-section of a wire lying at right angles to the lines. So long as no current flows through the wire,

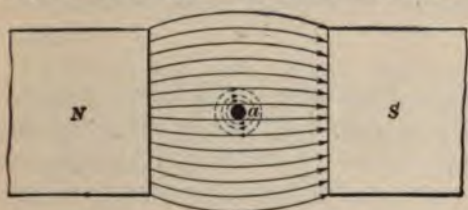

FIG. 1409.

the field will not be distorted, and there will be no tendency for the wire to move. If the ends of the wire are connected to a battery so that a current flows, say, down through the paper, this current will tend to set up lines of force around the wire, as shown by the dotted circles, Fig. 1409. It will be noticed that these lines tend to oppose the original field below the wire and make it more dense above the wire. The resultant effect is that the field is distorted, as shown in Fig. 1410, and the wire is forced downwards.

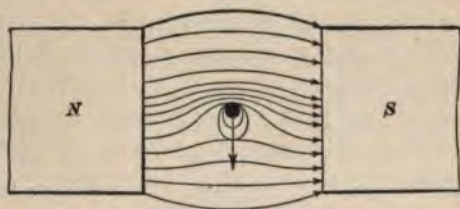

FIG. 1410.

3780. The action described in the simple case just given is essentially that which takes place in an electric

motor. The magnetic field is supplied by the field-magnet. This magnet is excited by means of current taken from the mains to which the motor is connected. Current from the line is led into the armature windings by means of the commutator and brushes, and this armature current reacts on the field, thus driving the armature around. The commutator keeps the relation between the current in the conductors and the field such that the twisting force or torque acting on the armature is continuous, and a uniform rotary motion is the result. The effort exerted by the reaction between the field and the current in each individual conductor may be quite small; but it must be remembered that the armature is usually provided with a large number of conductors, so that the total resulting torque may be quite large.

3781. By referring to Fig. 1410, it will be seen that in a motor the conductors are *forced* across the field by the reaction of the armature current on the field. That is, *the force exerted by the magnetic field upon the armature conductors of a motor is in the same direction as the motion of the armature.* This force is made use of for doing mechanical work. Compare this with the action of a dynamo. The dynamo armature is driven by means of a steam-engine or other source of power, and the armature conductors are made to cut across the magnetic field, this motion causing the generation of an E. M. F. When the outside circuit is closed, so that current flows through the armature conductors, this current reacts on the field in such a way as to *oppose* the motion of the armature. The more current the dynamo supplies, the greater is this opposing torque action between armature and field and the more work the steam-engine has to do to keep the dynamo operating. In the case of a motor, the greater the load applied to the pulley the greater must be the torque action between the armature and field to keep up the motion, and the greater the amount of current which must be supplied from the line. It is thus seen that as regards the torque action between the armature

and field, the motor is just the opposite of the dynamo, the force action in the former case being *with* the direction of motion and in the latter case *against* it.

COUNTER E. M. F. OF MOTOR.

3782. It was shown, in connection with the study of the theory of the dynamo, that whenever a conductor is moved in a magnetic field so as to cut lines of force, an E. M. F. is induced in the conductor. In the case of a dynamo, an E. M. F. is generated in this way, and this E. M. F. is made use of to set up currents in outside circuits. In other words, the E. M. F. is the *cause* of the flow of current, and consequently the E. M. F. is in the same direction as the current.

In a motor we have all the conditions necessary for the generation of an E. M. F. in the armature; that is, we have an armature revolving in a magnetic field and conductors cutting across lines of force. It is true that, in the case of a motor, the armature is not driven by a belt as in the case of a dynamo, but is driven around by the force action between the field and armature. This, however, makes no difference as far as the generation of an E. M. F. is concerned.

When a motor is in operation, there must be an E. M. F. generated in its armature, and for the present we will term it the **motor E. M. F.** Take the simple case shown in Fig. 1410: as the conductor is forced down, it will pass across the magnetic field, and an E. M. F. will be induced in it. Also, by applying the rule for determining the direction of the induced E. M. F., we see that it must be directed upwards, that is, towards us along the conductor (the direction of motion being down and the direction of the field from left to right). The *current* flowing in the conductor is flowing away from us, or is being opposed by the E. M. F. We may state, then,

In an electric motor the E. M. F. generated in the armature is opposed to the current which is flowing through the

armature. Owing to the fact that the motor E. M. F. is opposed to the current, it is commonly spoken of as the **counter E. M. F.** of the motor. It is important that the student should clearly understand the generation of this counter E. M. F. and its relation to the current. As regards the generation of E. M. F., the motor is the opposite of the dynamo, as in the latter case the E. M. F. is always in the same direction as the current.

3783. In order that a current may be sent through the armature of a motor, the E. M. F. of the dynamo supplying the current must be greater than that of the motor. Suppose a dynamo *A*, Fig. 1411, is supplying current to the motor *B*.

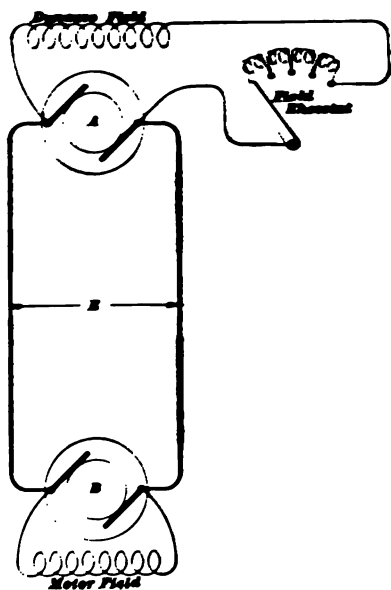

FIG. 1411.

Let E be the E. M. F. maintained between the mains by the dynamo *A*. We will suppose E to be kept constant independently of the current delivered. The motor when running will generate a certain counter E. M. F. which we will call E_m . Part of the line pressure will be used in overcoming the counter E. M. F., E_m , of the motor, and the remainder in overcoming the resistance of the armature. If the field coil were connected in series with the armature instead of in shunt as shown, a small part of E would also be required to overcome the resistance of the field winding. For the present we will consider the case shown. If C is the current flowing through the armature, we must have the relation

$$E = E_m + CR_a, \quad (601.)$$

where R_a is the resistance of the armature. This must hold true for any value of the current.

3784. It is evident from formula **601** that if the current flowing is very small (which is the case if the load on the motor is very light), the counter E. M. F., E_m , is very nearly equal to the E. M. F. E maintained between the lines by the dynamo. If E and E_m were exactly equal, no current would flow in the circuit. In practice, E_m never becomes quite equal to E , because it always takes a small amount of current to run a motor even if no load is applied to the pulley. There is always, therefore, a slight amount of the line pressure taken up in overcoming the armature resistance, and E_m is less than E , as shown by formula **601**.

EFFICIENCY.

3785. There are certain unavoidable losses in a motor just as there are in a dynamo. There is the loss in the field windings, the C^2R loss in the armature coils, the core loss due to hysteresis and eddy currents, and the loss due to mechanical friction. The *commercial efficiency* of the motor is the ratio of the useful power delivered at the pulley to the total power supplied from the mains. The electrical power utilized by the motor armature will be the product of the current flowing through the armature and the counter E. M. F. generated, just as the electrical energy generated in the armature of a dynamo is the product of the E. M. F. generated and the current flowing. We will call this electrical power taken up by the armature w' and the total power supplied to the motor W . The amount of power which is delivered at the pulley will be less than w' by the amount lost in friction and core losses; we will denote the power delivered at the pulley by w . Then

$$\text{Commercial efficiency} = \frac{w}{W}.$$

$$\text{Electrical efficiency} = \frac{w'}{W}.$$

$$\text{Efficiency of conversion} = \frac{w}{w'}.$$

Neglecting for the present the power taken up by the field, we have, if C is the current flowing through the armature,

$$\text{Total power taken from mains} = W = C E.$$

Total power in the armature

$$w' = C E_m.$$

The electrical efficiency

$$\frac{w'}{W} = \frac{C E_m}{C E} = \frac{E_m}{E}. \quad (602.)$$

It is thus seen that the higher the counter E. M. F. compared with the line E. M. F. the higher will be the efficiency. It is also evident from formulas 601 and 602 that if the resistance of the motor armature be high, the counter E. M. F. is bound to be considerably below the line E. M. F., thus making the efficiency low. This simply means that a considerable part of the line E. M. F. is used up in overcoming the resistance instead of overcoming counter E. M. F. and enabling the motor to do work. It also follows that a low-resistance armature is one of the requisites of a good motor just as much as it is of a good dynamo, and in general it will be found that anything which causes low efficiency in a dynamo will also cause low efficiency in a motor.

TORQUE.

3786. Suppose a current C to be sent through a motor the field of which is fully excited, and suppose the armature be held from turning. A strong turning or twisting effort will be exerted on the armature conductors, but as they are unable to move, no power is developed. In such a case, all the E. M. F. applied by the mains is used up in forcing a current through the armature against its resistance, and the current is determined by Ohm's law,

$$C = \frac{E}{R_a},$$

where R_a is the armature resistance. The watts supplied are used up wholly in heating the armature conductors. If the armature is allowed to turn, a counter E. M. F. is at once generated by the motion of the conductors through the field. The motor is now in a position to deliver power, and the current which flows is such that it will enable the motor to carry its load and make up for the losses. The current is now determined by the relation

$$C_1 = \frac{E - E_m}{R_a}, \quad (603.)$$

where E_m is the counter E. M. F. generated at the load represented by C_1 . The E. M. F. which is now effective in forcing current through the armature is the difference between E and E_m , and $C_1 E_m$ represents the electrical energy which is active in the armature, the greater part of which is available at the pulley.

3787. The torque exerted by a motor may be determined as follows: The counter E. M. F. of the motor is determined in the same way as the E. M. F. of a dynamo, that is,

$$E_m = \frac{n C N}{10^8},$$

where E_m is the counter E. M. F. in volts, n the speed in revolutions per second, C the total number of conductors on the armature, and N the total magnetic flux. The total torque exerted by the armature must be equal to the torque exerted at the pulley plus the constant torque required to overcome friction. Let P be the difference in the pull between the tight and loose sides of the belt and r the radius of the pulley. Then the *useful torque* exerted at the pulley will be Pr . The *total torque* will be equal to $Pr + F$, where F is the torque necessary to overcome friction. The power w delivered at the pulley is $2\pi n r P = 2\pi n T$, where T is the useful torque. The total power developed in the armature will be $w' = 2\pi n T'$, where $T' = Pr + F$. If we

express r in feet, P in pounds, and n in revolutions per minute, then the power developed in the armature will be

$$\omega' = \frac{2\pi n T'}{33,000} \text{ horsepower.}$$

If we neglect the core losses, we must have

$$\frac{2\pi n T'}{33,000} = E_m C_m,$$

where C_m is the current flowing through the armature;

but,
$$E_m = \frac{\pi C N}{10^8},$$

and
$$C_m E_m = \frac{\pi C N}{10^8} \times C_m \text{ watts.}$$

If we express n in revolutions per minute instead of revolutions per second and divide by 746 to reduce to horsepower, we may write

$$\frac{2\pi n T'}{33,000} = \frac{\pi C N C_m}{60 \times 746 \times 10^8}$$

or
$$T' = \frac{33,000}{2\pi \times 60 \times 746 \times 10^8} \times N C C_m. \quad (604.)$$

This formula will be found more convenient in the form

$$T' = .00117 \frac{N^2 C^2 C_m}{10^8}. \quad (605.)$$

This gives the total torque exerted on the armature in foot-pounds. The torque exerted at the pulley would be less than this by the torque necessary to overcome friction, and the pull at the rim of the pulley would be the useful torque in foot-pounds divided by the radius of the pulley expressed in feet. It will be noticed that the speed n has canceled out of the above expression for the torque, and the equation shows that the torque depends upon the strength of field, the number of conductors, and the current.

EXAMPLE.—A motor armature is provided with 250 conductors. The current supplied to the armature is 80 amperes and the total magnetic flux is 3,000,000 lines. The pulley is 9 in. in diameter and the torque

necessary to overcome friction is $\frac{1}{2}$ foot-pound. (a) What will be the total torque exerted on the armature? (b) What will be the pull exerted at the rim of the pulley?

SOLUTION.—(a) We have for the total torque

$$T' = .00117 \times \frac{3,000,000 \times 250 \times 30}{10^6} = 26.3 \text{ foot-pounds. Ans.}$$

The useful torque will be $26.3 - .5 = 25.8 \text{ ft.-lb.}$

(b) The radius of the pulley is $4\frac{1}{2} \text{ in.} = \frac{3}{4} \text{ ft.}$

Hence, pull at rim = $\frac{25.8 \times 8}{3} = 68.8 \text{ lb. Ans.}$

ARMATURE REACTION.

3788. Armature reaction is present in motors as in dynamos, but its effects are somewhat different. Let

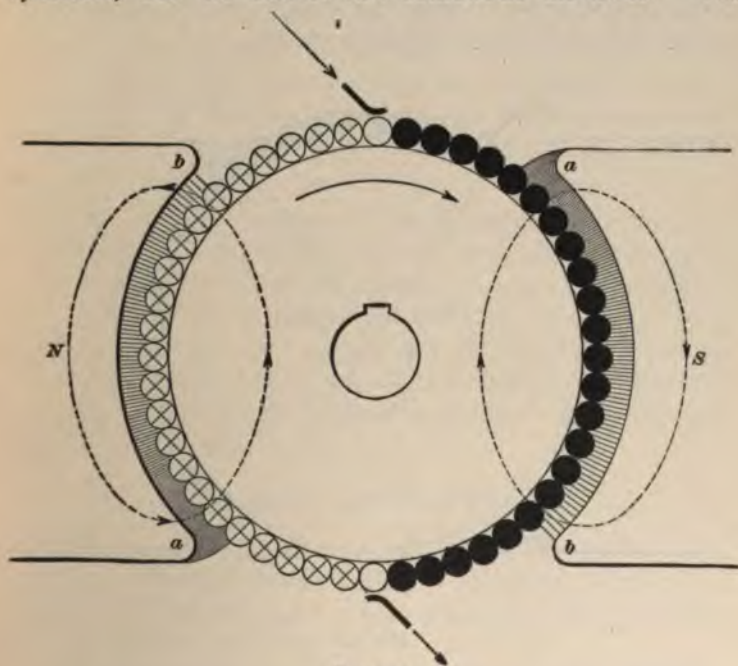

FIG. 1412.

Fig. 1412 represent the pole-pieces and armature of a two-pole motor, and suppose current to be sent into the armature

so that it flows, say, downwards through the paper in the right-hand conductors and upwards in those on the left. We will suppose for the present that the brushes are directly on the neutral line midway between the poles, as shown. The effect of the armature currents will be to cross-magnetize the field, as shown by the dotted lines, and by considering the direction of the cross-magnetism as related to the armature currents, it will be seen that the resultant effect is to weaken the pole corners b, b and strengthen a, a . It is also evident, from the relation of the field and current in the armature, that the direction of rotation will be as shown by the arrow, the effect of the cross-magnetization being to shift the field backwards as regards the direction of rotation instead of forwards, as in the case of a dynamo. It follows, then, that in order to keep the brushes at the non-sparking point, they must be shifted backwards.

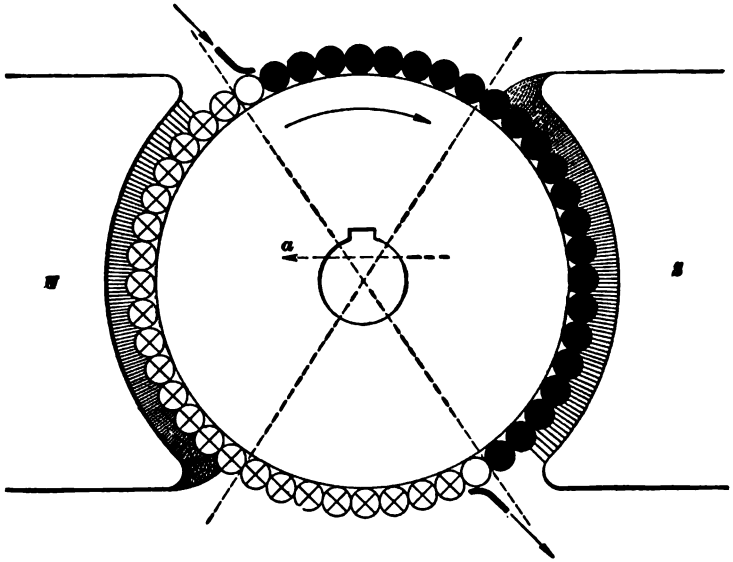

FIG. 1413.

3789. Fig. 1413 shows the same armature with the brushes shifted back to the non-sparking point. The shifting of the brushes brings into play the back ampere-turns

which are included between the double angle of lead. It will also be seen that these back ampere-turns tend to *demagnetize* the field, as shown by the dotted arrow at α , the action of the armature in this respect being the same as the action in a dynamo. It may also be noted here that if it were possible to operate the motor without sparking, with a *forward* lead of the brushes, the back ampere-turns would tend to *magnetize* the field. Small motors have been built to operate in this way, but it is not possible to so operate a motor of any considerable size without sparking. It is important that motors be designed so that the shifting of the sparking point from no load to full load shall be small. This means that the field should be "stiff" or powerful, and the effects of armature reaction made weak either by using a small amount of wire on the armature or properly proportioning the air-gap. In modern motors of good design the shifting of the neutral point is very slight. Carbon brushes are used almost exclusively, and the brushes may be left in the same position from no load to full load without sparking.

3790. It is instructive to note, in connection with motor armature reaction, that if the brushes have any lead forwards or backwards and a current be sent through the armature alone, the field being unexcited, the armature will revolve because the armature reaction will set up a field for the armature currents to react on. The torque produced would, of course, be very small, because the field set up in this way would be very weak.

CLASSES OF MOTORS.

3791. Continuous-current motors, like dynamos, are generally classed according to the methods adopted for exciting the field-magnets. This naturally divides motors into the following classes:

1. Shunt-wound.
2. Series-wound.
3. Compound or differentially wound.

Motors may also be operated with separately excited fields, but this is seldom done in practice. By far the larger part of the motors in use belong to the first two classes, the third class being used only to a limited extent. Differentially-wound motors are used in some cases where very close speed regulation is required, and motors with a combination of series and shunt windings are used to some extent for the operation of electric vehicles. Nearly all motors are operated on *constant-potential* circuits, the voltage across the terminals being maintained constant or nearly so by the dynamo supplying the system and the current taken by the motor varying with the load. In a few cases motors are operated on *constant-current* arc-light circuits, but their use is very limited. In this case the current through the motor remains constant, and the voltage across its terminals increases with the load.

SHUNT MOTORS.

3792. Outside of railway work, the shunt motor is more largely used than any other type because of the valuable speed-regulating qualities which render it well adapted for the operation of all kinds of machinery. The shunt-wound motor is identical, so far as its electrical construction is concerned,

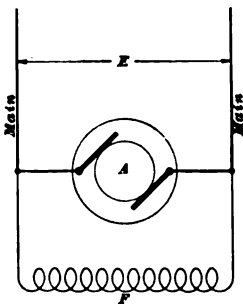

FIG. 1414.

with the shunt-wound dynamo. These motors are operated on constant-potential systems, the motor being connected directly across the mains when running, as shown in Fig. 1414, where *A* is the armature and *F* is the field. If *E*, the E. M. F. between the mains, is maintained constant, the current flowing through the shunt field will be constant. The field coils therefore supply the same

magnetizing force, no m
may be taking from

would be practically constant if there were no demagnetizing action of the armature. Take the case where the motor is running free and the only load which the armature currents have to overcome is the friction and other losses within the armature. The amount of energy which the motor will take from the line will just be sufficient to counterbalance these losses, and the armature will run up to a speed such that the counter E. M. F. will allow just sufficient current to flow to supply this loss of energy. Since this current is very small in a good motor, the counter E. M. F. when the motor is running light is very nearly equal to the line E. M. F., E .

ACTION OF SHUNT MOTOR.

3793. When a load is applied, the motor must take sufficient current to enable the armature to produce a torque sufficient to carry the load. In order to allow this current to flow, the counter E. M. F. must lower slightly, and as the field is nearly constant, this means a slight lowering of speed, because the counter E. M. F., E_m , is given by the expression

$$E_m = \frac{n C N}{10^8},$$

and C and N are practically fixed. At the same time it must be remembered that the back ampere-turns will make N slightly less when the motor is loaded than when it is not loaded, and this weakening of the field tends to keep the speed up. The net result is, therefore, that a shunt motor operated on a constant-potential circuit falls off slightly in speed as the load is applied, but if the motor is well designed and has a low-resistance armature, the falling off in speed from no load to full load will be very small. It is this speed-regulating feature which makes the shunt motor so widely used. If the load should be accidentally thrown off, there is no tendency to race, and the motor automatically adjusts itself to changes in load without materially changing its speed and without the aid of any mechanical regulating devices.

SPEED REGULATION.

3794. The speed of a shunt motor fed from constant-potential mains may be varied either by cutting down the applied E. M. F., E , or by changing the field strength. For any given load the motor has to generate a certain counter E. M. F.

$$E_m = \frac{nCN}{10^8}.$$

Solving this for n , we have

$$n = \frac{E_m 10^8}{NC}. \quad (606.)$$

It follows from formula **606** that if the field strength N be decreased, the speed n will be increased, the line E. M. F. remaining the same; also, if the field be strengthened, the speed will be decreased. This simply means that with a strong field the motor does not have to run as fast to generate a given counter E. M. F. as it would if the field were weak. The method of regulating the speed of a shunt motor by varying its field strength is sometimes used. It is the most efficient method for regulating speed, as it only necessitates cutting down the small field current by means of a resistance. The method described in the next article is, however, more generally used, though it causes a much larger waste of energy, and it is doubtful if it will not be displaced eventually by the field method. In using the field method of control, care must be taken to see that the weakest field used will allow the machine to operate without sparking.

3795. The speed may also be regulated by leaving the field at its full strength and cutting down the voltage applied to the armature by inserting an adjustable resistance in series with it. The connections for this method of speed regulation are shown in Fig. 1415, the adjustable rheostat R being connected in series with the armature A , and the field F connected directly across the mains. This method is rather wasteful of energy, but it is the one generally employed

when it is desired to control the speed of a shunt machine. If a shunt motor be overloaded or stalled in any way, the current becomes excessive, and the armature is burned out, unless it is protected by fuses or other safety device. Care should also be taken never to open the field circuit of such a machine while its armature is connected to the circuit. If

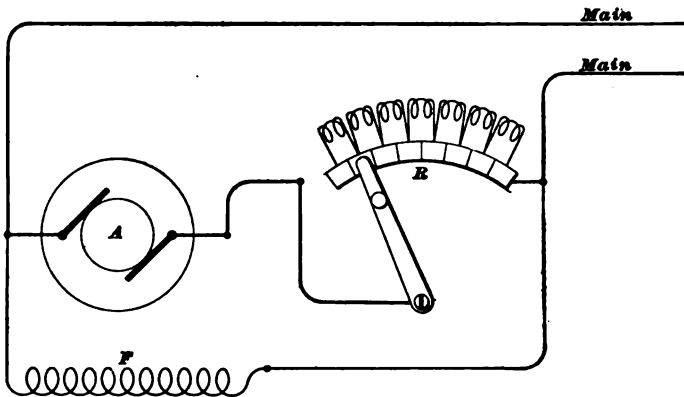

FIG. 1415.

the field circuit is opened, the machine is unable to generate any counter E. M. F., and the consequence is a large rush of current through the armature, which is at least apt to burn the commutator, and if not interrupted by means of fuses will in a short time burn out the armature.

SERIES MOTORS.

3796. These motors are constructed in the same way as series-wound dynamos; that is, the fields are excited by connecting the field coils in series with the armature, so that all the current which the motor takes from the mains flows through the field windings. The most extensive use of these motors is in connection with street-railways. They are also used to some extent for operating hoists, cranes, and other machinery of this class which requires a variable speed. Nearly all series motors, like shunt motors, are operated on constant-potential circuits. For example, the pressure of a

street-railway system is maintained approximately constant at 500 volts. Crane and hoist motors are usually operated at pressures of 110, 220, or 500 volts. Series motors are operated to a limited extent on *constant-current* arc-light circuits, but the number so operated is insignificant compared with those operated on constant-potential.

SERIES MOTOR ON CONSTANT-POTENTIAL CIRCUIT.

3797. Let *A*, Fig. 1416, represent the armature of a series motor connected in series with the field *F* across the

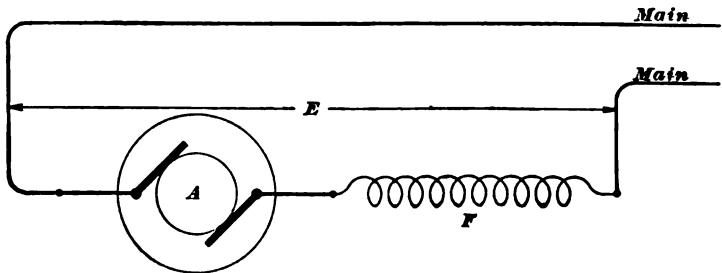

FIG. 1416.

mains, as shown. The pressure between the mains is maintained constant. We will denote this constant line pressure by *E*. We must have, then, the following relation:

$$E = E_m + CR_a + CR_f, \quad (607.)$$

where E_m is the counter E. M. F. of the motor, C the current corresponding to any given load, and R_a and R_f the resistances of the armature and field, respectively. The last two terms represent the drop in pressure due to these resistances, and the smaller the value of these terms the greater is the efficiency of the motor.

3798. First, we will consider the case where the motor is running light. Under this condition of load, the motor will take just enough energy from the line to make up for the losses due to friction, core losses, etc. As the armature speeds up, the counter E. M. F. increases and the current rapidly decreases. Now the field is in series with the

armature, so that as the current decreases the field strength also decreases and the armature has to run still faster to generate its counter E. M. F., which at no load is just about equal to the E. M. F. between the mains. The current necessary to supply the losses is usually very small if the motor is well designed, consequently the no-load current is very small, and the speed necessary to generate the counter E. M. F. becomes excessively high. In many cases this speed might be high enough to burst the armature. On account of this tendency to race, it is not safe to throw the load completely off a series motor unless there is some safety device for automatically cutting off the current. Of course in street-railway work there is always some load on the motors, so that no injury from racing is liable to result.

3799. When the motor is loaded, the counter E. M. F. decreases slightly, and this allows more current to flow. This current strengthens the field, and a correspondingly strong torque is produced. It should be noted here that the torque of a series motor depends directly upon the current which is flowing through it. This will be seen by referring to formula **605**. The torque is proportional to N and C_m ; but the field strength in a series motor depends upon C_m , so that the torque depends only on the current. This quality renders the series motor valuable for street-railway work, as a strong starting torque can be produced by allowing a heavy current to flow through the motor while the car is being started. Since the field strength of a series motor increases as the load is applied, it follows that the speed will decrease with the load and there will be a different speed for each load. This variable speed renders the series motor generally unsuitable for stationary work, such as operating machinery, etc., but is an advantage for street-railway work where a wide range of speed is desired. Series motors are more substantial and cheaper to build than shunt motors, on account of the fine field winding required by the latter. The field coils of series motors consist of a comparatively small number of turns of heavy wire, making a coil which is

less liable to burn-outs than the fine wire shunt coils and better fitted to stand the hard service connected with all street-railway work.

If a series motor be connected across the mains, the current which flows has to pass through the field as well as the armature, thus giving a good field for the armature currents to react on and produce the required starting torque. When a shunt machine is used, the field must first be connected to the mains and the current then allowed to flow through the armature. If this is not done, the current will all flow through the low-resistance armature in preference to the high-resistance field when the motor is first connected, and a very small starting torque will be the result.

SPEED REGULATION.

3800. The speed of a series motor may be regulated either by varying the strength of the field or by inserting a

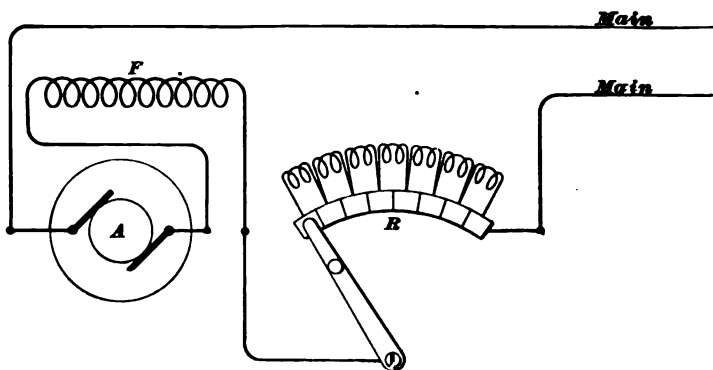

FIG. 1417.

resistance in series with the motor. The field strength may be regulated by having the field coils wound in a number of sections, and cutting these in or out, thus varying the effective number of turns. Another method is to shunt the fields by an adjustable resistance, thereby varying the amount of current which flows through the series coils. Both these methods have been used for controlling the speed of

street-car motors. In the resistance method of control, an adjustable rheostat is connected directly in series with the motor, as shown in Fig. 1417, thus cutting down the E. M. F. across the motor terminals. This method has also been used quite largely on street-cars and also for crane and hoist motors.

3801. The field-magnets of series motors are sometimes provided with such a large number of turns that the field becomes fully magnetized when the current flowing is only a fraction of the full-load current of the motor. This gives a field which does not change greatly in strength for a considerable range of load, and thus tends to make the speed vary less with changes in the load, and also keeps the motor from sparking at moderate loads, on account of the strong field obtained. Street-railway motors are generally "overwound" in this way.

SERIES MOTOR ON CONSTANT-CURRENT CIRCUIT.

3802. It has already been mentioned in Arts. **3791** and **3796** that series motors are operated to a limited

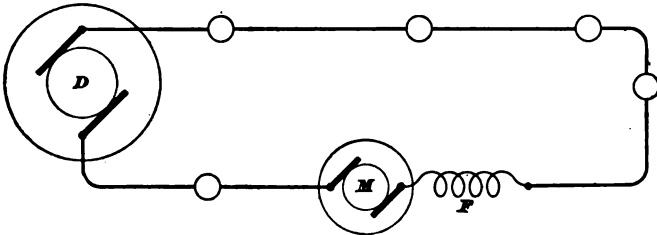

FIG. 1418.

extent on constant-current circuits. We will therefore examine briefly the action of the motor on such a circuit. Fig. 1418 shows a series motor *M* connected in an arc-light circuit, the current in which is kept at a constant value by means of a regulator on the dynamo *D*. Since the current flowing through the field *F* of the motor is constant, the strength of field will be constant and the torque will also be constant. If the armature were allowed to run free, it would

run very badly, the running being worse than in the case of a series motor on a constant-potential circuit, because in the latter case the current in the field and armature is reduced and the torque correspondingly cut down as the speed increases, whereas in this case the current is kept constant and the torque remains the same. It is thus seen that the speed of a series motor operated in this way would vary widely with the load, and such a motor without some regulating device would be unsuitable for operating machinery. In order to make such motors run at a nearly constant speed independently of the load, they are provided with a regulating device (usually a centrifugal governor of some sort) which either shifts the brushes or cuts sections

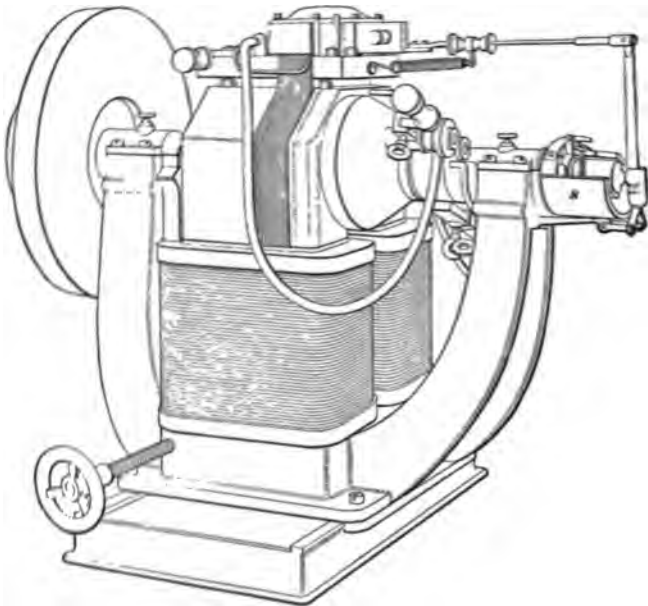

FIG. 1419.

of the field winding in and out in such a way as to maintain a nearly constant speed. Fig. 1419 shows a motor intended for operation on a constant-current circuit. In

this case the centrifugal governor on the end of the shaft operates a switch which alters the effective number of turns on the field. The fly-wheel is provided to smooth out any fluctuations in speed caused by the governor not acting instantaneously.

3803. The use of motors on constant-current arc circuits is not as general now as it once was. It is the general practice now to run special constant-potential lines for the operation of motors. Series motors on arc circuits are always more or less dangerous on account of the high pressures generated by arc dynamos. Also, if the output of the motor is at all considerable, the pressure across its terminals at full load may be quite high. For example, a 10 K. W. motor operating on an 8-ampere circuit would at full load have a potential of $\frac{10,000}{8} = 1,250$ volts across its terminals.

DIFFERENTIALLY-WOUND MOTORS.

3804. These motors are essentially the same in construction as the compound-wound dynamo, except that the series coils are connected so as to oppose the shunt coils instead of aid them as in the dynamo. The object of this arrangement is to secure constant speed when the voltage of the dynamo supplying the motor is constant. The series coils decrease the field strength slightly, and by thus weakening the field lower the counter E. M. F. sufficiently without the speed decreasing. These motors are not used as generally now as they once were, because it is found that a well-designed shunt-wound

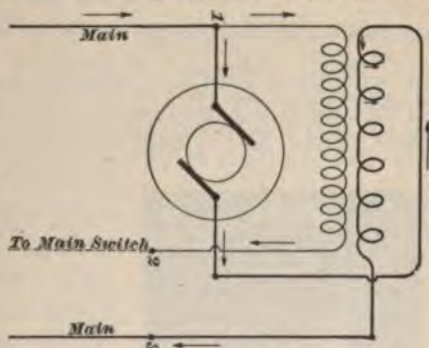

FIG. 1420.

motor will give sufficiently close speed regulation for all practical purposes. Fig. 1420 shows the connections of a differential motor, the coils being intended to represent windings in opposite directions, one right-hand, the other left-hand.

AUXILIARY APPARATUS.

STARTING RHEOSTATS.

3805. When motors are operated on constant-potential circuits, it is necessary to insert a resistance in series with the armature when starting the motor. Of course, in the case of a series motor, this starting resistance is also in series with the field. The resistance of a motor armature is very small in any type of motor, and in the case of a series motor the field resistance is also small, so that if the machine were connected directly across the circuit while standing still, there would be an enormous rush of current, because the motor is generating no counter E. M. F. Take, for example, a shunt motor of which the armature resistance is .1 ohm. If this armature were connected across a 110-volt circuit while the motor was at a standstill, the current which would flow momentarily would be $\frac{110}{.1} = 1,100$ amperes, the amount being limited only by the resistance of the armature. In the case of a series motor, the rush of current would not be quite as bad, as the field winding would help to choke the current back, but in either case it is necessary to insert a resistance and gradually cut it out as the motor runs up to speed and generates a counter E. M. F. which is able to regulate the current flowing.



FIG. 1421.

3806. The starting rheostat, or **starting box**, as it is often called, is simply a resistance divided up into a number of sections

and connected to a switch, by means of which these sections can be cut out as the motor comes up to speed. When the motor is running at full speed, this resistance is completely cut out, so that no energy is lost in it. Fig. 1421 shows a simple form of motor-starting rheostat, the resistance wire in this particular type being bedded in enamel on the back of an iron plate, while the ribs r on the front are intended to present additional cooling surface to the air. Starting rheostats are not designed to carry current continuously, and should therefore never be used for regulating the speed of the motor. The resistance wire is made of such a size as to be capable of carrying the current for a short time only, and if the current is left on continuously the rheostat will be burned out. The handle h of the rheostat shown is provided with a spiral spring s , tending to hold it against the stop a , which makes it impossible to leave the contact arm on any of the intermediate points. On the last point a clip c is placed to hold the arm of the rheostat.

SHUNT-MOTOR CONNECTIONS.

3807. The method of connecting up a shunt motor to constant-potential mains is shown in Fig. 1422. The lines leading to the motor are connected to the mains through a fuse block D , from which they are led to a double-pole knife switch B . One end of the shunt field F is connected to terminal 1 of the motor, and one brush is also connected to the same terminal. The other field terminal is connected to the motor terminal 2, and the other brush leads to the third terminal 3. One side of the main switch connects to terminal 1; the other side connects to 3 *through the starting rheostat C*. Terminal 2 connects to the same side of the switch as the starting rheostat. It will be seen from the figure that as soon as the main switch is closed, current will flow through the field F , and thus magnetize it before any current flows through the armature A (the first contact on the rheostat being a dead point). When the rheostat arm

is moved over, current flows through the armature, and a strong starting effort is produced, because the field is already

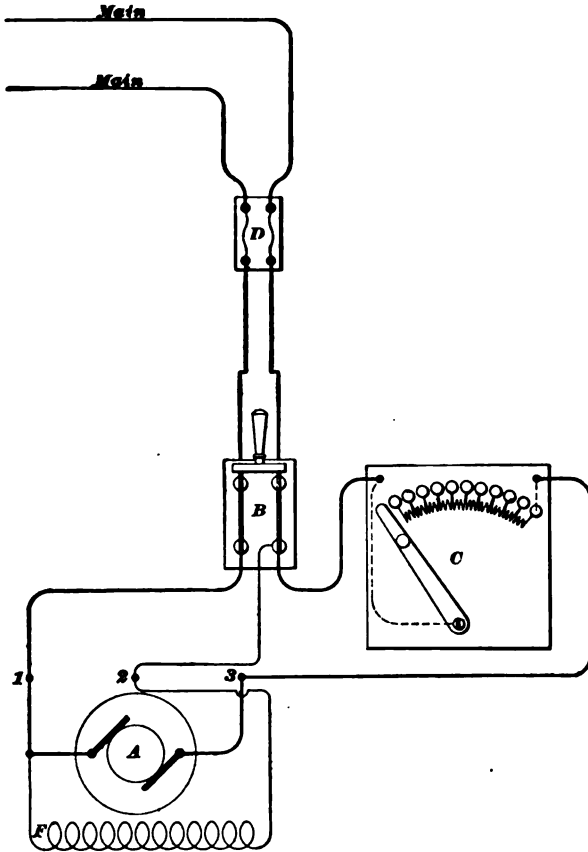

FIG. 1422.

magnetized. The handle is then moved over slowly and left on the last point when the motor has attained its full speed.

SERIES-MOTOR CONNECTIONS.

3808. The connections for a series motor are shown in Fig. 1423. Connection is made to the mains through a switch and fuse block as before. The motor connections

are somewhat simpler than in the last case, one terminal of the armature *A* being connected at *a* to one terminal of the field, *c* and *d* forming the two terminals of the motor. The starting rheostat *C* is simply connected in series with the armature, as shown. When a current flows through the armature, the same current also flows through the field, so that there is always a magnetic field present to produce

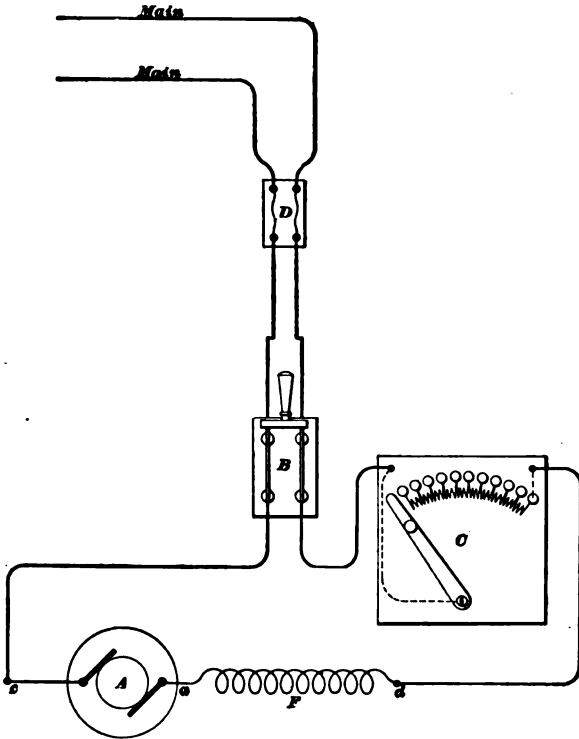

FIG. 1423.

the required starting torque. On account of the field winding acting to a certain extent like a starting resistance, series motors do not require as large an amount of resistance in the starting rheostat as shunt motors. This feature is of value in street-railway work, as it permits the use of a less bulky starting resistance than would otherwise be required.

AUTOMATIC SWITCHES.

3809. When the simple form of starting box is used, it is necessary to see that the handle is moved back to the off position every time the motor is shut down or the current cut off in any way. If this is not done, and the switch is thrown in, on starting up again, with the resistance all out of the circuit, there will result a heavy rush of current. In order to obviate this, motors are now usually provided with automatic boxes, the switch-lever of which automatically flies back to the off position when the current is shut

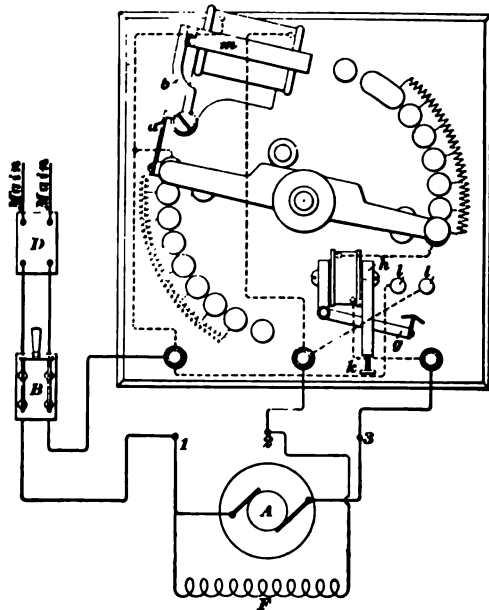

FIG. 1424.

off. They are also generally provided with an arrangement for throwing the switch-lever back, and thus breaking the circuit, when the motor is overloaded. Fig. 1424 shows the arrangement of an automatic box of this type, made by the General Electric Co., which will serve to illustrate the action of most of these automatic starting rheostats. The resistance is connected between the contact points, as shown, the arm

being shown in the running position with the resistance all cut out. The contact arm is moved over against the action of a spiral spring in the hub and is held in position by a catch *a*, which fits into a notch in the hub of the lever *b*. This lever carries an armature *c*, which is held down against the action of a spring by the magnet *m*. The exciting coil of this magnet, in the case of a shunt machine, is connected in series with the field; in the case of a series machine, it is wound with heavy wire and connected in series with the motor. If the current is cut off in any way, the magnet releases the armature and the switch-lever flies back to the off position.

3810. Fig. 1424 shows a device for protecting the motor against overloads. It consists of an electromagnet, the coil of which is connected in series with the armature *A*. This magnet is provided with a movable armature *g*, the distance of which from the pole *h* may be adjusted by the screw *k*. When the current exceeds the allowable amount, the armature is lifted, thus making connection between the pins *l*. This connection short-circuits the coil of the magnet *m* and the lever goes to the off position.

SERIES-MOTOR CONNECTIONS.

(CONSTANT-CURRENT CIRCUITS.)

3811. No starting rheostat is required for series motors operated on constant-current circuits, because the current can never exceed that furnished by the dynamo. Fig. 1425 shows the connections for such a motor. Two switches *A* and *B* should be used. Switch *A* is placed outside the building, to cut off the current in case of fire, etc. Switch *B* is used for starting and stopping the motor. Both these switches should be of the quick-break variety, similar to those used for cutting out sections of arc-light circuits. These switches must be so arranged as to cut out the motor by short-circuiting it and not by opening the circuit; that

is, the motor is cut in and out in the same way as an arc lamp.

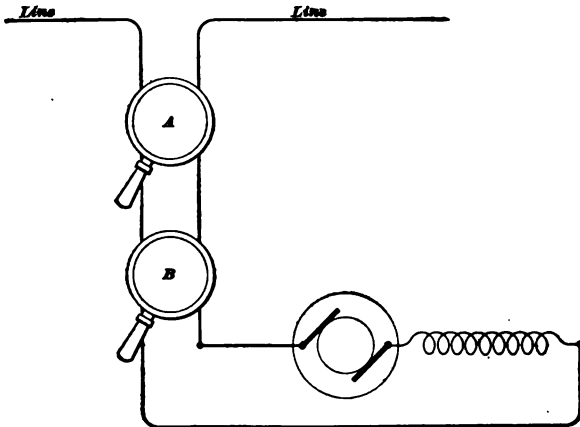

FIG. 1425.

REGULATING RHEOSTATS.

3812. Rheostats used for regulating the speed by being placed in the armature circuit must be designed to carry the current continuously without overheating. These rheostats have, therefore, to be made much larger than starting boxes, which carry the current for a short time only. Such rheostats were used largely at one time for the control of street-cars, but have now been displaced, owing to the adoption of more economical methods. All regulating rheostats, starting boxes, etc., should be installed in connection with motors in accordance with the rules of the Board of Fire Underwriters. This also applies to the size of wire which should be used for connecting up the motors and the installation of the motors themselves.

METHODS OF REVERSING MOTORS.

3813. It is necessary for some kinds of work to have a motor so arranged that its direction of rotation may be readily reversed. This is especially the case with street-car motors, motors for electric vehicles, etc. If the student

will refer to Figs. 1408, 1409, and 1410, he will readily see that if the direction of the current in the wire *a* be reversed while the field is left unchanged, the direction of motion will be reversed. Also, if the direction of the current in the wire is left unchanged and the field reversed, the direction of motion will be reversed. If both current and field be changed, the direction of motion will remain unchanged. It follows, therefore, that if we wish to change the direction of rotation of a given motor, we must change either the direction of the current through the armature and leave the field the same, or change the direction of the current through the field and leave the armature current the same. If both are changed at the same time, the direction of rotation will not be altered.

3814. A shunt motor may be easily reversed by reversing its field connections. Suppose a shunt motor to be connected up as shown in Fig. 1426, and that it runs in the direction indicated by the arrow. The line is connected to terminals 1 and 3 and the field to terminals 1 and 2 when the motor is in operation and the starting resistance cut out. Terminal 2 is connected to the other main, as shown in Fig. 1422. It is evident that reversing the line terminals 1 and 3 will not reverse the motor, because the current would be reversed in both armature and field. If, however, the field connections to 1 and 2 are interchanged, the current will be reversed through the field, while it will remain unchanged in the armature and the direction of rotation will be reversed. It is also evident that if the armature terminals 1 and 3 be reversed while the field terminals are left attached to 1 and 2, the direction of rotation will be reversed.

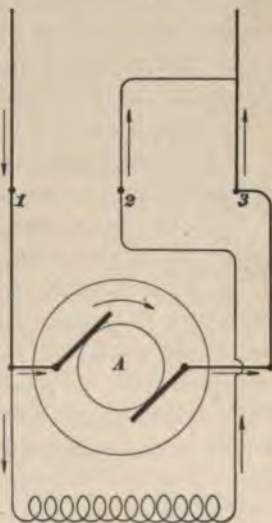

FIG. 1426.

3815. A series motor will run in the same direction, no matter which of the supply lines is connected to its terminals *a, b*, Fig. 1427. In fact, small series motors may, if constructed properly and provided with laminated fields, be run on an alternating-current circuit. Reversing the line connections simply reverses the current through both armature and field, and does

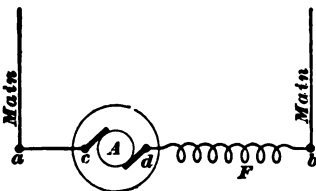

FIG. 1427.

not, therefore, change the direction of rotation. In order to reverse the motor, either the armature terminals *c, d* must be interchanged, so as to reverse the current through the armature, or the terminals *d, b* must be interchanged, so as to reverse the current through the field. In street-railway work the motors are usually reversed by reversing the current through the armature, the current through the field remaining unaltered. These changes are made by means of the reversing switch placed in the car controller. All motors which are reversed during their operation should be provided with radial carbon brushes.

When it is desired to reverse a motor while it is running, it is very necessary to insert a resistance in the armature circuit before reversing the current through the armature. It must be remembered that the counter E. M. F. which the motor was generating just before reversal becomes an active E. M. F. and helps to make the current flow through the armature as soon as the current is reversed, and this action continues until the motor starts to turn in the opposite direction. If, for example, a 110-volt motor were reversed while running, without inserting any resistance, the effect would be the same as if the motor armature were connected directly across 220-volt mains, because the whole E. M. F. which the motor was previously generating would be effective in aiding the line E. M. F. It is best, therefore, when possible, to let the motor drop considerably in speed, or even come to a standstill, before reversing it, and where this can not be done considerable resistance should be inserted, or a bad short circuit may result.

DESIGN OF CONTINUOUS-CURRENT MOTORS.

3816. Since continuous-current motors are constructed in the same way as continuous-current dynamos, and the same requirements for high efficiency apply to both, it follows that the machine which makes a good dynamo will, in general, operate well as a motor. At one time the idea prevailed that a motor in order to operate well should be designed differently from a dynamo, but it may be taken as a general rule that if the machine runs efficiently as a dynamo, giving a nearly constant voltage when driven at constant speed, it will run efficiently as a motor, and give a nearly constant speed when supplied with a constant voltage. On the other hand, some machines which will operate fairly well as motors will not operate well as dynamos. For example, some small shunt and series motors will not operate when driven as dynamos, because they are not capable of exciting their fields; whereas, when they are run as motors their fields are excited by current from the mains, and they are therefore capable of operation. In designing continuous-current motors, therefore, we may determine what the output of the motor would be if run at the required speed as a dynamo, and then design the motor as if it were a dynamo, making use of the various rules already given in connection with continuous-current dynamo design. All the principles which have been laid down with regard to armature reaction, length of air-gap, calculation of field winding, etc., apply to motors as well as dynamos.

DETERMINATION OF OUTPUT.

3817. Suppose a given machine be run as a dynamo: the total electrical power developed in the armature will be equal to the power delivered at the terminals plus the loss due to armature resistance, and the loss in the field or the power delivered will be the total power developed in the armature multiplied by the electrical efficiency. When the

machine is operated as a motor, the total electrical energy developed in the armature will be the total electrical energy supplied from the mains less the loss due to field and armature resistances, or it will be the total energy supplied multiplied by the electrical efficiency of the motor. If E_m is the counter E. M. F. of the motor, C the current flowing through the armature, and E the E. M. F. between the mains, we have for a series motor

$$\text{Total energy supplied from mains} = CE, \quad (608.)$$

because in the case of a series motor the current in both armature and field is C . Also

$$\text{Energy developed in armature} = CE_m, \quad (609.)$$

and

$$\text{Electrical efficiency} = \frac{CE_m}{CE} = \frac{E_m}{E}. \quad (610.)$$

For a shunt motor, we have

$$\text{Total energy supplied} = CE + cE, \quad (611.)$$

where c is the current through the shunt field, and

$$\text{Energy developed} = CE_m.$$

$$\text{Electrical efficiency} = \frac{CE_m}{E(C+c)}. \quad (612.)$$

3818. In the case of a dynamo, the total electrical energy developed in the armature is less than the total energy supplied at the pulley by the amount of the losses due to friction, hysteresis, and eddy currents; that is, the total electrical energy generated is the total mechanical power supplied multiplied by the efficiency of conversion of the dynamo. In a motor the useful output at the pulley is equal to the total electrical energy in the armature less the above losses, or is the total electrical energy generated multiplied by the efficiency of conversion of the motor.

3819. From the above relations, it will be seen that if we know approximately the values of these efficiencies for the size of motor which we wish to design, we can calculate what the output of the motor would be if run as a dynamo,

and then proceed to design it as if it were a dynamo. Fig. 1428 shows the approximate values of those efficiencies for motors up to 150 horsepower. The upper curve *A* gives the electrical efficiency at full load, that is, the ratio of electrical energy developed in motor armature to input, and the

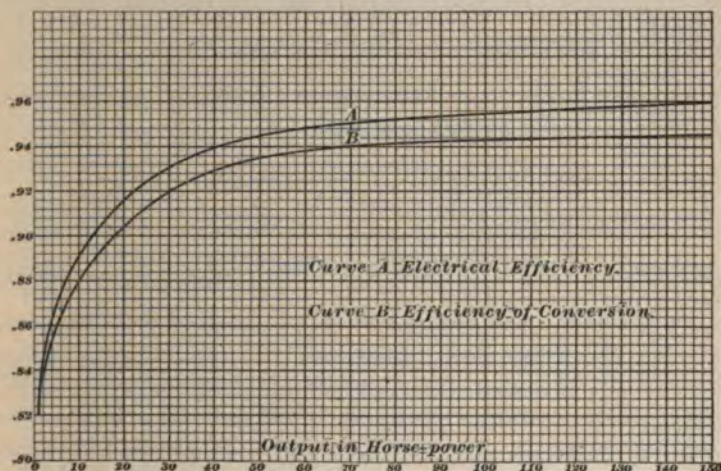

FIG. 1428.

lower curve *B* gives the efficiency of conversion or the ratio of power developed at pulley to electrical energy developed in armature. The product of these two efficiencies gives the commercial efficiency or ratio of useful work delivered at the pulley to the total energy supplied from the mains.

DESIGN OF 10 H. P. SHUNT MOTOR.

3820. We will suppose, for example, that it is desired to design a 10 H. P. shunt motor to operate on a 220-volt circuit and to run at a speed of 1,000 R. P. M. at full load. The field takes 3% of the total electrical input. It is required to find the current capacity of the armature of the corresponding dynamo, and also the voltage which it must generate when run at the above speed, so that we may proceed to design the motor as if it were a dynamo. The

efficiency of conversion of a machine of this size is, according to Fig. 1428, about .88, and the electrical efficiency is about .89. In order, then, to get a useful output of 10 H. P.

the input must be $\frac{10 \times 746}{.88 \times .89} = 9,525$ watts. The line pressure is 220 volts; hence, the total current taken at full load

is $\frac{9,525}{220} = 43.3$ amperes, nearly. Of this current input 3%,

or about 1.3 amperes, flows around the field, so that the armature current at full load would be about 42 amperes.

The total electrical energy in the armature is $\frac{10 \times 746}{.88} =$

8,477 watts; hence, the voltage generated in the armature must be $\frac{8,477}{42} = 201.8$ volts. In order, therefore, to obtain

a motor which will deliver 10 H. P., we must design a dynamo of which the armature has a current-carrying capacity of 42 amperes and which will generate 202 volts, nearly, when run at a speed of 1,000 R. P. M. When this machine is run as a motor, the speed at no load will be slightly over 1,000 R. P. M., because the counter E. M. F. generated will then be nearly 220 volts. The shunt field would be designed for a current of 1.3 amperes, and the winding would be calculated in the same way as the shunt winding for a dynamo, except that no allowance would be made for a field rheostat, the winding being designed for connection directly to the 220-volt mains.

3821. The output of the dynamo corresponding to a series motor is determined in much the same way as that for a shunt motor, formulas **608**, **609**, and **610** being used. Of course in a series motor the field winding must be capable of carrying the full-load current, but the efficiency, etc., for the two types of motor of the same output should be about the same. The curves shown in Fig. 1428 may therefore be used in connection with series-motor calculations.

DESIGN OF 10 H. P. SERIES MOTOR.

3822. Suppose it were desired to design a 10 H. P. series motor to operate on 220-volt constant-potential mains. We will take the loss in the field as 3% as before, and calculate the current and voltage output of the corresponding dynamo accordingly. The efficiencies will be the same as before, that is, electrical efficiency = .89 and efficiency of conversion = .88. The total input will be 9,525 watts, or 43.3 amperes. In this case, however, the armature must be designed for 43.3 amperes instead of 42 as before. The total electrical energy in the armature will be 8,477 watts, as in the last case, and the counter E.M.F. will be $\frac{8,477}{43.3} = 195.8$. The dynamo must therefore have an armature wound to deliver 43.3 amperes at 195.8 volts. The voltage generated by the armature is less in this case than with the shunt motor, because a portion of the line E.M.F., E , is used up in forcing the current through the field coil. The speed of the motor would vary with the load, since the field magnetization varies with the load. The drop through the field at full load would be $220 \times .03 = 6.6$ volts.

3823. It is specially important, in connection with the electrical side of motor design, to see that the field is very strong compared with the armature, in order to minimize the shifting of the brushes with the load. This is specially necessary in the case of motors, because they are liable to run under large and sudden fluctuations in load, and in many cases are frequently reversed, thus rendering a fixed point of commutation extremely necessary.

MECHANICAL DESIGN.

STATIONARY MOTORS.

3824. The general mechanical design of stationary motors is much the same as that of stationary dynamos; in fact, in many cases the same castings, armature disks, etc. are used for both. Both series and shunt motors are built

the same way, the only difference being in the field winding. The parts of a motor should be made as simple as possible, since motors do not generally get the same amount of care as dynamos. Carbon brushes are used almost exclusively, as they tend to keep down sparking with changes in the load.

3825. It is becoming customary to design stationary motors so that they are enclosed as much as possible, in some cases even the commutator and brushes being covered. This style of construction is advantageous where the motor is operated in places where it is exposed to flying particles. It should be remembered, however, that the more a motor is enclosed the more liable it is to run hot, because the heat losses are not so easily radiated. Due regard to the heating effect should therefore be given when designing motors of the iron-clad type.

3826. The details of the bed, bearings, field frame, armature, etc., for stationary motors are the same as those which already have been given for dynamos in the section on Dynamo Design, so that these do not need to be mentioned further.

STREET-RAILWAY MOTORS.

3827. The design of street-railway motors must, from the nature of the work which they have to do, be considerably different from that of stationary motors. The differences are, however, more in the mechanical construction than in the electrical part. As mentioned previously, all these motors are series-wound, because this type of winding allows a large starting torque and a variable speed, besides being cheap compared with the fine shunt winding.

3828. The general dimensions of such motors must be adapted to the space which they occupy under the car. This space is limited by the gauge of the track and the diameter of the car-wheels. The designer is therefore considerably restricted as to the shape which he can give such a motor. The lowest point of the motor should not be less than $3\frac{1}{4}$ or

4 inches above the surface of the rail; otherwise, there will be danger of the motor striking stones which may be lying on the track. These motors must also be water and dust proof, conditions which are accomplished in practice by using the iron-clad construction and making the field frame of such form as to completely enclose the motor.

3829. Fig. 1429 shows a Westinghouse motor of modern type, which will give an idea as to the arrangement of



FIG. 1429.

the parts. Fig. 1430 shows the same motor with the lower half of the field swung down to allow access to the armature. The field yoke is made in halves, and each half is provided with two salient pole-pieces P, P projecting radially inwards. Nearly all modern railway motors are of the four-pole type, and it will be noticed that the field of the motor shown is really only a modification of the circular type with radial poles. The car-axle passes through the bearings A, A , and the other side of the motor is supported by the nose casting N , Fig. 1429, which is supported on springs resting on the truck. The two brushes are connected to the cables d, d' . The field terminals are shown at e, e' .

3830. Cast steel is now used altogether for the field castings of these motors. The use of this metal instead of cast iron has largely reduced the weight of the motors

compared with the output. This metal is practically as good as wrought iron as regards its magnetic qualities, thus allowing the field castings to be made quite thin (see Fig. 1430), and yet have a sufficient cross-section of metal to carry the

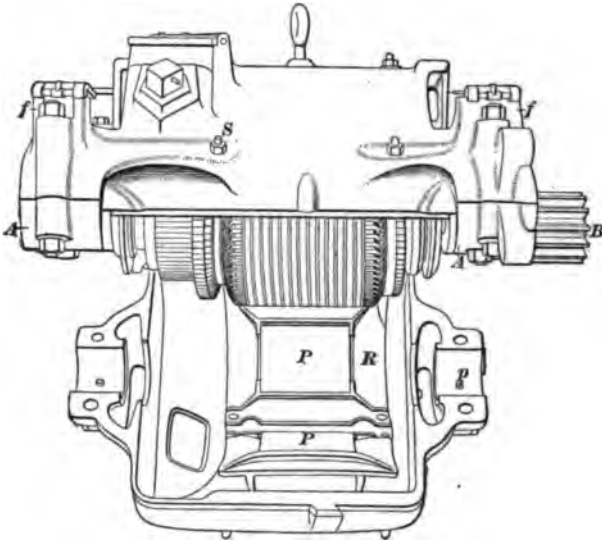

FIG. 1430.

magnetic flux. The steel is also strong mechanically, and is well able to stand the hard knocks to which a street-railway motor is subjected. The series coils are provided with a sufficient number of turns to set up a strong field, even when the motor is only partially loaded. The field coils are wound on forms, and are afterwards held in place by a heavy taping. They are very thoroughly insulated and treated with insulating varnish and paint to make them waterproof. The pole-pieces are necessarily very short, owing to the limited dimensions of the motor. The coils are held in place on the motor shown by the plates *R*, which are drawn up by the bolts *S*, the field coils themselves being short and flat.

3831. The bearings for these motors usually consist of sleeves of cast iron or brass, the former always being lined with babbitt metal. These bearing sleeves are usually made

in halves, though the armature bearings are sometimes made solid. These shells are held from turning by means of pins *p*, Fig. 1430, in the main casting. The bearing sleeves do not project inside the motor casing, the object being to keep out grease as much as possible. Grease is used as a lubricant, and is held in the large grease-cups *f, f*. The cover *C*, Fig. 1429, is removed when it is desired to inspect the brushes or commutator.

RAILWAY-MOTOR ARMATURES.

3832. The armatures used for all modern railway motors are of the toothed type. The coils are form-wound, and are usually arranged in two layers, in order to permit the use of a fairly large number of coils with a small number of slots, and also to allow an easy arrangement of the end connections. Straight slots are generally used, the coils being held in place by band wires, as in Fig. 1431, which

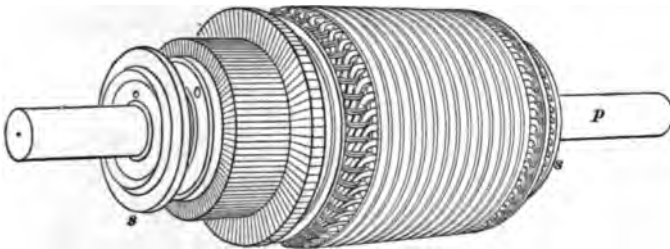

FIG. 1431.

shows the armature for the motor shown in Figs. 1429 and 1430. It will be noticed that the general design of this armature is much the same as that for any continuous-current motor of the multipolar type. The commutator is usually of very substantial construction, as it is generally subjected to a good deal of hard usage. Shields *s, s* are provided to keep grease from working its way along the shaft to the interior of the motor. The pinion end of the shaft *p* is tapered so that the pinion may be readily removed when worn out.

3833. Railway-motor armatures can not be made of very large diameter, on account of the limited space in which the motor must be placed. Such armatures are therefore usually longer, compared with their diameter, than those of multipolar stationary motors of corresponding output. Street-railway motor armatures are nearly always provided with a two-path or series-drum winding, as this type of winding requires only two sets of brushes for a multipolar machine, thus doing away with the necessity of brushes on the under side of the commutator, where they would be hard to get at. The two-path winding also has the advantage that it gives no trouble in case the field becomes unbalanced. An unbalanced field may be caused by the bearings wearing down, thus causing the armature to come nearer the lower poles. If a multiple-circuit winding were used, the uneven field caused by the above might give rise to local currents in the armature, which would cause heating. In some cases the center of the armature bearings is raised slightly above the center of the field bore, thus making the field pull up on the armature and lessening the weight on the bearings, as well as allowing for wear, and keeping the armature as a whole more nearly in the center of the field as the bearings wear down.

GEARS AND PINIONS.

3834. Ordinary street-railway motors usually range from 25 to 50 H. P. capacity. It has not been found practicable to build efficient motors of this size which will run slow enough to admit of direct connection to the axle. In order to allow a higher armature speed, gearing must be used, most equipments being geared so that the armature runs from four to five times as fast as the axle. This gearing is completely enclosed in a malleable iron or steel housing and runs in grease or oil. Such gearing, if properly cut, runs with very little noise and causes but small loss of power. The pinion on the motor axle is usually made of tool steel, in order to give it good wearing qualities. The axle gear is sometimes made of cast iron, but the best gears are made of

cast steel. All gears should have the teeth cut from the solid blank. The teeth are usually 3 diametral pitch on motors of ordinary size, the exact number of teeth in each gear depending upon the ratio of speed reduction desired. Common values are 13 or 14 teeth for the pinion and 65 or 67 teeth for the axle gear. The face of the gears may be from 4 to $5\frac{1}{2}$ inches, depending upon the output of the motor, and the axle gear must be made in halves, so as to be easily attached to the axle. The pinion is solid, being made out of a forged tool steel blank ; it is bored out on a taper to match the shaft and is keyed firmly to it.

3835. In conclusion, it may be stated with regard to street-railway motors that their construction should be the best possible in every respect. High finish is not necessary, but the mechanical and electrical workmanship must be of a high grade, because these motors are called upon to do harder work and to stand more mechanical shocks than any other type.

THEORY OF ALTERNATING-CURRENT APPARATUS.

THEORY OF ALTERNATING CURRENTS.

3836. In studying the applications of electricity, there are in general two distinct classes of electric currents to deal with, namely, *direct currents* and *alternating currents*. Most of the practical applications of electricity were formerly carried out by means of the direct current; but during recent years the alternating current has come extensively into use.

3837. The apparatus used in connection with alternating-current installations is in general different from that which has been previously described as used in connection

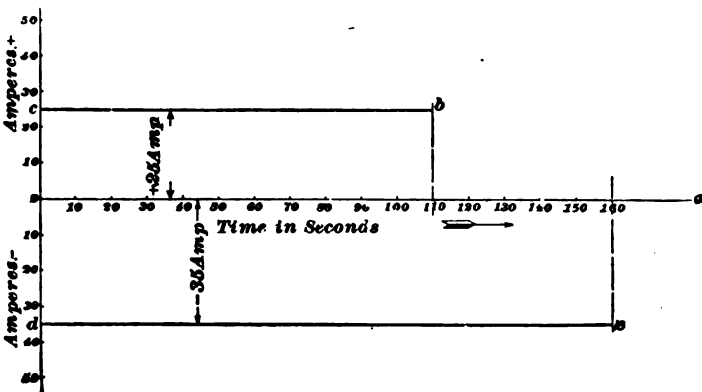

FIG. 1482.

with direct-current outfits, and needs to be considered separately. Moreover, on account of the nature of alternating currents, they do not flow in accordance with the simple laws which govern the flow of direct currents.

For notice of copyright, see page immediately following the title page.

3838. In continuous-current circuits the current flows uniformly in one direction; in other words, as time elapses the value of the current does not change. This condition might be represented graphically as shown in Fig. 1432. Time is measured along the horizontal line oa , and as the current remains at the same value, it might be represented by the heavy line bc ; the height of this line *above* the horizontal would indicate the value of the current, i. e., + 25 amperes. A current of -35 amperes, which would be flowing in the opposite direction, would be represented by the heavy line de *below* the horizontal.

3839. In the case of alternating currents the direction of the flow is continually changing. This may also be shown graphically as in Fig. 1433. In this case a current of 25

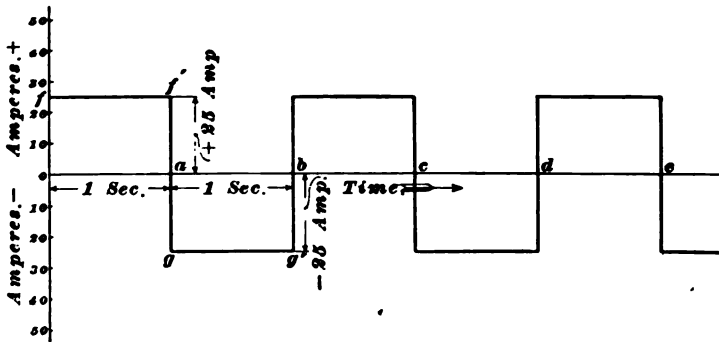

FIG. 1433.

amperes flows for an interval of one second in the positive direction, then reverses, flows for a similar interval in the opposite direction, and then reverses again. This operation is repeated at regular intervals as shown by the line, and any current which passes repeatedly through a set of values in equal intervals of time, such as that shown above, is known as an **alternating current**. The line $off'agg'b$ is often spoken of as a **current**, or **E. M. F., wave**, depending upon whether the diagram is used to represent the current flowing in a circuit or the E. M. F. which is setting up the current. The positive half wave $off'a$ is of almost exactly

the same shape as the negative half wave $ag' b$ in most practical cases. Induction-coils produce E. M. F.'s which have different positive and negative half waves, but in the case of E. M. F.'s produced by alternating-current dynamos the two waves are almost identical.

3840. The outline of the alternating-current waves usually met with in practice is always more or less irregular,

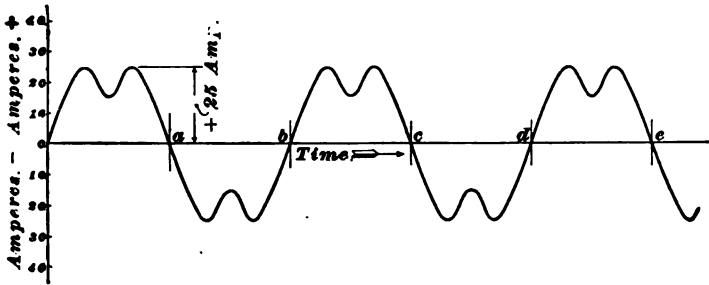

FIG. 1434.

the shape of the wave depending largely upon the construction of the alternator producing it. Some of the more common shapes met with are shown in Figs. 1434, 1435, 1436, and 1437. Figs. 1434, 1435, and 1436 show the general shape of the waves produced by some alternators used largely for

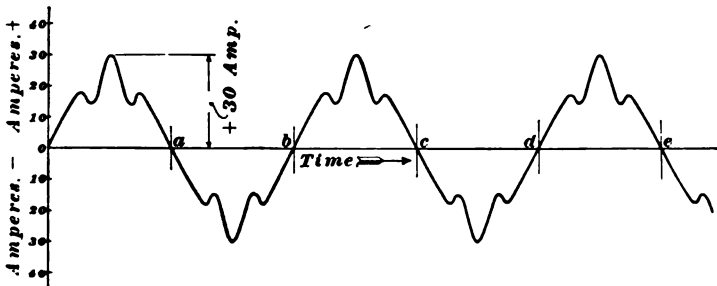

FIG. 1435.

lighting work and having toothed armatures. The student should notice that while the waves are irregular, the same set of values are repeated over and over, and that the set of negative values of the current is the same as the positive, thus producing a symmetrical curve with reference to the

horizontal line. Fig. 1437 represents a form of wave which is commonly met with, especially in the case of large alter-

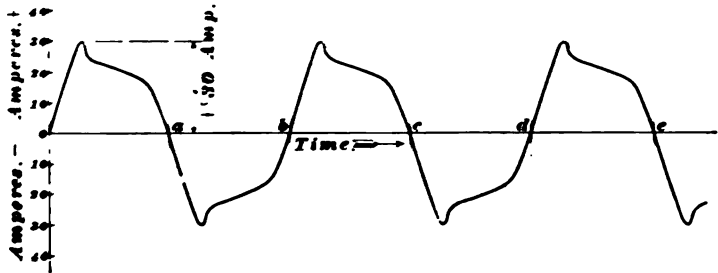

FIG. 1436.

nators designed for power transmission. It will be noticed that this curve is practically symmetrical as regards both

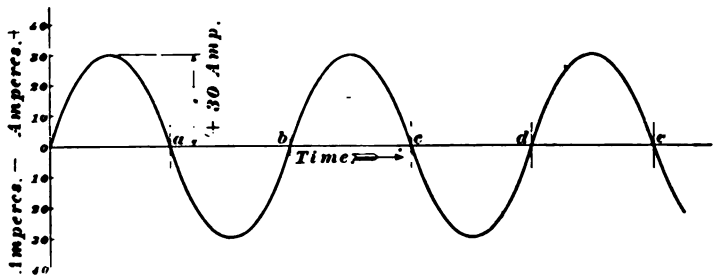

FIG. 1437.

the horizontal line $0 a b c$ and a vertical passing through the highest point of the curve.

CYCLE, FREQUENCY, ALTERNATION, PERIOD.

3841. In all the curves shown in Figs. 1434 to 1437 the current passes through a set of positive values while the interval of time, represented by the distance $0 a$, is elapsing, and through a similar negative set during the interval represented by the distance $a b$. This operation of passing through a complete set of positive and negative values is repeated over and over in equal intervals of time.

The complete set of values which an alternating current passes through repeatedly as time elapses is called a cycle.

A cycle would therefore be represented by the set of values which the current passes through while the time represented by the distance Ob was passing.

3842. *The number of cycles passed through in one second is called the **frequency** of the current.* For example, if the current had a frequency of thirty, it would mean that it passed through thirty complete cycles or sets of values per second. In this case the distance Ob would, therefore, represent an interval of one-thirtieth of a second, and the time occupied for each half wave, or the distance Oa , would be $\frac{1}{60}$ of a second. The frequency is usually denoted by the letter n , although the symbol \sim is sometimes used. Frequencies employed in alternating-current work vary greatly and depend largely upon the use to which the current is to be put. For lighting work, frequencies from 60 to 125 or 130 are in common use. For power-transmission purposes the frequencies are usually lower, varying from 60 down to 25, or even less. Very low frequencies can not be used for lighting work because of the flickering of the lamps. Several of the large companies have adopted 60 as a standard frequency for both lighting and power apparatus. This is well suited for operating both lights and motors and enables both to be run from the same machine—a considerable advantage, especially in small stations. The high frequencies of 125–130 are going out of use except in stations which operate lights exclusively.

3843. An **alternation** is half a cycle. An alternation is, therefore, represented by one of the half waves, and there are two alternations for every cycle.

Instead of expressing the frequency of an alternator as so many *cycles per second*, some prefer to give it in terms of so many *alternations per minute*. For example, suppose we have an alternator supplying current at a frequency of 60, i. e., 60 complete cycles per second, or 3,600 per minute. Since there are two alternations for every cycle, the machine might be said to give 7,200 *alternations per minute*. The

method of expressing the frequency as so many cycles per second is, however, the one most commonly used.

3844. The time of duration of one cycle is called its **period**. This is usually denoted by t and expresses the number of seconds or fraction of a second which it takes for one cycle to elapse. If the frequency were 60, the period would be $\frac{1}{60}$ second, or, in general,

$$\text{frequency} = \frac{1}{\text{period}},$$

or
$$n = \frac{1}{t}. \quad (613.)$$

3845. Two alternating currents are said to be in **synchronism** when they have the same frequency. Two alternators would be said to be running in synchronism when each of them was delivering a current which passed through exactly the same number of cycles per second.

SINE CURVES.

3846. The variation of an alternating current as time elapses may always be represented by a wave-like curve such as those shown in the previous diagrams, such curves being easily obtained from the alternators generating the current by several well-known methods. The current at any instant may thus be obtained. In order, however, to study the effects of an alternating current, it is necessary to know the

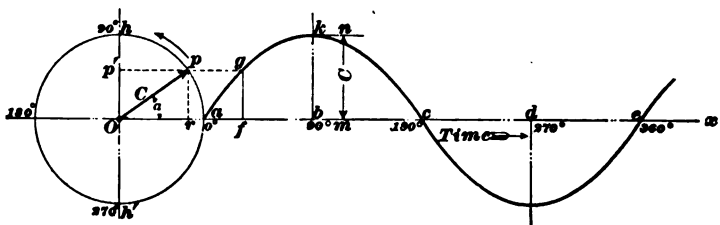

FIG. 1438.

law according to which this curve varies. In the case of the irregular curves shown in Figs. 1434, 1435, and 1436,

the law giving the relation between the time and the value of the current is so complicated that it renders calculations too involved. A great many alternators give E. M. F. and current curves which closely resemble that shown in Fig. 1437, and the law which this curve follows is quite simple. Such a curve may be constructed as follows: Suppose a point p , Fig. 1438, moves uniformly around a circle in the direction of the arrow, starting from 0° . The angle α (pronounced alpha) will uniformly increase from 0° to 180° and from there to 360° , or back to 0° , and so on. Take the instant when the point is in the position shown and project it on the vertical through O . The line $O p'$, which is the projection of $O p = p r$, will be proportional to the sine of the angle α , because $\sin \alpha = \frac{p r}{O p}$ and $O p$ remains constant. When $\alpha = 90^\circ$ the projection, or sine α , is proportional to $O h$; when at 180° or 360° it is zero, and when at 270° it is proportional to $O h'$. All the values of the projection of the line $O p$ from 0° to 180° are positive or above the horizontal, and those from 180° to 360° are negative or below the horizontal. As the point p revolves, p' moves from O to h , back through O to h' , and then back to O when the point p has reached 0° again. The way in which the sine (or length of the line $O p'$) varies as the point p revolves may be shown by laying out along the line $O x$ distances representing the time which it takes the point p to turn through various values of the angle α and erecting perpendiculars equal to the values of the sine corresponding to these angles. At the point a the value of the projection of $O p$ would be zero. At the instant shown in the figure the value of the sine is $p r = O p'$. Lay off the distance $a f$, representing the time required for the point to move from a to p , and erect a perpendicular $f g$ equal to $p r$. The distance $a b$ represents the time required for p to move through 90° , and the perpendicular $b k$ is equal to $O h = O p$. A number of points may be found in this way and the half wave $a k c$ drawn in. The negative half wave is exactly the same shape, but, of course, is drawn on the lower side of the horizontal. A curve constructed in this manner is known as a

sine curve, because its perpendicular at any point is proportional to the *sine* of the angle corresponding to that point. The sine of the angles 0° , 180° , 360° is zero; hence, at the points corresponding to these angles, the curve cuts the horizontal, i. e., the curve passes through its zero value. At 90° the curve passes through its positive maximum value, and at 270° it passes through its negative maximum. The maximum value of the curve $b k = O p$ is called its **amplitude**, and the curve varies between the limits $+ b k$ and $- b k$.

3847. If an alternating current or E. M. F. is represented by a sine curve constructed as above, the maximum value which the current or E. M. F. reaches during a cycle would be represented to scale by the vertical $b k$, and the value at any other instant during the cycle would be $b k \sin \alpha$, where α is the angle corresponding to the instant under consideration. The law which such a curve follows is therefore quite simple, and fortunately such a curve represents quite closely the E. M. F. and current waves generated by a large class of alternators. Even where the curves do not follow the sine law exactly, it is sufficiently accurate for all practical purposes to assume that they do. In all calculations connected with alternating currents, it is, therefore, usual to assume that the sine law holds good. The wave shown in Fig. 1438 may, therefore, be taken to represent the way in which an alternating current varies. During the time represented by the distance $a e$, one complete cycle occurs. The *maximum* value of the current is represented by the vertical, or ordinate, $C = b k$, and the current passes through a certain number of these cycles every second, depending upon the frequency n of the alternator.

3848. The student should always keep in mind the fact that in an alternating-current circuit there is a continual surging back and forth of current, rather than a steady flow, as in the case of a direct current, and it is this continual changing of the current which gives rise to most of the peculiarities which distinguish the action of **alternating currents** from **direct**.

PROPERTIES OF SINE CURVES.

3849. By examining Fig. 1438, it will be seen that every time the point p makes one complete revolution the sine curve passes through one complete cycle, and the time which it takes p to make one revolution corresponds to the period. The number of revolutions which the point p makes in one second would therefore be equal to the frequency n . It is well to note, in passing, that the sine curve is much steeper when it crosses the axis than when it is near its maximum values; in other words, the sine of the angle is changing more rapidly when near 0° and 180° than it is at 90° and 270° .

ADDITION OF SINE CURVES.

3850. If a line carrying a continuous current is split into two or more branches, the current flowing in the main line is found by taking the sum of the currents in the different branches. For example, suppose a pair of electric-light mains feeds three circuits, taking 5, 10, and 50 amperes; the current in the mains would be found by simply taking the sum of these, i. e., 65 amperes. This method, however, can not, as a general rule, be applied to alternating-current circuits, and it is necessary, therefore, to study carefully the methods of adding together two or more alternating currents or E. M. F.'s.

3851. The method of adding together two alternating E. M. F.'s represented by sine curves is shown in Fig. 1439. One E. M. F. is represented to scale by the radius Op ; that is, the radius Op is laid off to represent the maximum value E which the E. M. F. reaches during a cycle. The point p is supposed to revolve uniformly around the inner circle, and the corresponding sine curve is shown by the dotted wave. The other E. M. F. has its maximum value E' represented by the radius Oq , which revolves uniformly around the outer circle, generating the sine wave shown by the dot and dash line. Both points are supposed to revolve at exactly the same speed and to start from 0° at the

same instant; in other words, the *frequency* of both is the same, or they are in synchronism. Since both points start from 0° at the same instant and revolve at the same rate, it follows that both the E. M. F. curves will vary together. They will come to their maximum values at the same instant and will pass through zero simultaneously. When two or more alternating E. M. F.'s or currents vary together in this way, they are said to be **in phase** with each other. The two curves shown in Fig. 1439 not only represent two synchronous E. M. F.'s, but these E. M. F.'s are also in phase with each other. The curve representing the sum of these two E. M. F.'s is easily found by adding together the instantaneous values of the separate E. M. F.'s,

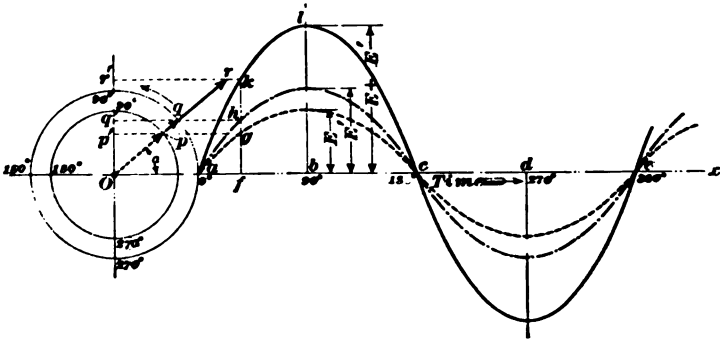

FIG. 1439.

- thus giving the sine curve shown by the full line. For example, take any instant represented by the point f on the line Ox ; the ordinate, or vertical, fg represents the instantaneous value of the E. M. F. E , and the ordinate fh represents the instantaneous value of E' . The value of their sum at this particular instant is therefore found by adding fg and fh , giving fk , and locating the point k on the required curve. The maximum ordinate of this resultant curve is $bl = E + E'$. This curve representing the sum of the two original E. M. F.'s is in phase with E and E' and is also a sine curve, hence it may also be represented by a line revolving about the point O , provided this line is so taken that its projection on the vertical is at all instants

equal to the sum of the projections of the two original lines $O p$ and $O q$. Since the points p and q are in line with each other, it follows that if we produce $O q$ to r , making $O r = O p + O q$, the projection of $O r = O r'$ will be equal to the sum of the projections of $O p$ and $O q$, i. e., $O r' = O p' + O q'$. It follows from the above that if the line $O r$ were to revolve uniformly around O at the same rate as $O p$ and $O q$, the curve representing the sum of the two E. M. F.'s would be generated.

3852. The following may be summarized from the above:

(1) *The curve representing the sum of two or more sine curves may be obtained by adding together the ordinates representing the instantaneous values of the original curves.*

(2) *If the two or more curves which are added are of the same frequency (as is usually the case), the resultant also will be a sine curve.*

(3) *Two or more alternating E. M. F.'s or currents of the same frequency are said to be in phase with each other when they reach their maximum and minimum values at the same instant.*

(4) *The resultant sine curve representing the sum of two or more sine curves of the same frequency may be generated by a line revolving uniformly, and of such length and so located with reference to the lines generating the original curves that its projection on the vertical shall at all instants be equal to the sum of the projections of the two original revolving lines.*

3853. In Fig. 1439 the line $O r = O p + O q$ generates the resultant curve, and since $O p$ and $O q$ are in phase with each other, it is seen that $O r$ is found by simply taking the sum of the two original lines $O p$ and $O q$. In other words, when two alternating E. M. F.'s or currents are in phase with each other, they may be added together in the same way as direct currents, but if they are not in phase, this can not be done. It is quite possible in alternating-current circuits to have the current and E. M. F. out of phase.

Suppose an alternator to be forcing current through a circuit. Every wave of E. M. F. will be accompanied by a corresponding wave of current, and hence the current and E. M. F. will always have the same frequency. There are a number of causes which may prevent the current and E. M. F. from coming to their maximum and minimum values at the same instant, and the current may lag behind the E. M. F. or may be ahead of it. In the case of two alternators feeding current into a common circuit, one current may lag behind the other, or the E. M. F. produced by one alternator may not be in phase with that of the other. The effects of this difference of phase must be taken into account in alternating-current work, as it gives rise to a number of peculiar effects not met with in connection with direct currents. Of course, in the case of direct currents there is no change taking place in the currents or E. M. F.'s; consequently, they are always in phase with each other.

3854. The effects of this difference in phase will be seen more clearly by referring to Fig. 1440. The two

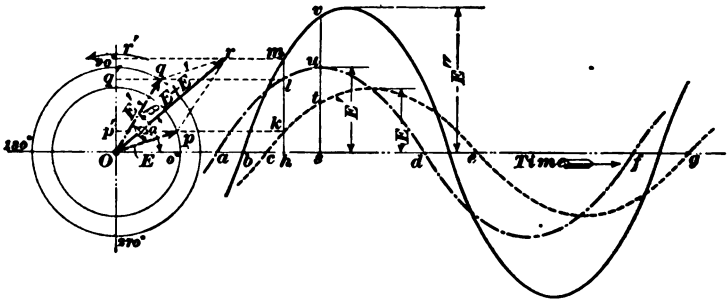

FIG. 1440.

E. M. F.'s E and E' are represented by the revolving lines Oq and Op as before. In this case, however, the E. M. F. E' starts from 0° before E , and the two are displaced by the angle Φ (phi); in other words, the point p does not start from 0° until the point q has turned through an angle Φ . After this the two revolve in synchronism, and the angle Φ remains constant, while the angle α is continually changing as before.

The E. M. F. E is therefore lagging behind E' , and the two E. M. F.'s are said to be **out of phase**. It might also be said that the E. M. F. E' was Φ degrees ahead or in advance of E , or that E lagged Φ degrees behind E' . If E lagged one complete cycle behind E' , the angle of lag would be 360° , and if it were said that E lagged 90° behind E' , it would mean that E came to its maximum or minimum value just $\frac{1}{4}$ period later than E' . The dot and dash curve, as before, represents E' , and the dotted curve represents E . The two curves, however, no longer cross the horizontal, or come to their maximum, at the same instant. The dotted curve starts in at the point c , a distance ac behind the curve representing E' . Since time is measured in the direction of the arrow, the point c represents an instant which is later than the point a . In other words, the curve representing E does not start until an interval of time, represented by ac , has elapsed after the starting of the dot and dash curve, i. e., the dotted curve is lagging behind the other. The distance ac is equivalent to the time which it would take p or q to turn through the angle Φ . The sum of the two curves is found as before by adding the ordinates; thus $hk + hl = hm$, and the resultant curve shown by the full line is obtained. It will be noticed that this is a sine curve, but it is in phase with neither of the original curves, also that its maximum value E'' is not as great as in the case shown in Fig. 1439. The resultant curve has, however, the same frequency as the others. The revolving line which will generate this curve must have its projections on the vertical equal to the sum of the projections of the other two. This condition is fulfilled by the line Or , which is the diagonal of the parallelogram formed on the two sides Op and Oq . That this is the case will be easily seen by referring to the figure. The projection of Op is Op' and of Oq , Oq' . The projection of the diagonal Or is Or' ; but $q'r' = Op'$; hence $Or' = Oq' + Op'$, and if the diagonal Or were to revolve at the same rate as Op and Oq , the full-line curve would be generated. The maximum value of this curve E'' is equal to Or , and the diagonal Or not only gives the maximum

value of the resultant curve, but also gives its phase relation in regard to the two original curves. In this case $O r$ lags behind $O q$ by the angle β (beta), and the distance $a b$ represents the interval of time which is required for the line $O r$ to swing through the angle β .

3855. The important points in the above may then be summarized as follows:

(1) *In alternating-current systems, two or more currents or E. M. F.'s may not come to their maximum and minimum values at the same instant, in which case they are said to be out of phase or to have a difference of phase.*

(2) *Phase difference is usually expressed by an angle (in most cases denoted by the Greek letter Φ). If this angle is measured forwards, in the direction of rotation, it is called an **angle of lead** or **angle of advance**; if measured backwards, it is called an **angle of lag**.*

(3) *Two sine curves not in phase may be added together by adding their ordinates. If the two original curves are of the same frequency, the resultant curve will be also a sine curve, but differing in phase from the other two.*

(4) *The maximum value of the resultant curve is given by the diagonal constructed on the lines representing the maximum values of the original curves. This diagonal not only gives the maximum value of the resultant curve, but also determines its phase relation.*

3856. From the above it will be seen at once that in adding alternating currents and E. M. F.'s, account must be taken not only of their magnitude, but also of their phase relation, and they can be added numerically only when they are in phase with each other, as in the case of direct currents.

3857. As an example of the addition of two alternating currents, suppose a divided circuit as shown in Fig. 1441. The main circuit 1 is divided into the branches 2 and 3, and ampere meters A_1 , A_2 , and A_3 are placed in the branches. If a continuous current were flowing, the reading of A_1 would be equal to the sum of the readings of A_2 and A_3 . This, however,

would not be the case if an alternating current were flowing, unless the currents in the two branches happened to be exactly in phase.

Generally speaking, they would not be in phase, and the reading of A_1 would be less than the sum of A_2 and A_3 . The relation between the three currents

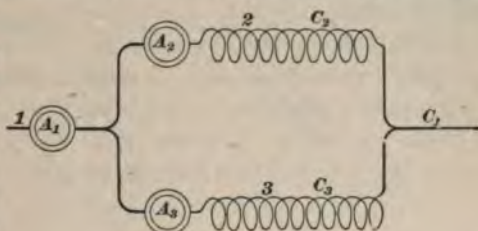

FIG. 1441.

would be as shown in Fig. 1442, where C_1 , the reading of A_1 , is the diagonal of the parallelogram formed by Oq and Op ,

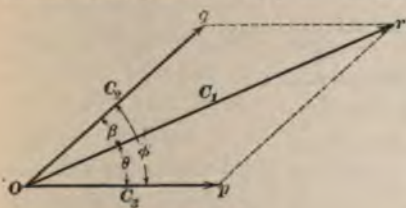

FIG. 1442.

representing the readings of A_2 and A_3 , respectively. These lines can all be laid off to scale, so many amperes per inch, and the angles of phase difference readily determined. In this

case Φ is the phase difference between the current in the branches 2 and 3, while the main current is β° behind C_2 and θ° (theta) ahead of C_3 . The resultant current represented by Or is smaller than it would be if Oq and Op were in

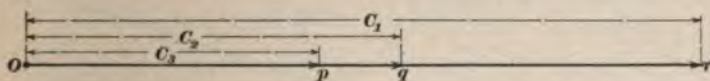
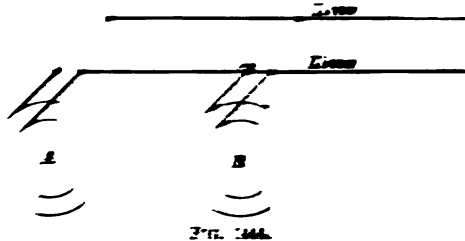

FIG. 1443.

phase. If Op and Oq were in phase, they could be added together directly, and the resultant would be Or , as shown in Fig. 1443. Here the angle of lag has become zero, and the parallelogram has been reduced to a straight line.

3858. A practical example of the addition of two alternating currents is the running of two alternators in parallel, Fig. 1444. In this case, the two alternators A and B furnish current to the line, and the actual current flowing in the line

would be found by taking the geometric sum of the two separate voltages, as explained in the preceding example.



3559. Alternating E. M. F.'s are added in the same way as currents. If two alternators *A* and *B*, Fig. 144B, were

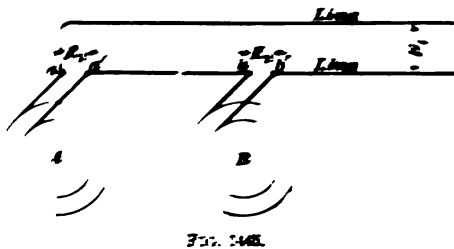

connected in series, one giving an E. M. F. E_1 and the other E_2 , writes, the E. M. F. E_3 obtained across the mains would not generally be equal to $E_1 + E_2$, but would be the resultant sum,

as shown by the parallelogram, Fig. 144C. If *A* and *B* were out of phase, E_3 would be equal to the sum of E_1 and E_2 . On account of this effect of the difference in phase between E_1 and E_2 , the sum of the readings of voltmeters connected across *a, a'* and *b, b'* would be greater than the reading obtained by a voltmeter connected across the mains.

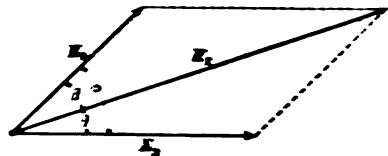

TWO AND THREE PHASE SYSTEMS.

3860. If the angle of lag between two currents is zero, they are said to be in phase.

If the angle of lag between two currents is 90° they are said to be at right angles or in quadrature.

If the angle of lag is 180° , they are said to be **in opposition**.

Fig. 1447 shows two current waves at right angles or in quadrature, the current C_2 , represented by the dotted line, lagging 90° , or $\frac{1}{4}$ cycle, behind C_1 . If these two currents were fed into a common circuit, the resultant current would be represented by the diagonal or , and this current would lag 45° behind C_1 .

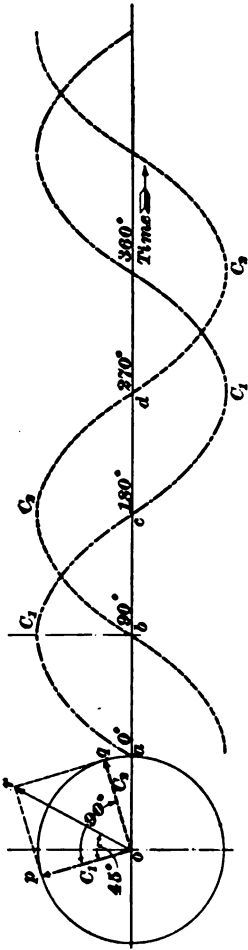

FIG. 1447.

3861. It will be seen by examining Fig. 1447 that at the instant C_1 is at its maximum value, C_2 is passing through zero. If each of these currents were fed into separate lines, a **two-phase**, or **quarter-phase system** would be obtained; i. e., there would be two distinct circuits, fed from one dynamo, the currents in the two circuits differing in phase by 90° , or $\frac{1}{4}$ period. Such systems are in common use for operating motors, and more will be said about them in connection with alternators. Alternators for use in connection with such systems are usually provided with two sets of windings on their armatures, so arranged that when one set is generating its maximum E. M. F., the other is passing through zero.

3862. Systems in which three currents are employed are also in common use in connection with power-transmission plants. These currents differ in phase by 120° , or $\frac{1}{3}$ period, and constitute what is known as a **three-phase system**. Such an arrangement

THEORY OF ALTERNATING

... that the sum of the instantaneous values of i_1 , i_2 , and i_3 is zero at all times. The corresponding

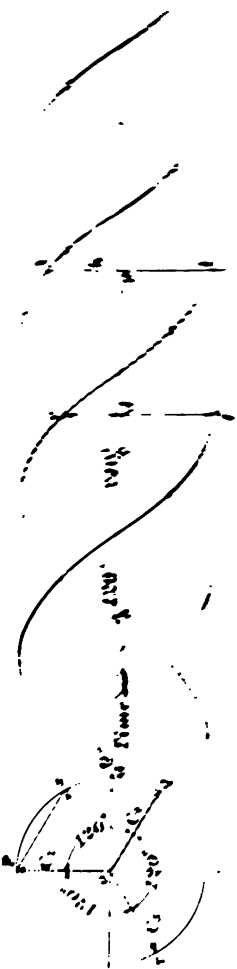

FIG. 111.

... are shown in dotted lines. The corresponding line i_1 lagsging i_2 through the full line i_2 , and the second line i_2 lagging i_3 through i_3 . In such a case where the three constants are equal, the resultant sum is at all instants equal to zero. This may be seen at once from the figure. The resultant sum of i_1 and i_2 is $-i_3$, and this is the equal and opposite of $i_3 = i_3$, so that the resultant sum of all three is zero. This may also be seen from the curves themselves, i_1 being the equal and opposite of $i_2 + i_3$, and i_2 is the equal and opposite of $i_1 + i_3$. It is well to bear this property of a balanced three-phase system in mind, as it is taken advantage of in connection with three-phase armatures and in three-phase power-transmission lines. The above would not be true if the system were unbalanced, i. e., if C_1 , C_2 , and C_3 were not all equal; but in most cases where these systems are used, it is tried as far as possible to keep the currents in the different lines equal. It should also be noted that in such a system when the current in one line is zero, the currents in the other two lines are equal and are flowing in opposite directions. When the cur-

rent in one circuit is at its maximum value, the currents in the other two are in the opposite direction and one-half as great.

COMPOSITION AND RESOLUTION OF CURRENTS
AND E. M. F.'s.

3863. It has been shown by the foregoing articles that a sine wave may always be expressed by a line revolving uniformly around a point and representing to scale the maximum value of the E. M. F. or current. The projection of this line on the vertical at any instant gives the instantaneous value of the E. M. F. or current. In working out problems in connection with alternating currents, it is not necessary to draw in the sine curves, but to use simply the line representing the curve. It has already been shown how currents and E. M. F.'s may be added by using these lines. In fact, alternating currents and E. M. F.'s are added and re-

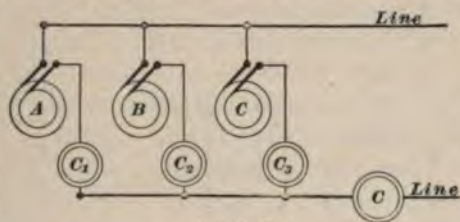

FIG. 1449.

solved into components in just the same way as forces are treated in mechanics, by means of the parallelogram of forces. What holds true with regard to two currents also applies to three or more, in this case the polygon of forces being employed. An example of this is shown in Fig. 1450. Three alternators *A*, *B*, and *C* are running in parallel, feeding current to the line. The three currents all differ in phase, and their amounts are given by the ammeters *C*₁, *C*₂, *C*₃.



FIG. 1450.

Required, the current flowing in the main circuit. This will be the resultant sum of *C*₁, *C*₂, and *C*₃. Lay off *Oa*, *Ob*, and *Oc*, Fig. 1450, to represent the three currents to scale and in their proper phase relation. From *a* draw *ae* equal and parallel to *Ob*, and from *e* draw *ed* equal and parallel to *Oc*. Join *Od*; then *Od* will represent the resultant current to the same scale that *Oa*, *Ob*, and *Oc* represent *C*₁, *C*₂, and *C*₃. In other words, *Od* would represent to scale the reading of the ammeter *C* placed in the main line. The angles giving the

phase differences between the different currents can usually be calculated when the constants of the different circuits are known. Methods for calculating the angles of phase difference will be given later. If the three currents represented by Oa , Ob , and Oc should all happen to be in phase with each other, their resultant sum would be obtained by simply adding them up numerically.

3864. Alternating E. M. F.'s and currents may be resolved into two or more components, in the same way that

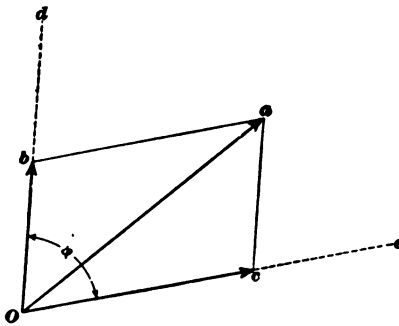

FIG. 1451.

forces are resolved in mechanics, by reversing the process of composition. For example, in Fig. 1451 we have the current represented by Oa resolved into two components Ob and Oc . The two currents represented by Ob and Oc , differing in phase by the angle ϕ , would therefore combine

to produce the current represented by Oa .

EXAMPLES FOR PRACTICE.

1. Two currents, one of 40 amperes and the other of 50, differing in phase by 30° , unite to form a third current. Required, the value of this current.

Ans. 87 amperes, nearly.

2. Construct a curve which will represent the E. M. F. of an alternator generating a maximum of 300 volts at a frequency of 60. Use 1 inch per 100 volts for the vertical scale and 1 inch equal to $\frac{1}{720}$ second for the horizontal.

3. Represent two E. M. F.'s of same frequency, one of 200 volts maximum and the other of 150 volts maximum, the latter lagging behind the former by an angle of 60° . Draw the two sine curves representing these E. M. F.'s in their proper relation to each other, and add these together to obtain the resultant curve. Find the maximum value of this resultant and compare its value with that obtained by taking the diagonal of the parallelogram constructed from the two component E. M. F.'s.

Ans. Resultant E. M. F. = 304 volts.

NOTE.—The student should bear in mind that in all the above cases the waves of current and E. M. F. are supposed to follow the sine law.

MAXIMUM, AVERAGE, AND EFFECTIVE VALUES OF SINE CURVES.

3865. During each cycle an alternating current passes through a large range of values from zero to its maximum. These instantaneous values are, as a rule, used very little in calculations. It is necessary to have it clearly understood what is meant when it is said that a current of so many amperes is flowing in a circuit or that an alternator is supplying a pressure of so many volts. When it is stated that an alternating current of, say, 10 amperes is flowing in a circuit, some average value must be implied, because, as a matter of fact, the current is continually alternating through a wide range of values. It has become the universal custom to express alternating currents in terms of the value of the continuous current which would produce the same effect in the circuit; as, for example, if the alternating current were 10 amperes, it would mean that this alternating current would produce the same effect as 10 amperes continuous current.

3866. Suppose the sine curve, Fig. 1452, represents the variation of an alternating E. M. F.; there are three values of this which are of particular importance:

(1) The **maximum value**, or the highest value which the E. M. F. reaches. This value is given by the ordinate E . This maximum value is not used to any great extent, but it shows the maximum to which the E. M. F. rises, and hence would indicate the maximum strain to which the insulation of the alternator would be subjected.

(2) The **average value**. *By the average value of a sine curve is meant the average of all the ordinates of the curve for one-half a cycle.* For example, in Fig. 1452 the average ordinate of the curve $a f b$ would be that ordinate $a d$ which multiplied by the base $a b$ would give a rectangle $a b e d$ of the same area as the surface $a f b$. The average value taken for a whole cycle would be zero, because the average ordinate for the negative wave would be the equal and opposite of the positive ordinate. In the case of a sine

curve, this average value always bears a definite relation to the maximum value. *If E is the maximum value, the average value is $\frac{2E}{\pi}$, or $.636 E$.* The average value is used in some calculations, but, like the maximum value, its use is not

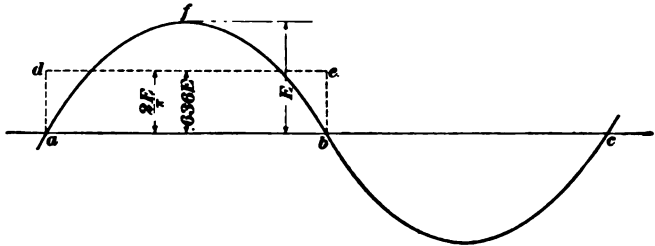

FIG. 1452.

very extended. The relation between the average and maximum value is, however, used considerably and should be kept in mind.

(3) The **effective value**. The effective value of an alternating current may be defined as *that value which would produce the same heating effect in a circuit as a continuous current of the same amount.* This effective value is the one universally used to express alternating currents and E. M. F.'s. It always bears a definite relation to the maximum value. When ammeters or voltmeters are connected in alternating circuits, they always read effective amperes or volts. This effective value is not the same as the average value (.636 max.), as might at first be supposed, but it is slightly greater, being equal to .707 times the maximum value. If a continuous current C be sent through a wire of resistance R the wire becomes heated, and the power expended in heating the wire is $P = C^2 R$ watts, or is proportional to the square of the current. If an alternating current be sent through the same wire, the heating effect is at each instant proportional to the square of the current at that instant. The average heating effect would therefore be proportional to the average of the squares of all the different instantaneous values of the current, and the effective value of the current

would therefore be the square root of the average of the squares of the instantaneous values. The effective value is for this reason sometimes called the square-root-of-mean-square value. It is also frequently called the *virtual value*. Suppose, for example, a circuit in which an alternating current of 10 amperes max. is flowing. This means that the current is continually alternating between the limits +10 amp. and -10 amp., and passing through all the intermediate values during each cycle. Now, as far as the heating or power effect of this current is concerned, it would be just the same as if a steady current of $.707 \times 10$ or 7.07 amperes were flowing, and if an ammeter were placed in the circuit it would indicate 7.07 amperes. Hereafter, in speaking of alternating E. M. F.'s and currents, effective values will be understood unless otherwise specified.

RELATIONS BETWEEN VALUES.

3867. The relation between the maximum, average, and effective values will be seen by referring to Fig. 1453, the average ordinate $.636 E$ being slightly shorter than the

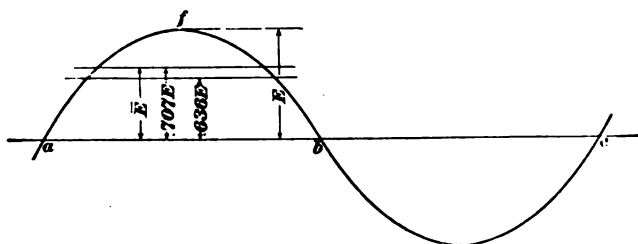

FIG. 1453.

effective $.707 E$. For convenience, the following relations are here given together. They should be kept well in mind, as they are used continually in problems connected with alternating-current work.

Average value = $.636$ maximum value.

Effective value = $.707$ maximum value, or $\frac{\text{maximum value}}{\sqrt{2}}$

Effective value = 1.11 average value.

3868. On account of the importance of the effective value, the following proof is given of the relation: Effective value = .707 max. Let Oa , Fig. 1454, represent the maximum value of the sine. The sine at any instant corresponding to the angle α is $ab = Oa \sin \alpha$,

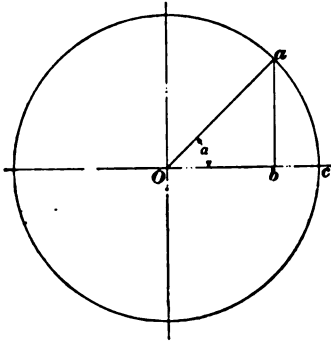

FIG. 1454.

$$\text{or } \sin \alpha = \frac{ab}{Oa}$$

$$\sin^2 \alpha = \frac{ab^2}{Oa^2}$$

$$\cos \alpha = \frac{Ob}{Oa}$$

$$\cos^2 \alpha = \frac{Ob^2}{Oa^2}$$

$$\sin^2 \alpha + \cos^2 \alpha = \frac{ab^2}{Oa^2} + \frac{Ob^2}{Oa^2} = \frac{ab^2 + Ob^2}{Oa^2} = \frac{Oa^2}{Oa^2} = 1.$$

Now as the line Oa revolves, thus generating the sine curve, the sine varies from 0 to Oa and the cosine varies from $Oc (= Oa)$ to 0, so that the sine and cosine pass through the same range of values, and consequently the average of the squares of the sine and the cosine must be the same. Since

$$\sin^2 \alpha + \cos^2 \alpha = 1,$$

$$\text{av. } \sin^2 \alpha + \text{av. } \cos^2 \alpha = 1,$$

and from the above $2 \text{ av. } \sin^2 \alpha = 1,$

$$\text{av. } \sin^2 \alpha = \frac{1}{2},$$

$$\sqrt{\text{av. } \sin^2 \alpha} = \frac{1}{\sqrt{2}}.$$

As the alternating E. M. F. is supposed to follow the sine law, the instantaneous value of the E. M. F. at any instant corresponding to the angle α is $e = E \sin \alpha$, where E is the maximum value; hence,

$$e^2 = E^2 \sin^2 \alpha,$$

$$\text{av. } e^2 = E^2 \text{ av. } \sin^2 \alpha,$$

$$\text{av. } e^2 = \frac{E^2}{2},$$

$$\sqrt{\text{av. } e^2} = \frac{E}{\sqrt{2}} = E \times .707;$$

i. e., the effective or square-root-of-mean-square value is equal to the maximum value multiplied by $\frac{1}{\sqrt{2}}$ or .707.

Hereafter, in designating E. M. F.'s and currents, the following notation will be used to avoid confusion:

- E = maximum E. M. F.;
- \bar{E} = effective or virtual E. M. F.;
- e = instantaneous E. M. F.;
- C = maximum current;
- \bar{C} = effective or virtual current;
- c = instantaneous current.

3869. In the diagram, Fig. 1455, the value of the square-root-of-mean-square ordinate is obtained graphically.

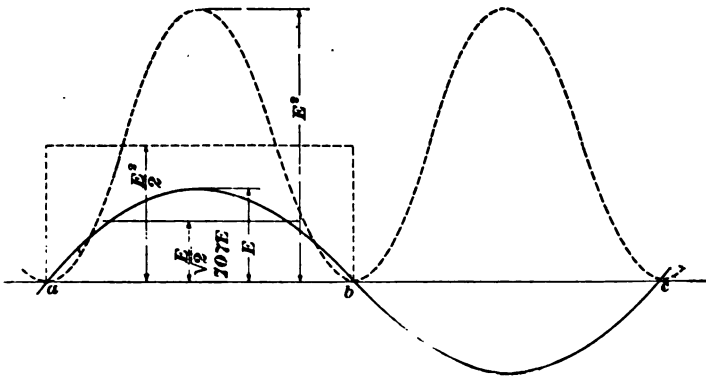

FIG. 1455.

The dotted curve is obtained by squaring the ordinates of the sine curve, and the area of the dotted rectangle is equal to the area enclosed by the curve of squares. The height of this ordinate is $\frac{E^2}{2}$, and it represents the average of all the

values of e^2 . The square root of this gives the effective value of the sine curve: $\frac{E}{\sqrt{2}} = .707 E$.

3870. In the preceding diagrams, showing the composition and resolution of E. M. F.'s and currents by means of the parallelogram, maximum values were used. Since, however, the effective or virtual values always bear a fixed

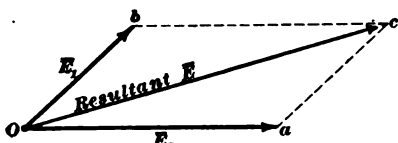

FIG. 1456.

proportion to the maximum, it follows that this construction will apply equally well in case effective values are used.

For example, if the two virtual E. M. F.'s \bar{E}_1 and \bar{E}_2 are represented by the lines Ob and Oa , Fig. 1456, the line Oc will represent the resultant virtual E. M. F. to the same scale that Oa and Ob represented the original quantities.

SELF-INDUCTION.

3871. It has already been mentioned in connection with the subject of phase difference that very often where an E. M. F. is causing an alternating current to flow in a circuit, the current may not rise and fall in unison with the E. M. F., but may lag behind it. This effect is due to what is known as *self-induction*, and it is a direct consequence of the continual variation which the current undergoes.

It has already been shown in the section on Principles of Electricity and Magnetism that whenever the number of magnetic lines of force threading through a circuit is caused to change in any way, an E. M. F. is set up in the circuit, and the average E. M. F. so generated depends upon the average number of lines of force changed per second, or, in other words, upon the *rate* at which the lines are made to change. As an example, take a circular coil of wire. Lines of force may be made to thread through this in several ways, one way, for instance, being to bring the

coil near the pole of a magnet, and then move it so as to cause the number of lines passing through the coil to vary. Consider the arrangement shown in Fig. 1457. Here the circular coil C , shown in section, is placed between the poles N , S of the electromagnet, so that the lines of force indicated by the arrows thread through its center. If the coil be moved up and down in the direction of the large arrows, an E. M. F. will be generated, which will be indicated by the voltmeter V . The E. M. F. so generated will be alternating, and the arrangement would constitute an elementary form of

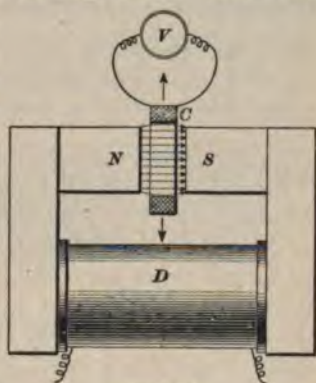

FIG. 1457.

alternator. The same effect would be produced if the coil were held still and the magnet moved. Both these methods are in common use in alternators, in one type the coils being mounted on the armature and revolved in front of the magnet, while in the other the coils are held stationary and the field is revolved.

3872. Lines of force may also be made to thread a coil by sending a current through the coil itself. Take a circular

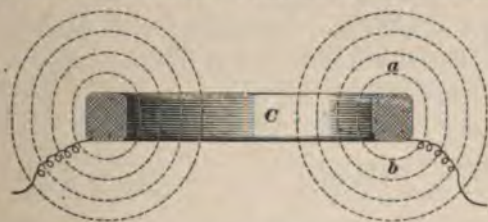

FIG. 1458.

coil as shown in Fig. 1458. If a current be sent through such a coil, lines of force will be set up as shown by the dotted lines. So long as the current remains steady, these lines will not change, and the current will flow through the coil just as if it were an ordinary resistance, i. e., the current

would follow Ohm's law; and if the voltage applied to the terminals were E volts and the resistance R ohms, the current would be determined by the relation $C = \frac{E}{R}$. If, however, the current is made to vary in any way, the number of lines of force threading the coil also varies, and hence an E. M. F. is set up in the coil. This E. M. F. of self-induction tends to oppose any change in the current. Whenever, then, an alternating current is sent through a circuit which can set up lines of force so as to thread through the circuit, a counter E. M. F. of self-induction is set up, and the current no longer flows according to Ohm's law, since the effect of the self-induction is to apparently increase the resistance of the circuit. Of course there are no self-induction effects present in direct-current circuits, because the current is steady and no induced E. M. F.'s can be set up. Circuits containing resistance can be made which have practically no self-induction, and these are known as *non-inductive resistances*. Such circuits would behave the same with regard to alternating currents as to direct, i. e., the current flowing in them would be according to Ohm's law. Water resistances and incandescent lamps are practically non-inductive.

CALCULATION OF INDUCED E. M. F.'s.

3873. Since the induced E. M. F. always depends upon the *rate at which lines of force are cut or changed*, it follows that if the coil be so situated that it can readily set up lines of force through itself, the induced E. M. F. will be large. Also, if there be a large number of turns in the coil, the E. M. F. will be large, because each of the turns will cut the lines of force threading the coil. The higher the frequency of the alternations, the more rapid will be the change in the lines, and hence the higher will be the E. M. F. It may then be stated that with a given current flowing through a coil, the induced E. M. F. will be proportional to the total number of lines threading the coil (N), the number of turns (T), and the frequency (n). The formula giving the relation between these quantities will be derived later.

3874. The total number of lines (N) which will thread a coil when a given current is sent through it depends upon the number of turns (T) in the coil and the material by which the coil is surrounded. In the case shown in Fig. 1458, where the coil is surrounded by air, the self-induction would be comparatively low, because air is a poor conductor of magnetic lines, and with a given current in the coil, a large number would not be set up through it. If, however, the coil were surrounded by iron, as shown in Fig. 1459, the self-induction would be enormously increased, because lines of force could be set up very readily. The number of lines which will be set up depends, then, not only on the current, but also on some other quantity, which takes account of the location of the coil and the facility with which lines of force may be set up around it. This quantity is known as the **coefficient of self-induction**.



FIG. 1459.

3875. The coefficient of self-induction for any coil is obtained from the following relation:

The product of the total number of lines N threading a coil when the current is one ampere and the number of turns in the coil, divided by 100,000,000, or 10^8 , gives the coefficient of self-induction. The coefficient of self-induction is usually denoted by the letter L . From the above, the relation given in formula **614** is obtained:

$$\frac{N \times T}{10^8} = L, \quad (614.)$$

where N is the number of lines corresponding to a current of one ampere, T the number of turns, and L the coefficient of self-induction. The practical unit of self-induction is called the **henry**. If a coil had a coefficient of self-induction of one henry, it would mean that if the coil had one turn, one ampere would set up 100,000,000, or 10^8 , lines through it, as seen from formula **614**. If it be assumed that

the number of lines set up increases directly with the current, formula **614** may be written as follows:

$$\frac{\text{magnetic flux} \times \text{turns}}{\text{current} \times 10^9} = \text{henrys}, \quad \text{(615.)}$$

or, magnetic flux \times turns = henrys \times current $\times 10^9$.

3876. The coefficient L for a given coil is a constant quantity so long as the magnetic permeability of the material surrounding the coil does not change. This is the case where the coil is surrounded by air. Where iron is present, the coefficient L is practically constant, provided the magnetism is not forced too high. In most cases arising in practice, the coefficient L may be considered to be a constant quantity, just as the resistance R is usually considered constant. The coefficient L of a coil or circuit is often spoken of as its **inductance**.

COMPONENTS OF IMPRESSED E. M. F.

3877. It has been shown that the effect of self-induction is to choke back the current. It also makes the circuit act as if it possessed inertia, as the current does not respond at once to the changes in the applied E. M. F., and thus lags behind. The resistance of the coil also tends to prevent the current from flowing, but it does not tend to displace the current and E. M. F. in their phase relations. In considering the flow of current through circuits containing resistance and self-induction, it is convenient to think of the resistance and self-induction as setting up counter E. M. F.'s, which are opposed to the E. M. F. supplied by the alternator. The E. M. F. supplied from the alternator or other source must then, in the case of alternating-current circuits, overcome not only the resistance, but also the self-induction. In the case of continuous-current circuits, the resistance only has to be taken into account. In every case, then, where an impressed E. M. F. encounters both resistance and self-induction in a circuit, it may be looked upon as split up into two components, one of which is necessary to overcome the resistance and the other the self-induction.

COMPONENT OVERCOMING RESISTANCE.

3878. It will readily be seen that *the component of the impressed E. M. F. which is necessary to overcome the resistance must always be in phase with the current.* The E. M. F. used in overcoming resistance is, from Ohm's law, $E = RC$. Hence, when the current is zero E is zero, and when C is

a maximum E is a maximum. The imaginary counter E. M. F. which the resistance offers is *directly opposed* to the current, consequently that component of the impressed E. M. F. necessary to overcome the resistance must be *in phase with the current.*

COMPONENT OVERCOMING SELF-INDUCTION.

3879. It is now necessary to determine the phase relation of that part or component of the impressed E. M. F. which is necessary to overcome the self-induction.

The component of the impressed E. M. F. necessary to overcome self-induction is at right angles to the current and 90° ahead of the current in phase. This may be shown by referring to Fig. 1460. Let the line oa and the corresponding wave shown by the full line represent the current flowing in the circuit. The magnetism produced by the current will increase and decrease in unison with it, and hence may be represented by the light-line wave in phase with the current. Now it has been shown that the induced E. M. F. is proportional to the rate at



FIG. 1460.

which the magnetism changes, and it will be seen from the figure that the magnetism is changing most rapidly at

the points a and c , where the magnetism curve cuts the axis, because there is a much greater change between two points such as e and c than there is between d and d' . It follows, then, that when the current and magnetism are passing through their zero values, the induced E. M. F. is at its maximum value; consequently it must be at right angles to the current.

3880. It is now necessary to determine whether this induced E. M. F. is 90° ahead of the current or behind it. When the current is rising in the circuit, the *induced E. M. F.* is always preventing its rise; hence, it may be represented by the dotted curve, Fig. 1460, 90° *behind* the current. By examining this curve, the student will see that the induced E. M. F. it represents opposes any change in the current. This induced E. M. F. may be represented by the line oc 90° behind oa . The component of the impressed E. M. F. *necessary to overcome the self-induction* will be the *equal and opposite* of this, and will be represented by the line ob 90° *ahead* of oa . The E. M. F. to overcome the self-induction is also shown by the dot and dash curve. The student must keep in mind the distinction between the E. M. F. of self-induction and the E. M. F. necessary to overcome self-induction; the former is 90° behind the current in phase, while the latter is 90° ahead of the current.

3881. In the above it has been assumed that the magnetism is exactly in phase with the current. This is not always the case where iron is present, as the hysteresis in the iron causes the magnetism to lag a little behind the current. It is true exactly for all circuits containing no iron, and sufficiently true, for all practical purposes, for iron circuits as well.

CIRCUITS CONTAINING RESISTANCE AND SELF-INDUCTION.

3882. From the above it will be seen that in circuits containing resistance and self-induction, the impressed E. M. F. may always be split up into two components, one necessary

to overcome the resistance (equal to RC and in phase with the current), and the other necessary to overcome the self-induction 90° in advance of the current. The effective value of the induced E. M. F. may be calculated as follows, when the inductance L is known: If the maximum magnetic flux is N , this total flux is cut four times by the coil during each cycle; i. e., the flux increases from zero to N , then decreases to zero, increases to N in the negative direction, and finally decreases to zero again. Now, by definition, the average volts induced in the coil must be equal to the average number of lines of force cut per second, divided by 10^8 (see section on Applied Electricity, Art. 3104). If the coil has T turns and the frequency is n cycles per second, the average number of lines of force cut by all the turns per second will be $4NTn$, and the average volts induced will be

$$E_{av.} = \frac{4NTn}{10^8}, \quad (616.)$$

or, since the effective volts is equal to 1.11 times the average volts,

$$\text{effective volts} = \bar{E} = \frac{4.44NTn}{10^8}. \quad (617.)$$

3883. The above formula, giving the relation between the induced effective volts \bar{E} , the frequency n , the number of turns T , and the flux N , is important, as it is used repeatedly in connection with alternator, induction motor, and transformer design. It may be expressed as follows: *Whenever a magnetic flux is made to vary through a circuit so as to induce a sine E. M. F., the effective value of the E. M. F. so induced is equal to 4.44 times the product of the maximum flux N , the number of turns T connected in series, and the frequency n , divided by 10^8 .*

3884. If the inductance of a circuit is L henrys, we have, from formula 615,

$$\frac{\text{max. magnetic flux} \times \text{number of turns}}{\text{max. current} \times 10^8} = L.$$

the induced current flowing in the circuit, the
 induced current must be $I = \frac{E}{Z}$ because $E = 2\pi n L C$.

$$I = \frac{E}{Z} = \frac{2\pi n L C}{Z} \quad (619)$$

$$I = \frac{E}{Z} = \frac{2\pi n L C}{Z} \quad (619)$$

the induced current must be $I = \frac{E}{Z}$ because $E = 2\pi n L C$.

$$I = \frac{E}{Z} = \frac{2\pi n L C}{Z} = \frac{2\pi n L C}{\sqrt{R^2 + X^2}} = \frac{2\pi n L C}{\sqrt{R^2 + 4\pi^2 n^2 L^2}}$$

the induced current must be $I = \frac{E}{Z}$ because $E = 2\pi n L C$.

$$I = \frac{E}{Z} = \frac{2\pi n L C}{Z}$$

the induced current must be $I = \frac{E}{Z}$ because $E = 2\pi n L C$.

$$I = \frac{E}{Z} = \frac{2\pi n L C}{Z}$$

$$I = \frac{E}{Z} = \frac{2\pi n L C}{Z} \quad (620)$$

the induced current must be $I = \frac{E}{Z}$ because $E = 2\pi n L C$.
 Whenever an alternating current is sent through a circuit
 containing an inductor, the induced E. M. F., in
 addition to the applied E. M. F., becomes the product of the fre-
 quency n and the effective current \bar{C} .

REACTANCE AND IMPEDANCE.

3885. It will be seen from the above that in order to
 obtain the volts necessary to overcome self-induction, the
 current is to be multiplied by the quantity $2\pi n L$. In
 order to obtain the E. M. F. necessary to overcome resist-
 ance, the current C is multiplied by the resistance R . It

follows, then, that the quantity $2\pi nL$ is of the same nature as a resistance and is used in the same way as a resistance. The quantity $2\pi nL$ is called the **reactance** of the circuit, and, like resistance, is measured in ohms.

The reactance of any inductive circuit is equal to 2π times the frequency times the inductance L expressed in henrys.

3886. Take the example shown in Fig. 1461. The alternator A is connected to a coil or circuit ab , as shown, the inductance of which is .5 henry. The resistance of the

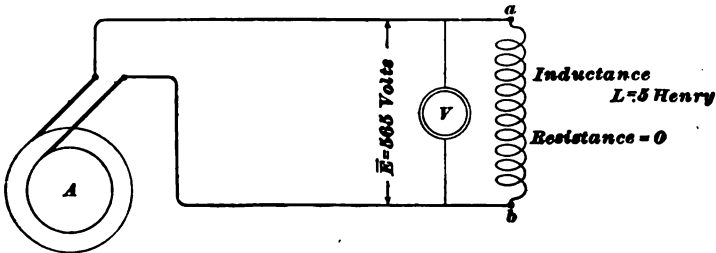

FIG. 1461.

circuit will be taken as negligible. The frequency of the E. M. F. furnished by the alternator is 60. Required the E. M. F. necessary to force a current of 3 amperes through the circuit. The induced counter E. M. F. set up will be

$$\bar{E} = 2\pi nL\bar{C} = 2\pi \times 60 \times .5 \times 3 = 565 \text{ volts.}$$

Hence, in order to set up the current of 3 amperes, the alternator must furnish an E. M. F. of 565 volts. This example shows one difference in the behavior of an alternating and a direct current. The E. M. F. required to set up a continuous current of 3 amperes through a circuit such as this, of very small resistance, would be exceedingly small, whereas it requires an alternating E. M. F. of 565 volts to set up the same current. In other words, if a continuous pressure of 565 volts were applied to the coil, the resulting current would be enormous. Instances of this effect are met with very commonly in connection with transformers. The primary coil of a transformer has a high self-inductance, so that when it is connected to the alternating-

current mains only a very small current flows. If the same transformer were connected to continuous-current mains, it would be at once burnt out, on account of the large current which would flow.

3887. In the above example, the circuit was supposed to have negligible resistance, so that the whole of the applied E. M. F., 565 volts, was used to overcome the self-induction. This being the case, it follows that the E. M. F. applied by the alternator must be 90° ahead of the current. The state of affairs existing in the circuit may, therefore, be represented as in Fig. 1462. Lay off to scale the value

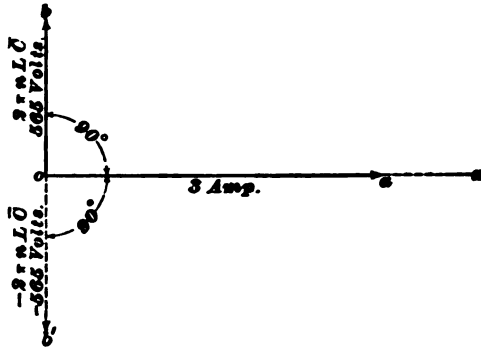

FIG. 1462.

of the current oa (so many amperes per inch) in the direction of the line ox . The induced E. M. F. $= 2\pi n L \bar{C} = 565$ volts must then be represented by the line ob' (so many volts per inch) 90° behind oa , and the equal and opposite of this, ob , 90° ahead of oa , will represent the E. M. F. which the alternator must supply to overcome the E. M. F. of self-induction. Of course, in actual practice it is impossible to obtain a circuit which has no resistance as assumed in the above example; but if the reactance $2\pi n L$ is very large as compared with the resistance, a condition quite frequently met with, the effect obtained in the circuit would be quite closely represented by Fig. 1462.

3888. In a large number of cases the circuits met with in practice will contain both resistance and self-induction,

and the simple case shown in Fig. 1462 will not apply. Take, for example, the case shown in Fig. 1463. The alternator A is supplying an E. M. F. \bar{E} , which is setting up a current \bar{C} through the circuit ab . This circuit possesses both resistance R (ohms) and inductance L (henrys).

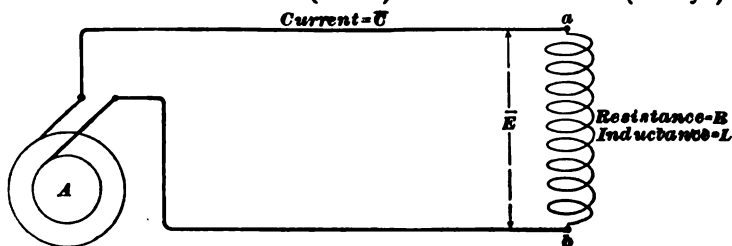

FIG. 1463.

In such a circuit it might be desired to find the impressed E. M. F. necessary to set up a given current; or, given the impressed E. M. F., to find the current. Suppose it is required to find the impressed E. M. F. \bar{E} necessary to set up a given current \bar{C} . The E. M. F. required must be the resultant sum of the E. M. F. required to overcome the resistance and that required to overcome the self-induction. The former must be equal to $R \bar{C}$, and must also be in phase with the current, while the latter is equal to the product of the current and reactance $2\pi n L \bar{C}$ and must be 90° ahead of the current. In Fig. 1464 oa is therefore laid off

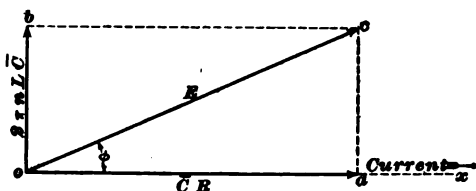

FIG. 1464.

to represent $\bar{C}R$ in the same direction as the current; and ob , 90° ahead of the current, is laid off equal to $2\pi n L \bar{C}$. The impressed E. M. F. \bar{E} must be the resultant of oa and ob , or the diagonal oc . The diagonal oc , therefore, represents the E. M. F. set up by the alternator to the same scale that oa and ob represent the other E. M. F.'s. The

diagram also shows that the current oa lags behind the impressed E. M. F. by the angle Φ , and it is also seen that if the circuit had no inductance, the line ca would become zero, and the E. M. F. would swing into phase with the current.

3889. Instead of using a complete parallelogram, as in Fig. 1464, triangles are commonly used to show the relations between the different E. M. F.'s. The right-angled triangle, Fig. 1465, shows the same relations as the parallelogram, Fig. 1464. $oa = \bar{C}R$ represents the E. M. F. to overcome resistance, ac that to overcome self-induction, and oc is the resultant. It should be remembered that the

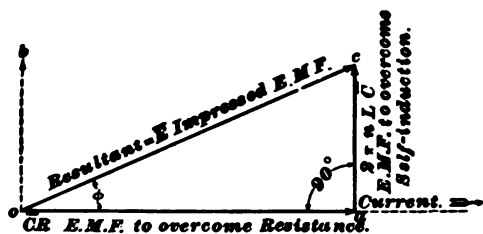

FIG. 1465.

line ac is transferred from ob , and consequently represents an E. M. F. 90° ahead of oa . Since the angle oac is a right angle, it follows that

$$\bar{E}^2 = \bar{C}^2 R^2 + 4 \pi^2 n^2 L^2 \bar{C}^2, \quad (621.)$$

$$\text{or} \quad \bar{E} = \sqrt{\bar{C}^2 R^2 + 4 \pi^2 n^2 L^2 \bar{C}^2} \quad (622.)$$

$$= \bar{C} \sqrt{R^2 + 4 \pi^2 n^2 L^2},$$

$$\text{or} \quad \bar{E} = \bar{C} \sqrt{R^2 + (2 \pi n L)^2}. \quad (623.)$$

That is, the impressed E. M. F. \bar{E} necessary to maintain a current \bar{C} in a circuit of resistance R and inductance L is equal to the product of the current \bar{C} into the square root of the sum of the squares of the resistance R and the reactance $2 \pi n L$.

The quantity $\sqrt{R^2 + (2 \pi n L)^2}$ is called the **impedance** of the circuit. The impedance of a circuit is equal to the square root of the sum of the squares of the resistance and reactance.

3890. The relation between resistance, reactance, and impedance is shown by the right-angled triangle, Fig. 1466. The following definitions may also be given of impedance, reactance, and resistance:

Impedance is that quantity which multiplied by the current gives the impressed E. M. F.

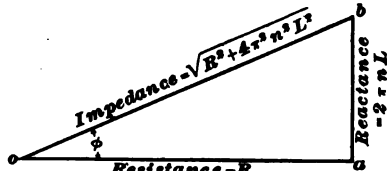

FIG. 1466.

Reactance is that quantity which multiplied by the current gives that component of the impressed E. M. F. which is at right angles to the current.

Resistance is that quantity which multiplied by the current gives that component of the impressed E. M. F. which is in phase with the current.

Impedances, like resistances and reactances, are expressed in ohms.

3891. In dealing with continuous-current systems, the relation between the current, resistance, and E. M. F. is fully given by Ohm's law, i. e., $\text{current} = \frac{\text{E. M. F.}}{\text{resistance}}$. Ohm's law can not, however, be applied in this form to alternating-current circuits, but from formula **623** becomes

$$\bar{C} = \frac{\bar{E}}{\sqrt{R^2 + 4\pi^2 n^2 L^2}}, \quad (624.)$$

or $\text{current} = \frac{\text{E. M. F.}}{\text{impedance}},$

and the current no longer depends simply upon the E. M. F. and resistance, but depends also on the inductance L and the frequency n . If n becomes zero, i. e., if the alternations become slower and slower until the current finally becomes continuous, the term $4\pi^2 n^2 L^2$ drops out and formula **624** reduces to $C = \frac{E}{\sqrt{R^2}}$, or $C = \frac{E}{R}$. Also, if the circuit is non-inductive, i. e., if $L = 0$, the formula reduces

to Ohm's law, and the current may be obtained by simply dividing the E. M. F. by the resistance, as is the case with continuous currents.

ANGLE OF LAG.

3892. From the triangle, Fig. 1466, it will be seen that the current which is in the direction of oa lags behind the impressed E. M. F. in the direction of ob by the angle Φ . The tangent of this angle Φ is equal to $\frac{2\pi nL}{R}$; hence, if the resistance and reactance are both known, the angle of lag may be calculated. From the relation $\tan \Phi = \frac{2\pi nL}{R}$, it is seen that the larger $2\pi nL$ is, compared with R , the larger will be the angle of lag, and if the reactance $2\pi nL$ is small in comparison with R , the angle Φ will be small, or the current will be nearly in phase with the impressed E. M. F.; hence:

In a circuit containing resistance and self-induction, the current lags behind the impressed E. M. F., the amount of the lag depending upon the relative magnitude of the resistance and reactance.

EXAMPLE.—An alternator is connected to a circuit having a resistance of 20 ohms and an inductance of .10 henry. The frequency is 60 cycles per second. What must be the E. M. F. furnished by the alternator in order to set up a current of 10 amperes in the circuit?

SOLUTION.—The required E. M. F. must be the resultant of the E. M. F. necessary to overcome resistance, i. e., $R\bar{C} = 20 \times 10 = 200$ volts, and that necessary

to overcome the self-induction. The latter is equal to the reactance multiplied by the current, or $2\pi nL\bar{C} = 2 \times 3.14 \times 60 \times .1 \times 10 = 376.8$ volts. The impressed E. M. F. \bar{E} is the resultant, or

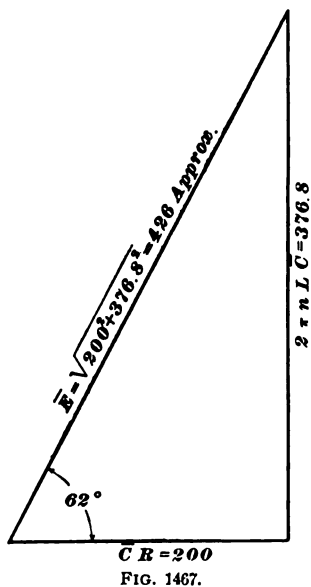

$\bar{E} = \sqrt{200^2 + 376.8^2} = 426.5$, nearly. These E. M. F.'s are related as shown in Fig. 1467, and the resultant \bar{E} may either be found by calculation as above or it may be scaled from the figure. The required E. M. F. which must be supplied by the alternator is, therefore, 426.5 volts.

The current in the circuit will lag behind the E. M. F. by an angle ϕ , the tangent of which is $\frac{2\pi nL}{R} = 1.88$. By looking up the angle in a table of tangents, it is found to be a little over 62° . This means, then, that in this particular circuit the current does not come to its maximum value till a little over $\frac{1}{4}$ of a period behind the E. M. F. Since the current passes through 60 cycles per second, it follows that the current in this case rises to its maximum value about $\frac{1}{180}$ of a second after the E. M. F.

The impedance of the circuit is $\sqrt{20^2 + 37.68^2} = 42.65$ ohms, and this multiplied by the current gives 426.5 volts, the impressed E. M. F.

Ans.

3893. The above problem might also come up in another form: The impressed E. M. F. being given, to determine the current. From formula **624**,

$$\bar{C} = \frac{\bar{E}}{\sqrt{R^2 + 4\pi^2 n^2 L^2}}; \quad (625.)$$

so that, if \bar{E} is given \bar{C} can be easily determined, R and L being known quantities.

If there were no inductance in the circuit, the E. M. F. required would be in accordance with Ohm's law, or $20 \times 10 = 200$ volts, which is less than half the voltage required when the inductance is present.

If there were no resistance present, the tangent of the angle of lag would be $\frac{2\pi nL}{0} = \infty$, or the angle of lag would be 90° , all the impressed E. M. F. being used in overcoming the inductance.

EFFECTS OF CAPACITY.

3894. There is another property of electric circuits which has to be considered in connection with the flow of alternating currents and which, like self-induction, does not

enter into the consideration of the flow of continuous currents. The property which most circuits possess to a greater or less degree of holding a certain charge or quantity of electricity is known as *electrostatic capacity*, and this, in some cases, has a marked influence upon the behavior of an alternating current flowing in the circuit. The capacity of most circuits met with in practice is quite small in comparison with their resistance and inductance, consequently its effect is not usually so noticeable; however, in some cases, especially in underground cable work, these effects become important, and it is necessary to study briefly the behavior of an alternating current when capacity is present in the circuit.

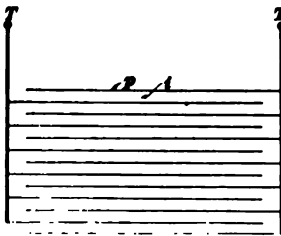

FIG. 1468.

3895. If capacity is needed for any particular purpose, it is usually made up by taking a large number of sheets of tin-foil and separating them by alternate sheets of waxed paper, mica, or other insulating material. The whole mass is pressed tightly together, one set of sheets constituting one terminal, and the alternate set the other, as shown in Fig. 1468, where

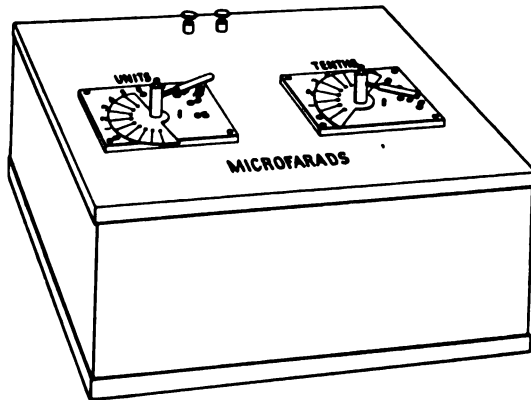

FIG. 1469.

p represents the tin-foil sheets, i the insulating material

between, and T the terminal posts. Such an arrangement is called a **condenser**. It should be noticed, in passing, that there is no electrical connection between the two sets of plates. Condensers, like resistances, are usually placed in a box and divided up into sections, which may be cut in or out at will.

Fig. 1469 shows a condenser provided with switches s , for cutting different sections in or out, and so varying the capacity. Condensers have been used to some extent commercially in connection with alternating-current motors, and their use on telegraph circuits is quite usual.

3896. Capacities may be connected in parallel as shown in Fig. 1470, or in series as in Fig. 1471.

If two capacities are connected in parallel, the capacity of the two combined is equal to the sum of the separate capacities.

If J_1 and J_2 , Fig. 1470, are the separate capacities, the combined capacity J is equal to $J_1 + J_2$. The same holds true for any number of capacities connected in parallel.

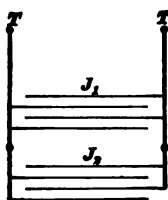

FIG. 1470.

If two capacities are connected in series, the reciprocal of the combined capacity is equal to the sum of the reciprocals of the separate capacities.

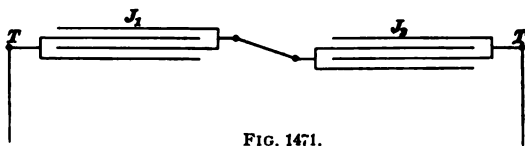

FIG. 1471.

If J_1 and J_2 , Fig. 1471, are the separate capacities, the combined capacity is obtained from the expression

$$\frac{1}{J} = \frac{1}{J_1} + \frac{1}{J_2},$$

or
$$J = \frac{J_1 J_2}{J_1 + J_2}. \quad (626.)$$

This may also be applied to any number of capacities connected in series. By comparing the above with the laws

governing resistance of conductors, in the section on Principles of Electricity and Magnetism, the student will see that when combined in series and parallel sets, capacities act just the opposite to resistances.

3897. Long transmission lines have an appreciable capacity, the two wires constituting the plates of the condenser, and the capacity of underground cables is often quite large. In the latter case the copper conductor constitutes one plate of the condenser and the outer sheath of the cable the other

CONDENSER CHARGES.

3898. If a battery be connected to the terminals of a condenser, as shown in Fig. 1472, a current will flow into it and the plates will become charged. The flow of current will be a maximum the instant the E. M. F. is applied, but will rapidly fall off, so that, in a small fraction of a second, the current will practically have ceased flowing and the condenser will be charged. This will be the state of affairs so long as the condenser remains connected to the battery; i. e., except for the instant when the battery is first connected, no

current will flow, and the circuit will act simply as if it were broken. The condenser acts as if it had acquired a counter E. M. F., tending to keep the current out, and this counter E. M. F. becomes greater until, when the condenser is charged, it is equal and opposite to that of the battery. If the battery be disconnected and the terminals of the condenser connected together, the charge will flow out and will result in a current of short duration. This current will be a maximum when the terminals are first connected, but it soon falls to zero.

3899. The unit of capacity is called the **farad**.

It is a condenser of such dimensions that a current of one ampere flowing into it for one second causes the pressure

across its terminals to rise one volt, its capacity is said to be one farad.

The flow of current into a condenser will always continue until the counter E. M. F. of the condenser is equal and opposite to the E. M. F. of the battery or generator to which the condenser is attached. A condenser sufficiently large to hold the quantity of electricity represented by one coulomb (one ampere for one second), with a rise of potential of one volt, would have to be of enormous dimensions. The farad is, therefore, too large a unit for convenient use, and instead of it the practical unit, the **microfarad**, has been adopted.

One microfarad is equal to one one-millionth of a farad.

It must be remembered that the microfarad is used only for convenience, and that in working out problems, capacities must always be expressed in farads before substituting in formulas, because the farad is chosen with respect to the volt and ampere, and hence must be used in formulas along with these units. For example, a capacity of 10 microfarads as given in a problem would be substituted in formulas as .000010 farad.

3900. In connection with condensers and capacities, it is often necessary to make use of the unit denoting quantity of charge. The unit of quantity is the *coulomb*, which has already been defined in the section on Principles of Electricity and Magnetism. It will be convenient to repeat here some of the definitions given, in order to assist in a thorough comprehension of that which follows. The coulomb, then, represents that quantity of current which passes through a circuit when the average rate of flow is one ampere for one second. If Q = quantity of electricity, or charge, in coulombs which a condenser takes up in t seconds, the average current during the time t must have been

$$C = \frac{Q}{t}. \quad (627.)$$

3901. If a condenser J , Fig. 1473, be connected to an alternator, a current will flow into and out of it, because the

E. M. F. at its terminals is constantly changing. If an ammeter M is connected in the circuit, it will give a reading just as if the alternator were sending a current through an ordinary circuit, whereas there is really no electrical connection between the terminals of the condenser J , and if

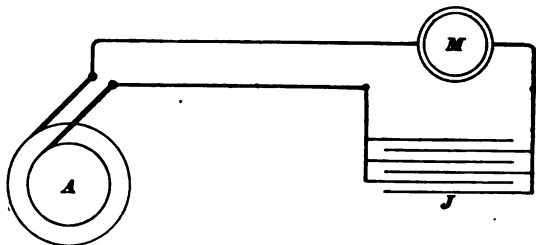

FIG. 1473.

it were connected to a continuous-current dynamo, the ammeter M would give no reading whatever. What really occurs is a surging of current into and out of the condenser.

CONDENSER E. M. F.

3902. Let the full-line curve, Fig. 1474, represent the current which flows into and out of a condenser when a sine E. M. F. is impressed on its terminals. This current

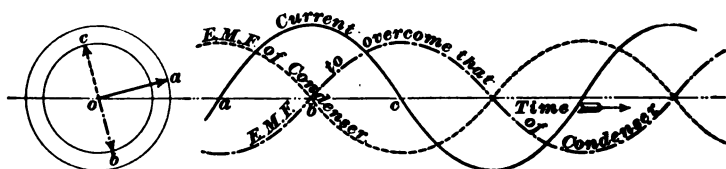

FIG. 1474.

will, of course, have a frequency equal to that of the alternator to which the condenser is attached. It will require a certain impressed E. M. F. to cause this current to flow, just as it required an E. M. F. to overcome the inductance of a circuit. The problem now is to determine the value of this E. M. F. and its phase relation with regard to the current.

The E. M. F. required to set up this current will be the equal and opposite of the E. M. F. of the condenser, just as

the E. M. F. to overcome self-induction was the equal and opposite of the E. M. F. of self-induction.

3903. It has already been shown that when the flow of current into the condenser is a maximum the counter E. M. F. of the condenser is zero, and when the flow finally becomes zero the counter E. M. F. is a maximum. It follows, therefore, that the wave representing the E. M. F. of the condenser is at right angles to the current. The fact as to whether it is 90° ahead of or behind the current may be decided as follows: When the current is flowing into the condenser, the counter E. M. F. is continually increasing in such a direction as to keep it out. The curve representing the E. M. F. of the condenser must cross the axis at the point *b*, Fig. 1474, because, as shown above, this curve is at right angles to the current curve. During the interval of time from *b* to *c*, the current is decreasing, so that during this interval the counter E. M. F. of the condenser must be increasing in the opposite direction, and is therefore represented by the dotted curve, which is 90° ahead of the current. The impressed E. M. F. necessary to overcome that of the condenser must be the equal and opposite of this, or 90° behind the current. This latter E. M. F. is shown by the dot and dash curve. The lines in the diagram at the left show these phase relations, the line *oa* representing the current, *oc* the E. M. F. of the condenser, and *ob* the impressed E. M. F. to overcome that of the condenser.

Hence, in a circuit containing capacity only, the current is 90° ahead of the impressed E. M. F., or the E. M. F. necessary to set up a current in such a circuit is 90° behind the current in phase.

In Fig. 1475 the current is represented by the line *Oa* and the impressed E. M. F. necessary to maintain the current by *Ob*, 90° behind *Oa*. The counter E. M. F. of the

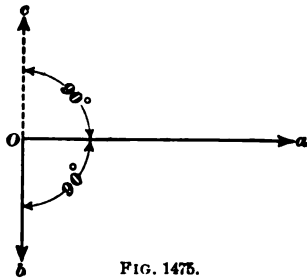

FIG. 1475.

condenser itself would be represented by $O c$; equal and opposite to $O b$, and hence 90° ahead of the current.

3904. The student will note from the above that the effect of capacity in a circuit is exactly the opposite of self-induction. Capacity tends to make the current lead the E. M. F., while self-induction causes it to lag. When both self-induction and capacity are present in a circuit, one tends to neutralize the other.

3905. The E. M. F. in volts (effective) necessary to overcome the capacity or condenser E. M. F. in a circuit may be calculated as follows :

If the capacity of the condenser be J farads and a *maximum* E. M. F. E be applied to its terminals, it will take up a *maximum* charge $Q = J E$ coulombs. The E. M. F. passes through n cycles per second, i. e., the condenser is charged up to a maximum in one direction, then discharged, and the process repeated in the opposite direction, n times per second. The average rate of charge and discharge is, therefore, $4 n$, i. e., $4 n$ times per second.

The maximum rate = average rate $\times \frac{\pi}{2}$; hence, the maximum rate of charge and discharge is $\frac{4 n \times \pi}{2} = 2 \pi n$. The maximum charge is $J E$, and if the maximum rate of charge is $2 \pi n$, the maximum current must be

$$C = J E 2 \pi n. \quad (628.)$$

Hence,
$$E = \frac{C}{2 \pi n J}. \quad (629.)$$

This formula gives the relation between the maximum E. M. F. and maximum current. The effective E. M. F. is equal to the maximum divided by $\sqrt{2}$. Dividing each side of the equation by $\sqrt{2}$, we have

$$\frac{E}{\sqrt{2}} = \frac{C}{2 \pi n J \sqrt{2}}; \text{ or, } \bar{E} = \bar{C} \frac{1}{2 \pi n J}; \quad (630.)$$

so it is seen that this equation also gives the relation between the effective E. M. F. and current.

CAPACITY REACTANCE.

3906. The quantity $\frac{1}{2\pi nJ}$ is called the **capacity reactance**, as it is analogous to the reactance $2\pi nL$ in circuits where self-induction is present. It has also been called the *condensance* by some writers.

EXAMPLE.—Required the E. M. F. necessary to set up an alternating current of 2 amperes through a condenser having a capacity of 5 microfarads, the frequency being 60 cycles per second.

SOLUTION.—By formula 630 we have

$$\bar{E} = \bar{C} \frac{1}{2\pi nJ};$$

$\bar{C} = 2$ amperes; $J = 5$ microfarads = .000005 farad; $n = 60$;

$$\bar{E} = \frac{2}{2 \times 3.14 \times 60 \times .000005} = 1,061 \text{ volts. Ans.}$$

EXAMPLE.—*BB*, Fig. 1476, represents a high-tension power-transmission line connected to an alternator *A*. The pressure maintained

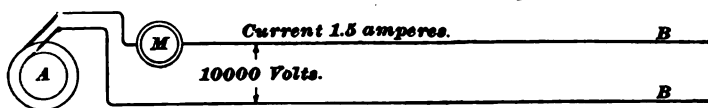

FIG. 1476.

between the lines is 10,000 volts, and the frequency is 60 cycles per second. There is no connection between the wires, and they are supposed to be so insulated that practically no leakage takes place between them. On running the alternator, it is found that the ammeter *M* gives a reading of 1.5 amperes. What must be the electrostatic capacity of the line?

SOLUTION.—From formula 630 we have, by derivation,

$$\bar{C} = 2\pi nJ\bar{E},$$

$$J = \frac{\bar{C}}{2\pi n\bar{E}} = \frac{1.5}{2 \times 3.14 \times 60 \times 10,000} \text{ farads,}$$

$$= \frac{1.5 \times 1,000,000}{2 \times 3.14 \times 60 \times 10,000} = .398 \text{ microfarad. Ans.}$$

CIRCUITS CONTAINING RESISTANCE AND CAPACITY.

3907. In case a circuit contains both resistance and capacity, the current will lead the E. M. F. The amount of lead will depend upon the relative values of the resistance and capacity reactance. If the resistance is very large compared

with the capacity reactance, the angle of lead will be small, because that component of the E. M. F. at right angles to the current will be small. On the other hand, if the capacity reactance is very large as compared with the resistance, the current may lead the E. M. F. by nearly 90° .

3908. The resultant E. M. F. may in such circuits be looked upon as being composed of two components, one at right angles to the current, used in overcoming the capacity reactance and equal to $\frac{\bar{C}}{2\pi nJ}$, and the other, necessary to overcome the resistance, equal to $\bar{C}R$ and in phase with the

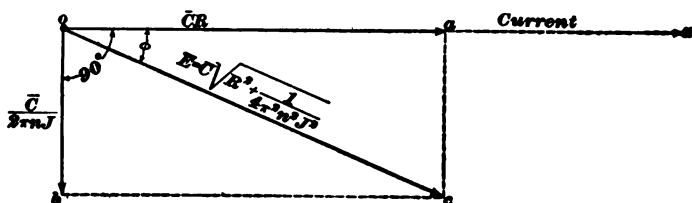

FIG. 1477.

current. These E. M. F.'s may be represented by the diagram, Fig. 1477. ox represents the current line and $oa = \bar{C}R$ the E. M. F. to overcome resistance. The E. M. F. to overcome the capacity reactance is represented by ob 90° behind oa , and the resultant impressed E. M. F. \bar{E} by the diagonal oc . The current leads the E. M. F. by the angle

Φ , the tangent of which is equal to $\frac{ac}{oa} = \frac{\frac{\bar{C}}{2\pi nJ}}{\bar{C}R} = \frac{1}{2\pi nJR}$.

$$\tan \Phi = \frac{1}{2\pi nJR} \quad (631.)$$

In this connection it is well that the student compare Fig. 1477 with Fig. 1464, as these two figures show the difference in the action of capacity and self-induction.

3909. From formula 631 it will be noticed that if R becomes zero, $\tan \Phi = \text{infinity}$, or the angle of lead is 90° . If the capacity J becomes infinitely large, $\tan \Phi = 0$ and the

current is in phase with the E. M. F. This latter is the condition of affairs in an ordinary closed circuit, because in such a case the current keeps on flowing so long as the E. M. F. is applied, and the circuit never becomes charged. In other words, an ordinary closed circuit in which there is no condenser at all acts as if it had an infinitely large capacity, while an open circuit acts as a condenser of infinitely small capacity.

3910. From the triangle *oac*, Fig. 1477, we have the relation

$$\bar{E}^2 = \bar{C}^2 R^2 + \frac{\bar{C}^2}{4 \pi^2 n^2 J^2},$$

$$\bar{E} = \sqrt{\bar{C}^2 R^2 + \frac{\bar{C}^2}{4 \pi^2 n^2 J^2}}, \quad (632.)$$

$$\bar{E} = \bar{C} \sqrt{R^2 + \left(\frac{1}{2 \pi n J}\right)^2}. \quad (633.)$$

Therefore, in circuits containing resistance and capacity, the impedance of the circuit is equal to the square root of the sum of the squares of the resistance *R* and the capacity reactance $\frac{1}{2 \pi n J}$.

The impressed E. M. F. \bar{E} necessary to maintain a current \bar{C} in a circuit containing resistance and capacity is equal to the current multiplied by the impedance. The law governing the flow of current in such a circuit then becomes

$$\bar{C} = \frac{\bar{E}}{\sqrt{R^2 + \frac{1}{4 \pi^2 n^2 J^2}}}. \quad (634.)$$

If the circuit contains a resistance *R* and no condenser, *J* becomes infinite in value, and formula 634 reduces to $\bar{C} = \frac{\bar{E}}{R}$. That is, the current follows Ohm's law.

If the circuit be broken, it means that the resistance becomes infinitely large, and the capacity *J* being very small, the impedance becomes infinitely large, consequently the current becomes zero.

EXAMPLE.—A non-inductive resistance R (Fig. 1478) of 200 ohms is connected in series with a condenser across the terminals of an alternator as shown, the frequency being 60. The condenser has a

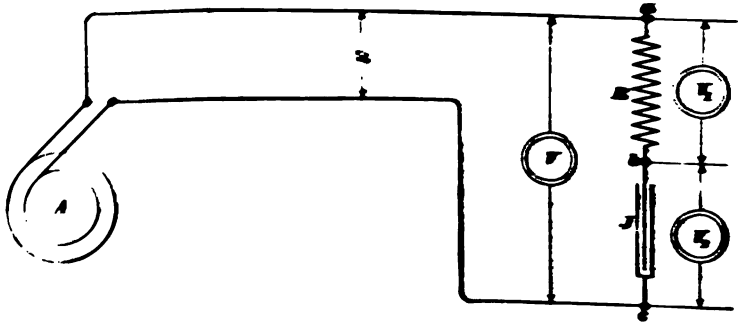

FIG. 1478.

capacity of 15 microfarads, and the current flowing in the circuit is 5 amperes. Required :

1. The reading which would be given by the voltmeter V_1 connected to the terminals of the resistance.
2. The reading of the voltmeter V_2 connected to the terminals of the condenser.
3. The angle by which the current will lead the E. M. F.
4. The E. M. F. which must be furnished by the alternator—i. e., the reading of the voltmeter V connected across the mains.

SOLUTION.—We know that the three required E. M. F.'s must be related to each other as shown in Fig. 1477.

1. The reading given by the voltmeter V_1 must evidently be the E. M. F. necessary to overcome the resistance R , and hence is equal to $E_1 R = 5 \times 200 = 1,000$ volts. Ans.

2. The reading of V_2 represents the E. M. F. necessary to overcome the capacity reactance, and hence is equal to

$$E_2 = \frac{1}{2\pi n C} = \frac{5}{2 \times 3.14 \times 60 \times .000015} = 884 \text{ volts. Ans.}$$

3. The angle by which the current leads the E. M. F. is given by formula 6311: $\tan \phi = \frac{1}{2\pi n C R} = .884$. From a table of tangents ϕ is found to be $41^\circ 20'$, nearly, i. e., the current is ahead of the E. M. F. by a little more than one-ninth of a complete cycle. Ans.

4. The resultant E. M. F. E , or the voltage which must be furnished by the alternator to set up the current of 5 amperes, is obtained from

$$\text{formula 6312: } E = 5 \sqrt{E_1^2 R^2 + \frac{E_2^2}{4\pi^2 n^2 C^2}} = 5 \sqrt{1,000^2 + 884^2} = 1,335 \text{ volts.}$$

This is the pressure which would be given by the voltmeter V , and it is the resultant sum of the E. M. F. to overcome resistance (1,000 volts) and that to overcome reactance (884 volts).

3911. In an alternating-current circuit as considered in the above example, it is thus seen that it is quite possible for the reading of the voltmeter V to be considerably less than the sum of V_1 and V_2 .

The relation between the quantities in this problem is shown by the E. M. F. triangle, Fig. 1479, the sides of the

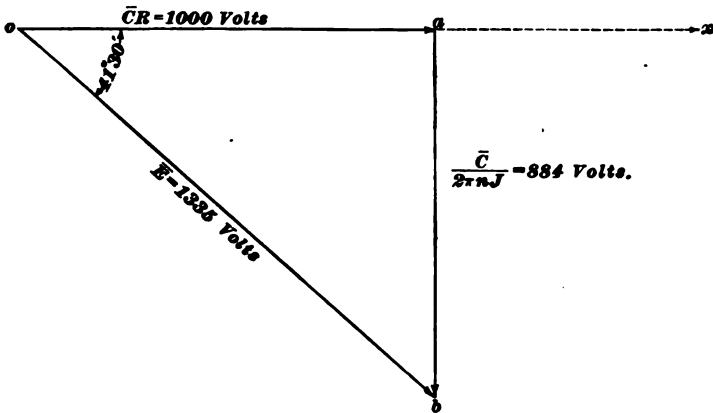

FIG. 1479.

triangle being laid off to scale to represent the different E. M. F.'s.

CIRCUITS CONTAINING RESISTANCE, SELF-INDUCTION, AND CAPACITY.

3912. It quite frequently happens that a circuit may contain all three of the above. Electrolytic cells in some cases act like a condenser, and synchronous motors under certain conditions often cause leading currents, thereby affecting the flow of current in the same way as a capacity.

The effect of all these three quantities, resistance, self-induction, and capacity, being present in a circuit is easily understood if it is remembered that the self-induction and capacity always tend to neutralize each other. The effect

E. M. F. at its terminals is constantly changing. If an ammeter M is connected in the circuit, it will give a reading just as if the alternator were sending a current through an ordinary circuit, whereas there is really no electrical connection between the terminals of the condenser J , and if

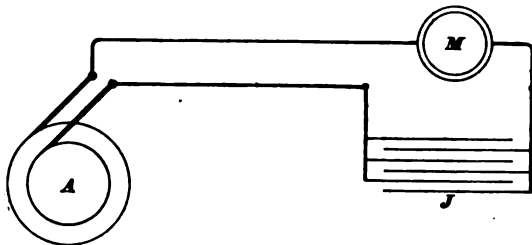

FIG. 1473.

it were connected to a continuous-current dynamo, the ammeter M would give no reading whatever. What really occurs is a surging of current into and out of the condenser.

CONDENSER E. M. F.

3902. Let the full-line curve, Fig. 1474, represent the current which flows into and out of a condenser when a sine E. M. F. is impressed on its terminals. This current

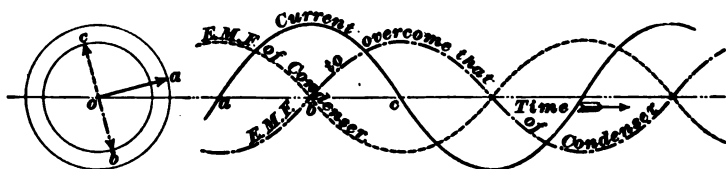

FIG. 1474.

will, of course, have a frequency equal to that of the alternator to which the condenser is attached. It will require a certain impressed E. M. F. to cause this current to flow, just as it required an E. M. F. to overcome the inductance of a circuit. The problem now is to determine the value of this E. M. F. and its phase relation with regard to the current.

The E. M. F. required to set up this current will be the equal and opposite of the E. M. F. of the condenser, just as

the E. M. F. to overcome self-induction was the equal and opposite of the E. M. F. of self-induction.

3903. It has already been shown that when the flow of current into the condenser is a maximum the counter E. M. F. of the condenser is zero, and when the flow finally becomes zero the counter E. M. F. is a maximum. It follows, therefore, that the wave representing the E. M. F. of the condenser is at right angles to the current. The fact as to whether it is 90° ahead of or behind the current may be decided as follows: When the current is flowing into the condenser, the counter E. M. F. is continually increasing in such a direction as to keep it out. The curve representing the E. M. F. of the condenser must cross the axis at the point *b*, Fig. 1474, because, as shown above, this curve is at right angles to the current curve. During the interval of time from *b* to *c*, the current is decreasing, so that during this interval the counter E. M. F. of the condenser must be increasing in the opposite direction, and is therefore represented by the dotted curve, which is 90° ahead of the current. The impressed E. M. F. necessary to overcome that of the condenser must be the equal and opposite of this, or 90° behind the current. This latter E. M. F. is shown by the dot and dash curve. The lines in the diagram at the left show these phase relations, the line *oa* representing the current, *oc* the E. M. F. of the condenser, and *ob* the impressed E. M. F. to overcome that of the condenser.

Hence, in a circuit containing capacity only, the current is 90° ahead of the impressed E. M. F., or the E. M. F. necessary to set up a current in such a circuit is 90° behind the current in phase.

In Fig. 1475 the current is represented by the line *Oa* and the impressed E. M. F. necessary to maintain the current by *Ob*, 90° behind *Oa*. The counter E. M. F. of the

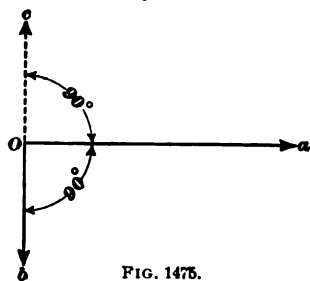

FIG. 1475.

condenser itself would be represented by $O c$; equal and opposite to $O b$, and hence 90° ahead of the current.

3904. The student will note from the above that the effect of capacity in a circuit is exactly the opposite of self-induction. Capacity tends to make the current lead the E. M. F., while self-induction causes it to lag. When both self-induction and capacity are present in a circuit, one tends to neutralize the other.

3905. The E. M. F. in volts (effective) necessary to overcome the capacity or condenser E. M. F. in a circuit may be calculated as follows :

If the capacity of the condenser be J farads and a *maximum* E. M. F. E be applied to its terminals, it will take up a *maximum* charge $Q = J E$ coulombs. The E. M. F. passes through n cycles per second, i. e., the condenser is charged up to a maximum in one direction, then discharged, and the process repeated in the opposite direction, n times per second. The average rate of charge and discharge is, therefore, $4 n$, i. e., $4 n$ times per second.

The maximum rate = average rate $\times \frac{\pi}{2}$; hence, the maximum rate of charge and discharge is $\frac{4 n \times \pi}{2} = 2 \pi n$. The maximum charge is $J E$, and if the maximum rate of charge is $2 \pi n$, the maximum current must be

$$C = J E 2 \pi n. \quad (628.)$$

Hence,
$$E = \frac{C}{2 \pi n J}. \quad (629.)$$

This formula gives the relation between the maximum E. M. F. and maximum current. The effective E. M. F. is equal to the maximum divided by $\sqrt{2}$. Dividing each side of the equation by $\sqrt{2}$, we have

$$\frac{E}{\sqrt{2}} = \frac{C}{2 \pi n J \sqrt{2}}; \text{ or, } \bar{E} = \bar{C} \frac{1}{2 \pi n J}; \quad (630.)$$

so it is seen that this equation also gives the relation between the effective E. M. F. and current.

CAPACITY REACTANCE.

3906. The quantity $\frac{1}{2\pi nJ}$ is called the **capacity reactance**, as it is analogous to the reactance $2\pi nL$ in circuits where self-induction is present. It has also been called the *condensance* by some writers.

EXAMPLE.—Required the E. M. F. necessary to set up an alternating current of 2 amperes through a condenser having a capacity of 5 microfarads, the frequency being 60 cycles per second.

SOLUTION.—By formula **630** we have

$$\bar{E} = \bar{C} \frac{1}{2\pi nJ};$$

$\bar{C} = 2$ amperes; $J = 5$ microfarads = .000005 farad; $n = 60$;

$$\bar{E} = \frac{2}{2 \times 3.14 \times 60 \times .000005} = 1,061 \text{ volts. Ans.}$$

EXAMPLE.—*BB*, Fig. 1476, represents a high-tension power-transmission line connected to an alternator *A*. The pressure maintained

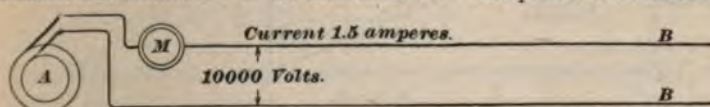

FIG. 1476.

between the lines is 10,000 volts, and the frequency is 60 cycles per second. There is no connection between the wires, and they are supposed to be so insulated that practically no leakage takes place between them. On running the alternator, it is found that the ammeter *M* gives a reading of 1.5 amperes. What must be the electrostatic capacity of the line?

SOLUTION.—From formula **630** we have, by derivation,

$$\bar{C} = 2\pi nJ\bar{E},$$

$$J = \frac{\bar{C}}{2\pi n\bar{E}} = \frac{1.5}{2 \times 3.14 \times 60 \times 10,000} \text{ farads,}$$

$$= \frac{1.5 \times 1,000,000}{2 \times 3.14 \times 60 \times 10,000} = .398 \text{ microfarad. Ans.}$$

CIRCUITS CONTAINING RESISTANCE AND CAPACITY.

3907. In case a circuit contains both resistance and capacity, the current will lead the E. M. F. The amount of lead will depend upon the relative values of the resistance and capacity reactance. If the resistance is very large compared

with the capacity reactance, the angle of lead will be small, because that component of the E. M. F. at right angles to the current will be small. On the other hand, if the capacity reactance is very large as compared with the resistance, the current may lead the E. M. F. by nearly 90° .

3908. The resultant E. M. F. may in such circuits be looked upon as being composed of two components, one at right angles to the current, used in overcoming the capacity reactance and equal to $\frac{\bar{C}}{2\pi nJ}$, and the other, necessary to overcome the resistance, equal to $\bar{C}R$ and in phase with the

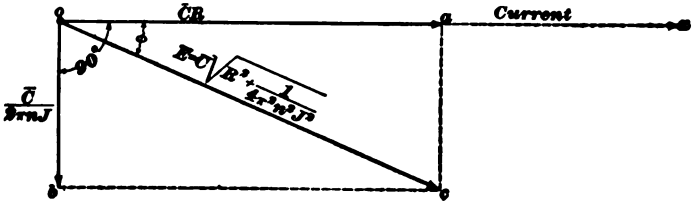

FIG. 1477.

current. These E. M. F.'s may be represented by the diagram, Fig. 1477. oa represents the current line and $oa = \bar{C}R$ the E. M. F. to overcome resistance. The E. M. F. to overcome the capacity reactance is represented by ob 90° behind oa , and the resultant impressed E. M. F. \bar{E} by the diagonal oc . The current leads the E. M. F. by the angle

Φ , the tangent of which is equal to $\frac{ac}{oa} = \frac{\frac{\bar{C}}{2\pi nJ}}{\bar{C}R} = \frac{1}{2\pi nJR}$.

$$\tan \Phi = \frac{1}{2\pi nJR} \quad (631.)$$

In this connection it is well that the student compare Fig. 1477 with Fig. 1464, as these two figures show the difference in the action of capacity and self-induction.

3909. From formula **631** it will be noticed that if R becomes zero, $\tan \Phi = \text{infinity}$, or the angle of lead is 90° . If the capacity J becomes infinitely large, $\tan \Phi = 0$ and the

current is in phase with the E. M. F. This latter is the condition of affairs in an ordinary closed circuit, because in such a case the current keeps on flowing so long as the E. M. F. is applied, and the circuit never becomes charged. In other words, an ordinary closed circuit in which there is no condenser at all acts as if it had an infinitely large capacity, while an open circuit acts as a condenser of infinitely small capacity.

3910. From the triangle *oac*, Fig. 1477, we have the relation

$$\bar{E}^2 = \bar{C}^2 R^2 + \frac{\bar{C}^2}{4 \pi^2 n^2 J^2}$$

$$\bar{E} = \sqrt{\bar{C}^2 R^2 + \frac{\bar{C}^2}{4 \pi^2 n^2 J^2}} \quad (632.)$$

$$\bar{E} = \bar{C} \sqrt{R^2 + \left(\frac{1}{2 \pi n J}\right)^2} \quad (633.)$$

Therefore, in circuits containing resistance and capacity, the impedance of the circuit is equal to the square root of the sum of the squares of the resistance *R* and the capacity reactance

$$\frac{1}{2 \pi n J}.$$

The impressed E. M. F. \bar{E} necessary to maintain a current \bar{C} in a circuit containing resistance and capacity is equal to the current multiplied by the impedance. The law governing the flow of current in such a circuit then becomes

$$\bar{C} = \frac{\bar{E}}{\sqrt{R^2 + \frac{1}{4 \pi^2 n^2 J^2}}} \quad (634.)$$

If the circuit contains a resistance *R* and no condenser, *J* becomes infinite in value, and formula **634** reduces to

$$\bar{C} = \frac{\bar{E}}{R}. \quad \text{That is, the current follows Ohm's law.}$$

If the circuit be broken, it means that the resistance becomes infinitely large, and the capacity *J* being very small, the impedance becomes infinitely large, consequently the current becomes zero.

EXAMPLE.—A non-inductive resistance R (Fig. 1478) of 200 ohms is connected in series with a condenser across the terminals of an alternator as shown, the frequency being 60. The condenser has a

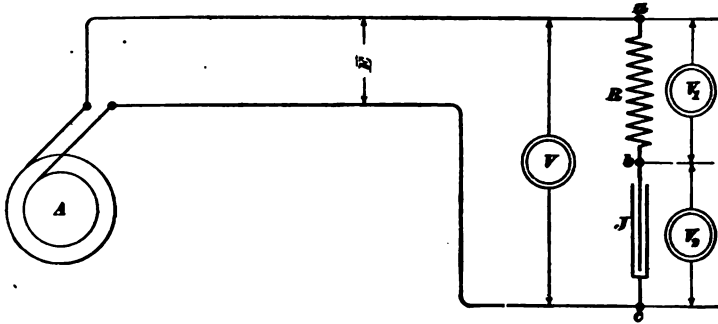

FIG. 1478.

capacity of 15 microfarads, and the current flowing in the circuit is 5 amperes. Required :

1. The reading which would be given by the voltmeter V_1 connected to the terminals of the resistance.
2. The reading of the voltmeter V_2 , connected to the terminals of the condenser.
3. The angle by which the current will lead the E. M. F.
4. The E. M. F. which must be furnished by the alternator—i. e., the reading of the voltmeter V connected across the mains.

SOLUTION.—We know that the three required E. M. F.'s must be related to each other as shown in Fig. 1477.

1. The reading given by the voltmeter V_1 must evidently be the E. M. F. necessary to overcome the resistance R , and hence is equal to $\bar{C}R = 5 \times 200 = 1,000$ volts. Ans.

2. The reading of V_2 represents the E. M. F. necessary to overcome the capacity reactance, and hence is equal to

$$\bar{C} \frac{1}{2\pi n f} = \frac{5}{2 \times 3.14 \times 60 \times .000015} = 884 \text{ volts. Ans.}$$

3. The angle by which the current leads the E. M. F. is given by formula 631; $\tan \phi = \frac{1}{2\pi n f R} = .884$. From a table of tangents ϕ is found to be $41^\circ 29'$, nearly, i. e., the current is ahead of the E. M. F. by a little more than one-ninth of a complete cycle. Ans.

4. The resultant E. M. F. \bar{E} , or the voltage which must be furnished by the alternator to set up the current of 5 amperes, is obtained from formula 632: $\bar{E} = \sqrt{\bar{C}^2 R^2 + \frac{\bar{C}^2}{4\pi^2 n^2 f^2}} = \sqrt{1,000^2 + 884^2} = 1,335 \text{ volts.}$

This is the pressure which would be given by the voltmeter V , and it is the resultant sum of the E. M. F. to overcome resistance (1,000 volts) and that to overcome reactance (884 volts).

3911. In an alternating-current circuit as considered in the above example, it is thus seen that it is quite possible for the reading of the voltmeter V to be considerably less than the sum of V_1 and V_2 .

The relation between the quantities in this problem is shown by the E. M. F. triangle, Fig. 1479, the sides of the

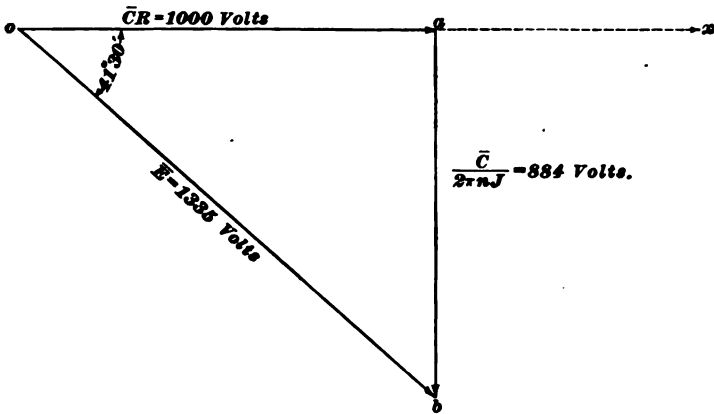

FIG. 1479.

triangle being laid off to scale to represent the different E. M. F.'s.

CIRCUITS CONTAINING RESISTANCE, SELF-INDUCTION, AND CAPACITY.

3912. It quite frequently happens that a circuit may contain all three of the above. Electrolytic cells in some cases act like a condenser, and synchronous motors under certain conditions often cause leading currents, thereby affecting the flow of current in the same way as a capacity.

The effect of all these three quantities, resistance, self-induction, and capacity, being present in a circuit is easily understood if it is remembered that the self-induction and capacity always tend to neutralize each other. The effect

reactance $\frac{1}{2\pi nJ}$ is less than the reactance $2\pi nL$ due to the self-induction. The resultant E. M. F. \bar{E} necessary to maintain the current in the circuit may then be determined as shown in Fig. 1481. oa represents, as in previous problems, the E. M. F. necessary to overcome the resistance $= \bar{C}R$ and in phase with the current along the line ox ; oc , the E. M. F. to overcome self-induction, 90° ahead of oa , equal to $2\pi nL\bar{C}$; and ob , the E. M. F. necessary to overcome capacity, 90° behind oa , equal to $\frac{\bar{C}}{2\pi nJ}$. The total component at right angles to the current will be $2\pi nL\bar{C} - \frac{\bar{C}}{2\pi nJ}$ and may be laid off by measuring back from c , $o'b' = ob$. oe is then the resultant component at right angles to the current, and the impressed E. M. F. furnished by the alternator is the resultant of oe and oa , i. e., the diagonal od . This resultant E. M. F. is in this case ahead of the current by the angle Φ or the current is *lagging* behind the E. M. F.

3913. From the triangle oda , Fig. 1481, we have the relation

$$\bar{E}^2 = \bar{C}^2 \left\{ R^2 + \left(2\pi nL - \frac{1}{2\pi nJ} \right)^2 \right\}, \quad (635.)$$

$$\text{and } \bar{E} = \bar{C} \sqrt{R^2 + \left(2\pi nL - \frac{1}{2\pi nJ} \right)^2}. \quad (636.)$$

The expression under the square root sign is, therefore, the impedance of a circuit possessing resistance, self-induction, and capacity, because it is that quantity which multiplied by the current gives the E. M. F.

The impedance of a circuit containing resistance, self-induction, and capacity is equal to the square root of the sum of the squares of the resistance and the difference between the reactance due to self-induction and the reactance due to capacity.

From formula **636** we have

$$\bar{C} = \frac{\bar{E}}{\sqrt{R^2 + \left(2\pi nL - \frac{1}{2\pi nJ} \right)^2}}, \quad (637.)$$

giving the relation between current and E. M. F. for a circuit containing all three of the above quantities.

3914. The tangent of the angle between the E. M. F. and current is given by the expression

$$\tan \phi = \frac{2 \pi n L - \frac{1}{2 \pi n f}}{R} \quad (638.)$$

So long as the expression $2 \pi n L - \frac{1}{2 \pi n f}$ is positive, i. e., when the self-induction has a greater effect than the capacity, the component oe , Fig. 1481, will be above oa and the current will lag behind the E. M. F. If the expression is negative, i. e., when the capacity has a greater effect than the self-induction, the component oe will be negative, or below the line ox , and the current will lead the E. M. F. In such a circuit, therefore, the angle between the E. M. F. and current may vary 90° either way. Fig. 1482 shows a

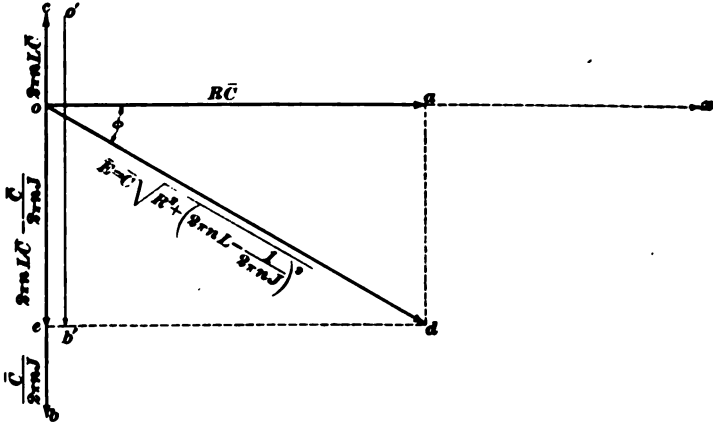

FIG. 1482.

case where the capacity has a greater influence than the self-induction, i. e., oc is less than ob . Measuring $o'b' = ob$ from c gives oe as the difference $= 2 \pi n L \bar{C} - \frac{\bar{C}}{2 \pi n f}$, and the E. M. F. $\bar{E} = od$. The current in this case is ahead of the E. M. F. by the angle ϕ .

3915. When $2\pi nL = \frac{1}{2\pi nJ}$, the expression $2\pi nL - \frac{1}{2\pi nJ}$ becomes zero, and $\Phi = 0$. When this is the case, the current is in phase with the E. M. F. and follows Ohm's law, the capacity and self-induction neutralize each other, and, though both are present in the circuit, the effect is the same as if neither were there.

In practice it is almost impossible to obtain complete neutralization of self-induction by capacity; but if the conditions are favorable, it may be approached quite closely.

3916. If the self-induction were neutralized by the capacity, the current flowing under a given impressed E. M. F. would be a maximum and would be determined by Ohm's law.

This condition is shown in Fig. 1483, where oc and ob are equal and opposite, and $R\vec{C} = \vec{E}$ because the current and E. M. F. are in phase.

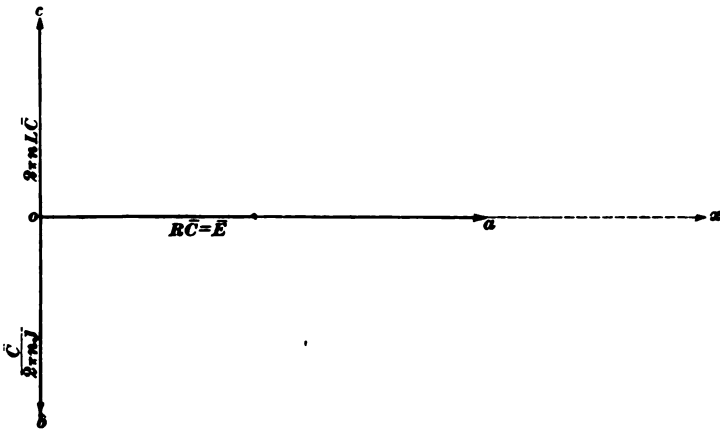

FIG. 1483.

It should be noted that, with given values of self induction and capacity, this condition can exist only for one particular

value of the frequency, and for any other value the two would not neutralize each other. If

$$2\pi nL = \frac{1}{2\pi nJ},$$

we have $n = \sqrt{\frac{1}{4\pi^2 J L}} = \frac{1}{2\pi} \sqrt{\frac{1}{JL}},$ (639.)

which gives the value of the frequency corresponding to the values of J and L . This *production of a maximum current* in a circuit for a certain *critical value* of the frequency is known as **electrical resonance**.

3917. Resonance sometimes produces peculiar effects in a circuit. If the resistance of the circuit is very low, a neutralization of the self-induction would allow a large current to flow. The E. M. F. across the terminals of the condenser is $\frac{\bar{C}}{2\pi nJ}$, and if \bar{C} be very large, this pressure may rise to a value very much greater than the impressed E. M. F. In the case of an underground cable, the pressure between the wire and the sheath might rise sufficiently to break down the insulation, while at the same time the E. M. F. supplied by the generator might not be at all high. Usually, however, the frequencies employed in practice are not high enough to make the effects of resonance very common.

3918. The following example will show the application of the above formulas to a circuit containing resistance, self-induction, and capacity:

EXAMPLE.—An alternator A , Fig. 1484, is connected to a circuit having resistance $R = 100$ ohms, self-induction $L = .25$ henry, and

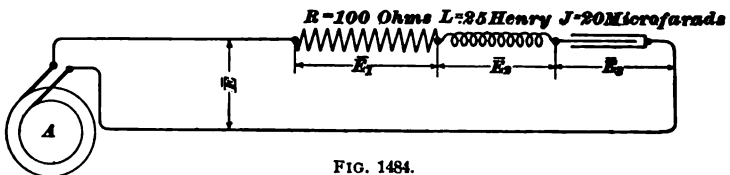

FIG. 1484.

capacity $J = 20$ microfarads. The current flowing is 5 amperes, and the frequency 60 cycles per second. Required to—

1. Find the E. M. F. or drop E_1 across the resistance, drop E_2 across the inductance, drop E_3 across the condenser.

2. Determine whether the current lags behind the impressed E. M. F., or is ahead of it, and by what amount.

3. Find the value of the impressed E. M. F. necessary to maintain the current of 5 amperes.

SOLUTION.—1. If the inductance $L = .25$ henry, the reactance $2\pi nL = 2 \times 3.14 \times 60 \times .25 = 94.2$ ohms.

The capacity $J = 20$ microfarads, hence the capacity reactance =

$$\frac{1}{2\pi nJ} = \frac{1,000,000}{2 \times 3.14 \times 60 \times 20} = 132.7 \text{ ohms.}$$

The E. M. F. necessary to overcome resistance = $\bar{C}R = 5 \times 100 = 500$ volts = \bar{E}_1 .

The E. M. F. necessary to overcome inductance = $\bar{C} \times 2\pi nL = 5 \times 94.2 = 471$ volts = \bar{E}_2 .

The E. M. F. necessary to overcome capacity = $\frac{\bar{C}}{2\pi nJ} = 132.7 \times 5 = 663.5$ volts = \bar{E}_3 . Ans.

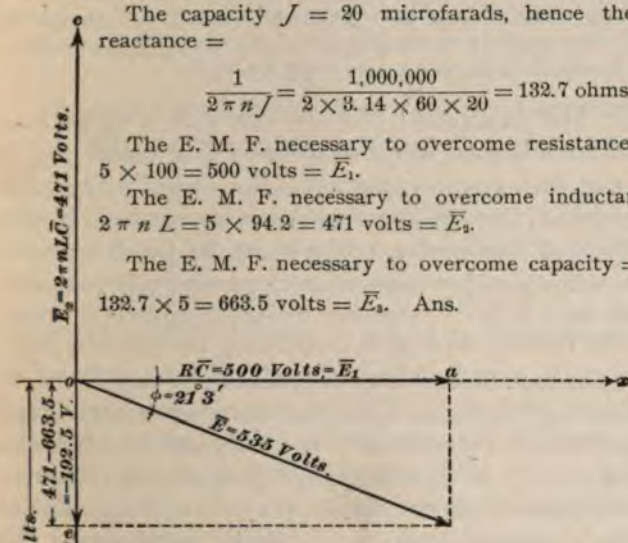

Scale 1" = 250 Volts.

FIG. 1485.

2. Since the E. M. F. necessary to overcome capacity is 663.5 volts and is 90° behind the current, while that to overcome self-inductance is only 471 volts and 90° ahead of the current, the resultant component at right angles to the current is $\bar{C}2\pi nL - \frac{\bar{C}}{2\pi nJ} = 471 - 663.5 = -192.5$, and is 90° behind the current (the negative sign indicating that this component is below the current line). It follows, then, that the impressed E. M. F. \bar{E} lags behind the current, or the current is in advance of the E. M. F. The relation of the different E. M. F.'s will be readily seen by referring to Fig. 1485. The angle by which the current leads is found easily from the figure, because $\tan \phi = \frac{192.5}{500} = .385$,

and ϕ is found to be $21^\circ 3'$, or the current is a little over $\frac{1}{5}$ of a period ahead of the impressed E. M. F. Ans.

3. The E. M. F. \bar{E} furnished by the alternator is equal to the current \times impedance; hence,

$$\bar{E} = \bar{C} \sqrt{R^2 + \left(2\pi n L - \frac{1}{2\pi n C}\right)^2} = 535 \text{ volts. Ans.}$$

In connection with this example the student should note that while the E. M. F. furnished by the alternator is only 535 volts, the pressure across the terminals of the condenser is 663.5 volts.

3919. The examples given in the preceding articles will serve to illustrate the composition and resolution of E. M. F.'s in such circuits as are commonly met with. The student should notice that in every case where such E. M. F.'s are combined or resolved, account must be taken not only of their magnitude, but also of their phase relation. For this reason such E. M. F.'s can not be simply added together, as is done in dealing with direct currents, but the resultant sum must in all cases be obtained by using the polygon or parallelogram of forces. If these phase relations are kept in mind, many of the peculiarities in the behavior of the alternating current are easily understood; as, for instance, in the last example, where the E. M. F. across one part of the circuit is greater than the E. M. F. taken across the whole, a thing which would be impossible in a direct-current circuit, but which is quite possible in the case worked out, on account of the phase relations between the E. M. F.'s in the different parts of the circuits.

In working out such problems, it is always best to draw out a diagram representing the different E. M. F.'s, as it makes the relation between them more easily understood. Quite a number of problems may be solved graphically by adopting convenient scales for the different quantities and laying out the E. M. F. triangles. The resultant may then be scaled off the drawing and the result obtained more easily than by calculation. Examples of this method have been shown in connection with several of the preceding problems. Unfortunately, however, it is almost impossible to use the graphical method in a large number of cases arising in prac-

tice, because the conditions are often such that the quantities entering into the problem result in such long, thin triangles and parallelograms that it is almost impossible to scale off any result accurately. In such cases the resultant E. M. F. has to be calculated by trigonometry from a knowledge of the sides and angles of the triangle or parallelogram in question.

CALCULATION OF POWER EXPENDED IN ALTERNATING-CURRENT CIRCUITS.

3920. If a continuous current C flows through a wire of resistance R , the wire becomes heated, and the rate at which work is done in heating the wire is proportional to the square of the current C and to the resistance R ; i. e., watts expended = C^2R . Since $C = \frac{E}{R}$, we have watts = $C E$.

Hence it may be stated that, in a continuous-current circuit, if we wish to calculate the watts expended, we multiply the current C by the E. M. F. E necessary to force the current through the circuit. This is also true in a circuit where the energy expended reappears in other forms besides heat. For example, we might have a direct-current dynamo D , Fig. 1486, sending current through a circuit $a d$, consisting

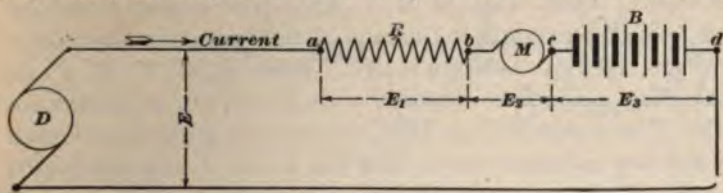

FIG. 1486.

of a resistance R , a motor M , and a storage-battery B . The total power expended in the circuit from a to d will be the product of the current C and the E. M. F. E across the circuit. Part of this energy = $C E_1$ will reappear as heat in the resistance R , another part, equal to $C E_2$, will reappear as work done by the motor M , and the energy expended in the

battery, $C E_s$, will be stored up by virtue of the chemical reactions which are caused to take place by the current.

3921. *If an alternating current be sent through a circuit, the power expended at each instant is given by the product of the instantaneous values of the current and E. M. F. It is seen at once, then, that the phase relation between the current and E. M. F. will have an important bearing upon the power supplied, because the value of the E. M. F. corresponding to any particular value of the current will depend altogether upon their phase relation. In alternating-current circuits, therefore, the power expended can not be obtained by simply taking the product of the volts and amperes as is done with direct currents. The effect of difference of phase*

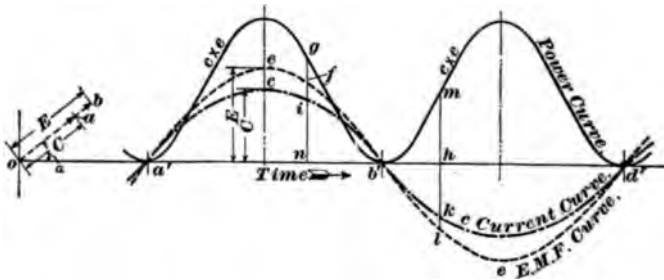

FIG. 1487.

between current and E. M. F. upon the power expended can be well illustrated by means of the sine curves as shown in Figs. 1487 to 1490 inclusive. Suppose an E. M. F. of maximum value E is in phase with a current of maximum value C , as shown in Fig. 1487, the current being represented by the dot and dash curve, and the E. M. F. e by the dotted curve. The power at any instant, such as that represented by the point n , is proportional to the product of the ordinates ni and nf of the c and e curves. If an ordinate ng is therefore erected at n proportional to this product, g will be a point on the power curve. In this way the power curve shown by the full line is constructed, and it shows the way in which the power supplied to the circuit varies with the E. M. F. and current. It should be noticed that in this case

(current and E. M. F. in phase) the power curve lies wholly above the horizontal; that is, the work is all positive, or, in other words, power is being supplied to the circuit. This would be the condition if the current were flowing through a non-inductive resistance.

3922. Suppose, however, that the current lags behind the E. M. F. by an angle Φ less than 90° , as shown in Fig. 1488.

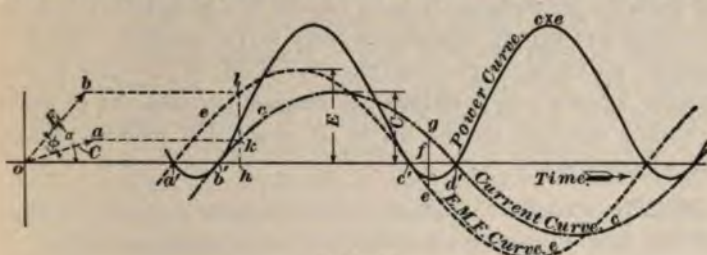

FIG. 1488.

The power curve is here constructed as before, but it is no longer wholly above the horizontal. The ordinate fg of the current curve is positive, while at the same instant that of the E. M. F. curve fe is negative, consequently

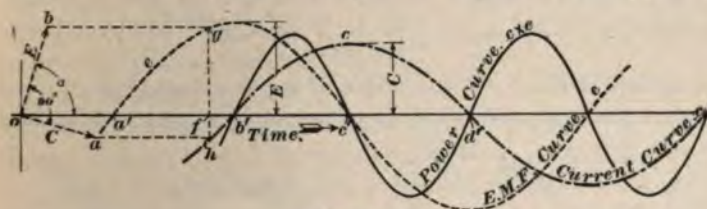

FIG. 1489.

their product is negative, and the corresponding ordinate of the power curve is below the horizontal. This means that during the intervals of time $a' b'$ and $c' d'$, *negative work* is being performed; or, in other words, the circuit, instead of having work done on it, is returning energy to the system to which it is connected. In Fig. 1489 the angle of lag has become 90° , or the current is at right angles to the E. M. F. In this case the power curve lies as much above the axis as

below it, and the circuit returns as much energy as is expended in it. The total work done in such a case is, therefore, zero, and although a current is flowing, this current does not represent any energy expended. This would be nearly the case if an alternator were supplying current to a circuit having a small resistance and very large inductance, as in this instance the current would lag nearly 90° behind the E. M. F. The primary current of a transformer working with its secondary on open circuit is a practical example of a current which represents very little energy. Such a current at right angles to the E. M. F. is, for the above reasons, known as a **wattless current**, because the product of such a current by the E. M. F. does not represent any watts expended.

3923. Another example of a wattless current is that flowing into and out of a condenser when the resistance of

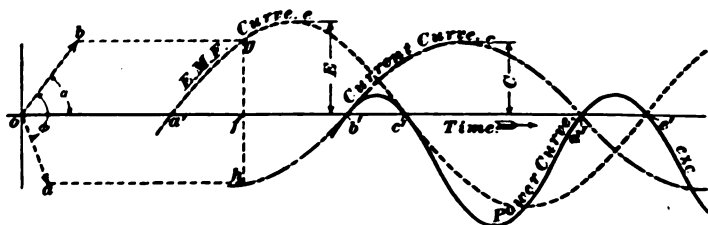

FIG. 1490.

the circuit is zero. If the angle of lag becomes greater than 90° , the greater part of the work becomes negative, as shown

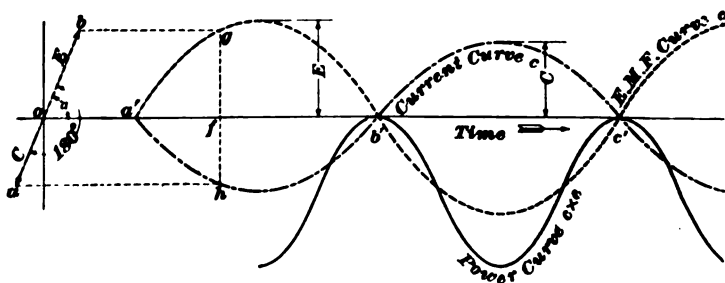

FIG. 1491.

in Fig. 1490. If the angle of lag becomes 180° , as in Fig. 1491, i. e., if the current and E. M. F. are in opposition, the work

done is all negative, and, instead of the alternator doing work on the circuit to which it is connected, the circuit is returning energy to the alternator and running it as a motor. In the above diagrams the relation in phase between the current and E. M. F. is shown in each case by the lines $o a$ and $o b$, respectively.

3924. The power curves in Figs. 1488 to 1491 show the instantaneous values of the watts expended in a circuit for different values of the angle of lag. What it is usually important to know, however, is the average rate at which energy is expended. Let $o a$, Fig. 1492, represent the effective value of the current \bar{C} , which lags behind the effective E. M. F. $\bar{E} = o b$ by an angle Φ . The average watts expended will be the E. M. F. \bar{E} multiplied by *that component of the current \bar{C} which is in the same direction as the E. M. F.* If a line perpendicular to $o b$ be drawn from a to d , the line $o d$ represents the component of \bar{C} , which is in the same direction as $o b$, and the watts expended are proportional to the product $o b \times o d$. The same result would be obtained by multiplying the current $o a$ by the component of the E. M. F. in the same direction as the current, i. e., by the product $o a \times o c$. It is

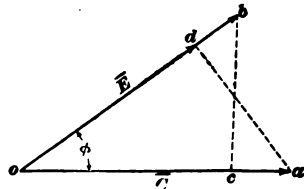

FIG. 1492.

usual to consider the current as resolved into two components, one at right angles to the E. M. F., and the other in the same direction, although it makes no difference in the numerical result which is taken. In Fig. 1492 $o d = o a \cos \Phi$; hence, watts = $o d \times o b = o a \cos \Phi o b = \bar{E} \bar{C} \cos \Phi$. Or, $o c = o b \cos \Phi$, and watts = $o c o a = o b \cos \Phi o a = \bar{C} \bar{E} \cos \Phi$. It may, therefore, be stated that *the mean power supplied to an alternating-current circuit, in watts, is equal to the effective volts multiplied by the effective amperes times the cosine of the angle between them.*

3925. The fact that the product $\bar{C} \bar{E} \cos \Phi$ gives the watts delivered to a circuit may be proved mathematically as follows:

Let $i \sin \alpha$ and $i \cos \alpha$ (Fig. 140) represent the maximum values E and C of the E. M. F. and current, differing in phase by the angle ϕ . These are supposed to rotate uniformly around O , and the angle α , which is constantly increasing, always represents the angular distance of $i \sin \alpha$ from the reference line OX . The angle ϕ remains constant; that is, $i \sin \alpha$ and $i \cos \alpha$ always keep a fixed distance apart. The instantaneous value of the E. M. F. is given by the

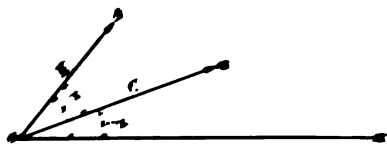

FIG. 140.

expression $e = E \sin \alpha$ (see Art. 3547). The current c also passes through a set of instantaneous values and lags behind E by the constant angle ϕ . The value of the current at any instant is given by the expression $c = C \sin (\alpha - \phi)$. The product of the instantaneous values e and c gives the instantaneous watts expended, or

$$ec = EC \sin \alpha \sin (\alpha - \phi).$$

From trigonometry, $\sin (\alpha - \phi) = \sin \alpha \cos \phi - \cos \alpha \sin \phi$; hence,

$$ec = EC \cos \phi \sin^2 \alpha - EC \cos \alpha \sin \alpha \sin \phi,$$

and the average value of the watts is

$$\text{av. } ec = \text{av. } EC \cos \phi \sin^2 \alpha - \text{av. } EC \cos \alpha \sin \alpha \sin \phi;$$

$$\text{or,} \quad \text{av. } ec = EC \cos \phi \text{ av. } \sin^2 \alpha - EC \sin \phi \text{ av. } \sin \alpha \cos \alpha.$$

The average value of $\sin \alpha \cos \alpha$ is zero, since both pass through positive and negative values alike, and the average value of $\sin^2 \alpha = \frac{1}{2}$; hence,

$$\text{average } ec = \frac{EC}{2} \cos \phi.$$

If the maximum values E and C are expressed in terms of their effective values, i. e., $E = \bar{E}\sqrt{2}$, $C = \bar{C}\sqrt{2}$, we have

$$\text{average power} = \text{average } ec = \bar{E}\bar{C} \cos \phi. \quad (640.)$$

POWER FACTOR OF A CIRCUIT.

3926. If an alternating current of \bar{C} amperes be flowing through a circuit, and the pressure across the terminals of the circuit is \bar{E} volts, the watts which are *apparently* expended would be given by the product of the current and E. M. F., that is, by $\bar{C} \times \bar{E}$. The *real* watts expended are, however, obtained, as proved above, by the product of $\bar{C} \bar{E}$ and $\cos \Phi$. The ratio $\frac{\text{real watts}}{\text{apparent watts}}$ is called the **power factor** of the system.

The power factor of a system may then be defined as *that quantity by which the apparent watts expended in the system must be multiplied in order to give the true watts*. From formula **640**, it will be seen that the power factor is numerically equal to $\cos \Phi$, and it is sometimes spoken of as "the $\cos \Phi$ of the system."

3927. If the current and E. M. F. are in phase, $\Phi = 0$ and $\cos \Phi = 1$; consequently the true watts expended under such circumstances may be obtained by taking simply the product $\bar{C} \times \bar{E}$. When the angle of lag is 90° , $\cos \Phi = 0$ and the true watts expended is zero, i. e., the current is wattless. When Φ becomes greater than 90° , $\cos \Phi$ becomes negative, thus showing that the circuit is delivering energy to the system to which it is connected. It will be seen, then, that it is quite possible to have large alternating currents flowing under high E. M. F.'s, and at the same time have very little energy expended.

3928. The power factor in the case of direct-current systems is always unity; but in cases where alternating current is used, it may vary from unity to zero. In most alternating-current systems the pressure is kept constant, or nearly so; hence, it follows that when a given amount of power is to be transmitted, the current will be smaller if the power factor is high than if it is low. This will, perhaps, be best illustrated by means of an example. Suppose it is desired to transmit 100 kilowatts over a line by means of

alternating current. The load on the line consists principally of motors, and will, therefore, be more or less inductive. We will suppose that the current lags behind the E. M. F. by an angle of 25° . $\cos \Phi$ is then equal to .90, and the power factor will be .90; hence,

$$\begin{aligned} \text{true watts} &= \text{apparent watts} \times .90 \\ &= \text{volts} \times \text{amperes} \times .90. \end{aligned}$$

We will suppose that the pressure used in transmission is 1,000 volts;

then, $100,000 = 1,000 \times \text{amperes} \times .90$,

and the current necessary will be 111.1 amperes. If the power factor had been unity, only 100 amperes would have been required. This example will serve to show the necessity of having the power factor as high as possible.

WATTLess AND POWER COMPONENTS.

3929. It was mentioned in connection with Fig. 1492 that the current could be looked upon as resolved into two components, one at right angles to the E. M. F. and the other in phase with it. This is shown in Fig. 1494. The component at right angles to the E. M. F. is known as the **wattless component** of the current, and the part in phase

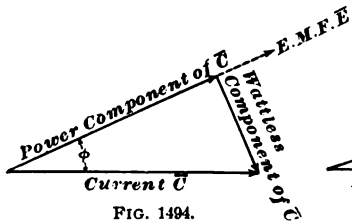

FIG. 1494.

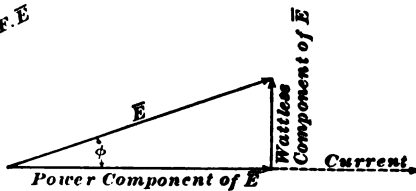

FIG. 1495.

is known as the **power component**. The E. M. F. may, in the same way, be looked upon as divided into wattless and power components, as shown in Fig. 1495. From these figures it is easily seen that the greater the angle of lag, the larger will be the wattless component and the smaller the part which is really expending power in the circuit.

3930. Although wattless currents do not represent any power wasted, they are objectionable, because they load up the lines and alternators and thus limit their output as to current-carrying capacity. For example, an alternator might be furnishing a current of, say, 20 amperes to a system having a very low power factor. The actual power delivered would be small, and the engine would not have to work hard to drive the dynamo. At the same time, the current of 20 amperes is circulating through the lines and the armature of the alternator, and thus will load up the lines and heat up the machine. As the current output of the armature is limited to a large extent by this heating, it is seen that the useful current which may be taken from the alternator is cut down by the presence of this wattless component. Alternating-current apparatus, such as induction motors, etc., are always designed so as to have as high a power factor as possible consistent with economy. The use of condensers has been suggested for neutralizing the self-induction, thus increasing the power factor, and one manufacturing company has used condensers in connection with induction motors to cut down the lag in the current.

EXAMPLE.—An alternator generating an E. M. F. of 1,000 volts at a frequency of 60 cycles per second supplies current to a system of which the resistance is 100 ohms and the inductance .3 henry. Find the value of the current, angle of lag, power factor, apparent watts, and true watts.

SOLUTION.—We have, by formula **625**,

$$\bar{C} = \frac{\bar{E}}{\sqrt{R^2 + (2\pi nL)^2}} = \frac{1,000}{\sqrt{100^2 + (2 \times 3.14 \times 60 \times .3)^2}} = \frac{1,000}{150.8} = 6.63 \text{ amperes.}$$

Reactance = $2\pi nL = 113.04$ ohms.

$$\tan \phi = \frac{2\pi nL}{R} = \frac{113.04}{100} = 1.13;$$

hence,

$$\phi = \text{angle of lag} = 48^\circ 30',$$

$$\text{power factor} = \cos \phi = .662,$$

$$\text{apparent watts} = \bar{E} \bar{C} = 1,000 \times 6.63 = 6,630,$$

$$\text{real watts} = \bar{E} \bar{C} \cos \phi = 1,000 \times 6.63 \times .662 = 4,389 \text{ watts.} \quad \text{Ans.}$$

The effect of the self-induction in the above example is, therefore, to cause a lag of $48^{\circ} 30'$, and by so doing the current of 6.63 amperes is equivalent to only 4,389 watts transmitted; whereas, if there were no inductance and $\cos \Phi = 1$, this current would have been equivalent to 6,630 watts.

TRANSMISSION LINES.

3931. In transmitting power over lines by means of the electric current, a certain loss of energy always occurs, due to the resistance of the wire. This loss can not be avoided, and all that can be done is to keep it down to within reasonable limits. Of course, the loss can be made as small as we please by increasing the size of the line conductor, but it is less expensive to allow a certain loss than to make the conductor very large. The lost energy in transmission lines varies greatly and depends largely on local conditions. Quite often it is about 5 or 10 per cent. of the power transmitted, and in some cases it is more than this, especially on long lines. The loss in the line results in a falling off in pressure between the station and the distant end, the number of volts decrease, or **drop**, as it is called, being obtained, in the case of continuous-current circuits, by multiplying the current by the resistance of the line. Evidently the drop will increase as the load or current increases, and if the pressure at the receiving end is to be kept constant at all loads, the pressure at the station must be increased as the current increases.

3932. The calculation of the size of wire to transmit a given amount of power over a given distance with a specified loss is a simple matter in the case of a direct-current circuit, as it requires simply a wire of such a size that the resistance of the circuit shall not cause the loss to exceed the specified amount. For example, suppose it is required to transmit 20 kilowatts a distance of 2 miles by means of direct current. The voltage at the delivery end is to be 500, and the loss is not to exceed 10 per cent. of this, i. e.,

the allowable drop is 50 volts at full load. The full load

$$\text{current} = \frac{\text{watts}}{\text{volts}} = \frac{20,000}{500} = 40 \text{ amperes.}$$

$$C \times R = 50 \text{ volts.}$$

$$R = \frac{50}{40} = 1.25 \text{ ohms.}$$

The resistance of the whole length of wire from the station and back, or 4 miles, must not exceed 1.25 ohms, or the resistance per mile = .312 ohm. By consulting a wire table this is found to be about a No. 000 B. & S. wire.

3933. In the case of a line using alternating current, the pressure required to send the current through the line is found by taking the product of the current and impedance instead of the current and resistance. A long transmission line may have an appreciable self-inductance, which has the effect of apparently increasing its resistance. For short lines this inductive effect is not usually taken account of, but it is not always safe to leave it out of account in the calculation of long lines, especially if a large conductor is used. The effect of inductance is evidently, with the same current, to cause the drop over the line to be greater than if it were not present. If, then, we are limited to the same number of volts drop, it follows that the inductance necessitates the use of a larger wire.

3934. The self-induction of a line depends on its length as well as on the distance apart which the wires are placed on the poles and can be calculated when the distance from center to center is known. The resistance per mile for any given size is easily calculated; hence the impedance per mile for a given frequency n may be found from the expression

$$\text{Impedance} = \sqrt{R^2 + (2\pi nL)^2}. \quad (\text{See Art. 3889.})$$

The impedance and reactance per mile for various sizes of wire and distances of spread have been calculated by Emmet and are given in Table 114. The reactance and impedance are here calculated for frequencies of 60 and 125,

THEORY OF ALTERNATING

Reactance and Impedance in Ohms per Mile of Wire
at a Frequency of 120.

Wavelength in Miles	40 Feet Between Centers		12 Inches Between Centers		8 Inches Between Centers		24 Inches Between Centers	
	React.	Imp.	React.	Imp.	React.	Imp.	React.	Imp.
0.000	.259	.508	.591	.646	1.06	1.092	1.17	1.190
0.001	.324	.523	.607	.686	1.09	1.138	1.20	1.237
0.002	.412	.534	.618	.749	1.12	1.194	1.23	1.297
0	.519	.550	.633	.818	1.15	1.258	1.26	1.360
1	.655	.565	.648	.920	1.18	1.349	1.28	1.436
2	.826	.580	.663	1.060	1.21	1.466	1.31	1.550
3	1.041	.591	.674	1.240	1.24	1.610	1.34	1.700
4	1.313	.606	.690	1.480	1.26	1.820	1.37	1.890
5	1.650	.620	.704	1.800	1.30	2.100	1.40	2.170
6	2.068	.633	.720	2.210	1.32	2.460	1.43	2.510
7	2.633	.647	.730	2.730	1.35	2.930	1.46	3.000
8	3.320	.662	.742	3.400	1.38	3.590	1.48	3.630
9	4.140	.677	.761	4.230	1.41	4.390	1.51	4.430
10	5.200	.688	.776	5.340	1.44	5.470	1.54	5.500

two most commonly met with. It will be noticed that for the large sizes there is quite a difference between the value of the resistance per mile and the impedance, but as the wire becomes smaller, the resistance becomes so large compared with the reactance that the difference between the resistance and impedance becomes less. As an example, let us consider a transmission line 2 miles in length, which delivers 100 K. W. to a *non-inductive* load, with a drop in voltage of 10%. Voltage at end of line is 2,000 ; frequency, 60 cycles per second. The allowable drop is $10 \times 2,000 = 200$ volts. Since the load is non-inductive, the full-load current corresponding to 100 K. W. will be $\frac{100,000}{2,000} = 50$ amperes.

$$\text{Impedance} = \frac{200}{50} = 4 \text{ ohms.}$$

There are 4 miles of wire, hence the impedance per mile = 1 ohm.

If the wires are placed 12 inches apart, a No. 2 B. & S. would be required, because, by referring to Table 114, it is seen that the impedance per mile for this size when spaced 12 inches is 1.008 ohms.

If the line had no inductance, we would have

$$\text{current} \times \text{resistance} = 200,$$

or resistance = 4 ohms, and resistance per mile = 1 ohm.

The resistance per mile of No. 3 B. & S. is 1.04 ohms, so that for the same allowable drop it is seen that the effect of the self-induction is to cause an increase in the size of wire required. In cases where the frequency is high, the effect of the impedance is much more marked. When the load is not non-inductive, the current for a given amount of power is increased and a still larger wire required. The product, current \times impedance, gives the line drop approximately only, because the impedance drop is not in phase with either the generator or terminal voltages. However, for most practical cases, the error in taking the drop as above is not of consequence unless large line-wires are used.

EXAMPLES FOR PRACTICE.

1. Find the size of wire necessary to transmit 75 K. W. over a line 5 miles in length. The pressure at the end of the line is to be 5,000 volts and frequency is 125 cycles per second. The allowable loss is 10%, and the wires are to be strung on the poles 18 inches apart.

Ans. Wire with an impedance of 3.33 ohms per mile, between a No. 8 and No. 7. No. 7 would probably be used.

2. What would be the size of wire required in example 1 if the line had no inductance?

Ans. Resistance of wire would be 3.33 ohms per mile, or No. 8 B. & S.

ALTERNATING-CURRENT MEASURING INSTRUMENTS.

3935. In measuring alternating E. M. F.'s and currents, we usually wish to know the square-root-of-mean-square, or effective, values, as these are used in most of the ordinary calculations. The maximum or instantaneous values are not used to any great extent. Ammeters and voltmeters for use on alternating-current circuits, as a general rule, therefore, indicate effective values, and most of such instruments will, if standardized by means of direct current, read effective values when connected to alternating-current circuits.

There is not such a large variety of alternating-current instruments as of direct-current, since a large number of instruments adapted for direct-current work will not act at all with alternating current. Generally speaking, an instrument which will give indications with alternating current will work also with direct current, but the reverse is by no means true. Take, for example, the Weston direct-current ammeters and voltmeters (as described in *Electrical Measurements*), which are widely used for direct-current measurements. The current flowing in the coil reacts upon the permanent field, and thus produces a deflection. If such an instrument were connected to an alternating-current circuit, the coil would not move, because the current would be continually changing direction, and there would be as much tendency to turn one way as the other. These instruments are, therefore, not suitable for alternating-current circuits, and

should never be connected to them. This is true of any class of instruments where a deflection is produced by the current reacting upon a constant magnetic field.

CLASSES OF INSTRUMENTS.

3936. For use in connection with alternating currents we are practically limited to four classes of instruments.

1. Hot-wire voltmeters.
2. Plunger ammeters and voltmeters.
3. Electrodynamometers (ammeters, voltmeters, wattmeters).
4. Electrostatic voltmeters.

The first class of instruments depend for their action upon the heating effect of the current. The commonest type of hot-wire voltmeter is the Cardew, which has been described in the section on Electrical Measurements. This instrument will indicate equally well on either direct or alternating current, and when it is calibrated with direct current, it will give the effective E. M. F. if connected to alternating-current mains.

3937. The hot-wire voltmeter may be used to measure current by connecting it across the terminals of a known non-inductive resistance, as shown at *R*, Fig. 1496. The

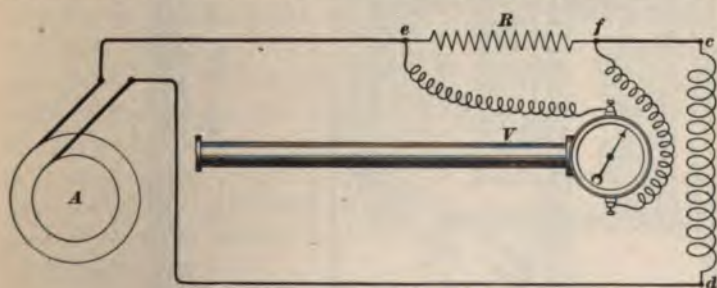

FIG. 1496.

voltmeter *V* in this case measures the drop from *e* to *f* through the resistance, this drop being equal to $\bar{C}R$; hence, if *R* is known, \bar{C} can be at once obtained, or the scale of the

instrument might be so marked as to give the current directly.

Hot-wire instruments, in order to be reliable, must be frequently recalibrated, as the heating and cooling seem to affect the wire, causing changes in the zero-point. On account of these defects, hot-wire instruments have been replaced by other types, which are better adapted for commercial work.

PLUNGER INSTRUMENTS.

3938. The plunger type of instrument is one which is used quite largely for ammeters and voltmeters in central

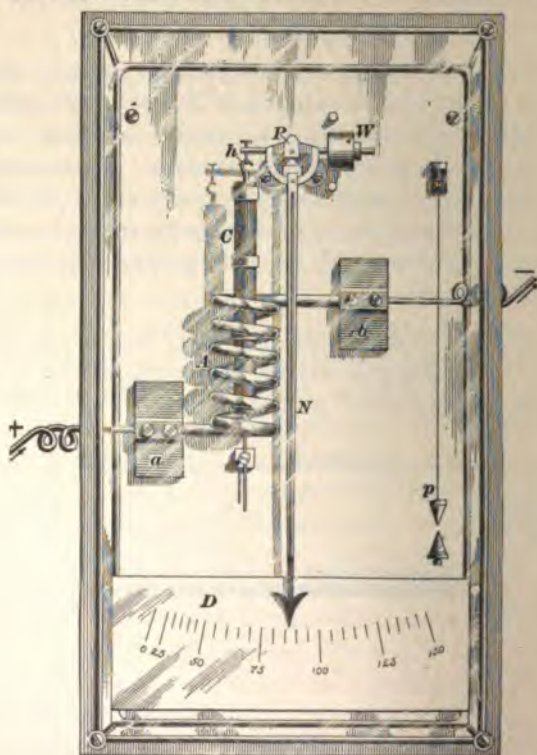

FIG. 1497.

stations, and a large number of switchboard instruments of this type are in use. Fig. 1497 shows a Westinghouse

plunger ammeter. In this instrument the conductor which carries the current does not act upon a magnetic needle, but upon a metal core C built of many strands of iron wire closely bound together. The current enters at the terminal block a , and passes through the solenoid A to the terminal b . The core is suspended by the hook h on the cross-arm P , which is supported on a knife-edge bearing. The weight of the core is balanced by the counterweight W , so that the needle N points to zero on the dial D . The plumb-bob p is used for leveling the instrument when setting it in position. With the variation in strength of current flowing through the coil, the pull on the plunger changes, consequently the needle is deflected.

3939. The plunger voltmeter, Fig. 1498, is similar in construction, but the coil A is made of fine wire and is connected in series with a resistance consisting of a great length of fine German-silver wire wound on sheets of insulating material and secured in the back of the case R . The terminals of the instrument are at a , b , and the path of the current is from a to the resistance coils, through the fuse F , and the coil A , to the terminal b .

3940. Some other styles of switchboard instruments in common use really belong to the

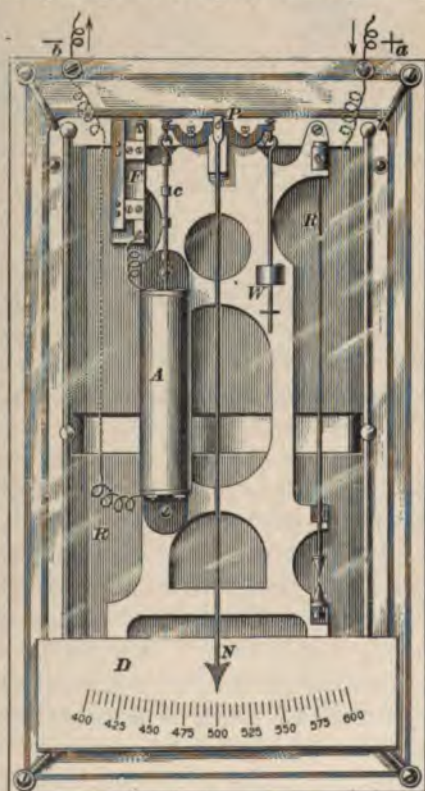

FIG. 1498.

plunger type, although they do not resemble the two just described. One of these, known as the Thomson inclined-coil instrument, is shown, in principle only, in Fig. 1499. A circular coil c , shown in section, is mounted with its axis inclined to the horizontal. Through the center of the coil passes a vertical shaft, which carries the pointer p . A small vane of iron v is mounted on the shaft at an angle, and the movement of the swinging system is controlled by the two flat spiral springs a, a' . When a current flows through the

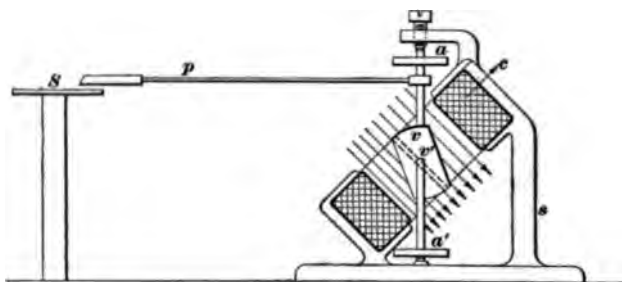

FIG. 1499.

coil, lines of force will thread it as shown by the arrows. The iron vane v will tend to turn so that it will lie parallel to these lines, as shown by the dotted lines v' , and in this way a reading is obtained.

3941. The principle of another instrument in common use is shown in Fig. 1500. A circular coil c is mounted in a horizontal position, with its center at the point d . A vertical shaft is pivoted with its center at d' to one side of d , and carries at the end of an arm a U-shaped piece of iron v which embraces the coil, as shown in detail in Fig. 1501. The movement of the needle is controlled by a small weight w , which takes the place of the springs in the preceding instrument. The action of the instrument is as follows: When a current flows through the coil, a magnetic field is set up which is stronger near the coil than at the center. The piece of iron v tends, therefore, to move nearer the inside of the coil, and the only way it can do this is by swinging around the center d' . This allows the iron

to approach the coil on account of d' being eccentric, and a deflection is thus obtained.

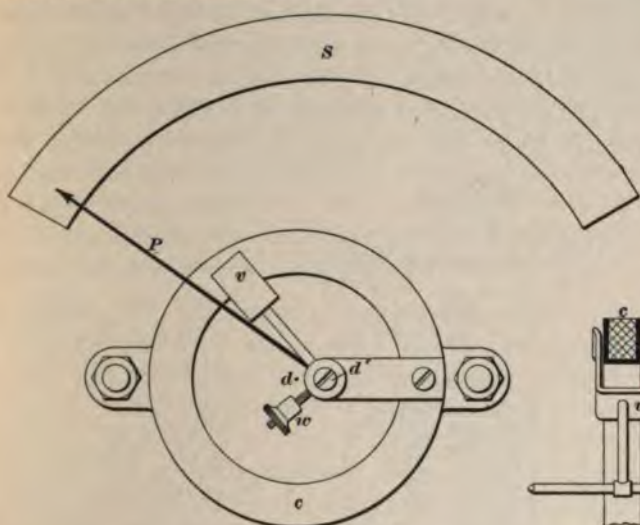

FIG. 1500.

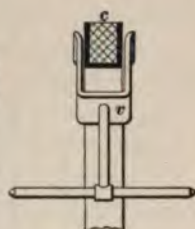

FIG. 1501.

Instruments of the plunger type will generally work on either direct or alternating current, but they must always be calibrated under the same conditions as those under which they are to be used. When intended for alternating-current circuits, they are always calibrated so as to read effective values.

ELECTRODYNAMOMETERS.

3942. The alternating-current instruments, which, on the whole, are the most reliable and widely used, belong to the third class. (See Art. **3936.**) In the class known as electro-dynamometers, the current in a swinging coil is acted upon by a magnetic field produced by a fixed coil. The field produced by the fixed coil changes with the changes in the current, the arrangement being somewhat similar to that used in the Weston direct-current instrument, except that the permanent magnet producing a constant field is replaced by a fixed coil producing an alternating field. Fig. 1502

shows a Siemens dynamometer, which is one of the commonest types in use. In this instrument a coil *A* is held by means of supports clamped to the frame, and at right angles to it is a coil *B*, which is free to swing a limited amount. This coil is held by a suspension, and the current is carried into it by means of two mercury cups *c, c'*, into which the ends of the coil dip. A spiral spring *d* has one end attached to the

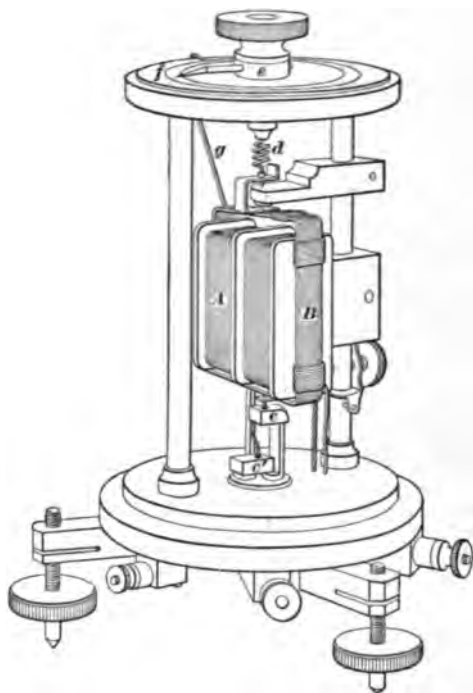

FIG. 1502.

coil and the other to the torsion head *e*. A pointer attached to this head moves over the circular scale *f*, and a second pointer *g* is attached to the swinging coil. When no current flows through the instrument, both pointers stand at the zero-point of the scale; but, on the passage of a current, the coil is deflected, its motion being limited to a small amount by stops not shown in the figure. When the instrument is to be used for measur-

ing E. M. F. or current, the swinging coil and fixed coil are connected in series, so that when a current flows, the field set up by the fixed coil changes in unison with the current in the swinging coil, thus producing a deflection. The swinging coil tries to assume a position parallel to the fixed coil, and the twisting action between the two is proportional to the product of the currents in the two coils. Since the coils are connected in series, the current must be the same in both; hence, in this case, the twisting

action, or torque, is proportional to the square of the current flowing through the instrument. After the swinging coil has been deflected, the torsion head is turned until the pointer attached to the coil comes back to the zero-point, and the reading on the circular scale is taken. From this reading the value of the current can be obtained by consulting a table or curve, giving the relation between currents and deflections, which has been previously obtained by sending continuous currents of known value through the instrument. If calibrated in this manner, it will give effective values when used with alternating current.

3943. The Siemens dynamometer, while not a direct-reading instrument, and on this account not as convenient to use as some others, is a very reliable instrument, because there are few things about it liable to change or get out of order. As a matter of fact, most of the instruments in commercial use are standardized by comparing them with a dynamometer. A Siemens dynamometer, in order to work satisfactorily, should possess a negligible amount of resistance and self-induction so that its insertion in any circuit will not have any appreciable effect on the current flowing in the circuit. A modification of the Siemens dynamometer is the Weston portable alternating-current voltmeter, which is constructed of such a pattern as to make it easily portable and also direct reading. Its construction is very similar to that of the Weston direct-current instruments, except that the permanent magnet is replaced by a pair of fixed coils, one on each side of the swinging coil and connected in series with it. The current is carried into the movable coil by means of flat spiral springs, which also serve to control its movement. The instrument reads directly in volts by a pointer attached to the swinging coil and moving over the scale.

WATTMETERS.

3944. In order to measure the power supplied in an alternating-current circuit, we must have an instrument which will indicate the real watts expended, i. e., one which will give deflections proportional to $\bar{C} \bar{E} \cos \Phi$. Such an

instrument is called a *wattmeter*, and has been mentioned in the description of practical instruments in Electrical Measurements.

A wattmeter must average up all the instantaneous values of the product of current and E. M. F.; consequently it must be so arranged that its indications will be affected by both. The dynamometer can easily be adapted to this work by changing the winding and connections of the swinging coil. Consider a circuit *ab*, Fig. 1503, in which energy is being expended, and suppose for the present that it is connected to a direct-current dynamo. The watts expended may, in this case, be easily obtained by connecting an ammeter *C* in series with the circuit, and a voltmeter *V* across it, so as to get the values of the current and E. M. F.,

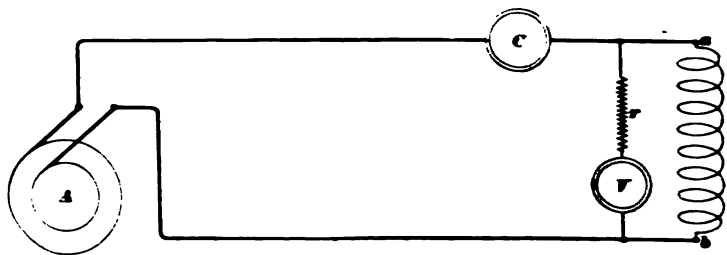

FIG. 1508.

the product of which gives the required watts. This method would not work, however, if the circuit were connected to an alternator *A*, as shown in the figure, because it would take no account of the phase difference in current and E. M. F. In order to do this, it is necessary to combine the ammeter and voltmeter into one instrument. This is done by winding the fixed coil of a dynamometer with a few turns of heavy wire and connecting it *in series* with the circuit, while the swinging coil is wound with a large number of turns of fine wire and connected *across* the circuit. It is usual to connect a non-inductive resistance *r* in series with the swinging coil, in order to limit the current flowing in it. Since the resistance of the swinging-coil circuit is constant, the current flowing through it will at all instants be pro-

portional to the E. M. F. acting on the circuit ab . The current in the fixed coil will also be equal to the current flowing in the circuit, hence the torque action between the two coils will at all instants be proportional to the product ec , and the average torque action will be proportional to the average watts. Such an instrument will, therefore, indicate the true value of the watts expended, because it takes account of the phase difference between the current and E. M. F.

3945. The Siemens wattmeter, like the dynamometer, is not direct reading, and is, therefore, not as convenient for commercial work as the portable direct-reading types, such as the Weston. It is, however, the standard wattmeter and the one which is used for calibrating other instruments, because, like the dynamometer, there are few parts about it to change or get out of order. Fig. 1504 shows a Weston

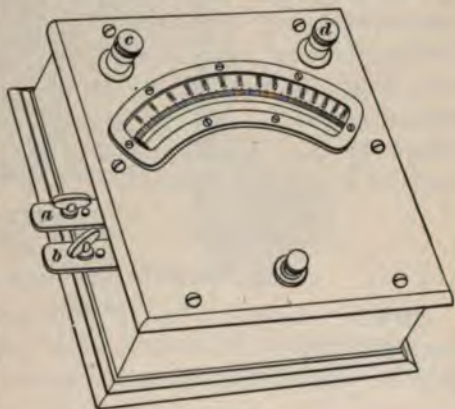

FIG. 1504.

portable wattmeter. This is constructed about the same as the voltmeter, except that the fixed coils are composed of a few turns of heavy copper conductor which carry the current. The heavy binding-posts a, b at the side of the case are the terminals of these current coils, and the small binding-posts c, d on the top connect with the swinging coil. In using wattmeters, care should be taken not to get the connections mixed, because if the current coil should, by mistake, be connected across the circuit, the instrument would in all probability be burnt out, as the resistance of this coil is very low and the resulting current would be enormous. In order that the readings of a wattmeter may

be reliable, the self-induction of the swinging coil should be very small. This is especially necessary if the instrument is to be used on a number of circuits having different frequencies. If the self-induction is high, the instrument will not read correctly for any other frequency than the one with which it was calibrated.

3946. Sometimes it is necessary to know the total amount of energy expended in a circuit during a given interval of time, as, for instance, in measuring the output of a station or the energy supplied to a consumer. For this purpose it is necessary to use a *recording wattmeter*, i. e., an instrument which will record the number of watt-hours electrical energy supplied during a given period. One of the commonest types of such an instrument is the Thomson recording wattmeter, already described in *Electrical Measurements*. This is really a modified Siemens wattmeter, arranged so that the moving coil revolves so long as current is passing through.

ELECTROSTATIC VOLTMETERS.

3947. Another class of voltmeter available for alternating-current work is that which depends upon the repulsion or attraction of two surfaces carrying electrostatic charges. Such instruments have been used most largely, in commercial work, for measuring high voltages, but instruments are also made on this principle which are quite capable of measuring low voltages. One type which is used for measuring high potentials is that brought out by Lord Kelvin, and illustrated in Fig. 1505. A set of fixed quadrants a, a', b, b' is mounted so that the aluminum vane v, v' may swing between them on the pivot d . The fixed set of quadrants is connected to one side of the circuit and the swinging vane to the other, so that when they become charged, the vane is attracted and drawn in between the quadrants, and the voltage is indicated by the pointer. These voltmeters have the advantage that they require no

current whatever for their operation. This is sometimes of importance, especially when the instrument is connected to

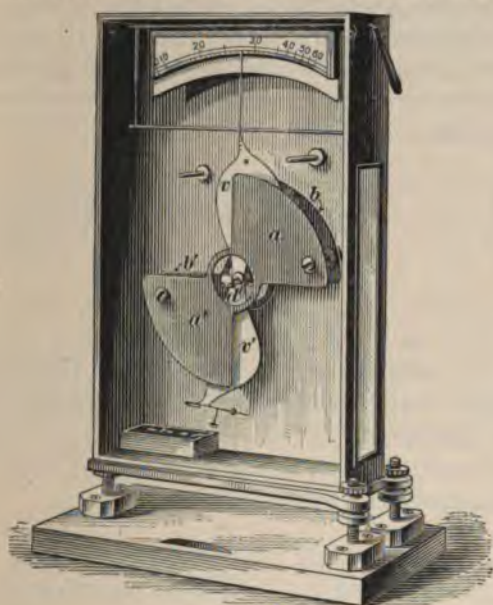

FIG. 1505.

a high potential circuit and left connected continuously. A very small current in such a case might represent a considerable loss of energy.

POWER MEASUREMENT.

THREE-VOLTMETER METHOD.

3948. There are other methods of measuring power which do not involve the use of a wattmeter, and which are therefore convenient when no other instruments but ammeters and voltmeters are obtainable. One of these, known as the **three-voltmeter method**, is shown in Fig. 1506. The circuit in which the power expended is to be measured is shown by bc . A non-inductive resistance R is connected in series with bc , so that the current flowing through R is the

same as that flowing through the circuit in question. Readings are then taken of the three pressures \bar{E}_1 , \bar{E}_2 , \bar{E} , which are the pressures respectively across the circuit, the non-inductive resistance, and LC combined. If the resistance R is properly chosen, it is often possible to get these three

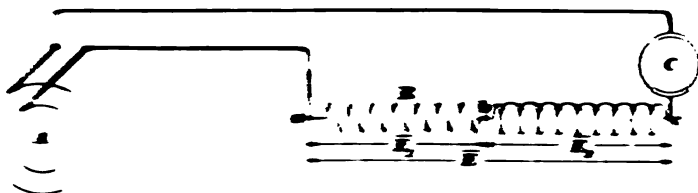

FIG. 100.

readings with one voltmeter without going beyond the range of the instrument, by having an arrangement for switching the voltmeter into the different parts of the circuit to be measured. At any instant during a cycle, the sum of the instantaneous values of \bar{E}_1 and \bar{E}_2 must be equal to the instantaneous value of \bar{E} , or

$$e = e_1 + e_2$$

where e , e_1 , and e_2 represent instantaneous values of E. M. F. Then,

$$e^2 = e_1^2 + 2e_1e_2 + e_2^2,$$

or

$$2e_1e_2 = e^2 - e_1^2 - e_2^2.$$

The instantaneous watts supplied to the circuit bc would be

$$w = e_2 \times i,$$

where i is the instantaneous value of the current. But ab is a non-inductive resistance, and the current in it must be in phase with the E. M. F. Hence, if e_1 is the drop through R at the instant the current is i , i must be equal to $\frac{e_1}{R}$, and the instantaneous watts must be

$$w = \frac{e_1}{R} e_2.$$

But

$$e_1 e_2 = \frac{e^2 - e_1^2 - e_2^2}{2}.$$

hence the watts at any instant are

$$w = \frac{1}{2R} (e^2 - e_1^2 - e_2^2),$$

and the average power supplied will be

$$\text{average } w = \frac{1}{2R} (\text{av. } e^2 - \text{av. } e_1^2 - \text{av. } e_2^2).$$

The readings of the voltmeter are, however, the $\sqrt{\text{av. } e^2}$ values; consequently the power expended must be given by the expression

$$W = \frac{1}{2R} (\bar{E}^2 - \bar{E}_1^2 - \bar{E}_2^2). \quad (641.)$$

In some cases it might be more convenient to measure the current by means of an ammeter C than to determine the value of the resistance R . In this case since

$$\bar{C} = \frac{\bar{E}_1}{R}, \text{ or } \frac{1}{R} = \frac{\bar{C}}{\bar{E}_1},$$

$$W = \frac{\bar{C}}{2\bar{E}_1} (\bar{E}^2 - \bar{E}_1^2 - \bar{E}_2^2). \quad (642.)$$

The three-voltmeter method is quite frequently used for measuring power, but it is not, in general, as accurate in its results as the wattmeter, and the latter is, therefore, always used when available. It will be noticed in formula 642 that all the voltmeter readings are squared; consequently, if a slight mistake is made in the observations, the error in the result may be quite large.

THREE-AMMETER METHOD.

3949. Another method of measuring power similar to the above, and known as the **three-ammeter method**, is shown in Fig. 1507. In this case the non-inductive resistance c d is connected in parallel with the circuit under test, and readings are taken of the current in the resistance, in the circuit under test, and in the main circuit. Let \bar{C} be the current in the main circuit, \bar{C}_1 in the resistance, and \bar{C}_2 in

the circuit in which the power expended is to be measured. Then the watts are given by the formula

$$W = \frac{R}{2} (\bar{C}^2 - \bar{C}_1^2 - \bar{C}_2^2), \quad (643.)$$

where R is the value of the non-inductive resistance.

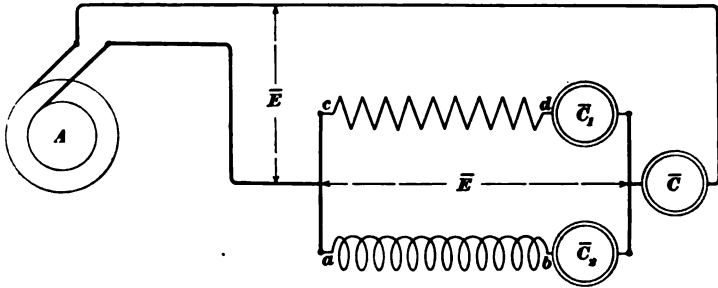

FIG. 1807.

The student can work out the proof of this, as it is similar to that for the three-voltmeter method. If the voltage \bar{E} is known, the formula may be written

$$W = \frac{\bar{E}}{2\bar{C}_1} (\bar{C}^2 - \bar{C}_1^2 - \bar{C}_2^2), \quad (644.)$$

in which case it is not necessary to know the value of the resistance R . This method is also open to the same objections as the three-voltmeter method, but it is well to bear both in mind, as they may often be of value when wattmeters of the proper range are not at hand.

SINGLE-PHASE ALTERNATORS.

GENERAL CHARACTERISTICS.

3950. Dynamo-electric machines used for the generation of alternating E. M. F.'s are known as **alternators**. It has already been shown in the section on Applied Electricity that the E. M. F. generated in the armature of a direct-current dynamo is essentially alternating, and that

nal to the E. M. F. acting on the circuit ab . The fixed coil will also be equal to the current in the circuit, hence the torque action between the coils will at all instants be proportional to the product of the current and the average torque action will be proportional to the average watts. Such an instrument will, therefore, indicate the true value of the watts expended, because it takes account of the phase difference between the current and the E. M. F.

3945. The Siemens wattmeter, like the dynamometer, does not direct reading, and is, therefore, not as convenient for commercial work as the portable direct-reading types, such as the Weston. It is, however, the standard wattmeter and the one which is used for calibrating other instruments, because, like the dynamometer, there are few parts about it to change or get out of order. Fig. 1504 shows a Weston

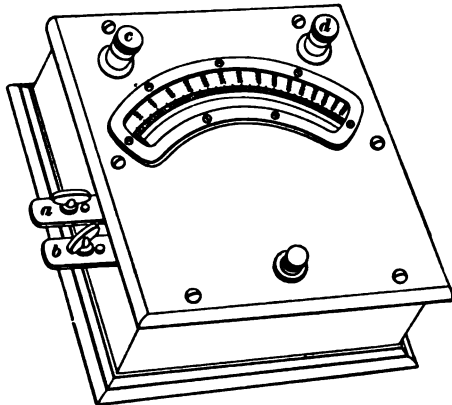

FIG. 1504.

portable wattmeter. This is constructed about the same as the voltmeter, except that the fixed coils are composed of a few turns of heavy copper conductor which carry the current. The heavy binding-posts a, b at the side of the case are the terminals of these current coils, and the small binding-posts c, d on the top connect with the swinging coil. In using wattmeters, care should be taken not to get the connections mixed, because if the current coil should, by mistake, be connected across the circuit, the instrument should in all probability be burnt out, as the resistance of coil is very low and the resulting current would be enormous. In order that the readings of a wattmeter may

through the distance $a b$. This E. M. F. curve may be of the shape shown in Fig. 1509, the portion at y being fairly uniform while the conductors are moving under the poles; or it may have a different shape, depending upon the shape of the coil and pole-pieces as well as upon the way in which the magnetic lines are distributed. No matter what the shape of the curve $a y b$ may be, the E. M. F. passes through one alternation when the coil is moved a distance equal to that from the center of one pole to the center of the next. If the coil C be moved back from S to N , the same set of values of the E. M. F. is generated in the opposite direction; hence, by moving the coil from N to S and back, the E. M. F. passes through one complete cycle as shown in Fig. 1510. The arrangement shown in Fig. 1508 would, therefore, constitute an elementary alternator, and the E. M. F. would be set up by movements of the coil back and forth across the pole

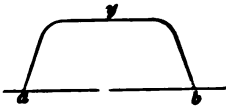

FIG. 1509.

faces, there being no rotation at all. Instead of moving the coil back and forth, the same effect could be produced

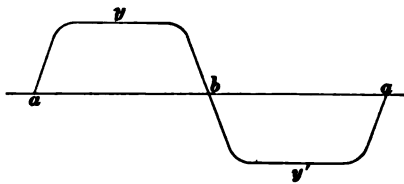

FIG. 1510.

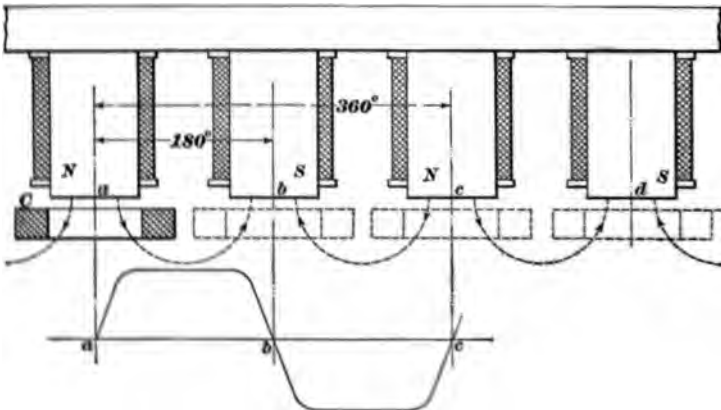

FIG. 1511.

faces, there being no rotation at all. Instead of moving the coil back and forth, the same effect could be produced

by moving the coil forwards continuously in front of a row of poles, as shown in Fig. 1511. As the coil C moves past the poles, it cuts the lines of force first in one direction and then in the other, thus producing the alternating E. M. F. represented by the curve below. It should be noted that while the coil moves through the distance between one north pole and the next pole of the same polarity, the E. M. F. passes through one complete cycle. The distance from a to c , therefore, corresponds to 360° on the E. M. F. curve, and $a b$ to 180° . For every pair of poles passed, the E. M. F. passes through a complete cycle of values; hence it follows that the number of cycles per second, or the frequency of an alternator, is equal to the number of pairs of poles which the armature winding passes per second. If the number of poles on the machine is P , the number of pairs of poles is $\frac{P}{2}$, and if the coil is moved past the poles s times per second, the frequency n will be

$$n = \frac{P}{2} s. \quad (645.)$$

3951. Instead of the single coil C , Fig. 1511, being used by itself, three other coils, shown dotted, might be connected in series or parallel with C , and the whole four moved together in front of the poles. If the coils were connected in series, it is evident that the total E. M. F. produced would be increased, because all the E. M. F.'s generated in the turns of the different coils would be added up. If they were connected in parallel, the E. M. F. would be the same as that produced by the single coil, but the current-carrying capacity would be increased, because there would now be four circuits to carry the current in place of one. It should be noted particularly that no matter how many coils there are, or how they are connected together, the frequency remains the same so long as the speed s and the number of poles is constant. In other words, the frequency of an alternator does not depend upon the way in which the armature is wound.

Connecting the coils in series is equivalent to making the winding of each of a large number of turns; connecting them in parallel amounts to the same thing as winding in one coil with a heavy conductor. As long, therefore, as the coils are all rotated simultaneously, as is always the case, the frequency is not affected in any way by the scheme adopted for winding and connecting up the armature.

3952. It is evident that an alternating E. M. F. would be set up in the coil or set of coils, Fig. 1511, if the magnet were moved and the coils held stationary. Also, both coils and magnet might be stationary and an E. M. F. still be induced by causing the lines of force threading the coils to vary. These three methods give rise to the following three classes of alternators:

1. Those in which the armature coils are moved relatively to the field-magnet.
2. Those in which the field is moved relatively to a fixed armature.
3. Those in which the magnetic flux passing through a fixed set of coils is made to vary by moving masses of iron, called *inductors*, past them.

For convenience in referring to alternators, we will suppose that the armature is the revolving part and the field fixed, though it must be remembered that actual machines may be built with any of the three arrangements mentioned above.

CONSTRUCTION OF ALTERNATORS.

3953. The commonest type of alternator is that in which the coils are mounted on a drum and revolved in front of a magnet consisting of a number of radial poles. Alternator armatures may be of the ring, drum, or disk type, but the drum style is used almost exclusively in America. If we suppose the poles, Fig. 1511, bent into a circle and the coils mounted upon a drum revolving within the poles, we will have one of the commonest types of alternators. This arrangement is shown in Fig. 1512, except

that in this case the machine is provided with eight radial poles and eight coils on the armature, giving a style of winding in common use for machines used on lighting circuits. In this case there are as many coils on the armature as there are poles on the machine; but a winding might easily be used in which there would be only half as many coils as poles. There is a large variety of windings suitable for

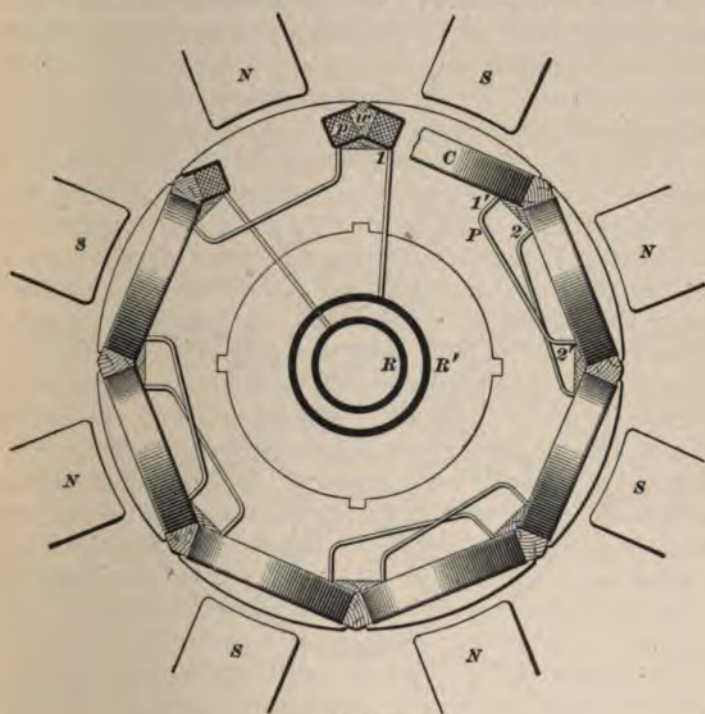

FIG. 1512.

alternators, and the designer has to select the one best suited to the work which the machine has to do. In Fig. 1512 the coils *C* are shown bedded in the slots *p* on the circumference of the iron core *P*, which is built up of thin iron stampings. These coils are heavily taped and insulated and are secured in place by hardwood wedges *w*. This makes a style of armature not easily injured, and the use of the dovetailed

slots and wooden wedges does away with the necessity of band wires. As the armature revolves, the coils sweep past the pole faces, and the E. M. F. is generated in the same way as in the case shown in Fig. 1511, i. e., the movement of the coils relative to the pole-pieces becomes one of translation rather than of rotation.

3954. Alternators are generally required to furnish a high voltage, and, in consequence, the armature coils are

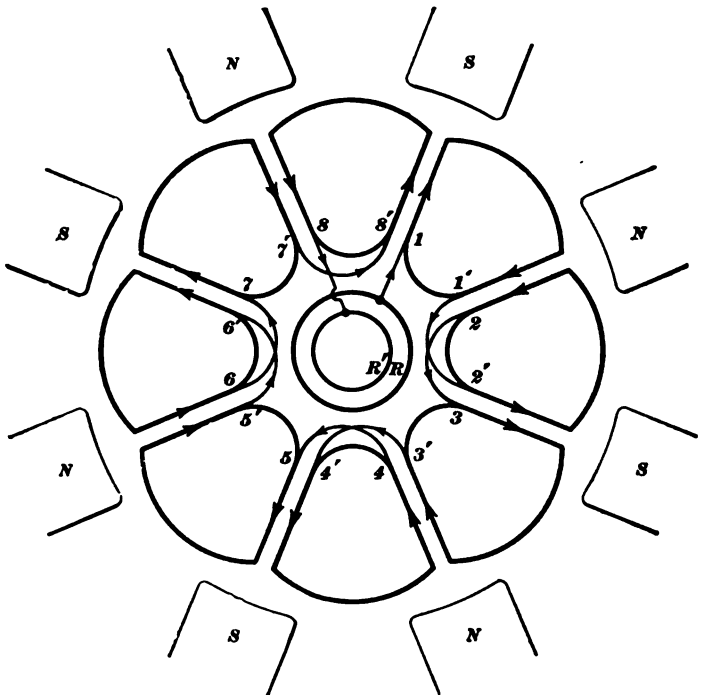

FIG. 1513.

usually connected in series. Care must be taken in connecting up such windings to see that the coils are so connected that none of the E. M. F.'s oppose one another. By laying out a diagram of the winding, the manner in which the coils must be connected will be easily seen. This has been done in Fig. 1513, which shows diagrammatically the winding of

the armature in Fig. 1512. The coils are represented by the heavy sector-shaped figures, and the connections between them by the lighter lines. The circles in the center represent the collector rings of the machine, and the radial lines that part of the coil which lies in the slot, that is, the part in which the E. M. F. is generated. The circular arcs joining the ends of the radial lines represent the ends of the coils which project beyond the laminated armature core. The drawing is made to show the coils at the instant the conductors in the slots are opposite the centers of the pole-pieces. At this instant the E. M. F. will be assumed to be at its maximum value, and we will suppose that the direction of rotation is such that the conductors under the north poles have their E. M. F.'s directed from the back of the armature towards the front. These E. M. F.'s will be denoted by an arrow-head pointing towards the center of the circle, since the inner end of the radial lines represents the front or collector-ring end of the armature. The E. M. F.'s in the conductors under the south poles must be in the opposite direction, or pointing away from the center. After having marked the direction of these E. M. F.'s, it only remains to connect the coils up so that the current will flow in accordance with the arrows. Starting from the collector ring R , and passing through the coils in the direction of the arrows, it is seen that the connections of every other coil must be reversed; i. e., if $1, 1', 2, 2'$, etc., represent the terminals of the coils, $1'$ and $2'$ must be connected together, also 2 and 3 , and so on. The end 3 is connected to the other collector ring and the winding thus completed. The connections of such a winding are quite simple; but if not connected with regard to the direction of the E. M. F.'s, as shown above, the armature will fail to work properly. For example, if $1'$ were connected to $2, 2'$ to 3 , and so on around the armature, the even-numbered coils would exactly counterbalance the odd-numbered ones, and no voltage would be obtained between the collector rings. Of course, in this case all the coils are supposed to be wound in the same direction, as is nearly always done in practice. The connections shown in

the diagram, Fig. 1513, are shown between the coils in Fig. 1512. It should be noted, in passing, that this constitutes an open-circuit winding; that is, the winding is not closed on itself, like that of a continuous-current drum or ring armature. A large number of alternator windings are of the open-circuit type, which is better adapted for the production of high voltages, because it admits of a large number of turns being connected up in series.

3955. Most alternating-current dynamos of the revolving-armature and stationary-field type are built on much the

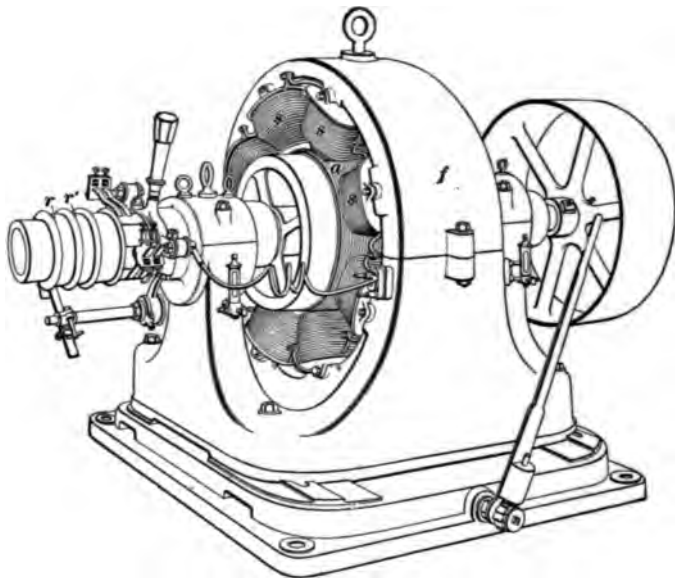

FIG. 1514.

same lines as direct-current multipolar machines. Usually, however they have a larger number of poles. Fig. 1514 shows a common type of alternator with revolving armature a and stationary field f , with inwardly projecting poles, on which are placed the spools s . This is an eight-pole machine with an armature winding similar to that shown in the diagram, Fig. 1513. The two collector rings r , r' are seen mounted on the end of the shaft outside the bearing, and

are connected to the armature winding by heavily insulated leads passing through a hole in the shaft. Some machines have the collector rings on the armature side of the bearing, thus avoiding the necessity of bringing the wires through the shaft, but making the distance between the centers of the bearings greater.

3956. The number of poles on these machines is made large, in order to obtain the necessary frequency without running the machine at too high a speed. It is evident from what has been pointed out in Art. **3950** that for every revolution of the armature the E. M. F. passes through as many complete cycles as there are pairs of poles, and the frequency was shown to be $n = \frac{P}{2} s$, where P = number of poles, and s = revolutions of the armature per second.

If we represent the number of *pairs of poles* by p ,

$$n = p \times s, \quad (646.)$$

or

$$s = \frac{n}{p}. \quad (647.)$$

Therefore, with a given frequency n , the number of poles must be made large if the speed s is to be kept down. For example, if an alternator has 8 poles and runs at a speed of 900 rev. per min., its frequency will be $\frac{8}{2} \times \frac{900}{60} = 60$ cycles per sec. If we attempted to obtain a frequency of 60, which is a very common one, by using a two-pole machine, its speed would have to be $s = \frac{60}{1}$, or 60 rev. per sec., or 3,600 rev. per min., a speed altogether too high for a machine of any size.

3957. It follows from the above that if the frequency is fixed, as it usually is, and it is desired to run an alternator at a given speed, it must be made with such a number of poles P that the condition $n = p \times s$ will be fulfilled. Alternators are often required to run at a specified speed in cases where they are to be coupled directly to water-wheels or engines. This leads to the designing of a large number of

special machines suited to these conditions, because alternators, on account of the relation which must be preserved between frequency, speed, and number of poles, can not be adapted to different conditions of speed and voltage by changing the armature winding, as is done with direct-current machinery. The number of poles used on commercial machines varies greatly, as there is a wide range of frequencies and speeds to be met. Alternators are built with the number of poles varying all the way from 4 up to 60 or 80 and sometimes more. The number of poles usually increases with the size of the machine, because the speed of the larger dynamos is necessarily less than that of the smaller. The Westinghouse 1,200 K. W. alternator may be mentioned as an example of a large machine adapted for direct connection to a steam-engine. This alternator has 40 poles and runs at a speed of 180 R. P. M., thus delivering current at 60 cycles. The number of poles, the output, and speed of some of the smaller sized machines are given below:

TABLE 115.
ALTERNATORS.

No. Poles.	60 Cycle.		No. Poles.	125 Cycle.	
	Output K. W.	Speed R. P. M.		Output K. W.	Speed R. P. M.
8	75	900	10	30	1,500
12	150	600	14	120	1,070
16	250	450	16	200	940

3958. The E. M. F. curve furnished by an alternator of the type shown in Fig. 1514 would not follow the sine law. Such machines, with heavy coils embedded in slots, usually give a curve which is more or less peaked and ragged in outline, and are best adapted for lighting work. For purposes of power transmission it is desirable to have a machine giving a smooth E. M. F. wave, and this can be obtained

by adopting the proper kind of winding for the armature. The advantages and disadvantages of the different windings will be taken up in connection with alternator design, attention being paid here to the principles governing the generation of the E. M. F. and the connecting up of the armature coils.

3959. The distance $e f$, Fig. 1515, from the center of one pole-piece to the center of the next is called the **pitch** of the alternator. The relation between the pitch and the width of pole face A varies in different makes of machines, but in a large number of American alternators the distance B between the poles is made equal to the width of pole face A or $\frac{1}{2}$ the pitch, and the pole-pieces cover 50% of the armature. The shape of the E. M. F. curve is determined largely by the relative shape of the coils and pole-pieces and the way in which the conductors are disposed on the surface of the armature.

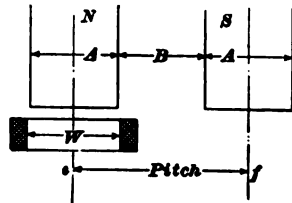

FIG. 1515.

The width of the opening W in the coil should not in general be much less than the breadth of the pole-piece A . It has been found that it may be slightly less without doing any harm; but if made too narrow, trouble is likely to arise owing to the E. M. F.'s induced in different conductors of the same coil being opposed to each other, thus cutting down the total E. M. F. generated.

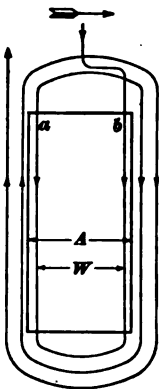

FIG. 1516.

This will be seen by referring to Fig. 1516, where a coil of three turns is shown with its width of opening W less than the polar width A . When the coil moves across the pole face in the direction of the arrow, the E. M. F.'s induced in the two conductors a and b will both be in the same direction, because they both cut lines of force in the same way. The consequence is that these two

E. M. F.'s oppose each other, as will be readily seen by following the arrow-heads. When an alternator is loaded, the armature reaction causes the magnetism to crowd more or less towards one side of the poles, thus practically reducing the width of the magnetic flux, and on account of this it has been found possible to make the width W a little less than A without bad results. Usually, however, the width of the opening is nearly equal to that of the pole face.

CALCULATION OF E. M. F. GENERATED BY ALTERNATORS.

3960. It has already been shown (Art. 3882) that the effective E. M. F. induced in a coil, when a magnetic flux N is made to vary through it according to the sine law, is

$$\bar{E} = \frac{4.44 N T n}{10^8}.$$

This is the case in an alternator producing a sine E. M. F. The flux N , which is caused to vary through the coils by the motion of the armature, is the number of lines flowing from one pole-piece; T is the total number of turns on the armature connected in series; and n is the frequency. This formula may be easily proved by remembering that the average volts = average number of lines of force cut per second $\div 10^8$.

- Let s = revolutions per second;
 p = number pairs of poles;
 $2p$ = number of poles;
 N = number of lines flowing from one pole;
 T = number of turns in series;
 $2T$ = number of conductors in series.

Each conductor cuts an average of $2pN$ lines per revolution, or $2pNs$ lines per second; hence,

$$\text{average E. M. F.} = \frac{2pNs \times 2T}{10^8} = \frac{4NTps}{10^8}.$$

But $p \times s$ = frequency = n ;

hence, $\text{average E. M. F.} = \frac{4NTn}{10^8}.$

The effective E. M. F. is 1.11 times the average; therefore,

$$\bar{E} = \frac{4NTn \times 1.11}{10^9} = \frac{4.44NTn}{10^9}; \quad (648.)$$

or, *the effective E. M. F. generated by an alternator is equal to 4.44 times the product of the number of lines flowing from one pole, the number of turns connected in series, and the frequency, divided by 10^9 .*

3961. Formula **648** gives the effective E. M. F. at the collector rings when the alternator is run without any load, i. e., on open circuit. If the machine be loaded, the E. M. F. at the terminals will fall off from the value given by the above equation. This formula gives the total effective E. M. F. generated only when the turns T which are connected in series are so situated as to be simultaneously affected by the changes in the magnetic flux. This means that the conductors must be bunched together into heavy coils like those shown in Fig. 1512 if the maximum effect is to be obtained. If the winding were spread out over the surface of the drum, as is done in direct-current armatures, the E. M. F. in one set of conductors would not rise to its maximum value until after the E. M. F. in the preceding set. For example, suppose we had an alternator wound with flat pan-cake coils as shown in Fig. 1517. The

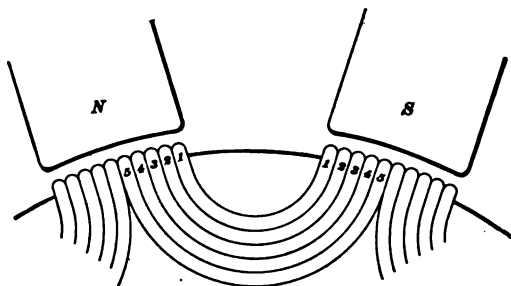

FIG. 1517.

coil is here spread out to a certain extent, and the E. M. F.'s in the different turns would be slightly out of phase with each other, because they would not all come into

and go out of action at the same instant. The total E. M. F. generated by such a coil would be the resultant sum of the E. M. F.'s generated in the different turns, and the more these separate E. M. F.'s are thrown out of phase by spreading out the coil, the smaller would be the resultant terminal E. M. F. obtained. If the five turns of the coil shown in Fig. 1517 were placed together in a slot, they would all be affected by the magnetic flux at practically the same instant. Hence, for a given length of active armature conductor, *concentrated* windings produce the maximum E. M. F. at no load, and if the winding is *distributed*, the terminal E. M. F. at no load is lowered. Both kinds of winding have their advantages and disadvantages, which will be taken up in connection with alternator design. For the present the student will please bear in mind that formula 648 gives the E. M. F. when the machine is running on open circuit and when the winding is so concentrated that all the conductors pass into and out of action simultaneously.

3962. The E. M. F. obtained at the terminals or collector rings of the alternator may be considerably less than that given by formula 648 when the machine is loaded, because a portion of the E. M. F. generated will be used up in forcing the current through the armature against its resistance, and some of the E. M. F. will also be necessary to overcome the self-induction. In the case of a direct-current dynamo, the pressure obtained at the brushes for any given load is equal to the total pressure generated less the pressure necessary to overcome the resistance of the armature. If C is the current and R_a the armature resistance, the lost volts are $C R_a$, and the pressure at the brushes is $E_b = E - C R_a$, where E is the total voltage generated. In the case of an alternator, the voltage at the terminals may fall off greatly as the load is increased, on account of the armature self-induction, the falling off being much greater than that accounted for by the resistance. The effects of armature self-induction will best be understood by referring to Figs. 1518 and 1519. The alternator is supposed to be run at a

constant speed with a constant strength of field; the *total E. M. F. generated* in the armature will therefore be constant, because the rate at which lines of force are cut does not

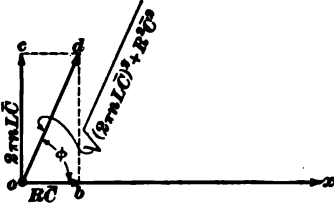

FIG. 1518.

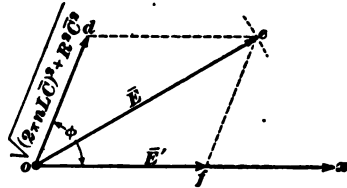

FIG. 1519.

change, no matter what current is taken from the machine. We will suppose that the alternator is working upon a non-inductive load, such as incandescent lamps, and we will represent the current in the external circuit by the line ox , Fig. 1518. The E. M. F. necessary to overcome the armature resistance will be represented by ob in phase with the current ox and equal to $R_a \bar{C}$; the E. M. F. necessary to overcome the armature reactance $2\pi n L \bar{C}$ will be represented by oc 90° ahead of the current; and the total E. M. F. necessary to overcome both resistance and reactance will be $od = \bar{C} \sqrt{R_a^2 + (2\pi n L)^2}$, Φ° ahead of the current in phase. The resultant sum of this E. M. F. od and the E. M. F. obtained at the terminals of the alternator must always be equal to the total E. M. F. generated \bar{E} , which is of fixed value so long as the speed and field excitation remain constant. Since the alternator is working on a non-inductive load, the terminal voltage \bar{E}' must be in phase with the current and in the same direction as the current line ox , Fig. 1519. The line od , Φ° ahead of ox and equal to od , Fig. 1518, represents the amount and direction of the E. M. F. to overcome the armature impedance. Hence the total E. M. F. \bar{E} must be the diagonal of a parallelogram which has its sides parallel to od and ox , and of which od is one side. The value of the terminal E. M. F. \bar{E}' must therefore be of , and it will be noticed that it is considerably less than the E. M. F. \bar{E} . By examining these two diagrams, it will be seen that if the inductance of the armature is large compared with

the resistance, the line od will be long and the angle Φ nearly 90° . Consequently, the terminal E. M. F. \bar{E} obtained from a given E. M. F. \bar{E} will be very small. If sufficient current is taken from a machine with large armature self-inductance, the terminal E. M. F. may fall to zero; that is, all the voltage generated is used up in overcoming the impedance of the armature, and we have practically a wattless current flowing.

3963. Alternators having high armature self-inductance may be short-circuited without much danger of burning them

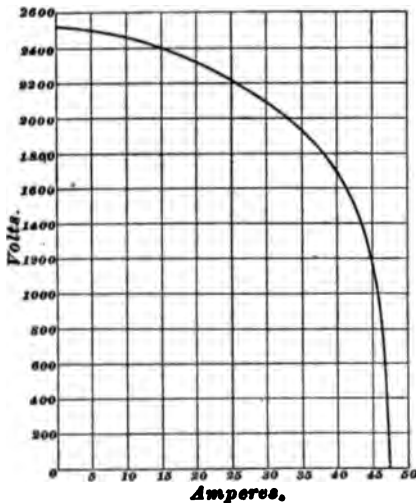

FIG. 1520.

out. When a machine of this kind is short-circuited the current does not rise to a very large amount, as with direct-current machines, because the voltage generated is required to overcome the inductance, and is unable to set up a large current. As the load is increased, the E. M. F. falls off at first slowly and then more rapidly, until, when a certain current is reached, the terminal E. M. F. has dropped to zero, and no

further increase in current can take place. This is illustrated by Fig. 1520, which shows a curve taken from an alternator with an armature of fairly high self-induction. The normal full-load current of this machine is 25 amperes, and it is seen that as the load is increased, the terminal voltage keeps falling off, until at short circuit the current is about 47 amperes and the terminal voltage zero. Such a machine would probably not be injured by a short circuit, because it would be able to carry a current of 47 amperes for some time without dangerously overheating the armature.

3964. The student will see from the above that the output of an alternator may be limited if the armature self-induction is too high, because the voltage may drop off before the machine is delivering the current which it is capable of doing without overheating. The output of alternators is, of course, affected by the heating of the armature conductors, just as in the case of direct-current machines, and the output is in most cases limited by this effect rather than by the self-induction.

EXAMPLES FOR PRACTICE.

1. If an alternator is to run at 1,200 R. P. M. and to give a frequency of 60 cycles per second, how many poles must it have? Ans. 6.
2. How many poles should a 60-cycle alternator have if it is desired to couple it directly to a water-wheel running 225 R. P. M.? Ans. 32.
3. A ten-pole alternator runs at the rate of 1,500 R. P. M. The armature is provided with ten coils of 40 turns each, connected in series, and the flux through each pole is 1,000,000 lines. What E. M. F. will the machine give at the collector rings when running on open circuit? Ans. 2,220 volts.

FIELD EXCITATION OF ALTERNATORS.

3965. In most alternating-current systems, the voltage at the points where the current is distributed is kept constant, or nearly so. This means that the voltage at the terminals of the alternator must, as a rule, rise slightly as the load comes on, the amount of rise depending upon the loss in the line. At any rate, the voltage at the terminals must not drop off, and, as it has been shown above that, with constant field excitation, the voltage will fall off with the load, it becomes necessary to increase the strength of the field-magnets as the current output of the machine increases. For accomplishing this there are two methods in use, which are analogous to those employed for the regulation of shunt and compound wound continuous-current machines.

3966. The simplest method is that indicated by the diagram, Fig. 1521. *W* represents the armature winding,

the terminals T , T' of which are connected to the collector rings R , R' , connecting to the line by means of the brushes g , h . The field is excited by a set of coils on the pole-pieces represented by C , and current is supplied to these from a small continuous-current dynamo or exciter E . This is a small shunt-wound machine with an adjustable field rheostat r in its shunt field f . An adjust-

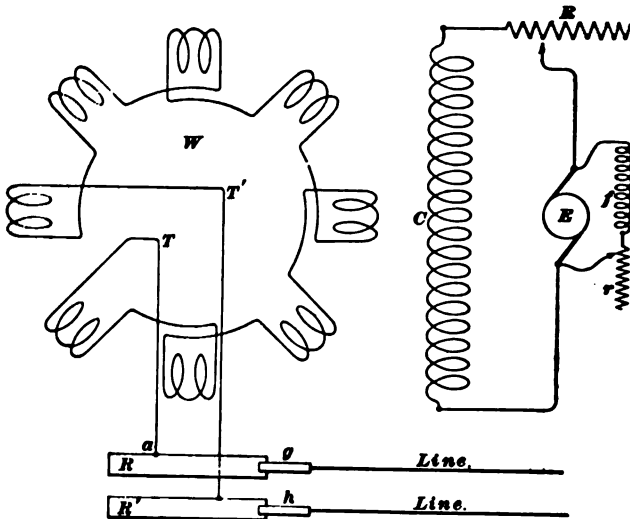

FIG. 1521.

able rheostat R is placed also in the alternator field circuit. When the voltage drops, the fields may be strengthened by adjusting the resistances R and r . This method, which is that used with plain separately excited alternators, serves to keep the voltage right, and may be used with advantage when a number of alternators are supplied from one exciter; but it is a hand method, and is therefore objectionable if the load varies much.

3967. The second method, shown in Fig. 1522, varies the excitation of the field in proportion to the current which the machine is supplying, and thus keeps the voltage up automatically. Each field coil in this case consists of two windings similar to those used on compound-wound

continuous-current dynamos. One set of windings is separately excited by means of the exciter E , and is provided with a rheostat R , as in the previous case. The field of the exciter is also provided with a rheostat r . The greater part of the current furnished by the alternator flows through the series winding represented by the heavy coil S ; and since this causes the magnetism to increase, the machine maintains its voltage. The separately excited coils set up the

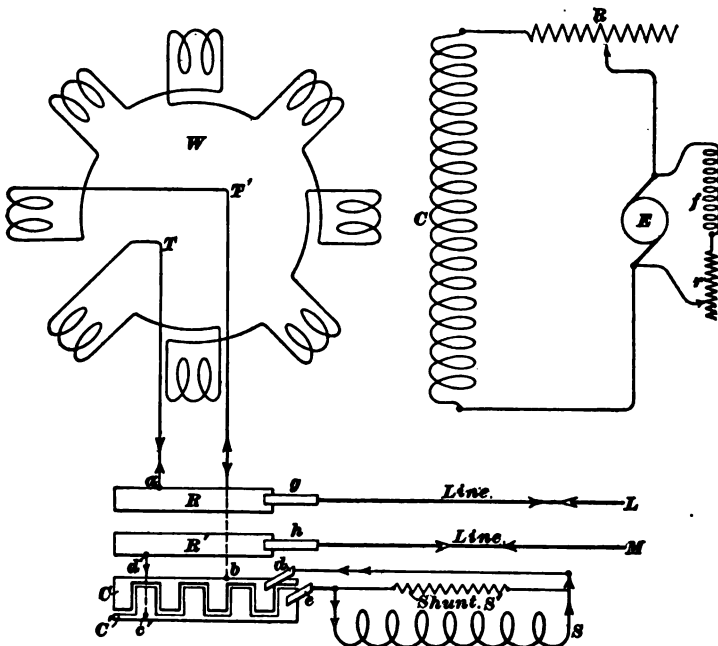
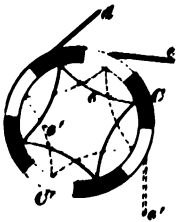

FIG. 1522.

magnetism necessary for the generation of the voltage at no load, and the series coils furnish the additional magnetism necessary to supply the voltage to overcome the armature impedance.

3968. The current flowing in these series coils must not be alternating, because if it were it would tend to strengthen the poles one instant and reverse them the next,

and on this account the current must be *rectified* before being sent around the field. This is accomplished by means of the commutator, or **rectifier**, CC' , which is mounted on the shaft alongside the collector rings. It consists of two castings C, C' (shown developed in the figure), which are fitted together and form a commutator of as many sections as there are poles in the machine. The alternate sections are connected together by the conductors c, c' , as shown in Fig. 1523, the light sections belonging to one casting C and the dark to the other C' . Two brushes d and e which press on the commutator are so arranged that one is always in contact with C , while the other touches C' . The connections are as shown in the diagram. One terminal T of the armature winding connects directly to the ring R and thence to the line. The other terminal T' connects to



one side of the rectifier C , and the other side C' is connected to the remaining ring R' . By following the direction of the current, it will be seen that while the rectifier causes the current to flow in the same direction in the series coils S , it still remains alternating in the line circuit. Take the instant when the coils occupy such a position that the current is flowing out from the terminal T , and mark the direction of flow in the different parts of the circuit by the closed arrow-heads. The current will flow out on the line L , back on M to C' , through S , flowing from left to right, back to C , and thence back to the armature. When the armature has turned through a distance equal to that between two poles, the current will be flowing in the opposite direction, as indicated by the open arrow-heads; that is, it will be flowing out from T' to C , from C it will go to the brush e instead of d , because it must be remembered that the rectifier has turned through the same angle as the armature, and hence d has slid from C on to C' . From e the current flows through S in the same direction as before back to C' , out on the line M , and back on L to T . The action of the rectifier is, briefly, to keep changing the connections of

d and e as the current changes, thus keeping the current in S in the same direction while it remains alternating in the line. Usually the brushes d, e are placed on the commutator as shown by d and e' , Fig. 1523, in order to have them farther apart, their action, however, being the same. A shunt resistance S' is usually placed across the coils S , in order to adjust the compounding of the machine to the circuit on which it is to work, since by varying S' , the percentage of the total current passing around the field can be changed.

3969. Another method very similar to the above is also employed, in which the main current, instead of passing through the rectifier and series coils, flows through the primary of a small transformer carried in the armature. The secondary of this transformer is connected to the rectifier and supplies the series field with a current which varies directly with the load.

REVOLVING-FIELD AND INDUCTOR ALTERNATORS.

3970. It has been mentioned previously that it makes no difference in the case of an alternator whether the field or armature is the revolving part. It is hardly practicable to make a direct-current dynamo with a revolving field and stationary armature, because it is necessary that the brushes should always press on the commutator at certain neutral points which bear a fixed relation to the field, and the brushes would, therefore, have to revolve with it. This, of course, would be objectionable, because it is often necessary to get at the brushes while the machine is running. In an alternator the brushes pressing on the collector rings do not have to bear any fixed relation to the field, consequently there is no objection to the use of a fixed armature, the current from which can be carried off by leads connected to the winding. Two collector rings are necessary for carrying the exciting current into the revolving field, so that the use of the stationary armature does

not do away with moving contacts. The revolving-field type has an advantage in that the armature, being stationary, is easy to insulate for high voltages. This construction also admits of the ready use of armatures of large diameter, thus rendering such machines particularly adapted to slow speeds.

3971. Alternators of the revolving-field type are coming rapidly into use, and some have been built generating pressures of eight to ten thousand volts. The arrangement of the parts of this type of machine is usually similar to that shown in Fig. 1524. This shows a portion only of the sta-

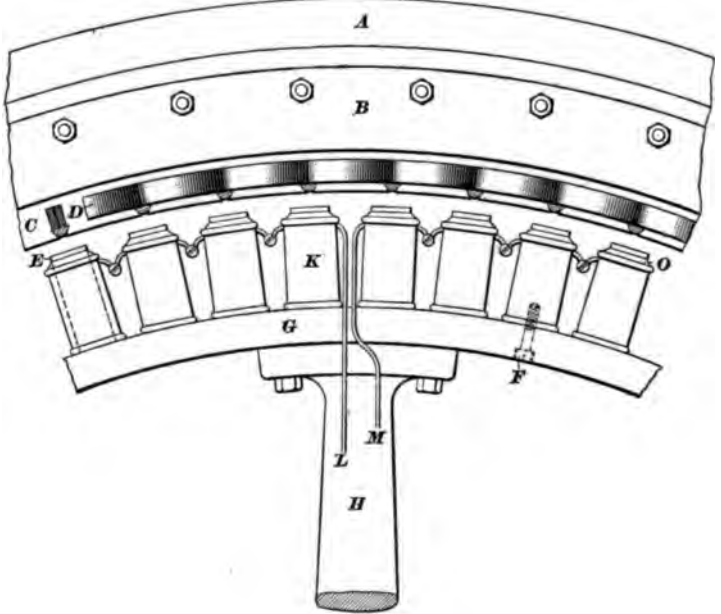

FIG. 1524.

tionary armature *A*, which is external to the revolving field. The armature core is built up of a large number of sectional stampings *C* provided with slots on their inner periphery, and the whole core structure is clamped in a heavy cast-iron yoke *A* by means of the flange *B*. The armature coils *D* are held in the slots by means of wooden wedges in much

the same way as in the revolving armature machines. The field structure is made up of a cast-steel ring *G* carried by the arms *H*, which terminate in a hub keyed to the shaft. Laminated field cores *E* are bolted to *G* by means of bolts *F*, and the field spools *K* are held on by means of flanges *O*. These coils are connected together, and the leads *L*, *M* are connected to two collector rings on the shaft by means of which the exciting current is supplied.

3972. In the inductor type of alternator, the collector rings for supplying current to the field may be done away with, and a machine obtained which has no moving contacts whatever. In this class of machine, a mass of iron or **inductor** with projecting poles is revolved past the stationary armature coils. The magnetism is set up by a fixed coil encircling the inductor, and as the iron part revolves the magnetism sweeps over the face of the coils, thus causing an E. M. F. to be set up. Fig. 1525 shows the principle

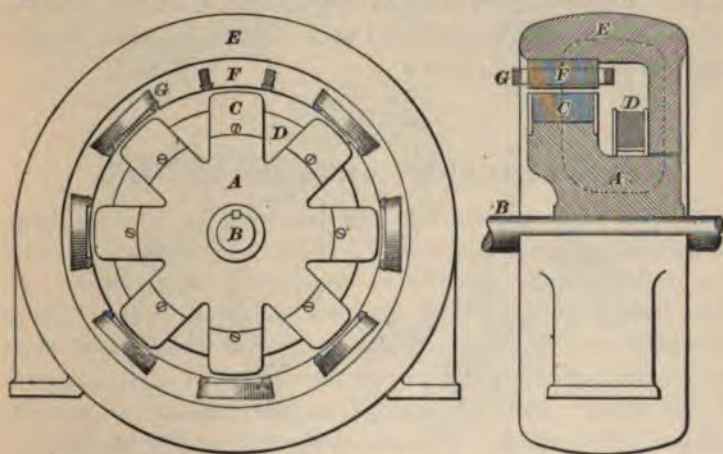

FIG. 1525.

of the Westinghouse inductor alternator. In this machine the circular iron frame *E* supports the laminations *F*, which constitute the armature core. These are provided with slots in which the coils *G* are placed. Inside of the armature is the revolving inductor *A*, provided with the projections *C*

built up of wrought iron or steel laminations. The circular exciting coil D is stationary and encircles the inductor A , thus setting up a magnetic flux around the path indicated by the dotted line. The projecting poles C are all, therefore, of the same polarity, and as they revolve, the magnetic flux sweeps over the coils. Although this arrangement does away with collector rings, the machines are not so easily constructed as other types, especially in the large sizes. The coil D becomes large and difficult to support in place, and would be hard to repair in case of breakdown. The collector rings supplying a low-tension current to revolving-field coils should give little or no trouble; so, taking all things into consideration, it is questionable whether the inductor machine possesses any advantage over those with the revolving field. The Warren and Stanley machines operate on the same principle as the Westinghouse machine, shown in Fig. 1525. The Stanley machine is double, having a set of poles on each end of the inductor, with the exciting coil between, and is provided with two armatures, one for each set of revolving poles.

POLYPHASE ALTERNATORS.

3973. The alternators discussed so far have all been considered as machines which furnish one current only, and are, consequently, known as *single-phase* alternators. In Art. **3861** mention was made of machines which, being provided with two or more distinct sets of windings on their armatures, were capable of furnishing two or more currents to the lines. Such are known as **polyphase**, or **multi-phase**, alternators. The two kinds in common use are:

1. Two-phase alternators.
2. Three-phase alternators.

Two-phase machines deliver two currents which differ in phase by 90° . (See Art. **3861**.)

Three-phase machines deliver three currents which differ in phase by 120° . (See Art. **3862**.)

TWO-PHASE ALTERNATORS.

3974. Since a two-phase machine delivers two currents differing in phase by 90° , it follows that the two windings on its armature must be so arranged that when one set is delivering its maximum E. M. F., the E. M. F. of the other is passing through zero. It has been shown that while the coils move from a point opposite the center of one pole-piece to a point opposite the next of the same polarity, the E. M. F. passes through one complete cycle; hence, if the E. M. F.'s generated by the two sets of coils are to be displaced 90° , or $\frac{1}{4}$ cycle, with reference to each other, it fol-

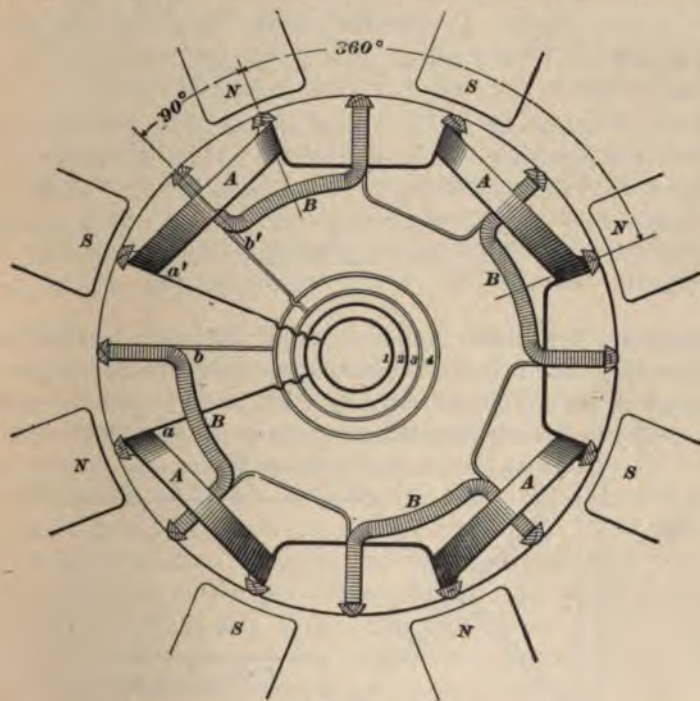
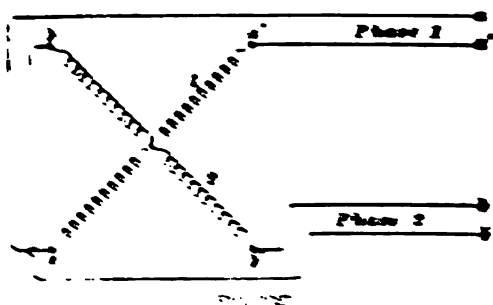

FIG. 1526.

lows that one set of coils must be placed one-half the pitch behind the other. This brings one set of conductors under the poles while the other set is midway between them.

3975. It has been shown that for the most effective generation of E. M. F. the wire on an alternator armature does not cover all the surface, and an armature such as that shown in Fig. 1512 could have another set of coils added, so as to produce an E. M. F. at 90° with that generated by the coils already shown on the drum. Such a winding is shown in Fig. 1526, except that in this case there are only four coils in each phase instead of eight. This gives a common type of two-phase winding, and is used instead of the eight-coil arrangement, in order not to make the drawing too confused. Fig. 1526, therefore, represents a two-phase winding having one group of conductors or one-half a coil per pole per phase. One phase is made up of the four coils *A*, which are connected in series, and the terminals *a*, *a'* brought out to the collector rings *1*, *2*. The four coils *B*, which make up the second phase, are also connected in series, and the terminals *b*, *b'* attached to the light collector rings *3*, *4*. The angular distance by which the center of set *B* is displaced from set *A* is equivalent to 90° , or $\frac{1}{4}$ cycle, as indicated in the figure, the angular distance from *N* to *N'* being equivalent to 360° , or one complete cycle.

3976. Fig. 1530 shows the most common method of connecting up two-phase windings; namely, the method employing two distinct circuits and four collector rings. This may be shown diagrammatically as in Fig. 1537. The



These windings have in

electrical connection with each other and connect to two distinct circuits.

3977. Sometimes, instead of using two distinct circuits with four collector rings, a common return wire is employed, as indicated in Fig. 1528. Here one end of each of the phases is joined to a common return wire, and only three

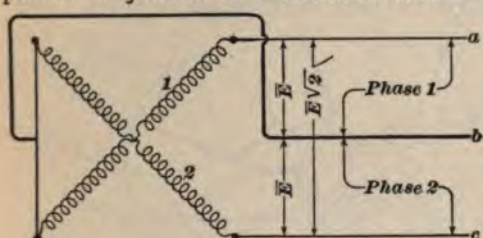

FIG. 1528.



FIG. 1529.

collector rings are necessary. If \bar{E} represent the E. M. F. generated per phase, the voltage between $a b$ and $b c$ will be \bar{E} , while that between $a c$ will be $\bar{E}\sqrt{2}$. This will be understood by referring to Fig. 1529, the E. M. F. between a and c being the resultant of the two E. M. F.'s \bar{E} at right angles to each other.

3978. Fig. 1530 is the winding diagram showing the method of connecting up the coils of the armature, Fig. 1526. This winding differs from that shown in Fig. 1513, in that the connections of every alternate coil do not have to be reversed. By marking the direction of the E. M. F.'s by arrow-heads, as before, it is readily seen that the terminal $1'$ must be connected to 2 , $2'$ to 3 , and so on. The difference in the method of connecting the two windings is caused by there being only four coils per phase in Fig. 1530, whereas there are eight in Fig. 1513. The coils of the second phase are shown dotted, and the connections between them are made in exactly the same way as those of the first phase.

3979. For delivering heavy currents at low voltages, armatures are sometimes wound with copper bars. In such cases there is usually only one turn, or two bars, per coil, and such a bar winding is shown in Fig. 1531. This is the

equivalent of the coil arrangement shown in Fig. 1530, the connections between the bars being such that the current

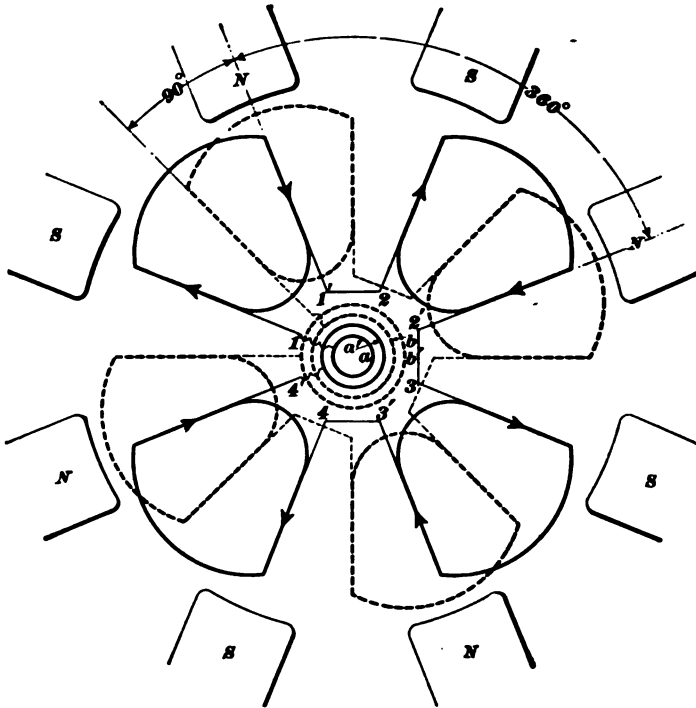

FIG. 1530.

flows in accordance with the arrows. Windings of this kind are used on machines for furnishing heavy currents necessary for electric smelting or any other purposes which call for a large current.

3980. The two-phase windings shown in Figs. 1526, 1530, and 1531 are of the simpler kind known as concentrated or wire coil windings. The conductors on a two-phase armature may be distributed in the same way as those of single-phase machines, there being two, three, or more coils per pole per phase. Both styles are in common use, and will be treated of more in detail in connection with alternator design.

3981. Polyphase machines are used principally for running motors, though lamps are often run from them as well. For example, in Fig. 1527 lamps could be connected across either of the phases, and in case a motor were to be connected, both phases would be used. The load on the different phases should be kept as nearly balanced as possible. It is usual to rate the output of alternators by the

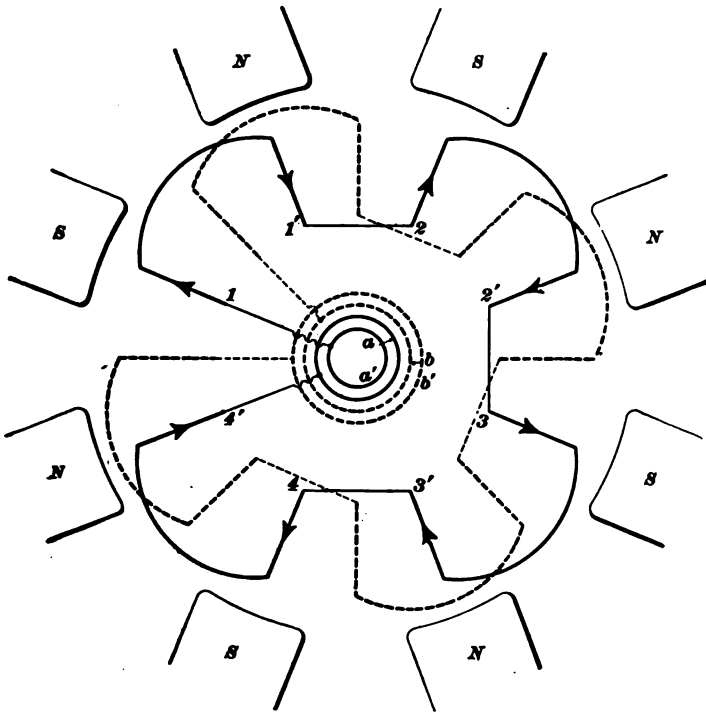

FIG. 1531.

power which they are capable of supplying to a non-inductive circuit; that is, by the product of the volts and amperes which they can furnish without overheating. The output of a two-phase machine is the sum of the outputs of the separate phases. For example, if it were said that a certain two-phase alternator had an output of 150 K. W., at a voltage of 2,000, it would mean that the volts generated by each

phase was 2,000, and hence the *total* full-load current with the machine working on a non-inductive resistance would be 75 amperes, or $37\frac{1}{2}$ amperes per phase. Each line and the wire on the armature would therefore have to be capable of carrying $37\frac{1}{2}$ amperes. If the machine were working on an inductive load, the product of the volts and amperes would not give the output in watts, on account of the lagging of the current. The current in this case would have to be greater for a given output, and as the current output is limited by the size of the armature wire, it follows that an alternator will not deliver its full-load rating to a circuit which is inductive. If the above alternator were provided with only three lines and three collector rings, as in Fig. 1528, the current in the common return wire would be $37\frac{1}{2} \times \sqrt{2} = 53$ amperes, nearly. The two outside wires would in this case be proportioned for $37\frac{1}{2}$ amperes and the middle wire for 53 amperes.

EXAMPLE.—A two-phase alternator is to have an output of 200 K. W. at a pressure of 2,000 volts, and is to be operated on a three-wire circuit. What will be the full-load current in each of the three wires, and what current must the wire on the armature be capable of carrying?

SOLUTION.—Output per phase = 100 K. W. Hence, full-load current per phase = $\frac{100,000}{2,000} = 50$ amperes. The current in the two outside wires is therefore 50 amperes, and the wire in each set of armature coils must be capable of carrying 50 amperes also. The current in the common return wire is $50 \times \sqrt{2} = 70.7$ amperes. Ans.

3982. The field-magnet of polyphase machines is identical with that used for single-phasers; in fact, the only distinguishing feature of the former is the armature winding, the other parts of the machine being almost exactly the same, with perhaps a few minor changes, such as an increase in the number of collector rings, etc.

THREE-PHASE ALTERNATORS.

3983. The requirement of a three-phase armature winding is that it shall furnish three E. M. F.'s differing in phase by 120° , or one-third of a complete cycle. This can be done by furnishing the armature with three sets of wind-

ings displaced 120° from each other. This means that phase No. 2 must be one-third the angular distance from one north pole to the next north pole behind phase No. 1, and also that phase No. 3 shall be displaced a similar angular distance behind No. 2. Such an armature will deliver three E. M. F.'s differing in phase, as indicated in Fig. 1532. The three E. M. F.'s are equal, and are represented by \bar{E}_1 , \bar{E}_2 , and \bar{E}_3 , each being 120° behind the other.



FIG. 1532.

3984. Fig. 1533 shows a three-phase winding having

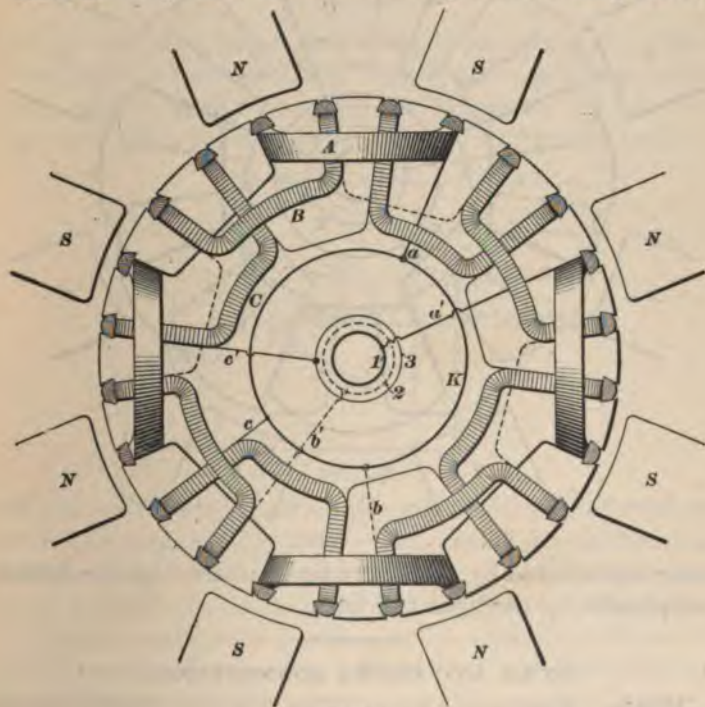

FIG. 1533.

one-half coil per pole per phase. This is the three-phase winding corresponding to the two-phase arrangement shown

in Fig. 1526. The winding consists of three distinct sets of coils *A*, *B*, and *C*. The angular distance from the center of coil *B* to *A* is equivalent to 120° , or is one-third of the distance from *N* to *N*; also the coil *C* is displaced the same distance behind *B*. Each of these three sets is connected in series, leaving the three pairs of terminals *a*, *a'*; *b*, *b'*; *c*, *c'*. The coils are shown diagrammatically in Fig. 1534, phase 1

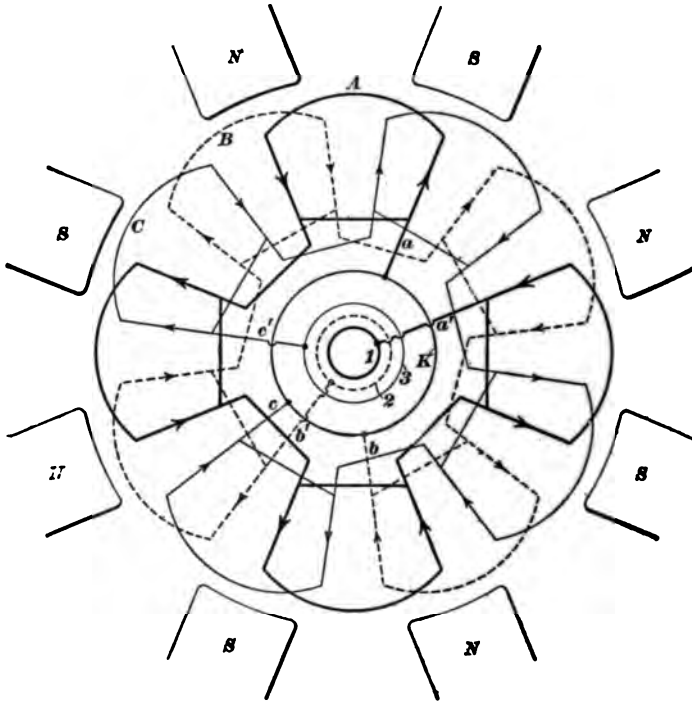

FIG. 1534.

being represented by the heavy lines, phase 2 by the dotted, and phase 3 by the light full lines.

STAR AND DELTA CONNECTIONS.

3985. There are two or three different ways in which the three pairs of terminals *a-a'*, *b-b'*, *c-c'*, Fig. 1533, may be connected to the collector rings. In the first place each terminal might be run to a ring, as was done in the case of the

two-phase armature. This would give three pairs of lines and six collector rings, as shown in Fig. 1535. This is sel-

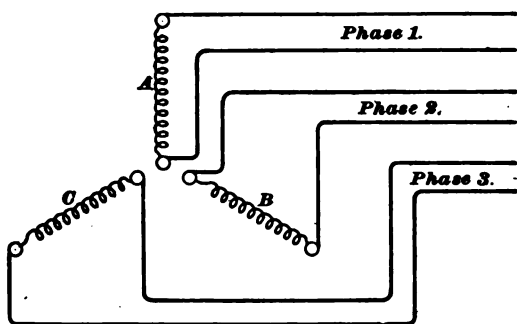

FIG. 1535.

dom, if ever, done in practice, as it complicates matters, and, moreover, it is not necessary. Again, one end of each of the three phases might be connected together, as shown in Fig. 1536, and a common return wire *d* run from the common

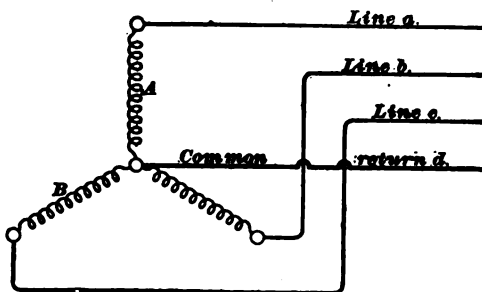
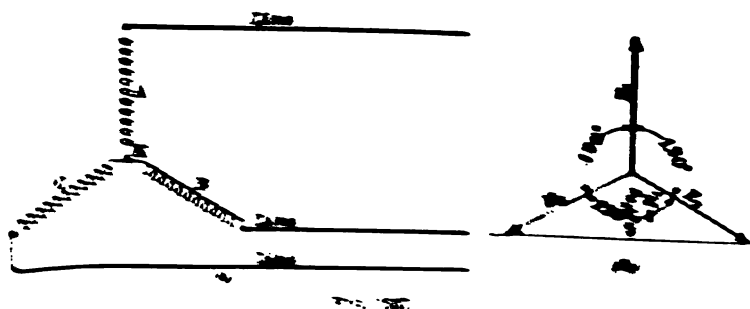

FIG. 1536.

connection, forming an arrangement similar to the two-phase three-wire system, Fig. 1523. This would necessitate four collector rings, and is used occasionally on alternators which are to be used considerably for lighting work. The return wire from the common junction is also sometimes employed on three-phase distributing systems. It was pointed out in Art. 3862 that the resultant sum of three *equal* currents displaced 120° is at all instants equal to zero. Consequently, if the resultant current is zero, there is no need of a return wire *d*, so it may be omitted. However, in some cases,

where power is distributed from transformers or three-wire systems, the different branches are apt to become unbalanced. Under such circumstances the common return d is sometimes used.

3206. Joining the common wire d of Fig. 1535 gives the arrangement shown in Fig. 1537, in which *one* end of each of the pairs is joined to a common connection K and the other ends are joined to three *main* rings. This is a form of mesh of 3 connecting up three-phase armatures, known as the Δ or "star" scheme of connection. The windings in Figs. 1532 and 1534 are shown connected up in this way. In connecting up the terminals $a, a'; b, b'; c, c'$ to form a Δ winding, care must be taken to preserve the



proper relation of the a, b, c in the different sets of coils. In connecting up the coils of Fig. 1534, it will be noticed that with the a, b, c of Fig. 1532, in one set of coils a is connected to the b' of a, b, c' and b in the other two sets. The b' is greater and in the opposite direction. Suppose a then that we take the winding with a, b, c of Fig. 1534, is connecting a to b' in b, c' conductors opposite centers to give, the a, b, c of a, b, c' in this a is directed toward the common junction K . Then terminal a will be connected to b' of the winding in the other two sets in such a way that a, b, c are all a great and in the opposite direction, that is a, b, c are connected that the current in each will be flowing toward the common junction. In order to satisfy this condition, the terminals b and c are

connected to K . The remaining three terminals are connected to the collector rings 1, 2, and 3.

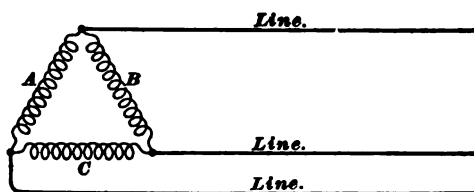

FIG. 1538.

3987. Instead of connecting up the phases in the Y fashion, they may be formed into a closed circuit, as shown in Fig. 1538, the collector rings being attached to the point

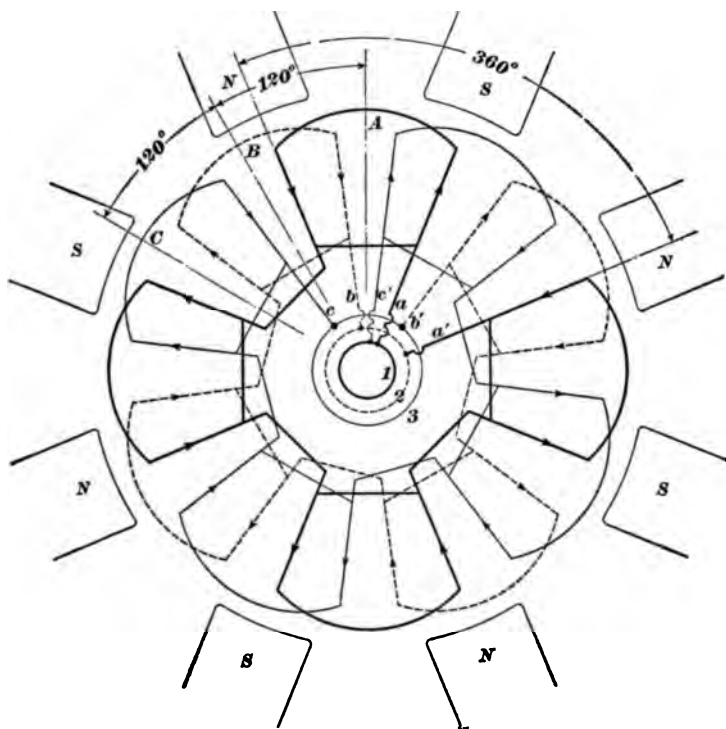

FIG. 1539.

where the phases join. This is known as the Δ (delta) or "mesh" method of connecting. This method, like the last

described, requires only three collector rings, and is extensively used.

Fig. 1539 shows the same winding as Fig. 1534 connected up Δ , and it will be noticed that there is no common connection, as in Fig. 1534. The three sets of coils are connected up in series, as before, leaving the three pairs of terminals a, a' ; b, b' ; c, c' . We will consider the currents in the coils at the instant when the current in set A is at its maximum; that is, when the conductors are midway under the pole-pieces. At this particular instant, the currents in the other two sets will be one-half as great and in such a direction that the sum of the currents taken around the closed circuit of the armature winding is zero. If the maximum current is represented by C , the value and direction of the currents in the three sets of coils must be as shown in Fig. 1540.

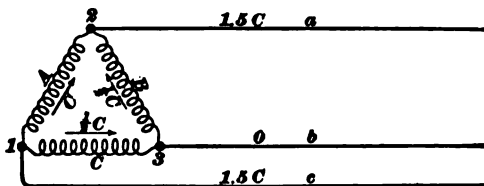

FIG. 1540.

Starting from one end of phase A , by connecting a to the inner collector ring, we therefore pass through phase A in the direction of the arrows to the middle ring. From there we must pass through B against the arrows; hence the terminal b must be connected to the middle ring and the other end b' to the outer ring. From the outer ring the current must pass through C against the arrows; hence, the terminal c must be connected to the outer ring and the other terminal c' carried to the inside ring.

3988. Both of the above methods of connection are in common use in windings, not only for alternators, but also for synchronous motors and induction motors; it is, therefore, important to bear in mind the methods of connection and the distinction between them.

RELATION BETWEEN CURRENT, E. M. F., AND OUTPUT.

3989. The E. M. F. and current output of a three-phase alternator depends upon the scheme which is adopted for connecting up the armature. Suppose the coils A , B , and C ,

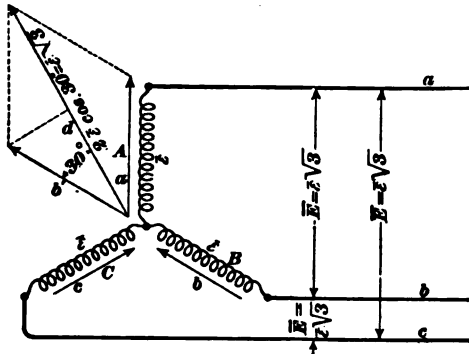

FIG. 1541.

Fig. 1541, represent the windings of an armature Y connected. Let $\bar{\epsilon}$ be the effective value of the voltage generated in *each* phase. The volts obtained between the lines a , b will be the resultant of the two voltages $\bar{\epsilon}$ in A and B . Let \bar{E} represent the pressure between the lines. \bar{E} must be equal to $2\bar{\epsilon} \cos 30^\circ$.

NOTE.—The resultant of the E. M. F.'s in coils A and B , which is the line E. M. F. \bar{E} , may be found as follows: Represent the E. M. F.'s in the three phases by the arrows a , b , c . Suppose the E. M. F. in A to be directed away from the common junction; then the E. M. F.'s in c and b will be directed towards the common junction. To add a and b we must draw b' from the extremity of a equal to and in the same direction as b . The resultant of a and b' will be d , which is the line E. M. F. \bar{E} . The resultant d is equal to $2\bar{\epsilon} \cos 30^\circ = \bar{\epsilon} \sqrt{3}$.

In a three-phase Y-connected alternator, the voltage between any two collector rings is equal to the voltage generated per phase multiplied by $\sqrt{3}$ or 1.732.

Conversely: If the line voltage maintained by a three-phase Y-connected alternator is \bar{E} volts, the voltage generated by each phase must be \bar{E} divided by $\sqrt{3}$ or 1.732.

3990. It is easily seen from Fig. 1541 that if we have a current \bar{C} flowing in any of the lines, the current in the phase to which it is connected must also be \bar{C} . Hence,

In a three-phase \mathbf{Y} -connected alternator, the current in the armature windings is the same as that in the line.

3991. The total output in watts will be the sum of the outputs of each of the three phases. The current in each of the three phases is \bar{c} and the voltage is $\bar{\varepsilon}$; hence, the total watts developed on a non-inductive load will be $3\bar{c}\bar{\varepsilon}$. But $\bar{\varepsilon} = \frac{\bar{E}}{\sqrt{3}}$. Therefore the total output $W = \frac{3\bar{c}\bar{E}}{\sqrt{3}} = \sqrt{3}\bar{c}\bar{E}$, where \bar{c} is the current in the line, and \bar{E} is the voltage between any pair of lines. Hence,

The output, in watts, of a three-phase \mathbf{Y} -connected alternator working on a non-inductive load is equal to $\sqrt{3}$ or 1.732 times the product of the line current and line E. M. F.

3992. For a \mathbf{Y} -connected winding we may then summarize the following formulas, in which $\bar{\varepsilon}$ = volts generated per phase; \bar{E} = line voltage; W = total watts output; \bar{c} = line current; \bar{c} = current per phase or current in windings.

$$\bar{E} = 2\bar{\varepsilon} \cos 30^\circ = \bar{\varepsilon}\sqrt{3}. \quad (649.)$$

$$\bar{\varepsilon} = \frac{\bar{E}}{\sqrt{3}}. \quad (650.)$$

$$\bar{C} = \bar{c}. \quad (651.)$$

$$W = \bar{C}\bar{E}\sqrt{3}. \quad (652.)$$

3993. In case the armature is delta connected, as shown in Fig. 1542, the E. M. F. $\bar{\varepsilon}$ generated in each phase is equal

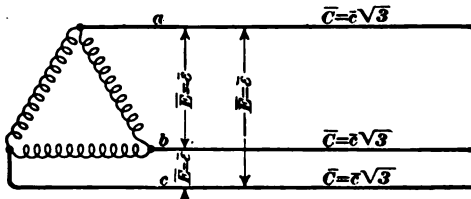

FIG. 1542.

to the line E. M. F. \bar{E} , because the different phases are connected directly across the lines. The current in the armature

windings, however, is not as great as that in the lines, because it divides at each of the collector rings. If \bar{c} represents the current in each phase, the current in the lines will be $2 \bar{c} \cos 30^\circ = \bar{c} \sqrt{3} = 1.732 \bar{c}$.

The total watts output will be $3 \bar{c} \bar{E} = 3 \frac{\bar{C}}{\sqrt{3}} \bar{E} = \sqrt{3} \bar{C} \bar{E} = 1.732 \bar{C} \bar{E}$.

Hence it may be stated that,

In a three-phase delta-connected alternator, the line voltage \bar{E} is equal to the voltage generated in each phase.

In a three-phase delta-connected alternator, the current \bar{C} flowing in the line is equal to the current \bar{c} in each phase multiplied by $\sqrt{3}$ or 1.732.

Conversely: If the current flowing in the line is \bar{C} , the current which the armature conductors have to carry will be \bar{C} divided by $\sqrt{3}$ or 1.732.

The watts output of a three-phase delta-connected alternator working on a non-inductive load is equal to $\sqrt{3}$ or 1.732 times the product of the line current and line E. M. F.

3994. The following formulas relating to a *delta winding* may then be summarized:

$$\bar{E} = \bar{e}. \quad (653.)$$

$$\bar{C} = \bar{c} \sqrt{3}. \quad (654.)$$

$$\bar{c} = \frac{\bar{C}}{\sqrt{3}}. \quad (655.)$$

$$W = \bar{C} \bar{E} \sqrt{3}. \quad (652.)$$

3995. It will be noticed that the expression for the watts output remains the same, whether the armature be connected \mathbf{Y} or $\mathbf{\Delta}$. It follows, therefore, that the output of a three-phase armature is not altered by changing its connections from \mathbf{Y} to $\mathbf{\Delta}$, or the reverse. The \mathbf{Y} method of connection gives a higher line voltage than the $\mathbf{\Delta}$ for the same E. M. F. generated per phase, while the $\mathbf{\Delta}$ connection cuts down the current in the armature conductors.

The Y winding is, therefore, best adapted for machines of high voltage and moderate current output, as it does not require such a high E. M. F. to be generated per phase. On the other hand, the Δ connection is more suitable for machines of large current output, as it keeps the size of the armature conductors down. The best style of winding for any given machine depends largely, therefore, upon the work which it has to do. These formulas regarding Y and Δ windings apply also to polyphase synchronous motors and induction motors.

EXAMPLE.—A three-phase alternator has a capacity of 100 K. W. at a line pressure of 1,000 volts. What is the maximum line current which may flow in each of the three lines leading from the machine?

SOLUTION.—We have, from formula 652,

$$W = \bar{c} \bar{E} \sqrt{3}, \text{ or } 100,000 = \sqrt{3} \bar{c} 1,000;$$

hence,
$$\bar{c} = \frac{100,000}{1,000 \times \sqrt{3}} = 57.7 \text{ amperes. Ans.}$$

EXAMPLE.—(a) If the above armature be Y connected, what will be the current in the armature conductors? (b) What must be the E. M. F. generated in each phase?

SOLUTION.—(a) In a Y -connected machine, the current in the windings must be the same as the line current, that is, 57.7 amperes. Ans.

(b) From formula 650 we have

$$\bar{\varepsilon} = \frac{\bar{E}}{\sqrt{3}} = \frac{1,000}{\sqrt{3}} = 577 \text{ volts. Ans.}$$

EXAMPLE.—(a) If the same machine were changed to the delta connection, what would be the allowable maximum line current? (b) What would be the line voltage with a delta-connected armature?

SOLUTION.—(a) The winding is such as to allow 57.7 amperes in each phase; hence, from formula 654, we have

$$\bar{c} = \bar{c} \sqrt{3} = 57.7 \sqrt{3} = 100 \text{ amperes} = \text{line current. Ans.}$$

(b) The line voltage \bar{E} would be equal to $\bar{\varepsilon}$, and would be 577 volts. The total output would be $\bar{c} \bar{E} \sqrt{3} = 577 \times 100 \times \sqrt{3} = 100,000$ watts, or the same as with a Y winding. Ans.

3996. It is seen, then, in the above example that by changing the Y winding over to Δ , the current output has been *increased* from 57.7 amperes to 100 amperes, while the

line E. M. F. has been *decreased*, in the same proportion, from 1,000 volts to 577 volts, the total watts, however, remaining the same.

3997. The principal differences in the connections of multiphase armatures, as distinguished from single-phase, have been given in the preceding articles; as far as the mechanical construction goes there is no essential difference. Toothed armature cores with the coils or conductors bedded in slots are now almost universal in alternators as well as direct-current machines. Of course polyphase windings give rise to a larger number of coils to dispose of, and, therefore, usually give more crossings of the conductors or coils at the ends of the armature; but polyphase armatures are constructed essentially in the same manner as those used for single-phase machines.

MONOCYCLIC SYSTEM.

3998. The monocyclic alternator, brought out by Steinmetz, is intended for use in stations where the greater part of the load consists of electric lights, but where it is also desired to have a machine capable of operating motors as well. In cases where the motor load is large, it is usual to use a regular two or three phase system.

The monocyclic alternator is really a single-phase machine with a modified armature winding. The armature is provided with a set of coils constituting the main winding, the terminals of which are connected to the two outside collector rings, Fig. 1543. In addition to this winding, a second set of coils

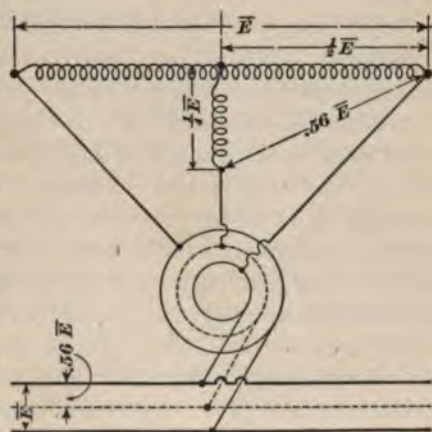

FIG. 1543.

In addition to this winding, a second set of coils

is provided, which are placed on the armature 90° behind the main coils, in just the same way as shown for the two-phase machine, Fig. 1526. This second set is unlike those in a regular two-phase machine in that the number of turns in the "teazer coils," as they are called, is only $\frac{1}{2}$ that of the main set, and one end of the teazer set is attached to the middle of the main winding, instead of being brought out to a collector ring. The other end of the teazer winding is brought to the middle collector ring, as shown in Fig. 1543. This second winding furnishes an E. M. F. displaced 90° from the main E. M. F., and of one-quarter its value, thus furnishing an out-of-phase pressure suitable for starting motors. If it is desired to run lights only, the two outside wires alone are used, it being necessary to run the third wire only to places where motors are used. By referring to the figure it will be seen that the E. M. F. between either of the outside and the middle rings is equal to $\sqrt{(\frac{1}{2}\bar{E})^2 + (\frac{1}{4}\bar{E})^2} = .56\bar{E}$, nearly. For example, if the main winding generated 1,000 volts, the pressure between the middle and outside rings would be 560 volts, nearly.

TRANSFORMERS.

3999. One of the principal reasons for the fact that continuous current is giving place so largely to alternating current is the ease with which the latter may be transmitted over long lines at high voltages, and then be transformed at the receiving end to currents of lower pressure suitable for operating lights, motors, or other devices. If power is to be transmitted over long distances by means of the electric current, it is absolutely necessary that high line pressures be employed, in order to make the cost of the conductors reasonably low. For a given amount of power to be transmitted, the current will be smaller the higher the pressure employed. The loss in the line, however, increases with the square of the current; consequently, if the pressure on a line be doubled, it means that, with the same loss, only $\frac{1}{4}$ the amount of copper would be required in the

conductors. In other words, *with a given amount of power to be transmitted and a given fixed amount of loss, the copper required will decrease as the square of the voltage employed.* By using high pressures, it is evident that a small line conductor may be made to carry a large amount of power over a long distance, and still not have the loss any greater than if a low pressure and a very large and expensive conductor had been employed.

4000. Transmission with direct current and high pressures never proved to be a success, because of the difficulty of building direct-current machines to generate the high E. M. F.'s necessary. The commutator on such high-tension machines would be apt to give trouble, and, moreover, it would be a difficult matter to transform the high-tension continuous currents at the other end of the line down to currents at pressures suitable for ordinary use. The alternating current is open to neither of these objections, because an alternator has no commutator to give trouble, and high-tension alternating currents may easily be transformed down. Devices used for changing an alternating current of one voltage to another of higher or lower voltage are known as **transformers** or **converters**. Transformers may be used either to "step-up" the voltage, i. e., increase it, or they may be used to "step-down," or decrease, the line pressure. Whether the transformer be used to step up or down, the change in pressure is always accompanied by a corresponding change in the current, and the *power* delivered to the transformer is always a little greater than that obtained from it. For example, suppose a current of 20 amperes were supplied to a transformer from 1,000-volt mains. If the load on the transformer were non-inductive, the E. M. F. and current would be almost exactly in phase, and the watts supplied to the side connected to the mains (*primary* side of the transformer) would be $20 \times 1,000$, or 20,000 watts. The power obtained from the *secondary* side, or the side connected to the circuit in which the power is being used, would not be

quite as much as this. Suppose the secondary E. M. F. were 100 volts; if there were no losses whatever in the transformation, we would obtain 20,000 watts from the secondary, and the available secondary current would be $\frac{20000}{100} = 200$ amperes. In other words, the decrease in E. M. F. has been accompanied by a corresponding increase in current. As a matter of fact, there is always some loss in conversion, and the secondary output is never quite equal to the power supplied to the primary. The ratio $\frac{\text{watts output}}{\text{watts input}}$ gives the efficiency of the transformer. A good transformer is one of the most efficient pieces of apparatus known, some of large size delivering as much as 98.5% of the energy supplied.

4001. Transformers used for changing an alternating current at one pressure to another alternating current at another pressure are often called **static transformers**, because they have no moving parts. This is done to distinguish them from **rotary transformers**, which are used to transform alternating current to direct, or vice versa. Such machines always have moving parts, hence their name.

4002. Nearly all transformers are operated on constant-potential systems. The transformer is supplied with current from mains, the pressure between which is kept constant, and this current is transformed to one of a lower pressure, the secondary pressure also being constant or nearly so.

THEORY OF THE TRANSFORMER.

4003. A simple transformer is shown in Fig. 1544. C is a laminated iron ring, on which are two coils P and S . The coil P has a number of turns T_p , and S has, we will suppose, a smaller number of turns T_s . The coil P is the primary, and is connected to the alternator mains across which the constant pressure \bar{E}_p is maintained. We will suppose for the present that the resistance of both primary and secondary

coils is negligible. The above is essentially the construction of the ordinary static transformer. It consists of two coils or sets of coils interlinking an iron magnetic circuit. Of course the forms of different transformers vary widely, but they all contain the three essential parts mentioned.

Suppose a voltmeter V to be connected to the terminals of the secondary coil S . The resistance of the voltmeter is very high, consequently a very small current will flow

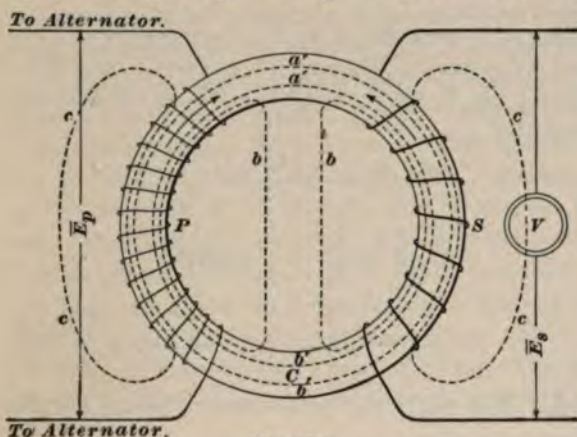

FIG. 1544.

through the secondary, and we may, for all practical purposes, consider the secondary as an open circuit with no current flowing. The line E. M. F. \bar{E}_p will cause a current to flow through the primary coil, and this current will set up an alternating magnetic flux in the iron core. This alternating flux will set up a counter E. M. F. in the coil P , which will be the equal and opposite of \bar{E}_p , since the coil is supposed to have no resistance. If the maximum magnetic flux be N and the number of cycles per second n , we will have, from formula 617,

$$\bar{E}_p = \frac{4.44 N T_p n}{10^8}.$$

The current which will flow, therefore, in the primary when the secondary is on open circuit is that current which is required to set up a magnetic flux N capable of producing

a back E. M. F., equal and opposite to the applied E. M. F. Since the coil P is provided with a closed iron circuit, it is evident that a very small current might be able to set up a large magnetic flux; hence, the current required when the secondary is on open circuit may be very small, perhaps only a fraction of an ampere. In other words, the applied E. M. F. is capable of forcing only a small current through the primary, on account of its high self-induction.

4004. The flux N set up by the primary coil also interlinks the secondary S , and as it is continually alternating through it, an E. M. F. will be set up in the secondary coil, which will be

$$\bar{E}_s = \frac{4.44 N T_s n}{10^8},$$

and
$$\frac{\bar{E}_p}{\bar{E}_s} = \frac{T_p}{T_s}, \quad (656.)$$

or
$$\bar{E}_s = \bar{E}_p \frac{T_s}{T_p}. \quad (657.)$$

4005. The ratio of the primary voltage to secondary, i. e., $\frac{\bar{E}_p}{\bar{E}_s}$ is called the **ratio of transformation**. It also

follows from the above that the ratio of transformation is equal to the primary turns divided by the secondary turns. For example, if a transformer be supplied with 1,000 volts primary and has 500 turns on its primary coil while there are 50 turns on the secondary, the ratio of transformation is 10, and the secondary voltage $1,000 \times \frac{50}{500} = 100$ volts. In this case the transformer reduces the voltage from 1,000 to 100, but the operation could be reversed, that is, it could be fed with 100 volts and the pressure raised to 1,000.

4006. It was assumed above that all of the magnetic flux N which threaded the primary coil also passed through the secondary, and in well-designed transformers this is very nearly the case. However, some lines may leak across, as shown by the dotted lines b, b, c, c , without passing through

both coils. This is known as **magnetic leakage**, and its effect upon the action of the transformer will be noticed later.

4007. So far, in dealing with the action of the transformer, the secondary has been supposed to be on open circuit. It is now necessary to examine the transformer action when the secondary is working on a load. While the construction of a transformer is exceedingly simple, the reactions which occur when it is loaded are by no means so simple, and for the sake of clearness we will first examine the action of an ideal or perfect transformer—one which has no resistance in its coils, no magnetic leakage, and no hysteresis or eddy-current loss in its core. Such a transformer would have an efficiency of 100%, and after examining its workings we can easily note the effect of the introduction of one or more of the above defects, which are present to a greater or less extent in all commercial transformers. The fact that the efficiency of good transformers is commonly over 95 or 96%, and even rises to over 98%, shows at once that the combined effect of all the above defects does not change the performance of the transformer very much from that of the ideal.

4008. In the first place, if the core reluctance were zero, the current with open circuit secondary necessary to set up the magnetic flux would be infinitely small. All cores have, however, some reluctance; hence, the effect of reluctance in the core is to increase this no-load current, or **magnetizing current**, as it is called. Since this magnetizing current is that which is caused to flow against the self-induction of the primary, it follows that it is a wattless current 90° behind the E. M. F. of the mains which is overcoming the self-induction. It is important to keep the magnetizing current as small as possible; therefore the magnetic circuit should be made short and of ample cross-section.

4009. We have seen that the primary induces an E. M. F. $\bar{E}_s = \bar{E}_p \frac{T_s}{T_p}$ in the secondary at no load. Now, if the secondary circuit be closed, say through a non-inductive

resistance made up of a number of incandescent lamps, a current will flow which will be in phase with the secondary E. M. F. This current flowing in the secondary coil will always flow in such a direction as to oppose any change in the magnetic lines threading it, just as the reaction on the field due to the current in the armature of a dynamo tends to prevent the rotation. The magnetism is in phase with the primary current; hence the secondary current must be directly opposite in phase to that of the primary. Whenever a current \bar{C}_s is taken from the secondary, a corresponding current \bar{C}_p flows in the primary. The total current in the primary will, therefore, be made up of two components, one of which is the magnetizing current \bar{m} and the other \bar{C}_p , due to the current \bar{C}_s in the secondary. The magnetizing power of the primary and secondary coils is proportional to their ampere-turns, that is, to $\bar{C}_p T_p$ and $\bar{C}_s T_s$, respectively. The currents \bar{C}_p and \bar{C}_s are opposed to each other; hence the total magnetizing effect of the two currents is

$$\bar{C}_p T_p - \bar{C}_s T_s.$$

Now the input $\bar{C}_p \bar{E}_p$ is equal to the output $\bar{C}_s \bar{E}_s$ for an ideal transformer, or

$$\bar{C}_p = \bar{C}_s \frac{\bar{E}_s}{\bar{E}_p} = \bar{C}_s \frac{T_s}{T_p}; \quad (658.)$$

hence, we may write the total magnetizing effect of the two currents,

$$\bar{C}_s \frac{T_s}{T_p} T_p - \bar{C}_s T_s = 0. \quad (659.)$$

That is to say, when a current \bar{C}_s is taken from the secondary of an ideal transformer, the corresponding current \bar{C}_p which flows in the primary over and above the magnetizing current \bar{m} is $\bar{C}_s \frac{\bar{E}_s}{\bar{E}_p}$, and the total magnetizing effect of the two currents is zero. This means that the flux N in the iron core will remain constant, no matter what load is placed on the secondary.

4010. Since the magnetic flux is constant for all loads, it follows that the secondary induced E. M. F. will also be constant, and if the secondary coil has no resistance, the E. M. F. at its terminals, that is, the secondary line E. M. F., will not change as the load is applied. An ideal transformer would, therefore, if supplied with a constant primary pressure, maintain the voltage between the secondary lines constant at all loads. This condition is approached quite closely in the best makes of modern transformers, the variation in secondary voltage being not more than 1.5 to 2%, depending upon the size. It is thus seen that while the transformer is most simple in construction, it adjusts itself exceedingly well to changes in load so as to maintain the desired constant secondary pressure, the whole automatic regulation being brought about by the interactions of the currents in the primary and secondary coils.

ACTION OF IDEAL TRANSFORMER.

4011. The action of a transformer without resistance, magnetic leakage, hysteresis, or eddy-current losses, may be represented by Fig. 1545,

when working with an *open-circuit secondary*. Let ON represent the magnetic flux; then the magnetizing current will be in phase with ON , and hence may be represented by Om . This current is 90° behind the primary impressed E. M. F. \bar{E}_p , and \bar{E}_p will, therefore, be represented by the line $O\bar{E}_p$, 90° ahead of Om . The secondary



FIG. 1545.

secondary E. M. F. \bar{E}_s will be directly opposite in phase to \bar{E}_p and will be represented by $O\bar{E}_s = \bar{E}_p \frac{T_s}{T_p}$. In this case the

transformer takes the small current $O m$ from the line, and since this current is at right angles to the E. M. F., it is wattless, $\cos \Phi = 0$ and $\overline{E}_p \overline{m} \cos \Phi = 0$, and the transformer consumes no energy.

4012. When the secondary is connected to a non-inductive resistance, a current \overline{C}_s flows in the secondary, and the action of an ideal transformer in this case is represented by Fig. 1546. The lines ON and $O m$ represent the magnetic flux and the magnetizing current as before. $O \overline{E}_p$ is drawn to scale to represent the primary E. M. F., and $O \overline{E}_s$ represents the secondary E. M. F. Let R be the resistance of the non-inductive circuit to which the secondary is connected; then the secondary current will be $\overline{C}_s = \frac{\overline{E}_s}{R}$, since the resistance is non-inductive, and may be represented to scale by the line $O d$ in phase with $O \overline{E}_s$. The

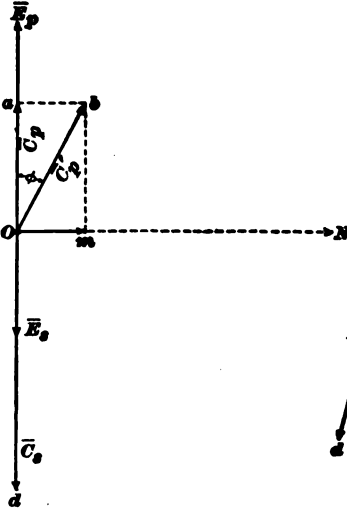

FIG. 1546.

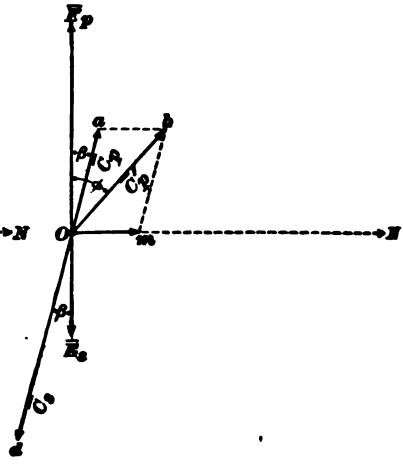

FIG. 1547.

current in the primary corresponding to \overline{C}_s in the secondary will be $\overline{C}_p = \overline{C}_s \frac{T_s}{T_p}$, and may be represented by the line

Oa opposite in phase to Od and representing \bar{C}_p to the same scale that Od represents \bar{C}_s . In the case shown, $\bar{E}_s = \frac{1}{2}\bar{E}_p$; hence, Oa must be one-half the length of Od . The total current flowing in the primary will be the resultant of Oa and Om , or $Ob = \bar{C}_p$. This resultant current lags Φ° behind the impressed E. M. F., and it is evident that the more the transformer is loaded, the smaller Φ becomes, and the nearer the primary current gets into phase with the primary E. M. F. In other words, taking current from the secondary acts as if it decreased the self-induction of the primary, thus allowing a larger current to flow. Since Φ decreases as the load is applied, it follows that $\cos \Phi$ increases; hence, the power supplied to the primary increases.

4013. If the secondary of an ideal transformer furnishes current to an *inductive* load, such as motors, the secondary current \bar{C}_s lags behind the E. M. F. \bar{E}_s by an angle β of such amount that $\tan \beta = \frac{2\pi nL}{R}$, where L is the inductance of the circuit and R the resistance. This action is represented by Fig. 1547. The magnetizing current Om , magnetic flux ON , primary E. M. F. \bar{E}_p , and secondary E. M. F. \bar{E}_s are all represented as before. The secondary current \bar{C}_s , however, lags behind \bar{E}_s by the angle β ; consequently the corresponding primary current Oa is behind the primary E. M. F. \bar{E}_p by the same angle β , because \bar{C}_p is opposite in phase to Od . The total primary current, being the resultant of Om and Oa , will be Ob , lagging Φ° behind \bar{E}_p . It will be noticed that Φ is greater than it would be if the transformer were working on a non-inductive load; hence the primary current corresponding to a given output will be greater with an inductive load.

The above diagrams represent the action of an ideal transformer, and, as mentioned before, actual transformers approximate quite closely to the ideal. We will now notice what effect the resistance of the coils, core losses, and magnetic leakage have on the action of an actual transformer.

EFFECT OF RESISTANCE OF PRIMARY AND SECONDARY COILS.

4014. Transformer coils always have an appreciable resistance, hence there will be a loss in them proportional to the square of the current. One effect, therefore, of coil resistance is the heating under load and a lowering of the efficiency. A transformer with an excessive amount of coil resistance can not have a high efficiency. The resistance also produces another effect which is more detrimental than the mere loss in efficiency, namely, bad regulation. When a transformer regulates badly, the secondary E. M. F., instead of remaining nearly constant, drops off as the load is applied and rises when it is removed. This is a particularly bad feature, especially when incandescent lights are being operated, because the changes in voltage not only affect the brilliancy of the lamps, but also shorten their life. The resistance of the primary prevents the induced back E. M. F. from being quite equal to the line E. M. F., because a certain part of the impressed voltage is used up in overcoming the resistance; this, in turn, will also cause the secondary induced E. M. F. to be slightly smaller than it would be if the primary had no resistance. The E. M. F. obtained at the terminals of the secondary will be further reduced by the drop due to the secondary resistance. It is thus seen that the general effect of the resistance is to cause a falling off in the secondary voltage when the transformer is loaded. The only way to prevent bad regulation from this source is to make the resistance of the coils as low as possible without making the design bad in other respects.

EFFECT OF MAGNETIC LEAKAGE.

4015. When a transformer has a large magnetic leakage, quite a number of the lines which pass through the primary will not thread the secondary, consequently the E. M. F. induced in the secondary will not be as large as it should be. Take the case of a transformer constructed as shown in Fig. 1544. When it is not loaded,

there is no current in the secondary coil, and consequently there is nothing to oppose the primary coil setting up lines through the magnetic circuit. Under these circumstances there would be very little leakage. When, however, a current flows in the secondary, a counter magnetic flux is set up which is opposed to the original flux set up by the primary, as indicated by the arrows. There is then a tendency for poles to form at a' , a' and b' , b' , thus causing leakage lines bb and cc to be set up. Evidently the leakage will increase as the load on the secondary increases; hence the tendency of magnetic leakage is to cause a falling off in the secondary voltage as the transformer is loaded. The effect of both resistance and magnetic leakage is, therefore, to produce bad regulation.

4016. Magnetic leakage can be avoided to a large extent by so placing the coils with reference to each other that all the lines passing through one must pass through the other. This might be done by winding the two coils together, but this plan would not work in practice, owing to the difficulty of maintaining proper insulation between them. The type shown in Fig. 1544 would have a large amount of leakage and would not be used in practice. A much better arrangement would be to wind the coils one on top of the other, thus leaving very little space for lines to leak through between them, or to wind the primary and secondary in sections and interleave them.

EFFECT OF CORE LOSSES.

4017. Since the magnetism in the core is constantly changing, there will be a hysteresis loss, just as there is a loss due to the varying magnetization of an armature core. The transformer will have to take power from the line to make up for this loss, thus lowering the efficiency. The amount of loss due to hysteresis depends upon the quality and volume of iron in the core, as well as upon the maximum magnetic density at which it is worked. Since the

magnetic flux N is nearly constant for all loads, the magnetic density must also be constant, and the hysteresis loss must be about the same, no matter what load the secondary is carrying. Heat losses also occur in transformer cores, due to eddy currents set up in the iron. The iron in the core acts as a closed conductor, and the alternating field induces small E. M. F.'s, which give rise to currents in the core. In order to prevent the flow of eddy currents, the core is laminated or built up of sheets varying in thickness from .014 in. to about .025 in., depending upon the frequency, the thicker iron being used for transformers designed to work on low frequencies. The effect of laminating the core is to break up the paths in which the eddy currents flow, thereby reducing their volume. The effect of both eddy-current and hysteresis losses is simply to increase the power which the primary takes from the line, and thus lower the efficiency. These losses do not affect the regulation to any appreciable extent, but if large they may lower the efficiency considerably.

4018. It has been shown above that the core losses take place so long as the primary pressure is maintained, and are about the same whether the transformer is doing any useful work or not. In most lighting plants, the line pressure is maintained all day, while the load may be on for only a few hours out of the twenty-four. It follows, therefore, that the C^2R , or copper, losses take place for a short time only, whereas the iron losses go on all day. It is very important, therefore, that the iron losses be small as compared with the copper loss, because, if this is not the case, the transformer may have a low all-day efficiency; that is, it may give out a small amount of energy during the day compared with the amount it consumes. If the transformer were loaded steadily all day, it would not be of such importance to have the core losses small compared with the copper losses.

CONSTRUCTION OF TRANSFORMERS.

4019. Transformers are made in a variety of forms, but they may, for convenience, be divided into two general classes:

- a. Core transformers.
- b. Shell transformers.

In the **core transformers**, the iron part forms a core upon which the coils are wound, while in the shell arrangement, the iron surrounds the coils. Figs. 1548 and 1549 show the arrangement of the parts of a common type of core transformer. The core *C*, Fig. 1548, is built up of thin iron strips into the rectangular form shown; *P*, *P'*, *S*, *S'* are the primary and secondary coils, each wound in two parts. It will be noticed that the primary is wound over the secondary,

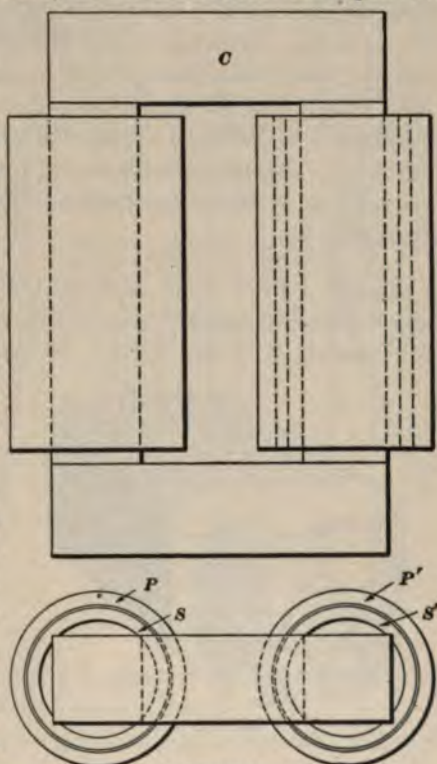

FIG. 1548.

primary, thus making the leakage path between the coils long and of small cross-section, thereby reducing the magnetic leakage. Fig. 1549 shows a section of the coils and core. One advantage of this type is that the core may be built up of strips of iron, no special stampings being required.

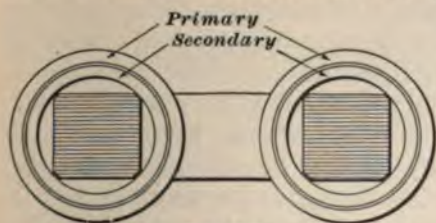

FIG. 1549.

There is also an advantage in having the coils wound in two sections, in that it enables the transformer to be connected up for a variety of voltages. For example, suppose each primary coil were wound for 1,000 volts and each secondary for 50 volts. By connecting the primary coils in series or parallel, the transformer could be operated on 2,000 or 1,000 volt mains, and by connecting the secondaries in series or parallel, a secondary voltage of either 100 or 50 could be obtained. Modern transformers are usually built in this way, because it is often convenient to be able to make these changes.

4020. Figs. 1550 and 1551 show a common type of **shell transformer**. Here the primary and secondary coils, P, P_1 and S, S_1 , respectively, are surrounded by the iron core

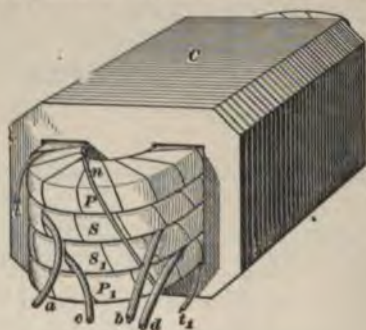

FIG. 1550.

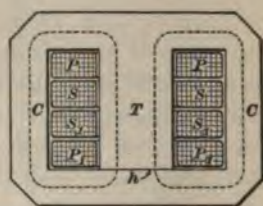

FIG. 1551.

C , which is built up of iron stampings of the form shown in the sectional view, Fig. 1551. A cut is made in the stamping at h , so that the tongue T may be bent back to allow the stampings to be slipped over the coils. The magnetic lines are set up around the circuit as indicated by the dotted lines, and thus pass through both primary and secondary coils. The primary and secondary coils are split up into two sections, the primary being divided into two parts and placed on each side of the secondary. The two parts of the primary coils are connected in series by the connection shown at n ; t and t_1 are the primary terminals. The ends a and b of coil S

and c and d of coil S , are brought out separately, in order that the two coils may be connected either in series or in parallel, as may be desired. Leakage tends to take place between the coils, and by interleaving the primary and secondary, the leakage is reduced.

4021. Transformers for outside work are placed in a weather-proof iron case, such as that shown in Fig. 1552

This shows a case suitable for a transformer of the style shown in Fig. 1548. The wires a, b are the primary terminals, and c, d, e, f are connected to the secondary mains. The case in which transformers are placed is often filled with an insulating oil, which not only tends to keep the insulation better, but also helps to get

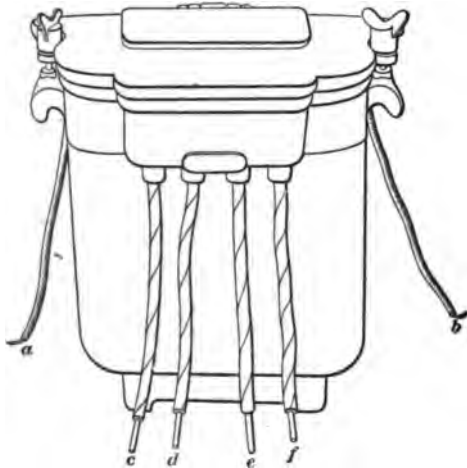

FIG. 1552.

rid of the heat by conducting it away from the transformer to the iron case, and thence to the outside air.

The ratio of transformation for transformers used in ordinary lighting work is usually 10 or 20, that is, 1,000 or 2,000 volts primary and 50 or 100 volts secondary.

CONNECTING TRANSFORMERS.

4022. The ordinary method of connecting transformers to constant-potential mains is shown in Fig. 1553. In this case the primaries P, P' are simply connected in parallel across the 1,000-volt mains, and the secondary of each delivers 100 volts, provided the ratio of the windings is 10 to 1.

Fig. 1554 shows a transformer with its primary coil wound in two sections, as referred to in Art. 4019. Each primary

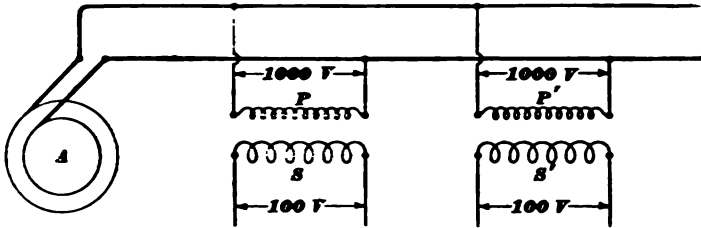

FIG. 1553.

coil is wound for 1,000 volts and the secondaries for 50 volts; hence, by connecting the primaries in series, the transformer may be attached to 2,000-volt mains. If the secondaries are connected in series as shown, 100 volts will be obtained between the secondary mains. The primaries might be connected in parallel and attached to 1,000-volt mains and 100 volts obtained from the secondary, or both primary and secondary might be connected in parallel and the transformation made from 1,000 volts to 50 volts.

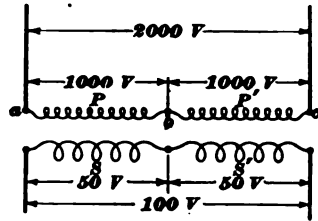

FIG. 1554.

4023. Sometimes it is necessary to connect up the secondaries of two transformers to feed into the same circuit, as shown in Fig. 1555.

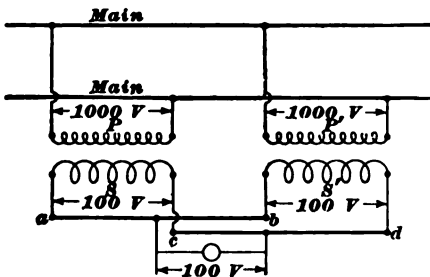

FIG. 1555.

If the connections were made as in Fig. 1556, they would be wrong, because the two coils would practically

When this is done, care should be taken to get the corresponding ends of the two secondaries connected as shown in the figure, with terminals a and b brought together to one main, and c and d to the other.

be connected up in series into a closed circuit, and the consequence would be that the two coils would be short-circuited and burnt out. The same care must be taken in connecting primary coils in series across the mains. If one coil is con-

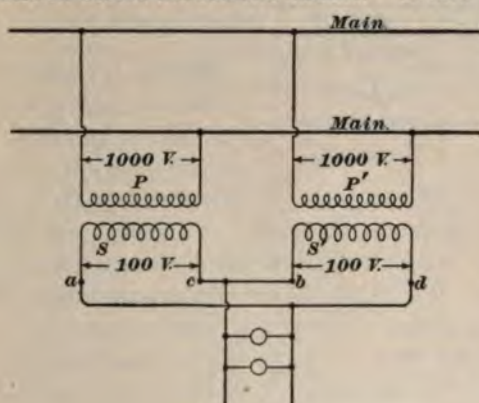

FIG. 1556.

nected up so as to neutralize the other, the coils act as if they had no self-induction, and, in consequence, are not able to choke back the current. The result is a rush of current through the primaries, and they are burnt out unless protected by fuses.

4024. Pairs of transformers are often connected up so as to deliver current to secondary mains on a plan similar to the three-wire system, as shown in Fig. 1557. This plan

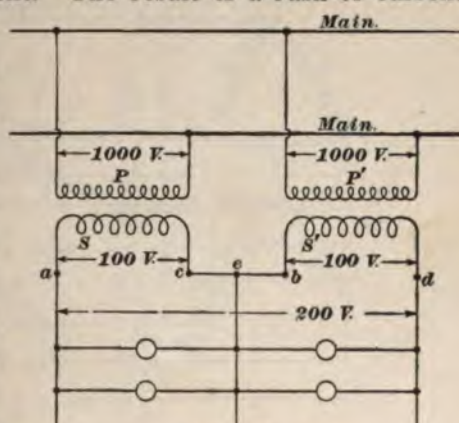

FIG. 1557.

allows the use of a higher secondary line voltage, and hence cuts down the amount of copper required for the mains. By connecting the two 100-volt secondaries in series, a line

voltage of 200 is obtained.

A third or neutral wire is run from ϵ , where the two coils unite, and if the load on each side is balanced, no current flows in this line.

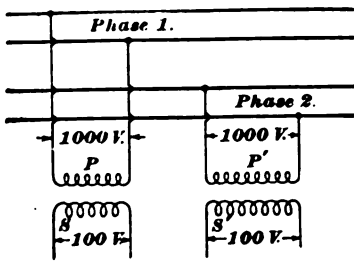

FIG. 1558.

It is usual, however, to connect up two or more single-phase transformers in the combination required to do the work. Fig. 1558 shows two transformers connected to two-phase mains. These are simply connected in parallel across the two pair of mains in the usual manner, and the mains from the secondary constitute in this case a two-phase system with a line pressure of 100 volts.

Transformers may be connected up in a number of different ways on three-phase circuits, depending upon

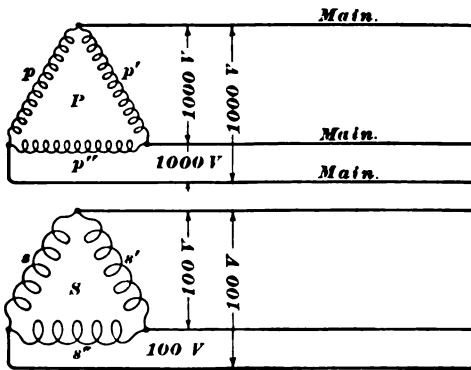

FIG. 1559.

whether the Y or Δ connection is used. In all the following examples there are supposed to be ten times as many primary turns as secondary on the transformers used; that is, they transform down in the ratio of 10:1. Three single-

4025. Ordinary transformers are generally used on multiphase systems, although special two and three phase transformers have been constructed.

4026.

phase transformers are employed in each case, their primary coils being p, p', p'' , and their corresponding secondaries s, s', s'' . In the first case, Fig. 1559, both the primaries and secondaries are connected up Δ , and they would, therefore, transform from 1,000 volts primary to 100 volts secondary, or the ratio of primary line voltage to secondary

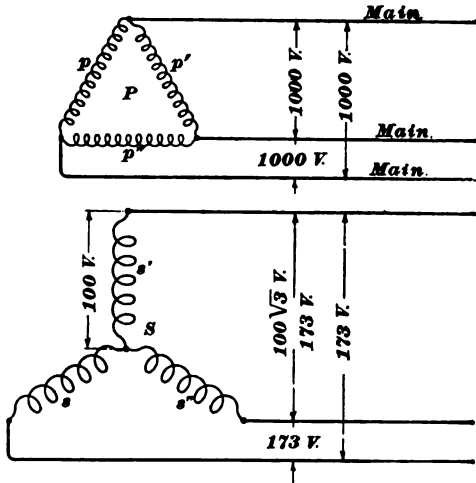

FIG. 1560.

same as that of the windings. In Fig. 1560 the primaries are connected Δ and the secondaries Y . In this case the voltage

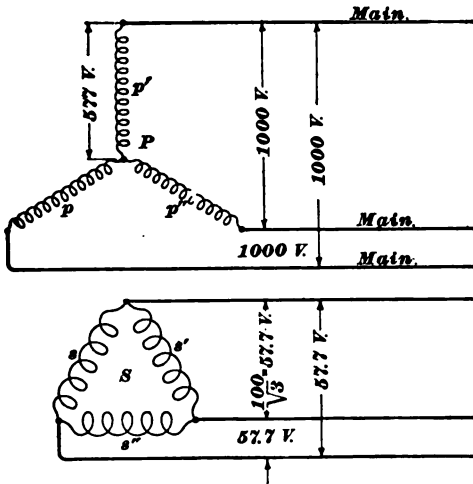

FIG. 1561.

generated in each of the secondary windings will be 100.

hence, the line pressure will be $100\sqrt{3}$ or 173 volts. This arrangement, therefore, transforms from 1,000 volts primary to 173 volts secondary. In Fig. 1561 the primaries are connected \mathbf{Y} and the secondaries Δ . Since the \mathbf{Y} connection is used on the primaries, the voltage impressed on each primary will be $\frac{1,000}{\sqrt{3}}$, or 577 volts; hence, that generated in each secondary will be 57.7 volts, and as these

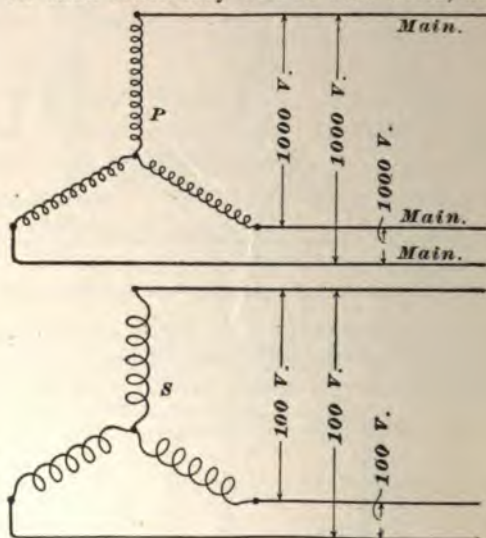

FIG. 1562.

are connected Δ , the secondary line voltage will be 57.7 volts. This arrangement, therefore, transforms from 1,000 volts primary to 57.7 volts secondary. In Fig. 1562 both primary and secondary are connected \mathbf{Y} , and it is evident that such an arrangement would transform from 1,000 to 100. The connections best adapted for any work will depend largely upon the magnitude of the E. M. F.'s and currents to be handled. For example, if a very high line voltage were employed, it would be best to use the \mathbf{Y} connection on the primaries, because this would lessen the voltage on any one transformer. On the other hand, if the secondaries had to deliver very heavy currents, they would

in all probability be connected up Δ , as this would cut down the current in the secondary windings and avoid the use of such heavy conductors in the coils.

SPECIAL USES OF TRANSFORMERS.

4027. Two currents differing in phase by 90° may be transformed into three differing by 120° , by means of an arrangement of special transformers. Fig. 1563 shows the principle of the device for transforming from two phase to three phase, and vice versa, brought out by Mr. C. F. Scott. Two transformers *A* and *B* are connected to two-phase mains, as shown. The secondary coil of *B* is represented by *bd*, and that of *A* by *ec*. The secondary coil of *A*, that is,

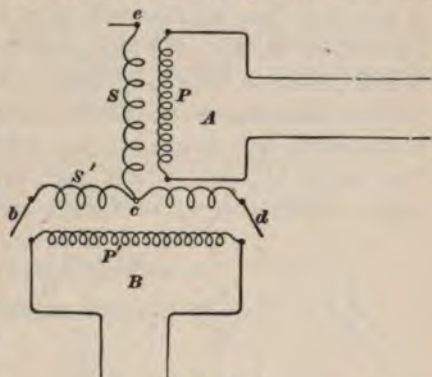

FIG. 1563.

ec, has $\frac{\sqrt{3}}{2}$ times as many turns as the secondary of *B*. The relation of the secondary E. M. F.'s generated in such an arrangement is shown in Fig.



FIG. 1564.

1564; *bd* is the pressure generated in the secondary of *B*, and *ce* is that generated in the secondary of *A*. From the relation of the windings, it follows that *bcd* must be an equilateral triangle; hence, the pressures *be*, *ed*, and *bd* are all equal and differ 120° in phase. If, therefore, three lines are attached to the terminals *b*, *d*, *e*, Fig. 1563, we will have a three-phase system, or if three-phase currents are supplied, they will be transformed to two currents differing in phase by 90° .

4028. An other special use to which transformers are sometimes put is that of raising or lowering the pressure on feeders running from the station. Suppose of *A*, Fig. 1565, to represent a feeder running to some distant point requiring the pressure on this particular feeder to be higher than that on the others connected to the same dynamo. Raising the dynamo pressure would increase the voltage on all the feeders connected to it, and this would make the pressure at points near the station too high. By connecting a transformer as shown in Fig. 1565, the voltage on *A B* may be raised without affecting any of the other feeders. This transformer has its primary *cd* connected across the mains in the usual way, while the secondary is connected in series. The result of this is that the voltage of the secondary is either added to or subtracted from that of the dynamo, thus

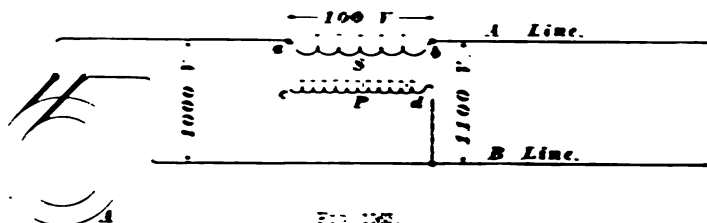

FIG. 1565.

either increasing or decreasing the line voltage. In the case shown, the transformer is wound for 1,000 volts primary and 100 secondary, so that the line voltage is increased from 1,000 to 1,100, provided the terminals *ab* of the secondary are so connected that the secondary voltage is added. The proper method of connecting *ab* is easily found by trial, and can be changed by simply reversing the terminals. The secondary *S* must be of sufficient current-carrying capacity to carry all the current which the feeder *A B* is ever called upon to furnish. The capacity of the transformer must be at least equal to the extra watts which are to be supplied to the line, that is, line current times amount by which voltage is to be raised.

4029. The arrangement described above, using a simple transformer, will, of course, give only one adjust-

ment of voltage. In cases where it is desired to have the voltage adjustable, the secondary coil may be wound in sections, and these cut in or out by means of a switch, thus adding or subtracting any required voltage to or from that of the alternator. Such a device is known as a **Stillwell regulator**, and it is frequently used in central stations to adjust the feeder voltages independently of the pressure furnished by the dynamos.

4030. When induction motors are operated from monocyclic alternators, the transformers are connected as

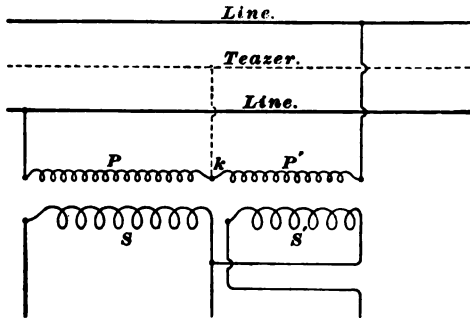

FIG. 1566.

shown in Fig. 1566. Ordinary transformers are used, with their primaries connected in series across the outside mains, the middle point k being connected to the teaser wire.

The secondaries S , S' are also connected in series, but with the secondary of one reversed with regard to the other. This gives three secondary voltages in an approximately three-phase relation. These three voltages will not be equal, the lower voltage being that of the teaser, and the other two combinations of the teaser and main pressures.

4031. Transformers are often used on switchboards to tell when two alternators are in synchronism. Suppose A , Fig. 1567, is an alternator supplying current to bus-bars M , M , and it is desired to connect machine B . The alternator B should be in step with A before being connected,

and in order to tell when this is the case, two small transformers have their primaries c and d connected as shown, corresponding terminals on each primary being connected to similar terminals of A and B . The secondaries e and f are connected in series, as shown, and a couple of incandescent lamps l, l are connected in the circuit. If A and B are

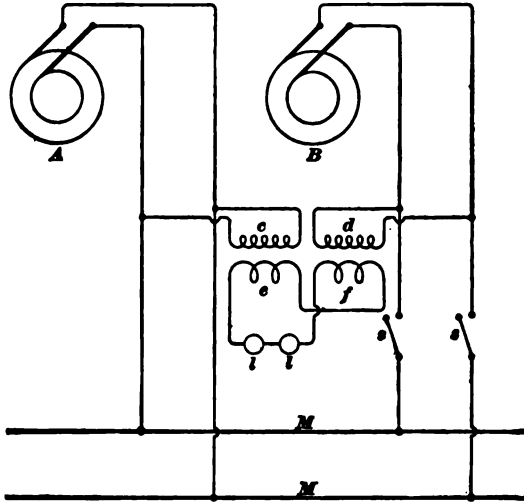

FIG. 1567.

exactly in phase, the E. M. F.'s in e and f would just neutralize each other and the lamps would not light up; if opposite in phase, they would light up to full candle-power. If the machines are not running in synchronism, the lamps will flicker, and the more nearly they get into synchronism, the slower will the flickering become. When, therefore, the beats become very slow, the switches S, S are thrown when the lamps are out, and the machines go on running in parallel. If the connections of one of the transformers were reversed, it is readily seen that the instant when A and B were in phase would be indicated by the lamps being up to full brilliancy instead of being out. Attention should, therefore, be paid to the transformer connections in using such an arrangement for synchronizing alternators.

ALTERNATING-CURRENT MOTORS.

4032. Motors designed for use in connection with alternating currents may be divided into two classes:

1. Synchronous motors.
2. Induction motors.

Both kinds are in common use, and by far the larger part of all the motors operated in connection with the alternate current belong to one of these classes. There are a few other motors which are used to some extent, but their number is insignificant compared with those of the above two classes.

SYNCHRONOUS MOTORS.

4033. **Synchronous motors** are made to operate either on single-phase or polyphase systems, and are so called because they always run in synchronism with, or at the same frequency as, the alternator driving them. In construction they are almost identical with the corresponding alternator, and always consist of the two essential parts, field and armature, either of which may revolve. The field of such motors must be excited from a separate continuous-current machine in the same way as an alternator. The fields of synchronous motors are, however, very seldom compound wound, and hence are provided simply with collector rings, no rectifier being required; otherwise, the whole construction of the motor is about the same as that of the alternator.

4034. If a single-phase alternator be connected to another similar machine, the latter will not start up and run as a motor, because the current is rapidly reversing in its armature, thus tending to make it turn first in one direction and then in the other. The consequence is that the armature does not get started from rest. If, however, the second machine be first run up to a speed such that the frequency of its alternations is the same as that of the alternator, and

then connected into circuit, the impulses of current will all tend to keep it rotating, and the machine will continue running as a motor. The motor would have to be run up to synchronism by means of some outside source of power, and the fact that single-phase synchronous motors will not start of their own accord is a serious drawback to their use. On the other hand, polyphase synchronous motors will start from rest and run up to synchronism, because, before the current has died out in one set of coils, it is increasing in one of the other sets, so that there is always some turning effort exerted on the armature. While starting, such motors take quite a large current from the line, and they will not start at all under any heavy load. They must, therefore, be started up first and the load applied afterwards, when they will continue running in synchronism with the alternator, and will take current from the line in proportion to the work done.

4035. Synchronous motors behave differently in some respects from direct-current machines. If the field of a direct-current motor be weakened, the motor will speed up and the current flowing through the armature will remain practically unchanged. If the field strength of a synchronous motor be changed, the speed can not change, because the motor has to keep in step with the alternator. Such a motor adjusts itself to changes of load and field strength by the changing of the phase difference between the current and E. M. F. Imagine a synchronous motor which, we will suppose, runs perfectly free when not under load. If such a machine were run up to synchronism, and its field adjusted so that the counter E. M. F. of the motor were equal and opposite to that of the dynamo, no current would flow in the circuit when the two were connected. At any instant the E. M. F. causing current to flow is the difference between the instantaneous E. M. F. of the alternator and the counter E. M. F. of the motor. If the motor be loaded, its armature will lag a small fraction of a revolution behind that of the alternator, and the motor E. M. F. will no longer be in opposition to that of the alternator, consequently a cur-

rent will flow sufficiently large to enable the motor to carry its load. The greater the load applied, the larger will be the current which is thus allowed to flow. It must be borne in mind that this phase difference is caused by a small relative lagging of one armature behind the other, not by a difference in speed. For example, the change of phase from full load to no load might not be more than 25° , and this would mean an angular displacement on the machine of a little more than $\frac{1}{4}$ of a pole face. If the machine be loaded too heavily, the slipping back of the motor armature will become sufficiently great to throw the motor out of synchronism, and it will come to a standstill.

4036. Since polyphase synchronous motors will, when not loaded, run up to synchronism of their own accord, they are largely used for power-transmission purposes in places where a large starting effort is not required and where the motor is not started and stopped frequently. They have an advantage over induction motors in that they do not produce lagging currents, and are therefore better adapted for power-transmission plants. What was said with regard to alternator armature windings also applies to synchronous motors, such motors being built for either two or three phase systems.

4037. The speed at which a synchronous motor will run when connected to an alternator of frequency n is $s = \frac{n}{p}$, where s is the speed in revolutions per second and p the number of pairs of poles on the motor. For example, if a 10-pole motor were run from a 125-cycle alternator, the speed of the motor would be $\frac{125}{5} = 25$ rev. per sec., or 1,500 R. P. M. It follows from the above that if the motor had the same number of poles as the alternator, it would run at exactly the same speed, and any variation in the speed of the alternator would be accompanied by a corresponding change in the speed of the motor.

INDUCTION MOTORS.

4038. In a great many cases it is necessary to have an alternating-current motor which will not only start up of its own accord, but one which will start with a strong torque. This is a necessity in all cases where the motor has to start up under load. It is also necessary that the motor be such that it may be started and stopped frequently, and in general be used in the same way as a direct-current motor. These requirements are fulfilled by *induction motors*, which have come largely into use, especially in sizes up to about 100 or 150 H. P.

4039. **Induction motors** are usually made for operation on two or three phase circuits, although they are sometimes operated on single-phase circuits, as explained later. They always consist of two essential parts, namely, the *primary*, or field, to which the line is connected, and the *secondary*, or armature, in which currents are induced by the action of the primary. Either of these parts may be the revolving member, but we will suppose in the following that the field is stationary and the armature revolving. In a synchronous motor or direct-current motor, the current is led into the armature from the line, and these currents reacting upon a fixed field provided by the stationary field-magnet produce the motion. In the induction motor, however, two or more currents differing in phase are led into the field, thus producing a magnetic field which is constantly changing and which *induces* currents in the coils of the armature in the same way that currents are induced in the secondary coils of transformers. These induced currents react on the field and produce the motion of the armature. It is on account of this action that these machines are called induction motors.

FIELD WINDING.

4040. The winding on the field of an induction motor is almost exactly the same as that on the armature of a synchronous motor. The field structure is built up of disks with teeth on their inner circumference, which form slots

when the core is assembled. The coils are placed in these slots, forming a winding like that on the surface of a poly-phase armature. Distributed windings are usually employed; that is, there is generally more than one coil per pole per phase, and the winding when completed resembles

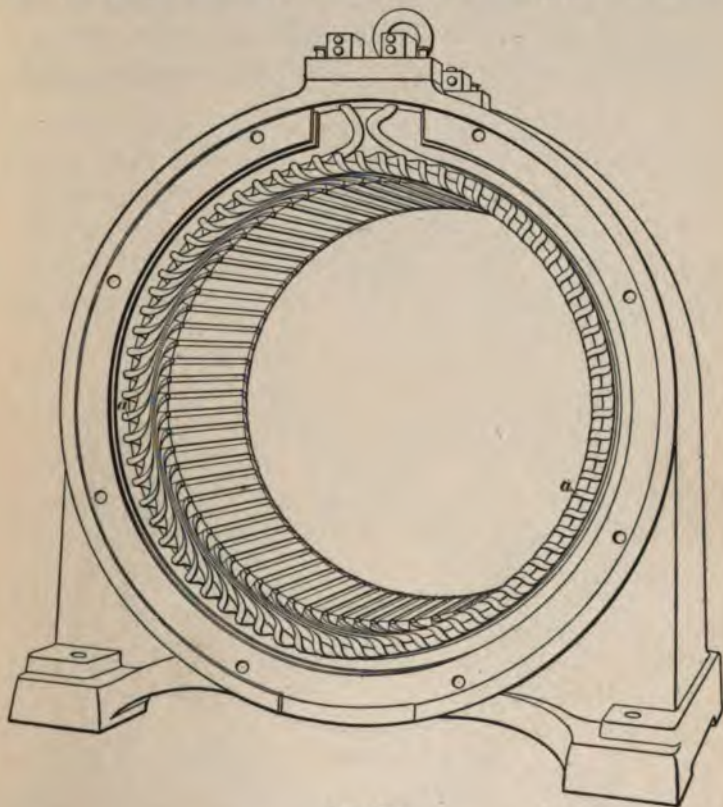

FIG. 1568.

very much the evenly distributed arrangement of coils on a continuous-current armature. Fig. 1568 shows a finished field for an induction motor. The coils are seen at *a, a* distributed evenly around the inner circumference.

4041. The action of the out-of-phase currents in producing a changing field will be understood by taking the case

of a simple two-phase field as shown in Fig. 1569. In order to make the action clearer, we will suppose that the coils are wound on projecting poles instead of being sunk in slots. The field F composed of laminations has eight polar projections, four poles for each phase. Each projection is wound with a coil, and alternate coils belong to the same phase, the winding constituting phase 1 being shown full and phase 2 dotted. The winding is such that if a current is sent

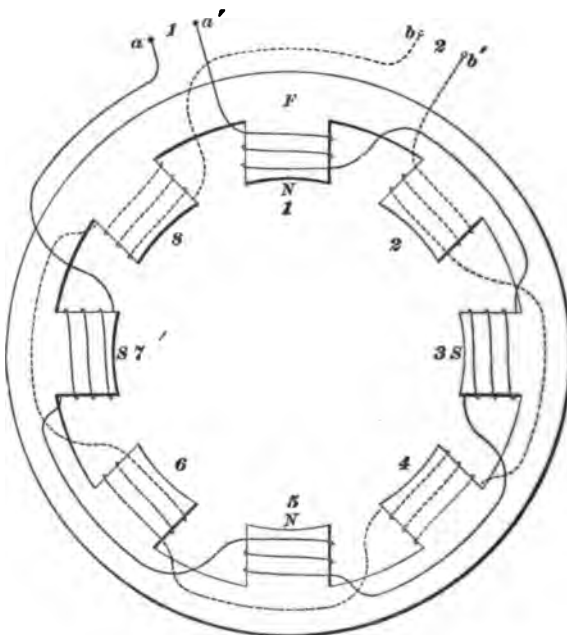

FIG. 1569.

through either of the windings, the poles formed are alternately north and south; for example, 1, 3, 5, 7 would be N and S as shown. If such a field were connected to a two-phase alternator, we would have currents in each of the circuits, differing in phase by 90° and continually reversing in direction. The effect of this is, that as the magnetism in, say, pole 1 dies out, it increases in pole 2, and so on, thus producing the effect of a field continually shifting around or

revolving. In fact, the field produced by the field coils shifts around in the same way that the field is made to shift around the armature of the alternator by its rotation in the field produced by the separately excited field-magnets. We have, then, the effect of a four-pole revolving field, and the speed at which it revolves would depend upon the frequency of the alternator. In this case, if the frequency were 60, the field would make $s = \frac{2 \times 60}{4} = 30$ rev. per sec., or 1,800 R. P. M. The effect of the distributed winding in Fig. 1568 is more uniform than that in the simple motor shown above and causes the motor to exert a more even torque.

4042. Suppose an armature having also eight polar projections to be placed inside the field of Fig. 1569. Each of these projections is wound with a coil c , Fig. 1570, and these

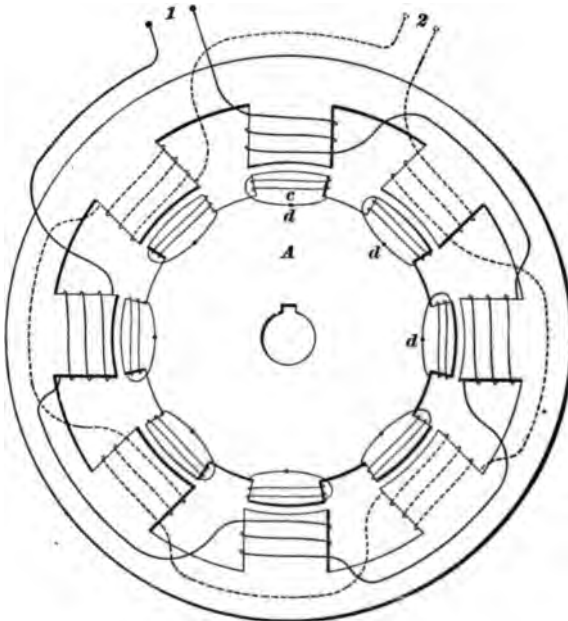

FIG. 1570.

coils form independent closed circuits, since their two terminals are united at the points d . When a current is sent

through the field, a varying magnetic flux is set up through the armature coils, thus generating an E. M. F. in them. Since the coils form closed circuits, the induced E. M. F. causes currents to be set up in them, and this causes the armature to rotate by the reaction of these currents on the field. If the armature were held from turning, the coils on the armature would act like the secondary of an ordinary transformer, and heavy currents would be set up in them. However, as the armature comes up to speed, the relative motion between the revolving field and armature becomes less, and the induced E. M. F.'s and currents become smaller, because the secondary turns do not cut as many lines of force as before. If the armature were running exactly in synchronism with the field, there would be no cutting of lines whatever, no currents would be induced, and the motor would exert no torque. Therefore, in order to have any induced currents, there must be a difference in speed between the armature and the revolving field, and the greater the current and consequent torque or effort, the greater must be this difference. When the load is very light, the motor runs almost exactly in synchronism, but the speed drops off as the load is increased. This difference between the speed of the armature and that of the field for any given load is called the **slip**. The slip in well-designed motors does not require to be very great, because the armatures are made of such low resistance that a small secondary E. M. F. causes the necessary current to flow. In well-designed machines it varies from 2 to 5% of the synchronous speed, depending upon the size. A 20 H. P. motor at full load might drop about 5% in speed, while a 75 H. P. motor might fall off about 2½%. For example, if an 8-pole motor were supplied with current at a frequency of 60, its field would revolve $\frac{60}{4} = 15$ rev. per sec., or 900 R. P. M., and its no-load speed would be very nearly 900. At full load the slip might be 5%, so that the speed would then be 855 R. P. M. It is thus seen that as far as speed regulation goes, induction motors are fully equal to direct-current machines.

ARMATURE WINDING.

4043. The armature winding of induction motors is, like that of the field, placed in slots around the periphery of the drum. In many cases this winding consists simply of a number of heavy copper bars placed in the slots and formed into closed circuits by means of heavy connecting rings at the ends. Such a **squirrel-cage winding**, as it is often called, is shown in Fig. 1571, where the winding bars b are shown bolted to the short-circuiting rings r, r . In some cases, especially in the larger motors, it is best to have the

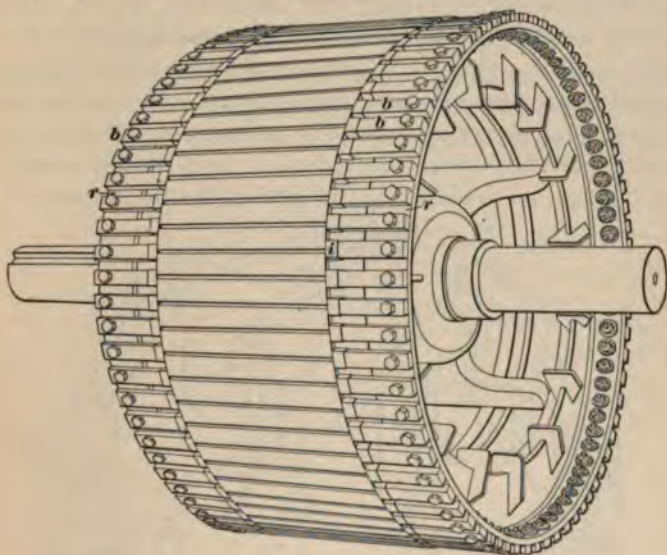

FIG. 1571.

armature winding so arranged that a resistance may be inserted in series with it while the motor is starting up, and cut out when full speed is attained. If this is not done, there will be a large rush of current at starting, because, when the motor is standing still, it is in the condition of a transformer with its secondary short-circuited, and since the armature is stationary with regard to the field, a fairly high E. M. F. might be induced, thus causing a very heavy current to flow through the low-resistance secondary winding.

This would cause a large current to flow in the primary, and would, therefore, be objectionable. Moreover, this large secondary current reacts on the field produced by the primary so as to greatly weaken it, and results in a very small starting torque. If the armature were so designed as to have a fairly high resistance in itself, in order to limit the starting current and procure a good starting torque, the motor would be inefficient and would give bad speed regulation. It is therefore best to have a resistance which may be placed temporarily in the circuit and then cut out. This may be done by supplying the secondary with a regular winding similar to that of the field, and bringing the terminals to collector rings. By means of these, connection may be made to a resistance-box, and resistance cut in or out in much the same way as is done in starting up direct-current motors. In the General Electric Co.'s motors, the use of collector rings is avoided by mounting the resistance on the

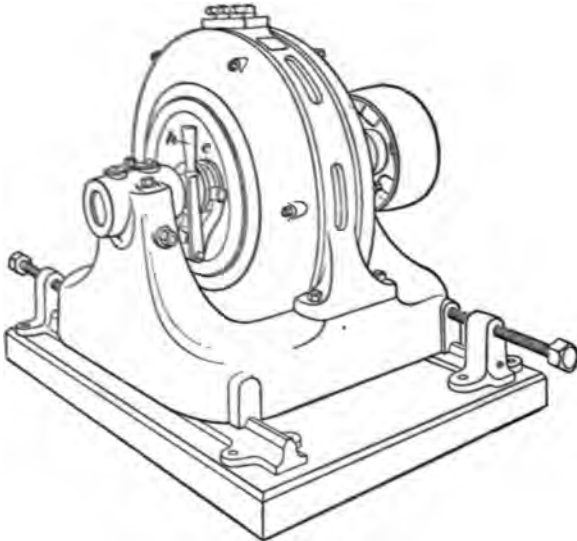

FIG. 1572.

armature spider, and cutting it out by a switch operated by a sliding collar on the shaft. This enables the motor to be built without any moving contacts whatever.

4044. In cases where it is necessary to have induction motors run at variable speeds, it is usual to supply them with collector rings connected to an adjustable rheostat, a method often used where such motors are intended for operating hoists, etc. Fig. 1572 shows one of the above motors with adjustable resistance in the secondary, the handle *h* shown in the figure being used to operate the sliding collar *c*. It also shows the arrangement of the parts of a motor with stationary field and revolving armature.

—

FIELD AND ARMATURE CONNECTIONS.

4045. The field and armature windings of three-phase induction motors are the same as those on three-phase alternators, and such windings may be connected up Υ or Δ , in

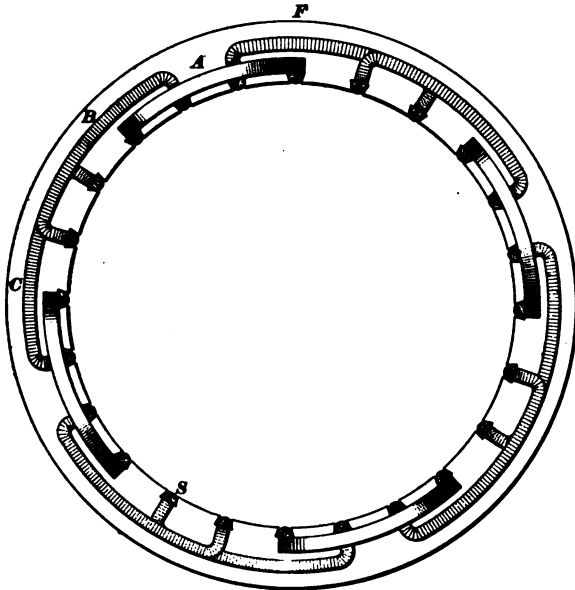

FIG. 1573.

whichever way is best suited to the conditions under which the motor is to work. If, for example, the field were to be connected to high-potential mains, it would probably have

its coils connected up *Y*. Fig. 1573 shows the arrangement of coils for a simple three-phase motor field, the connections between coils not being shown, as the diagram is intended to show simply the arrangement of coils. The field stampings *F* are provided with 24 slots *S*, and there are 12 coils, consisting of three sets *A*, *B*, and *C* of four coils each, set *B* being 120° behind *A*, and set *C* 120° behind *B*. Such a winding, when fed from three-phase mains, would give rise to a 4-pole revolving field. The winding shown has only one coil per pole per phase. Modern induction-motor fields usually have a large number of slots; for example, an 8-pole motor with three coils per pole per phase would have 72 coils and 72 slots if a two-layer winding were used, as is usually done. The windings of induction motors will be treated of more in detail in connection with induction-motor design.

OPERATION OF INDUCTION MOTORS.

4046. Induction motors always give rise to lagging currents in the line; that is, the actual watts taken from

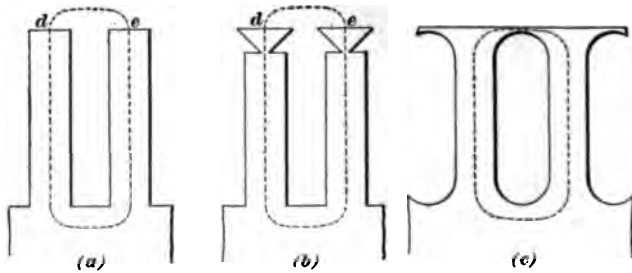

FIG. 1574.

the line is not equal to the volts times amperes, but is this product multiplied by the power factor of the motor. The higher the self-induction of the motor and the higher the frequency, the lower will be the power factor, other things being equal. It is best, therefore, to operate motors at a fairly low frequency, and design them so that their self-induction shall not be too great. The use of open slots, as at (a) and (b), Fig. 1574, tends to keep down self-induction,

because an air-gap de is introduced into the path of the magnetic lines which the coil tends to set up around itself. If closed slots are used, the inductance is greater, because the coils can set up a flux through a complete iron path. The power factor $\cos \Phi$ of a good motor operating on 60 cycles should be from .85 to .87 at full load.

4047. Induction motors are always constructed with a multipolar field, so as to keep down the speed of rotation. The number of poles employed increases with the output, and the speed is correspondingly decreased. The following table gives the relation between poles, output, and speed for some of the standard sizes of induction motors (60 cycle).

TABLE 116.

INDUCTION MOTORS.

Poles.	H. P.	Speed.
4	1	1,800
6	5	1,200
6	10	1,200
8	10	900
8	20	900
10	50	720
12	75	600

PHASE SPLITTING.

4048. Motors are sometimes operated from single-phase circuits by "splitting the phase"; that is, the original single-phase current may be split up into other currents which are out of phase, and thus suitable for starting up a motor. A simple arrangement of this kind is shown in Fig. 1575. The motor is supplied with two windings which are connected to the mains, one in series with a resistance R and the other in series with an inductance L . It is evident

that the current in circuit *B* will lag behind that in *A*, and the motor will therefore be supplied with two currents suitable for starting. After the motor has run up to speed, *R* and *L* are usually cut out and the machine runs as a single-phase motor. A number of starting devices are in use for

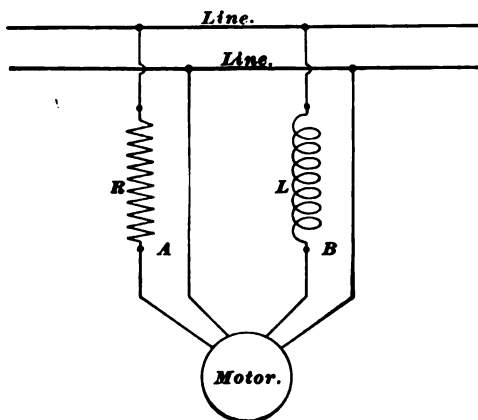

FIG. 1575.

operating motors from single-phase machines; but where a really satisfactory motor is required, the multiphase-induction or synchronous motors are used. The latter are especially valuable for large power-transmission plants, where lagging currents are objectionable.

ROTARY TRANSFORMERS.

4049. It is often necessary to change direct current to alternating, and vice versa, and machines for accomplishing this are known as **rotary transformers**. The transformation might be effected by having an alternating-current motor coupled to a direct-current generator, simply using the alternating current to drive the generator. An arrangement of two machines is, however, not usually necessary, although such motor-generator sets are used to some extent. Rotary transformers are largely used for changing alternating current to direct for the operation of street railways, electrolytic plants, etc.

SINGLE-PHASE TRANSFORMERS.

4050. Suppose an ordinary Gramme ring armature to be revolved in a two-pole field as shown in Fig. 1576; a continuous E. M. F. will be generated and a continuous current obtained by attaching a circuit to the brushes a, a' . If, instead of the commutator, two collector rings were attached to opposite points of the winding, an alternating current would be obtained in a circuit connected to b, b' . If the machine be equipped with both commutator and collector rings, the armature may be revolved by means of

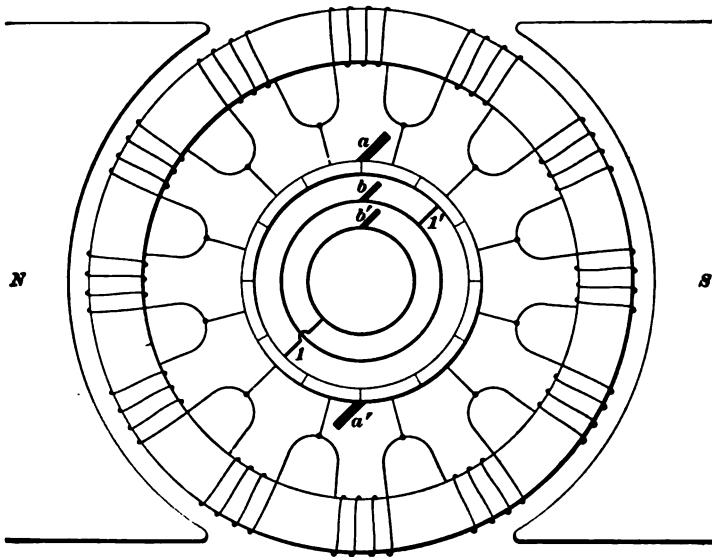

FIG. 1576.

direct current led in at the brushes a, a' , thus running it as a motor instead of it being driven by a belt. The conductors on the revolving armature will be cutting lines of force just as much as they were when the machine was driven by a belt, therefore an alternating current will be obtained from the rings b, b' . In other words, the machine acts as a transformer, changing the direct current into a single-phase alternating current. If the operation be

reversed and the machine be run as a synchronous alternating-current motor, the alternating current will be transformed to direct.

4051. In the above single-phase rotary transformer, it is evident that the maximum value of the alternating E. M. F. occurs when the points I, I' to which the rings are connected are directly under the brushes a, a' ; that is, the maximum value of the alternating E. M. F. is equal to the continuous E. M. F. For example, if the continuous E. M. F. were 100 volts, the *effective* volts on the alternating-current side would be $\frac{100}{\sqrt{2}} = 70.7$ volts. Therefore, if \bar{E} is the alternating voltage and V the direct, we may write for a single-phase rotary transformer,

$$\bar{E} = .707 V. \quad (660.)$$

TWO-PHASE TRANSFORMERS.

4052. By connecting four equidistant points of the

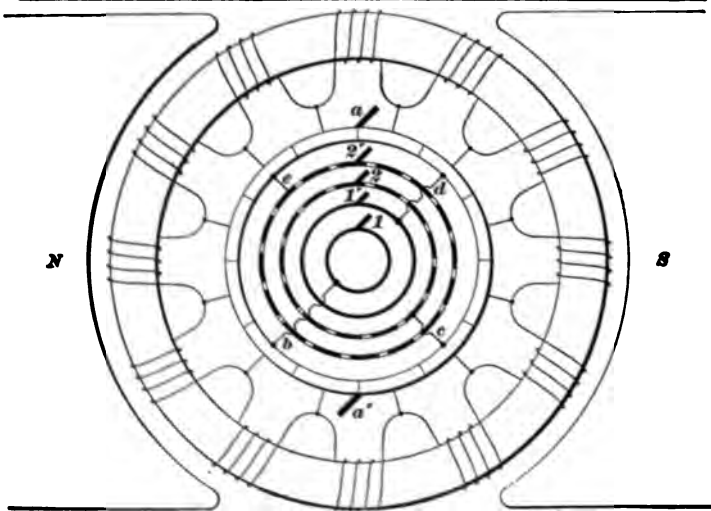

FIG. 1577.

winding $b, c, d,$ and e , Fig. 1577, to four collector rings, we would have a two-pole two-phase, or quarter-phase, trans-

former. In this case we would have two pairs of lines leading from the brushes $1, 1', 2, 2'$. The E. M. F. between 1 and $1'$ or between 2 and $2'$ would be given by formula **660**.

THREE-PHASE TRANSFORMERS.

4053. By connecting three equidistant points as shown at $b, c,$ and $d,$ in Fig. 1578, a three-phase transformer is obtained. Since all direct-current armatures have closed-

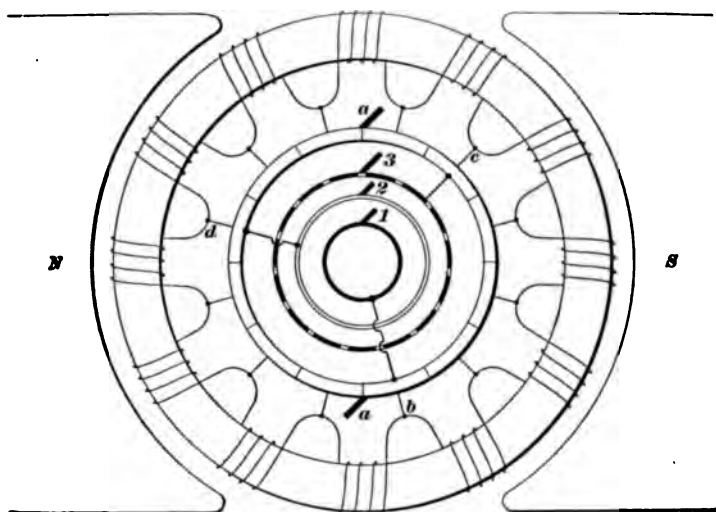

FIG. 1578.

circuit windings, it follows that the connections on the alternating-current side of a three-phase rotary transformer are always Δ , the Y connection not being possible. If \bar{E} be the effective voltage between the lines on the alternating side of a three-phase rotary transformer and V the voltage of the continuous-current side,

$$\bar{E} = .612 V. \quad (661.)$$

If such a transformer were supplied with direct current at 100 volts pressure, alternating current at 61.2 volts would be obtained; and if it were desired to obtain 100 volts direct

current from alternating, the alternating side would have to be supplied at a pressure of 61.2 volts.

The proof of the above relation is as follows:

Suppose the closed-circuit winding of a two-pole rotary transformer is represented in Fig. 1579.

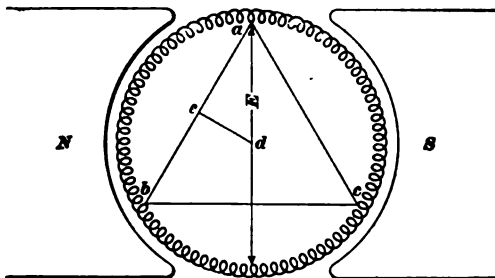

FIG. 1579.

The E. M. F. E obtained across the diameter of the winding would be the continuous E. M. F. of the machine. It would also be the maximum alternating E. M. F. for a single-phase rotary transformer. For a three-phase rotary, the winding would be tapped at three equidistant points, a , b , and c , and the maximum values of the alternating E. M. F. between the three collector rings would be represented by the three lines ab , bc , and ca . To obtain the value of this E. M. F. in terms of the continuous E. M. F., from the center d draw the line dc perpendicular to ab .

Then the angle $adc = 60^\circ$.

$$ac = \frac{1}{2} E \sin 60^\circ,$$

$$ab = 2 ac = E \sin 60^\circ.$$

$ab =$ maximum E. M. F. of alternating-current side of machine. Then the

$$\begin{aligned} \text{effective E. M. F. } \bar{\varepsilon} &= .707 E \sin 60^\circ \\ &= .707 \times .866 \times E \\ &= .612 E. \end{aligned}$$

That is, the E. M. F. obtained from the three-phase side is .612 times that supplied to the direct-current side.

RATIOS OF TRANSFORMATION OF E. M. F.

4054. Rotary transformers are nearly always used to transform from alternating to direct current. The machine runs as a synchronous motor at constant speed, and in order to vary the direct E. M. F., it is usually necessary to change the alternating E. M. F. The E. M. F. of the direct-current side may be varied through a slight range by changing the field excitation, but the usual practice is to use voltage regulators in the alternating-current side, because changing the field strength from its proper value will throw the primary current and E. M. F. out of phase and lower the power factor of the system. If other ratios of transformation than those given above were required, it would not be possible to use an armature with a single winding for both alternating and direct current sides of the machine. In such cases it would be necessary to use either a machine with two distinct armature windings or else a motor-generator set. It is, however, usually possible to get any desired direct E. M. F. from alternating by transforming the alternating current to such a voltage that when delivered to the rotary transformer, it will be changed to direct current of the desired pressure. For example, suppose it were desired to transform alternating current at 2,000 volts to direct current at 500 volts, suitable for operating a street railway. We will suppose that a three-phase rotary transformer is employed. Then it follows from formula **661** that the alternating current must be supplied to the machine at a pressure of $\bar{E} = .612 V = .612 \times 500 = 306$ volts. The alternating current would, therefore, be first sent through static transformers so wound as to reduce the pressure from 2,000 to 306 volts, and the secondary coils of these transformers would be connected to the alternating-current side of the rotary.

MULTIPOLAR ROTARY TRANSFORMERS.

4055. The windings shown in Figs. 1576, 1577, and 1578 show the connections for two-pole machines; but rotary transformers are nearly always made multipolar in

order to reduce the speed of rotation. In the single-phase machine shown in Fig. 1576, it was necessary to have only one connection to each ring; in a multipolar machine it is necessary to have as many connections to each ring as there are pairs of poles on the machine. Fig. 1580 shows the connections for a six-pole single-phase rotary. Here the ring *1* is connected to the points *g*, *h*, and *f*, while *2* is connected at *c*, *d*, and *e*, these points being the equivalent of 180° apart.

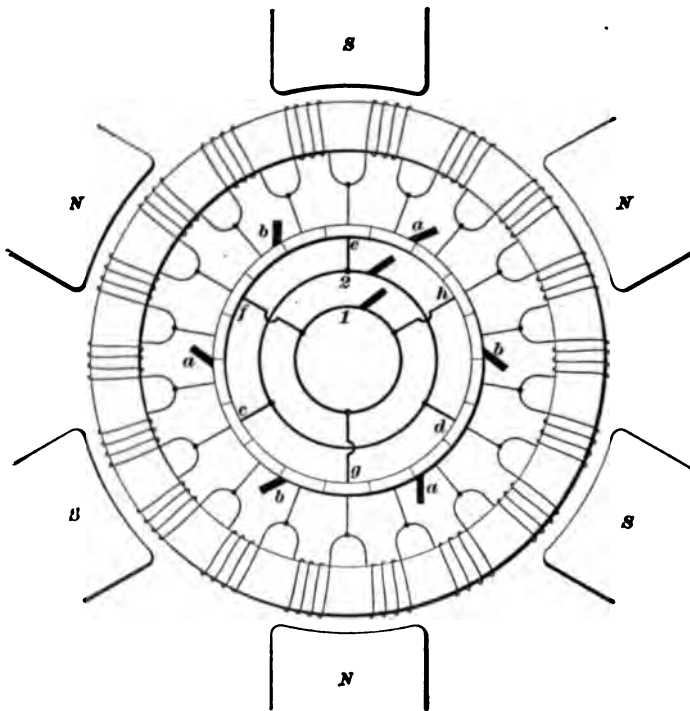

FIG. 1580.

If only two connections were made, as in Fig. 1576, the whole of the winding would not be utilized. Fig. 1581 represents the same armature connected up as a three-phase rotary. Here each of the three rings has three connections as before,

and these connections are the equivalent of 120° apart. For example, the angular distance from *k* to *e* is $\frac{1}{3}$ the distance from north pole to north pole, which represents 360 degrees. Such a winding would, therefore, have the three connections

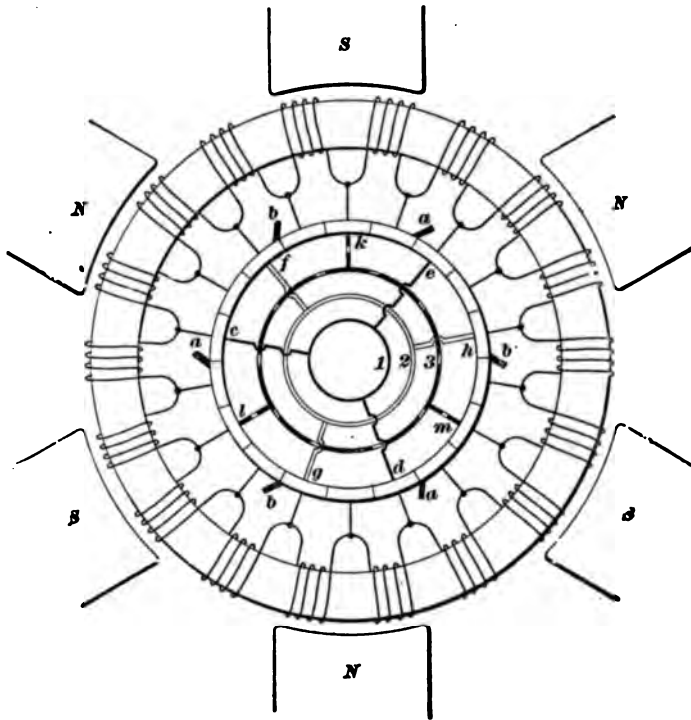

FIG. 1581.

c, d, e for ring 1; *f, g, h* for ring 2; and *k, l, m* for ring 3, there being as many connections for each ring as there are pairs of poles.

4056. Fig. 1582 shows the construction of a modern three-phase rotary transformer. The three collector rings are seen at the left-hand end of the machine, and the com-

2734 ALTERNATING-CURRENT APPARATUS.

mutator is shown at the right. Like alternators, rotary

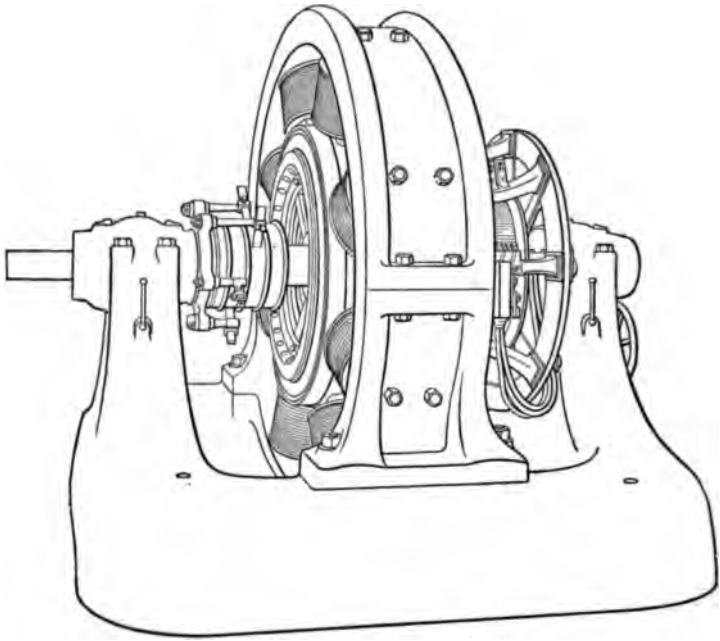

FIG. 1582.

transformers are built for a large range of output and frequency.

DESIGN OF ALTERNATING-CURRENT APPARATUS.

ALTERNATORS.

4057. The design of alternators is in many respects similar to that of multipolar continuous-current machines, many of the parts being very similar. For example, the method of calculating the field ampere-turns, and the design of the field in general, is much the same in these two classes of machines. A great many of the mechanical details are also similar, and much of what has already been given as applying to continuous-current machines applies also to alternators.

4058. Some of the calculations connected with the design of alternators are, however, not so easily made as for direct-current machines, and the production of a good design depends largely upon the skill and previous experience of the designer. For example, there is a large variety of armature windings to select from, and the designer has to decide which winding is best adapted for the work which the alternator has to do. Such calculations as the estimation of armature inductance, armature reaction, etc., are difficult to make without having had previous experience with machines of the same type as that being designed. The quantities are, in general, easily determined after the machine has been built, but their previous calculation is difficult. For this reason the design of alternators is, on the whole, more empirical than that of continuous-current machines. There is also a greater choice as to the mechanical arrangement of the different parts, since either the field or armature may be the revolving member.

For notice of copyright, see page immediately following the title page.

LIMITATION OF OUTPUT.

4059. The output of an alternator, like that of a direct-current machine, is limited by the heating of the armature. This heating is due to two causes, namely, the C^2R loss in the armature conductors, and the core loss due to the hysteresis and eddy-current losses in the mass of iron constituting the armature core. Both these losses appear in the form of heat, and cause the armature as a whole to rise in temperature. Since the maximum temperature at which an armature can be run with safety is limited by the temperature to which the insulating material may be subjected continuously without injury, it follows that this heating effect is an important factor limiting the output of the machine.

4060. The output may in some cases be limited by the self-induction of the armature. If the inductance of the armature is very high, a considerable part of the E. M. F. generated may be used to force the current through the armature itself, thus reducing at the terminals of the machine the E. M. F. available for use in the external circuit. In other words, if an alternator having an armature with high self-inductance is run with a constant field excitation, the voltage between the collector rings will fall off as the load is applied, and if the inductance is excessive, it may result in a limitation of the output of the machine. Usually the limiting current output is reached in well-designed machines before the self-induction has cut down the voltage very largely, so that, in general, the heating effect may be looked upon as the most important item limiting the output. The drop due to inductance is usually compensated for by strengthening the field, so that a higher E. M. F. is generated in the armature and the terminal E. M. F. kept constant.

4061. One effect which in many cases limits the output of continuous-current machines is sparking at the commutator, and it was shown, in connection with continuous-current dynamo design that this sparking is largely due

to the reaction of the armature currents on the field. Armature reaction is also present in alternators, but its effects are not nearly so important as in continuous-current machines, since an alternator has no commutator, and consequently is not subject to the difficulties arising from sparking which are often found in continuous-current machines having weak fields and large armature reaction. The effects of armature reaction in alternators will be taken up later, but from the above it will be seen that this reaction does not affect the action of the machine sufficiently to be considered as a factor limiting the output.

4062. From the preceding it may be concluded that by far the most important limiting factor is the heating of the armature due to the $C^2 R$ losses and core losses. In designing machines, therefore, we will look upon these losses as the limiting factors, and will make the armature sufficiently large to present enough radiating surface to get rid of the above losses without an undue rise in temperature.

HEATING OF ALTERNATOR ARMATURES.

4063. The final temperature which an armature attains when carrying its normal load depends not only on the actual amount of energy wasted in the armature and which appears in the form of heat, but also on the readiness with which the armature can get rid of this heat to the surrounding air. The armature will always keep on increasing in temperature until it reaches a point where it radiates the heat to the air as fast as it is generated. The rise in temperature necessary to accomplish this will evidently depend largely upon the construction of the armature. A well-ventilated armature will get rid of more heat per degree rise than a poorly ventilated one, hence every effort should be made, in designing an armature, to arrange it so that the air can circulate freely around the core and conductors. This is best done by mounting the armature disks on an open spider, and providing air-ducts through the iron core, which allow a circulation of air when the machine is running. By

adopting this construction, makers have been able to reduce the size of armature for a given output compared with the size required for the same output when the older style with surface windings and unventilated core was used. The heat loss due to hysteresis and eddy currents in the core is about the same, whether the machine is loaded or not. Suppose an alternator to be run on open circuit with its field fully excited. There will be no loss in the armature conductors, because the machine is furnishing no current. The mass of iron in the core is, however, revolving through a magnetic field, and there will consequently be a hysteresis loss in the iron, and eddy currents will be set up in the armature disks. These will cause the armature to heat up until the rise in temperature is sufficient to radiate these core losses. When the machine is loaded, we have, in addition to the above, the heat loss in the conductors due to the current which is now flowing. The result is that the armature increases further in temperature until it reaches a final temperature which allows the armature to get rid of all the heat generated in it. If the armature is overloaded, the C^2R loss becomes excessive, and a point is soon reached where it becomes unsafe to load the machine further.

4064. What was said regarding the safe heating limit of the insulating materials used in the construction of continuous-current armatures applies also to armatures for alternators. There is no good reason why an alternator armature should be worked at a higher temperature than that of a direct-current machine, although in many alternators, especially some of the older styles, the limit is much higher. In modern machines, however, the rise of temperature is very little, if any, higher than in continuous-current machines of corresponding output and speed. The final temperature when running fully loaded should not exceed 170° F.

4065. The total temperature which the armature attains when fully loaded depends upon the temperature of the surrounding air. It is not safe to count on less than

90° F. for the average temperature of the surrounding air, because the air in dynamo rooms in summer often goes far above this. A fair rise in temperature may therefore be taken as 70° to 80° F., or from 40° to 45° C. These are the ordinary values used in rating machines, and if an alternator will deliver its full load continuously, with a rise in temperature not exceeding the above, it should be perfectly safe, as far as danger from overheating goes. The rise in temperature of the field coils is generally not quite as high as that of the armature, but it must be remembered that while the outside layers of the coils may be comparatively cool, the inner turns may be quite hot, and it is the greatest temperature which any part of the coils attains which must be taken into account.

RELATION BETWEEN C^2R LOSS AND OUTPUT.

4066. The C^2R loss in an armature at full load

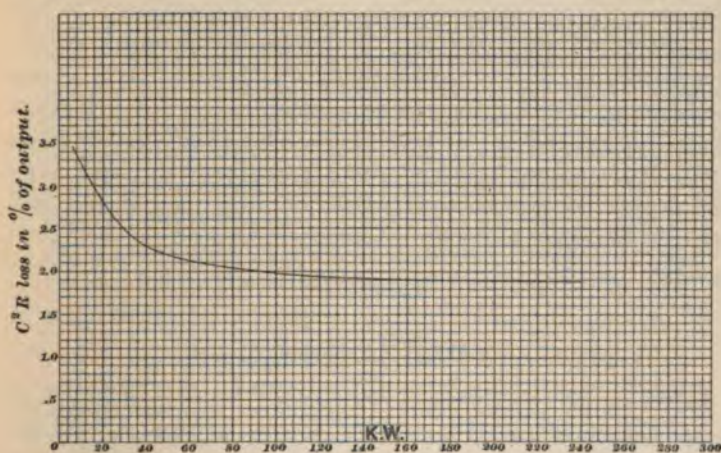

Curve showing relation between armature C^2R loss & output of alternator.

FIG. 1583.

usually bears a certain ratio to the output of the machine. An alternator with an excessive C^2R loss in the armature

conductors would have a low efficiency. It is therefore important that the armature be so designed that the heat loss in the winding shall not exceed a certain proportionate amount of the total output. This loss can be decreased by decreasing the resistance of the armature winding. The resistance can be decreased by either shortening the length of wire on the armature or by increasing its cross-section. A certain length of active conductor is necessary for the generation of the E. M. F.; hence, to keep down the C^2R loss, we must use an armature conductor of large cross-section. The size of conductor, if increased too much, calls for a large armature for its accommodation, and the machine is thus rendered bulky and expensive. All that can be done, therefore, is to design the armature winding so that the heat loss will be as small as is consistent with economy of construction. Older types of alternators had a large armature C^2R loss, but the curve drawn in Fig. 1583 may be taken as giving the average loss for ordinary alternators. The abscissas of this curve give the output in K. W., and the ordinates, the C^2R loss in per cent. of the output. It will be understood that the loss in individual machines might vary somewhat from the values shown, but the curve shows the average relation for machines where the C^2R armature loss is not excessive. It will be noticed that this loss is a much larger percentage for small machines than for large ones. For machines over 100 K. W., the percentage loss does not decrease much with increased output.

CORE LOSSES.

4067. The core losses have already been mentioned as one of the causes producing heat in the armature. These losses are present also in continuous-current armatures, but their effects are usually much less than in alternators. In some alternators the core losses are nearly if not quite as great as the C^2R loss, and consequently the no-load rise in temperature may be considerable.

HYSTERESIS LOSS.

4068. The hysteresis loss constitutes the most important part of the core losses. This loss is caused by the resistance which the iron offers to the changes in magnetism, and it is due to a kind of molecular friction in the iron. This loss plays an important part in the design of alternating-current apparatus, hence it will be well to see upon what quantities it depends. Whenever the magnetism in a given mass of iron is carried through a cycle of values, as it is when rotated past the poles of an alternator, a certain amount of energy is lost. In order to produce this loss the magnetism must be varying. In case the magnetism is constant, there is no hysteresis loss. There is no hysteresis loss, for example, in the field-magnet of a dynamo, because the flux through the magnet does not change in direction, while in the armature the magnetism is constantly changing in direction, due to the rotation. The number of times per second which the magnetism is reversed will depend on the speed of the machine and the number of poles with which it is provided. In an alternator the magnetism passes through $p \times s$ cycles per second where p is the number of pairs of poles on the machine and s the revolutions per second. Steinmetz investigated this hysteresis loss, and found that *the loss per unit volume per cycle is proportional to the 1.6th power of the maximum magnetic density at which the iron is worked.* The loss per unit volume per cycle may then be expressed as a constant times $\mathbf{B}^{1.6}$. The total loss for a given mass of iron at a given frequency n is proportional also to the volume and to the frequency. Hence we may write

$$W_H = \frac{k \times V \times \mathbf{B}^{1.6} \times n}{10^7}, \quad (662.)$$

where

k = a constant depending upon the magnetic qualities of the iron under consideration;

V = volume of iron in cubic centimeters;

\mathbf{B} = magnetic density (maximum) at which the iron is worked;

n = number of cycles through which the magnetism is carried per second;

W_h = energy (in watts) expended in hysteresis.

The constant 10^7 , or 10,000,000, is used to reduce the ergs per second given by the numerator, to watts. The value of the constant k varies considerably with different kinds of iron. For very soft transformer iron it may be from .0020

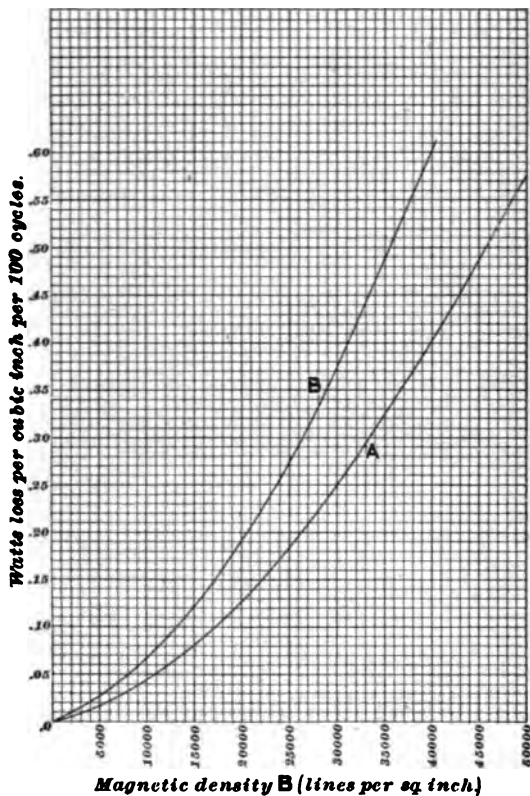

FIG. 1584.

to .0025. Steinmetz gives .0033 as a fair value for armature iron. The formula given is not in convenient form for use in designing, but it shows upon what quantities the

hysteresis loss depends. The curve *A*, Fig. 1584, shows the relation between the maximum magnetic density **B** and the hysteresis loss in watts per cubic inch per one hundred cycles for a good quality of soft transformer iron. The upper curve *B* shows the same relation for ordinary armature iron of good quality.

In order to obtain the total hysteresis loss in watts for a given mass of iron, multiply the value given by the curve corresponding to the maximum density at which the iron is worked by the volume in cubic inches and the frequency, and divide the result by 100.

EXAMPLE.—The armature core of an alternator having 12 poles and running at a speed of 600 rev. per min. is worked at a maximum magnetic density of 20,000 lines per square inch. If the volume of the core is 2,000 cubic inches, how many watts will be wasted in hysteresis?

SOLUTION.—If the machine runs at 600 rev. per min. and has 12 poles, the frequency of the magnetic cycles in the armature core must be $\frac{600}{12} \times \frac{1}{2}$, or 60 cycles per second.

By referring to curve *B*, Fig. 1584, we find the loss per cubic inch per 100 cycles corresponding to a density of 20,000 to be about .19 watt. Hence the total loss will be

$$W_H = \frac{.19 \times 2,000 \times 60}{100} = 228 \text{ watts. Ans.}$$

4069. The student will see by examining formula **662** that the hysteresis loss, other things being equal, increases directly with the frequency. It is on this account that the hysteresis loss is usually greater in alternator armatures than in those used for direct-current machines, because the frequency of the former is usually much higher than that of the latter. Special care should therefore be taken in the selection of core iron for all kinds of alternating-current apparatus. It will also be noticed that the hysteresis loss, being proportional to the 1.6th power of the magnetic density, will increase quite rapidly as the density is increased. It follows, therefore, that the core densities used should be low, otherwise the hysteresis loss may become excessive. It is usual to employ lower core densities in alternating-current machines than in continuous-current

the size of the armature will, for a given output and given amount of loss, depend upon the ease with which it can radiate the heat. The number of watts which an armature can radiate per square inch of surface per degree rise in temperature varies greatly with the style and construction of the armature and the peripheral speed at which the armature is run, so that it is not possible to give any values for this radiation constant which will be applicable to all styles of armatures. A modern well-ventilated iron-clad armature should be able to radiate from .04 to .06 watt per square inch of cylindrical surface (circumference of iron core \times length parallel to shaft) per degree rise. These values are for machines running at peripheral speeds from 4,000 to 5,000 feet per minute; if the peripheral speed were higher, the watts radiated per square inch per degree rise would be correspondingly increased. This means, then, assuming 40° C. to be the allowable rise, that a well-ventilated armature of the above type should be capable of radiating from 1.6 to 2.4 watts per square inch of cylindrical surface. In well-designed machines, the sum of the hysteresis and eddy-current losses will not, as a rule, be greater than the $C^2 R$ loss, so that we will, in general, be safe in assuming that an allowance of .8 to 1.2 square inches of surface for each watt $C^2 R$ loss will give an armature of sufficient radiating surface to keep the total rise in temperature due to all the losses from exceeding 40° C. This will give a preliminary value for the surface of the armature on which to base subsequent calculations, bearing in mind that the dimensions so obtained are not necessarily final, and may be modified as the design is worked out further, provided always that the armature is made of such dimensions that it will be able to get rid of the heat generated. Machines have been built in which the surface per watt is less than that given above, but it will usually be found that such machines run very hot when fully loaded unless their peripheral speed is very high. Alternator armatures of the iron-clad type can usually be constructed so as to secure good ventilation, especially if they are of fairly large diameter, so there should be no

difficulty in radiating the amount of heat given above. The watts per square inch as given are referred to the outside cylindrical surface; of course the ends of the core, and to a certain extent the inside also, help to radiate the heat, but it is more convenient for purposes of calculation to refer the watts radiated per square inch to the outside core surface rather than to the surface of the armature as a whole.

ARMATURE REACTION.

4072. Armature reaction, in connection with alternators, has already been mentioned in a general way, and it now remains to be seen just how it affects the action of a machine when loaded. The matter of armature reaction plays an important part in the design of continuous-current machines, as has already been shown in the section on the design of such dynamos. If the armature of a continuous-current machine is capable of overpowering the field, bad sparking will result at the commutator. This, however, can not occur in the case of an alternator, as mentioned in Art. **4061**, and the only bad effect which the reaction can have is to cause a weakening and distortion of the field. Its effects are not nearly of so much importance, and consequently do not need to be investigated so fully.

4073. Let N , Fig. 1585, represent one of the north poles

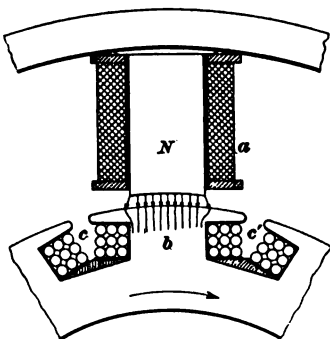

FIG. 1585.

of an alternator, surrounded by its magnetizing coil a . The lines of force will flow into the armature from the pole-piece as indicated by the lines and arrow-heads. We will consider the instant when the coil $c c'$ has its opening directly under the pole, or when the center of the tooth b is opposite the center of the pole-piece. If the armature has no self-induction, the current flowing through the armature will be in phase with

the E. M. F. generated; consequently, at the position shown in the figure, the current in the coil will be zero, because the coil is cutting no lines of force, and the E. M. F. generated is consequently zero. It follows, then, that under this particular set of conditions the armature coil has no disturbing effect upon the lines of force set up by the field. The direction of rotation is indicated by the arrow, and a moment later the bundle of conductors in the slot *c* is under the center of the pole, as shown in Fig. 1586. The current in the conductors will now be at its maximum value, because the E. M. F. generated is at its maximum. The current will be flowing down through the plane of the paper, and the bundle of conductors lying in the slot will tend to set up lines of force around themselves as shown by the dotted lines and in the direction shown by the arrow-heads. It will be noticed that this field set up by the conductors tends to strengthen the right-hand side of the pole and weaken the left-hand side by a like amount. The resultant effect is therefore to crowd the field forwards in the direction of rotation, making it denser at the right-hand side, as shown in Fig. 1587.

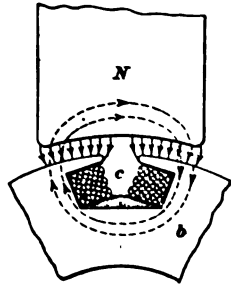

FIG. 1586.

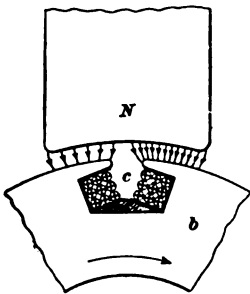

FIG. 1587.

It is therefore seen that in this respect the effect of armature reaction is similar to the effect observed in direct-current machines; but in an alternator with coils as shown in the above figures, the effect on the field is not steady, but varies as the teeth move past the poles. The student should note that in this case the armature is assumed to have no self-induction, and also that the armature reaction tends only to change the distribution of the field and not to weaken it.

4074. Armatures always have more or less self-induction, especially if they are provided with heavily wound

coils sunk in slots. The effect of this self-induction is, of course, to cause the current in the armature to lag behind the E. M. F. It is necessary, then, to see how this lagging of the current affects the reaction of the armature on the field. In this case the current in the coil does not die out at the same instant as the E. M. F., but persists in flowing after the E. M. F. has become zero. The current, instead of being zero when the tooth is under the pole, will then be flowing as shown in Fig. 1588; that is, the current in the conductors in slot *c*

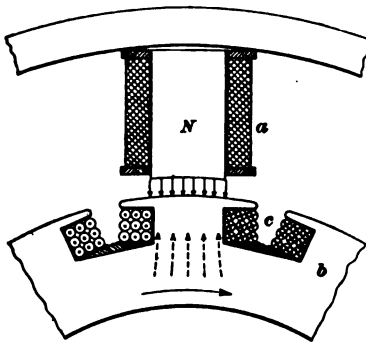

FIG. 1588.

persists in flowing, as shown in Fig. 1587, after the conductors have moved out from under the pole-piece. This current flowing in the armature coil will set up lines of force through the coil in the direction shown by the dotted arrows, i. e., directly opposed to the original field. The armature reaction, therefore, not only tends to distort the field, but also tends to weaken it when there is a lagging of the armature current due to self-induction in the armature. This reaction of the armature on the field would of course cause a falling off in the voltage of the machine if the field-magnets were not strengthened to counterbalance its effects. It is instructive to note here that if it were practicable to have a condenser in connection with the armature, the current could be made to lead the E. M. F., and the armature reaction would then tend to magnetize the field instead of demagnetize it.

4075. It is seen from the above that in alternator armatures in which there is an appreciable amount of self-induction present, we have two effects similar to those produced by the cross ampere-turns and back ampere-turns of a continuous-current armature, the former tending to distort the field, and the latter acting directly against it and

tending to weaken it. The bad effects of this reaction can be reduced, as in the case of direct-current machines, by lengthening the air-gap. The actual amount of distortion or demagnetization is not easily calculated, as it evidently changes with the changes in the current, and also depends upon the armature inductance, which is itself difficult to estimate without data from machines of the same type. The distribution of the field can be determined after the machine has once been built, and unless the air-gap is very short, the distortion is not sufficient to badly affect the working of the machine.

4076. One effect of armature reaction is sometimes taken advantage of in designing armature windings, namely, the crowding together of the lines to one side of the pole-piece. This practically makes the effective width of the pole face less and allows the use of coils on the armature with an opening somewhat less than the width of the pole face, without danger of the E. M. F.'s in the different turns of the coil opposing each other. (See Art. **3959**, Theory of Alternating-Current Apparatus.)

ARMATURE SELF-INDUCTION.

4077. It has just been shown that the self-induction of the armature is, indirectly, responsible for the demagnetization of the field, which in turn produces a falling off in voltage. Self-induction also calls for a considerable E. M. F. to force the current through the armature, and this causes a still further diminution in the E. M. F. obtained at the terminals. This drop in voltage has already been explained in the section on Theory of Alternating-Current Apparatus. A machine with high armature self-induction will not maintain a constant terminal pressure unless the field is strengthened as the load is applied, and such machines therefore require heavily compounded fields.

4078. In general, armatures wound with a few heavy coils bedded in slots have a high self-induction, because the

coils are able to set up a large number of lines around themselves when a current flows through the armature. Machines with this style of armature winding usually give an E. M. F. curve which is more or less peaked and irregular. Such windings are easily applied to the armature, and being of very simple construction they necessitate very few crossings of the coils at the ends where the coils project from the slots. Such armatures are, therefore, easy to insulate for high voltages, and are extensively used on alternators for operating incandescent lights.

4079. The inductance of an armature is, other things being the same, proportional to the *square of the number of turns per coil* or to the *square of the number of conductors per slot*. For example, suppose an armature has 6 coils of 40 turns each and that the inductance of each coil is .02 henry. The coils are supposed to be connected in series, so that the total inductance of the armature will be $6 \times .02$, or .12 henry. Suppose, now, the winding to be split up into 12 coils of 20 turns each, the shape and arrangement of the coils being kept the same. We will then have the same total number of turns as before, but will have half as many turns per coil or half as many conductors per slot. The inductance of each coil will therefore be one-fourth of what it was before, because the inductance will decrease as the square of the number of turns per coil. The inductance per coil will then be $\frac{1}{4} \times .02$, or .005 henry, and the total inductance will be $.005 \times 12 = .060$ henry, or one-half of what it was in the former case. In order, then, to decrease the inductance of an armature, the number of turns per coil must be decreased, or, what amounts to the same thing, the number of conductors per slot must be decreased.

4080. Alternators provided with armatures of low inductance give a much better E. M. F. regulation than those having high inductance armatures, because the reaction on the field is not only less, but much less of the E. M. F. generated is used up in driving the current

through the armature. In other words, such machines, if provided with a constant field excitation, will show only a slight falling off in terminal voltage from no load to full load. On this account, it is quite common to find such machines built without any compound or series winding on the fields, all the regulation necessary being accomplished by varying the current supplied to the field coils by the exciter. Such alternators give a smooth E. M. F. curve which approximates closely to the sine form, and alternators of this type are being used extensively for power-transmission purposes.

4081. An excessive amount of armature inductance, and consequent demagnetizing armature reaction, has been used to make alternators regulate for constant current. In such machines the armature inductance is made very high, and a small air-gap is used between the armature and field. If the current delivered by such a machine tends to increase by virtue of a lowering of the external resistance, the armature reaction on the field increases, and the field is weakened. This cuts down the voltage generated, so that the voltage adjusts itself to changes in the load, and the current remains constant.

PERIPHERAL SPEED OF ALTERNATOR ARMATURES.

4082. Alternators have been built which run at peripheral speeds much higher than those used for continuous-current machines. This was the case in many of the older types of lighting machines running at a high frequency. High peripheral speeds were used with these machines in order to keep down the number of armature conductors required for the voltage generated, and thus obtain low armature inductance. Since the frequencies employed were high, the revolutions per minute of the armature had also to be high in order to avoid using a very large number of poles. This high speed of rotation usually resulted in high peripheral speeds also because the armature could not

be made very small in diameter. Such machines often ran at peripheral speeds as high as 7,000 or 8,000 feet per minute. It may be stated that, in general, 125-cycle alternators run at higher peripheral speeds than low-frequency machines.

4083. The frequency of a great many modern machines is lower than that which was formerly used, 60 cycles per second being a standard value. The lowering of the frequency was accompanied by a lowering of the peripheral speed, and the peripheral speeds of modern alternators compare quite favorably with the speeds of multipolar direct-current machines of the same output. Peripheral speeds for belt-driven 60-cycle alternators may be taken from about 3,500 to 5,500 feet per minute. The peripheral speed of some of the larger direct-connected alternators may be even lower than this, just as the peripheral speed of multipolar direct-current generators is usually lower than that of belt-driven machines.

ARMATURE WINDINGS.

4084. The foregoing articles have dealt with different subjects relating to the operation of armatures. We will now take up those subjects which deal more particularly with their design. Some of the most important points in the design of an armature are the selection of the type of winding to be used for a given case, the method of connecting it up, and the means used for applying the winding to the armature. Alternator windings have already been dealt with to some extent in the section on Theory of Alternating-Current Apparatus, but the following articles are intended to bring out some points of difference between concentrated and distributed windings which are necessary for the designing of armatures for alternators and fields for induction motors.

4085. Alternator windings may be divided into two general classes, namely:

- A.* Uni-coil or concentrated windings.
- B.* Multi-coil or distributed windings.

These may further be subdivided into

1. Uni-coil single-phase windings.
2. Multi-coil single-phase windings.
3. Uni-coil polyphase windings.
4. Multi-coil polyphase windings.

The uni-coil windings for single-phase, two-phase, and three-phase machines have been treated in the section on Theory of Alternating-Current Apparatus. We will presently examine single-phase multi-coil or distributed windings to see how the spreading out of the winding affects the voltage generated by the armature.

SINGLE-PHASE CONCENTRATED WINDING.

4086. A single-phase concentrated winding has only one slot or bunch of conductors under each pole; consequently the conductors are practically all active at the same instant, and the maximum E. M. F. is obtained with a given length of active armature conductor. This E. M. F. is given by the formula

$$\bar{E} = \frac{4.44 N T n}{10^8}, \quad (\text{See formula 617, Art. 3882.})$$

where T = No. of turns connected in series on the armature;

N = total magnetic flux from one pole;

n = frequency;

\bar{E} = E. M. F. generated in armature, or E. M. F. obtained between the collector rings at no load.

Such windings have therefore the advantage of giving a high E. M. F. for a given length of conductor, but they have the disadvantage that they give rise to high armature self-induction and consequent falling off in terminal voltage when the machine is loaded.

SINGLE-PHASE DISTRIBUTED WINDINGS.

4087. It was shown in Art. 4079 that the self-induction could be reduced by splitting up the coils and distributing them over the armature. Such distribution is, however, always accompanied by a lowering of the E. M. F. generated,

even though the total number of turns be kept the same. Suppose, for example, we have a single-phase armature with T turns, or $2T$ conductors, connected in series and arranged with only one slot or bunch of conductors under each pole. The E. M. F. generated will then be

$$\bar{E} = \frac{4.44 N T n}{10^8}$$

Suppose now we spread the winding out so that there will be two sets of conductors or two slots for each pole, and

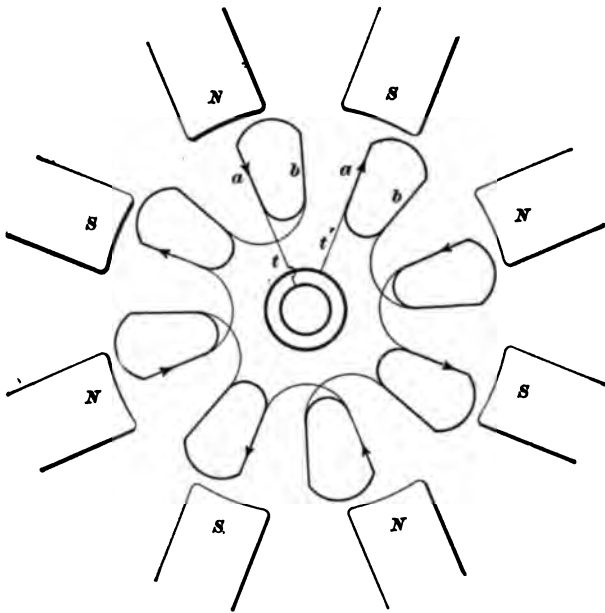

FIG. 1580.

distribute these slots equally around the armature. We will put half as many conductors as before in each slot, so that the total number of conductors and turns will remain the same as before. This will give us a winding similar to that shown in Fig. 1589. This shows an 8-pole single-phase winding with *two* slots per pole-piece. By examining the figure, it is evident that with such an arrangement the conductors in slot *b* are generating zero E. M. F., while those

in a are generating their maximum E. M. F. Of the total turns on the armature, one half is therefore idle, while the other half is active. The E. M. F. which will be obtained between the collector rings will be the sum of the two, as shown in Fig. 1590. Oa represents the E. M. F. generated in one set of conductors, while $O b$ represents the E. M. F. generated in the other. These two E. M. F.'s will be equal, and will be given by the expression

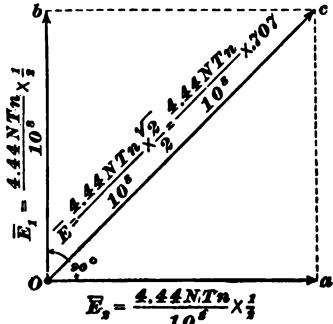

FIG. 1590.

$$\bar{E} = \frac{4.44 N T n}{10^8} \times \frac{1}{2}, \quad (663.)$$

since there are $\frac{1}{2}$ the total turns T active in each set. The resultant E. M. F. $O c$ will therefore be

$$\bar{E} = \frac{4.44 N T n}{10^8} \times \frac{1}{2} \times \sqrt{2} = \frac{4.44 N T n}{10^8} \times .707. \quad (664.)$$

That is, the E. M. F. which is obtained at no load from a two-coil single-phase winding is .707 times that which would have been obtained with the same total number of turns grouped into a uni-coil winding. By spreading out the winding in this way, the no-load voltage has, for the same number of active conductors, been reduced about 30 per cent.; the inductance of the armature has, however, been reduced to one-half (see Art. 4079); so that, although we may not get an armature which will give as high a voltage at no load, it may give as high a terminal voltage when loaded, and a machine provided with such a winding would hold its voltage more nearly constant throughout its range of load.

4088. The subdivision of the winding might be carried still further, and three slots for each pole-piece used. The E. M. F.'s in the three sets of conductors would then be related as shown in Fig. 1591. Each of the groups would consist of $\frac{T}{3}$ turns, and the three E. M. F.'s $O a$, $O b$, and $O c$

would be displaced 60° from each other, instead of 90° , as shown in Fig. 1590, because there are three groups of conductors per pole, and the distance from center to center of

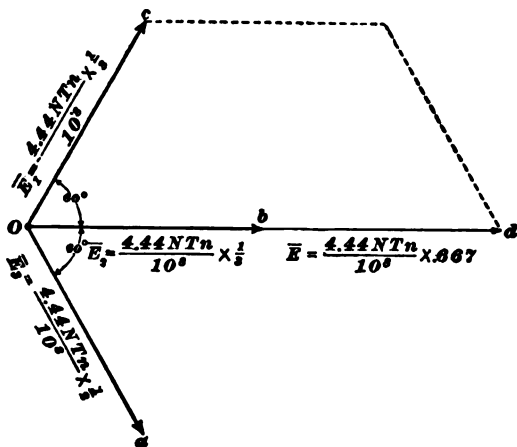

FIG. 1591.

the pole-pieces corresponds to 180° . The E. M. F. generated in each set will be

$$\bar{E}_1 = \bar{E}_2 = \bar{E}_3 = \frac{4.44 NTn}{10^8} \times \frac{1}{3}, \quad (665.)$$

and the resultant E. M. F. Od , Fig. 1591, will be

$$\bar{E} \times \frac{4.44 NTn}{10^8} \times \frac{1}{3} = \frac{4.44 NTn}{10^8} \times 0.67. \quad (666.)$$

The effect of spreading out the coils into a three-coil winding is, therefore, to reduce the no-load terminal E. M. F. still further, and at the same time to reduce the self-induction. It will be noticed that the difference in the voltages given by a two-coil and by a three-coil winding is not nearly so great as that between the voltages of the two-coil and single-coil windings. If the winding is spread out still more, the E. M. F. generated is reduced by very little, and if the subdivision is carried out so that the winding becomes

uniformly distributed over the whole surface of the armature, the formula becomes

$$\bar{E} = \frac{4.44 N T n}{10^8} \times .636. \quad (667.)$$

4089. The more the winding is spread out, the greater the number of crossings of the coils at the ends of the armature, making such windings difficult to insulate for high voltages. Such windings, therefore, have the disadvantage of being more expensive to construct and insulate, in addition to giving a lower E. M. F. at no load for a given length of active conductor. They have the advantage of giving better regulation or small drop in voltage when loaded, and also give a smooth E. M. F. curve. For *single-phase* armatures in general, we may then write the E. M. F. equation as follows:

$$\bar{E} = \frac{4.44 N T n}{10^8} \times k, \quad (668.)$$

where T = total number of turns *connected in series* on the armature;

N = total flux from one pole;

n = frequency;

k = a constant depending upon the style of winding used.

For a single-coil or concentrated winding, $k = 1$.

For a two-coil winding, $k = .707$.

For a three-coil winding, $k = .667$.

For a uniformly distributed winding, $k = .636$.

POLYPHASE ARMATURE WINDINGS.

4090. Concentrated, or uni-coil, polyphase windings have already been described in the section on Theory of Alternating-Current Apparatus. The two and three phase windings there described consist of one group of conductors or one slot for each pole and each phase. Polyphase windings can, however, be distributed in a manner similar

to that just given for single-phase windings, and such distributed windings are in common use for induction motors, polyphase alternators, and polyphase synchronous motors. The distribution of such windings is accompanied by a lowering of the terminal E. M. F., as in the case of single-phase windings, though this decrease in the E. M. F. is not nearly so great. Suppose, for example, we have a three-phase winding with two groups of conductors per pole per phase. We will have then six groups of conductors for each pole, and as the distance from center to center of poles is equivalent to 180° , the E. M. F.'s in the two groups of each phase will differ in phase by $\frac{180^\circ}{6}$, or 30° . Let the total number of turns per phase be T . Then the number of turns in each of the two sets constituting each phase will be $\frac{T}{2}$, and the E. M. F. generated in each of the sets will be

$$\bar{E}_1 = \bar{E}_2 = \frac{4.44 N T n}{10^8} \times \frac{1}{2}.$$

These two E. M. F.'s will be related as shown in Fig. 1592, and the resultant E. M. F. will be

$$\begin{aligned} \bar{E} &= \frac{4.44 N T n}{10^8} \times \frac{1}{2} \times 2 \cos 15^\circ \\ &= \frac{4.44 N T n}{10^8} \times .965. \quad (669.) \end{aligned}$$

Hence, *the voltage generated per phase by a two-coil three-phase winding is .965 times that which would be generated by a single-coil winding.* In other words, the splitting up of the winding has resulted in a reduction of only $3\frac{1}{2}\%$. If a three-coil winding were used, the E. M. F. would be reduced still further, and if a uniformly distributed winding covering the whole surface of the armature were employed, the constant would become .95. If a uniformly distributed winding is used on a two-phase machine, the value of the constant becomes .90. For polyphase windings we may then sum-

marize the following: The E. M. F. *generated per phase* in a polyphase armature is given by the expression

$$\bar{E} = \frac{4.44 N T n}{10^8} \times k, \quad (670.)$$

where T = number of turns connected in series *per phase*;

N = flux from one pole;

n = frequency;

k = constant depending upon the arrangement of the winding.

For a winding with one group of conductors per pole per phase,

$$k = 1.$$

For a two-phase winding uniformly distributed, $k = .90$.

For a three phase winding uniformly distributed, $k = .95$.

For a three-phase winding with two groups of

conductors per pole per phase, $k = .965$.

The student will notice particularly that formula 670 gives the *voltage per phase*, not the voltage between the

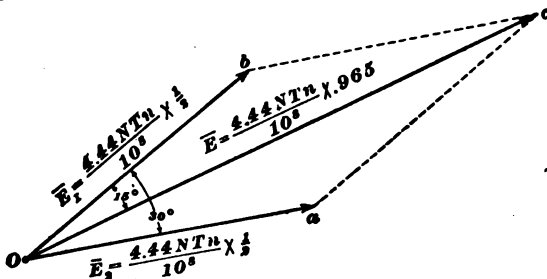

FIG. 1592.

collector rings or terminals of the machine. This latter voltage will evidently depend upon the method adopted for connecting the different phases together.

ARRANGEMENT OF WINDINGS.

4091. The method of arranging these distributed windings will be understood by referring to Figs. 1593 and 1594. Fig. 1593 shows a six-pole two-phase coil-wound armature with two slots per pole per phase. The coils are

shown by the heavy outlines, the winding being in two layers, so that there are as many coils as slots. Only one phase is drawn in complete, so as not to confuse the drawing. Take the coil A . One side e of this coil lies in the top of a slot, and the other side f lies in the bottom of the corresponding slot under the next pole. The light lines a , a' represent the terminals of the coil A , and the light connections show the connections between the coils constituting one phase. Starting from collector ring 1, we pass from a around coil A and come to a' ; a' is joined to b , so that the current passes around coil B in agreement with the arrows; the terminal b' is then connected to c' , so as to pass through coil C in the direction of the arrows. This process is repeated until the twelve coils constituting the phase are all connected in series, and the remaining terminal l is brought to collector ring 2. The other phase, of which the active conductors are indicated by the light lines, is connected up in exactly the same way, and its terminals brought to the collector rings 3 and 4. This gives a completed two-phase winding which consists of two coils for each pole and for each phase, all the coils in each phase being connected in series, and each phase connected to its pair of collector rings.

4092. Fig. 1594 represents a three-phase bar-wound armature with four bars for each pole and each phase. The armature is wound for 8 poles, so that there are 32 bars or conductors connected up in series in each phase. One phase is shown connected up, the conductors belonging to the other two phases being indicated by the dotted and dot and dash lines. Starting from the collector ring r , we connect to the bottom conductor in slot 1, from there we pass to the corresponding slot under the next pole, that is, slot 7, and connect to the top conductor in that slot. In this way we pass twice around the armature, connecting up the bars in accordance with the arrows, coming finally to the point n . From n a connection is made to m , and from m we pass twice around the armature again in the opposite direction,

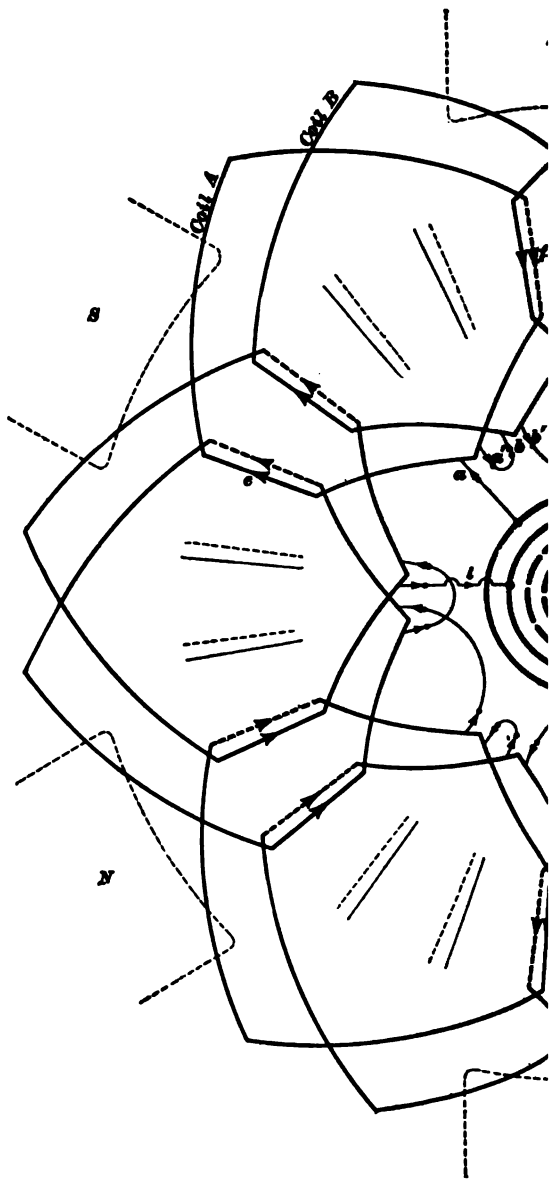

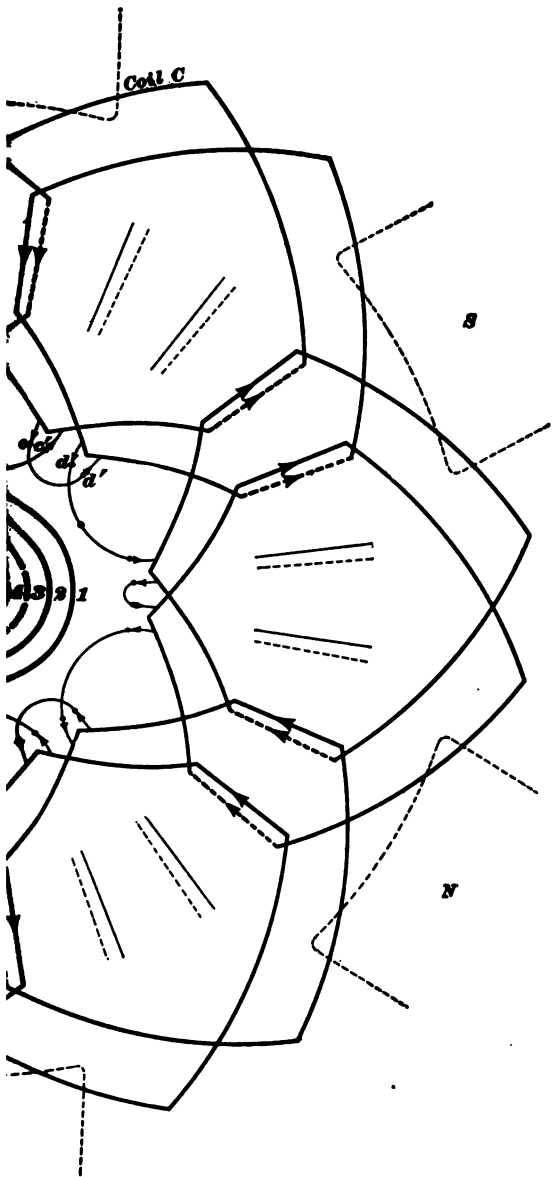

1

i

4

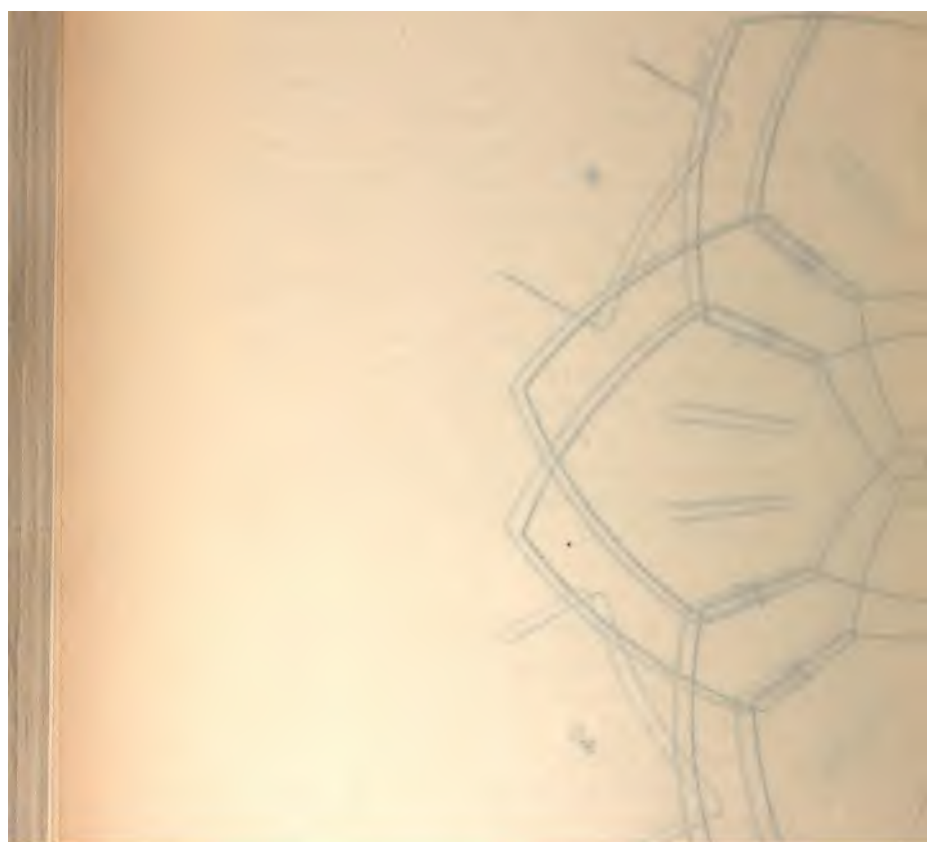

4



and come finally to the point s , which is connected to the common junction k if a **Y** winding is employed. This connects all the conductors belonging to this phase in series by what is known as a **wave winding**, so called because the winding progresses around the armature from one bar to the next. The bars constituting the other two phases are connected up in a similar way, and the three phases connected up in the **Y** or Δ combination, according to the rules which have been given in the section on Theory of Alternating-Current Apparatus. A three-phase alternator provided with a winding like that shown in Fig. 1594 would be suitable for a machine designed to deliver a large current output at a low voltage. In such a case the number of armature conductors required would be comparatively small, and hence bars could be used to advantage. A similar scheme of connection could be used for a coil-wound armature, except that in this case each element of the winding would consist of a number of convolutions instead of the single turn as shown in Fig. 1594.

4093. By referring to Figs. 1593 and 1594, it will be noticed that in such two-layer windings the top conductors are always connected across the front and back of the armature to bottom conductors; that is, a conductor in the top of one slot is not connected to the *top* conductor in the corresponding slot under the next pole. This is done to make the arrangement of the end connections such that they do not interfere with each other. Take the end connections on the back of the armature (connections next the poles). It will be noticed that all the end connections attached to the top bars slant in one direction, while all those attached to the bottom bars slant in the other; consequently, if the top and bottom connections are arranged in two different planes, the crossings will be effected without the connections interfering with each other. The two-layer type of winding is on this account extensively used, and its application will be taken up further in connection with induction-motor design.

CONSTRUCTION OF ARMATURES.

4094. On the whole, the mechanical construction of alternator armatures is very similar to that employed for armatures for multipolar direct-current machines. There are differences in the electrical features, arising from the different type of winding usually employed and the absence of commutator connections. The construction of many of the armatures is simpler than that necessary for continuous-current machines, on account of the smaller number of coils used in making up the armature winding.

ARMATURE DISKS.

4095. Most of the armature disks used are adapted for armatures of the drum type. Such disks or disk segments are stamped from well-annealed soft iron. Very mild steel is also used for such disks, as it is practically as good magnetically as the sheet iron. It is essential, however, that whatever material is used, the hysteresis factor should be low, especially if the armature is to be run at a high frequency. It is almost the universal practice at present to use toothed cores, although smooth-core armatures were quite common in some of the older types of machines. Core iron should be from .014 in. to .018 in. or 14 to 18 mils thick. Iron thicker than this is frequently used in direct-current machines, but it is not safe to use iron much thicker in alternator-armature cores on account of the danger of increasing the eddy-current loss. Some makers depend upon the oxide on the disks for the insulation to prevent eddy currents, while other makers give the disks a coat of japan before they are assembled to form the core.

4096. The variety of disks used for alternator armatures is large. Some are designed for stationary armatures of large diameter, while others are for rotating armatures of comparatively small diameter. The different styles of slots used are also numerous. Fig. 1595 represents one common style of disk used for lighting-alternators, and is

designed to accommodate a winding similar to that shown in Fig. 1512, Theory of Alternating-Current Apparatus. This disk is provided with as many teeth and slots as there are poles on the alternator. Each tooth is provided with the projections *a, a*, which hold the coils in place and obviate the necessity of band wires. A keyway *k* is provided by which the disks are keyed to the spider supporting them. It is well to notice in passing that core disks for alternators are usually

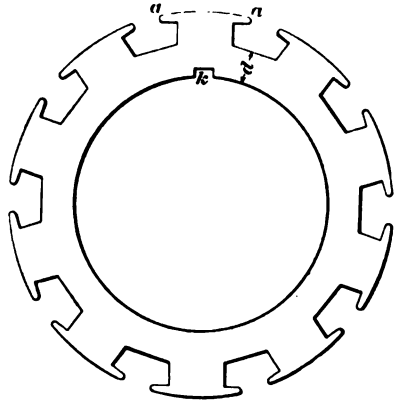

FIG. 1595.

quite shallow, the depth of iron *d* under the slots being small compared with that usually found in direct-current armatures, making the disks appear more like rings. This is accounted for by the fact that in an alternator the total flux which the armature conductors cut in one revolution is divided up among a large number of poles, consequently the flux from any one pole is comparatively small. The flux through the core under the teeth is one-half the

flux from the pole-piece; the cross-section of iron necessary to carry it is, therefore, small, and a large depth of core is unnecessary to obtain the required cross-section.

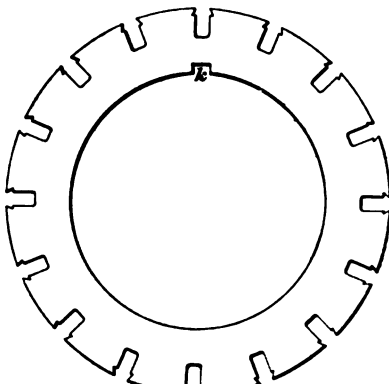

FIG. 1596.

4097. Fig. 1596 shows another style of disk and slot in common use. This disk is provided with 16 slots, and would be suitable for an 8-pole two-phase

winding like that shown in Fig. 1526, Theory of Alternating-Current Apparatus. The same style of disk with 24 slots would answer for the three-phase winding, Fig. 1533. The disk shown in Fig. 1596 is provided with slots which have dovetailed grooves near the circumference. After the coil is placed in position, a wooden wedge is fitted into these grooves, thus holding the coil firmly in place and doing away with the necessity of band wires.

4098. When the armature is wound with bars, straight slots are frequently used. Fig. 1597 shows such a disk provided with 48 equally spaced slots. Such a disk would be

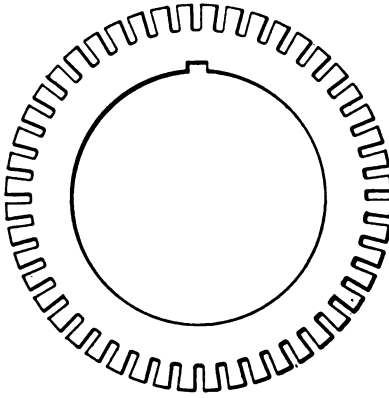

FIG. 1597.

suitable for an armature core for the winding shown in Fig. 1594. It would be necessary in this case to use band wires to hold the conductors down in place, giving a construction very similar to that commonly employed for direct-current armatures.

4099. Stationary armatures for large machines are placed externally to the revolving field, and the coils

placed in slots around the inner periphery. Since such armature cores are generally of large diameter, the armature disks

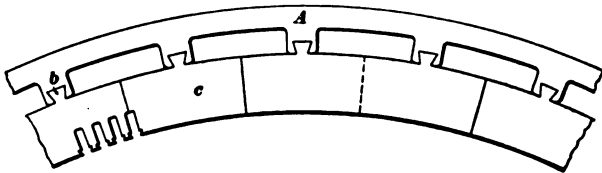

FIG. 1598.

have to be punched out in sections, as shown at *c* in Fig. 1598. These sections are provided with dovetail projections *b* which fit into slots in the supporting iron framework *A*. As

the core is built up, the joints between the different segments are "staggered" or the segments are overlapped, so as to form a core which provides a magnetic circuit practically as good as if the disks were punched in one piece. The use of the dovetail projecting lugs avoids the use of bolts passing through the disks to hold the latter in place. Unless bolts are insulated, they are liable to give rise to eddy currents by short-circuiting the disks. Some makers, however, use disks as shown in Fig. 1599,

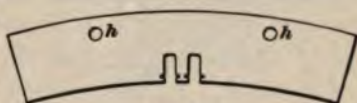

FIG. 1599.

provided with holes *h* for the clamping bolts. The slots used for such stationary armatures must of course be provided with grooves of some kind to receive holding-in strips or wedges, as it is not possible to use band wires in such a case.

4100. Revolving armatures are also frequently made of such large diameter that it is not practicable to punch the disks in one piece. In such cases, again, the disks are made in segments, and are held in place either by bolts passing through them or by dovetail projections fitting into grooves in an extension of the armature spider arm. This construction will be understood by referring to

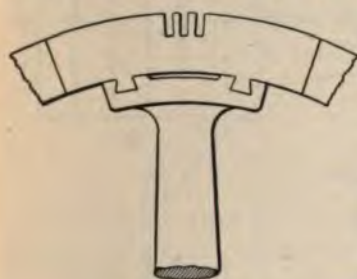

FIG. 1600.

Fig. 1600. In assembling disks to make up a core, it is usual to place a heavy sheet of paper about every $\frac{1}{8}$ inch or $\frac{1}{4}$ inch of core, in order to make sure that the path for eddy currents will be effectually broken up.

ARMATURE SPIDERS.

4101. Disks for revolving armatures are usually supported in spiders similar to those used for direct-current multipolar armatures. These spiders are made of cast iron or steel, and are necessarily strongly constructed. They

should be so made as to clamp the disks firmly in place, and be amply strong to bear any unusual twisting action they may have to withstand due to an accidental short circuit. Fig. 1601 shows two views of a spider (and core) suitable for disks of moderate size punched in one piece. The spider proper consists of a hub *a* provided with four radial arms *b* which fit the inner diameter of the disk.

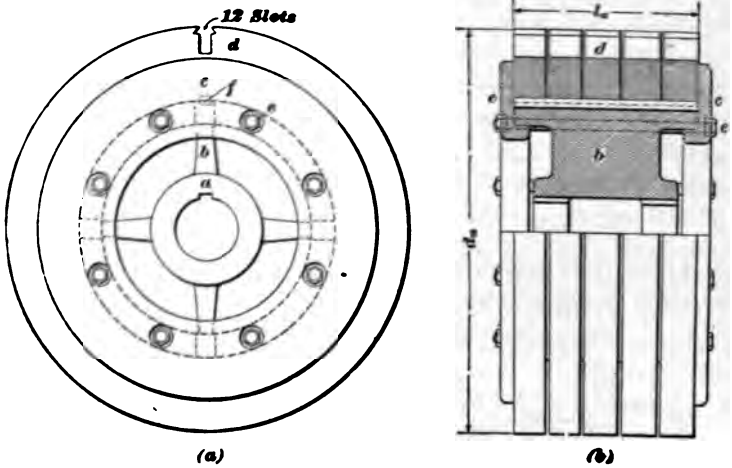

FIG. 1601.

The hub is bored out so that it fits very tightly on the shaft, and a key is provided to avoid any chance of turning. The core disks *d* are clamped firmly in place by two heavy cast-iron end plates *c, c* which are pressed up and held by the bolts *e*. These bolts pass under the disks, so that there is no danger of their giving rise to eddy currents. The key *f* prevents the disks from turning on the spider and ensures the alinement of disks, which is necessary to make the teeth form smooth slots when the core is assembled.

Fig. 1601 shows the construction used with armatures having a small number of heavy armature coils. In such cases the coils are stiff and the ends project out past the end of the core without being supported. In case a distributed winding is used, the coils are numerous, and being small,

they are frequently not stiff enough to support themselves, hence the clamping rings of the spider are in such cases provided with flanges, as shown in Fig. 1602. The end connections of the coils lie on the flat cylindrical surfaces a, a , and are tightly bound down in place by means of band wires. This construction gives rise to what is known as a **barrel**, or **cylindrical winding**, because the ends of the coils project straight out from the core, forming a cylindrical surface. Fig. 1603 shows a spider suitable for a large armature built up with segments like those shown in Fig. 1600. This style of spider is common for machines with large diameter of armature

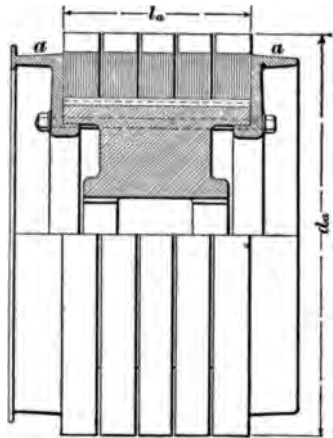

FIG. 1602.

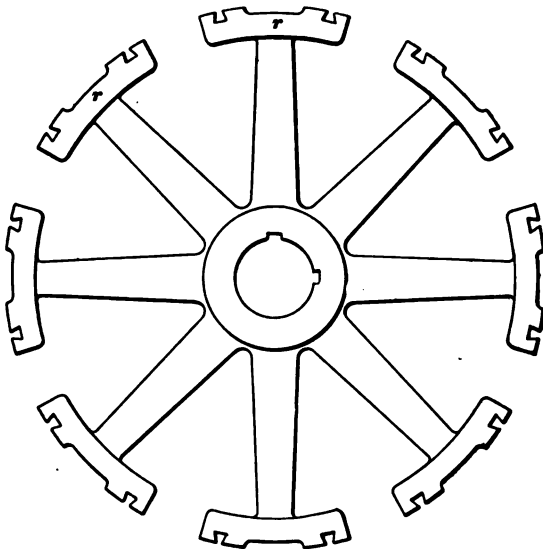

FIG. 1608.

running at low speeds. The rim r of the spider is made

non-continuous, in order to avoid strains in casting as much as possible.

4102. When the armature is the stationary part of the machine, a stationary frame of some kind must be used to support the stampings. This consists usually of a rigid cast-iron framework provided with end plates, between which the armature disks are clamped. The construction will be understood by referring to Fig. 1604, which shows a stationary armature frame for a machine of large diameter.

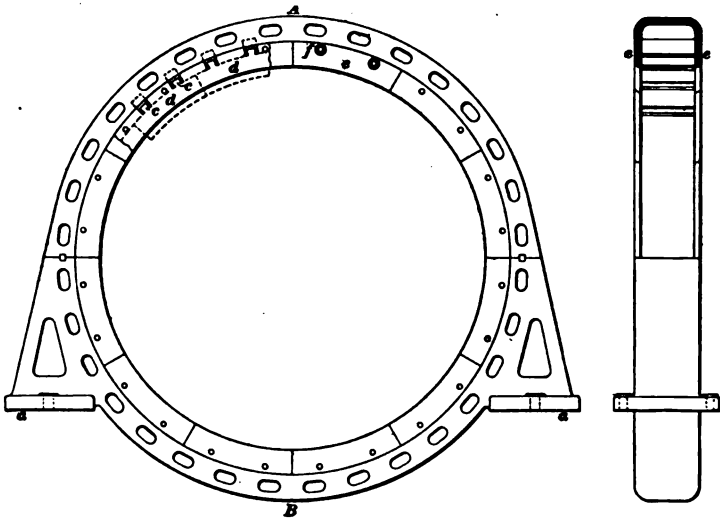

FIG. 1604.

The frame casting is usually made in two pieces *A* and *B*, the lower half being provided with projections *a, a* by which the spider is bolted to the bed or foundation. The segmental core stampings *d, d* are held in place by the dovetail grooves *c, c*. These segments are clamped between the end rings *e, e* by means of the bolts *f*. The end rings *e* are shown made up in segments on account of their large diameter.

ARMATURE CONDUCTORS.

4103. The style of conductor used on the armature will depend to a great extent upon the current which it is to carry and the space in which it is to be placed. High-voltage machines of moderate output are usually wound with double or triple cotton-covered magnet wire. Frequently two or more wires are used in multiple in order to secure the requisite cross-section. This gives a more flexible conductor than a single large wire, which would be difficult to wind.

4104. It is often advantageous to use bare wire in making up such conductors and cover the combination of wires with insulation, as shown in Fig. 1605. A section of a conductor made up of two bare wires in multiple is shown at (a) and four bare wires at (b), the conductors being in each case covered by the cotton wrapping i . This construction

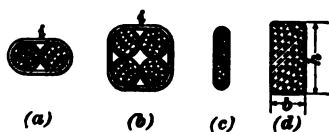

FIG. 1605.

not only saves space, but the insulation also serves to hold the wires in place. Conductors of special shape are used on some machines. For example, square wire and copper ribbon are sometimes employed. Fig. 1605 (c) shows a section of a copper ribbon conductor with its cotton insulation. Such ribbons are usually from $\frac{1}{32}$ in. to $\frac{1}{16}$ in. thick, and should be made with rounded edges, to prevent danger of cutting through the insulation.

4105. Copper bars are largely used for armatures designed to deliver large currents. The use of such bars enables a large cross-section of copper to be put into small space, there being very little of the waste space which is unavoidable where round copper wires are used. Fig. 1605 (d) shows a cross-section of an armature-winding bar. The dimension h is usually considerably greater than b , in order to adapt the bar to an armature slot which is deep and narrow. These bars are rolled to any required dimensions,

the corners being slightly rounded as shown, to prevent cutting of the insulation.

FORMS OF ARMATURE COILS AND BARS.

4106. The simplest form of coil for alternator armatures is that used on ordinary single-phase machines with uni-coil windings. The coils usually consist of a fairly large number of turns, and are

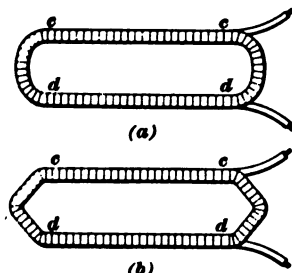

FIG. 1606.



wound on forms, so that the finished coil is of such shape that it fits snugly into place in the slots. Such coils are heavily taped to insulate them thoroughly and make them hold their shape.



Coils of this type are shown in Fig. 1606 (a) and (b).

The straight portion *cc* and *dd* lies in the slots, the end parts projecting out over the ends of the armature core. In some cases the ends are curved as at (a), while in others the ends shown at (b) are used.

4107. In many polyphase windings it is necessary to shape these heavy coils so that they may cross each other at the ends of the armature. This is accomplished by shaping one of the coils as shown in Fig. 1607. The end of the coil *b* is bent down into a different plane from that of *a*, so that the coils cross each other without touching, and ensure good insulation.

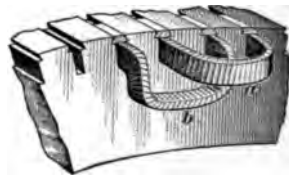

FIG. 1607.

4108. When coils are used for a distributed winding like that shown in Fig. 1593, they are generally shaped like the coil shown in Fig. 1608. This is a form-wound, taped coil consisting usually of a comparatively small number of

turns. The straight portions aa and bb lie in the slots, while the end portions project beyond the core and are usually supported by flanges, especially if the armature revolves. The side aa lies in a lower plane than bb , so that the upper and lower end connections do not interfere with each other. The terminals t, t of the coil are usually brought out at the points shown. At the points c, c the coil is so formed as to bring the end connections d, d into a plane above aa , and thus bring the side bb in the top of the slot. Sometimes the terminals are brought out at the corners a, b , if this brings them in a position more convenient for connection to the other coils.



FIG. 1608.

4109. Bar windings are frequently made in two layers. Fig. 1609 shows a form of bar suitable for a winding such as that shown in Fig. 1594.



FIG. 1609.

The straight part aa lies in the slot, and the end portions b, b form the connections to the other bar. Fig. 1610 shows one element or turn of such a winding. The part cc lies in the top of the slot, and the two bars making up the element are soldered together at the point d .

Fig. 1611 shows a similar element for a wave bar winding, except that there is no soldered joint at the point a , the element being composed of one continuous copper bar first bent into the long U form shown in Fig. 1612, and then spread out to form the winding element shown in Fig. 1611. This construction reduces the number of soldered joints necessary, which is an advantage, as poorly soldered joints may



FIG. 1610.

introduce enough local resistance to cause heating at the

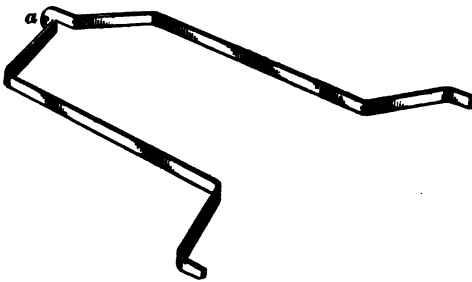

FIG. 1611.

has to be taped in order to insulate it from its neighbors. The part in the slot is frequently taped also, though in some

joints when the machine is delivering a large current. Bars of the style just described are used also for some styles of induction-motor armatures. The portion of the bar forming the end connection

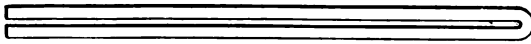

FIG. 1612.

cases the insulation from the core is provided wholly by the insulating trough.

ARMATURE INSULATION (COILS).

4110. Alternator armatures are generally called upon to generate much higher voltages than are common with continuous-current machines. The pressures generated by ordinary lighting-alternators are usually in the neighborhood of 1,000 or 2,000 volts. Power-transmission alternators have been built which generate as high as 8,000 or 10,000 volts. These are the values of the pressures generated in effective volts, and when it is remembered that the *maximum* value of the pressure to which the insulation is subjected is considerably greater than the effective value, it will be seen that the insulation of these armatures must be carefully carried out to ensure against breakdowns. The insulation should be capable of standing a pressure at least three or four times as great as that at which it is ordinarily worked.

4111. For very high voltage machines it is best to use the type with stationary armature, as it is easier to insulate

a stationary armature thoroughly. The allowable space for insulation on a stationary armature is usually greater than on a revolving one, and, moreover, the insulation is more likely to remain intact. A revolving armature also necessitates collector rings, brush-holder studs, etc., which have to be insulated for high pressures; whereas with the stationary armature only three terminals are required, which are comparatively easy to insulate. In all armatures for high pressures, windings are used which give as few crossings of the coils as possible.

4112. When the coils each contain a large number of turns, the voltage generated per coil will be large; consequently it is not only necessary to insulate the outside of the coil thoroughly, but each layer must also be insulated from its neighbor. Fig. 1613 shows a section of a coil consisting of 32 turns. Between each layer of wire is a layer of insulation i turned up at the ends, so as to thoroughly insulate the individual layers. The whole coil is covered with a heavy wrapping of insulating tape t , and in addition is treated with insulating varnish and baked to drive out all moisture. The thickness of tape will depend upon the voltage of the machine. Linen tape of good quality, treated with linseed oil, forms about the best material for this purpose, as it has high insulating properties and does not deteriorate with a moderate amount of heating. Such tape is usually about .010 in. (10 mils) thick, and is wound on half lapped. Where extra high insulation is required, the tape may be interleaved with sheet mica. Coils for distributed windings do not usually contain a large enough number of turns to require insulation between the separate layers. They may be taped and treated with the same materials as the heavier coils, but the outside taping is usually not so heavy. With such windings the material lining the slot is depended upon largely for the requisite insulation.

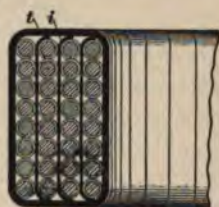

FIG. 1613.

ARMATURE INSULATION SLOTS.

4113. The taping on the coils should not be depended on alone for the insulation. The slots should be lined with insulating material which is not likely to be damaged by putting the coils in place. Slot insulation is usually made up in the form of troughs or tubes composed of alternate layers of pressboard and mica. The mica is depended upon mainly for the insulation, the pressboard being used as a bonding material to hold the mica in place. These tubes may be either made up separately or formed in place in the slots. The mica is usually stuck on the pressboard with shellac or other insulating varnish, which becomes dry when hard and makes the trough hold its shape. Fig. 1614 shows the

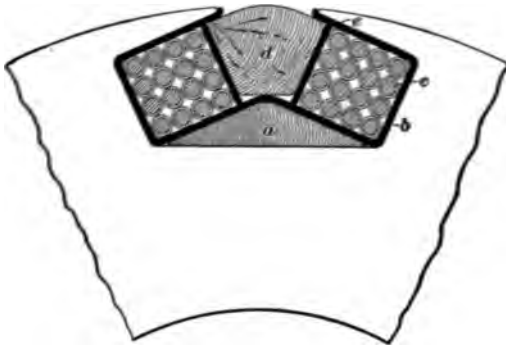

FIG. 1614.

slot insulation for the armature winding shown in Fig. 1512, Theory of Alternating-Current Apparatus. The hardwood strip *a* is first laid in the bottom of the slot, and the paper and mica trough *b* formed in place before the bonding varnish becomes dry. The coil *c*, consisting of several turns of copper wire or ribbon, is wound in place after the slot insulation has become dry, and a wooden wedge *d*, pushed in from the end of the armature, holds the winding firmly in place. An insulating piece *e* is also placed between the wedge and the winding.

4114. Fig. 1615 shows the slot insulation for a winding similar to that shown in Fig. 1526, Theory of Alternating-

Current Apparatus; t is the taping on the coil and i the paper and mica insulating trough. The top of the trough is left projecting up straight until the coil is placed in the slot, after which it is bent over as shown, protecting the coil from any injury while the wedge a is being forced into place. These wedges should be cut so that the grain of the wood lies across the slot, otherwise there is danger of their becoming loose due to shrinkage.

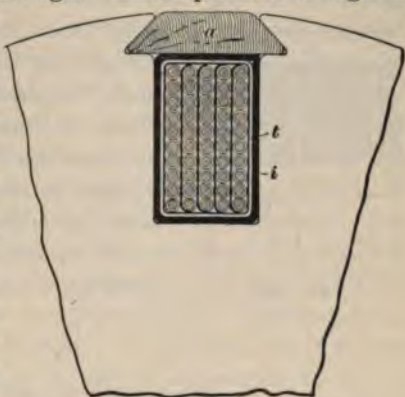

FIG. 1615.

4115. Fig. 1616 shows the arrangement of slot insulation for a coil-wound two-layer armature. The insulating trough i runs around the slot and laps over the top of the coil as before. In addition to this, the upper and lower groups of conductors are separated by the insulating strip a , which must be sufficiently thick to stand the total voltage generated. This arrangement also makes use of the wedge construction for holding the coils in place.



FIG. 1616.

4116. Fig. 1617 shows the insulation for a two-layer bar-wound armature with straight slots. This style of slot would be suitable for the bar winding shown in Fig. 1594. In such cases the bars have to be placed in the slots from the top, the bent ends preventing their being pushed in from the end. This necessitates the use of straight slots and band wires for holding the bars in place. A wooden strip is usually inserted between the band wires and bars in order to protect the winding.

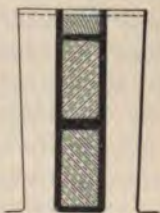

FIG. 1617.

4117. In using two-layer windings, care should be taken to have the top and bottom layers very thoroughly insulated from each other. The insulating troughs *a*, Fig. 1618, should project a short distance beyond the core *d*, in order to make sure of good insulation between the coils and core. The spider flanges should also be thoroughly insulated with paper and mica *c* wherever there is any possibility of the current jumping from the coils to the spider.

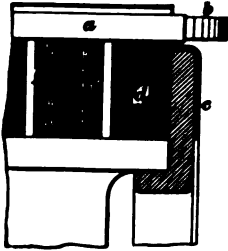

FIG. 1618.

MAGNETIC DENSITIES.

DENSITY IN ARMATURE TEETH.

4118. Where armatures are wound with a few heavy coils, the teeth between the coils are large, in many cases fully as wide as the pole faces. In such armatures the magnetic density in the teeth will not be much higher than that in the air-gap. When a distributed winding is used, the surface of the armature is split up more by the slots, and the area of cross-section of iron in the teeth is reduced. This gives rise to a higher magnetic density in the teeth than in the air-gap.

4119. It was pointed out, in connection with the design of continuous-current machines, that in such machines it was desirable to have the magnetic density in the teeth high, because highly saturated teeth prevent the armature from reacting strongly on the field, and thus aid in suppressing sparking. In the case of alternators, however, high densities in the teeth are avoided, because the effects of armature reaction are not nearly so serious in these machines, and the high density might prove detrimental by causing excessive hysteresis and eddy-current losses. In general, therefore, in alternator design, the magnetic density in the

core teeth is kept as low as possible. The density, however, can not be made very low, as this would mean large teeth and a correspondingly large armature. Where distributed windings are used, it will generally be found that the width of the slot and width of tooth are made about equal, thus reducing the effective iron surface of the armature to about one-half and making the magnetic density in the teeth about twice that in the air-gap. It will be remembered that both the hysteresis loss and eddy-current loss increase very rapidly with the density, consequently it is easily seen that if the density in the teeth is very high, the amount of loss in them may be considerable, on account of the high frequency at which alternators usually run. It also follows that, for the same amount of loss, it would be allowable to use a higher magnetic density with a low-frequency alternator than with one running at a high frequency.

DENSITY IN ARMATURE CORE.

4120. The density in the armature core proper, that is, the portion of the core below the armature slots, should also be low, in order to keep down the core losses. This density can be made almost as low as we please by decreasing the inside diameter of the core, thus making the depth d , Fig. 1595, large, and increasing the cross-section of iron through which the lines have to flow. If, however, the inside diameter were made very small, the core would be heavy, and since the hysteresis loss is proportional to the volume of iron, very little would be gained by decreasing the density beyond a certain amount. Armature cores for alternators are usually worked at densities varying from 25,000 to 35,000 lines per square inch, the allowable density being higher in low-frequency machines than in those running at high frequencies. Where armatures are run at very high speeds of rotation, the density may be allowed to run a little higher than the above values, in order to make the core as light as possible, provided the frequency is not too high.

DENSITY IN AIR-GAP.

4121. The allowable density in the air-gap will depend, to a certain extent, upon the material of which the pole-pieces are made. If cast-iron pole-pieces are used, the density must be kept fairly low, otherwise there will be danger of the cast iron becoming saturated. It is best, therefore, to make the air-gap density in such machines in the neighborhood of 30,000 lines per square inch. If the pole-pieces are made of wrought iron, as they frequently are in modern machines, the density may be as high as 40,000 or 45,000 lines per square inch. The density could be even higher than this without danger of saturating the wrought iron, but if the air-gap density is carried too high, a very large magnetomotive force must be supplied by the field coils in order to set up the flux. For these reasons the average air-gap density should usually be somewhere near the values given above.

DESIGN OF 100 K. W. SINGLE-PHASE ALTERNATOR.

4122. The preceding articles have dealt with the general considerations governing the design and construction of alternator armatures. We will now apply these to the special case of the design of an armature for a single-phase alternator, in order to illustrate the calculation of the different dimensions. As a starting-point, we will assume that the following quantities are known, and in this particular case are as given below, the design being worked out for these quantities. The student will understand, however, that most of the formulas are perfectly general, and that these special values are only taken to illustrate a typical case in order to make the design clearer. The following quantities are in general known or assumed:

1. Output at full load.
2. Frequency.
3. Speed.
4. Voltage at no load. Voltage at full load.
5. Allowable safe rise in temperature.
6. General type of machine.

For the case in hand, we will take the following:

1. Output at full load: 100 K. W.
2. Frequency: 60 cycles per second.
3. Speed: 600 rev. per min.
4. Voltage at no load = 2,000 = \bar{E} . Voltage at full load = 2,200 = \bar{E}' .
5. Allowable rise in temperature: 40° C.
6. General type of machine: belt-driven, revolving armature, stationary field.

4123. It will be noted that the armature is to deliver 2,000 volts on open circuit and 2,200 volts when the machine is fully loaded. This is done so that the voltage at the distant end of the line may remain practically the same from no load to full load. This increase in voltage is accomplished by strengthening the field by means of the series coils, so that, so far as the voltage generated by the armature is concerned, we design it to generate 2,000 volts, and leave the increase of 200 volts to be brought about by the action of the field.

4124. Since the speed and frequency are fixed, the number of poles is also fixed by the relation

$$n = p \times s, \quad (\text{See formula 646, Art. 3956.})$$

where

$$\begin{aligned} s &= \text{rev. per sec.;} \\ p &= \text{pairs of poles;} \\ n &= \text{frequency.} \end{aligned}$$

We have then

$$\begin{aligned} 60 &= p \times \frac{600}{60}, \\ p &= 6, \end{aligned}$$

and the machine must be provided with twelve poles to give the required frequency at a speed of 600 R. P. M. We might have used a speed of 900 rev. per min. and 8 poles, the frequency being the same in either case. It is better, however, to use the lower speed (600 R. P. M.) for a machine of this capacity, so we will adopt the 12-pole 600 R. P. M. design. The field will be external to the armature, and will be provided with 12 equally spaced poles projecting radially

inwards. We will also follow the usual practice and make the distance between the poles equal to the width of the pole face, or, in other words, make the width of pole face equal to one-half the pitch. The pole-pieces will, therefore, cover one-half the surface of the armature.

DIMENSIONS OF CONDUCTOR AND CORE.

4125. The current output at full load will be

$$\begin{aligned} \bar{C} &= \frac{\text{watts}}{\text{full-load voltage}} = \frac{\text{K. W.} \times 1,000}{\bar{E}'} & (671.) \\ &= \frac{100 \times 1,000}{2,200} = 45.4 \text{ amperes.} \end{aligned}$$

The machine must, therefore, be capable of delivering a current of at least 45.4 amperes continuously without the temperature rise above the surrounding air exceeding 40° C.

4126. The cross-section of the conductor which is used on the armature is determined by the current which it has to carry, and this in turn depends upon the way in which the different armature coils are connected up. Since the armature we are considering has to generate a high voltage, we will use an open-circuit winding and connect all the armature coils in series. The current flowing through the armature conductor at full load will then be the same as the full-load current output of the machine, that is, 45.4 amperes. The student should compare this with the calculations determining the size of wire used on a continuous-current armature. It will be seen that in this latter case the current in the armature conductor was only *one-half* the total current output of the machine. In some of the older types of alternators, the armature conductors were worked at a high current density, in some cases less than 300 circular mils per ampere being allowed. For machines of good design the circular mils per ampere will usually lie between 500 and 700. For a trial value we will take 550 circular mils per ampere in order to determine the approximate necessary cross-section of the conductor.

Let A = area of cross-section of conductor in circular mils;
 C = current in conductor;
 m = circular mils per ampere.

Then, $A = C m.$ (672.)

In this case $C = 45.4$ and $m = 550$. Therefore the cross-section of the conductor will be

$$45.4 \times 550 = 24,970 \text{ circular mils.}$$

A No. 6 B. & S. wire would give 26,250 circular mils, which is quite near to the cross-section required, or two No. 9 wires in parallel would give a cross-section of 26,180 circular mils. We will use the latter, because the two wires in multiple will give a more flexible and easily wound conductor. We will use two bare No. 9 wires covered with a double wrapping of cotton. The double thickness of this covering will be about 15 mils. The diameter of No. 9 wire is .114 in., hence the width of the conductor over all will be .243 in. and the thickness .129 in. Fig. 1619 shows a cross-section of the conductor, illustrating the arrangement of the insulation.

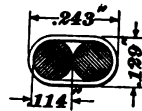

FIG. 1619.

DESIGN OF ARMATURE CORE.

4127. The diameter of the armature is determined by the speed of rotation and the allowable safe value of the peripheral speed. A safe peripheral speed for a belt-driven machine of this type may be taken at about 5,000 feet per minute. Hence we have

$$\begin{aligned} \text{diameter of armature in inches} &= \\ d_a &= \frac{\text{peripheral speed} \times 12}{\text{R. P. M.} \times \pi} \quad (673.) \\ &= \frac{5,000 \times 12}{600 \times \pi} = 31.8 \text{ inches.} \end{aligned}$$

We will therefore adopt $31\frac{3}{4}$ in. = 31.75 as the outside diameter of the armature core.

4128. The length of the armature core parallel to the shaft, or the spread of the laminations l_a , Fig. 1602, must be large enough to enable the armature to present sufficient radiating surface to get rid of the heat generated. In other words, the armature must be large enough to do the work required of it without overheating. The core losses and C^2R loss of the machine under consideration can not be determined exactly until the dimensions of the armature have been determined. The curve shown in Fig. 1583 gives the relation between the output and C^2R loss for machines of good design, and it is seen that for a machine of 100 K. W. capacity, the C^2R loss should be about 1.95% of the output. The approximate C^2R loss may then be taken as

$$100,000 \times .0195 = 1,950 \text{ watts.}$$

4129. This armature is of rather large diameter and runs at a fairly high peripheral speed. Good ventilation should easily be obtained by constructing the spider to allow free access of air and by providing the core with ventilating ducts. With such an armature there should be no difficulty in radiating 1.3 to 1.5 watts for each square inch of core surface with a rise in temperature of 40°C . The core losses are apt to be quite large; hence, to be on the safe side, we will allow half this radiation capacity for the core losses and half for the C^2R loss. This means that we should have about .7 square inch of cylindrical surface for each watt C^2R loss. This would call for a surface of

$$1,950 \times .7 = 1,365.0 \text{ sq. in.}$$

4130. The outside circumference of the armature is

$$31.75 \times \pi = 100 \text{ in., nearly;}$$

hence the approximate length of armature core parallel to the shaft should be about 13.65 in. As a basis for further calculation, we will, therefore, adopt a trial length of core of say 14 in. It may be found necessary to modify this dimension slightly, as the design is worked out further, but it should not be made much less than this, or there will be danger of the armature overheating.

4131. We have now determined the approximate dimensions of the armature core, and are in a position to calculate the magnetic flux N after we have decided upon the density to be used in the air-gap. This machine will be provided with wrought-iron pole-pieces; hence we may take 40,000 lines per square inch as a fair value for the magnetic density in the air-gap. The total magnetic flux N from one pole will be the area covered by the pole multiplied by the magnetic density. The poles cover one-half the circumference; hence the length of arc on the armature covered by each pole will be

$$\frac{\pi \times d_a \times .5}{\text{No. of poles}} \quad (674.)$$

$$= \frac{3.14 \times 31.75 \times .5}{12} = 4.16 \text{ inches.}$$

The length of the pole face is the same as the length of the armature core, i. e., 14 in.; hence the area of the pole face is $14 \times 4.16 = 58.2$ sq. in.

The total flux from each pole will therefore be

$$58.2 \times 40,000 = 2,328,000 \text{ lines.}$$

4132. Since the flux N , the frequency n , and the E. M. F. \bar{E} generated at no load are now known, the number of turns T necessary to generate the voltage \bar{E} can be calculated. This armature will be provided with six coils or twelve slots, that is, one slot for each pole; consequently all the conductors may be considered active at once, and we may use formula **617** to determine the turns T . (See also Art. **4086**.)

We have then

$$\bar{E} = \frac{4.44 N T n}{10^8},$$

or
$$T = \frac{\bar{E} \times 10^8}{4.44 \times N \times n} \quad (675.)$$

The voltage to be generated at no load is 2,000, the frequency is 60, and the flux \mathcal{N} is 2,328,000; hence we have

$$T = \frac{2,000 \times 100,000,000}{4.44 \times 2,328,000 \times 60} = 322.$$

4133. From the above it is seen that we must place as nearly 322 turns on the armature as possible. There are twelve slots, or six coils; hence there would be $\frac{322}{6} = 53.6$ turns per coil and 53.6 conductors in each slot. This number would not be practicable, since we should arrange the coils so that they will wind up into a number of layers without any fractions of turns. We must therefore arrange the coils to give the required number of turns as nearly as possible, and then modify the length of the turns, so that the voltage generated will not be altered. Suppose we arrange the coil and slot as shown in Fig. 1620, using 8 turns of the twin conductor in each layer, and having 7 layers per coil. This will give 56 turns per coil and 56 conductors per slot.

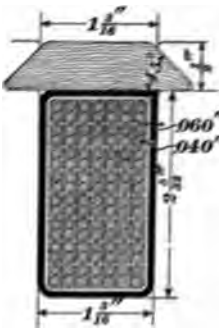

FIG. 1620.

4134. The dimensions of the slot may now be determined from the known number of conductors that are to be placed in it, and the necessary space which must be allowed for insulation. We will allow .060 in. or 60 mils all around for the paper and mica tube which composes the slot insulation, and .040 in. or 40 mils for lapping around the coil. In addition to this, we will allow for 6 layers of insulation, 10 mils thick between the layers of the coil. This will make the necessary width of the slot

$$7 \times .129 + 6 \times .010 + 2 \times .040 + 2 \times .060 = 1.163 \text{ in.}$$

The necessary depth of slot will be

$$8 \times .243 + 2 \times .040 + 2 \times .060 = 2.144 \text{ in.}$$

In order to be sure that the coil will slip into the slot without forcing it, and also to compensate for any slight roughness, we will adopt the dimensions shown in Fig. 1620,

namely, $1\frac{3}{8}$ in. wide by $2\frac{5}{8}$ in. deep. We will make the wooden wedge $\frac{1}{2}$ inch thick, and the opening at the circumference the same width as the slot, in order to allow the coil to be slipped easily into place.

4135. In order to obtain an even number of turns per coil, the total number of turns has been increased from 322, as first calculated, to 336. It follows, therefore, that if the dimensions of the armature are not altered in any way to compensate for this increase in the number of conductors, the machine would give more than 2,000 volts when run at a speed of 600 revolutions per minute. In order, therefore, to keep the voltage generated the same, we must shorten up each conductor a small amount, so that the poles and armature core will also be shortened. This will reduce the flux N , so that the voltage generated by the 336 conductors will be 2,000 volts. The final length of armature may be obtained as follows:

$$\text{We have } N = \frac{\bar{E} \times 10^8}{4.44 \times T n}; \quad (676.)$$

and in this case

$$N = \frac{2,000 \times 100,000,000}{4.44 \times 336 \times 60} = 2,235,000, \text{ nearly.}$$

That is, in order to keep the voltage the same, the flux is reduced from 2,328,000 to 2,235,000.

The area per pole will then be

$$\frac{N}{\text{air-gap density}} = \frac{2,235,000}{40,000} = 55.8 \text{ sq. in.}, \quad (677.)$$

and the length of the pole and armature core parallel to the shaft will be

$$\frac{\text{area}}{\text{polar arc}} = \frac{55.8}{4.16} = 13.42 \text{ in.} \quad (678.)$$

It will thus be noticed that the armature core is shortened slightly, thus shortening up each conductor and making the *length of active wire* the same with the 336 conductors as it would have been if 322 had been used. We will therefore

take $13\frac{1}{8}$ in. as the final value for the length of the core parallel to the shaft (see l_a , Fig. 1621).

4136. All the essential dimensions of the armature core have now been determined except the diameter of the hole in the disks. This inner diameter of the core is determined by the cross-section of iron which must be provided to carry the magnetic flux through the armature core from one pole to the next, and this cross-section in turn depends upon the density at which the core is worked.

Fig. 1621 shows a cross-section of the core, and Fig. 1622 shows a portion of the armature lying between two pole-pieces. In

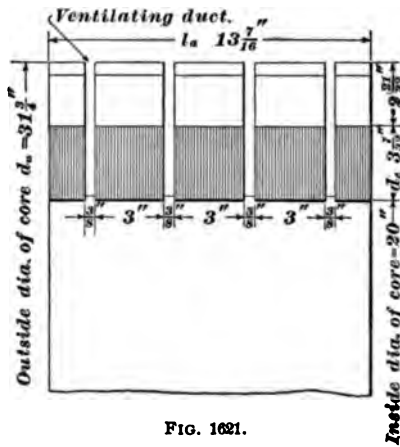

FIG. 1621.

order to determine the inside diameter, we must first obtain

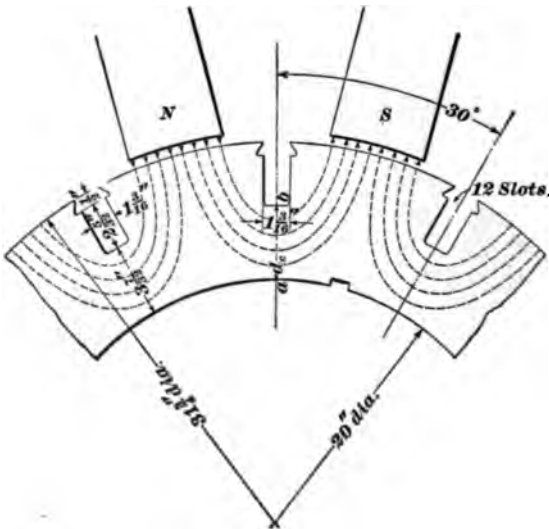

FIG. 1622.

the distance d_c , or the depth of the iron below the bottom of the slots. The lines of force flow from the north to the south pole, as shown in the figure, and it will be seen that the number of lines flowing through the portion $a b$ under a slot is one-half the total number flowing from the pole-piece. Hence the flux through the armature core is $\frac{1}{2} N$. The area of cross-section of iron required will then be

$$A_c = \frac{\frac{1}{2} N}{B_c}, \quad (679.)$$

where B_c is the magnetic density at which the core is worked. We will take the value of B_c as 30,000 lines per square inch. (See Art. 4120.) This will make

$$A_c = \frac{1}{2} \times \frac{2,235,000}{30,000} = 37.25 \text{ sq. in.}$$

This is the area of cross-section of *iron*, and it is equal to the radial depth of the core under the slots ($a b$, Fig. 1622) multiplied by that length of core parallel to the shaft which is actually occupied by iron. The over-all length of the core parallel to the shaft is $13\frac{7}{8}$ in., but part of this is taken up by the insulating varnish and paper insulation between the disks, as well as the portion taken up by the air-ducts. In the present case we will provide the armature with four air-ducts, each $\frac{3}{8}$ in. wide, as shown in Fig. 1621, the disks being spaced apart this distance by suitable ribbed brass castings. These four ducts will therefore occupy a linear distance of $1\frac{1}{2}$ in., leaving $13\frac{7}{8} - 1\frac{1}{2}$ or $11\frac{1}{8}$ in. to be occupied by the iron and insulation on the disks. We will take $11\frac{1}{2}$ in. as the actual length of iron. The required radial depth will then

be $\frac{37.25}{11.5} = 3.23$ inches. We will therefore make the depth

of iron $3\frac{7}{8}$ in. (See Figs. 1621 and 1622.) The total depth of the slot is $2\frac{3}{8}$ in., hence the total radial depth of the disk is $2\frac{3}{8} + 3\frac{7}{8} = 5\frac{1}{2}$ in., and the inside diameter is $31\frac{3}{4} - 2 \times 5\frac{1}{2} = 20$ in. The dimensions of the disk are, therefore, as shown in Fig. 1622. There are twelve slots of the dimensions shown in Fig. 1620, these slots being spaced equally 30° apart.

CALCULATION OF ARMATURE LOSSES.

4137. The dimensions of the armature having been determined, it is now necessary to calculate the losses to see if the armature will deliver the required output without the losses exceeding the allowable amount. We will first calculate the $C^2 R$ loss.

4138. The resistance of the armature can be determined quite closely, since the length of wire on it can be estimated and the cross-section is already known. The length of wire can be obtained by laying out one of the coils to scale and measuring up the mean length of a turn. The coil has to bridge over the distance from the center of a north pole to that of a south pole, and the ends of the coil must be rounded out so as to clear the armature core. The coil will be shaped as shown in Fig. 1623. The straight

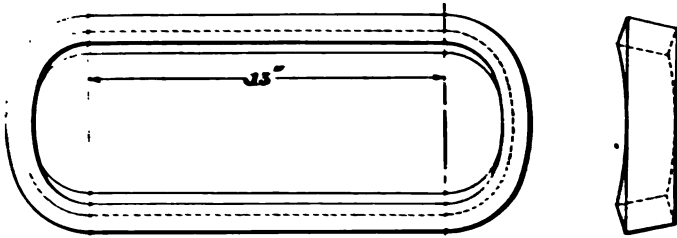

FIG. 1623.

portion of the coil will be made 15 in. long, in order to allow the coil to project about $\frac{1}{4}$ in. from the slots at each end before it begins to turn. The mean turn, shown dotted, is the turn through the center of the coil. Its length is readily determined from the drawing, and in this case it is about 54 inches. The total length of conductor on the armature will therefore be $54 \times 330 = 18,144$ in., or 1,512 ft.

4139. The resistance of any known length of a conductor may be found as follows:

$$R = \frac{l \times \lambda \times \rho}{m} \quad (680.)$$

where L = the length of the wire *in feet*;
 k = the resistance of one mil-foot of the wire in ohms;
 m = the area of cross-section of the wire in circular mils.

NOTE.—By the resistance of a mil-foot of wire is meant the resistance which one foot of the wire would have if it were $\frac{1}{1000}$ inch in diameter.

The numerator $L \times k$ gives the resistance which the given length of wire would have if it were only one mil in diameter, that is, if it had a sectional area of one circular mil. Since the resistance is inversely proportional to the cross-section, dividing the numerator by m (the circular mils cross-section of the conductor) gives the resistance of the given length of conductor. The resistance of one mil-foot of copper wire at ordinary temperature is about 10.4 to 10.6 ohms. Hence we may write

$$\text{(cold) } R = \frac{L \times 10.4}{m}, \quad (681.)$$

or
$$\text{(cold) resistance} = \frac{\text{length in feet} \times 10.4}{\text{cir. mils cross-section}}$$

This is a convenient formula for calculating the cold resistance of any copper wire of which the length and cross-section in circular mils are known. It is more generally useful than tables, because it enables the resistance of a conductor of any cross-section (copper bars for example) to be calculated. In using the formula, care must always be taken to have the length L expressed in *feet*, because the constant 10.4 is the resistance of a mil-foot. In making calculations connected with alternators, transformers, etc., we are usually concerned with the *hot* resistance or the resistance which the wire attains at the working temperature of the machine. This hot resistance is appreciably higher than the resistance at ordinary temperatures, and for temperatures such as are ordinarily attained we may take the

value of the resistance of a mil-foot as 11.5 ohms. Hence we may write

$$(\text{hot}) \text{ resistance} = \frac{\text{length in feet} \times 11.5}{\text{cir. mils cross-section}}$$

$$\text{or} \quad (\text{hot}) R = \frac{L \times 11.5}{m}. \quad (682.)$$

Applying this to the armature just worked out, we find

$$(\text{hot}) R = \frac{1,512 \times 11.5}{26,180} = .664 \text{ ohm.}$$

We will take the resistance as .7 ohm, in order to make some allowance for the resistance of the connections between the coils.

41-40. The full-load current is 45.4 amperes; hence the $C^2 R$ loss at full load will be

$$(45.4)^2 \times .7 = 1,442 \text{ watts.}$$

This shows that the $C^2 R$ loss is well under the limit of 1,950 watts and that the armature would be capable of delivering a little over 45.4 amp. without the $C^2 R$ loss exceeding the allowable amount. The outer cylindrical surface of the armature as obtained from the final dimensions is

$$\pi \times 31\frac{1}{2} \times 13\frac{7}{8} = 1,343 \text{ sq. in., nearly.}$$

This allows a little over .9 sq. in. per watt $C^2 R$ loss which should be an ample allowance for an armature of this type.

41-41. The hysteresis loss may be calculated when the volume of iron, magnetic quality of the iron, and frequency are known. The area of the end of the core is

$$\frac{1}{2} \pi (31.75^2 - 20^2) = 477.3 \text{ sq. in., nearly.}$$

The area of each slot is about 3.4 sq. in., and the total area taken out by the slots 40.8 sq. in., leaving 436.5 sq. in. as the area of the disks. The actual length of *iron* parallel to the shaft is 11 $\frac{1}{2}$ in. (see Art. **4136**); hence the volume of iron in the core is

$$436.5 \times 11.5 = 5,020 \text{ cu. in.}$$

The magnetic density in the core is 30,000 lines per sq. inch. Referring to curve *B*, Fig. 1584, we find that for a density of 30,000 the loss per cubic inch per 100 cycles is .375 watt. Hence the hysteresis loss in watts is

$$W_H = \frac{5,020 \times .375 \times 60}{100} = 1,130$$

4142. The eddy-current loss is not easily obtained, but the combined core losses in this case would likely be fully as great as, if not greater than, the C^2R loss of 1,442 watts. If the combined losses were, say, 3,000 watts, the *electrical efficiency* at full load would probably be in the neighborhood of 94 or 95%, as there would be about 2 per cent. loss in the field and various connections. The commercial efficiency would be somewhat less than this on account of the bearing friction, brush friction, etc.

ARMATURE WINDING FOR TWO-PHASE ALTERNATOR.

4143. The armature just worked out has been designed to deliver a single current at 2,000 volts pressure. Suppose it were desired to provide this armature, or rather an armature of the same general dimensions, with a winding which would deliver two currents at 2,000 volts pressure, and differing in phase by 90°. We could use a two-phase winding similar to that shown in Fig. 1526 in the section on Theory of Alternating-Current Apparatus. We would have two windings, each consisting of six coils connected in series, the two sets being displaced 90° from each other with regard to the poles. The total output, as before, is to be 100 K. W.; hence the output per phase will be 50 K. W., and the current in each phase at full load will be $\frac{50 \times 1,000}{2,200} = 22.7$ amp.

The current in the armature conductor is, therefore, one-half of that in the single-phase machine, and, using the same current density, we may make the conductor up of a single No. 9 wire instead of two in multiple.

4144. The voltage generated in each phase is to be 2,000. The total magnetic flux is the same, since the size of the pole-pieces and armature is not altered; hence the number of conductors in *each phase* must be 336. Each coil on the two-phase armature will therefore consist of 56 turns of No. 9 B. & S. wire, provided we can arrange this number satisfactorily in the slot. If we use 7 layers with 8 turns per layer, we will have a slot of the same width as before, but only a little over half as deep. This will result in a slot which is not very deep compared with its width, whereas it is generally better to have the slot considerably greater in depth than in width. It will give a much better

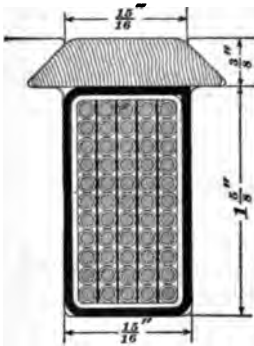

FIG. 1624.

proportioned slot if we use only 5 layers, and place 11 turns in each layer, or 55 turns per coil instead of 56. This would lower the voltage slightly, but we will leave the dimensions of the core the same, and compensate for this slight decrease by strengthening the field a small amount. In other words, we will compensate for the decrease in the number of turns by increasing N so that \bar{E} will remain the same. The slot may then be arranged as shown in Fig. 1624. Allowing the same amount for insulation as before, we have the width of the slot equal to

$$5 \times .129 + 4 \times .010 + 2 \times .040 + 2 \times .060 = .885 \text{ in.}$$

The depth of the slot will be

$$11 \times .129 + 2 \times .040 + 2 \times .060 = 1.619 \text{ in.}$$

We will therefore make the slot $1\frac{1}{8}$ in. wide and $1\frac{1}{2}$ in. deep. As this coil is lighter than the one used for the single-phase armature, we will allow only $\frac{3}{8}$ in. for the wooden wedge, and make the upper part of the slot as shown in Fig. 1624. We will leave the inner diameter of the disk the same, the cross-section of iron being slightly greater than before, on account of the smaller depth of the slots. The disk for this

two-phase armature will then be of the dimensions shown in Fig. 1625. In this case the disk is provided with 24 slots of the dimensions shown in Fig. 1624, there being 12 slots for each phase.

4145. The $C^2 R$ loss in this armature would be practically the same as that in the single-phase armature previously calculated. The resistance of each phase will be about double the resistance of the single-phase armature, because in each phase there is about the same length of wire as before, but this wire has only one-half the cross-section

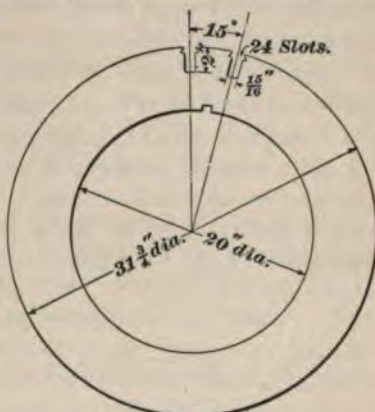

FIG. 1625.

of that used for the single-phase machine. We may, therefore, take the resistance per phase as $2 \times .7$ or 1.4 ohms. The $C^2 R$ loss per phase will be

$$(22.7)^2 \times 1.4 = 721 \text{ watts,}$$

and the total loss in the two phases will be 1,442 watts as before. The radiating surface has not been altered in any way, so that the two-phase armature should deliver its output without overheating. The core losses will also be about the same, because the volume of the core and the magnetic density have not been altered materially.

ARMATURE WINDING FOR THREE-PHASE ALTERNATOR.

4146. Suppose it were desired to wind the above armature so that it would deliver 100 K. W. to a system by means of three currents differing in phase by 120° . It would be necessary to supply the armature in this case with three sets of coils (see Fig. 1533, Theory of Alternating-Current

Apparatus) displaced from each other 120° with regard to the poles. Each set would consist of 6 coils connected in series, the three groups being connected together according to either the Y or Δ method and the terminals led to the collector rings. In this case we will suppose that the Y method of connection is used, because the current in each phase is small and the line voltage high. By adopting the Y method, the voltage to be generated per phase is reduced, thus calling for a smaller number of turns per coil than would be required if the armature were Δ connected. The total output, as before, is to be 100 K. W. and the line pressure at full load 2,200 volts. We have for a three-phase machine

$$\text{watts output} = \sqrt{3} \bar{C} \bar{E},$$

where \bar{C} is the full-load line current and \bar{E} the voltage between the lines at full load. (See Art. 3992, Theory of Alternating-Current Apparatus.) For the present case, we have therefore

$$100,000 = \sqrt{3} \bar{C} 2,200,$$

$$\text{or } \bar{C} = \frac{100,000}{2,200 \sqrt{3}} = 26.2 \text{ amp.}$$

4147. If the line current at full load is 26.2 amp., the full-load current in the armature conductors must also be 26.2 amperes, because, in a Y -connected armature, the current in each phase is the same as the line current. We will allow 550 cir. mils per ampere as before to get an approximate estimate of the area of cross-section of conductor required. This gives

$$550 \times 26.2 = 14,410 \text{ cir. mils.}$$

No. 9 wire has a cross-section of 13,090 cir. mils, while No. 8 has a cross-section of 16,510 cir. mils. We will use the No. 8 wire, since it is on the large side, and will thus tend to make the $C^2 R$ loss less. The diameter of this wire when covered with a double wrapping of cotton will be about .140 in.

4148. The line voltage at no load is to be 2,000; consequently the voltage generated in each phase will be

$$\frac{2,000}{\sqrt{3}} = 1,154 \text{ volts,}$$

because the armature is **Y** connected.

We have from formula **670**,

$$\bar{E} = \frac{4.44 N T n}{10^8} \times k,$$

where \bar{E} is the voltage at no load generated in each phase. In this case the constant k is 1, because we are using a concentrated winding, there being only one slot for each pole and phase. T is the number of turns in *each phase*. The magnetic flux N will be considered the same as before, because the dimensions of the pole-pieces and armature have not been altered. We have then

$$T = \frac{\bar{E} \times 10^8}{4.44 \times N \times n}, \quad (683.)$$

or
$$T = \frac{1,154 \times 10^8}{4.44 \times 2,235,000 \times 60} = 194 \text{ turns, nearly.}$$

These 194 turns are to be split up into the 6 coils constituting one phase. We can use 32 turns per coil, and thus have 192 turns in each phase instead of 194. This slight decrease in the number of turns could be compensated for by increasing the field strength slightly. The three-phase armature will therefore be provided with 18 coils, each consisting of 32 turns of No. 8 wire. These coils are to be divided into three sets of 6 coils, each of the three sets being connected up **Y**.

4149. The arrangement of the slot which would probably be best adapted to this number of turns would be four layers with 8 turns per layer as shown in Fig. 1626. We will allow the

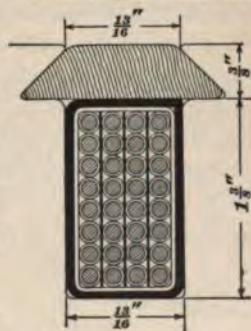

FIG. 1626.

same thickness of insulation as in the previous examples, thus making the width of the slot

$$4 \times .140 + 3 \times .010 + 2 \times .040 + 2 \times .060 = .790 \text{ in.}$$

The depth of the slot will be

$$8 \times .140 + 2 \times .040 + 2 \times .060 = 1.320 \text{ in.}$$

We will therefore adopt the dimensions $1\frac{1}{8}$ in. by $1\frac{1}{8}$ in. as the width and depth, and make the wedge $\frac{3}{8}$ in. thick, as

in the last case. Fig. 1627 shows the dimensions of the disk for this machine. It is provided with 36 slots, equally spaced and of the dimensions shown in Fig. 1626. The other dimensions of the disk remain the same as for those previously calculated.

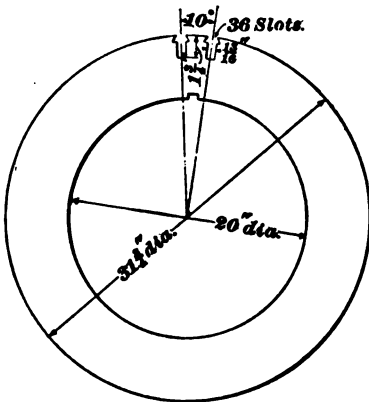

FIG. 1627.

4150. The $C^2 R$ loss for this armature should not differ greatly from the loss calculated for the other two.

We can easily make an approximate estimate of the $C^2 R$ loss in such a three-phase armature as follows: The mean length of a turn will be very nearly the same as that obtained for the single-phase machine, because the angular distance which the coils span remains the same and the length of the armature core has not been altered. There might possibly be a slight increase in the length, owing to the shape which has to be given to the ends of some of the coils in order to allow them to pass each other at the ends of the armature (see Fig. 1607), but it will be sufficiently accurate to take the length of a turn the same as before, namely, 54 inches, for the present purpose. The total length of conductor in each phase will be

$$\frac{54 \times 192}{12} = 864 \text{ ft.}$$

The hot resistance of each phase will therefore be

$$\frac{864 \times 11.5}{16,510} = .60 \text{ ohm.}$$

The current in each phase at full load is 26.2 amp. Hence the C^2R loss in each phase will be

$$(26.2)^2 \times .60 = 412 \text{ watts, nearly.}$$

We will take the loss in each phase at, say, 500 watts, in order to allow for the loss due to the resistance of the connections. The total loss in the armature would therefore be 1,500 watts, or about the same as for the other armatures. The radiating surface is the same as in the other two cases, so that this armature should deliver 100 K. W. within the specified temperature limit. The core losses, as before, would remain nearly the same, since the volume of iron has not been changed appreciably.

4151. The three-phase armature might have been designed for a Δ winding, in which case each phase would be provided with a sufficient number of turns to generate 2,000 volts. The current in the conductor would, however, be only $\frac{26.2}{\sqrt{3}}$, or 15.1 amperes; so that while the number of turns has to be increased, the cross-section of the conductor may be decreased in the same ratio, and the size of armature slot would be about the same in either case.

4152. The above calculations for single, two, and three phase armatures have all been made upon the supposition that uni-coil or concentrated windings were used. The method of designing the armature when distributed windings are used is, in general, the same, with the exception that the formula giving the relation between the E. M. F., flux, and turns has to be modified to suit the style of armature winding used. The effect of using distributed windings has already been pointed out, and calculations in connection with such windings will be given in connection with induction-motor design.

COMPLETED ARMATURES.

4153. Fig. 1628 shows a finished armature with collector rings. This armature has a concentrated winding, as indicated by the small number of large slots around its circumference. The wooden wedges for holding the coils in

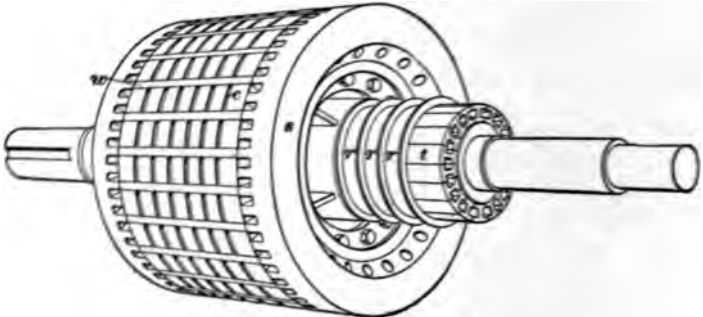

FIG. 1628.

place are shown at *w*, and *c* are the ventilating ducts for allowing a circulation of air through the core. The cast-brass shields *s* are supported from the armature spider and

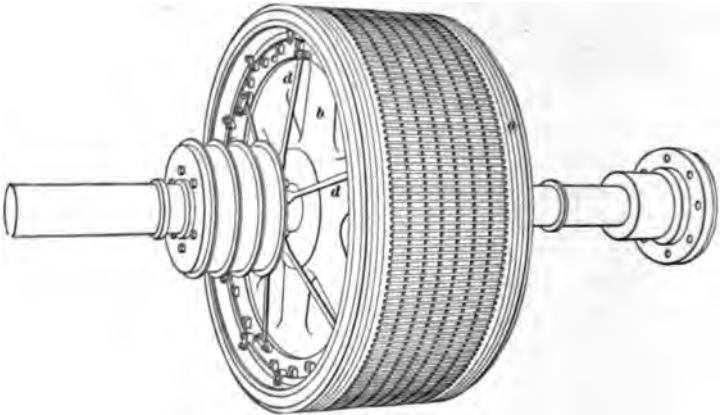

FIG. 1629.

are used to protect the projecting ends of the coils. The armature is shown complete with the collector rings *r* and the rectifier *r*. Fig. 1629 shows a large three-phase armature with a distributed winding. It will be noticed that this

armature has a large number of narrow slots and is similar in appearance to a continuous-current armature, except for the absence of the commutator and its connections. The ends of the bars rest on the spider flanges and are held down by the bands *a*. The disks are carried by the spider *b* and are clamped up by the end plates *c*. The copper bars *d, d* are the connections between the winding and the collector rings. It will be noticed that this armature is not provided with a rectifier, because this style of armature is of such low inductance that the machine can be made to regulate closely enough without the use of a set of series coils on the field.

DESIGN OF FIELD-MAGNETS.

4154. Stationary field-magnets for alternators are generally constructed in about the same way as those for multipolar continuous-current machines, the main difference being the large number of poles with which an alternator

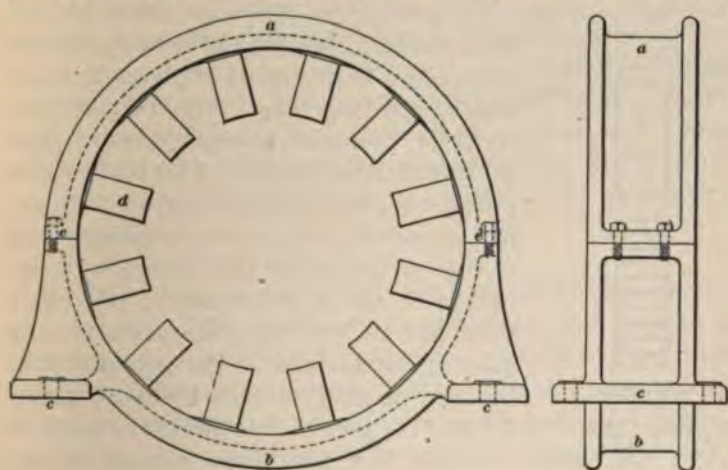

FIG. 1630.

field is usually provided. The design almost universally adopted for stationary fields consists of a circular yoke *a* of cast iron or steel, Fig. 1630, provided with a number of poles *d* projecting radially inwards towards the armature.

The field is usually made in halves, so that the upper part a may be removed to give access to the armature. The lower half b is very often cast with the base of the machine, especially in machines of moderate size. In larger machines the lower half is cast separately and provided with projections c, c , by means of which it is bolted to the bed. The halves are held together by means of the bolts e . Some makers build fields of this description which are divided on the vertical diameter, allowing the halves to be separated sideways, in order to get at the armature. In some small machines the yoke is made in one piece and the machine so arranged that the armature may be drawn out endways.

4155. The pole-pieces used with these stationary fields are usually straight; that is, they are not provided with pole shoes or polar projections of any kind. Pole shoes are not usually necessary, because the length of the polar arc is generally small. Some of the older types of machines were provided with cast-iron pole-pieces cast with the yoke, but

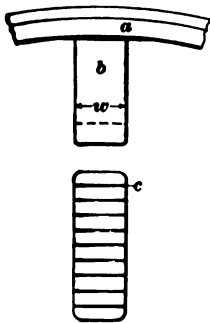

FIG. 1631.

most modern machines have wrought-iron pole-pieces built up out of plates and cast welded into the yoke. Fig. 1631 shows a form of cast-iron pole-piece which has been used considerably. This is a straight pole-piece b cast with the yoke a . In order to prevent eddy currents being set up in the pole-pieces by the changes of magnetism in the pole face due to the coarse teeth and slots of the armature sweeping past it, the surface of the pole is broken up by a number of thin U-shaped pieces of sheet iron c cast into the pole. This limits the paths in which the eddy currents flow, and thus cuts down the heating of the poles due to them. Cast-iron poles can not be worked at a magnetic density much over 30,000 or 35,000 lines per square inch, and there is always more or less loss in the polar surface due to eddy currents. In order, therefore, to do away with this eddy-current loss

and to permit the use of a higher magnetic density, laminated wrought-iron pole-pieces have come largely into use.

Fig. 1632 shows a common form of this type of pole. The pole is built up of soft iron stampings b , which are clamped together between the end plates d, d by means of the bolts c, c . This built-up pole-piece is cast into the yoke a . The plates used for these poles are usually from $\frac{1}{16}$ in. to $\frac{1}{8}$ in. in thickness. If the bolt at the inner end of the pole-piece is very near the end of the pole, it should be lightly insulated by a paper tube, otherwise

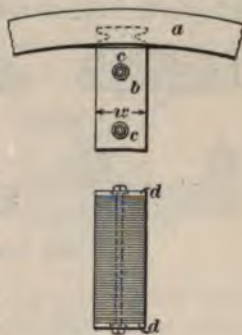

FIG. 1632.

it may, by short-circuiting the plates, allow eddy currents to flow. The length of these pole-pieces parallel to the shaft is made equal to the corresponding length of the armature core. The breadth of the pole w is determined by the polar arc which the pole has to span. It will be noticed in passing that the cross-section of these pole-pieces is, in general, rectangular, or nearly so, and the field coils are therefore nearly rectangular. Circular field coils and field cores which are so common with direct-current machines are seldom met with on alternators, because the width of the pole w is generally small compared with the length of the armature.

4156. The yoke $a b$, Fig. 1630, is nearly always made of cast iron. The magnetic flux through the yoke of an alternator is usually small, and as the yoke has to have considerable cross-section to make it strong enough mechanically in any event, there is no object in using cast steel to make the cross-section small, as is frequently done in the case of direct-current machines. Usually the yoke is worked at a low density in order to give sufficient cross-section to make it strong enough mechanically. The shape of the cross-section is largely a matter of design, so long as the requisite *area* of iron is provided. Fig. 1633 (a) shows a plain

rectangular section with rounded corners; (b) shows a section which is frequently used, the well-rounded corners and the elliptical back giving the yoke a more graceful appearance

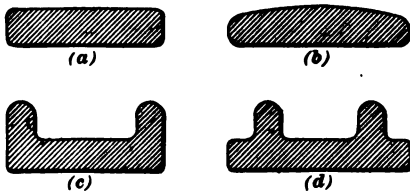

FIG. 1633.

than the plain rectangular section. Fig. 1633 (c) shows a section which is commonly used. In this case the yoke is provided with flanges which make it stiff, and which also give the yoke a solid appearance, although the cross-section of metal in it may be quite small (see Fig. 1630). Fig. 1633 (d) shows a flanged construction with the flanges moved in from the edge of the yoke. The breadth of the yoke is usually somewhat greater than the length of the pole-pieces parallel to the shaft, so that the yoke will partially cover the ends of the field coils.

REVOLVING FIELDS.

4157. A number of different constructions are used for revolving fields, depending upon the methods adopted for furnishing the field excitation. A common type is that in which the radial pole-pieces are bolted to a cast steel or iron rim, each pole-piece being provided with an exciting coil, as in the case of the stationary field just described. Fig. 1634 shows a pole-piece and coil for this type of field.

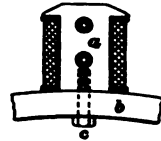

FIG. 1634.

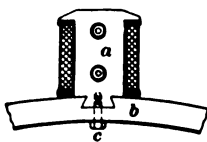

FIG. 1635.

The pole *a* is built up out of sheet-iron plates and secured by the bolt *c* to the ring *b*, which is carried on the spokes of the field spider. The projections on the pole serve to hold the coil in place. In some cases the poles are made straight and the coil held in place by projecting lugs on the end clamping plates. Fig. 1635 shows a similar pole-piece, the plates in this case being dovetailed into the field ring as well as bolted.

4158. Revolving fields are sometimes built so as to require only one exciting coil for all the poles. A field of this type is shown in Fig. 1636. The exciting coil *c* is circular. The field casting is in two parts *a* and *b*, held together by bolts *f*, and each casting has a crown of 6 poles, as shown.

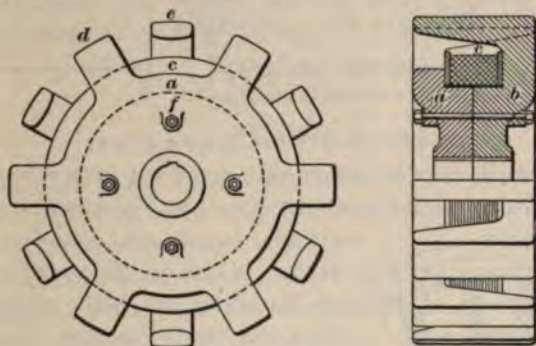

FIG. 1636.

When current is sent through the coil, lines of force thread through it; all the projections *d* attached to one side being, say, north poles and all those attached to the other side south poles. This construction is apt to give rise to more magnetic leakage than the type with radial pole-pieces and individual field coils; also, since the coil *c* is large and heavy, it is more difficult to repair in case of breakdown than the smaller coils used on the other type of field. This construction, however, enables a multipolar field to be made with a very small number of parts, and is on this account desirable.

FIELD-MAGNET COILS.

4159. Field-magnet coils are wound on spools constructed similar to those used for the field coils for continuous-current machines. These spools are made so as to slip over the pole-pieces, and are usually held in place by pins projecting from the pole or by cap bolts screwed through lugs projecting from the end flanges of the spool. Fig. 1637 shows an end elevation and a cross-sectional view of a spool of the style commonly used. The shell *b* is made of heavy

sheet iron and is flanged up at the ends, so that it may be riveted or soldered to the brass end flanges *a, a*. These

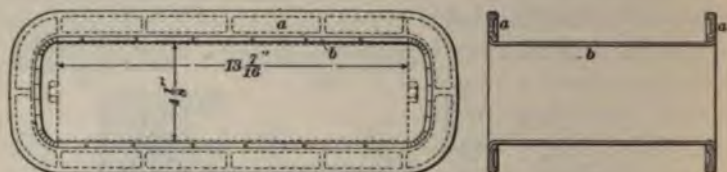

FIG. 1637.

flanges are usually recessed and provided with ribs to make them stiff and at the same time secure lightness. The ends of the spool are rounded out as shown, so as to give clearance for the heads of the bolts which clamp the pole-pieces together. In designing field coils and spools, care must be taken to see that the depth of winding is not made such that the coils will interfere with each other when they are placed on the poles, and sufficient clearance must be provided, as at *a*, Fig. 1638.



FIG. 1638.

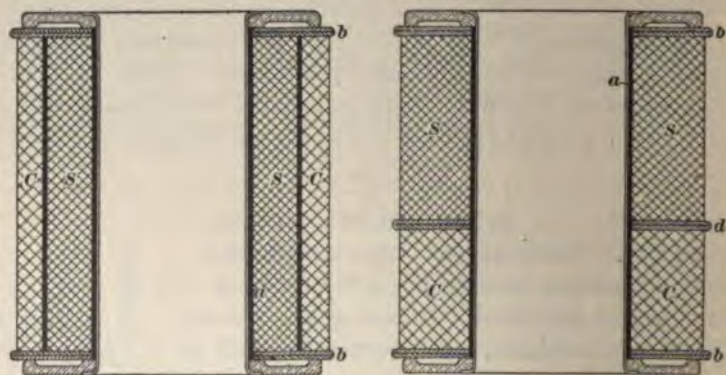

FIG. 1639.

FIG. 1640.

4160. Field coils are usually wound with double cotton-covered magnet wire, though in some large machines copper

strip is used. When field coils are provided with two sets of windings (separately excited and series), the coils may be arranged on the spool, one on top of the other, as shown in Fig. 1639, or side by side, as in Fig. 1640. The construction shown in Fig. 1640 is the better, because it admits of higher insulation and allows one coil to be repaired in case of breakdown, without disturbing the other.

INSULATION OF FIELD COILS.

4161. In many cases the fields are excited by coils which are provided with only one winding excited from a separate continuous-current machine. The exciter voltage in such cases is usually low, and it is unnecessary to take any unusual precautions in insulating the spools, as the maximum pressure tending to break down the insulation would not likely exceed one or two hundred volts. Such spools may therefore be insulated in the same way as those for ordinary continuous-current machines.

4162. Where the spools are provided with two windings, the series winding is, in many cases, in direct connection with the armature, thus carrying the high potential to the field coils and subjecting the insulation to a large stress. Such windings must be thoroughly insulated, not only from each other, but also from the spools. Figs. 1639 and 1640 show the methods of insulating these coils. The shell is covered with several layers *a* of paper and mica interleaved, the insulation between the coils in Fig. 1639 being also of the same material. The end insulations *b, b* and insulation *d* between the coils, Fig. 1640, are made either of heavy collars of paper and mica, or of hardwood veneer treated with oil or other insulating material. Every precaution should be taken to make the insulation of these spools high, as they are liable to be subjected to just as high a voltage as the armature windings.

DESIGN OF FIELD.

4163. We will illustrate the method of obtaining the field dimensions by working out the design of a field suitable for the single-phase armature previously calculated. This field will be of the radial pole type shown in Fig. 1630, the pole-pieces being of wrought iron, as shown in Fig. 1632.

BORE OF POLES AND LENGTH OF AIR-GAP.

4164. Before proceeding with the design of the field, we must decide upon the length of air-gap to be used. It was shown in connection with continuous-current machines that for any given armature it was necessary to have a certain length of air-gap, otherwise the armature would react on the field so as to cause sparking when the machine was loaded. It has also been shown that the general effect of the armature reaction in an alternator is to weaken the field. If we wish an alternator to give good regulation, we can cut down the effect of the armature on the field by using a large air-gap, and on this account it is quite common to find alternators provided with an air-gap which is much larger than is necessary for mechanical clearance. A short gap would have the advantage of requiring only a small amount of magnetizing power on the field to set up a given flux; but, on the other hand, it would allow the armature to react strongly, the actual length of air-gap used not being determined from considerations of the sparking limit as it is in the case of direct-current machines. For belt-driven machines up to 250 or 300 K. W., $\frac{3}{8}$ in. to $\frac{1}{2}$ in. may be taken as fair values for the length of the double air-gap. If the gap is made very large, of course a large amount of exciting power is required, so that it does not pay to increase the length of the gap much beyond the values given above. For large direct-connected machines, the gap necessary for mechanical clearance will usually be found sufficient to make the machine perform well electrically.

4165. For the machine under consideration, we may, therefore, make the double air-gap $\frac{3}{8}$ in. and the bore of the pole-pieces

$$31\frac{3}{4} + \frac{3}{8} = 32\frac{1}{8} \text{ inches.}$$

The poles cover 50% of the armature, and the length of the arc will be

$$\frac{\pi \times \text{bore of poles} \times .5}{\text{No. of poles}}, \quad (684.)$$

or
$$\text{arc} = \frac{\pi \times 32.125 \times .5}{12} = 4.2 \text{ in.}$$

The distance between the sides of the pole will be about $4\frac{1}{8}$ in., as shown in Fig. 1641. The length of the pole-piece parallel to the shaft will be the same as the length of the armature core, $13\frac{7}{16}$ in.

4166. All dimensions of the pole-pieces are now known except their radial depth l , Fig. 1641. The pole-piece must be made long enough to accommodate the winding without making it too deep. Short pole-pieces result in a yoke of small diameter and a correspondingly light machine. On the other hand, the spool winding has usually to be deep when short spools are used. The depth of winding may not only be limited by the space between the poles, but deep windings are objectionable on account of their liability to overheat and the larger amount of copper required for them. If, however, the cores are made longer than is necessary, the winding is made unnecessarily shallow and the yoke of large diameter, thus making the machine heavy and the magnetic circuit long. In machines of the type under consideration, the length of the pole-piece is usually from $1\frac{3}{4}$ to $2\frac{1}{2}$ times as long as it is wide. For a trial value, we will therefore take 8 inches as the length l . This can later be increased or decreased slightly to suit the windings, if

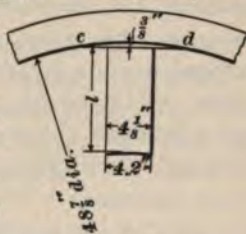

FIG. 1641.

found necessary. We will also allow $\frac{3}{8}$ in., as shown in Fig. 1641, for the thickness of the flat part on the inside of the yoke against which the coils rest. This will make the inside diameter of the yoke

$$32\frac{1}{8} + 16 + \frac{3}{4} = 48\frac{7}{8} \text{ in.}$$

MAGNETIC FLUX THROUGH POLE-PIECES AND YOKE.

4167. The magnetic flux which passes through the armature from one pole-piece is N . A certain number of the lines leak across from one pole-piece to the other without passing through the armature; hence, in order to get N lines in the armature, we must have N_y lines in the pole-piece where y is the coefficient of magnetic leakage for the field frame. The coefficient of leakage is generally somewhat greater for alternators than for direct-current machines, because the poles are usually fairly close together and expose quite a large surface from which leakage may take place. The larger the air-gap compared with the leakage path between the poles, the greater will be the amount of leakage, since the lines always flow by the path offering the least resistance. The coefficient of leakage also varies with the size of the machine, being smaller for large machines than for small ones, and may have values ranging from 2 to 1.3 or less in very large machines. We will take the coefficient of leakage for the machine under consideration as 1.4.

4168. The useful flux N from one pole is in the present case 2,235,000 lines. The flux through each pole-piece will therefore be

$$N_y = 2,235,000 \times 1.4 = 3,129,000.$$

The magnetic density in the field cores will be

$$B_f = \frac{\text{flux through core}}{\text{cross-section}} \quad (685.)$$

$$= \frac{3,129,000}{4\frac{1}{8} \times 13\frac{7}{8}} = 56,400 \text{ lines per sq. in.}$$

It will be noticed that this density is well below that point

at which wrought iron begins to saturate, so that the sectional area of the pole-pieces as determined by the polar arc is ample for carrying the magnetic flux.

4169. The magnetic flux through the yoke is one-half that through the pole-piece, because the lines divide, one half flowing in one direction and the other half in the other direction. The number of lines flowing through the cross-section of the yoke is therefore

$$\frac{N_y}{2} = \frac{3,129,000}{2} = 1,564,500,$$

and the required cross-section of the yoke will be

$$A_y = \frac{\text{flux through yoke}}{\text{allowable density in yoke}} = \frac{\frac{1}{2} N_y}{B_y}, \quad (686.)$$

where B_y is the magnetic density at which the yoke is worked. The yoke density is usually low, as explained in Art. **4156**, the yoke being made of cast iron. We will take 30,000 lines per square inch as the allowable value of B_y , thus giving for the required cross-section

$$A_y = \frac{1,564,500}{30,000} = 52.1 \text{ sq. in., nearly.}$$

We will make the yoke 17 in. wide, so as to allow it to project over the pole-pieces at each end. If we made the yoke rectangular in section, as shown by the dotted outline, Fig. 1642, the thickness of the yoke would have to be about $3\frac{1}{8}$ in. to give the requisite cross-section. In-

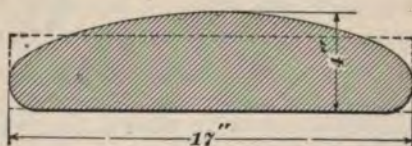

FIG. 1642.

stead of using the rectangular shape, we will increase the thickness at the center to 4 in. and round off the yoke as shown, so as to keep the area about the same. This will give a heavier-looking yoke, and one which will present a better appearance generally than that with a rectangular section.

CALCULATION OF FIELD AMPERE-TURNS.

4170. Since the dimensions of the field frame, armature, and air-gap are now known, and the magnetic densities in these different parts are also known, the ampere-turns required to set up the magnetic flux can be calculated. In order to do this, it is best to consider one of the simple

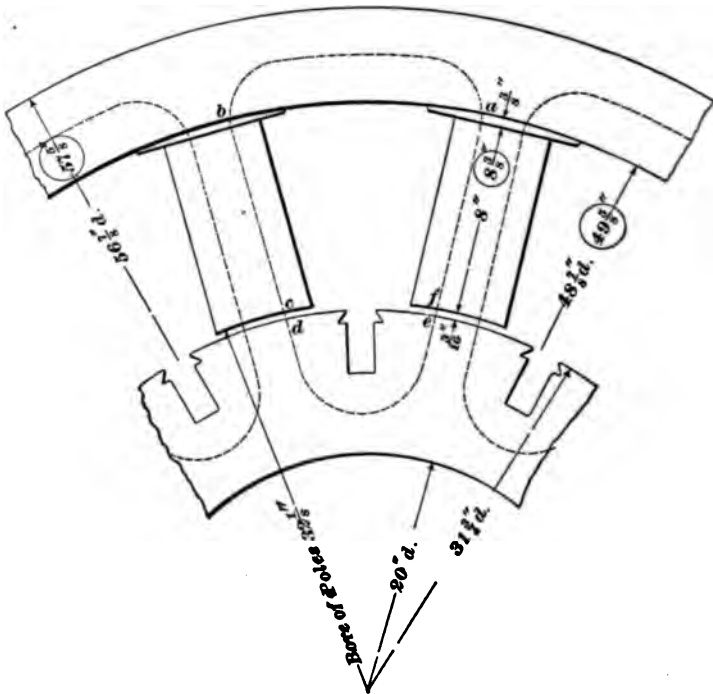

FIG. 1643.

magnetic circuits shown by the dotted line *a-b-c-d-e-f*, Fig. 1643. This path is made up of a portion of the yoke, two pole-pieces, the double air-gap, and the portion of the armature core shown. The dotted line represents the length of the average path through which the lines flow, and the ampere-turns supplied by the separately excited coils on the two poles must be sufficient to set up the magnetic flux around this path. We may, then, for convenience

In making calculations, split up the ampere-turns required for the whole circuit into the following parts:

1. Ampere-turns required for the double air-gap $cd + ef$.
2. Ampere-turns required for the circuit through the two pole-pieces $bc + af$.
3. Ampere-turns required for the path through the yoke ab .
4. Ampere-turns required for the path through the armature de .

4171. The effective area of cross-section of the air-gap through which the lines N flow will be taken as about equal to the area of the pole face. The lines will fringe to some extent at the edges of the pole, thus actually increasing the effective area slightly. The area is, however, cut down somewhat by the air-ducts in the core, so that this will tend to counterbalance any increase in area due to fringing. We will therefore assume that the density is as taken in Art. **4131**, namely, 40,000 lines per square inch. The permeability of air is 1 and the total length of air-gap is $\frac{3}{8}$ in.; hence we have

$$\text{Ampere-turns required for double air-gap} = \frac{40,000 \times .375}{3.192} = 4,700, \text{ nearly.}$$

4172. The magnetic density in the pole-pieces has already been determined and found to be 56,400 lines per sq. in. The length of path through the two pole-pieces is $2 \times 8 = 16$ in. By referring to Fig. 1354 in the section on Dynamo-Electric Machine Design, Continuous-Current, we find that it requires about 11 ampere-turns per inch of length to set up a density of 56,400 lines per square inch through wrought iron. Hence we have

$$\text{Ampere-turns required for field cores} = 11 \times 16 = 176.$$

4173. The yoke has been made of such cross-section that the density in it is 30,000 lines per square inch. The length of the path ab through the yoke can be scaled from

the drawing, and in this case is about $14\frac{1}{2}$ in. For a density of 30,000 lines per square inch, the ampere-turns required per inch of length for cast iron are about 43. Hence we have

$$\text{Ampere-turns required for yoke} = 43 \times 14\frac{1}{2} = 623.5.$$

4174. The armature has been made of such cross-section that the density in the core is about 30,000 lines per square inch. The length of the path through the core can be obtained from the drawing, and in this case is about 12 inches. The ampere-turns required per inch of length for wrought iron at this density will be about 8. Hence

$$\text{Ampere-turns required for armature core} = 8 \times 12 = 96.$$

4175. The total ampere-turns which must be supplied by one pair of the separately excited field coils will be the sum of the ampere-turns required for the different parts of the magnetic circuit; hence

$$\text{Total ampere-turns} = 4,700 + 176 + 623.5 + 96 = 5,595.5, \text{ say } 5,596.$$

The student will note that because the magnetic densities in the iron parts of the circuit are low, and also because the lengths of the different paths are short, the ampere-turns required for the iron part of the circuit are small compared with those required for the air-gap, which has a high magnetic reluctance. The ampere-turns required for the armature core might in many cases be neglected without serious error. It follows from this that if it is found necessary later to lengthen or shorten the pole-pieces slightly, in order to accommodate the winding, the corresponding resulting change in the ampere-turns required will not be appreciable.

CALCULATION OF SEPARATELY EXCITED WINDING.

4176. Having determined the ampere-turns to be supplied by each pair of separately excited coils, the next step is to design a winding for these coils which will supply the required number of ampere-turns. The size of wire required can readily be determined when the mean length of a turn

and the voltage across the coils are known. In order to get at a value for the mean length of a turn, we must adopt a trial value for the depth of the winding. Suppose we make the spool flanges $1\frac{1}{4}$ in. deep, as this will give a spool of dimensions well suited to the field shown in Fig. 1643, allowing plenty of clearance space between the coils when they are slipped over the poles. The clearance between the shell and field core will be, say, $\frac{3}{8}$ in. all around, and we will allow $\frac{5}{8}$ in. on each side for the thickness of the shell and insulation. The series and separately excited coils will be arranged side by side, as shown in Fig. 1640. We will have a clear depth of winding of 1 inch, allowing for clearance and insulation as above. The shape of the spool will be as shown in Fig. 1637, and the mean length of a turn can readily be measured off the drawing. In this case the mean length of a turn will be about 41 in. or $3\frac{5}{12}$ ft.

4177. The separately excited coils are connected in series, so that the voltage across any pair of coils will be the voltage across all the coils divided by the number of pairs of poles on the machine. The voltage applied to the separately excited field is equal to the voltage generated by the exciter less whatever drop there may be in the regulating rheostat. Let E represent the E. M. F. generated by the exciter and e the drop in the rheostat. The pressure applied to one pair of coils will then be

$$\frac{E - e}{\frac{P}{2}},$$

where P = number of poles;

or
$$\frac{2(E - e)}{P},$$

The current in the field will be

$$C = \frac{\text{E. M. F.}}{\text{resis.}} = \frac{2(E - e)}{R} \quad (687.)$$

where R is the resistance of a pair of spools.

But the resistance R of a pair of spools may be expressed as follows:

$$R = \frac{l_m \times t \times 11.5}{m}, \quad (688.)$$

where l_m = mean length of a turn in feet;
 t = number of turns on a pair of spools;
 m = circular mils cross-section of field wire.

Substituting in formula 687 the value of R as given by 688, we get

$$C = \frac{2(E - e)m}{P \times l_m \times t \times 11.5}, \quad (689.)$$

and

$$m = \frac{\frac{P}{2} \times l_m \times t \times C \times 11.5}{(E - e)}$$

$$= \frac{\rho \times l_m \times t \times C \times 11.5}{(E - e)}, \quad (690.)$$

where ρ is the number of pairs of poles on the machine. The values of the quantities t and C are not known separately, but their product is known, since it is the ampere-turns supplied by one pair of spools. Hence we may write

cir. mils cross-section of separately excited field wire =

$$\frac{\text{No. of pairs of poles} \times \text{mean length of a turn in ft.} \times \text{amp.-turns} \times 11.5}{\text{voltage of exciter} - \text{drop in field rheostat}}.$$

Or,

The cross-section in circular mils of the wire necessary for the separately excited winding of an alternator is found by taking the product of the number of pairs of poles, the mean length of a turn in feet, the ampere-turns supplied by one pair of spools, and the hot resistance of 1 mil-foot of copper, and dividing by the voltage of the exciter less the drop through the field rheostat.

The size of wire could be worked out equally well by considering the ampere-turns supplied by *all the coils* instead of a single pair, and taking the *total* voltage instead of the voltage across a pair of spools. It is best, however, to make

the calculations with reference to a pair of spools in order to avoid confusion, because the ampere-turns were calculated for a pair of spools.

4178. The exciter voltage E is commonly 110 volts, though higher voltages are sometimes used with large machines. The use of 110 volts is common, because it permits the use of an ordinary 110-volt incandescent dynamo as an exciter. We will assume that the field for which we are making calculations is supplied from a 110-volt exciter, and that the normal drop in the rheostat is 10 volts. This will make the pressure across the twelve field coils 100 volts total. We have then

$$\text{cir. mils} = \frac{6 \times \frac{41}{2} \times 5,596 \times 11.5}{100} = 13,192.$$

The nearest size to this is No. 9 B. & S. having a cross-section of 13,090 cir. mils. We will therefore adopt this size of wire for the separately excited field, the slight difference in cross-section being compensated for by cutting out a little of the rheostat resistance.

4179. The current density in the field should be considerably lower than in the armature, because the field windings are deeper and the heat is not so easily dissipated. The current in the separately excited winding is about the same, no matter what load the alternator is carrying, and in this respect is not like the current in the series coils, which varies with the load. For these reasons, it is not safe to allow much less than 1,000 or 1,200 circular mils per ampere in the separately excited winding, and in cases where the winding is very deep a larger allowance than this may be required. In the present case we will take 1,100 cir. mils per amp. as a fair value, thus limiting the current to $\frac{13,090}{1100} = 11.9$ amp.

4180. With a field current of 11.9 amperes, the number of turns required per pair of spools will be $\frac{5,596}{11.9} = 473$ turns,

nearly. *Each coil* should then have 236 turns of No. 9 B. & S. double cotton-covered wire. The diameter of this wire over the insulation will be about 126 mils, and if the coil is wound in 8 layers, the depth of winding will be 1.008 in., so that an 8-layer winding will fit the 1-inch winding space on the spool. (See Art. 4176.) If we use 30 turns to a layer, we will have 240 turns per spool. This is an increase of 4 turns over the number actually required, but it will be better to use this winding than to have an uncompleted layer, since the difference is so small. The length of winding space occupied by the coil will be $30 \times .126 = 3.78$ in., or, say, $3\frac{3}{4}$ in., so as to be sure of enough room. The separately excited coil will therefore be wound with 8 layers of No. 9 wire with 30 turns per layer, the winding space occupied being $3\frac{3}{4}$ in. long and 1 in. deep. With 480 turns per pair of spools, the required field current would be reduced to $\frac{5520}{480} = 11.7$ amp., nearly. The upper coil S, Fig. 1644, shows the arrangement of this field coil on the spool.

COMPOUND OR SERIES FIELD WINDING.

4181. The compound winding must provide a sufficient number of ampere-turns to compensate for the falling off in voltage at the terminals due to the resistance of the armature and the combined effects of armature inductance and armature reaction. The compound winding must also provide the ampere-turns necessary for any increase in terminal voltage in cases where the machine is to be overcompounded. The calculation of the compound winding depends to a large extent upon data obtained from machines of a similar type. Its determination for a machine of new type is always more or less experimental.

4182. The current which is led through the series winding is first rectified, as explained in former articles, and as the current increases in proportion to the load, the field is strengthened proportionally, provided the magnetic circuit is not saturated. This is usually the case with alternators,

so that we may assume that any change in the field current is accompanied by a corresponding change in the field strength. It is not usual to send the whole of the current around the series fields; part of it is shunted through a German-silver resistance, by varying which the amount of compounding can be varied. This allows a considerable adjustment of the series coils, so that their effect upon the performance of the machine can be varied through a wide range without changing the series winding in any way. Sometimes the whole current is not rectified, a portion of it being shunted around by means of a resistance connected to the two sides of the rectifier. In this case the shunt has to revolve with the armature, and is usually mounted on the armature spider. Revolving shunts are generally used on machines of any considerable size, as they avoid the difficulty of commutating a large current. Compound coils are only necessary on the fields of machines which have high armature inductance or resistance, or on machines which have to give a considerable rise in voltage from no load to full load. Other types of machines can be made to give sufficiently good regulation by the use of separately excited coils only.

4183. The drop in the armature is easily calculated when the armature resistance is known, as it is equal to the product of the armature resistance and the full-load current. In this case, therefore, the armature drop will be $45.4 \times .7 = 31.78$ volts.

4184. The machine is to supply 2,000 volts at no load and 2,200 volts at full load; the compound winding must therefore strengthen up the field sufficiently to generate this 200 additional volts, as well as the 31.78 volts required to overcome the resistance of the armature. If there were no armature inductance or armature reaction, the total volts which would have to be generated at full load would be about 2,232. The ampere-turns supplied by two separately excited coils (i. e., 5,596) are sufficient to generate 2,000 volts;

hence, if the above conditions were attained, the ampere-turns on the field at full load would have to be $\frac{2}{3} \times 5,596 = 6,245$, and the ampere-turns which would be supplied by the series coils would be $6,245 - 5,596 = 649$, or about 325 on each spool. For a machine of this kind, however, this would represent only a very small part of the series ampere-turns which would actually be required, because, in the first place, the field is liable to be weakened by the reaction of the armature, and, secondly, a large E. M. F. has to be generated to force the current through the armature against its inductance. In machines of this type the compound ampere-turns may be as much as $\frac{2}{3}$ or more of the ampere-turns supplied by the separately excited coils. In the present case, therefore, we will design each spool so that it will be capable of supplying about 2,500 ampere-turns. If this should prove to be somewhat more than is actually required, it can easily be cut down by allowing more current to flow through the shunt.

4185. We will assume that 70% of the current at full load flows through the series coils, the remaining 30% flowing through either the revolving or stationary shunts. This will make the current in the series coils $45.4 \times .70 = 31.78$, say 32 amp., nearly. The number of turns required for each series coil will then be $\frac{2500}{32} = 78.4$ turns.

4186. The current density in the series coils should be about the same as that in the separately excited windings. If we allow 1,100 circular mils per ampere, as before, we get a cross-section of $32 \times 1,100 = 35,200$ circular mils. Two No. 8 wires in parallel give 33,020, while two No. 7 wires give 41,640. We will adopt the conductor made up of two No. 8 wires, because the current in the series coils is not apt to be continuously at 32 amperes, and we can therefore afford to use a cross-section which is a little on the small side. The outside diameter of No. 8 wire with cotton insulation is about .140 in.; hence in a winding space 1 inch deep we can place 7 layers. If we use 11 turns per layer, we will have 77

turns per coil, and can compensate for the slight decrease in the calculated number of turns (78.4) by changing the shunt a little, so as to cause a correspondingly larger amount of current to flow through the coils. Each turn consisting of two wires in parallel will occupy a length along the winding space of .280 in., and 11 turns will take up a space of $.280 \times 11 = 3.080$ in., say $3\frac{1}{8}$ in. We will allow $\frac{3}{16}$ in. at each end for the hardwood insulating collars, thus making the total axial length taken up by the windings and insulation $3\frac{1}{8} + 3\frac{1}{8} + \frac{3}{16} = 7\frac{9}{16}$ in. The brass flanges on the spools will be about $\frac{1}{4}$ in. thick, so that the total space taken upon the pole-piece will be $7\frac{9}{16} + \frac{1}{2} = 8\frac{1}{16}$ in. The radial length of the pole-piece as originally assumed was 8 in.; it will therefore be necessary to lengthen out the poles a little, in order to accommodate the spool, and increase the diameter of the yoke correspondingly. It is best to have the pole project beyond the spool flange a little, as it keeps the flanges away from the armature and makes it easier to fasten the spools in place. We will therefore make each pole-piece $8\frac{3}{8}$ in. long instead of 8 in. Fig. 1644 shows a section of the spool with both windings in place. The pole-piece is indicated by the dotted outline. This change in the length of the pole-piece will make the inside diameter of the yoke $49\frac{5}{8}$ in., and the outside diameter $57\frac{5}{8}$ in., as shown in Fig. 1643, where the final dimensions are encircled by rings. The spools are held in place on the poles by pins (not shown in the figure), which are fixed in the pole-pieces so as to prevent the coils slipping down on to the armature.

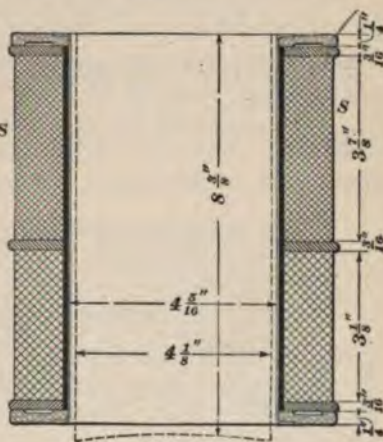

FIG. 1644.

LOSS IN FIELD COILS.

4187. The loss in the field coils should be determined, in order to see if sufficient radiating surface is provided to dissipate the heat. The resistance of the twelve separately excited coils will be

$$R_s = \frac{12 \times 240 \times 11.5 \times \frac{11}{2}}{13,090} = 8.64 \text{ ohms.}$$

The C^2R loss in the separately excited coils will therefore be $(11.7)^2 \times 8.64 = 1,183$ watts, nearly.

4188. The resistance of the twelve series coils is

$$R_s = \frac{12 \times 77 \times 11.5 \times \frac{11}{2}}{33,020} = 1.1 \text{ ohms.}$$

The C^2R loss in the series coils will therefore be $(32)^2 \times 1.1 = 1,126$ watts.

4189. The total loss in the field will be 2,309 watts, or about 2.3% of the output. This is the maximum loss when

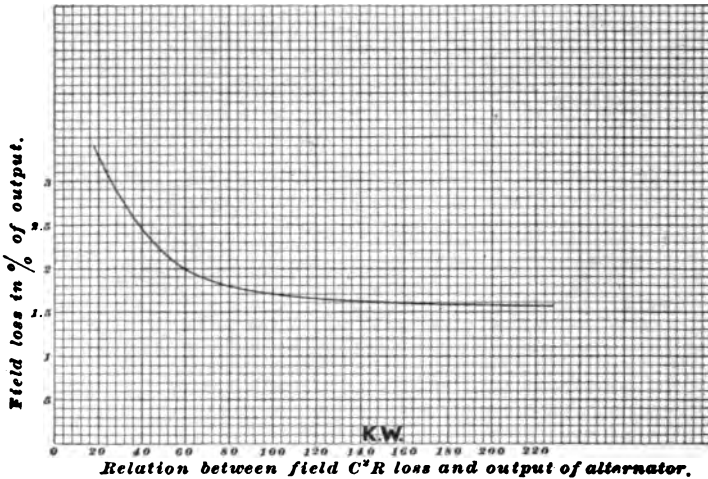

FIG. 1645.

the machine is working at its full output. The average field loss would probably not be over 2% of the output, as

the loss in the series coils would not be as high as 1,126 watts all the time. The loss per coil will be $\frac{230^2}{8} = 192$ watts. The surface of each coil (not counting the ends) is about 350 sq. in. This area is obtained by multiplying the perimeter of the coil as obtained from the drawing by the length of the coil along the pole-piece. This area gives an allowance of 1.8 sq. in. of surface per watt, which is sufficient to ensure a rise in temperature not exceeding 40° C. As far as heating goes, the design of the winding is therefore satisfactory.

4190. The curve shown in Fig. 1645 gives the relation between the average field C^2R loss and the output for alternators of good design. For a 100 K. W. machine the average loss is about 1.7%, and as the average loss in the field designed would probably not exceed 2%, we may consider the design of the field satisfactory as regards efficiency.

MECHANICAL CONSTRUCTION.

FIELD FRAME AND BED.

4191. Fig. 1646 shows the field frame with bed and bearings for the machine designed, and will serve to illustrate the general method of construction used for machines of this type. In this case the field is shown as a separate casting bolted to the base, but, as mentioned before, many machines are constructed with the lower half of the field cast with the base. Where the machine is of large size, it becomes difficult to cast the field and bed together, and the construction shown is usually adopted in such cases. The field is usually set down into the bed as shown, as this lowers the center of gravity of the machine and tends to make it run steadier. The distance between the centers of bearings is determined by the over-all length of the armature and the space taken up by the collector rings. The bed itself is almost exactly similar to the beds used for multipolar

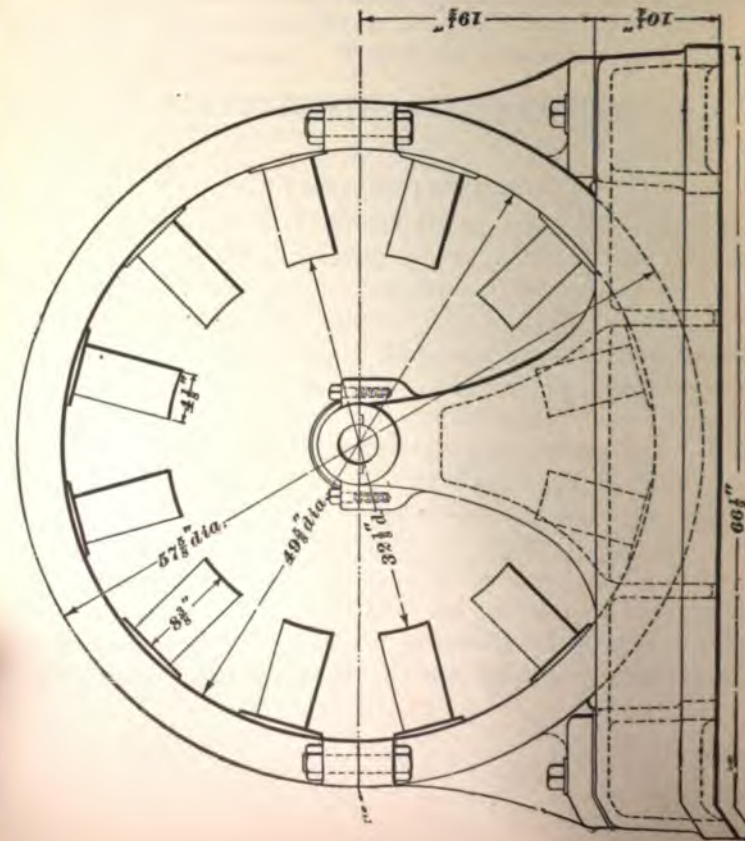
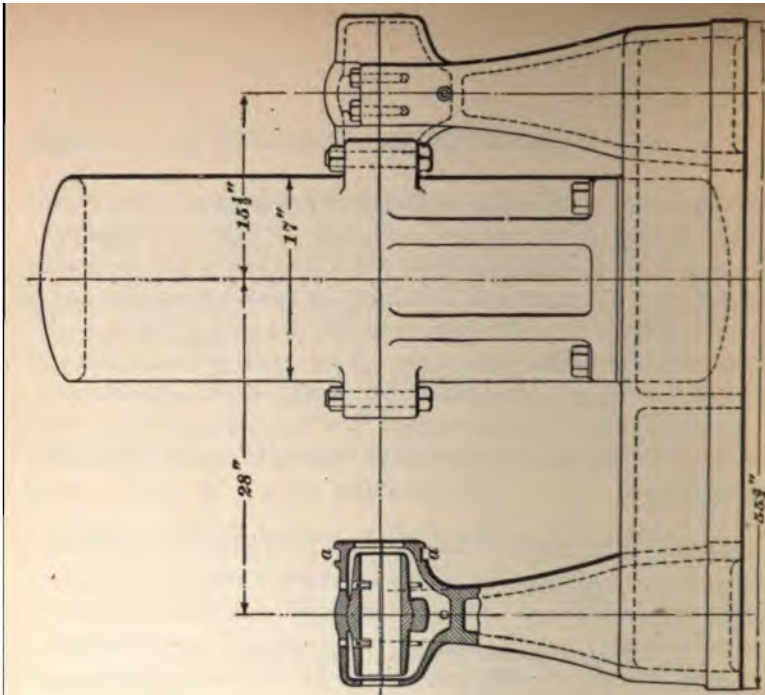

FIG. 1045.

continuous-current machines; it is made hollow and provided with ribs to ensure stiffness. The thickness of metal in the bed will vary from about $\frac{1}{2}$ in. or $\frac{5}{8}$ in. up to $1\frac{1}{4}$ or $1\frac{1}{2}$ in. for machines varying in size from about 50 K. W. to 500 K. W. Self-oiling bearings of the ring type are used almost exclusively. These bearings have already been described in connection with continuous-current machines. The bearing pedestals, as shown in Fig. 1646, are cast with the base, though in many large machines it is common practice to cast them separately and bolt them to the bed. The bearing cap and pedestal is grooved at *a a* to receive the rocker-arm, which carries the rectifier brushes. Some makers place the rectifier and collector rings outside the bearing and bring the connecting wires through the shaft; in such cases the outside end of the bearing cap and pedestal has to be grooved to receive the rocker-arm. Machines of the type shown are usually arranged so that they can be mounted on rails in the same manner as continuous-current machines.

COLLECTOR RINGS AND RECTIFIER.

4192. One of the distinguishing features of an alternator is the arrangement by which the current is collected. The commutator of the continuous-current machine, which is usually made up of a large number of parts, is replaced, in a simple alternator, by two or more plain collector rings. In case the alternator is compound wound, the commutator is replaced by two or more collector rings in combination with a rectifier. Although there are, in general, a small number of parts connected with a collector as compared with a commutator, the mechanical construction of the collector must be carefully carried out, because it is necessary in most cases to secure high insulation. Fig. 1647 shows a construction which may be used for simple collector rings. Such a pair of rings would be suitable for a single-phase alternator with a separately excited field winding only. The same construction could be used for separately excited two-phase or three-phase machines, the only difference

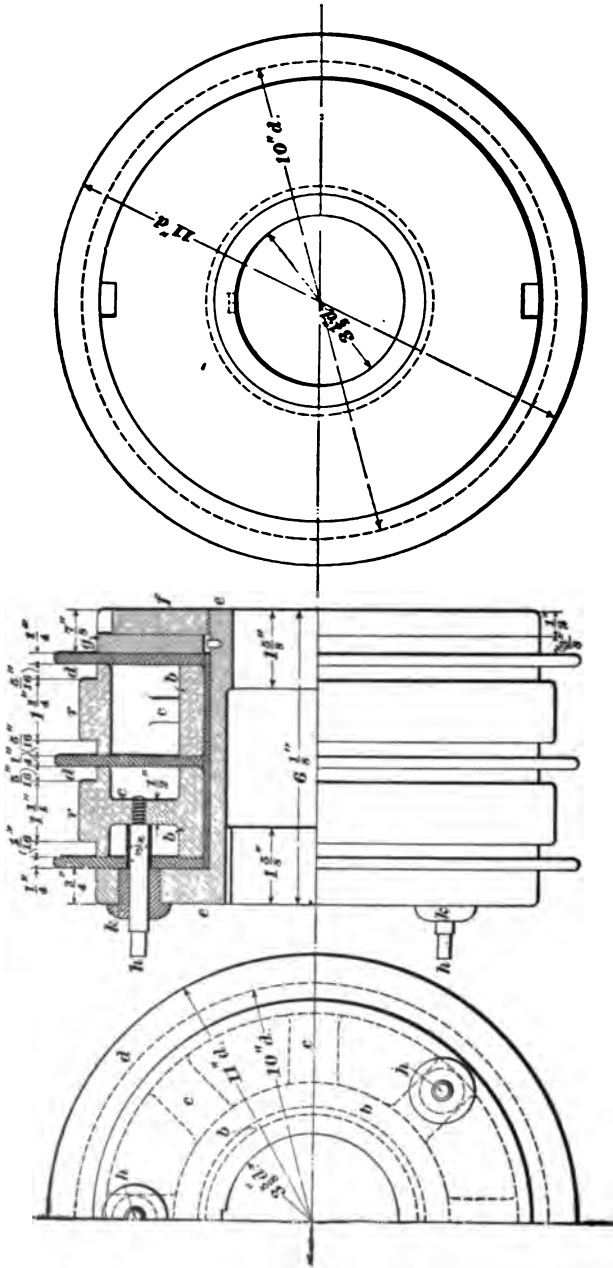

FIG. 1647.

being in the number of rings employed. The rings r, r are made of cast copper, which must be free from blow-holes or imperfections tending to cause uneven wear. These rings are usually made heavier than is necessary for collecting and carrying the current, in order to make them strong mechanically and to allow for wear. Care must be taken to have the rings very thoroughly insulated from each other and from the shaft, when the rings are used with a revolving armature. Revolving-field collectors are not usually subjected to high potentials, and unusual precautions do not need to be taken to effect their insulation. Fig. 1647 shows the construction used for rings which are subjected to a pressure of about 2,000 volts. The rings are cast with a hub b , which supports the rings by means of the spokes c . The insulation d between the disks is usually made of either red fiber or hard rubber, the latter being preferable, especially for high potentials. These insulating disks should be at least $\frac{1}{4}$ in. thick, in order to keep them from breaking easily, and they should also project some distance above the surface of the rings, in order to avoid any danger of the current arcing over from one ring to the other. The insulating washers and collector rings are assembled on a shell e , made either of cast iron or brass, the latter being preferable for collectors of small size. This shell is thoroughly insulated with several layers of mica, and the assembled collector is clamped firmly in place by means of the nut f and washer g . When the collector is of large diameter, it is usually clamped up by means of bolts instead of the nut f . The connections to the rings are made by two copper studs h , which pass through the back of the shell and connect to each of the rings by being screwed into one of the spokes as shown. These studs are heavily insulated throughout their length by tubes made of mica or hard rubber. After the terminals of the armature winding have been attached to the studs, all exposed parts should be heavily taped to avoid any danger of arcing from one terminal to the other. Where the studs pass through the back of the shell, they are insulated by thick hard-rubber bushings k .

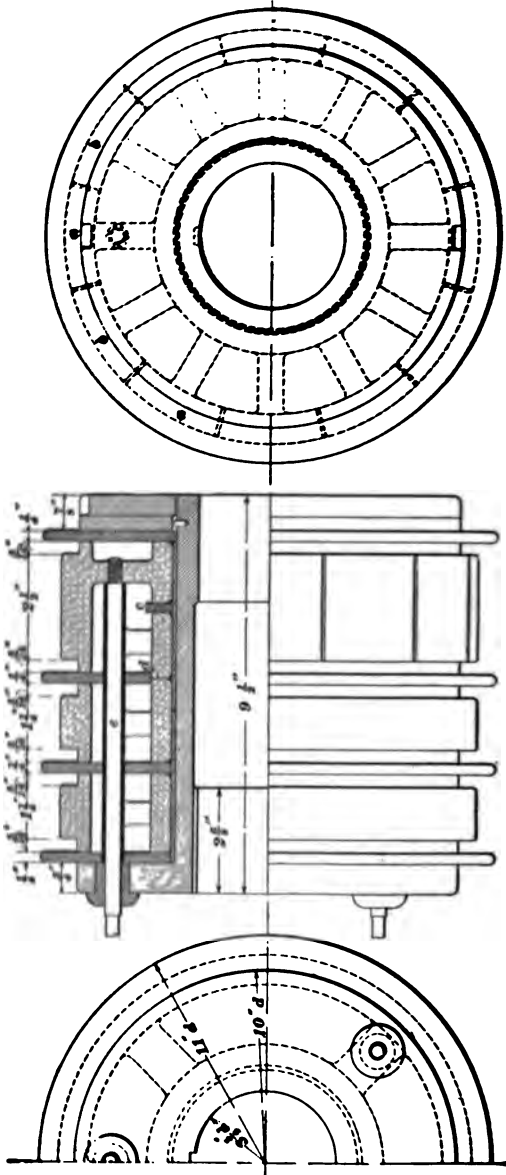

FIG. 1648.

4193. The dimensions of the rings are determined quite as much by mechanical considerations as by the current which they are to collect. The surface of the rings should be wide enough to present sufficient collecting surface, and they should be thick enough to allow for a reasonable amount of wear. Such rings should collect at least 200 amperes per square inch of brush contact surface. This assumes that copper brushes are used, which is generally the case with alternators. Carbon brushes are used chiefly to suppress sparking in connection with continuous-current machines, consequently they do not have any great advantage over copper in connection with alternators, and are therefore but little used. Carbon brushes, if used, would require about three times the collecting surface allowed for copper. The rings should not be made of too large diameter, or the rubbing velocity between the brush and ring will be high, thus tending to cause uneven wear and cutting. On the other hand, if the rings are made of very small diameter, they must be made wide to present sufficient collecting surface, thus necessitating the use of wide brushes. If a large collecting surface is required, it is best to use a ring of moderately large diameter, and use several brushes on each ring. From 1,500 to 2,500 ft. per minute are fair values for the peripheral speed of collector rings for belt-driven machines. The rings shown in Figs. 1647 and 1648 are 10 in. in diameter.

4194. For compound-wound machines, it is necessary to have a rectifier in addition to the collector rings. The rings and rectifier are usually built up together, though some makers mount them on the shaft separately. Fig. 1648 shows a combined pair of collector rings and rectifier suitable for the single-phase machine designed. The rings are made 10 in. in diameter and $1\frac{1}{4}$ in. wide, the construction used being the same as that already described. The rectifier is made up of two castings, each having six sections, those belonging to one casting being marked *a*, and those belonging to the other, *b*. These two castings are separated

by the mica collar *c*, and mica insulation is provided between the segments *a* and *b*, as in a regular continuous-current commutator. One set of segments connects to one of the collector rings through the hubs, as shown at *d*. The other rectifier casting is connected to the stud *e*, which is in turn connected to one terminal of the armature winding. The other stud is connected to the remaining collector ring. The details of construction will be understood by referring to the drawing, as they are almost identical with those described in connection with Fig. 1647.

BRUSHES AND BRUSH HOLDERS.

4195. Copper brushes are generally used for the reasons given in Art. **4193**. Copper leaf or wire brushes similar to those used for direct-current machines are generally employed. It is best to have at least two brushes for each collector ring, though this is hardly as essential as with direct-current machines, because collector-ring brushes do not need as much attention while the machine is running as those used with commutators; for this reason a large number of machines are built with only one brush for each collector ring. Two or more brushes should, however, be

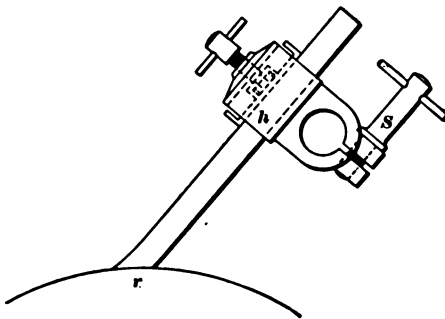

FIG. 1649.

used for each terminal of the rectifier, because these brushes are liable to need more or less adjustment while the machine is running. The holders used should be so designed that the copper brush will press on the rings at an angle of about 45° . Any good form of copper brush holder used on continuous-current machines will answer equally well for an alternator. Such a holder should be arranged so that

used for each terminal of the rectifier, because these brushes are liable to need more or less adjustment while the machine is running. The holders used should be so designed that the copper brush will press on the rings at an angle of

the brushes may be lifted from the commutator and held off, and the pressure of the brush on the ring should be easily varied. The pressure of the brush on the ring may be provided by making the brush itself act as a spring, or the holder may be provided with a spring, the tension of which is adjustable. Fig. 1649 shows a simple type of holder which has been used considerably on alternators. The brush is made long enough between the holder *h* and the ring *r* to render it flexible and allow it to follow any unevenness of the surface. The pressure on the ring can be varied by changing the position of the holder on the stud by means of the clamp *S*. One advantage of this style of holder is that the current has no loose contact surfaces to pass through between the brush to the brush-holder stud.

BRUSH-HOLDER STUDS.

4196. Brush-holder studs follow the same general design as those used for continuous-current machines, special care being taken to have them very well insulated.

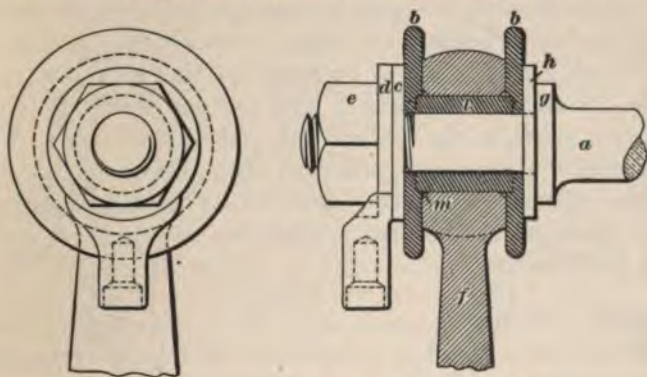

FIG. 1650.

Fig. 1650 shows a common type of stud and the method used for insulating it. The brass stud *a* is circular in cross-section and is provided with a shoulder *g*, which clamps against a washer *h*. The stud is insulated from the rocker-arm by a heavy hard-rubber bushing *l* and washers *b*. The

hard-rubber bushing *f* is let into the washers *b*, as shown, in order to break up the path by which the current tends to jump from the stud to the supporting casting. The sharp corners of the casting should also be removed, as shown at *m*. The cable terminal *d* is clamped between the washer *c* and the nut *e*. Fig. 1451 shows another method

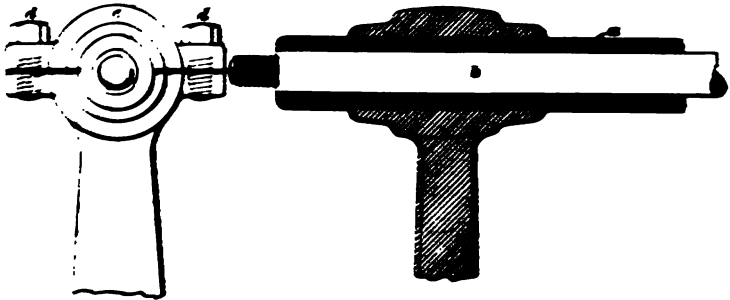

FIG. 1451.

which is sometimes used for mounting and insulating brush-holder studs. A hard-rubber tube *a* fits tightly over the stud *b* and completely covers it except at the points where the brush holders and cable connections are placed. The brush-holder stud is clamped to the rocker-arm, as shown, by means of the cap *c* and the cap bolts *d*. Connection is made to the cable at the end of the stud. This construction gives very good insulation between the stud and the rocker, because the insulation is unbroken and no path is open for the current to jump across unless it punctures the tube itself.

4197. The studs which carry the rectifier brush holders should be mounted on a rocker-arm, so that they may be adjusted, with reference to the field, in the same manner as the brushes of a direct-current machine. The studs for the collector-ring brushes may be carried on the same rocker-arm, or may be mounted on a stationary stand bolted to the bed of the machine. The collector-ring brushes do not have to occupy any definite position relatively to the field; hence it is not necessary that they should be mounted on

the rocker-arm, though this is very often done for the sake of convenience and cheapness of construction. The angular distance between the arms of the rocker carrying the rectifier studs will depend on the number of poles on the machine. Suppose Fig. 1652 represents the rectifier for the twelve-pole machine worked out. All the light sections belong to one casting and the dark ones to the other. The angular distance from center to center of segments is 30° . When one set of brushes is on a light segment, the other set must be on a dark segment; hence the brushes might occupy the position c and d' . This, however, would bring the brushes too close together, and we will place the rocker-arms so as to make them as far apart as possible, and still have them conveniently located. We will therefore place the rocker-arms carrying these brush-holder studs 150° apart, thus bringing the brushes into the position c, d .

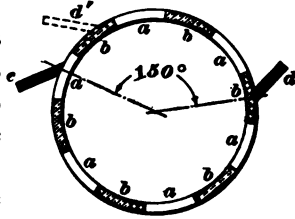

FIG. 1652.

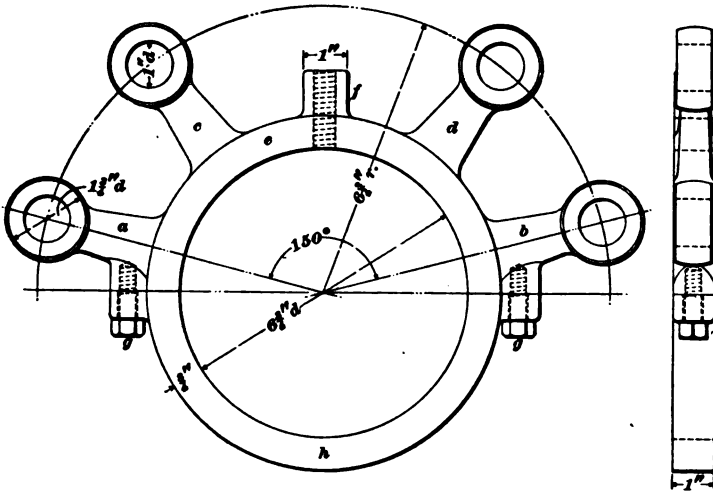

FIG. 1653.

4198. Fig. 1653 shows a rocker-arm suitable for the single-phase machine designed. The arms a, b are 150°

apart, and carry the rectifier studs, the arms c, d for the collector-ring studs being carried on the same rocker. The hub e is bored to fit the groove in the bearing cap, and the rocker is made in halves, as shown, so as to be easily removable, and held together by bolts g, g . The lug f is tapped out to receive a handle, which serves both to shift the rocker and clamp it in any desired position by screwing it down against the seat on which the rocker moves.

SHAFTS.

- 4199.** Shafts for alternators are designed according to the same rules as those for direct-current machines, and what has been said of them in the section on Dynamo-Electric Machine Design (Continuous-Current) applies equally well here. These shafts are usually made larger than the size called for by the power to be transmitted. Stiffness is an essential feature of all armature shafts, and in order to secure this, they are made quite large, considering the actual amount of power which they have to transmit. This is necessary, because the shaft has not only to support the weight of the armature, but it may also be called upon to stand heavy magnetic pulls if the field is not evenly balanced. A shaft suitable for the 100 K. W. machine is shown in Fig. 1654. This is designed for a pulley journal, 13 in. \times 4 in., and a collector end journal, 10 in. \times 3 $\frac{1}{4}$ in. The keyway a is for the armature spider key. The central portion of the shaft where the spider fits on is usually made a little large, so that the spider may be forced into place. The keyway for the pulley is shown at b ; the size of the keyways may be obtained from Table 111, Dynamo-Electric Machine Design. At the internal corners of the shaft



should be rounded as shown at c , c , and oil grooves d , d should be provided to prevent the oil from working its way out of the boxes by creeping along the shaft. In many cases the exciter is driven from a pulley mounted on an extension of the armature shaft. The shaft must then be furnished with a keyway on the extension for the exciter pulley, as shown by the dotted lines.

PULLEYS.

4200. Ordinary cast-iron pulleys are usually employed. Broad-faced pulleys are usually provided with two sets of arms, and the pulleys, on the whole, are constructed somewhat heavier than those used for general transmission work. For pulleys of small size, the web construction (shown in Fig. 1387, *Dynamo-Electric Machine Design*) may be used. Large pulleys should be made in halves, and strongly bolted together both at the hub and rim. The diameter of the pulley is determined by the linear speed at which it is allowable to run the belt. A fair average value for this belt speed may be taken from 4,000 to 5,000 feet per minute for machines varying in size from 50 K. W. to 500 K. W. It is not advisable to run the belt at a speed much higher than 5,500 feet per minute, as the grip between the belt and pulley becomes less with higher speeds. The diameter of the pulley in inches is then given by the expression

$$\text{Diam. of pulley} = \frac{12 s}{\pi \times \text{R. P. M.}} \quad (691.)$$

where s = belt speed in feet per minute.

Applying this to the 100 K. W. machine, and taking 4,500 feet per minute as a fair value for the belt speed, we get

$$\text{Diam. of pulley} = \frac{12 \times 4,500}{3.14 \times 600} = 28.6 \text{ inches.}$$

We will make the diameter of the pulley $28\frac{1}{2}$ in., as shown in Fig. 1655. The face of the pulley must be slightly wider than the belt necessary to transmit the given amount of power at the required belt speed. The belt must be of such width that the strain on it per unit width will not be more

than the belt can safely carry. The amount of power which can be transmitted per unit width of belt depends upon the quality and thickness of the belt as well as on the belt speed. Assuming that a double thick belt is used, we may determine the width of belt necessary by means of the following formula:

$$\text{Width of belt} = .7 \times \frac{w}{s}, \quad (692.)$$

where w = output of generator in watts.

Applying this to the 100 K. W. machine, we get

$$\text{Width of belt} = .7 \times \frac{100,000}{4,500} = 15.5 \text{ in.}$$

We will allow $\frac{1}{4}$ in. on each side of the belt, thus making the face of the pulley 17 in. wide. Fig. 1655 shows a pulley

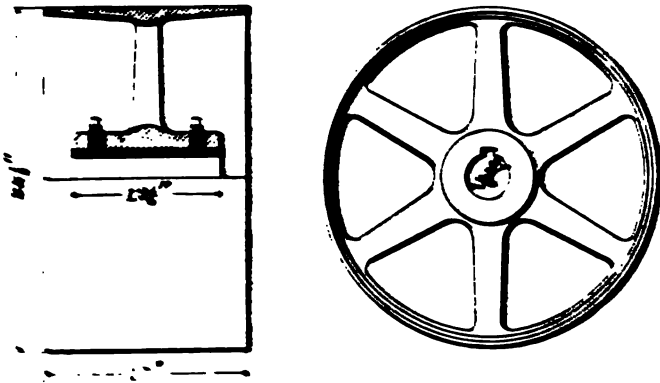

FIG. 1655.

used for this machine. The pulley is made of cast iron, as the face is not very hard, and is used to prevent the pulley work-

CONNECTERS

CONNECTIONS for alternators have been discussed in Chaps. 1921 and 1922. The following are some of the apparatus; the details of the construction are not set out on the

machine. We will first consider the connections suitable for a single-phase compound-wound machine of the type designed. Fig. 1656 represents the connections of such a machine. T and T' are the two terminals of the armature winding, one of which is connected to one collector ring by means of the stud a . The other terminal T' is connected to one side of the rectifier by the stud b , the other side of

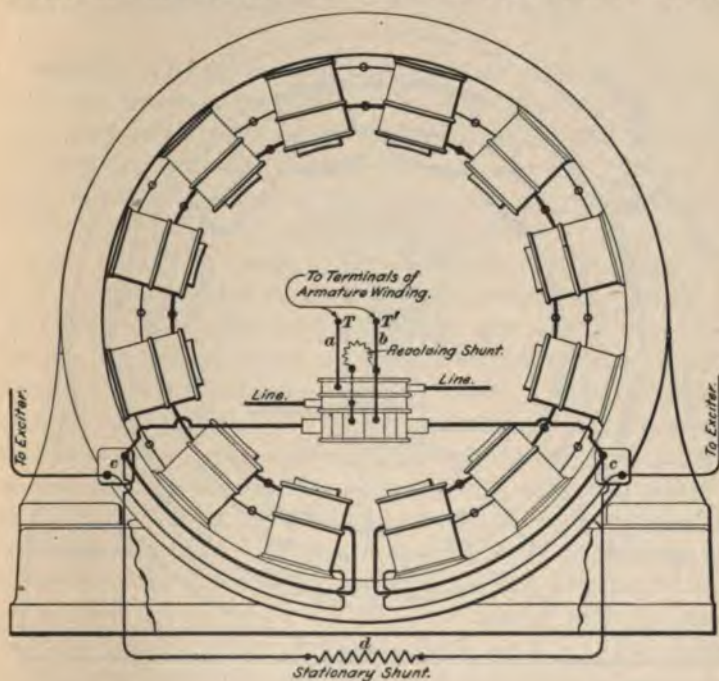

FIG. 1656.

the rectifier being connected to the remaining collector ring. If a revolving shunt is used across the rectifier, it is necessary to have another connection stud, shown by the dotted line. The revolving shunt is then connected between this stud and b , thus placing the shunt across the rectifier and allowing a certain portion of the total current to flow by without being rectified. The line-wires lead from the two collector rings, and the rectifier brushes are connected

to the series field by means of the connection boards c, c . The connections between the series field, armature, rectifier, and collector rings shown in Fig. 1656 are those which are used on the General Electric Co.'s machines of this type. The Westinghouse Co. use a different arrangement for supplying the rectified current to the series coils, which is shown in Fig. 1657. In this case the terminal T is connected to one end b of the primary ab of a small transformer. The

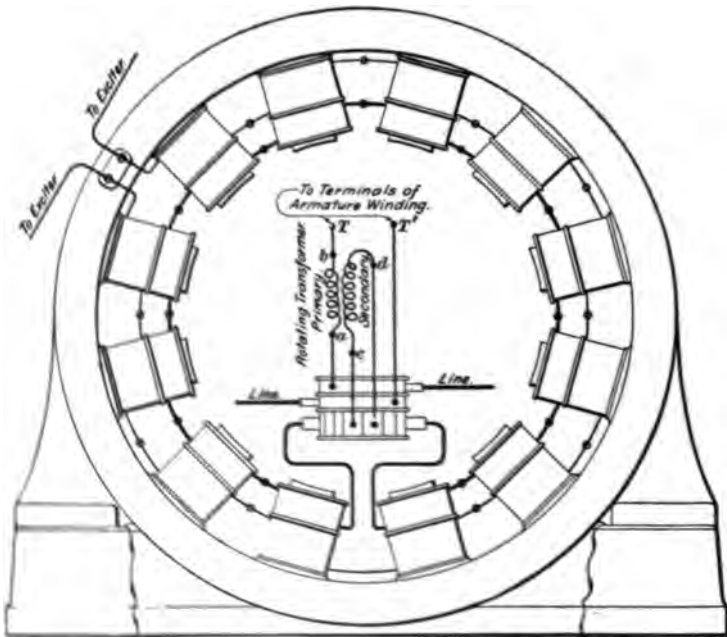

FIG. 1657.

other end of this primary connects to the collector ring as shown, so that all the current flowing through the armature passes through this coil. The secondary $c d$ of this transformer connects directly to the two sides of the rectifier, which in turn connects to the series field by means of the brushes. The other end of the winding is connected directly to the winding as shown. In this case it is seen at once that there is no electrical connection between the armature and

the series coils, the latter being supplied by an induced current from the secondary $c d$. This transformer, which is usually quite small, must, of course, revolve with the armature, and in some of the smaller machines the spokes of the spider form the core of the transformer. The use of this transformer renders the insulation of the series coils easier, because it separates the armature connections entirely from the field.

4202. The connections for the field coils vary little in different makes of machines, so we will take those shown in Fig. 1656 as a typical case. The windings of the field coils are connected up so as to make the poles alternately N and S . Care must be taken that the series coils are not connected in such a way as to oppose the separately excited coils instead of aiding them. The terminals of the separately excited coils are led directly to the connection boards c, c . The terminals of the series coils are also led to the same boards, and from there connected to the rectifier brush-holder studs by means of flexible cables. The stationary shunt d is connected to the same terminals on the connection boards as the series field. This shunt may be attached to the machine or placed on the switchboard; it is usually made up of German-silver wire or ribbon of such size that it will not overheat with the maximum current it may be called upon to carry. The connections and winding of the series coils are generally the same, no matter what the current output or voltage of the machine may be. The series connections may, however, be varied somewhat in machines with different current outputs. When the current output is large, the series coils are sometimes grouped into two sets connected in parallel, thus reducing the current in the field conductor, and allowing the use of smaller and more easily wound wire. For example, the 100 K. W. machine designed had a full-load current output of 45.4 amperes at 2,200 volts; if the same machine were built for 1,100 volts, the current output would be 90.8 amperes at full load. In the first case the series field was designed to carry 32 amperes; in the

second case it would have to carry 64 amperes. Generally we would wish to get the same number of ampere-turns on each pole in either case; so, instead of winding the coils with half as many turns of wire, large enough to carry double the current, we can connect the six upper coils in series and connect them in parallel with the six lower coils, which are also connected in series. This will keep the current in the coils the same, although the line current is doubled. This is often done in practice, as it allows the coils which were designed for a machine of certain voltage to be used for a machine of half that voltage without changing the coil winding in any way.

4203. The line connections are usually made directly to the collector-ring studs when the machine is provided

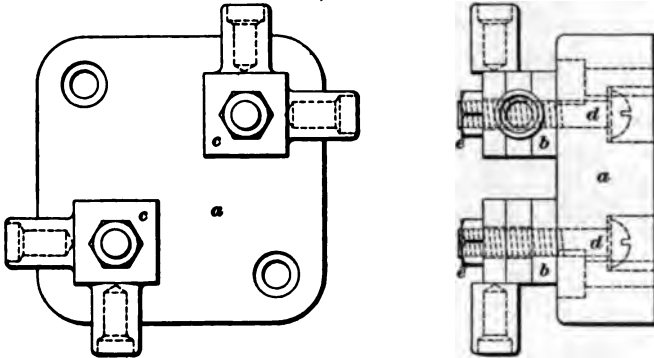

FIG. 1658.

with a revolving armature. When the armature is stationary, the armature terminals are simply run to a connection board, to which the lines are attached. Fig. 1658 shows a simple form of connection board, suitable for the connections shown in Fig. 1656. The base *a* should have high insulating properties, and is preferably made of porcelain, or hardwood treated with oil. If slate or marble is used, care must be taken to see that they are free from metallic veins or impurities. Cable terminals *c* are provided for the shunt and series connections, and these are held in place by screws *d* passing through from the back of the slate. These screws

are well countersunk, and the holes filled in with insulating compound, in order to obviate any danger of the connections becoming grounded on the frame of the machine. The nuts e clamp the terminals firmly in place against the brass blocks b .

4204. Connections between the individual field coils are usually made by means of small brass connectors similar to those shown in Fig. 1659. Three of the commoner forms

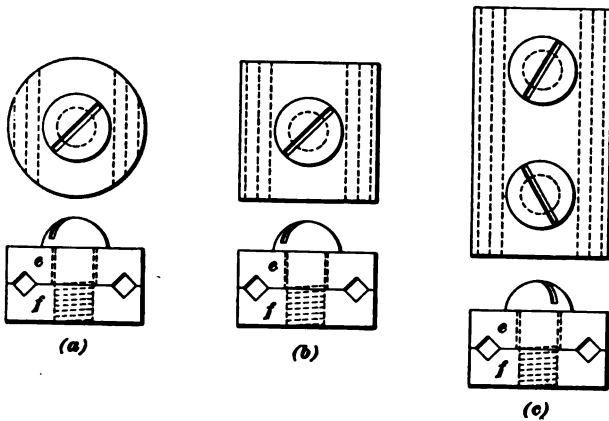

FIG. 1659.

are here shown. They all consist of two brass plates e, f provided with grooves to receive the ends of the coils, and clamped together by screws, as shown. The ends of the coils usually consist of heavily insulated wire brought out from the winding. In some cases where the coils are wound with copper strip, connection between the coils is made by simply clamping the ends of the strip together between brass washers.

4205. Special reference has not been made to the design of fields for two and three phase machines, because there is very little difference between such fields and the one worked out for the single-phase machine. The only difference might be a slight change in the series winding and the connections to the rectifier. The winding of the separately excited coils would be the same, because the exciter voltage

would not be changed, and all three fields were assumed to furnish the same magnetic flux.

4206. Fig. 1660 shows an assembled compound-wound machine with stationary field and revolving armature, such

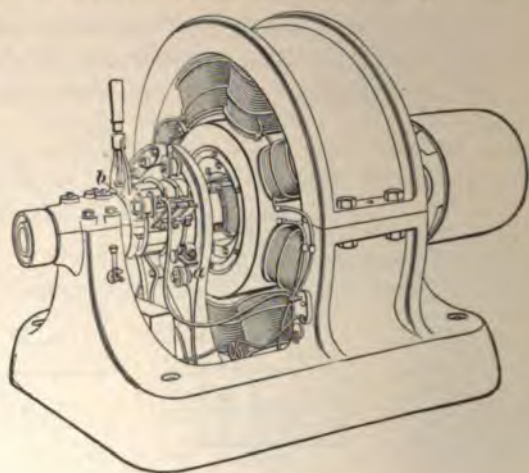

FIG. 1660.

as we have worked out. The lower half of the yoke is in this case cast with the bed, and the yoke itself is provided with flanges, as shown

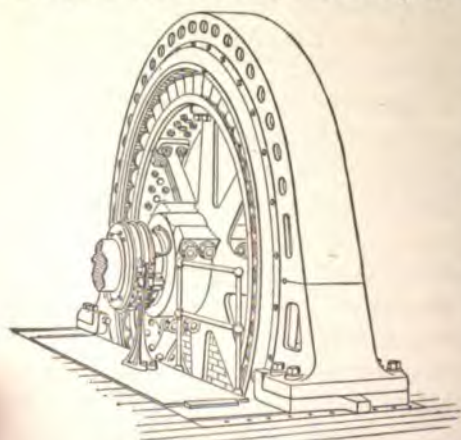

FIG. 1661.

in Fig. 1633 (*c*). The collector-ring brushes are here shown mounted on a stand *a*, and the rectifier brushes are carried on a rocker *b* mounted on the inside end of the bearing. The arrangement of cables, connection boards, etc., will be readily seen by referring to

the figure. Fig. 1661 shows a large alternator designed to run at low speed. This machine is provided with a stationary armature and revolving field, the collector rings shown on the shaft being used to convey the exciting current into the field coils.

TRANSFORMERS.

4207. It was shown in the section on Theory of Alternating-Current Apparatus that a certain amount of loss always occurs in a transformer so long as its primary is connected to a source of E. M. F. The losses which occur may be divided, for convenience, into two classes, namely, **iron losses** and **copper losses**. The iron losses are those which occur in the iron core of the transformer, and are due to hysteresis and eddy currents. These core losses are practically constant for all loads, because they are dependent upon the magnetic density in the core, and this changes but little from no load to full load. The C^2R loss or copper loss in the coils increases very rapidly with the load. The combined effect of these losses is to heat up the coils and core, so that the amount of power which a transformer is capable of delivering is limited by the heating effect. The transformer could therefore be loaded until the coils reached the maximum temperature which the insulation on the wire could stand without injury; any further increase in load would result in the transformer being eventually burnt out. Aside from the danger of overheating, a transformer should not be worked much beyond its rated load, because of the falling off in efficiency. If the load is forced too high, the C^2R loss becomes excessive, and the transformer works uneconomically, even if it does not happen to overheat.

Overloading a transformer also causes a falling off in the secondary voltage, which is very objectionable if the transformer is used for lighting work.

4208. A transformer should be so designed that it will do the work of transforming the current with the least possible cost. This means that the efficiency must not only

be high at full load, but that it should also be high throughout a wide range of load. Fig. 1662 shows the efficiency curve for a transformer of good design. It will be noticed that the efficiency increases very rapidly at first, being as high as 60% with only $\frac{1}{8}$ full load on the secondary. The efficiency varies but slightly between $\frac{1}{4}$ load and full load, and when the transformer is overloaded, the efficiency begins to fall off. A transformer is seldom worked at its full capacity all the time; hence it is important to have a good efficiency through a wide range of load, as shown by the curve. The efficiency can be made high by employing

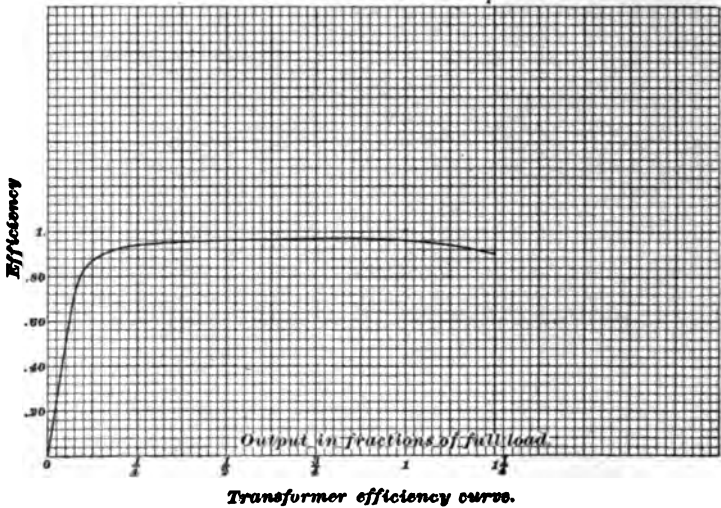

FIG. 1662.

anything that will keep down the losses; but for a transformer of given size, the efficiency can not be increased beyond a certain point without greatly increasing the weight and cost. For example, the C^2R loss might be made very small by using a large cross-section of copper, but this would necessitate a large winding space, thus increasing the bulk of the transformer and making the core heavy. Increasing the efficiency beyond a certain point is attained only by a large increase in cost, and a transformer may, in general,

be said to be well designed when it gives the highest all-day efficiency consistent with an economical distribution of iron and copper. The curve, Fig. 1663, shows the relation between output and full-load efficiency which should be attainable in good transformers. The efficiency increases

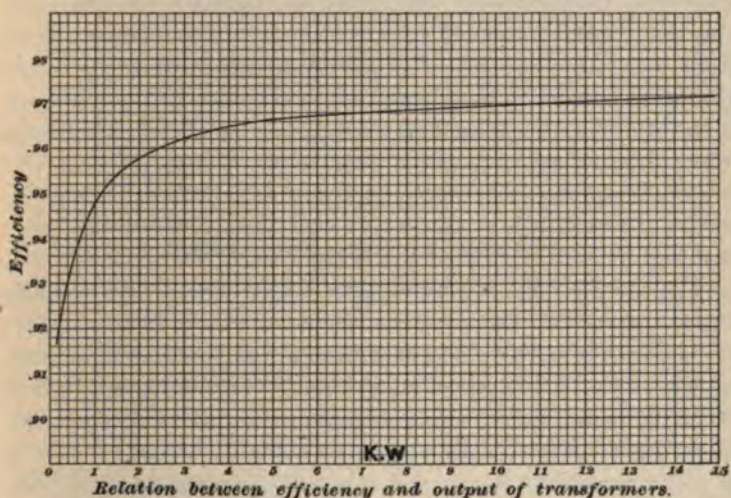

FIG. 1663.

rapidly with the output for transformers of small size, but changes slowly after outputs of 4 or 5 K. W. are reached. Some very large transformers might have an efficiency as high as 98% or slightly over, but it is only in transformers of large size that such a high efficiency is reached.

TRANSFORMER CORES.

4209. Transformer cores have been made in a large number of different shapes, but the two most generally used types are the core and shell varieties shown in Figs. 1548 to 1551, Theory of Alternating-Current Apparatus. Good transformers may be designed using either the core or shell construction, and large numbers of both styles are in common use. Great care should be taken in the selection of the iron

for transformer cores. It should be borne in mind that the hysteresis loss goes on continuously, whether the transformer is loaded or not, and that everything possible should be done to keep this loss small by using only the best quality of core iron. The plates should be about 12 or 14 mils thick for 125-cycle transformers, but may be slightly thicker than this for transformers of low frequency. The oxide on the iron, with the addition of a paper sheet at intervals along the core, is usually sufficient to insulate the disks from each other. Some makers coat the plates with an insulating varnish or japan and do not depend on the oxide film.

HEATING OF TRANSFORMERS.

4210. Since the efficiency of transformers is generally high, the energy lost in them is small, and in transformers of ordinary size there is generally enough radiating surface to get rid of the heat generated. Transformers up to 50 K. W. capacity can usually be made with sufficient ventilation to get rid of the heat generated, but for larger sizes it is often necessary to use special cooling arrangements. Air blasts are frequently used to carry the heat away from the core and windings of large transformers. Sometimes the core and windings are immersed in oil kept cool by water circulating in pipes. Transformers of smaller size are often designed so that the case may be filled with oil. This helps to give the windings good insulation, and keeps down the temperature by conducting the heat from the windings and core to the outside casing. The student should bear in mind that while these special devices are in many cases necessary to get rid of the heat, it does not follow by any means that the transformer is inefficient; on the contrary, the efficiency is usually very high, and these devices are necessary only because the transformer of itself does not present enough radiating surface to get rid of the heat. No definite rules can be given as regards the number of watts which can be radiated per square inch of core or case surface which will apply to all types of transformers. This radiation

constant varies widely for transformers of different size and form, but unless the efficiency is very low, the dimensions of transformers under 40 or 50 K. W. are usually such that they can get rid of the heat generated without undue rise in temperature.

MAGNETIC DENSITY IN CORE.

4211. Transformer cores are worked at low magnetic densities in order to keep down the core losses and magnetizing current. The hysteresis loss is proportional to the frequency and the eddy-current loss to the square of the frequency; hence for an allowable amount of core loss it follows that higher magnetic densities can be used with low than with high frequency transformers. For 60-cycle transformers the maximum value of the magnetic density may be taken from 28,000 to 32,000 lines per square inch. For 125-cycle transformers, the density may be from 19,000 to 21,000 lines per square inch. The densities in individual cases may vary from the above, but the average values used are generally within the limits given.

4212. The allowance of copper per ampere in the primary and secondary coils should be large, in order to keep down the copper loss. The coils are usually heavy, and it is also important to have a liberal cross-section of copper, in order to prevent overheating. The cross-section per ampere should be about the same both for primary and secondary coils. When the core type is used, there is usually room for a liberal cross-section of copper, but in the shell type the winding space is more restricted, and the coils can not be made very large without increasing the bulk of the iron core considerably. The number of circular mils allowed per ampere varies greatly in transformers of different makes and sizes. In general, the allowance should not be less than 1,000 or 1,200 circular mils per ampere, and in many of the later types of transformers the allowance may be as high as 2,000 or over.

ARRANGEMENT OF COILS AND CORE.

4213. The arrangement of coils and core has already been described for two of the common types. The core type



FIG. 1004.

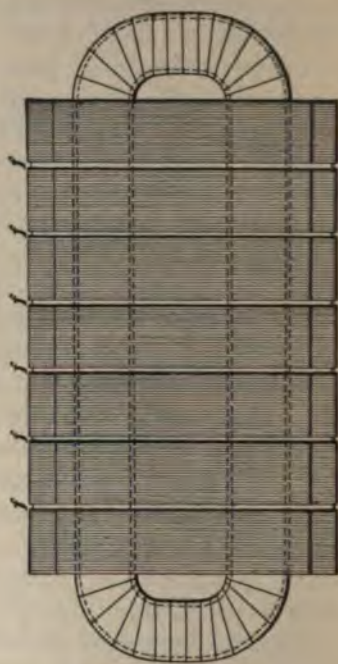
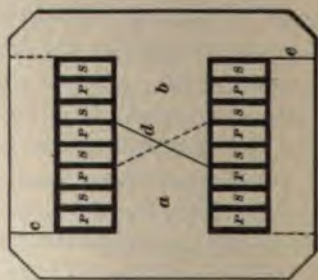
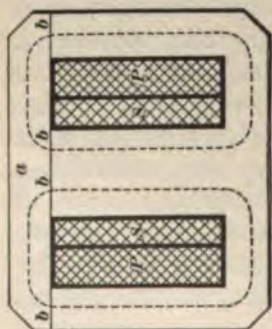

FIG. 1005.



can usually be arranged so that it can be taken apart and the coils slipped off in case repairs are necessary, while the

shell construction very often requires the removal of each plate before the coils can be reached. Transformers have been made with the core built in sections as shown in Fig. 1664. In this case the upper part *a* is built up separately, and forms a cover which can be removed from the main part of the core when it is desired to get at the coils. This construction is, however, objectionable, because it introduces small air-gaps into the magnetic circuit at *b*, *b*, thereby increasing the magnetic reluctance of the core. In designing transformer cores, every effort should be made to have the magnetic circuit continuous. Fig. 1664 also shows a common arrangement of the primary and secondary coils for shell transformers, the secondary coil *S* being slipped inside the primary coil *P*. Fig. 1665 shows an arrangement of coils and core suitable for a transformer of large size. The stampings *a* and *b* are cut as shown, the joints being at *c*, *d*, and *e*. As the core is piled up, these joints are staggered, as shown by the dotted lines, thus making the iron path for the lines practically continuous and doing away largely with the bad effects of the joints. The primary and secondary coils are wound in a number of sections, each consisting of a flat coil, these sections being sandwiched, as

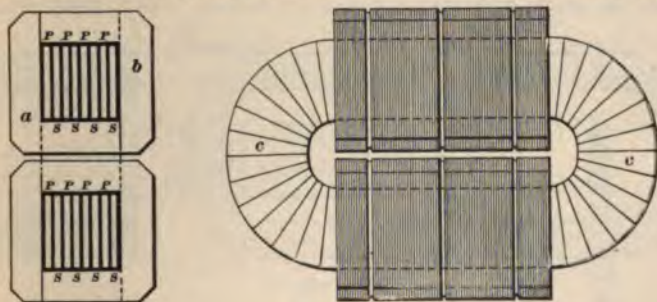

FIG. 1666.

shown, in order to reduce the magnetic leakage between them. Splitting the coils up in this way also makes it easier to insulate the transformer for high voltages, because it cuts down the voltage across any one of the coils. The coils are usually separated from each other by a built-up sheet of mica

or other material having high insulating properties. Large cores are frequently provided with ventilating ducts between the laminations as shown at *f*. The laminations are held apart by brass castings, and the channels so formed allow air to circulate through the core, the whole construction being similar to that used for ventilated armature cores. Fig. 1666 shows another arrangement of coils and core which also makes use of thin flat coils. In this case the stampings *a* and *b* surround one side of the coil only, a separate set of stampings being used to form the magnetic circuit around the other side. This is the construction used by the Westinghouse Co. for several of their larger transformers. The projecting ends of the coils *c* are usually spread out like a fan, so as to allow the air to circulate freely between them.

WINDING AND INSULATION OF COILS.

4214. Since transformer coils are usually of simple shape, they can generally be lathe wound and thoroughly insulated. High insulation is of great importance in transformers, and every precaution should be taken to see that the primary and secondary coils are not only well insulated from the core, but also from each other. Fig. 1667 shows

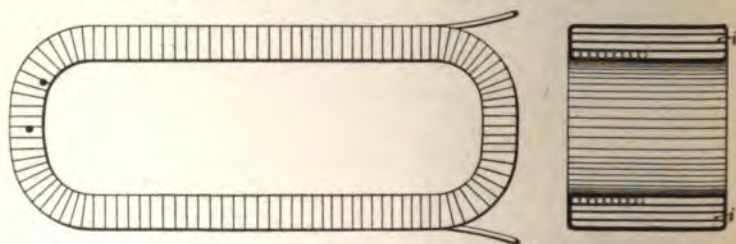

FIG. 1667.

the shape of primary coil commonly used for shell transformers. The coils have to withstand a high impressed line E. M. F., and the voltage between layers may therefore be considerable. Insulation *i* should be placed between each layer, and may be composed of oiled linen tape or other good insulating material. The outside of the coil is heavily taped,

and afterwards treated with insulating varnish and baked. Additional insulation in the form of mica and paper, or in some cases oiled hardwood pieces, is placed between the coils and the core. The secondary coil should be thoroughly insulated from the primary and from the core, though it is in many cases unnecessary to insulate between the layers of the secondary on account of the low voltage which it usually generates. The insulation between primary and secondary should be specially good. Some makers allow a clear air space between the coils in addition to the insulation on the coils themselves. If connection should be established between the primary and secondary, and there should happen to be a ground on the primary mains, a difference of potential would exist between the secondary service wires and the ground which would be equal to the primary voltage. Such a difference of potential between the service wires and the ground would be very dangerous to life; hence the importance of thorough insulation between the primary and secondary. Some makers place a metal shield between the primary and secondary coils which is connected to ground. If the primary insulation breaks down, this shield connects the winding to ground, and thus protects the secondary circuit.

4215. The conductor used for the primary winding usually consists of copper wire, except perhaps in some very

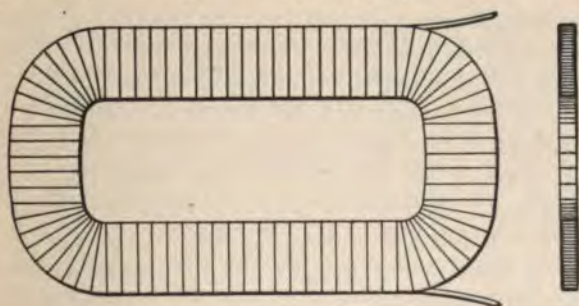

FIG. 1068.

large transformers, where copper strip may be used to advantage. For the secondary, a conductor of large cross-

section is usually required, because the secondary voltage is generally low and the current correspondingly large. For transformers of moderate output, the secondary conductor can generally be made of a number of wires in multiple. In most large transformers, the secondary conductor is made up of copper strip. Fig. 1668 shows a flat secondary coil made up in this way. Such a coil would be suitable for the transformer shown in Fig. 1666. The details of construction and method of calculating the different parts will be best understood by working out an example. We will therefore take up the design of a transformer of the core type such as would be suitable for lighting work.

DESIGN OF 8 K. W. TRANSFORMER.

4216. In starting out to design a transformer, the following quantities are either known or assumed:

Useful secondary output in kilowatts (K.W.);

Primary voltage (E_p);

Secondary voltage (E_s);

Frequency of system on which the transformer is to be operated (n).

For ordinary lighting transformers, E_p is in the neighborhood of 1,000 or 2,000 volts, E_s 50 or 100 volts, and n 60 or 125 cycles per second.

4217. We will take for an example an 8 K. W. transformer of the core type to be designed for 2,000 volts primary and 50 or 100 volts secondary, the secondary being wound in two coils, which may be connected in parallel for 50 volts or in series for 100 volts. The frequency will be taken as 60. A good transformer of this output should have a full-load efficiency of 96.8 or 96.9% (see Fig. 1663); consequently, in designing it we should aim to keep the losses down to such an amount that the efficiency will be, say, 96.8%. We have

$$\text{Efficiency} = \frac{\text{watts output}}{\text{watts input}}. \quad (\text{See Art. 3671.})$$

Hence, for an output of 8,000 watts the input will be

$$\text{Input} = \frac{8,000}{.968} = 8,264 \text{ watts.}$$

The total loss at full load should therefore not exceed 264 watts. This total loss is made up of three parts, namely, the losses due to the resistance of the coils, hysteresis, and eddy currents. It can be shown mathematically that, in order that a transformer shall have a high all-day efficiency, the C^2R loss and the core losses should be about equally divided; that is, the copper loss should be about equal to the sum of the hysteresis and eddy-current losses. If the transformer is used only a short time during each day, it might be well to allow the C^2R loss to be a little larger than the core losses, but the above relation holds approximately correct for well-designed transformers. In the present case, we will aim at making the copper loss, say, 140 watts and the core loss 124 watts. This division of the losses should give a satisfactory transformer for lighting work.

DETERMINATION OF CORE VOLUME.

4218. Since the transformer is to operate on a 60-cycle system, we will take 30,000 lines per square inch as a fair value for the maximum magnetic density in the core. At this frequency and density, there will be a definite amount of loss per cubic inch of iron in the core, depending upon the quality of the iron used. We will assume that the curve *A*, Fig. 1584, represents the quality of the iron in this respect. From this curve, we find that the loss per cubic inch per 100 cycles at a density of 30,000 is about .25 watt. The loss at 60 cycles will therefore be $\frac{60}{100} \times .25 = .15$ watt.

The total core loss is to be 124 watts. This is the loss due to hysteresis and eddy currents combined. The eddy-current loss should be quite small if the core is properly laminated; hence we will take the hysteresis loss alone as 110 watts, and allow 14 watts for the loss due to eddy currents. If the loss per cubic inch is .15 watt, then the volume of iron in the core will be $\frac{110}{.15} = 733$ cubic inches.

DIMENSIONS OF CORE.

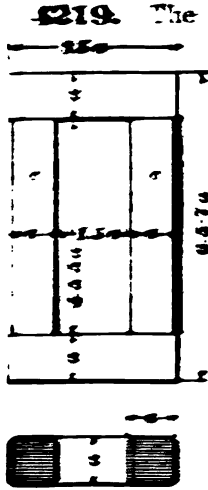

FIG. 1669.

The volume of iron in the core has now been determined, and it remains to proportion the core itself. Fig. 1669 shows the style of core used for this type of transformer, and in proportioning it due regard must be had to the windings which are to be placed on the cores *a, a*. We will make the core square in cross-section, with the corners chamfered slightly, as shown in the figure. If the cross-section $a \times a$ is made very small, the cores will be long and thin, the magnetic flux V will be small, and the coils will have to be provided with a large number of turns to generate the required E. M. F. Long cores also give rise to a long magnetic circuit, thus increasing the

magnetizing current. On the other hand, if the cores are made very short, the wire will have to be piled up deep, in order to get it into the winding space, and the yokes across the ends will have to be made longer. Deep windings also mean a long length of wire for a given number of turns, resulting in a large amount of copper. The best proportions to be given to the core is therefore largely a matter of experience. For preliminary dimensions, we will use the proportions indicated in Fig. 1669, all the dimensions being here expressed in terms of the thickness of the cores. We will make the

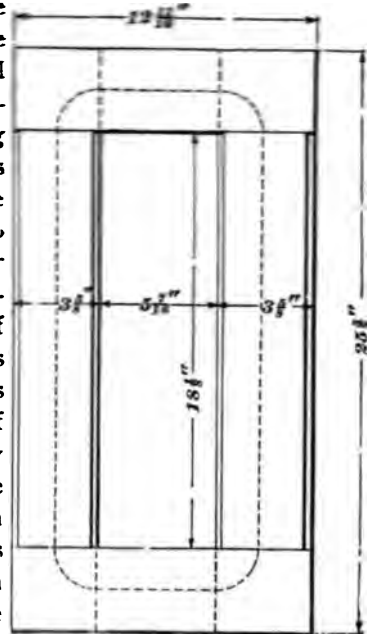

FIG. 1670.

height of the core = $7a$. The volume of the core will then be

$$V = (2 \times 3.5a + 2 \times 5a)a^2, \quad (693.)$$

a^2 being the area of cross-section and $5a$ the distance between the yokes. This gives

$$17a^3 = V = 733 \text{ cubic inches.}$$

$$a = \sqrt[3]{\frac{733}{17}}$$

This makes a just about $3\frac{1}{2}$ in. This is the value of the thickness of the core if it were solid iron. Part of the cross-section is, however, taken up by insulation between the plates, and the corners are cut off slightly, so we will make the core $3\frac{3}{8}$ in. square. The other dimensions follow from this, so we will take the dimensions given in Fig. 1670 as a basis for working out the design further. The distance between the inside edges of the cores will be $5\frac{7}{8}$ in., and the space between the yokes available for the windings will be $18\frac{1}{2}$ in.

DIMENSIONS OF CONDUCTORS.

4220. We will wind the secondary coil next the cores, and place the primary over it. The secondary current at full load will be

$$\frac{\text{secondary watts}}{\text{secondary volts}} = \frac{8,000}{100} = 80 \text{ amperes.} \quad (694.)$$

The secondary coil will be wound in two sections, one section being placed on each core. Each section will have a sufficient number of turns to generate 50 volts, and the conductor will be capable of carrying 80 amperes. If an output of 100 volts and 80 amperes is required, the coils may be connected in series and their E. M. F.'s added. If an output of 160 amperes at 50 volts is desired, the coils may be connected in parallel. In either case, the full-load current *in the conductor* will be 80 amperes. In this type of transformer, a large cross-section is usually allowed per ampere, because there is plenty of room for the coils, and the number

of turns is usually large. We will therefore allow 2,000 circular mils per ampere to obtain the approximate size of the conductor. We have then

Circular mils cross-section of secondary conductor = $80 \times 2,000 = 160,000$ cir. mils.

Six No. 6 B. & S. wires in parallel will give $6 \times 26,250 = 157,500$ circular mils. We will therefore make up the secondary conductor as shown in Fig. 1671, using 6 bare wires in multiple and covering the whole with a cotton insulation having a double thickness of 20 mils. The bare diameter of the wire is .162 inch; hence the width of the conductor over all will be $2 \times .162 + .02 = .344$ in. The height of the conductor will be $3 \times .162 + .02 = .506$ in.

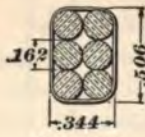

FIG. 1671.

4221. The watts supplied to the primary at full load are 8,264. Hence, the primary current will be

$$\frac{\text{primary watts}}{\text{primary volts}} = \frac{8,264}{2,000} = 4.132 \text{ amperes.} \quad (695.)$$

The primary current at full load will be very nearly in phase with the E. M. F.; or, in other words, the power factor will be very nearly 1. The magnetizing current should be quite small, so that the primary current at full load will be but slightly larger than the above amount. We will call the full-load primary current 4.25 amperes, in order to allow a little for the magnetizing current. Allowing the same cross-section per ampere in the primary as in the secondary, we get

Circular mils of primary conductor = $4.25 \times 2,000 = 8,500$ circular mils.

A No. 11 B. & S. wire has a cross-section of 8,234 circular mils, which is nearly the number required. The diameter of this wire over the insulation may be taken as .101 in.

CALCULATION OF PRIMARY AND SECONDARY TURNS.

4222. The primary coil has to be provided with a sufficient number of turns to generate a counter E. M. F. equal and opposite to that of the mains. The impressed E. M. F.

Is equal and opposite to the resultant of the E. M. F. generated by the primary and the E. M. F. necessary to overcome the resistance of the primary. The drop through the primary at no load due to the ohmic resistance is so small that it may be neglected in comparison with the E. M. F. which is generated by the primary coil, so that we may take the E. M. F. so generated as equal numerically to the impressed E. M. F. The number of turns required to set up this E. M. F. will depend upon the magnetic flux N which threads through the turns. The maximum magnetic flux through the coil will be

$$N = \mathbf{B} \text{ max.} \times A, \quad (696.)$$

where $\mathbf{B} \text{ max.}$ is the maximum value which the magnetic density reaches during a cycle, and A is the area of cross-section of iron in the core on which the coil is wound.

In this case $\mathbf{B} \text{ max.}$ is 30,000 lines per square inch, and the area of cross-section of the iron is $3\frac{1}{2} \times 3\frac{1}{2} = 12.25$ square inches; hence,

$$N = 30,000 \times 12.25 = 367,500 \text{ lines.}$$

Taking the E. M. F. generated in the primary as the equal and opposite of the line voltage, we may write

$$E_p = \frac{4.44 N T_p n}{10^8}, \quad (697.) \quad (\text{See Art. 3882.})$$

where

N = maximum value of the magnetic flux through the core;

T_p = number of turns on primary coil;

n = frequency (cycles per second);

E_p = impressed primary voltage.

Applying this to the present example, we have

$$2,000 = \frac{4.44 \times 367,500 \times T_p \times 60}{10^8},$$

or
$$T_p = \frac{2,000 \times 10^8}{4.44 \times 367,500 \times 60} = 2,042, \text{ nearly.}$$

We will therefore provide the primary coil with, say,

2,040 turns and place 1,020 on each of the cores, as this number will give an even number of turns on each coil. Dropping two turns would not appreciably affect the working of the transformer, as the magnetic density would have to be increased but very slightly to make up for the difference.

4223. The number of secondary turns T_s will be

$$T_s \times \frac{E_s}{E_p}, \quad (698.)$$

(where E_s is the secondary voltage) since the turns must be in the same ratio as the voltages generated. This will give for the present case

$$2,040 \times \frac{1000}{2000} = 102 \text{ turns.}$$

The total number of secondary turns will therefore be 102, or there will be 51 turns on each coil, using the conductor shown in Fig. 1671.

ARRANGEMENT OF PRIMARY AND SECONDARY COILS.

4224. The coils will be arranged on the core as shown in the section through the coils and core, Fig. 1672. The

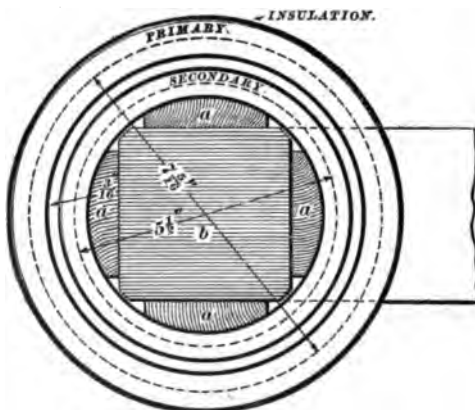

FIG. 1672.

secondary will be wound next the core, in order to make the length of the heavy secondary conductor as short as possible. The coil will be held firmly in position by oiled hardwood blocks a placed between it and the iron core b . The diameter of the coils could be made somewhat less by chamfering the corners more than shown, but this would decrease the cross-section of iron, so that very little would

be gained in the end. Both coils are heavily insulated with linen tape, and provision is made for a clear space of $\frac{3}{16}$ in. between the primary and secondary. The length of the cores between the yokes is $18\frac{1}{2}$ in. (see Fig. 1670). Each secondary coil contains 51 turns. The breadth of each turn is .344 in., so that 51 turns would take up a length along the core of $51 \times .344 = 17.5$ in. The secondary coil can therefore be made up of one layer of 51 turns of the conductor shown in Fig. 1671. This arrangement will allow about $\frac{3}{16}$ in. clearance at each end between the secondary winding and the yoke, in addition to the taping. The arrangement of this winding will be readily understood by referring to the section of the coils shown in Fig. 1674. The mean diameter of the secondary coil will be $5\frac{1}{2}$ in. and the mean length of a turn 1.44 ft.

4225. The primary coil is placed over the secondary, as shown in Fig. 1672. The space of $\frac{3}{16}$ in. is allowed to ensure good insulation between the coils and to allow the use of a ground shield if desired. In case the transformer is immersed in oil, the film of oil between the coils forms an insulating layer which is not easily broken down. We will make the primary coil slightly shorter than the secondary, and adopt a clear winding space say $17\frac{1}{4}$ in. in length. This will remove the high-tension primary windings a little farther from the yokes and avoid danger of arcing over. The diameter of the primary conductor over the insulation is .101 in.; hence in a layer $17\frac{1}{4}$ in. long we can place $\frac{17.25}{.101} = 170$ turns, nearly. We must place 1,020 turns on each coil, so that we can arrange the winding by using 6 layers of 170 turns per layer. The two primary coils are connected in series across 2,000-volt mains; hence the pressure across each coil will be 1,000 volts, and there will be 166 volts generated in each layer. The pressure tending to break down the insulation between the beginning of the first layer and the end of the second will therefore be the maximum value corresponding to an effective pressure of

333 volts. It is necessary, therefore, to insulate each layer from the one next it, and particular care should be taken at the ends of the coil, where a breakdown between layers is most liable to occur. We will allow 20 mils for insulating tape between each layer and $\frac{1}{16}$ in. all around for the outer taping on the coil. This will make the thickness of the primary coil

$$6 \times .101 + 5 \times .020 + \frac{1}{8} = .831 \text{ in.}$$

The mean diameter of the primary coil will be about $7\frac{3}{8}$ in., and the mean length of a primary turn 1.91 feet.

4226. All the essential dimensions of the transformer have now been determined. With the primary winding calculated above, the outside diameter of the primary coil will be about $8\frac{1}{8}$ in. The distance from center to center of cores is $5\frac{1}{16} + 3\frac{3}{8} = 9\frac{1}{16}$ in., so that there would be a space between the coils of $\frac{1}{16}$ in., and the design is suitable as far as the accommodation of the windings goes.

EFFICIENCY.

4227. In designing the transformer, we aimed at securing a certain efficiency, and so proportioned the core that the hysteresis loss should not exceed 110 watts. The design has been worked out, and it is found that the windings obtained can be accommodated on this core. It now remains to be seen whether the copper loss in these coils is within the allowable amount. If the copper loss is excessive, we must remodel the design of the coils so as to bring it to nearly the allowable amount. In order to calculate the copper losses in the primary and secondary, we must first determine their resistance.

4228. In calculating the resistance of the coils, we will take the resistance of a mil-foot of copper as 11.5 ohms, as it is the hot resistance which we must consider. Since there are 51 turns on each secondary coil, and the length of each turn is 1.44 feet, the resistance of each coil will be

$$R = \frac{51 \times 1.44 \times 11.5}{157,506} = .0053 \text{ ohm,}$$

and the resistance of the two coils in series will be .0106 ohm.

The loss in the secondary at full load will therefore be

$$C_s^2 R_s = (80)^2 \times .0106 = 67.8 \text{ watts.} \quad (699.)$$

4229. Each primary coil has 1,020 turns, and the length of each turn is 1.91 ft. The resistance of each primary coil will then be

$$R = \frac{1,020 \times 1.91 \times 11.5}{8,234} = 2.72 \text{ ohms,}$$

and the resistance of the two coils in series will be 5.44 ohms.

The primary $C^2 R$ loss will therefore be

$$C_p^2 R_p = (4.25)^2 \times 5.44 = 98.2 \text{ watts.} \quad (700.)$$

The total $C^2 R$ loss in the coils as designed is then 166 watts instead of the 140 watts allowed. The difference, however, is not great enough to make a very large difference in the efficiency. It will be noticed that the loss in the primary coils is rather high, since this loss should be about equally divided between the primary and secondary. This can be remedied to some extent by lowering the primary resistance, i. e., by using a larger wire for the primary winding. We will have room enough to do this, because we found that there would be a clearance of $\frac{1}{8}$ in. between the coils with the other winding. Suppose we try a No. 10 wire for the primary and see if this will give a more satisfactory result. The insulated diameter of this wire will be about .112 in. The number of turns which can be placed in 1 layer will be $\frac{17.25}{.112} = 154$. We will therefore use 6 complete layers with 154 turns each, and 1 additional layer with 96 turns. The coil at the part where it is wound 7 layers deep will have a thickness of

$$7 \times .112 + 6 \times .020 + \frac{1}{8} = 1.029 \text{ in.}$$

This will increase the mean diameter slightly and make the mean length of a turn about 1.94 ft. The cross-section

of the wire will now be 10,380 circular mils, so that the resistance of each primary coil will be

$$R = \frac{1,020 \times 1.94 \times 11.5}{10,380} = 2.19 \text{ ohms,}$$

and the resistance of the two coils is 4.38 ohms.

The loss in the primary at full load will then be

$$C_p^2 R_p = (4.25)^2 \times 4.38 = 79 \text{ watts, nearly.}$$

This makes the total $C^2 R$ loss $67.8 + 79 = 146.8$ watts instead of 166. This change in the primary winding makes the loss in the primary and secondary nearly equal, and brings the total loss down nearly to the required amount. We will therefore adopt this winding in place of the one previously calculated. The outside diameter of the primary coils will now be a little over $8\frac{1}{2}$ in., so that there will still be a clearance of about $\frac{1}{2}$ in. between them when the transformer is assembled. The total loss at full load will be $110 + 146.8 + 14 = 270.8$, say 271 watts. The full-load efficiency will then be $\frac{800}{897} = .9673$, or about .7% lower than was assumed when starting out to design the transformer.

EFFICIENCY CURVE.

4230. The curve showing the relation between the efficiency and output can be readily plotted when the efficiencies at different loads are known. We will therefore calculate the efficiency for $\frac{1}{8}$, $\frac{1}{4}$, $\frac{1}{2}$, $\frac{3}{4}$, and full load, also for $\frac{1}{4}$ overload. In order to do this, we will assume that the core loss remains constant. For example, at $\frac{1}{4}$ load the useful output is 2,000 watts, and the secondary current 20 amperes. The primary current will be that corresponding to the secondary current of 20 amp. (or 1 ampere, since ratio of transformation is 1 to 20) plus the current necessary to set up the magnetization and supply the losses. The primary current at $\frac{1}{4}$ load may be taken as approximately 1.12 amp., since the amount of current required to supply

TABLE 117.

Fraction, full load.	Secondary output: Watts.	Secondary current: Amperes.	Primary current: Amp. (approx.)	Core loss.	Primary C^2R loss.	Secondary C^2R loss.	Total loss.	Total input.	Efficiency: Per cent.
$\frac{1}{4}$	1,000	10	.60	124	1.58	1.06	126.5	1,126.5	88.70
$\frac{1}{2}$	2,000	20	1.12	124	5.47	4.24	133.7	2,133.7	93.70
$\frac{3}{4}$	4,000	40	2.16	124	20.41	16.96	161.0	4,161.0	96.10
Full load	8,000	80	4.25	124	79.10	67.80	271.0	8,271.0	96.73
$\frac{1}{4}$ overload	10,000	100	5.30	124	123.00	106.00	351.0	10,351.0	96.60

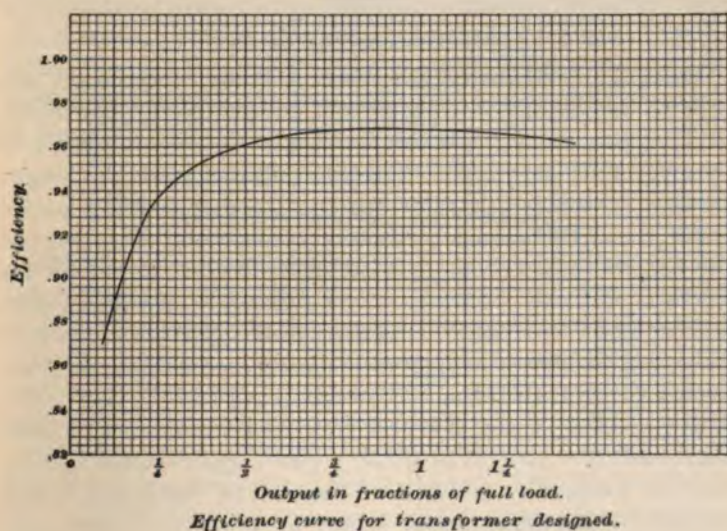

FIG. 1673.

the losses will be very small at this load. The primary C^2R loss will be $(1.12)^2 \times 4.38 = 5.47$ watts. The

secondary C^2R loss will be $(20)^2 \times .0106 = 4.24$ watts. The core loss is 124 watts; hence the total loss will be 133.7 watts. The input will then be 2,133.7 and the output 2,000, giving an efficiency at this load of 93.7%. The calculations and results for the other loads are given in Table 117.

4231. These values of the load and efficiency give the curve shown in Fig. 1673. The student should compare this curve with that shown in Fig. 1662. The scale used for the efficiency in Fig. 1673 is larger than that in Fig. 1662, in order to show the variation of efficiency more clearly, but it will be noticed that the curves have the same general characteristics. The variation in efficiency in this case is not more than 3% from $\frac{1}{2}$ load to 25% overload. It will be seen from the table that the efficiency begins to drop off when the transformer is overloaded, owing to the rapid increase of the C^2R losses.

ALL-DAY EFFICIENCY.

4232. The efficiency which actually determines the cost of operating the transformer is the all-day efficiency, or the ratio of the watts useful output per day to the watts supplied during the day. This will depend upon the length of time during the day that the transformer is doing useful work. For example, suppose the transformer were worked during the 24 hours an amount equivalent to full load for 6 hours, and that it remained idle an amount of time equivalent to 18 hours. The core losses would go on for the whole 24 hours, because the pressure is maintained across the lines, whether the transformer is working or not. The watt-hours wasted in the form of core losses in one day would therefore be $124 \times 24 = 2,976$. The copper losses during one day would be equivalent to the sum of the primary and secondary full-load copper losses for 6 hours. Hence the watt-hours energy wasted in C^2R losses per day will be $146.8 \times 6 = 880.8$. The useful energy delivered during the day is equivalent to full load for 6 hours, or $8,000 \times 6 = 48,000$

watt-hours. The energy which must be supplied during the day is $48,000 + 2,976 + 880.8 = 51,856.8$ watt-hours, and the all-day efficiency under these conditions is $\frac{48,000}{51,856.8} = .925$.

This means that of all the energy delivered to the transformer during 24 hours, 92.5% is converted into useful energy and the remainder wasted. If the transformer were loaded for a longer period during the day, the useful work done would be greater and the C^2R loss would also be greater. The core loss would remain the same as before, so that the all-day efficiency would depend upon the relation between the copper and iron losses. For example, suppose the transformer were fully loaded for 10 hours instead of 6. The useful work would be 80,000 watt-hours and the energy wasted in copper losses 1,468 watt-hours. The core loss would be 2,976 as before, and the total energy supplied would be 84,444, giving an all-day efficiency of about 94.7%. The condition of load for which any given transformer will give its maximum all-day efficiency depends, therefore, upon the relation between the copper and iron losses. It also follows that if the transformer is to be loaded for a short period only during the day, the iron losses should be small if the all-day efficiency is to be high.

MAGNETIZING CURRENT.

4233. The current which the primary of a transformer takes from the line when its secondary is on open circuit is usually spoken of as the magnetizing current, although, strictly speaking, it is the resultant of the magnetizing current proper and the current which represents the energy necessary to supply the core losses. It is important that this no-load current should be small, because if a large number of transformers are connected to the line, the sum of all the magnetizing currents required by the separate transformers may represent a considerable current to be supplied from the station. This means that the alternator may be delivering a fairly large current when no useful work is

being done. It is true that this current may not represent very much power, because it is considerably out of phase with the current, but it loads up the lines and alternator, and thus limits their useful current-carrying capacity. The no-load current is made up of two components, one of which is the magnetizing current, or the current which sets up the ampere-turns necessary to drive the flux around the core. The other component represents that current which is necessary to supply the core losses, and is in phase with the impressed E. M. F. The core loss in this case is 124 watts; hence this component of the no-load current will be $\frac{124}{1000} = .124$ ampere.

4234. The component of the no-load current which represents the current necessary to set up the magnetic flux may be obtained as follows: For a magnetic density of 30,000 lines per square inch, we will require about 5.5 ampere-turns per inch length of the circuit for a good quality of transformer iron. The mean path for the magnetic flux is shown by the dotted line, Fig. 1670, and the length of this circuit is about 60 inches. The ampere-turns required to set up the flux will then be $60 \times 5.5 = 330$. The number of primary turns surrounding the circuit is 2,040. We have then

$$\text{Magnetizing current} \times 2,040 = 330,$$

or $\text{current} = .162$ ampere.

The no-load current is therefore made up of the two components .062 and .162 at right angles to each other, and its value is

$$C_m = \sqrt{.062^2 + .162^2} = .17 \text{ ampere.}$$

This is the current which the transformer will take from the line when it is operating under no load. This does not mean, however, that it is consuming $.17 \times 2,000$ or 340 watts, because the no-load current is always considerably out of phase with the E. M. F., and, as a matter of fact, the transformer consumes only sufficient power to make up for the core losses and the slight loss in the primary due to the

no-load current. At no load the power factor may be considerably less than 1, but as the load is increased the current and E. M. F. shift into phase until the power factor at full load is very nearly unity.

REGULATION.

4235. The secondary voltage will fall off as the load is applied, and it is important that this falling off should be slight. In well-designed transformers the falling off in secondary voltage may vary from 1 to 2.5 or 3%, depending on the output. This drop is due to magnetic leakage and the resistance of the primary and secondary coils. In the type of transformer designed, the falling off due to magnetic leakage will be quite small, because the coils are wound one over the other, making the path between the coils, through which leakage is set up, long and of small cross-section. The leakage drop would not likely amount to more than .2 or .3 volt. The drop in the secondary coils at full load will be current \times resistance = $80 \times .106 = .85$ volt. The drop in the primary at full load due to the primary resistance will be $4.25 \times 4.38 = 18.6$ volts. This drop of 18.6 volts in the primary will cause a corresponding drop of $\frac{18.6}{20} = .93$ volt in the secondary, making a total drop due to resistance of $.93 + .85 = 1.78$ volts. The total drop due to leakage and resistance combined would therefore be under 2 volts, or 2% of the output, which is close enough regulation for all practical purposes.

CONSTRUCTION.

4236. The construction and arrangement of the core and coils will be understood by referring to Fig. 1674. This shows an elevation of the assembled transformer with a longitudinal section of the coils showing the windings and insulation. The core is built up out of thin iron strips, which are interleaved at the corners, so as to practically do away with joints in the magnetic circuit. The plates are

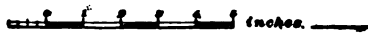
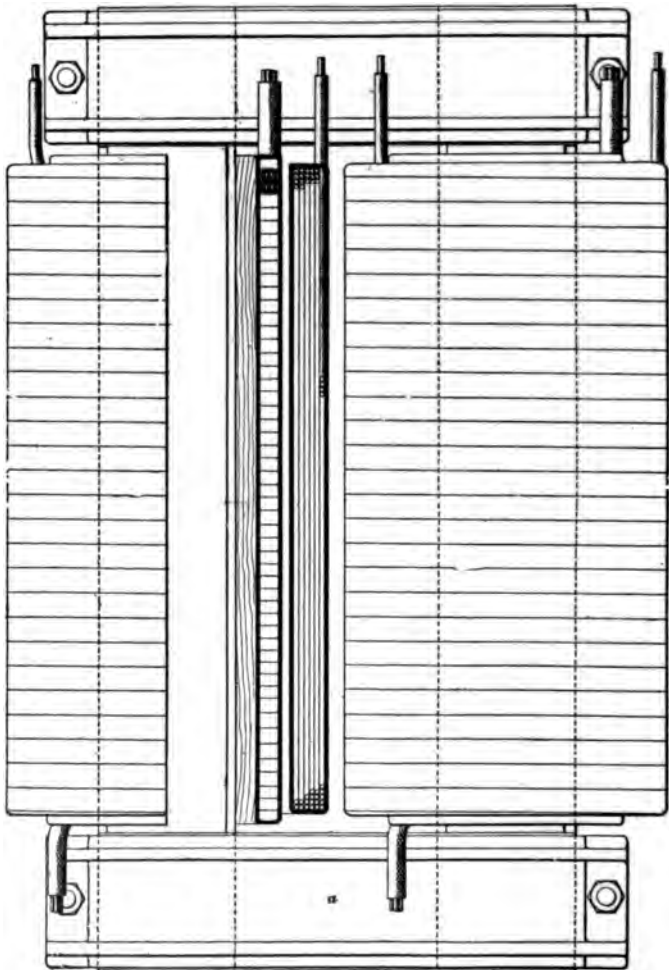
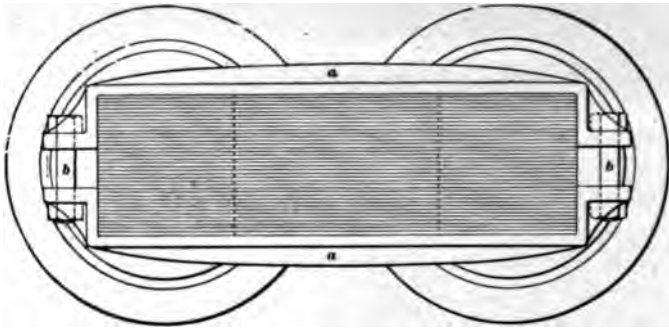

FIG. 1674.

shown held in position by clamps *a*, drawn up by bolts *b*, though some makers use bolts passing through the plates at the corners. It is best, however, to avoid bolts passing through the core if possible. The terminals of the coils should be very heavily insulated, and may be run to a connection board

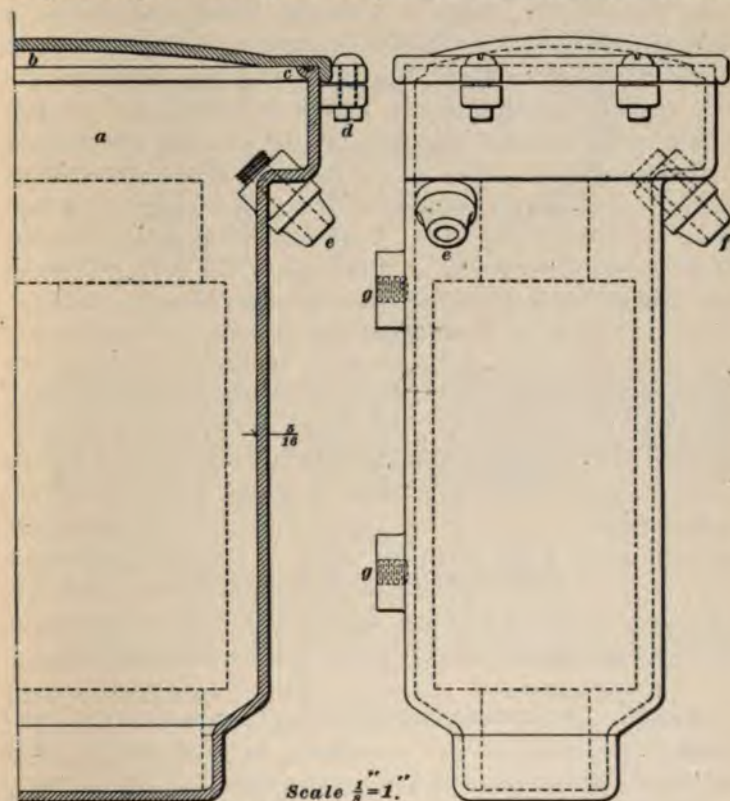

FIG. 1675.

of some kind within the transformer, or taken directly out through the case. Transformers in sizes up to 20 or 30 K. W. are usually placed in an iron case arranged for mounting on poles. These transformer cases should be weather-proof, and made as light as possible consistent with the necessary strength. They are generally designed with a view to being

filled with oil. Fig. 1675 shows a case suitable for the transformer designed. This is made of cast iron about $\frac{5}{16}$ or $\frac{1}{4}$ in. thick. The case a is provided with a cover b , which is bolted on by means of the bolts d . The overlapping flange and gasket c serve to make the cover water-tight. The transformer, which is shown by the dotted outline, is held in place either by wooden wedges or by set-screws, the latter being preferable. The primary terminals are brought out through the bushings e , and four bushings f are provided on the front of the case for the secondary terminals. The bushings should be of heavy hard rubber or porcelain, and so constructed that they will prevent leakage of current from the lines to the case. These outlets should, of course, be directed downwards, so that the wires may be looped into them, thus preventing water from getting into the case. Lugs g, g of some kind should be provided on the back of the case for attaching suspension hooks for hanging the transformer on the pole. Fuses are usually provided between the primary and the line, but these are generally mounted outside the transformer case in separate fuse boxes of special construction. Secondary fuses are not provided at the transformer, the fuses in connection with the secondary service wires being depended upon to protect the secondary circuit. For large indoor transformers, only sufficient covering is used to protect the coils, a regular case being unnecessary, as well as interfering with the ventilation.

4237. The transformer which has been worked out is one such as would be used on an ordinary lighting circuit. The method of designing a step-up transformer would be essentially the same, except that extra precautions would be taken to ensure very high insulation, and requiring a larger allowance of winding space. The design of a shell transformer may be also carried out in about the same way. The core proportions shown in Fig. 1676 may be taken as a starting-point. All dimensions are referred to the width of the tongue a , which carries the lines through the coils. The length of the core may be from 3 to 7 times a . The height

of the winding space is usually from 2 to 3 times a , and the breadth from .7 to .8 times a . The thickness of the outer part of the shell around the coils is necessarily $\frac{1}{2}a$, because

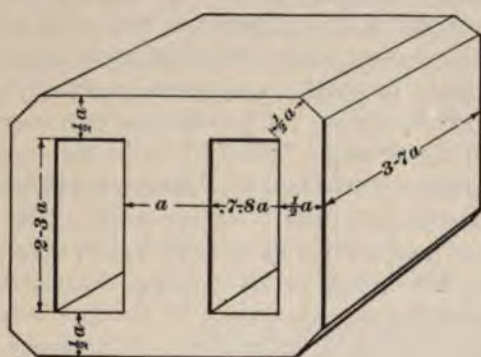

FIG. 1676.

this part of the core carries one-half the flux passing through the coils. In this type of transformer, the allowance of copper will usually be somewhat less than in the core type, because the winding space is more restricted.

INDUCTION MOTORS.

4238. In many respects the action of an induction motor resembles that of a transformer, and consequently parts of its design can be carried out by methods similar to those used in designing transformers. The primary of the induction motor, that is, the part into which currents are led from the line, corresponds to the primary coil of the transformer, while the secondary, or the part in which the currents are induced, corresponds to the secondary coil of the transformer. This relation holds, whether the primary or secondary of the induction motor is the revolving part; but in all that follows we will consider the primary as being fixed and the secondary as revolving. In such an arrangement, the fixed primary is commonly spoken of as the **field**, or **stator**, while the secondary is spoken of as the **armature**,

or **rotor**. Either the primary or secondary may be the revolving member, but the stationary primary with revolving secondary is the more common arrangement. The iron part on which the primary and secondary conductors are arranged performs a duty similar to that of a transformer core, that is, it serves to carry the flux set up by the primary coils through the secondary, and thus causes an E. M. F. to be set up in the secondary. The essential difference between an induction motor and a transformer is that in the latter case the secondary core and windings are fixed as regards the primary, and the E. M. F. generated in the secondary is made use of to supply useful electrical energy to an outside circuit; while in the former case the secondary core and windings revolve with regard to the primary, and the mechanical torque action between the primary and secondary is made use of to deliver mechanical energy. The currents generated in the secondary are not led into an outside circuit, but flow within the secondary itself, in order that they may react on the field produced by the primary, and so cause the armature or secondary to exert the required effort at the pulley. A transformer supplied with a constant primary pressure will furnish a nearly constant secondary pressure independently of the load; an induction motor when supplied with a constant primary pressure will run at nearly constant speed independently of the load.

LIMITATION OF OUTPUT.

4239. The output of induction motors, like that of alternators and transformers, is limited principally by the heating effect due to the various losses which occur in the motor when it is loaded. The principal loss is that due to the resistance of the primary and secondary conductors, although the hysteresis and eddy-current losses may also be considerable if the motor is not properly designed. If an induction motor be overloaded considerably, the armature currents

react excessively on the field, causing excessive magnetic leakage along the air-gap, and greatly lessening the torque between the field and armature. If the overload is sufficiently great, the torque will be reduced to such an extent that the motor will stop. Usually, however, an induction motor may be loaded for short periods beyond its full-load capacity without danger of overheating or stopping.

PRIMARY CORE LOSSES, MAGNETIC DENSITIES, ETC.

4240. The losses in the primary are made up of the core loss due to hysteresis and eddy currents, and the copper loss due to the resistance of the primary winding. The frequency of the changes in the magnetism of the primary is the same as the frequency of the current magnetizing it; hence the lower the frequency at which the motor is operated, the higher the allowable value of the magnetic density in the primary core. The core densities used for such motors should, on the whole, therefore, be about the same as the core densities used for

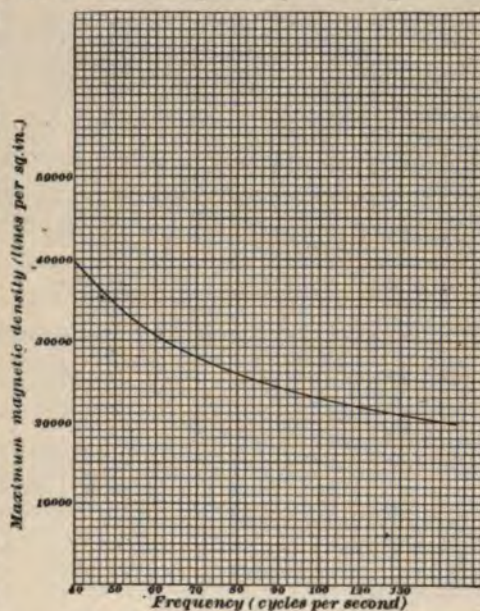

FIG. 1677.

transformers operating at the same frequency. The curve, Fig. 1677, shows the relation between the maximum value of the density and the frequency, based on values given

by Kolben. The densities, on the whole, are low, and lie between 40,000 and 20,000 lines per square inch throughout the range of frequencies commonly met with in practice. This curve gives the density in the core proper; the density in the teeth of the primary and secondary may be double these values without making the hysteresis loss very large, the volume of the teeth being small. Motors are also commonly built in which the magnetic density will be found less than that given by the curve, but the values shown should not, as a rule, be exceeded. Induction motors, like alternators, are generally built with several poles, so that the magnetic flux is subdivided. The required cross-section of iron in the yoke is, therefore, small, and a low magnetic density may be used without making the machine very heavy. The eddy-current loss in the primary, like that in transformer cores, can be kept down to a very small amount if thin disks are used and the core built up so that there is no electrical connection between them. The thickness of stampings used is about the same as for alternator armature cores, namely, from .012 in. to .018 in.

SECONDARY CORE LOSSES, MAGNETIC DENSITIES, ETC.

4241. The core losses in the secondary are usually quite small. This is due to the fact that the frequency of the reversals of magnetism in the secondary is low. If the armature were standing still, the slip between primary and secondary would be 100%, and the frequency of the magnetic cycles in the secondary would be the same as in the primary. When, however, the motor is running under normal conditions, the slip may not be more than from 2 to 5%. The frequency of the magnetic cycles in the armature will therefore be only from 2 to 5% of the frequency in the field, and the core losses will therefore be correspondingly small. The armature iron is usually worked at about the same density as that in the field, the density in the teeth being about double that in the core proper.

INDUCTION-MOTOR WINDINGS.

PRIMARY WINDING.

4242. The winding on the primary must be so designed that it will generate a counter E. M. F. equal and opposite to that of the mains, neglecting the small drop due to the resistance of the coils. It is therefore determined in a manner similar to that used for the calculation of the primary winding for a transformer. In some of the earlier forms of induction motors the coils were wound on salient poles, as shown in Figs. 1569 and 1570, Theory of Alternating-Current Apparatus, but in modern machines they are placed in slots in the same way as windings for alternator armatures. Most induction motors are of the two or three phase type, and the field winding of such machines is carried out in the same way as the winding for the armature of a two or three phase alternator. The primary winding may be concentrated or distributed, the latter arrangement being most generally used for machines operating at moderate pressures. We may then use formula **670** to show the relation between the pressure, turns, flux, and frequency. We may write, then, for induction-motor windings

$$\bar{E} = \frac{4.44 N T n}{10^8} \times k, \quad (701.)$$

where

- \bar{E} = E. M. F. generated by or impressed on each phase;
- T = number of turns connected in series per phase;
- N = maximum total magnetic flux from one pole;
- n = frequency (cycles per second);
- k = a constant depending on the style of winding used.

For a concentrated winding, that is, one with one group of conductors per pole-piece per phase, $k = 1$. For a uniformly distributed two-phase winding, $k = .90$. For a uniformly distributed three-phase winding, $k = .95$. (See Art. **4090**.) If the winding is only partially distributed, the value of k will lie between the values given above and 1.

It will be noticed that for a given value of the flux, frequency, and number of volts applied, the number of turns required for a distributed winding is but slightly less than that required for a concentrated winding, the difference being about 10% for a two-phase motor and 5% for a three phase. The distributed windings are preferred, because with them there is less magnetic leakage between the primary and secondary, and the action of the motor is also more uniform. Generally, the primary slots occupy about one-half the circumference of the primary core, as this arrangement allows a fair amount of space for the windings without forcing the density in the teeth too high.

4243. The cross-section of the conductor used for the primary winding is determined by the full-load current which the motor takes in each phase. The relation of this current to the full-load current taken from the mains will, of course, depend upon the way in which the different phases are connected up. At least 600 circular mils per ampere should be allowed in the primary conductor. The primary is usually stationary, and can not, therefore, radiate its heat as readily as if it were revolving. For this reason, the current density should be kept as low as possible without making the space occupied by the windings too large. Induction-motor fields usually present quite a large radiating surface, and are, moreover, generally supplied with air-ducts, a draft through which is caused by the armature. If it were not for this, the allowance per ampere would have to be considerably more, but usually the allowance is between 600 and 800.

4244. The primary winding may be made up of bars or coils, depending upon the voltage at which the machine is to operate, coils being used on most machines of moderate size. These are arranged in the same way as has already been described for two and three phase armatures, and what has been said as regards the insulation, etc., of such armatures applies also to induction-motor primaries. The primary winding is very often arranged in two layers, coils of the shape shown in Fig. 1608 being used.

SECONDARY WINDING.

4245. The number of conductors used for the secondary winding is largely a matter of choice. The motor may be built with any ratio of transformation, that is, with any ratio of primary to secondary conductors, and work well. It is desirable, however, to make the resistance of the secondary low, and to get as large a cross-section of copper as possible into the slots. For this reason, it is usual to provide the secondary with only one or two bars to each slot, the space taken up by insulation being thus reduced to a minimum. The bars used are generally rectangular in section, though in some machines round bars have been used.

4246. The secondary conductors are in many cases grouped into a regular two or three phase bar winding similar to that shown in Fig. 1594, the winding generally being in two layers. It is necessary to use a wound secondary of this kind when it is desired to insert resistance in series with the secondary, either for the purpose of securing a good starting torque or regulating the speed. When this is done, the winding is connected up according to the Y method, and the three terminals brought to collector rings, as shown in Fig. 1678.

The three phases p_1 , p_2 , and p_3 are thus connected to the three resistances r_1 , r_2 , and r_3 , as shown. When the motor is being started, the phases are connected to the points a , b , and c , and the resistance is

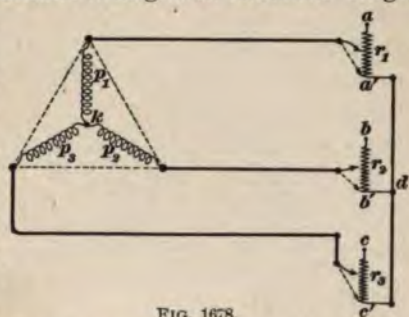

FIG. 1678.

gradually cut out as the motor runs up to speed. When the resistance is all cut out, the phases are practically short-circuited, as shown by the dotted lines. In case the resistance is used for starting only, and not for regulating the speed, the resistances may be mounted within the armature spider and cut out by a special switch, thus avoiding

the use of collector rings. In all cases, however, where it is desired to regulate the speed by the insertion of resistance in the secondary circuit, collector rings are necessary.

4247. When it is not desired to insert resistance in the secondary circuit, a plain squirrel-cage winding may be used, such as is shown in Fig. 1571, of the section on Theory of Alternating-Current Apparatus. There is in this case only one bar in each slot, all of them being connected by copper short-circuiting rings at each end of the armature. In starting up a motor with a squirrel-cage secondary, the primary voltage should be cut down by means of resistance or otherwise, so as to prevent a heavy rush of current. The insertion of resistance in the primary has the effect of cutting down the starting torque, so that in cases where a very strong starting torque is desired, it is best to insert the resistance in the secondary. The squirrel-cage construction gives a durable and efficient armature, because the winding is extremely simple, and the end connections between the bars are of very low resistance. Since the voltage generated in an induction-motor secondary is very low, the insulation between the bars and core need not be very heavy, as the danger of burn-outs is almost nil and short-circuits do not count for anything, because the bars are short-circuited anyway by the end connecting rings. Usually the number of slots in the secondary is different from the number in the primary, though this is not absolutely necessary. The use of a different number of slots tends to avoid any dead points at starting, and prevents the motor from acting merely as a static transformer with a short-circuited secondary. The lower the resistance of the secondary, the lower will be the voltage which must be generated in it to set up a given current. The voltage generated depends upon the slip between the armature and field; consequently for a given load and corresponding secondary current, the slip will be smaller the lower the armature resistance, other things being equal. It follows, therefore, that machines with low-resistance armatures will

give better speed regulation than those in which the armature resistance is high. This corresponds to the action of continuous-current motors; the lower the armature resistance of a shunt-wound motor, the better will be its speed regulation.

POWER FACTOR.

4248. It is important that the power factor of an induction motor be high, otherwise it will take an excessive amount of current for a given amount of power delivered, on account of the angle of lag between the current and E. M. F. In order that the power factor may be high when the motor is loaded, the magnetic leakage and consequent inductance must be kept low. This may be done by using a small air-gap, subdivided windings, and slots which are partially opened at the top. The power factor of a motor at full load will depend somewhat upon its size; motors from 10 to 20 H. P. should have a full-load power factor of about .85.

LENGTH OF AIR-GAP.

4249. The current necessary to set up the magnetic flux through the field will be largely dependent upon the length of air-gap between the primary and secondary, because this constitutes by far the greater part of the reluctance of the magnetic circuit. In a transformer it is not necessary to have any air-gap in the magnetic circuit, hence the magnetizing current can be made quite small. In an induction motor, however, an air-gap is unavoidable, and all that can be done is to reduce this to the smallest possible amount. The air-gap between the field and armature of induction motors is therefore made as small as the necessary mechanical clearance will permit. For small motors the single air-gap may not be more than $\frac{1}{32}$ in. For larger machines it would be somewhat greater than this, on account of the difficulty of centering large armatures exactly, and to prevent the armature touching the field in case the bearings should wear slightly. The air-gap in machines from 10 H. P. up to 50 H. P. may be from $\frac{1}{16}$ in. to $\frac{3}{8}$ in.

DESIGN OF 10 H. P. MOTOR.

4250. In order to illustrate the design of a simple induction motor, we will take an example and make the calculations required for the windings and core. Many of the mechanical details are similar to those which have already been described for alternators, so that they need not be taken up in detail; those parts which differ materially will be described as the design is worked out. We will take for an example a 10-horsepower three-phase motor with stationary primary and revolving secondary. The primary will be provided with a distributed winding placed in slots, the secondary being provided with a squirrel-cage winding. We will suppose that the following quantities are given:

- Output at pulley, 10 horsepower;
- Line voltage, 220 volts;
- Frequency, 60 cycles per second;
- Power factor at full load, .85;
- Commercial efficiency at full load about 85%.

FULL-LOAD CURRENT IN PRIMARY.

4251. The output is to be 10 H. P. or $10 \times 746 = 7,460$ watts = W . The actual power to be delivered to the motor at full load will therefore be $\frac{7,460}{.85} = 8,776$ watts = W' .

The true watts delivered to the motor at full load is equal to the product of the volts and amperes into the power factor $\cos \Phi$, where Φ is the angle of lag between the current and E. M. F. We have then

$$\text{apparent watts} = \frac{\text{true watts}}{\cos \Phi}; \quad (702.)$$

$\cos \Phi = .85$ in this case; hence we have

$$\text{apparent watts} = \frac{8,776}{.85} = 10,324 = W''.$$

For a three-phase motor we have, by formula 652, Theory of Alternating-Current Apparatus,

$$W'' = \bar{C} \bar{E} \sqrt{3},$$

where \bar{E} is the voltage between the lines and \bar{C} the current in each line; hence,

$$10,324 = \bar{C} \times 220 \times \sqrt{3}.$$

$$\bar{C} = \frac{10,324}{220 \times \sqrt{3}} = 27.1 \text{ amperes, nearly.}$$

The full-load current in the line will therefore be 27.1 amperes, and the current in each phase will also be 27.1 amperes if we adopt a Y winding for the primary. If we used a Δ winding, the current in each phase would be $\frac{27.1}{\sqrt{3}} = 15.7$ amperes, nearly.

4252. Since the current in each phase is comparatively small, we will use the Y method of connection for the primary winding. The current in the primary conductor will therefore be 27.1 amperes. Allowing 650 circular mils per ampere, we get

$$27.1 \times 650 = 17,615 \text{ circular mils.}$$

This is the approximate cross-section of conductor required. A No. 8 B. & S. wire has a cross-section of 16,510 circular mils, so we will use it for the winding. The insulated diameter of this wire will be about .144 in.

PERIPHERAL SPEED AND DIAMETER OF ARMATURE.

4253. If the speed of rotation and the frequency are fixed, the number of poles for which the field must be wound is at once determined; or, if the number of poles and frequency be fixed, the speed of rotation at no load at once follows, because at no load the speed of the armature is almost exactly equal to that of the revolving field, the slip being very small. If we wind the field so as to have 6 poles, the speed at no load will be very nearly $s = \frac{\text{frequency}}{\text{pairs of poles}} = \frac{30}{3} = 20$ revolutions per second, or 1,200 revolutions per minute. If the field were wound for 8 poles, the speed would be 900 revolutions per minute. As this motor is not of very large

size, 1,200 revolutions per minute will be a fair speed for it. If we used the 8-pole arrangement, we would obtain a lower speed, but the motor would be larger and more expensive, we will therefore adopt the 6-pole, 1,200-revolution arrangement. As the output of induction motors is increased, it is usual to increase the number of poles also, so as to lower the speed.

4254. Induction motors are run at moderately high peripheral speeds, usually lying between 3,000 and 5,000 feet per minute. For a motor of the size under consideration, 4,000 feet per minute will be a fair value. The outside diameter of the armature will therefore be

$$d_a = \frac{\text{peripheral speed} \times 12}{\text{R. P. M.} \times \pi} = \frac{4,000 \times 12}{1,200 \times \pi} = 12.7 \text{ in.}$$

(See Art. 4127.)

We will therefore adopt $12\frac{3}{4}$ in. as the outside diameter of the armature. The circumference of the armature will be about 40 in. The inside diameter of the field will be equal to the outside diameter of the armature plus the air-gap required for mechanical clearance. For an armature of this diameter $\frac{3}{8}$ in. on each side should be sufficient, so that the inside diameter of the field will be $12.75 + \frac{3}{4} = 12\frac{3}{4}$ in. The inside circumference of the field will be about 40.3 in.

PRIMARY WINDING.

4255. We will use a primary winding which is subdivided. If the winding is subdivided to a large extent, a large number of slots will be required to accommodate it. It is usually sufficient, however, for motors ranging from 10 to 100 H. P. to use from 2 to 4 coils per pole per phase, and for the present case we will take 3 coils per pole per phase as a trial arrangement. The winding will be arranged in two layers; hence there will be as many slots as coils. The number of slots will therefore be

$$3 \times 6 \times 3 = 54$$

We will make the space along the circumference occupied by the teeth and slots about equal, so that the approximate width of the primary slot will be

$$\frac{40.3}{2 \times 54} = .373 \text{ in.}$$

If we place 2 No. 8 wires side by side in the slot, they will take up $2 \times .144 = .288$ in., and if the slot were made, say, $\frac{3}{8}$ in. (.375) wide, we would have 87 mils left for insulation, or $43\frac{1}{2}$ mils on each side. This amount of insulation would be rather light for a 220-volt machine, so we will increase the width of the slot by $\frac{1}{32}$ in., making it .406, or $\frac{13}{32}$ in. wide. This will allow 65 mils on each side for insulation, which should be quite sufficient for a 220-volt machine. The total space taken up around the circumference will then be $54 \times .406 = 21.92$ in., leaving 18.38 in. to be occupied by the teeth at the circumference. The circumferential width of the tooth will therefore be $\frac{18.38}{54} = .34$ in., nearly. The actual width of the tooth at the circumference may be made a little wider than this, so long as sufficient room is left between the teeth to slip in the coils. The width of the slot and tooth at the circumference will be as shown in Fig. 1679.

4256. We must now make a trial selection for the number of conductors to be placed in a slot. The depth of the slots in the primary is usually from 2 to 3 times their width. It is not well to make them much deeper than this, as it removes the bottom conductors too far from the surface of the field. We will try an arrangement of 6 turns per coil, or 12 conductors per slot. The slot will then be arranged as shown in Fig. 1679, the conductors being insulated by taping around the coil, as well as by the trough in

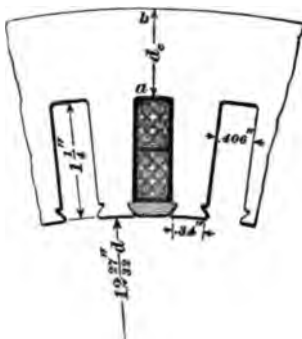

FIG. 1679.

the slot. Allowing $\frac{1}{8}$ in. for the space taken up by the wedge, we find that the total depth of slot must be about $1\frac{1}{4}$ in., as shown in the figure.

MAGNETIC FLUX IN POLES.

4257. By the magnetic flux N is meant the total maximum number of lines which flow from one pole-piece. The pole-pieces of an induction motor are not sharply defined like those of an alternator field, but gradually merge from one into the other.

Fig. 1680 will help to convey an idea as to the way in which the flux is distributed around the face of an induction-motor field. The inner circle represents the face of the field,

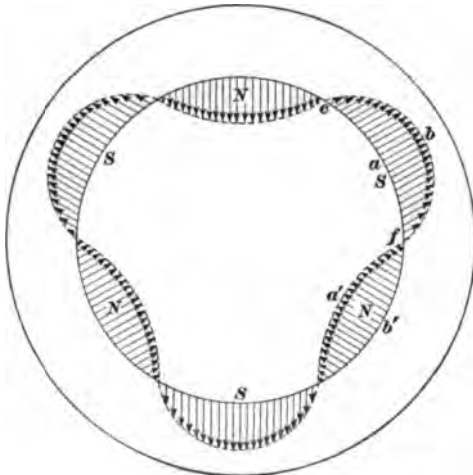

FIG. 1680.

which for the present will be considered as unbroken by slots.

If a current be sent through the windings, six poles will be formed, as shown, and these poles will be continually shifting around the ring.

We will consider the instant when the centers of the poles are at the points marked N, S . The magnetic density is greatest

opposite the center

of the pole, and may be represented by the arrow $a b$ directed outwards from a south pole, or $a' b'$ directed inwards from a north pole. As we move towards either side of the center of a pole, the field intensity diminishes until it becomes zero at the point midway between the poles, and begins to increase again in the opposite direction. This variation in the magnetic density at the various points of the pole face is repre-

sented quite closely by a sine curve, and if the line ab represents the maximum value of the density, the average value of the density will be $ab \times \frac{2}{\pi}$ (av. value = max. value $\times \frac{2}{\pi}$).

Hence, if \mathbf{B} represents the maximum value of the density, $\mathbf{B} \times \frac{2}{\pi}$ will be the average density. Now the total flux N when at its maximum value is equal to the area of the pole face multiplied by the average value of the density; or

$$N = \text{arc } cf \times \text{length of field parallel to shaft} \times \mathbf{B} \times \frac{2}{\pi}. \quad (703.)$$

$$\text{The arc } cf = \frac{\pi \times \text{diameter of field}}{\text{number of poles}};$$

$$\text{hence, } N = \frac{\pi \times \text{diam. of field}}{\text{No. of poles}} \times \text{length of field} \times \mathbf{B} \times \frac{2}{\pi};$$

or we may write, for the length of field parallel to the shaft,

$$l = \frac{N \times 2p}{2 \times d_f \times \mathbf{B}}, \quad (704.)$$

where

N = the flux from one pole;

$2p$ = number of poles (p = No. of pairs of poles);

d_f = inside diameter of field;

\mathbf{B} = magnetic density in the air-gap (maximum).

Hence, from this formula we can obtain the length of the field parallel to the shaft when we know the value of N and have decided upon the air-gap density to be used. The other quantities in the equation are already known. We can obtain the value of the flux from the formula

$$\bar{E} = \frac{4.44 N T n}{10^8} \times k.$$

We will take $k = .95$, as the winding is nearly uniformly distributed. There are 18 coils in each phase, with 6 turns each, so that the number of turns T in series per phase is 108.

The voltage generated in each phase will be, neglecting the resistance drop, $\frac{220}{\sqrt{3}} = 127$ volts, because the armature is Y connected. We have then

$$127 = \frac{4.44 \times N \times 108 \times 60 \times .95}{10^8},$$

or
$$N = \frac{127 \times 10^8}{4.44 \times 108 \times 60 \times .95} = 464,700 \text{ lines.}$$

4258. The magnetic density in the air-gap should not be forced too high, or a large magnetizing current will be required to set up the flux. From 20,000 to 30,000 lines per square inch may be taken as fair values for the air-gap density. The density at the top of the teeth would of course be more than this. We will take 20,000 lines per square inch in this case. Applying formula **704**, we have for the length of the core parallel to the shaft, the field diameter being $4\frac{1}{4}$ in.,

$$l = \frac{464,700 \times 6 \times 32}{2 \times 411 \times 20,000} = 5.42 \text{ in.}$$

The length of the iron part parallel to the shaft should therefore be, say, $5\frac{7}{8}$ in., in order that the air-gap density shall not exceed 20,000 lines per square inch. The length of core over all will be somewhat greater than this, owing to the space taken up by insulation between the disks and air-ducts if the latter are used. We will allow $\frac{3}{8}$ in. for an air-duct in the center of the core, and $\frac{1}{2}$ in. for the space taken up by the insulation, thus making the spread of the laminations over all $6\frac{5}{8}$ in.

4259. All the dimensions of the primary have now been determined except the depth of the iron under the slots, that is, the dimension d_c , Fig. 1679. This must be made such that there shall be a sufficient cross-section of iron to keep the magnetic density down to the proper amount. Referring to the curve, Fig. 1677, we find that a fair value for the magnetic density in the iron of a 60-cycle motor is about 30,000 lines per square inch. The magnetic leakage

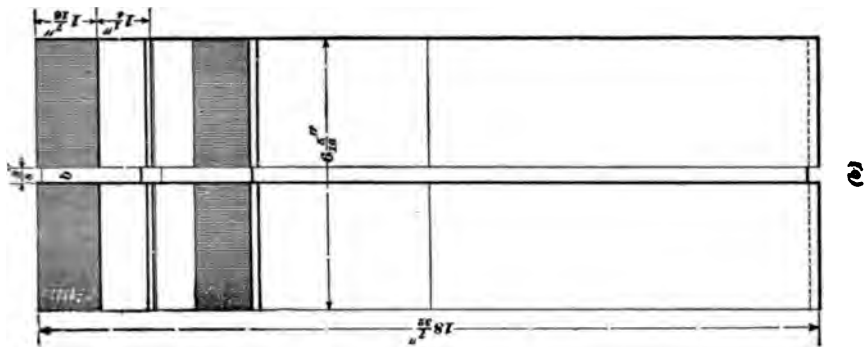

(c)

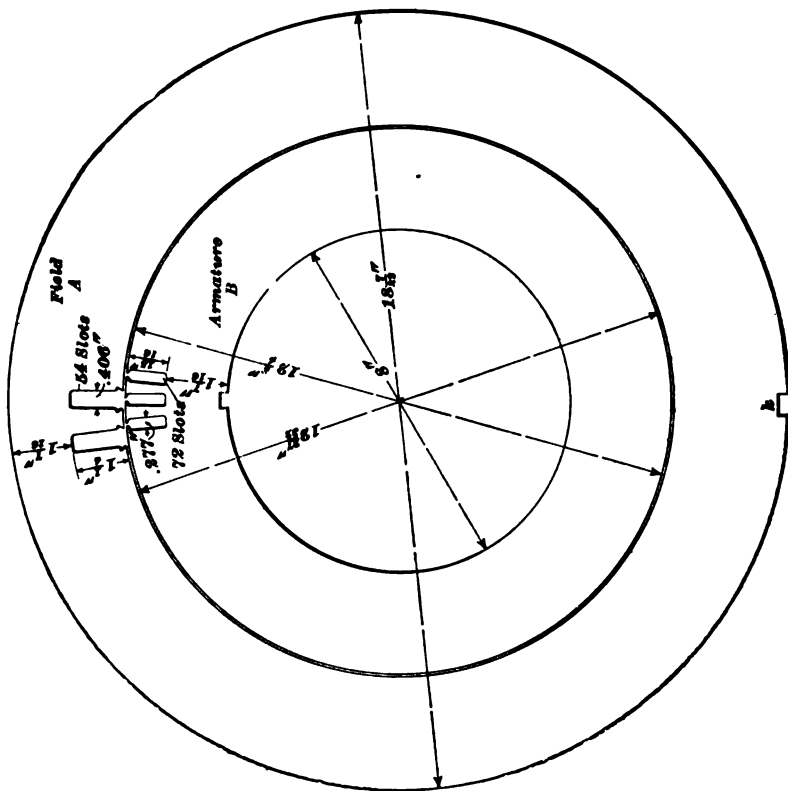

(a)

FIG. 1681.

in such a motor is very small, and we may take the flux in the field as practically the same as that in the air-gap. The flux through a cross-section of the yoke under the slots will be $\frac{1}{2}N$, because the flux from one pole will divide, one half flowing in one direction and the other half in the other direction. The area of cross-section of iron in the yoke will therefore be

$$A_v = \frac{\frac{1}{2}N}{B_v},$$

which gives $A_v = \frac{232,350}{30,000} = 7.73$ square inches.

The actual length of iron parallel to the shaft is $5\frac{7}{8}$ in.; hence the depth of iron under the slots must be

$$d_c = \frac{7.73}{5\frac{7}{8}} = 1.42 \text{ in.}$$

We will therefore make the dimension d_c , Fig. 1679, $1\frac{7}{8}$ in. The inside diameter is $12\frac{3}{4}$ in., and the depth of the slots $1\frac{1}{4}$ in., so that the outside diameter of the stampings for the primary will be

$$12\frac{3}{4} + 2 \times 1\frac{1}{4} + 2 \times 1\frac{7}{8} = 18\frac{7}{8} \text{ in.}$$

The complete dimensions of the primary are shown by (a), Fig. 1681. A section through one of the primary slots is given at (b), showing the air-duct b and a section of the laminations. The primary laminations are provided with a keyway k for holding the stampings in place and bringing the slots into line. There will be 54 slots of the dimensions shown in Fig. 1679, equally spaced around the inner periphery.

SECONDARY WINDING.

4260. The design of the secondary follows largely from that of the primary. The outside diameter is already known, and the length of the secondary core over all parallel to the shaft will be the same as the length of the primary, $6\frac{5}{8}$ in. We will provide the secondary with a squirrel-cage winding, although a secondary with a regular three phase Y winding

might be used if it were desired to insert resistance in series when starting. We will also use a different number of slots for the secondary, in order to avoid dead points when starting. We will take, say, 72 slots for the secondary winding, or 4 bars per pole per phase. This will give 24 bars to each phase, all the bars being connected in multiple by the short-circuiting rings at the ends of the armature.

CONDUCTORS AND CORE.

4261. The current in the secondary at full load will depend upon the primary current and the ratio of the primary and secondary turns. The secondary current will be given close enough for practical purposes by the following formula:

$$C_s = \frac{C_p r}{k}, \quad (705.)$$

where C_s = secondary current;

C_p = primary current;

r = ratio of primary to secondary conductors;

k = power factor.

We will assume the power factor k of the secondary to be .95, which will not be far from the truth, because the secondary inductance is low, and the power factor correspondingly high. In the case under consideration there are on the primary a total of 648 conductors, or 216 in each phase connected up in series. On the secondary there is a total of 72 conductors, or 24 to each phase, all connected in parallel; that is, 1 conductor in series. The primary current in each phase is 27.1 amperes. Hence the secondary current $C_s = \frac{27.1 \times 216}{.95} = 6,161$ amperes. To carry this current, we have 24 conductors in parallel; hence the current in each of the secondary bars will be about $\frac{6,161}{24} = 256.7$ amperes. This result might also be obtained by considering all the conductors. The current in each primary conductor is 27.1 amperes; hence the current in

each secondary conductor will be $\frac{27.1 \times 648}{.95 \times 72} = 256.7$ as before. The bars on the secondary must therefore be capable of carrying 256.7 amperes. A comparatively large cross-section per ampere may be allowed for these bars, because the number of bars is not very great, and only a small space is required for insulation. It is also desirable to have the secondary resistance as low as possible, as this tends to reduce the slip and make the motor give better speed regulation. We will therefore allow, say, 800 circular mils per ampere in the secondary bars. This gives for the cross-section

$$256.7 \times 800 = 205,360 \text{ circular mils.}$$

In order to get at the dimensions of the rectangular bar corresponding to this, we will have to reduce the area to square mils. One circular mil is equal to $\frac{\pi}{4}$ square mils; hence

$$\text{Area in sq. mils} = \frac{205,360 \times \pi}{4} = 161,200 \text{ sq. mils, nearly.}$$

4262. The circumference of the secondary is 40 in., and we will allow about one-half of this to be taken up by the slots. This makes the approximate width of the secondary slot $\frac{40}{2} = .277$ in. We will allow but 25 mils on each side for slot insulation, as this should be quite sufficient to stand the voltage generated. This will leave 227 mils space for the bar. We will therefore make the secondary bars 225 mils wide. The depth of bar required to give the cross-section of 161,200 square mils will be $\frac{161,200}{225} = 716$ mils. The corners of the bar will be rounded slightly, so we will make the bar, say, 750 mils or $\frac{3}{4}$ inch deep. The area will be slightly increased by so doing, but

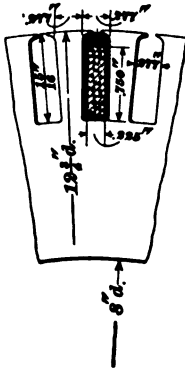

FIG. 1882.

this will be an advantage, as it will lower the secondary resistance a little. The bars for the secondary may be pushed into place from the end, so that we can make the slots nearly closed at the circumference. We will make the total depth of the slot $\frac{1}{8}$ inch, in order to allow room for the wooden strip. Fig. 1682 shows the dimensions of the secondary slot and bar.

4263. We will work the iron in the core of the secondary at about the same magnetic density as that in the primary, although, owing to the low frequency in the secondary, the density might be even considerably higher without causing any great amount of loss. The flux through the secondary will be practically the same as that through the primary, on account of the small amount of magnetic leakage. The length of iron parallel to the shaft is the same as for the primary, so we will make the depth of iron under the slots the same as before, namely, $1\frac{1}{8}$ in. The

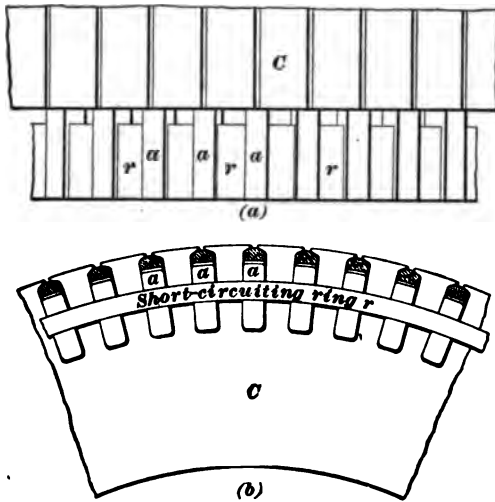

FIG. 1683.

inside diameter of the secondary will then be $12\frac{3}{4} - 2 \times \frac{1}{8} - 2 \times 1\frac{1}{8} = 8$ in. The complete dimensions of the secondary

core are given in Fig. 1681, there being 72 equally spaced slots of the dimensions shown in Fig. 1682.

4264. The end connections between the bars where they project from the core C will be made by means of the copper ring r , Fig. 1683 (*a*) and (*b*). This ring should be very thoroughly connected to the bars, because the current flowing through the junctions between the bars and ring is large, and local heating will result if the electrical connection is not well made. In large machines, the heavy armature bars are usually well bolted to the short-circuiting rings, but for a machine of small size, like the one under consideration, the bars a , a may be notched, as shown, and the ring r thoroughly sweated in.

HEAT LOSSES.

4265. The principal dimensions have now been determined, and it remains to be seen whether the motor will deliver its rated output without overheating. In order to do this, we will make an approximate estimate of the C^2R losses. The C^2R loss in the secondary may be determined approximately as follows: The cross-section of each armature bar as finally adopted will be about 214,900 circular mils. The bars should project a short distance out of the slots, so we will call the length of each bar about $8\frac{5}{16}$ in. The resistance of each bar will then be, by formula **682**,

$$R = \frac{L \times 11.5}{m} = \frac{8\frac{5}{16} \times 11.5}{12 \times 214,900} = .000037 \text{ ohm, nearly.}$$

NOTE.—The length L being here expressed in inches, it is necessary to divide by 12.

The C^2R loss in each bar will be

$$(256.7)^2 \times .000037,$$

and the total C^2R loss in the armature will be $(256.7)^2 \times .000037 \times 72 = 175$ watts. There will also be a certain amount of loss in the short-circuiting rings and at the

joints, but the total C^2R loss will probably not exceed 200 watts. The outside cylindrical surface of the armature is $40 \times 6\frac{1}{8} = 252.5$ square inches, which gives a surface of considerably over 1 square inch per watt C^2R loss. The core losses in the secondary will be very small, so that the secondary will carry its load without any danger of overheating.

4266. In order to estimate the C^2R loss in the primary at full load, we must first determine the length of a

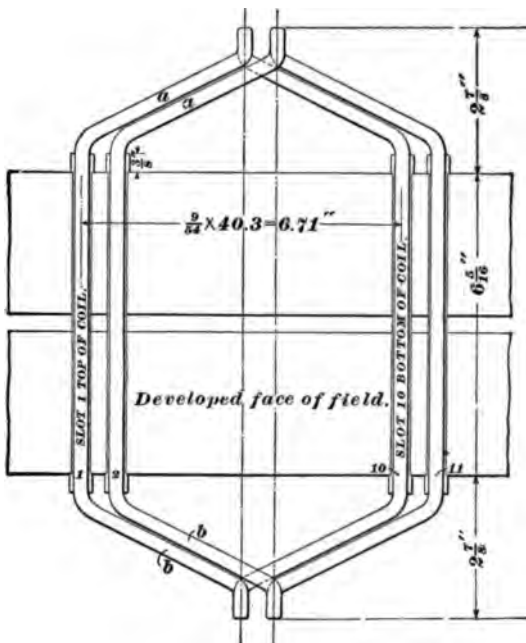

FIG. 1684.

primary turn. This involves a consideration of the primary winding. There are in all 54 coils and 54 slots, the coils being arranged in two layers. There are six poles, so that if one side of a coil lies in the top of slot No. 1, the other side will lie in the bottom of slot No. 10, as shown in

the winding diagram, Fig. 1685. The coil will then span over $\frac{3}{4}$ of the circumference of the field as shown in Fig. 1684. This figure represents two coils of the field winding in place, the inner face of the field being developed out flat. When the coils are in place, the ends *a, a* and *b, b* will project out past the core, forming a cylindrical winding. The ends of the coils are arranged on such a slant that they will fit in as shown without crowding. From this layout of the coils, the length of an average turn can be obtained, and in the present case it is found to be about 3 feet. There are 18 coils in series per phase and 6 turns per coil, making a total of 108 turns. The resistance per phase will therefore be

$$R = \frac{108 \times 3 \times 11.5}{16,510} = .22 \text{ ohm.}$$

The $C^2 R$ loss per phase will then be $(27.1)^2 \times .22 = 161.5$ watts, and the total $C^2 R$ loss in the field will be $161.5 \times 3 = 484.5$ watts. The exposed cylindrical surface of the field core alone is $18\frac{7}{8} \times \pi \times 6\frac{5}{8} = 361$ square inches. The surface exposed by the projecting windings will be approximately 200 square inches, so that there is an effective radiating surface of 561 square inches for getting rid of the heat developed in the primary, without counting the radiating surface which would be provided, to a certain extent, by the frame of the machine in contact with the field. The radiating surface as a whole, therefore, should be sufficient to get rid of the losses without an undue rise in temperature, especially as the hysteresis loss in the primary core would not be as large as the $C^2 R$ losses, the density being low and the volume of iron comparatively small.

FIELD WINDING AND CONNECTIONS.

4267. Fig. 1685 shows the arrangement of the primary or field winding, one phase being drawn in complete. The groups of conductors for the other two phases are indicated by the light and dotted lines, the connections between them

The ordinary ray, O , is the ray which is not doubly refracted. The extraordinary ray, E , is the ray which is doubly refracted. When the crystal is cut parallel to the optical axis, the ordinary ray will project any point on the surface of the crystal. The extraordinary ray will project an image which is an inverted and reversed image of the object. In this position, the extraordinary ray will project an image which is an inverted and reversed image of the object.

The extraordinary ray, E , is the ray which is doubly refracted. The ordinary ray, O , is the ray which is not doubly refracted. When the crystal is cut parallel to the optical axis, the ordinary ray will project any point on the surface of the crystal. The extraordinary ray will project an image which is an inverted and reversed image of the object. In this position, the extraordinary ray will project an image which is an inverted and reversed image of the object.

FIGURE 1. A diagram showing the paths of light rays through a crystal. The rays are labeled with numbers 31 through 46. The diagram illustrates the ordinary ray, O , and the extraordinary ray, E , and their respective paths through the crystal. The rays are shown as solid lines with arrows indicating their direction of travel. The extraordinary ray is shown as a dashed line with arrows indicating its direction of travel. The diagram also shows the crystal's surface and the paths of the rays as they exit the crystal.

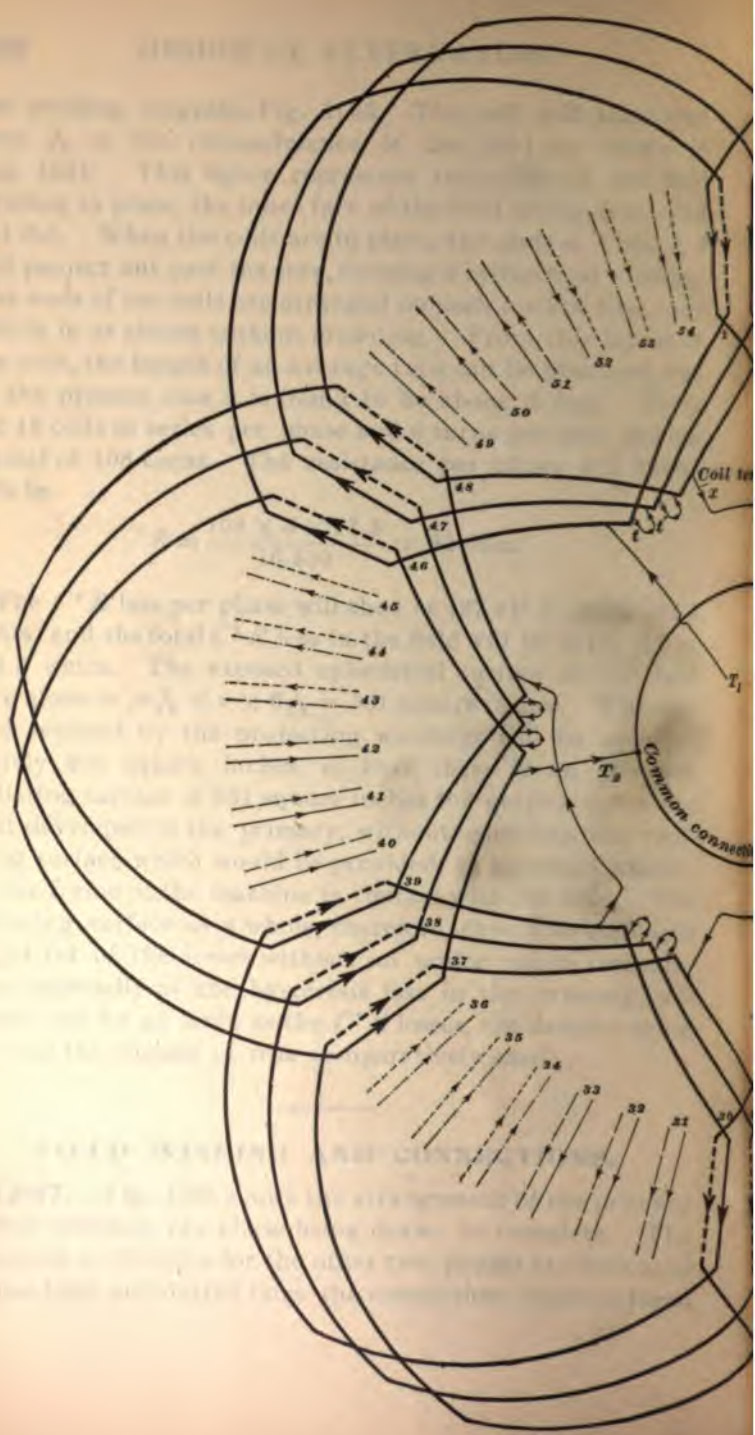

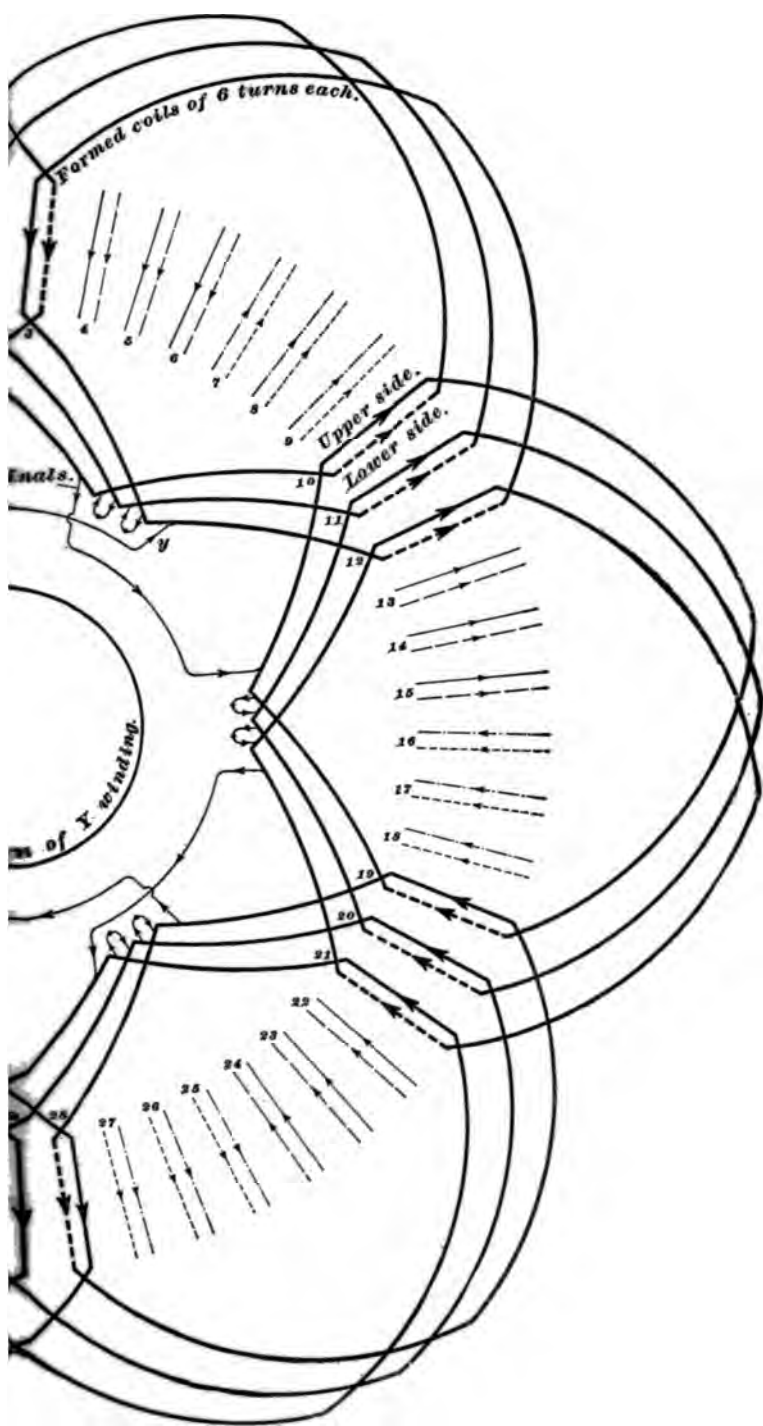

11

12

being made in the same way as those for the phase drawn in. The rules governing the connecting up of such a winding have already been explained in connection with polyphase-alternator armatures. Each of the heavy outlined figures represents a field coil of 6 turns; the lighter lines (two to each coil) projecting from the inner point of the coils represent the terminals of the coils. There are 54 slots, or 9 slots corresponding to each pole; hence the E. M. F.'s in all the conductors in the 9 slots under any one pole will be in the same direction, as shown by the arrow-heads. For example, the E. M. F.'s in the conductors in slots 7, 8, 9, 10, 11, 12, 13, 14, 15 will all be in one direction, say directed from the front to the back, while those in slots 16, 17, 18, 19, 20, 21, 22, 23, and 24 will have their E. M. F.'s in the opposite direction, corresponding to a pole of opposite polarity. The 18 coils shown belonging to one phase must all be connected in series, so that the E. M. F.'s in the conductors in the different slots belonging to this phase will be summed up. Suppose we start with the terminal T_1 ; we will pass 6 times around the coil, bridging from slot 46 to slot 1, in agreement with the arrow-heads, and come out at t ; we will connect t to t' and go 6 times around the next coil, finally coming to x and completing the connections of that group of 3 coils. We then pass on to the next group of 3 connecting x to y (so as to agree with the arrows), and so on around the field till the whole 18 coils are connected in series, finally coming to T_1 . We will connect T_1 to the common connection of the Y winding, T_1 being then one of the terminals of the motor which is connected to the line. The other two phases are connected up in exactly the same way, the connections between the terminals of the different phases and the common junction being made according to the rules given in the section on Theory of Alternating-Current Apparatus. This winding could also be connected up Δ , the only difference being in the connections of the phase terminals with each other and with the terminals of the machine.

MECHANICAL CONSTRUCTION.

ARMATURE.

4268. The armature core is built up in almost exactly the same way as cores for alternator or continuous-current armatures, the disks being mounted on a spider and clamped together by means of end flanges drawn up and held in place by cap-screws or bolts. If a wound secondary is used, it is customary to provide the spider with projecting flanges for supporting the winding, as already explained for alternator armatures with distributed windings. Where the squirrel-cage construction is used, no supports are necessary, the bars and short-circuiting ring being stiff enough to hold themselves in place.

SHAFT.

4269. Shafts for induction motors are usually made exceptionally heavy, considering the power which they have to transmit. They should, in general, be heavier than the shafts used for alternators of corresponding speed and output. The air-gap in induction motors is so small that a very stiff shaft is required, the slightest bending of the shaft being sufficient to either let the armature touch the field or bring very heavy magnetic pulls on the shaft, due to the shortening of the air-gap on one side and lengthening of it on the other. Generally the shafts for these motors are shorter than those required for alternators and continuous-current machines, because no room need generally be allowed for collector rings. Fig. 1686 shows the induction motor which has been worked out. This will give an idea as to the style of shaft used for such machines.

FIELD FRAME, BED-PLATE, ETC.

4270. The arrangement of the parts of an induction motor of this size will be understood by referring to Fig. 1686. In this case the field frame forms the main supporting casting of the machine, being provided with feet as

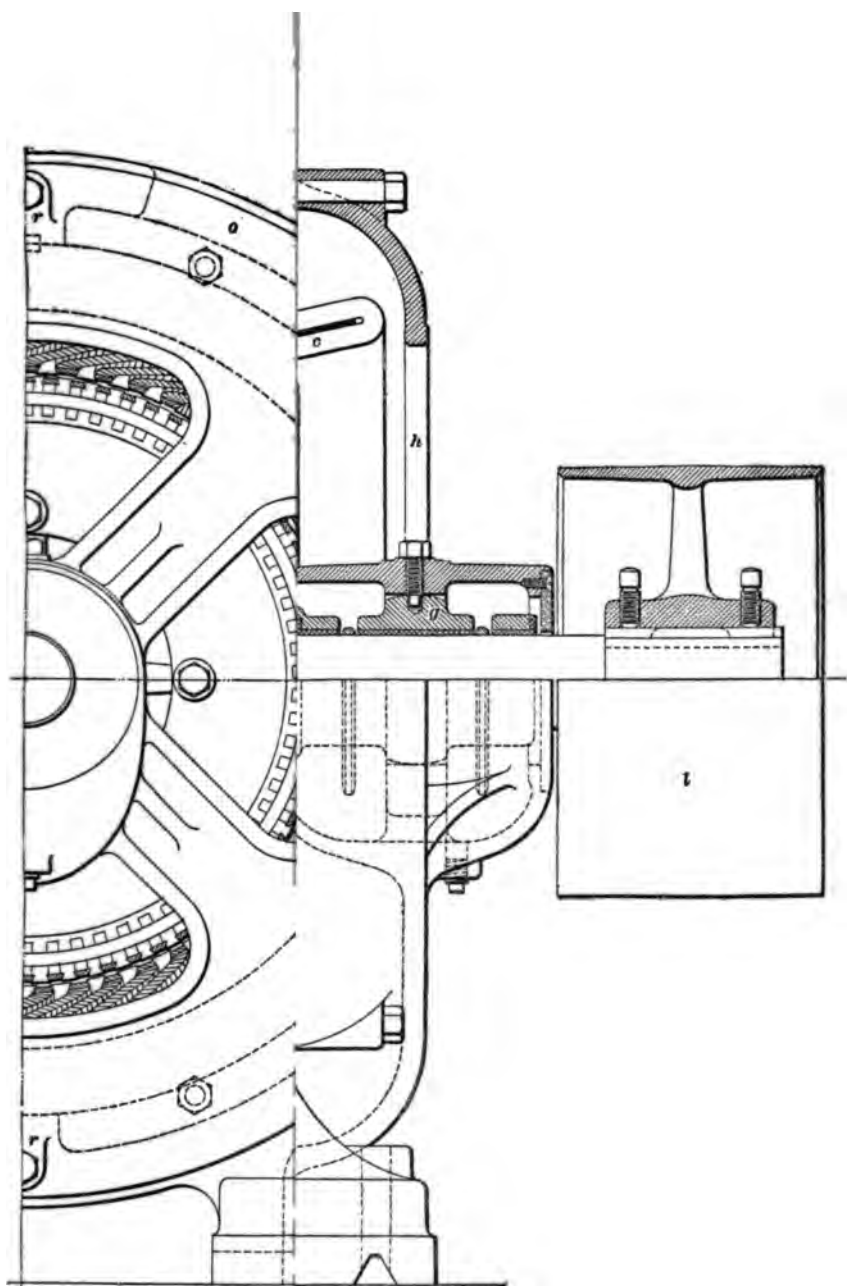



■

■

■

■

shown. It serves the double purpose of supporting the field stampings and forming a base for the machine. In some of the larger sizes of induction motors, the field frame is bolted to a separate bed in the same manner as shown for the field of the alternator. For machines of moderate size, the construction shown in Fig. 1686 answers quite well, and is cheaper than that which makes use of a separate bed. The

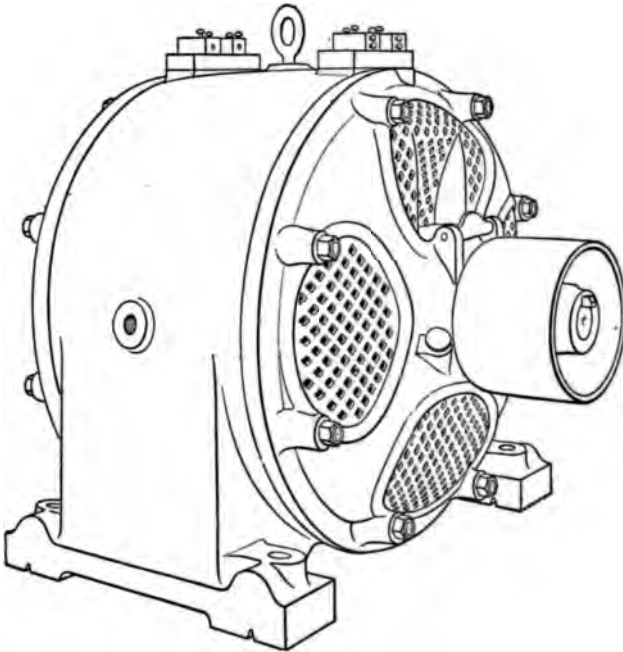

FIG. 1687.

self-oiling bearings are carried by the two end plates *h, h*, which are bolted to the field frame, as shown, and carry the bearings *g, g* and the shaft *f*, with pulley *l*. These end-bearing supports also serve to protect the field coils *c*. The conductors in the field slot are shown at *d, d*, and *b* is a section of the field laminations. The armature laminations *a* are supported by the spider *e* and held by the cap bolts and end flange as shown. The armature bar *s* is shown projecting

2896 ALTERNATING-CURRENT APPARATUS.

from the slot, the ends being slotted to receive the short-circuiting rings. The field frame k is provided with a number of ribs r , which are bored out to fit the outer circumference of the stampings. A number of openings o are cored in the frame to allow ventilation. The terminals of the field winding are led through the cored openings p, p to the terminals n , which are mounted on the slate terminal board m , from which the connections to the line are made. It will be seen that, on the whole, the construction of such a motor is very simple, there being no brushes, brush holders, collector rings, etc. Fig. 1687 shows a perspective view of an induction motor of the same general type as the one worked out. The cover on the bearing is to allow for inspection of the oil-rings while the motor is running, and some similar means may be provided for the machine just designed. The main mechanical features of Fig. 1687 will be understood by referring to Fig. 1686, so that further comment is unnecessary.

4271. Two-phase induction motors are designed in the same way as three-phase machines, the only essential difference being in the arrangement of the windings. The calculation of two-phase armature windings has already been described, and the calculations for a two-phase induction-motor field are made in the same way.

A SERIES
OF
QUESTIONS AND EXAMPLES
RELATING TO THE SUBJECTS
TREATED OF IN THIS VOLUME.

It will be noticed that the Examination Questions that follow have been divided into sections, which have been given the same numbers as the Instruction Papers to which they refer. No attempt should be made to answer any of the questions or to solve any of the examples until that portion of the text having the same section number as the section in which the questions or examples occur has been carefully studied.

1

DYNAMO-ELECTRIC MACHINE DESIGN.

(CONTINUOUS-CURRENT.)

(ARTS. 3541-3775.)

(1648) On what account is a high speed advisable for armatures, and what drawbacks does this present ?

(1649) What do you understand by *back ampere-turns* ?

(1650) Explain the term "volume of current."

(1651) What advantage is derived from making the density very high in the teeth of a slotted armature ?

(1652) In a 4-pole dynamo it is found that one of the complete magnetic circuits requires 4,800 ampere-turns. How many ampere-turns must be provided on each field spool ?

(1653) Why is it advisable to allow for slight end play in the armature shaft of a belt-driven dynamo ?

(1654) What are the chief factors which limit the output of a constant-potential dynamo ?

(1655) What is, in general, the peripheral speed adopted for armatures ?

(1656) Name the advantages or disadvantages attending the use of short spools for field-magnets.

(1657) How do you express the cross ampere-turns in terms of armature current and conductors ?

(1658) Why is it necessary, in general, to increase the length or density of the air-gap when increasing the capacity of an armature ?

(1659) Why is a constant-current dynamo designed with a weak field ?

(1660) (a) If the number of turns on a full magnet spool

For notice of copyright, see page immediately following the title page.

2920 DYNAMO-ELECTRIC MACHINE DESIGN.

of a shunt dynamo is decreased by 10 per cent., what will be the effect? (b) Will it be necessary to choose another size of wire, in order to still get the proper amount of ampere-turns? (c) Why?

(1661) In what way may an external characteristic of a dynamo prove useful?

(1662) What material is generally used for binding wires, and of what size wire are they usually made?

(1663) Why should webbed pulleys be used for small dynamos?

(1664) What is approximately the limiting temperature to which it is safe to subject an armature when in continual use?

(1665) What is the usual limit of winding depth on a field-magnet, and why is this limit necessary?

(1666) When the field of a dynamo is energized, and at the same time a current flows through the armature, what is the result on the lines of force of the field?

(1667) How is it that, when a heavy current necessitates a large angle of lead, the demagnetizing action of the back ampere-turns does not necessarily produce sparking at the brushes?

(1668) (a) What do you understand by armature ampere-turns? (b) Express their value in terms of armature conductors and current.

(1669) Under what conditions may the length of air-gap be equal to one-half the width of slot of a toothed armature?

(1670) (a) Is any question of efficiency involved in the choice of the number of turns of wire in shunt field spools? (b) If so, how?

(1671) Up to what limit, approximately, may a bipolar form of machine be economically built?

(1672) Why should one or both of the pedestals of a bipolar dynamo be removable?

(1673) How is overload to be considered when adopting the designs for a dynamo?

DYNAMO-ELECTRIC MACHINE DESIGN. 2921

(1674) What is, approximately, the percentage of loss in the field coils of a shunt dynamo?

(1675) (a) Do the cross ampere-turns affect the total strength of field? (b) Give reasons for your answer.

(1676) How would you determine the electrical efficiency of a dynamo?

(1677) What is the maximum volume of current which may be taken from (a) a drum armature? (b) a ring armature?

(1678) Name some of the special applications of smooth-core and slotted armatures.

(1679) How is a magnetization curve used in determining the series ampere-turns for a compound-wound dynamo?

(1680) Why is the insulation at the ends of commutator bars extended beyond the edges of the bars?

(1681) What amount of surface should be allowed on an armature per watt expended in heating?

(1682) In what part of the magnetic circuit is the magnetomotive force of the armature ampere-turns mostly expended?

(1683) (a) What result would follow if the magnetomotive force at one pole tip, due to the cross ampere-turns, should become as great as the magnetomotive force due to the field? (b) What should be the relation between the two values?

(1684) What amount of surface should be allowed on field spools per watt expended in heating?

(1685) What effect has a small winding volume for the field coils on the regulation of a dynamo?

(1686) What is the limiting potential difference to be allowed between succeeding commutator segments of a constant-potential dynamo?

(1687) What is the reason for the use of laminated pole-pieces?

(1688) State Esson's rule giving the rise in temperature of an armature for different conditions of load and speed.

2922 DYNAMO-ELECTRIC MACHINE DESIGN.

(1689) At what points are found the greatest magnetic differences of potential due to the armature ampere-turns?

(1690) What is the particular value of a high magnetic density in the core of a ring armature?

(1691) (a) What style of machine is preferable for use in electroplating? (b) Why?

(1692) What is the purpose of a shunt across the terminals of the series winding of a compound-wound dynamo?

(1693) Why is it not good practice to use single brushes on the commutator at each terminal?

(1694) (a) Would it be possible, under ordinary conditions, to dispense with the back ampere-turns of the armature? (b) Give reasons for your answer.

(1695) What densities of lines of force are used in (a) armature teeth? (b) armature cores? (c) yokes? (d) magnet cores?

(1696) What is the rule for determining the proportions between shunt and series windings for a compound-wound dynamo?

(1697) In the shunt fields of a certain dynamo the loss is 3 per cent. of the total output. A leakage coefficient of 1.25 was used in calculating the shunt winding. What percentage of the output is lost in leakage, assuming the above figures to be correct?

(1698) How do you express the maximum value of armature ampere-turns in terms of volume of current and of number of field-magnet poles?

(1699) On what account are copper-gauze brushes to be recommended for use with dynamos for lighting on incandescent circuits?

(1700) Give a useful formula for determining the rise in temperature of field spools when carrying current.

(1701) How do you explain the fact that the loss due to eddy currents in the pole-pieces is reduced in any given case by increasing the length of the air-gap?

DYNAMO-ELECTRIC MACHINE DESIGN. 2923

(1702) Explain how a sloping line drawn from the origin of a characteristic to any point on it will indicate graphically the amount of resistance in the circuit.

(1703) For what reason is a footstep of zinc provided for the Edison bipolar dynamo?

(1704) (a) In what way are the back ampere-turns of the armature neutralized? (b) How is their value determined?

(1705) What are the disadvantages of a slotted form of armature?

(1706) What do you understand by the critical resistance of an external circuit supplied with power from a dynamo?

(1707) Why must the proportion of field ampere-turns to cross ampere-turns be greater in the case of ring than of drum armatures?

(1708) What current densities may be used at the brush contact surfaces in the case of (a) copper brushes? (b) brass brushes? (c) carbon brushes?

(1709) (a) When the leading pole tip is weak, necessitating the short-circuited coil being brought close to the edge of the pole-piece, what effect may be expected? (b) Why?

(1710) To what is due the fall of the characteristic from the point of highest E. M. F. with increase of load?

(1711) A shunt-wound bipolar dynamo is to be designed, capable of furnishing 5 horsepower. Provide a slotted armature, allowing for this work 600 circular mils per ampere in armature conductors. Shunt winding will absorb about 3 per cent. of output. E. M. F. at terminals, 230 volts. Peripheral velocity of armature, 2,600 feet per minute. Determine size of armature and field frame, number of lines of force (using a leakage coefficient of 1.25), size of wire for armature and field coils, and number of turns of wire in each case.

MOTOR DESIGN.

(CONTINUOUS-CURRENT.)

(ARTS. 3776-3835.)

(1712) (a) What is meant by the counter E. M. F. of a motor? (b) If a 2-pole motor is running at a speed of 1,000 revolutions per minute and the magnetic flux is 3,000,000 lines, what will be the counter E. M. F. generated, the armature being provided with 400 conductors?

Ans. (b) 200 volts.

(1713) Explain why a shunt-wound motor will run at nearly constant speed when supplied from constant-potential lines, no matter what load the motor may be carrying.

(1714) (a) If a shunt motor is connected across 220-volt mains and its armature has a resistance of .05 ohm, what counter E. M. F. must it be generating when the current flowing through it is 100 amperes? (b) What current would flow if the armature were held from turning?

Ans. $\left\{ \begin{array}{l} (a) \text{ 215 volts.} \\ (b) \text{ 4,500 amperes.} \end{array} \right.$

(1715) Why are series motors better adapted for street-railway work than shunt motors?

(1716) *P*, Fig. 40, represents the pulley of a motor, to which is clamped a brake. The arm of the brake is 2 feet long. When the motor is taking a current of 25 amperes, the spring balance gives a reading of 10 pounds. The armature is provided with 300 conductors, and it takes a constant torque of 1 foot-pound to overcome friction. Calculate (a) the total flux from the field into the armature; (b) the average

For notice of copyright, see page immediately following the title page.

propelling force exerted on each conductor, supposing that $\frac{1}{3}$ of the conductors are under the poles at any given instant

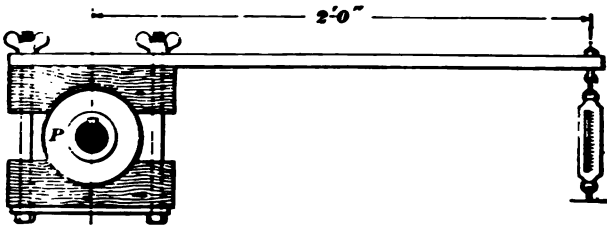

FIG. 40.

and that the diameter of the armature is 12 inches.

Ans. $\left. \begin{array}{l} (a) \text{ 2,393,100 lines, approx.} \\ (b) \text{ .21 lb.} \end{array} \right\}$

(1717) (a) What is meant by the commercial efficiency of a motor? (b) If a motor has a commercial efficiency of 85% and it delivers 10 H. P. at the pulley, what current will it take from 500-volt mains? Ans. (b) 17.55 amp.

(1718) (a) How does the speed of a series motor, operated from constant-potential mains, vary with the load? (b) Why is it not safe to throw the load completely off a series motor operated as above?

(1719) How does strengthening the field affect the speed of a motor under ordinary conditions?

(1720) If it were desired to design a shunt motor for an output of 20 H. P. when operated on 220 volts, at a speed of 800 R. P. M., explain how you would find the capacity (voltage, current, output, etc.) for the corresponding dynamo, and give the approximate values for the above quantities. Take field loss to be 3%.

Ans. $\left. \begin{array}{l} \text{Current, 79.44 amp.} \\ \text{Voltage, 208 at 800 R. P. M.} \end{array} \right\}$

(1721) (a) Describe two methods for regulating the speed of a shunt motor. (b) Which method is the more economical?

(1722) (a) Why is it necessary to insert a resistance in series with the armature of a motor when starting, in case

the motor is operated on constant-potential mains? (b) What would be the result if the current were switched on when the starting resistance was all cut out?

(1723) A motor armature is provided with 500 conductors and is placed in a field which covers 60% of the surface. The total magnetic flux is 2,500,000 lines. (a) What will be the total torque exerted when the current flowing is 20 amperes? (b) What will be the pull on each conductor if the diameter of the armature is 9 inches?

Ans. $\left\{ \begin{array}{l} (a) \text{ 29.25 ft.-lb.} \\ (b) \text{ .26 lb.} \end{array} \right.$

(1724) (a) What is wrong with the motor connections shown in Fig. 41, and show how you would correct them? (b) What would be the result if an attempt were made to start the motor under load with the connections as shown?

(1725) (a) What is meant by the efficiency of conversion of a motor? (b) If a motor generates a counter E. M. F. of 100 volts when the current flowing in the armature is 10 amperes and delivers 1 H. P. at the pulley, what is the value of the efficiency of conversion? Ans. (b) 74.6%.

(1726) Describe two methods of regulating the speed of a series motor operated from constant-potential mains.

(1727) How would you reverse the direction of rotation of a shunt motor?

(1728) How may a motor be wound to secure constant speed regulation? Show why this method secures the desired result.

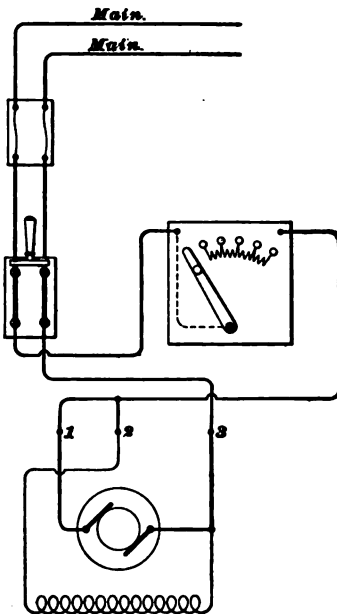

FIG. 41.

(1729) (a) How does the cross-magnetization of the armature affect the field of a motor? (b) What is the effect of this cross-magnetization as far as the non-sparking point of the brushes is concerned?

(1730) (a) What is the effect of the armature back ampere-turns on the field of a motor? (b) Why do the back ampere-turns tend to keep the speed constant in the case of a shunt motor?

(1731) It is desired to design a series motor for a full-load output of 30 H. P. at 800 R. P. M. The motor is to be operated on 500-volt constant-potential mains. What would be the current output and voltage of the corresponding dynamo which you would design for this purpose, and what would be its speed at full load?

(1732) Why is cast steel used almost exclusively for the construction of railway-motor field frames?

(1733) (a) Why is it necessary to have a regulating device to secure constant speed from a series motor operated on a constant-current arc-light circuit? (b) How does the voltage across the terminals of such a motor vary with the load?

(1734) Why are railway-motor armatures generally provided with two-path or series-connected windings?

(1735) How would you reverse the direction of rotation of a series motor?

(1736) Why is it essential in the design of a good motor to make the field strong and the armature reaction as weak as possible?

(1737) Show that the E. M. F. generated in the conductors of a motor armature is opposed to the current flowing through the armature.

(1738) What would happen if the field circuit of a shunt motor were broken while the motor was in operation?

(1739) Why do some shunt machines, which when run as dynamos give very poor regulation for constant potential, run fairly well as motors and give nearly constant speed?

(1740) Why should the field of a shunt motor be excited before current is allowed to flow through the armature ?

(1741) How would you cut out a constant-current motor from the circuit on which it is operating ?

(1742) Why should the switch arm of a starting rheostat never be left on an intermediate point ?

(1743) (a) What is meant by the electrical efficiency of a motor ? (b) If the armature has a high resistance, how are the speed and electrical efficiency affected ?

(1744) If the electrical efficiency of a motor is 90% and the efficiency of conversion is 85%, what is its commercial efficiency ? Ans. .765, or 76.5%.

(1745) (a) What is meant by the torque of a motor ? (b) Show that, for a given value of the current, the torque of a shunt motor is independent of the speed.

(1746) (a) What are the principal sources of loss in a motor ? (b) What limits the output of a motor ?

(1747) A motor *M*, Fig. 42, is running on 110-volt constant-potential mains. Suppose the switch *A* connecting the motor with the mains is opened so as to cut off the supply current, and immediately after the switch *B* is closed so as to short-circuit the motor. What will be the result ? Give reasons for your answer.

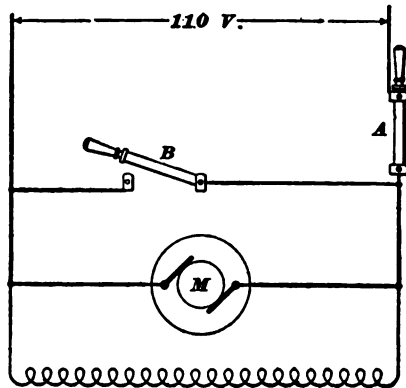

FIG. 42.

THEORY OF ALTERNATING-CURRENT APPARATUS.

(ARTS. 8836-4056.)

(1748) (a) Explain the difference between an alternating current and a direct current. (b) What is meant by the frequency of an alternating current?

(1749) (a) What is meant when it is said that two alternating currents differ in phase? (b) When are two currents in quadrature? (c) When are two currents in opposition?

(1750) (a) What is meant by the inductance of a coil or circuit? (b) Why is the inductance of a coil increased by surrounding it with iron?

(1751) (a) What is a transformer and for what is it used? (b) Can a transformer be used on a direct-current circuit, and if not, why? (c) Describe the essential parts of a transformer.

(1752) What is meant by a three-phase alternating-current system?

(1753) (a) What are rotary transformers? (b) Explain the principle of a simple two-phase two-pole rotary transformer, and draw a diagram showing the armature connections for the same.

(1754) Would it be possible to have a single-phase rotary transformer, with a single armature winding, supplied with alternating current at 50 volts, and have this transformed to continuous current at 100 volts? Give reasons for your answer.

(1755) (a) What is meant by the capacity of a line or circuit? (b) Define the unit of capacity. (c) If two

For notice of copyright, see page immediately following the title page.

capacities, one of 20 microfarads and the other of 10 microfarads, are connected in parallel, what is the combined capacity of the two?

(1756) A three-phase alternator has twelve poles. What must be the angular distance, in degrees, which the three sets of coils composing the armature winding must be displaced from each other? Ans. 20° .

(1757) (a) What is meant by the reactance of a circuit? (b) Does the reactance of a circuit change with changes in the frequency? (c) What unit is used to express reactance?

(1758) How do the pressures between the three lines of a three-phase system compare? In other words, would voltmeters connected across the three pairs of lines all read the same or not?

(1759) A transformer has two coils on its primary, each wound for 1,000 volts. It also has two coils on the secondary, each wound for 50 volts. Give a diagram showing how to connect up the primary so that it may be connected to 1,000-volt mains, and the secondary so that it will supply an E. M. F. suitable for 100-volt lamps.

(1760) (a) What is meant by the impedance of an alternating-current circuit, and how are the impressed E. M. F., current, and impedance related to each other? (b) What general form does Ohm's law assume for alternating-current circuits?

(1761) An alternator, frequency 60, is connected to a circuit having a negligible resistance and an inductance of .5 henry. Find the pressure which must be supplied by the alternator in order to cause a current of 5 amperes to flow in the circuit. Ans. 942 volts.

(1762) (a) Point out the difference between the Y and the Δ methods of connecting up three-phase armatures. (b) Is the output of a three-phase armature affected by changing its connections from Y to Δ or the reverse?

(1763) (a) Explain what is meant by the effective value of an alternating current. (b) If an alternating current

flowing through a resistance reaches a maximum value of 150 amperes during each alternation, what continuous current would develop the same amount of heat when sent through the same resistance? Ans. 106 amperes.

(1764) Three transformers having 400 turns on their primary coils are connected up Δ across 1,000-volt three-phase mains. Each transformer has 50 turns in its secondary coil, and the three secondaries are connected up Y. What will be the voltage between the secondary three-phase mains?

Ans. 216.5 volts.

(1765) (a) What is meant by the efficiency of a transformer? (b) A transformer is supplied with 1,800 watts and delivers a useful secondary output of 2.2 H. P.; what is its efficiency?

Ans. Efficiency = .912 or 91.2%.

(1766) Why is it not necessary to have any moving parts in a transformer for changing alternating current from one voltage to another?

(1767) (a) What is meant by the angle of lag? (b) How would you determine the angle of lag for a circuit if you knew the values of the resistance, inductance, and frequency?

(1768) An alternator giving 60 cycles per second is connected to a circuit having a resistance of 12 ohms and an inductance of .2 henry. (a) What current will flow in the circuit if the alternator maintains a pressure of 500 volts? (b) What will be the value of the angle of lag?

Ans. $\left\{ \begin{array}{l} (a) \text{ 6.55 amperes.} \\ (b) \text{ Angle of lag} = 80^\circ 57'. \end{array} \right.$

(1769) (a) What would the current have been in the last example if the circuit had a negligible amount of resistance? (b) What would the angle of lag be in this case?

Ans. $\left\{ \begin{array}{l} (a) \text{ Current} = 6.63 \text{ amperes.} \\ (b) \text{ Angle of lag} = 90^\circ. \end{array} \right.$

(1770) (a) How may an alternator be compounded? (b) Explain the use and action of the rectifier. (c) How many sections must the rectifier have compared with the number of poles on the machine?

(1771) (a) What is meant by non-inductive resistance? (b) Does the current lag behind the E. M. F. in flowing through such a resistance? If not, why? (c) Give examples of non-inductive resistances.

(1772) (a) Why are iron cores always used in transformers? (b) How would the magnetizing current be affected if the core were removed?

(1773) What is the relation between the frequency, speed, and number of poles of an alternator?

(1774) What would happen if a wattmeter were connected in a circuit with its current coil across the mains instead of in series with them?

(1775) If a single-phase alternator armature with as many coils as poles on the machine were to be connected up, how would the connections between the different coils be made in order that none of the E. M. F.'s induced in the different coils may neutralize each other?

(1776) In Fig. 43, *A* represents an alternator which is connected to a circuit *ab* having a non-inductive resistance

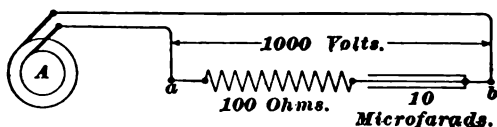

FIG. 43.

of 100 ohms connected in series with a condenser of 10 microfarads capacity. The alternator maintains a pressure of 1,000 volts at a frequency of 125 cycles per second. What will be the current which will flow in the circuit?

Ans. 6.17 amperes.

(1777) (a) If two transformers *A* and *B* were connected up with their secondaries in parallel, as shown in Fig. 44, what would be the result? (b) How could the trouble be remedied?

(1778) Suppose the current in one of the lines from a three-phase alternator is at its maximum value of 150 amperes at a particular instant. (a) What will be the value

of the currents in the other two lines at the same instant?
 (b) What will be the direction of these two currents as regards the current in the first line?

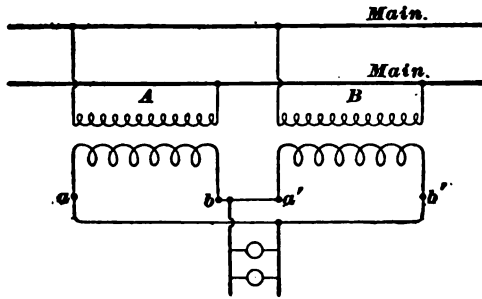

FIG. 44.

(1779) An alternator has 20 poles, and its armature runs at a speed of 300 R. P. M. (a) What will be the frequency?
 (b) How long will it take the current from such a machine to pass through one complete cycle?

Ans. $\left\{ \begin{array}{l} (a) \text{ 50 cycles per second.} \\ (b) \frac{1}{50} \text{ of a second.} \end{array} \right.$

(1780) If an alternator be connected to a circuit having a very small resistance and a large amount of inductance, what will be the phase relation of the current and E. M. F.?

(1781) Explain how the output of an alternator may be limited by high self-induction in its armature.

(1782) An alternator *A* is connected to a condenser *B*, as shown in Fig. 45, and it is found that a current of 2 amperes

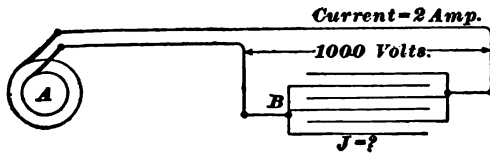

FIG. 45.

flows. The pressure maintained by the alternator is 1,000 volts and the frequency is 125. Find (a) the capacity of the condenser; (b) the power in watts necessary to maintain

the current. In this example the connecting wires are supposed to have a negligible amount of resistance.

$$\begin{aligned} \text{Ans. } X &= 2.54 \text{ microfarads.} \\ Z &= 0. \end{aligned}$$

(1773) (a) What is a synchronous motor? (b) Why will a single-phase synchronous motor not start of its own accord? (c) Why will such a motor continue running after it is first run up to the same frequency as the alternator driving it?

(1774) Suppose it were desired to design a reactance or choking coil to be connected in series with a lamp circuit for the purpose of dimming the lamps. This coil consists simply of a circular laminated iron core wound with wire sufficiently heavy to carry the current to operate the lamps. It is connected in series as shown in Fig. 46. The lamps L

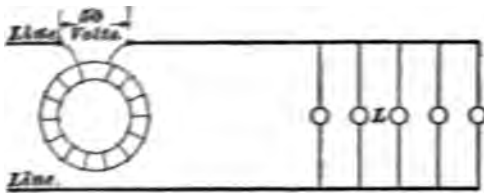

FIG. 46.

burn at full brilliancy when the pressure is 100 volts, and it is desired to design the coil to furnish a counter E. M. F. of 50 volts. The dimensions of the iron core are such that the magnetic flux is limited to 200,000 lines. The frequency is 125. How many turns must be wound on the core to produce the desired effect? Ans. 45 turns.

(1785) (a) What effect has the resistance of the primary and secondary coils of a transformer upon the efficiency? (b) What effect has the resistance upon the regulation?

(1786) (a) How would you define the henry? (b) What does it mean if it is stated that a coil of 50 turns has an inductance of 5 henrys?

(1787) Why are alternators with armatures having high self-inductance not liable to be damaged by short circuits?

(1788) What chief advantage have polyphase synchronous motors over single-phase motors of the same type?

(1789) What chief advantage have induction motors over polyphase synchronous motors?

(1790) Explain the essential parts of a polyphase induction motor.

(1791) An alternator A , Fig. 47, is connected to a circuit having a resistance $R = 150$ ohms, an inductance $L = .3$ henry, and a capacity $J = 15$ microfarads.

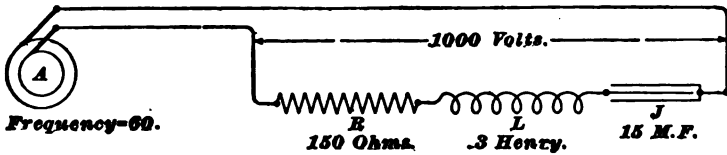

FIG. 47.

The alternator maintains a pressure of 1,000 volts across the circuit and the frequency is 60. (a) Required the current which will be set up by the impressed E. M. F. of 1,000 volts. (b) Determine whether this current is ahead of the E. M. F. or behind it, and by what amount. (c) Determine the watts expended in the circuit.

$$\text{Ans. } \left\{ \begin{array}{l} (a) \text{ 6.13 amperes.} \\ (b) \text{ Ahead by } 23^\circ 5'. \\ (c) \text{ 5,633 watts.} \end{array} \right.$$

(1792) (a) What is meant by the power factor of a system? (b) What is the largest value that the power factor can ever have?

(1793) (a) What is the best method of measuring the power expended in an alternating-current circuit? (b) Explain the instrument which you would use for this purpose, and (c) give a diagram showing how you would connect it up.

(1794) If a transformer were connected up with its primary across continuous-current mains, what would be the result?

(1795) Explain how the current is set up in the armature of an induction motor without the armature being connected in any way to an outside circuit.

(1796) If the secondary coil of a transformer becomes short-circuited accidentally by the terminals becoming connected, how will the current in the primary be affected?

(1797) How may the speed of an induction motor be regulated?

(1798) (a) What causes magnetic leakage in a transformer? (b) How does magnetic leakage affect the action of the transformer? (c) How may it be largely obviated?

(1799) (a) How does the current in the armature of an induction motor change as the load increases? (b) Explain the cause of the change in current.

(1800) What kind of winding would be suitable for the field of a three-phase induction motor?

(1801) If a synchronous motor be loaded too heavily, what will be the result?

(1802) An alternating current of 25 effective amperes is flowing through a circuit. (a) What is the highest value that the current reaches? (b) What is its average value?

Ans. $\begin{cases} (a) & 35.36 \text{ amperes.} \\ (b) & 22.52 \text{ amperes.} \end{cases}$

(1803) If an alternator furnishes an effective pressure of 2,000 volts, what is the highest pressure that the insulation on the armature has to stand?

Ans. 2,828 volts.

(1804) An alternator has 10 poles and runs at the rate of 1,500 R. P. M. Its armature is provided with 800 face conductors or 400 turns, all of which are connected in series. The flux through each pole face is 900,000 C. G. S. lines. (a) What will be the frequency? (b) What voltage will be obtained between the collector rings at no load?

Ans. $\begin{cases} (a) & 125 \text{ cycles per second.} \\ (b) & 1,998 \text{ volts.} \end{cases}$

(1805) If a condenser has a capacity of 20 microfarads, how long would an average current of .1 ampere have to flow into it to raise the pressure between its terminals to 1,000 volts?

Ans. $\frac{1}{3}$ second.

(1806) An induction motor is so wound as to have 6 poles and is run from an alternator giving a frequency of 60. What speed will the motor run at when not loaded?

Ans. 1,200 rev. per min.

(1807) How does a synchronous motor adjust itself to changes of load without changing its speed? That is, how is it that the current flowing through the armature is allowed to increase as the load increases?

(1808) What effect has inductance upon the size of wire necessary in power-transmission lines?

(1809) A circuit contains reactance, due to self-induction, of 20 ohms, and reactance, due to capacity, of 15 ohms. The resistance of the circuit is 10 ohms. (a) Will the current be ahead of the impressed E. M. F. or behind it? (b) What will be the value of the angle of phase difference?

Ans. $\left\{ \begin{array}{l} (a) \text{ Current behind E. M. F.} \\ (b) \text{ Angle of lag} = 26^\circ 34' \end{array} \right.$

(1810) Explain how the field of an alternator may be strengthened so as to keep the voltage constant when the machine is not provided with compound windings on its field spools.

(1811) If an induction motor is built with a high-resistance secondary winding, how will its speed be affected?

(1812) A three-phase alternator with a Y-connected armature generates a pressure of 1,100 volts and is capable of delivering a current of 50 amperes. (a) What would the voltage be between the collector rings if the same winding were connected up Δ ? (b) What would be the current output with the Δ winding?

Ans. $\left\{ \begin{array}{l} (a) 635 \text{ volts.} \\ (b) 86.6 \text{ amperes.} \end{array} \right.$

(1813) (a) How do eddy-current losses in the core of a transformer affect its action? (b) How may these losses be reduced?

(1814) Explain how it is that a well-constructed transformer maintains, automatically, a nearly constant pressure between its secondary terminals, and takes current in the

primary in proportion to the work which it is doing in the secondary.

(1815) What determines the amount of current which a transformer takes from the line when its secondary is on open circuit?

(1816) Why is it necessary to have a resistance in series with the armature of an induction motor when starting up?

(1817) (a) What is meant by the slip of an induction motor? (b) What is the slip when the motor is held from turning?

(1818) A three-phase rotary transformer is supplied with continuous current at 220 volts. What will be the voltage between the collector rings on the alternating-current side of the machine?

Ans. 134.6 volts.

(1819) Show why the E. M. F. necessary to overcome self-induction is 90° ahead of the current in phase.

(1820) (a) What effect does the hysteresis loss in the core have on the action of a transformer? (b) How may this loss be kept down? (c) Why should special care be taken to have it small in transformers used for lighting work?

(1821) (a) Show how two transformers may be connected up so as to transform two-phase to three-phase currents. (b) If the primaries of the transformers used have each 600 turns, what must be the number of turns on the secondaries, the two-phase voltage being 1,000, and the three-phase, 200?

Ans. (b) 120 turns and 104 turns.

(1822) Why are open slots preferred for induction-motor armatures and fields?

(1823) It is desired to raise the pressure 30 volts on a certain feeder running from a station by connecting the secondary of a special transformer in series with the feeder. The dynamo pressure is 2,000 volts, and the transformer primary is to be connected across its terminals, as shown in Fig. 48. The primary coil is wound with 800 turns. (a) Find the number of turns on the secondary which must be connected in series with the feeder. (b) If the maximum

current delivered over the feeder is 20 amperes, and the secondary coil can safely carry 1 ampere for every 1,000

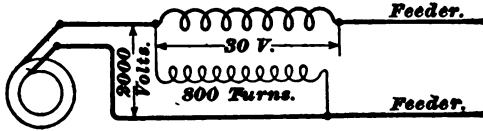

FIG. 48.

circular mils cross-section, find the size of wire to be used in the secondary. (c) How many watts output should this transformer have?

Ans. $\left\{ \begin{array}{l} (a) \text{ 12 turns.} \\ (b) \text{ No. 7 B. \& S.} \\ (c) \text{ 600 watts.} \end{array} \right.$

(1824) A two-phase rotary transformer is supplied with alternating current at 400 volts. What will be the pressure obtained between the brushes on the direct-current side?

Ans. 565.7 volts.

(1825) A monocyclic alternator has 16 poles and runs at the rate of 450 R. P. M. Its armature has 800 face conductors, or 400 turns connected in series, and the flux through each pole is 1,250,000 lines. (a) Find the voltage between the two outside, or main, collector rings. (b) Find the voltage between the middle and outer rings, provided the "teazer" winding has $\frac{1}{4}$ as many turns as the main winding.

Ans. $\left\{ \begin{array}{l} (a) \text{ 1,332 volts.} \\ (b) \text{ 745 volts, nearly.} \end{array} \right.$

(1826) A transformer is to have its primary designed for connection to 2,000-volt mains and a frequency of 125 cycles per second. The magnetic flux in the iron core is limited to 500,000 lines. (a) How many turns should there be in the primary coil? (b) How many turns should there be in the secondary if the secondary voltage is to be 100?

Ans. $\left\{ \begin{array}{l} (a) \text{ 720 turns.} \\ (b) \text{ 36 turns.} \end{array} \right.$

(1827) A three-phase induction motor has a commercial efficiency of 80% and a power factor of .85. (a) What current will it take from the primary mains when delivering

20 H. P. at the pulley, provided the pressure between the primary mains is 220 volts? (b) What will be the current in the field windings if the coils are connected up Δ ?

Ans. $\left\{ \begin{array}{l} (a) \text{ 57.6 amperes in each line.} \\ (b) \text{ 33.2 amperes.} \end{array} \right.$

(1828) Calculate the size of wire necessary to transmit 200 H. P. over a line 25 miles long at a pressure of 10,000 volts with a line loss of 1,000 volts, the frequency being 60. The load is non-inductive and the wires are 18 inches apart on the poles.

Ans. Between No. 3 and No. 4 B. & S. No. 3 would probably be used.

(1829) (a) Does the magnetic flux in the core of a transformer vary with the load? (b) Do the core losses increase with the load?

(1830) Show how lagging currents in a system may limit the useful output of the alternators in the station.

(1831) How may a Cardew voltmeter, or other alternating-current voltmeter, be used to measure the strength of an alternating current?

(1832) Resolve a current of 50 amperes into two equal currents differing in phase by 60° , and find the value of these currents. Illustrate by means of a diagram drawn to scale.

Ans. 28.8 amp.

(1833) An induction motor having 10 poles is connected to an alternator of frequency 60. (a) What speed will the motor run at when operating under no load? (b) What will be its speed at full load, provided the slip is 5%?

Ans. $\left\{ \begin{array}{l} (a) \text{ 720 R. P. M.} \\ (b) \text{ 684 R. P. M.} \end{array} \right.$

(1834) (a) Show how to construct a sine curve. (b) At what point is a sine wave changing most rapidly?

(1835) A three-phase alternator has a Δ -connected armature. Its output is 150 K. W. and the line voltage is 1,000. (a) What is the full-load current in the lines? (b) What is

the full-load current which the wire on the armature has to carry ?

Ans. $\left\{ \begin{array}{l} (a) \text{ 86.6 amperes.} \\ (b) \text{ 50 amp.} \end{array} \right.$

(1836) How may the power supplied to a circuit be measured by means of three voltmeters ?

(1837) (a) Why are open-circuit windings used largely on alternator armatures ? (b) Does the kind of winding used affect the frequency, and if not, why ?

(1838) A transformer carrying a load of 100 lamps consuming 50 watts each requires a primary current of $6\frac{1}{2}$ amperes at a primary pressure of 1,000 volts. (a) What is the apparent efficiency of the transformer ? (b) If the power factor at this load is .85, what is the real amount of energy consumed in the primary ? (c) What is the true efficiency for this load ?

Ans. $\left\{ \begin{array}{l} (a) \text{ 76.9\%} \\ (b) \text{ 5,525 watts.} \\ (c) \text{ 90.5\%} \end{array} \right.$

(1839) Why can not Y-connected armatures be used for three-phase rotary transformers ?

(1840) Why should the width of opening in the coils of an alternator armature never be but slightly less than the width of the pole face ?

DESIGN OF ALTERNATING-CURRENT APPARATUS.

(ARTS. 4057-4271.)

(1841) Why are the core losses in alternator armatures liable to be greater than those in continuous-current armatures of the same output if care is not taken in their design?

(1842) Under what conditions may armature self-induction limit the output of an alternator?

(1843) About how many watts per square inch of cylindrical surface should a well-ventilated armature be capable of radiating with a rise in temperature of 40° C.?

(1844) What is the general effect of armature reaction upon the voltage obtained between the collector rings of an alternator, the field excitation of which is kept constant?

(1845) Explain how an alternator may be made to regulate for constant current by the use of an armature having high self-induction.

(1846) A single-phase alternator has 16 poles and runs at a speed of 450 revolutions per minute. Its armature is provided with 16 slots, with 30 conductors in each slot. The flux from each pole-piece is 3,000,000 lines. (a) What voltage will be obtained between the collector rings at no load? (b) If the winding were placed in 32 equally spaced slots, with 15 conductors per slot, what would be the voltage at no load? (c) If the winding were placed in 48 slots with 10 conductors in each slot, what would be the voltage?

Ans. $\left\{ \begin{array}{l} (a) \text{ 1,918 volts.} \\ (b) \text{ 1,356 volts.} \\ (c) \text{ 1,279 volts.} \end{array} \right.$

(1847) (a) Under what conditions would you use bars for an armature winding rather than wire? (b) When would wire be preferable?

(1848) Why are the coils or bars of distributed-wound armatures very often arranged in two layers?

(1849) A single-phase alternator has 12 poles and runs at the rate of 300 R. P. M. The flux from each pole is 3,000,000 lines and the armature has 12 slots. (a) How many turns must be placed on the armature in order to obtain 1,500 volts between the collector rings? (b) How many turns would be needed if the winding were placed in 24 slots?

Ans. $\left\{ \begin{array}{l} (a) \text{ 375 turns.} \\ (b) \text{ 530 turns.} \end{array} \right.$

(1850) (a) What is the resistance of a foot of copper wire .001 inch in diameter at ordinary temperatures? (b) What is the resistance of a mil-foot of copper at the usual working temperature met with in dynamos?

Ans. $\left\{ \begin{array}{l} (a) \text{ 10.4 ohms.} \\ (b) \text{ 11.5 ohms.} \end{array} \right.$

(1851) Why is it necessary to insulate between the separate layers of heavy armature coils and primary coils of transformers?

(1852) A three-phase two-coil winding is to be provided for a 16-pole alternator; if the winding is arranged in two layers, how many slots will the armature have? Ans. 96.

(1853) Why is it necessary to have higher insulation on the field spools of an alternator which is provided with compound coils connected to the armature than on the spools of a plain separately-excited machine?

(1854) Why are revolving shunts sometimes used in connection with alternator rectifiers?

(1855) What is the principal factor which limits the output of an alternator?

(1856) Why are the effects of armature reaction of less importance in alternators than in direct-current machines?

(1857) (a) Explain how eddy currents may be avoided to a large extent in armature cores. (b) Why is the eddy-

current loss apt to be large in alternators if care is not taken in constructing the core? (c) How do eddy-current losses vary with the frequency?

(1858) How may an alternator armature be constructed so as to have a low inductance?

(1859) A three-phase alternator has 8 poles and runs at a speed of 900 revolutions per minute. Its armature has 24 slots, with 60 conductors in each. The flux from one pole is 2,500,000 lines. (a) What will be the E. M. F. generated in each phase at no load? (b) What E. M. F. would be obtained per phase if the armature had 48 slots with 30 conductors in each? (c) If the armature had the whole 1,440 conductors spread evenly over the surface, what would be the E. M. F. generated per phase?

Ans. $\left\{ \begin{array}{l} (a) 1,598 \text{ volts.} \\ (b) 1,542 \text{ volts.} \\ (c) 1,518 \text{ volts.} \end{array} \right.$

(1860) What would you consider a fair value of the peripheral speed for a 150 K. W. 60-cycle alternator?

(1861) (a) About what thickness of iron should be used for alternator-armature disks? (b) Why is the amount of iron in alternator-armature cores usually smaller than in those of continuous-current machines of corresponding output?

(1862) Why are distributed windings not suitable for high-voltage machines?

(1863) A single-phase alternator is to deliver 200 K. W. at 2,300 volts. The current density in the armature conductors is to be in the neighborhood of 500 circular mils per ampere. (a) What should be the approximate cross-section of the conductor in circular mils? (b) Give an arrangement of conductor which you think would be suitable for this case.

(1864) (a) Explain how the resistance of a wire may be calculated when its length, area of cross-section in circular mils, and the resistance of a mil-foot are known. (b) Calculate the hot resistance of 1,600 feet of copper conductor having a cross-section of 11,500 circular mils.

Ans. (b) 1.6 ohms.

(1865) Will the size of a three-phase armature for a given output be any greater for a Δ winding than for a Y winding? Give reasons for your answer.

(1866) Why should induction motors be provided with specially stiff shafts?

(1867) The cross-section of a 125-cycle transformer core is 19 square inches. The primary voltage is 1,000. (a) About what value should the total magnetic flux have? (b) How many turns should be placed on the primary? (c) If the secondary voltage is to be 50, about how many turns should there be on the secondary coil?

Ans. (a) About 200,000 lines.
(b) 900 turns, nearly.
(c) 45 turns.

(1868) Why do alternators with armatures of high inductance require more powerful series coils on the field than those having armatures of low inductance?

(1869) What is a fair value for the magnetic density in the cast-iron yoke of an alternator?

(1870) What effect would an air-gap in the magnetic circuit of a transformer have on the current in the primary, the secondary being on open circuit?

(1871) How may the series coils of a compound-wound alternator be supplied with a rectified current proportional to the load without having the coils electrically connected to the armature winding?

(1872) If an induction motor is to run at a speed of about 1,500 R. P. M. on a 125-cycle circuit, how many poles should its field be wound for?

(1873) What causes the armature of an alternator to heat up when it is run on open circuit in a fully excited field?

(1874) (a) What determines the rise in temperature at which it is safe to work an alternator armature continuously? (b) What would you consider a fair value for the allowable rise in temperature?

(1875) Why does an induction motor with a low-resistance armature give better speed regulation than one with an armature of high resistance ?

(1876) How does the reaction of an alternator armature affect the field in case the armature has no inductance ?

(1877) What class of alternator armatures have high self-induction ?

(1878) Give the dimensions of a pulley (face and diameter) which you would consider suitable for a 250 K. W. alternator running at 450 R. P. M.

(1879) Why is it that the core losses in the secondary of an induction motor are usually small ?

(1880) How does armature reaction in an alternator affect the field when the current in the armature lags behind the E. M. F. ?

(1881) An alternator armature has 10 coils connected in series, each of which has 20 turns and an inductance of .01 henry. (a) What will be the total inductance of the armature ? (b) If the winding is split up into 20 coils of 10 turns each, what will be the total inductance, other things being equal ?

Ans. $\left\{ \begin{array}{l} (a) .1 \text{ henry.} \\ (b) .05 \text{ henry.} \end{array} \right.$

(1882) (a) How do the windings for induction-motor fields compare with those used for polyphase armatures ? (b) Why are induction-motor field windings usually placed in slots rather than on projecting poles ?

(1883) How does the percentage C^2R loss in small alternators compare with the same loss in large machines ?

(1884) (a) Upon what quantities does the hysteresis loss in a core depend ? (b) Does building the core up out of disks affect this loss or decrease it ?

(1885) A transformer has a capacity of 5 K. W., costs \$30, and has a core loss of 120 watts. Another transformer, also of 5 K. W. capacity, costs \$50, and has a core loss of

900 watts. (a) If power is worth 10 cents per kilowatt-hour and the pressure is maintained continuously, how much will the core losses in each of the transformers cost per year? (b) With interest and depreciation at 10%, which transformer would be the more economical to use?

Ans. (a) $\left\{ \begin{array}{l} \text{1st transformer, } \$105.12. \\ \text{2d transformer, } \$78.84. \end{array} \right.$

(1886) If an armature core has a volume of 2,200 cubic inches and runs at a speed of 900 R. P. M. in an 8-pole field, calculate the watts wasted in hysteresis, assuming that the iron is of good average quality and is worked at a density of 25,000 lines per square inch. Ans. 363 watts.

(1887) How does the peripheral speed affect the radiating capacity of an armature?

(1888) How may the strength of the compound coils of an alternator be adjusted?

(1889) If the frequency of an alternator were doubled by running it up to twice its normal speed, how would the eddy-current losses in the armature core be affected?

(1890) Why is it better to insert resistance in series with the armature rather than the field of an induction motor when a good starting torque is desired?

(1891) (a) What quantities determine the size of wire to be used for the separately-excited winding of an alternator? (b) Show how the size of wire may be determined when these quantities are known.

(1892) (a) What determines the angular distance between the arms of the rocker carrying the rectifier brushes on an alternator? (b) What would be the angular distance between the tips of the rectifier brushes for a 16-pole machine? Ans. (b) 157.5° .

(1893) (a) Why should the air-gap of an induction motor be made just as small as possible? (b) About what value should be used for the density in the air-gap of these motors?

(1894) (a) How does the magnetic flux in the yoke of an alternator compare with that in the pole-pieces? (b) How does the flux in the pole-pieces compare with that in the air-gap?

(1895) Why are alternator magnet yokes (stationary) usually made of cast iron in preference to cast steel?

(1896) An induction motor is provided with a three-phase primary winding Y-connected. There are 72 slots, with 12 conductors per slot. The secondary is also provided with a three-phase Y-connected winding with 48 slots and 2 bars per slot. (a) If the full-load current in each primary phase is 50 amperes, what will be the current which the bars in the secondary have to carry at full load, assuming the power factor of the secondary to be 1? (b) If 800 circular mils per ampere is allowed, what should be the cross-section of the bars in square mils?

Ans. $\left. \begin{array}{l} (a) \text{ 450 amperes.} \\ (b) \text{ 282,600 sq. mils.} \end{array} \right\}$

(1897) (a) What is meant by a unicoil or concentrated alternator armature winding? (b) What are the advantages of this style of winding? (c) What are the disadvantages of concentrated windings?

(1898) The density in the teeth of an induction-motor field is 40,000 lines per square inch. The volume of the teeth is 200 cubic inches and the volume of the core below the teeth is 500 cubic inches; what will be the total hysteresis loss if the density in the core under the teeth is 20,000 lines per square inch, and the motor runs at 125 cycles?

Ans. 268.75 watts.

(1899) A two-phase 12-pole alternator is provided with 24 slots, in each of which are 50 conductors. The machine runs at a speed of 600 R. P. M. and the flux from one pole is 2,000,000 lines. (a) What will be the voltage generated in each phase? (b) If the 1,200 conductors were spread evenly over the surface, what voltage would be obtained?

Ans. $\left. \begin{array}{l} (a) \text{ 1,598.4 volts.} \\ (b) \text{ 1,438.56 volts.} \end{array} \right\}$

(1900) Why should bolts passing through armature laminations or transformer cores be avoided whenever possible?

(1901) Why are alternators with stationary armatures

better adapted for the generation of high voltages than those with revolving armatures?

(1902) A transformer carries a load during the day which is equivalent to its full-load output of 5 K. W. for 6 hours. The secondary voltage is 100 and the primary 1,000. The C^2R loss in the primary at full load is 60 watts and in the secondary 50 watts. The core loss is 95 watts and the no-load current is supposed to be negligible. What will be the efficiency (a) at full load? (b) at $\frac{1}{2}$ load? (c) What will be the all-day efficiency?

Ans. $\left\{ \begin{array}{l} (a) 96.06\% \\ (b) 95.33\% \\ (c) 91.07\% \end{array} \right.$

(1903) Is there any hysteresis loss in the field-magnet of an alternator which is excited by a steady continuous current? Give reasons for your answer.

(1904) (a) What materials are best suited for insulating armature coils? (b) What materials are generally used for lining armature slots?

(1905) Why are highly saturated armature teeth an advantage in direct-current machines and a disadvantage in alternators and induction motors?

(1906) (a) What are the advantages in using oil insulation for transformers? (b) Why is it important to have high insulation between the primary and secondary coils of a transformer?

(1907) What is a fair value for the magnetic density in the armature core of a 60-cycle alternator?

(1908) A two-phase armature has a resistance of .75 ohm in each phase. The output is 75 K. W. at 1,100 volts. What will be the number of watts lost in the armature windings? Ans. 1,743.2 watts.

(1909) (a) About what value should the magnetic density have in the air-gap of an alternator with cast-iron pole-pieces? (b) What density may be used if the pole-pieces are made of wrought iron?

(1910) Explain how you would obtain the length of an

induction-motor field parallel to the shaft, being given the allowable air-gap density, total magnetic flux, diameter of field, and number of poles.

(1911) (a) What is meant by a distributed or multicoil armature winding? (b) What are the advantages and disadvantages of this style of winding?

(1912) A three-phase induction motor operating on 60 cycles is provided with a Δ -connected field winding. The flux from one pole is 500,000 lines and the line voltage is 500. The winding may be taken as uniformly distributed.

(a) How many turns should there be in each phase? (b) If the power factor of the motor is .85 when 10,000 true watts are being delivered to it from the line, what will be the current in each line? (c) What will be the current in each phase under the same conditions?

Ans. $\left\{ \begin{array}{l} (a) \text{ 396 turns, nearly.} \\ (b) \text{ 13.59 amp.} \\ (c) \text{ 7.84 amp.} \end{array} \right.$

(1913) The flux from one pole of an alternator is 2,500,000 lines. The outside diameter of the armature is 28 inches, and the slots are 2 inches deep. The armature core is to be worked at a density of 30,000 lines per square inch, and the length of the iron in the core parallel to the shaft is 15 inches. (a) What will be the necessary area of cross-section of iron in the core under the slots? (b) What will be the inside diameter of the armature core disks?

Ans. $\left\{ \begin{array}{l} (a) \text{ 41.66 sq. in.} \\ (b) \text{ About } 18\frac{1}{2} \text{ in.} \end{array} \right.$

(1914) (a) How would you arrange the coils of a transformer so that the drop in the secondary voltage due to magnetic leakage shall be small? (b) If the secondary coil of a transformer has a resistance of .02 ohm and the primary has a resistance of 5 ohms, what will be the falling off in secondary voltage when the secondary is delivering 50 amperes? Neglect the drop in primary due to magnetizing current and also drop due to magnetic leakage. Ratio of transformation is 20; that is, $\frac{\text{primary volts}}{\text{secondary volts}} = 20$.

Ans. (b) 1.625 volts.

2954 ALTERNATING-CURRENT APPARATUS.

(1915) An alternator has 8 poles, the windings on which are connected in series and excited from a 220-volt dynamo. Each pair of coils has to supply 4,000 ampere-turns, and the mean length of a turn is 40 inches. The field is connected to the exciter through a regulating rheostat, the drop in which is 25 volts. Find the area in circular mils cross-section of the wire required for the winding, and give the nearest size B. & S.

Ans. 3,145 circular mils. No. 15 B. & S.

(1916) A three-phase armature is Δ -wound to deliver 50 K. W. at a line pressure of 1,100 volts. The resistance per phase is 1.5 ohms. (a) What will be the total C^2R loss in the armature at full load? (b) What will be the drop in voltage between the lines due to the armature resistance?

Ans. $\left. \begin{array}{l} (a) 1,033 \text{ watts.} \\ (b) 22.7 \text{ volts.} \end{array} \right\}$

(1917) Why should the pole-pieces of alternators be laminated?

(1918) A two-phase alternator has an output of 175 K. W. at 3,000 volts. What size wire, B. & S., would you use for winding the armature in order to have an allowance of about 500 circular mils per ampere?

Ans. 14,580 circular mils; between No. 8 and No. 9 B. & S. No. 8 would probably be used.



A KEY
TO ALL THE
QUESTIONS AND EXAMPLES
CONTAINED IN THE
EXAMINATION QUESTIONS
INCLUDED IN THIS VOLUME.

The Keys that follow have been divided into sections corresponding to the Examination Questions to which they refer, and have been given corresponding section numbers. The answers and solutions have been numbered to correspond with the questions. When the answer to a question involves a repetition of statements given in the Instruction Paper, the reader has been referred to a numbered article, the reading of which will enable him to answer the question himself.

To be of the greatest benefit, the Keys should be used sparingly. They should be used much in the same manner as a pupil would go to a teacher for instruction with regard to answering some example he was unable to solve. If used in this manner, the Keys will be of great help and assistance to the student, and will be a source of encouragement to him in studying the various papers composing the Course.

DYNAMO-ELECTRIC MACHINE DESIGN.

(CONTINUOUS-CURRENT.)

(QUESTIONS 1648-1711.)

(1648) A reduction in weight for a given output is secured. On the other hand, high speed requires careful balancing and strong construction. (Art. 3549.)

(1649) The turns embraced within twice the angle of lead of the brushes multiplied by the current flowing through one of those conductors constitute the back ampere-turns. (Art. 3560.)

(1650) "Volume of current" is a term used to indicate the total amount of current which the armature carries. It may be defined as the sheet of current flowing across the whole armature, and is equal to the number of conductors on the periphery of the armature multiplied by the current flowing in one conductor. (Art. 3573.)

(1651) The result obtained is a diminution of sparking at the commutator, because, when the iron is saturated, there is less change in the number of lines of force at the moment of short-circuiting a coil. (Art. 3593.)

(1652) In a four-pole machine there are only two magnetic circuits to be calculated; therefore the total ampere-turns will be double the amount required for one circuit, or, in this case, 9,600 ampere-turns. (Art. 3691.)

(1653) In order to avoid any liability of the shaft being caught between the bearings when expanded by heat, and also in order to promote smooth wearing of the commutator by allowing oscillation of the armature when running. (Art. 3741.)

(1654) The output is limited by the carrying capacity of the armature conductors and by the distortion of the field by armature reaction. (Art. 3541.)

(1655) Small bipolar dynamos may be run at about 2,300 to 2,900 feet per minute; larger machines range between 2,800 to 3,600 feet per minute. Sometimes a fixed speed is used, for small sizes perhaps 3,100, for large sizes 3,500 feet per minute. (Art. 3549.)

(1656) The advantages of such design are that a compact magnetic circuit is obtained and the weight of copper is reduced. (Art. 3551.)

(1657) The cross ampere-turns may be defined as equal to one-half the conductors under the pole-pieces multiplied by the current flowing through each; that is, to the whole number of armature ampere-turns less the back ampere-turns. The cross ampere-turns of a bipolar dynamo are equal to one-half the armature current multiplied by the number of conductors enclosed within an angle equal to 180° less twice the angle of lead. (Art. 3562.)

(1658) The maximum volume of current which an armature may carry is directly proportional to the field ampere-turns required for the air-gap, and inversely proportional to the polar embrace. Therefore, since the angle covered by the pole is usually fixed, the volume of current is affected only by the length and density of the air-gap, and an increase in volume of current must be accompanied by an increase in one of these factors. (Art. 3585.)

(1659) In order to keep the current at a constant value, for any increase of armature current above the normal amount will distort and weaken the field. (Art. 3592.)

(1660) (a) The effect will be a decrease of efficiency, because, the number of turns being decreased, the current must necessarily increase in order to obtain the same number of ampere-turns, and the heat losses are proportional to the square of the current, but only directly proportional to the resistance of the winding.

(b) No.

(c) Because the total number of ampere-turns will be practically constant, as the resistance of the winding is decreased and a larger current flows. (Art. **3622.**)

(**1661**) The external characteristic is useful in showing the performance of a dynamo under load. (Art. **3659.**)

(**1662**) Steel, hard brass, or phosphor-bronze, varying in thickness from No. 18 to 21 or 22. (Art. **3713.**)

(**1663**) The pulleys for small machines run at a high speed, which necessitates very careful balancing. This result is best obtained by casting the pulley with a central web and turning all over. (Art. **3747.**)

(**1664**) About 170° F. (Art. **3544.**)

(**1665**) Usually not more than $2\frac{1}{2}$ inches. This depth should not be exceeded, as a rule, as the rise in temperature of the inner turns may otherwise become very high. (Art. **3550.**)

(**1666**) Distortion of the field is produced, causing an uneven distribution of the lines of force. Under the leading pole tips of a dynamo the density becomes less than normal, and under the following pole tips it becomes greater. (Art. **3554.**)

(**1667**) When the back ampere-turns are increased, owing to the necessity of shifting the brushes, the cross ampere-turns are correspondingly decreased; so that, while the opposition to the field lines of force is greater, the distribution of the lines is more uniform. For this reason, the commutating fringe at the leading pole tip is still sufficiently strong to reverse the current effectively, as long as the current is not excessive. (Art. **3564.**)

(**1668**) (a) The armature ampere-turns consist of the cross ampere-turns and the back ampere-turns.

(b) They are equal to one-half the total number of conductors on the surface of the armature multiplied by the current carried by each. (Art. **3569.**)

290 DYNAMO-ELECTRIC MACHINE DESIGN.

(1669) When the air-gap density is about 50,000 lines of force per square inch, the length of air-gap may be equal to one-half the width of slot. (Art. 3588.)

(1670) (a) Yes.

(b) A high resistance of shunt provides the requisite number of ampere-turns with a low current strength, and as the heat loss is directly proportional to the resistance, but proportional to the square of the current, the latter should preferably be kept at a low value. Also, when the shunt resistance is great, a smaller amount of the total current output of the machine is used in the field, leaving a larger proportion for the external circuit. (Arts. 3622 and 3623.)

(1671) Bipolar machines may be made in sizes up to about 15 or 20 horsepower. (Art. 3692.)

(1672) In order that the armature and shaft may be entered between the pole-pieces. (Art. 3753.)

(1673) A specified overload should be provided against, as being likely to occur frequently. A limit of 15 or 20 per cent. will usually be found sufficient. (Art. 3542.)

(1674) From about 10 per cent. for a 1 K. W. machine to about 1.5 per cent. for a 100 K. W. machine. (Art. 3552.)

(1675) (a) No.

(b) The cross ampere-turns produce a different distribution of lines of force in the field, by distortion; but the total number of lines of force is not changed. (Art. 3554.)

(1676) The electrical efficiency of a dynamo is obtained by multiplying 100 times the E. M. F. at the brushes, in volts, by the current in amperes available for the external circuit and dividing the result by the product obtained by multiplying together the total E. M. F., in volts, and the total current in amperes. (Art. 3668.)

(1677) (a) The maximum volume of current which a smooth-core drum armature may carry is equal to 240 times

the field ampere-turns required for the air-gaps, divided by the angle embraced by one pole-piece.

(*b*) For a ring armature, the maximum volume of current is equal to 180 times, instead of 240 times, the above value. (Arts. **3574** and **3575**.)

(**1678**) Smooth-core armatures are especially suitable for electric-light dynamos, as the load comes on gradually and the brushes may be moved to the proper position for sparkless running. When the load fluctuates considerably and suddenly, the brushes must be kept in one position, which is possible only with a slotted armature, and this style of machine is therefore used for street-railway work and for installations of similar character. (Art. **3593**.)

(**1679**) The values of the ampere-turns per magnetic circuit are found for no load and for full load, the required E. M. F. and speed being specified for each case. The difference between these two values of the ampere-turns gives the ampere-turns for the series coils. (Art. **3642**.)

(**1680**) Higher insulation is obtained by this means, as a larger surface of insulating material is introduced between the segments and the shell of the commutator. (Art. **3718**.)

(**1681**) Allow about 1.11 square inches of surface per watt lost in heating. (Art. **3546**.)

(**1682**) In the air-gap. (Art. **3553**.)

(**1683**) (*a*) The field would be neutralized, and the excessive sparking due to this cause would necessitate reduction of load or shutting down the machine. (Art. **3563**.)

(*b*) The M. M. F. in the gap due to the field ampere-turns should be $1\frac{1}{2}$ to 2 times the cross M. M. F. due to the armature current. (Art. **3564**.)

(**1684**) From 1.1 to 1.5 or 2 square inches of surface should be allowed per watt expended in heating. (Art. **3550**.)

294 DYNAMO-ELECTRIC MACHINE DESIGN.

(1655) It becomes difficult to regulate the E. M. F., because there is a wide variation in the temperature of the coils, which heat up continually after the machine is started. The consequent change in resistance causes the E. M. F. to fall steadily, and a constant difference of potential is obtained only after running for some time. (Art. 3623.)

(1656) Not more than 15 or 16 volts between segments; but a lower difference of potential is rather better. (Art. 3723.)

(1657) Laminated pole-pieces are used in order to prevent the generation of eddy currents in those parts. (Art. 3762.)

(1658) The rise in temperature of an armature is equal to 99 times the watts lost, divided by the exposed surface in square inches multiplied by 1 plus 0.00018 times the velocity in feet per second. (See also Art. 3546.)

(1659) At the pole tips, at nearly diametrically opposite points. (Art. 3553.)

(1690) A high density is used to counteract the effect of self-induction of the armature coils, as there is only a slight change in the total number of lines of force in the core when those due to the armature current collapse. (Art. 3567.)

(1691) (1) Smooth-core machines.

(2) Because this style of machine has low self-induction, which is an important requirement when heavy currents are carried. (Art. 3594.)

(1692) In order to make provision for changing within certain limits the amount of current passing through the series coils, and thereby regulating the amount of compounding. (Art. 3654.)

(1693) It would not be possible to remove a brush while the machine was running, if there were no other brush provided to collect the current in the meantime. (Art. 3727.)

(1694) (a) It is usually necessary to consider the back ampere-turns, (b) because a lead must be given to the brushes in order to bring the armature coils under the pole tip for commutation of the current. (Art. 3560.)

(1695) (a) 100,000 lines of force per square inch, and sometimes as high as 120,000.

(b) For drum armatures, 85,000 to 90,000 lines of force, and for ring armatures 100,000 to 110,000 or more lines of force, per square inch.

(c) Cast-iron yokes, about 30,000; for cast steel, about 75,000; and for wrought iron, about 85,000 lines of force per square inch.

(d) Cast iron, about 40,000 to 50,000; and cast-steel or wrought-iron forgings, 95,000 to 105,000 lines of force per square inch. (Arts. 3598 to 3601.)

(1696) The energy loss, in watts, of the shunt and series windings of a compound dynamo should be proportioned to the respective ampere-turns carried by each coil. (Art. 3646.)

(1697) A leakage coefficient of 1.25 indicates that $\frac{.25}{1.25} = 20$ per cent. of the magnetizing force is wasted. The magnetizing force is 3 per cent. of the total output; therefore 20 per cent. of 3 per cent., or .6 of 1 per cent., of the total output is lost in leakage. (Art. 3693.)

(1698) The maximum number of ampere-turns which an armature may carry is equal to the volume of current flowing through the conductors divided by the number of field-magnet poles. (Art. 3579.)

(1699) Copper-gauze brushes collect heavy currents without much heating and interpose but little resistance in the circuit, which is desirable in the case of low-potential lighting dynamos. Since the load comes on gradually, an attendant is always able to shift the brushes by hand to the point of least sparking. (Art. 3727.)

1700

$$r = \frac{30 \pi}{L}$$

where r = temperature rise of spool in degrees Fahrenheit;
 π = watts expended in coils;
 L = surface of spool (wire only) in square inches.
 (Art. 3550.)

(1701) When the air-gap is long as compared with the width of the slot, the lines of force spread out, and the density at the pole face becomes more uniform than would be the case with a shorter gap. (Art. 3555.)

(1702) When the current and E. M. F. on a characteristic curve are laid out to the same scale (as is usual), and a line is drawn from the origin to any point on the curve, the tangent of the angle of slope will indicate the value of the external resistance. The current is equal to the E. M. F. divided by the resistance; the vertical dimension on the curve sheet represents the E. M. F., and the horizontal dimension represents the current. But the former divided by the latter is equal to the tangent of the angle of slope, so that this tangent always represents the value of the resistance. (Art. 3660.)

(1703) In the inverted bipolar form of dynamo the pole-pieces approach close to the iron bed-plate, and the zinc block is introduced in order to preserve sufficient distance between to prevent undue leakage. (Art. 3759.)

(1704) (a) The back ampere-turns must be neutralized by an equal number of ampere-turns on the field-magnets.

(b) The back ampere-turns are equal to $\frac{C r c}{360}$, where C = total armature current; r = angle of lead of brushes; c = total number of conductors. (Arts. 3560 and 3561.)

(1705) Considerable self-induction results at commutation on account of the coils being wound over iron teeth, and sparking results. (Art. 3593.)

(1706) If, on the dynamo characteristic, the resistance of the external circuit when laid out should be of such a value

as to correspond with the initial portion of the characteristic, this constitutes the critical resistance of the circuit, and the instability of operation is extreme. (Art. **3661**.)

(**1707**) Ring armatures possess greater self-induction than drum armatures, so that a greater angle of lead is required to overcome it, as well as a more powerful field for reversal. In order to obtain this condition, the field ampere-turns must be relatively stronger in the case of a ring armature than of a drum armature, for the same cross ampere-turns. (Art. **3567**.)

(**1708**) The following current densities per square inch may be used: (*a*) for copper, 150 amperes; (*b*) for brass, 100 amperes; (*c*) for carbon, 30 amperes. (Art. **3727**.)

(**1709**) (*a*) and (*b*) The change in magnetic density at points close together becomes abrupt, so that if there is any uneven spacing of the conductors, they will be short-circuited at different points relative to the pole-piece, and thus cause sparking. (Art. **3565**.)

(**1710**) Due to drop of potential through the armature, and to weakening and demagnetizing action of the armature current. (Art. **3662**.)

(**1711**) We may begin by selecting the armature diameter, and, if necessary, change the figure subsequently. We will take a diameter of 8 inches. Then, since the peripheral velocity is 2,600 feet per minute, the speed will be $\frac{2,600 \times 12}{8 \times 3.1416} = 1,240$ R. P. M. The density in the air-gap may be about 35,000 lines of force per square inch. In determining the size of armature conductor we must allow 600 circ. mils per ampere. $5 \text{ H. P.} = 5 \times 746 = 3,730$ watts, and $\frac{3,730}{230} = 16.22$ amperes output. The shunt current will be about .48 ampere; total armature current = 16.7 amperes. The cross-sectional area of the conductor is then $\frac{600 \times 16.7}{2} = 5,010$ circ. mils. No. 13 wire = 5,178 circ. mils, and will therefore be suitable.

296 DYNAMO-ELECTRIC MACHINE DESIGN.

If we allow for an air-gap of $\frac{1}{8}$ in. each side, the bore of the fields will be $8\frac{1}{4}$ in. We will suppose that each pole face covers 125° ; then the length of pole face will be $\frac{8.25 \times 3.1416 \times 125}{360} = 9$ in. If the width of the pole face

(length of armature) is 6 inches, the area of the pole face at the air-gap will be 54 sq. in. At 35,000 lines per square inch, this will give 1,890,000 lines of force in the air-gap.

By modification of formula **480** we have

$$c = \frac{E \times 60 \times 10^8}{NS} = \frac{230 \times 60 \times 10^8}{1,890,000 \times 1,240} = 588.$$

By selecting 32 slots and 18 conductors per slot we obtain $c = 576$. With this number of conductors the lines of force N must be $\frac{230 \times 10^8 \times 60}{576 \times 1,240} = 1,932,000$. The density in the air-gap will then be $\frac{1,932,000}{54} = 35,780$ lines per square inch.

The diameter of No. 13 wire, double cotton covered, is .081 in. We must allow for 2 coils per slot, as this will allow us 32 bars in the commutator. Each coil will be wound, then, in 9 turns, forming a square in cross-section, being shaped to the armature, bound over with tape, and shellaced. The thickness of the coil when wound will be about $.081 \times 3 + 2 \times .03 = .303$, allowing .03 for tape each side and for irregularities. If, then, we insert .04 in. mica insulation on each side of the coil in the slot, the width of slot will be .383 in. Between two coils in a slot we will place a strip of fiber .1 in. thick, .04 in. of mica at the bottom of the slot, the same above the upper coil, and a piece of hard wood .15 in. thick over this. The depth of the slot will then be $2 \times .303 + .1 + 2 \times .04 + .15 = .936$ in., or, say, $\frac{11}{8}$ in.

As there are 32 slots and 2 coils per slot, the number of winding spaces $w = 64$. By formula **483**, $w = 2j \pm 2$, whence the pitch $j = \frac{64 \pm 2}{2} = 31$ or 33. We will adopt the smaller number 31.

The armature being 8 in. in diameter, the circumference is 25.13 in., and the pitch of the teeth is $\frac{25.13}{32} = .785$ in. at the top. The slots are $\frac{1}{8}$ in. deep, and the diameter at the root of the teeth is therefore $8 - 1\frac{1}{2} = 6\frac{1}{2}$ in., which gives a circumference of 19.24 in. The pitch at the root of the teeth is, then, $\frac{19.24}{32} = .601$ in. The average pitch = $(.785 + .601) \div 2 = .693$ in. The width of slot = .383 in.; therefore the average thickness of tooth = $.693 - .383 = .31$ in.

The angle embraced by one pole-piece is 125° . $\frac{1}{2} \times 32 = 11$ teeth under the pole. The effective area = $11 \times .31 \times$ length of armature. The effective length of the armature is $.88 \times 6 = 5.28$ in. Therefore the effective area of teeth under the pole = $11 \times .31 \times 5.28 = 18$ square inches. The density in the teeth will be $\frac{1,932,000}{18} = 107,300$. The leakage coefficient is 1.25; then the induction in the magnet core will be $1.25 \times 1,932,000 = 2,415,000$ lines of force. If we take a diameter for the core of $5\frac{1}{2}$ in. corresponding to 24.85 sq. in. area, the density will be $\frac{2,415,000}{24.85} = 97,250$ lines per square inch.

The diameter of the armature core at root of the teeth is $6\frac{1}{2}$ in. Allowing for a shaft $1\frac{1}{2}$ in. in diameter, the radial depth of the core is $2\frac{1}{2}$ in. Then the density will be $\frac{966,000}{2.25 \times 5.28} = 81,400$ lines per sq. in.

The current in the armature at full load is 16.7 amperes and the back ampere-turns = $(16 - 11) \times 18 \times \frac{16.7}{2} = 751$.

The yoke may be cast iron, say 10 in. average length, with a density of 30,000 lines of force per sq. in. For the pole-pieces we will allow 4 inches each, or a total of 8 in., with a density of 50,000.

For the magnet cores we may allow a length of 4 inches each, or 8 inches total. Then the total ampere-turns will be:

298 DYNAMO-ELECTRIC MACHINE DESIGN.

	Length. In.	Density.	Amp.-turns per In.	Ampere- turns.
Air-gap.....	$\frac{1}{4}$	35,780		2,800
Magnet core.....	10	97,250	110	1,100
Cast-iron yoke, flanged.	10	30,000	43	430
Pole-pieces.....	8	50,000	10	80
Armature core.....	5	81,400	30	150
Armature teeth.....	$1\frac{1}{2}$	107,300	100	187
Back ampere-turns.....				751
				<u>5,498</u>

The total ampere-turns we may call 5,500.

The diameter inside of magnet spool = $5\frac{1}{2}$ in., and depth of winding may be, say, $1\frac{1}{2}$ in. The mean diameter will be 7 inches, corresponding to a circumference of 21.99 in., or 1.83 feet.

By formula **592** the area of the wire is $\frac{12 \times 1.83 \times 5,500}{230} = 525$ circ. mils. The nearest size of wire is No. 23, B. & S., having a cross-sectional area of 509.5 circ. mils. Winding volume = $4 \times 1.125 \times 2 = 9$ sq. in. Turns per sq. in. = 1,307, making a total of 11,763 turns. Total length in feet = $1.83 \times 11,763 = 21,520$, and the resistance will be, cold, about $20.37 \times 21.52 = 438$ ohms. Allowing for a temperature rise of about 40° F., the resistance, hot, will be about 477 ohms. The shunt current = $\frac{477}{1000} = .483$ ampere. Watts loss = $CE = .483 \times 230 = 111$, and the loss in the shunt = $\frac{111 \times 100}{3,730} = 2.98$ per cent.

The cylindrical surface of the armature = $8 \times \pi \times 6 = 150.78$ sq. in., and at the ends about 50 sq. in. additional, for radiation of heat. There are 288 complete turns of wire, each turn being about 3 feet long. Total length = $288 \times 3 = 864$ feet.

No. 13 wire has a resistance per 1,000 feet of 2 ohms; then two lengths in parallel, each 432 ft., have a resistance of .432 ohm. Allowing for heating and effect of joints, we may call this resistance .5 ohm. The $C^2 R$ loss will then be

$16.7^{\circ} \times .5 = 139.45$ watts. The temperature rise, by formula **559**, is

$$t = \frac{99 \times 139.45}{200.78 \times (1 + .00018 \times 45)} = \frac{13,805}{202.4} = 68^{\circ} \text{ F.}$$

Outside diameter of field spools = $8\frac{1}{2}$ in. Length of each = $\frac{1}{4}$ in. Total surface = $8\frac{1}{2} \times \pi \times 8 = 20\frac{1}{4}$ sq. in. Watts lost (as already found) = 111. The temperature rise of the spools is, by formula **560**,

$$t = \frac{80 \times 111}{20\frac{1}{4}} = 43^{\circ} \text{ F.}$$

MOTOR DESIGN.

(CONTINUOUS-CURRENT.)

(QUESTIONS 1712-1747.)

(1712) (a) The counter E. M. F. is the E. M. F. generated by the armature conductors cutting across the magnetic field when the motor is in motion. (Art. 3782.)

(b) The counter E. M. F. may be calculated from the expression

$$E_m = \frac{n C N}{10^8},$$

which in this case gives

$$E_m = \frac{1,000 \times 400 \times 3,000,000}{60 \times 10^8} = 200 \text{ volts. Ans.} \\ \text{(Art. 3787.)}$$

(1713) A shunt motor runs at nearly constant speed because the field strength is nearly constant, and also because the counter E. M. F. which the machine has to generate drops only a slight amount when the motor is loaded. (Arts. 3792 and 3793.)

(1714) (a) We have the relation between the line E. M. F. and the counter E. M. F. given in formula 601. Hence we have

$$E = E_m + C R_a.$$

$$220 = E_m + 100 \times .05.$$

$$E_m = 215 \text{ volts. Ans. (Art. 3783.)}$$

(b) If the armature were held from turning, the counter

E. M. F., E_a , would be zero, the current would be limited simply by the armature resistance, and we would have

$$C = \frac{E}{R_a} = \frac{220}{.05} = 4,500 \text{ amperes. Ans.}$$

(1715) Series motors are better adapted for street-railway work because they can be made to give a very strong effort for short intervals; also because they are less expensive and their field windings are less easily damaged. (Art. 3799.)

(1716) (a) If the balance gives a reading of 10 lb. at a radius of 2 feet, the useful torque is 20 ft.-lb., and the torque acting on the armature is this plus the 1 ft.-lb. necessary to make up for friction. The total torque acting on the armature is, therefore, 21 ft.-lb. From formula 605 we have

$$T' = .00117 \frac{N C C_m}{10^6},$$

where N is the magnetic flux, C the number of armature conductors, and C_m the current flowing through the armature.

Hence,
$$21 = .00117 \times \frac{N \times 300 \times 25}{10^6},$$

or
$$N = \frac{21 \times 10^6}{.00117 \times 300 \times 25} = 2,393,100 \text{ lines, nearly. Ans.}$$

(b) The total torque acting on the armature is 21 foot-pounds, and since the diameter of the armature is 12 in., or 1 foot, the pull at the circumference of the armature must be 42 lb. This pull will be exerted upon the conductors under the poles, so that the average pull for conductor will be

$$\frac{42}{300} = .14 \text{ lb. Ans. (Arts. 3787 and 3788.)}$$

(1717) (a) The commercial efficiency is the ratio of the total useful power delivered at the pulley to the total power supplied from the mains.

(b) 10 H. P. = 7,460 watts delivered; hence, input must be $\frac{7,460}{.85} = 8,776$ watts, and the current supplied must be $\frac{8,776}{500} = 17.55$ amperes. Ans. (Art. **3785**.)

(1718) (a) The speed decreases as the load is increased, because the motor, being operated from constant-potential mains, has to generate a nearly constant E. M. F. As the load increases the field strength increases, hence the speed must diminish.

(b) It is not safe to throw the load entirely off the motor because the speed would become so high that the armature would be liable to injury. (Arts. **3798** and **3799**.)

(1719) Strengthening the field lowers the speed of the motor, because the stronger the field the less the speed at which the armature has to turn to generate the required counter E. M. F. (Art. **3794**.)

(1720) The efficiency of conversion of a motor of this capacity should be about .904 and the electrical efficiency about .916 (see Fig. 1428). The commercial efficiency would therefore be $.904 \times .916 = .828$. If the output at the pulley is $20 \times 746 = 14,920$ watts, the input must be $\frac{14,920}{.828} = 18,020$ watts, nearly. The total current input will then be $\frac{18,020}{220} = 81.9$ amperes; 3% of this current, or 2.46 amp., will flow through the field, so that the armature should be designed to carry about $81.9 - 2.46 = 79.44$ amperes. The efficiency of conversion is .904; hence, the total electrical energy active in the armature is $\frac{14,920}{.904} = 16,500$ watts, nearly. The current flowing through the armature is 79.44 amperes; hence, the counter E. M. F. must be $\frac{16,500}{79.44} = 208$ volts, nearly. We must then design as a dynamo a machine capable of generating 208 volts at a

speed of 800 R. P. M., and have a current-carrying capacity of 79.44 amperes in the armature and 2.46 amperes in the field. Ans.

(1721) (a) One method for regulating the speed is the cutting down of the E. M. F. across the armature terminals by the insertion of a resistance in the armature circuit. Another method is by strengthening or weakening the field by means of a field rheostat.

(b) The latter method is the more economical. (Arts. 3794 and 3795.)

(1722) (a) A resistance is necessary at starting because the counter E. M. F. is then zero; and since the armature resistance is very low, a very large current would flow if the armature were connected directly across the mains.

(b) A burned-out armature would result, unless the circuit was at once broken by some safety device, such as fuses or a circuit-breaker; in any event, the commutator is quite liable to be burned. (Art. 3805.)

(1723) (a) The total torque T' can at once be calculated from formula 605:

$$T' = .00117 \frac{NC C_m}{10^6} = .00117 \times \frac{2,500,000 \times 500 \times 20}{1,000,000} = 29.25 \text{ foot-pounds. Ans.}$$

(b) If the diameter of the armature is 9 in., the radius is $\frac{3}{2}$ ft. Consequently the pull at the circumference of the armature must be $\frac{29.25 \times 8}{3} = 78$ pounds; 60% of the conductors are under the poles, so that the pull per conductor must be $\frac{78}{.60 \times 500} = .26$ lb. (Art. 3787.)

(1724) (a) The connection from field terminal 2 to the line is wrong. This connection should be made to the line on the switch side of the rheostat, as shown in Fig. 1422.

(b) If the connections were as shown and the main switch thrown, the field would not be excited, because no connec-

tion would be made to the field until the rheostat arm was moved from the dead point to the first resistance point. Current would then flow through both armature and field, but the magnets would be but very slightly energized, so that very little starting torque would be produced. There would be no danger of short circuit, as the rheostat is properly connected in series with the armature.

(1725) (a) The efficiency of conversion of a motor is the ratio of the total energy delivered at the pulley to the active electrical energy in the armature, i. e., to the armature current multiplied by the counter E. M. F. The greater the core losses and friction losses, the lower will be the efficiency of conversion.

(b) The total energy active in the armature is $100 \times 10 = 1,000$ watts. Total energy delivered is 1 H. P. = 746 watts. Efficiency of conversion = $\frac{746}{1000} = .746$, or 74.6%.

(Art. 3785.)

(1726) The speed of a series motor may be regulated by the same methods already given for a shunt motor, namely, by cutting down the applied E. M. F. by means of a resistance in series with the motor, or by varying the field strength. The field strength, in the case of a series motor, may be varied by cutting in or out a number of the field turns or by shunting a portion of the current around the field. (Art. 3800.)

(1727) By reversing the direction of the current either through the armature or through the field. Care must be taken not to reverse both when changing the connections, otherwise the direction of rotation will remain unaltered. (Arts. 3813 and 3814.)

(1728) A motor may be made to give constant speed regulation by providing the field with a number of series turns which are connected so as to oppose the shunt turns. This secures constant speed, because the field is weakened slightly as the load is applied, thus making the armature

keep up its speed instead of falling off in proportion to the lowering of the counter E. M. F. (Art. **3804**.)

(1729) (a) The cross-magnetization distorts the field, shifting it backwards as regards the direction of rotation. (See Fig. 1412.)

(b) The shifting of the field has a tendency to move the non-sparking point of the brushes backwards instead of forwards, as in the case of a dynamo. (Art. **3789**.)

(1730) (a) The armature back ampere-turns tend to demagnetize the field, as shown in Fig. 1413.

(b) In order to keep the speed constant, the field must be weakened slightly as the load is increased. The back ampere-turns help to bring about the necessary reduction in field strength, and consequently aid in keeping the speed constant. (Art. **3790**.)

(1731) By referring to Fig. 1428, we find that the electrical efficiency of a 30 H. P. motor should be about .925, and the efficiency of conversion about .92. The commercial efficiency will therefore be about $.92 \times .925 = .851$. The total input at full load will therefore be $\frac{30 \times 746}{.851} = 26,300$ watts,

nearly. The total current input will be $\frac{26,300}{500} = 52.6$ amperes.

Since the field and armature are connected in series, both must be designed for 52.6 amperes. The total electrical energy active in the armature is $\frac{30 \times 746}{.92} =$

24,326 watts. The E. M. F. which the armature must generate at full load must then be $\frac{24,326}{52.6} = 462.5$ volts, nearly.

The 37.5 volts difference between this E. M. F. and that of the mains represents the drop through the series field and the armature. The dynamo must then have a current output of 52.6 amperes and generate 462.5 volts when running at a speed of 800 R. P. M. (Arts. **3817** and **3818**.)

(1732) Cast steel is used on account of its good magnetic qualities and mechanical strength. These qualities enable a motor to be made light compared with its output, which is an important consideration in street-railway work. (Art. 3830.)

(1733) (a) If no regulating device were used, the torque acting on the armature would be the same for all loads, because the current is automatically kept constant by the dynamo. The result is that the motor slows down when loaded and races if the load is thrown off.

(b) The voltage across the terminals rises as the load is increased. As the output increases the input must also increase, and since the current is constant, it follows that the potential across the terminals must increase. (Arts. 3802 and 3803.)

(1734) Railway motors are usually of the four-pole type, and by using a two-circuit winding two brushes only are needed. This does away with the necessity of having two brushes on the under side of the commutator, where they would be hard to get at. Two-circuit windings do not become unbalanced electrically like multiple-circuit windings in case the field should become stronger on one side than the other, due to the air-gap becoming shorter on that side. (Art. 3833.)

(1735) By reversing the connections between the armature and field so as to reverse the direction of the current through either the armature or field, but not through both. Reversing the line connections would not reverse the direction of rotation. (Art. 3815.)

(1736) To keep down the bad effects of armature reaction and make the motor give good speed regulation. If the field is very strong compared with the armature, the shifting of the brushes from no load to full load will be very slight, and if fairly thick carbon brushes are used, the motor may be operated at all loads, with its brushes fixed in position and without sparking. (Art. 3789.)

(1737) This will be seen by referring to Fig. 1410. As the conductor moves down in the direction of the arrow, it is readily seen that the E. M. F. induced in it must be directed *up through the paper*. The *current which is causing the wire to move* is flowing down through the paper ; in other words, the E. M. F. is opposed to the current. (Art. 3782.)

(1738) If the field circuit were broken while the motor was running, the counter E. M. F. would at once become nearly zero, and a very large current would flow through the armature, the effect being much the same as if the armature were thrown across the mains without any resistance at starting. If the field circuit were broken in this way, the armature would be burned out unless protected by fuses, and in any event it is probable that the commutator would be more or less burned. (Art. 3795.)

(1739) Because when run as motors these machines have their fields excited from the mains, and their field magnetization is therefore practically constant, no matter what the load may be. When they are run as dynamos, they excite their own fields, and every falling off in voltage generated causes a corresponding falling off in the field excitation, thus causing poor regulation for constant potential. (Art. 3816.)

(1740) In order to secure a good starting effort. If the current is supplied to both at the same instant, a large current will flow through the armature and only a very small current through the high-resistance field, the consequence being that there is no field present for the armature current to react on and the starting torque is very small. (Art. 3807.)

(1741) By short-circuiting it. Breaking the circuit would cut off the current from the whole circuit, and besides would be a dangerous operation with such high-tension dynamos as are used to operate arc circuits. (Art. 3811.)

(1742) Because starting rheostats are designed to carry the current only for a short time, and if the current is allowed

to flow through them continuously they will be burned out. (Art. 3806.)

(1743) (a) The electrical efficiency of a motor is the ratio of the total electrical power developed in the armature to the total electrical power supplied from the mains.

(b) If the armature resistance is high, the loss in the armature will be large and the electrical efficiency correspondingly low. A high-resistance armature causes bad speed regulation, as the higher the armature resistance the more the counter E. M. F. and speed must drop when the motor is loaded. (Art. 3785.)

(1744) The commercial efficiency is equal to the product of the electrical efficiency and the efficiency of conversion; hence, if the electrical efficiency is .90 and the efficiency of conversion .85, the commercial efficiency must be .765, or 76.5%. (Art. 3785.)

(1745) (a) The torque is the turning moment or twisting effort exerted on the armature by the reaction of the current in the armature conductors on the field.

(b) This is shown by formula 605. The field excitation N is independent of the speed; hence, for a given current C_m , the torque is given by formula 605, and the speed does not enter into the equation. (Art. 3787.)

(1746) (a) The principal sources of loss are the same as those in a dynamo; namely, C^2R losses in field and armature, hysteresis and eddy-current losses in the armature core, and frictional losses.

(b) The output is limited by the same factors which limit the output of a dynamo, the heating effect in the armature being the principal limiting factor.

(1747) If the motor were short-circuited after being disconnected from the mains, it would be brought to a sudden standstill, because it would act as a dynamo and send current through the switch B . The energy stored up by the momentum of the armature would be rapidly used up,

and the machine would soon stop. It will easily be seen that the motor will act as a dynamo if it is remembered that all the time the motor is working, its E. M. F. is opposed to that of the mains or trying to send a current opposite to that from the mains. The result is that as soon as the main E. M. F. is removed and the switch *B* closed, the motor E. M. F. is able to set up a current, thus making the motor act as a dynamo.

THEORY OF ALTERNATING-CURRENT APPARATUS.

(QUESTIONS 1748-1840.)

(1748) (a) The essential difference between an alternating current and a direct current is that the former is constantly reversing the direction of its flow, whereas the latter flows uniformly in the same direction. The alternating current passes through a number of positive and negative values during each complete cycle, and this process is repeated over and over. (Arts. 3838 to 3840.)

(b) The frequency is the number of complete cycles which the current passes through in 1 second. (Art. 3842.)

(1749) (a) Two alternating currents differ in phase, or are out of phase, when both do not pass through similar values at the same instant. If, for instance, one current did not rise to its maximum value till, say, a fraction of a second after the other had reached its maximum, the two currents would be out of phase. (Art. 3854.)

(b) Two currents are in quadrature when one lags behind the other by just $\frac{1}{4}$ of a period; that is, when one current is at its maximum value, the other is just passing through zero. In this case the angle of lag is 90° . (Art. 3860.)

(c) When two currents are in opposition they are directly opposed to each other; i. e., when one is at a positive maximum, the other is at a negative maximum. It follows, therefore, that when two currents are in opposition, the angle of phase difference must be 180° . (Art. 3860.)

(1750) (a) The inductance of a coil or circuit is that quantity which multiplied by the current and 10^9 and divided

by the number of turns in the circuit will give the total number of magnetic lines threading the circuit when the given current is flowing. The inductance L , or coefficient of self-induction, is a measure of the ability which a coil has of setting up lines through itself and, hence, of the ability of the coil to produce a counter E. M. F. of self-induction.

(*b*) Anything which makes it easier for a coil to set up lines around itself increases the inductance L . Surrounding a coil with iron provides a very good path for the magnetic lines, hence the number of lines which the coil sets up is greatly increased, thus making L large. (Arts. 3874 to 3876.)

(1751) (*a*) A transformer is a device for changing an alternating current at one voltage to a current at another voltage. They are used extensively in connection with lighting and power transmission plants for transforming down from high voltages used on the line. They are also used in connection with some power plants for increasing the pressure supplied by the alternators to that desired for transmission. (Art. 4000.)

(*b*) No; a transformer can not be used in a direct-current circuit. The E. M. F. induced in the secondary of a transformer is produced by the alternating magnetic flux which passes through it. In order to produce an alternating magnetic flux it is necessary to have an alternating current in the primary, consequently an ordinary static transformer would not operate on a direct-current circuit.

(*c*) A transformer always consists of three essential parts, primary coil, secondary coil, and laminated iron core, the arrangement of these parts being shown in Figs. 1548 to 1551. (Art. 4019.)

(1752) A three-phase alternating-current system is one in which three alternating currents are employed which differ in phase by $\frac{1}{3}$ of a complete period, or 120° . A three-phase circuit is simply three single-phase circuits, the currents in which differ in phase as described. (Art. 3862.)

(1753) (a) A rotary transformer is a machine for changing alternating current to direct or the reverse.

(b) The principle of such machines is explained in Arts. 4050 and 4051, and the connections for a two-pole two-phase machine would be as shown in Fig. 1577.

(1754) No. In a single-phase rotary transformer with a single armature winding, the ratio of transformation is fixed, the relation being

$$\bar{E} = .707 V,$$

where V is the direct-current voltage and \bar{E} the alternating voltage. If \bar{E} were 50 volts, V would be $\frac{50}{.707} = 70.7$ volts instead of 100. (Art. 4051.)

(1755) (a) By the capacity of a line or circuit is meant that property which enables it to hold a certain charge or quantity of electricity. (See Art. 3894.)

(b) The unit of capacity is the farad, and it may be defined as that capacity which will take up a charge of .1 coulomb (1 ampere for 1 second) with a rise of pressure of 1 volt. (Art. 3899.) The microfarad is the unit usually employed for expressing capacities.

(c) If the two capacities are connected in parallel, the combined capacity is simply the sum of the two, or 30 microfarads. (Art. 3896.)

(1756) Since the alternator has 12 poles, the angular distance from the center of one pole-piece to the center of the next will be $\frac{360^\circ}{12} = 30^\circ$. The distance from the center of one pole to the center of the next of the same polarity corresponds to 360° , and since the coils are to be displaced 120° , the actual angular displacement will be one-third of the angular distance between the centers of two poles of the same polarity. The coils must then be displaced $\frac{1}{3} \times 30 \times 2$ or 20° , since $30 \times 2 = 60^\circ$ is the distance from the center of one pole to the center of the next of the *same polarity*. (Art. 3950.)

rent in the circuit. The impedance is always equal to $\sqrt{\text{resistance}^2 + \text{reactance}^2}$. In other words, the impedance is the *apparent* resistance which the circuit offers to the flow of the current. (Arts. **3889** and **3890**.)

(*b*) Ohm's law for alternating-current circuits takes the form:

$$\text{Current} = \frac{\text{electromotive force}}{\text{impedance}}. \quad (\text{Art. } \mathbf{3891}.)$$

(**1761**) The resistance of the circuit is negligible, hence all the pressure supplied must be used up in overcoming the reactance. The reactance is equal to $2 \pi n L = 2 \times 3.14 \times 60 \times .5 = 188.4$ ohms, and the E. M. F. necessary to overcome the reactance is equal to the product of the reactance and the current. The E. M. F. \bar{E} , therefore, which must be supplied by the alternator is

$$\bar{E} = 2 \pi n L \bar{C} = 188.4 \times 5 = 942.0 \text{ volts.} \quad (\text{Art. } \mathbf{3886}.)$$

(**1762**) (*a*) In the **Y** winding, one end of each of the windings is brought to a common connection, and the other ends are carried to the three collector rings. In the Δ method, the three windings are connected up into a closed circuit and the collector rings are attached to the points where the different phases join. (Arts. **3986** and **3987**.)

(*b*) No; the output is not affected by changing from one scheme of connection to the other, because if the current output is increased by changing from **Y** to Δ , the voltage is decreased in the same ratio, and, hence, the watts output is not altered. (Art. **3995**.)

(**1763**) (*a*) The effective value of an alternating current is the expression for that value of the current which would produce the same power or heating effect in a circuit as a continuous current of the same amount. (Art. **3866**.)

(*b*) The effective value is equal to .707 times the maximum value, or is equal to the maximum value divided by $\sqrt{2}$; hence, if 150 amperes is the maximum which the current reaches, the effective value of the same current would

be $\frac{150}{\sqrt{2}} = 106$ amperes. It follows, therefore, that if a continuous current of 106 amperes were sent through the resistance, the same amount of heat would be produced as by an alternating current having a maximum value of 150 amperes. (Art. 3867.)

(1764) Each transformer has 400 turns on its primary and 50 on its secondary, therefore the ratio of transformation is 8. Since the coils are connected up Δ to the primary, the pressure across each primary coil must be 1,000 volts; consequently, the pressure induced in each secondary will be $\frac{1000}{8} = 125$ volts. In other words, the voltage per phase in the secondary is 125, and since the three phases are connected up Y , the voltage between the secondary lines will be $125 \times \sqrt{3} = 125 \times 1.732 = 216.5$ volts. Ans.

(Art. 4026.)

(1765) (a) The efficiency of a transformer is the ratio of the useful watts obtained from the secondary to the watts supplied to the primary; or, efficiency = $\frac{\text{output}}{\text{input}}$. The efficiency is always less than 1.

(b) $2.2 \text{ H. P.} = 2.2 \times 746 = 1,641$ watts = useful output.
 Input = 1,800 watts; hence, efficiency = $\frac{1,641}{1,800} = .912$, or the transformer gives out 91.2% of the energy supplied to it. (Art. 4000.)

(1766) In order to induce an E. M. F. such as that in the secondary of a transformer, all that it is necessary to have is a coil so arranged as to thread a varying magnetic flux. If the flux were fixed, as it is in dynamos, it would be necessary to move the coils in order to set up an E. M. F. In a transformer, however, the flux is made to vary by the alternating current in the primary, hence it is not necessary to move the secondary in order to make it cut lines of force. In other words, the magnetic flux is constantly changing,

and for this reason it is not necessary that any of the transformer coils should move.

(1767) (a) If an alternating-current circuit contains inductance, the current flowing will not vary, or rise up and down, in unison with the E. M. F., but will lag behind by a certain fraction of a period. The part of a complete cycle by which the current lags is usually denoted by an angle which represents the amount of lag. For example, one complete cycle is equivalent to 360° ; hence, if the angle of lag were said to be 90° , it would mean that the current came to its maximum just $\frac{1}{4}$ of a period behind the E. M. F. If the angle of lag were 60° , the current would be behind the E. M. F. by $\frac{1}{3}$ of a period. (Arts. 3854 and 3855.)

(b) The angle of lag may be obtained from the expression

$$\tan \Phi = \frac{2 \pi n L}{R},$$

as explained in Art. 3892, so that if the frequency, inductance, and resistance for any given circuit are known, the angle of lag can at once be estimated. No commercial instrument has yet been made which will measure the angle of lag, so it always has to be calculated.

(1768) (a) If the frequency is 60 and the inductance is .2 henry, the reactance = $2 \pi n L = 2 \times 3.14 \times 60 \times .2 = 75.36$ ohms.

The resistance = 12 ohms ; hence,

$$\text{impedance} = \sqrt{R^2 + (2 \pi n L)^2} = \sqrt{144 + 5,679} = 76.3 \text{ ohms.}$$

$$\text{Current} = \frac{\text{E. M. F.}}{\text{impedance}} = \frac{500}{76.3} = 6.55 \text{ amperes. Ans.}$$

$$(b) \text{ Tangent of angle of lag} = \frac{2 \pi n L}{R}.$$

$$\text{Tan } \Phi = \frac{75.3}{12} = 6.28 \text{ and } \Phi = 80^\circ 57'. \text{ Ans.}$$

(1769) (a) If the resistance had been negligible, we would have

$$\text{current} = \frac{\text{E. M. F.}}{\sqrt{0^2 + (2\pi nL)^2}} \text{ or current} = \frac{500}{75.36} = 6.63 \text{ amperes.}$$

Ans.

$$(b) \quad \text{Tan } \Phi = \frac{2\pi nL}{R} = \frac{75.3}{0} = \infty;$$

hence, $\Phi = \text{angle of lag} = 90^\circ.$ Ans.

In this problem and the preceding one the reactance is large compared with the resistance; hence, removing the resistance does not affect the value of the current very much.

(1770) (a) An alternator may be compounded by winding the field spools with a second set of coils which are connected in series with the line. The current in these coils therefore increases with the load and thus strengthens the field-magnets. The initial magnetization is supplied by means of a set of coils excited from a separate direct-current dynamo. (Art. 3966.)

(b) The use and action of the rectifier is explained in Art. 3968. Its action is to keep changing the connections between the compound field winding and the circuit so that the current in the field coils will always be in the same direction.

(c) The number of sections in the rectifier must be the same as the number of poles on the alternator.

(1771) (a) A non-inductive resistance is one which is incapable of setting up lines of force around itself, and hence has no inductance.

(b) No; the current is in phase with the E. M. F. when flowing in a non-inductive resistance. A non-inductive resistance simply retards the flow of the current in the same way that a resistance prevents the flow of a continuous current. If the resistance has no self-induction, there can be no induced E. M. F. set up to prevent the current rising and falling in step with the E. M. F.; hence, in such a resistance the current does not lag behind the E. M. F.

(c) Water resistances and incandescent lamps are practically non-inductive. (Art. 3872.)

(1772) (a) Iron cores are always used in transformers to provide a path of low magnetic resistance for the lines threading the primary and secondary coils.

(b) If no core were used, the lines would have to be set up through the air, which offers a high resistance to the flow of the lines; consequently it would require a very large magnetizing current to set up the flux. The magnetizing current would, therefore, be enormously increased by removing the core and the transformer would be practically inoperative. (Art. 4003.)

(1773) Every time the armature of an alternator turns through an angle equal to that from one pole to the next of the same polarity, the E. M. F. passes through one complete cycle. Hence, in one revolution the E. M. F. will pass through as many cycles as there are pairs of poles, and if s = rev. per second and P = number of poles, we have

$$\text{frequency} = \frac{P}{2}s. \quad (\text{Art. 3950.})$$

(1774) The current coil of a wattmeter is of very low resistance, and if connected across the mains instead of in series with them, a very large current would result, which would be almost certain to burn out the instrument unless protected by fuses. (Art. 3945.)

(1775) In such a winding the E. M. F.'s induced in the coils under the N poles will be opposite in direction to the E. M. F.'s in the coils under the S poles. In order, then, that the E. M. F.'s may add up properly, the connections of every other coil must be reversed, as shown in Figs. 1512 and 1513. The student should read Art. 3954 in connection with this question. Fig. 1513 is the winding diagram for an armature of this type, and by following the arrow-heads it will easily be seen that the connections of every other coil must be reversed.

(1776) The capacity $J = 10$ microfarads = .000010 farad. Frequency = 125; resistance = 100 ohms; capacity reactance

$$= \frac{1}{2\pi nJ} = \frac{1,000,000}{2 \times 3.14 \times 125 \times 10} = 127.4 \text{ ohms, nearly.}$$

$$\text{Impedance} = \sqrt{R^2 + \left(\frac{1}{2\pi nJ}\right)^2} = \sqrt{100^2 + (127.4)^2} = \sqrt{26,230} = 162, \text{ nearly.}$$

$$\bar{C} = \frac{\bar{E}}{\text{impedance}} = \frac{1,000}{162} = 6.17 \text{ amperes. Ans.}$$

In substituting in the expression $\frac{1}{2\pi nJ}$, care must be taken to have J expressed in farads, not microfarads.

(1777) (a) If the transformers were connected in the manner indicated, they would be burned out, unless protected by fuses. The figure shows the two secondaries connected up in series into a closed circuit, so that the combined E. M. F. of the two secondaries would set up a large current and thus burn out the coils.

(b) The trouble could be remedied by connecting the transformers as shown in Fig. 107, a being connected to a' , and b to b' .

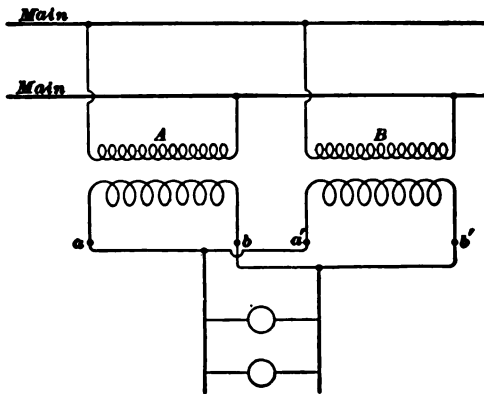

FIG. 107.

(1778) (a) It has been shown in Art. 3862, and it can also be seen by referring to Fig. 1448, that, in a three-phase

system, when the current in one line is at its maximum value, the currents in the other two lines are one-half as great and in the opposite direction. Hence, if the current in one line is at its maximum value of 150 amperes, the currents in the other two lines at the same instant must each be 75 amperes.

(*b*) The current of 75 amperes in these two lines will be flowing in a direction opposite to that of the current in the first-mentioned line.

(1779) (*a*) If the alternator runs at a speed of 300 R. P. M., the rev. per second = 5. There are 20 poles, or 10 pairs of poles; hence, by formula **646**,

$$\text{frequency} = p \times s = 10 \times 5 = 50 \text{ cycles per second.}$$

(*b*) Since the frequency is 50, it follows that the current from such a machine will pass through one complete cycle of values in $\frac{1}{50}$ second.

(1780) If the inductance is very large as compared with the resistance, nearly all the E. M. F. required to set up the current through the circuit will be used up in overcoming the inductance, and will, therefore, be almost 90° ahead of the current in phase. Consequently, in such a circuit the current will lag very nearly 90° behind the E. M. F. (Art. **3922**.)

(1781) If the armature of an alternator has high self-induction, a large part of the E. M. F. generated may be used up in forcing the current through the armature itself, leaving only a small terminal E. M. F. available at the collector rings. If the inductance were very high, there might be such a falling off in terminal pressure that the maximum output which could be taken from the machine might be less than that which the armature could safely deliver without overheating, and the machine would not deliver the power which it was really capable of supplying. (Art. **3930**.)

(1782) (a) The resistance of the circuit is considered to be zero; hence the impedance $\sqrt{R^2 + \left(\frac{1}{2\pi nJ}\right)^2}$ becomes $\frac{1}{2\pi nJ}$, and

$$\bar{C} = \frac{\bar{E}}{\frac{1}{2\pi nJ}} = 2\pi nJ\bar{E}.$$

Frequency = $n = 125$ cycles per sec.

Current = $\bar{C} = 2$ amperes.

$J = \frac{\bar{C}}{2\pi n\bar{E}}$ farads = $\frac{2 \times 1,000,000}{2 \times 3.14 \times 125 \times 1,000}$ microfarads = 2.54 microfarads. Ans.

(b) Since there is no resistance in the circuit, all the E. M. F. is used in overcoming that of the condenser, and the current is at right angles to the E. M. F. and 90° ahead of it. The current is therefore wattless, and no energy is being expended in the circuit. The number of watts expended is therefore zero.

(1783) (a) A synchronous motor is one which runs in step or synchronism with the alternator driving it. (Art. 4033.)

(b) A single-phase synchronous motor will not start up of its own accord because, when it is standing still and a rapidly reversing current is sent through its armature, there is an effort exerted tending to make it turn first in one direction and then in the other, the consequence being that the armature does not start up.

(c) If the motor be run up to speed, the coils move past the poles just as the current in the coils reverses; consequently the torque acting on the armature is always in the same direction and the motor continues running. (Art. 4034.)

(1784) The counter E. M. F. set up in a coil through which a flux N is made to vary is given by formula 617, Art. 3882.

$$\bar{E} = \frac{4.44 N T n}{10^8}.$$

The magnetic flux N is in this case 200,000 lines; the frequency $n = 125$; the required counter E. M. F. $\bar{E} = 50$ volts.

Hence we have

$$T = \frac{\bar{E} \times 10^8}{4.44 n N} = \frac{50 \times 10^8}{4.44 \times 125 \times 200,000} = 45 \text{ turns. Ans.}$$

(1785) (a) The effect of resistance in the primary and secondary coils of a transformer is to cause a loss in them due to the heating, thus making the efficiency lower than it would otherwise be.

(b) The resistance in the coils also causes a falling off in the secondary voltage when the transformer is loaded, thereby making the regulation poor. (Art. 4014.)

(1786) (a) The henry is the unit of self-induction, and a coil of T turns would have an inductance of 1 henry if it set up a flux of $\frac{10^9}{T}$ lines through itself when the current in it was 1 ampere. Or it might be defined as that quantity which multiplied by the current and 10^9 gives the product of the flux and the number of turns.

(b) For example, if a coil of 50 turns had an inductance of 5 henrys it would mean that, with a current of 1 ampere flowing through the coil, there would be 10,000,000 lines passing through the center of the coil, since

$$\text{flux} \times 50 = 5 \times \text{current} \times 10^9,$$

or $\text{flux} = \frac{5 \times 1 \times 100,000,000}{50} = 10,000,000 \text{ lines.}$
(Art. 3875.)

(1787) If the armature has a high inductance, the greater part of the E. M. F. generated will be used up in

forcing the current through the armature itself. The result is that the E. M. F. is not able to set up a very large current when the machine is short-circuited, and, consequently, no damage results, as would be the case with a direct-current machine. (Art. 3963.)

(1788) The great advantage of polyphase over single-phase synchronous motors is that the former will start of their own accord and run up to synchronism, whereas the latter have to be started up from some outside source of power. (Art. 4034.)

(1789) The chief advantage which induction motors possess over synchronous motors is that they will start with a strong torque, and will therefore start up under load, whereas synchronous motors will not start on anything but a light load. Induction motors also have the advantage of not requiring, under ordinary circumstances, any brushes or collector rings. (Art. 4038.)

(1790) The essential parts of a polyphase induction motor are the field, or primary, into which currents from the line are led, and the armature, or secondary, in which currents are induced by the moving field set up by the primary. (Art. 4039.) The method of constructing and winding the field and armature is such as that described in Arts. 4040 to 4042.

(1791) (a) Line pressure or impressed E. M. F. = 1,000 volts. Frequency = 60 cycles per sec. Self-induction = .3 henry. Resistance = 150 ohms. Capacity = 15 microfarads = .000015 farad.

In such a circuit as this the current will of course be equal to $\frac{\text{impressed E. M. F.}}{\text{impedance}}$. This circuit contains resistance, self-induction, and capacity; hence, the

$$\text{impedance} = \sqrt{R^2 + \left(2\pi nL - \frac{1}{2\pi nC}\right)^2}. \quad \text{See Art. 3910.}$$

The reactance due to self-induction = $2\pi nL = 2\pi \times 60 \times .3 = 113$ ohms.

The reactance due to capacity =

$$\frac{1}{2\pi nJ} = \frac{1,000,000}{2 \times 3.14 \times 60 \times 15} = 176.9 \text{ ohms.}$$

$$\left(2\pi nL - \frac{1}{2\pi nJ}\right) = 113 - 176.9 = -63.9 \text{ ohms.}$$

Then, the impedance =

$$\sqrt{150^2 + (-63.9)^2} = \sqrt{22,500 + 4,083} = \sqrt{26,583} = 163 \text{ ohms.}$$

Hence, current = $\frac{1,000}{163} = 6.13$ amperes. Ans.

(b) Since the capacity reactance is greater than the reactance due to self-induction, it follows that the component of the E. M. F. at right angles to the current is 90° behind the current, as shown in Fig. 108. The impressed

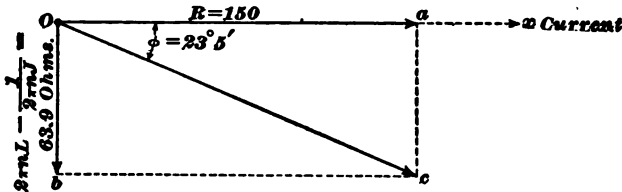

FIG. 108.

E. M. F. is therefore in the direction of Oc , and the angle by which the current leads the E. M. F. is such that

$$\tan \Phi = \frac{2\pi nL - \frac{1}{2\pi nJ}}{R} = \frac{63.9}{150} = .426$$

and $\Phi = 23^\circ 5'$. Ans.

(c) The watts expended = $\bar{C}\bar{E} \cos \Phi = 1,000 \times 6.13 \times .919 = 5,633$ watts. Ans.

(1792) (a) The power factor is that quantity by which the apparent watts expended in an alternating-current circuit must be multiplied to give the true watts. It is equal numerically to the cosine of the angle of lag between

the current and E. M. F., and the more nearly the current and E. M. F. are in phase with each other the larger is the value of the power factor. (Art. 3926.)

(b) When the current and E. M. F. are exactly in phase, the power factor has its greatest value, $\Phi = 0$ and $\cos \Phi = 1$. In this case the apparent watts, or volts \times amperes, are equal to the true watts. (Art. 3927.)

(1793) (a) The best method of measuring power in an alternating-current circuit is by the use of a wattmeter, the most reliable type of which is the Siemens dynamometer.

(b) A description of this instrument will be found by referring to Art. 3944.

(c) A wattmeter should be connected with its current coil in series with the circuit in which the power is to be

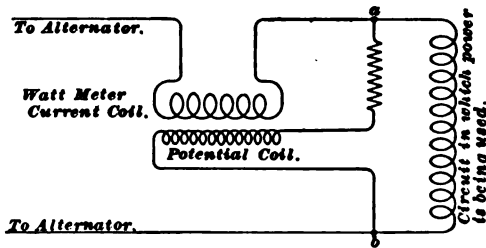

FIG. 109.

measured. The fine wire coil should be connected across the terminals of the circuit *a b*, as shown in Fig. 109.

(1794) If a transformer were connected with its primary across continuous-current mains, no counter E. M. F. would be set up in the primary, because the current would not be changing. The primary would, therefore, not be able to choke back the current, and a rush of current would take place which would be limited only by the resistance of the primary coil; consequently a current would flow which would probably be great enough to burn out the coil unless it were protected by fuses.

(1795) The armature of an induction motor does not revolve quite so fast as the magnetic field set up by the currents in the field winding; consequently there is a cutting

of magnetic lines by the armature conductors, which sets up an electromotive force in them. Since the armature coils, or conductors, are connected up into closed circuits, this induced E. M. F. sets up currents which react on the field and so produce the motion. (Art. 4042.)

(1796) If the secondary were to become short-circuited, it would be equivalent to connecting it to a circuit of very low resistance. The consequence would be a heavy rush of current through the secondary coil, which would allow a correspondingly large current to flow in the primary.

(1797) The speed of an induction motor may be regulated by inserting an adjustable resistance in series with the secondary winding. The resistance limits the amount of current which flows in the secondary coils, and the torque may be increased or diminished, as desired. This arrangement necessitates the use of collector rings and brushes, as a resistance for regulating purposes to be used continually could not very well be placed within the armature itself on account of the heat which it would develop. (Art. 4044.)

(1798) (a) Magnetic leakage is caused by the flux which the secondary tends to set up being opposed to that set up by the primary. The two opposing magnetic fluxes cause lines to leak between the coils, as shown in Art. 4015, and this leakage effect increases as the load on the secondary increases.

(b) The effect of magnetic leakage is to cause a drop in the secondary voltage, because all the magnetic lines do not get through the secondary.

(c) The effect of magnetic leakage may be largely reduced by so arranging the coils that there is little chance for magnetic lines to leak between them. This may be accomplished by placing the coils one over the other, or by winding the primary and secondary in sections and interleaving them. (Art. 4016.)

(1799) (a) The current in the armature *increases* as the load is applied in very much the same way that the

current in the armature of an ordinary shunt-wound dynamo increases with increase of load.

(*b*) The change in the secondary current is brought about by the slight slowing down in speed of the armature. This slowing down causes the relative motion between the revolving armature and field to become greater, thus making the conductors cut more lines of force per second and increasing the voltage induced in them. The increase of voltage is accompanied by a corresponding increase of current, which causes the motor to develop a greater torque and thus adjust itself to the new condition of load. (Art. 4042.)

(1800) The winding suitable for the field of a three-phase induction motor would be similar to that used on a three-phase alternator armature. The windings used on polyphase induction-motor fields are usually distributed windings consisting of 2 or 3 coils per pole per phase. (Art. 4045.)

(1801) If the motor be loaded too heavily, the armature will be retarded through so great an angle that the motor will slip out of step with the alternator driving it, and will rapidly come to a standstill. (Art. 4035.)

(1802) (*a*) If 25 amperes is the effective value, the maximum value will be $25\sqrt{2}$, because the effective value

$$= \frac{\text{max. value}}{\sqrt{2}}.$$

$$25\sqrt{2} = 35.36 \text{ amperes. Ans.}$$

(*b*) Effective value = 1.11 average value; hence, average value = $\frac{25}{1.11} = 22.52$ amperes. (Art. 3867.)

(1803) If the effective voltage of the machine is 2,000, the maximum pressure which the insulation of the armature is subjected to will be the maximum pressure corresponding to 2,000 effective volts; that is, $2,000\sqrt{2}$ or $2,000 \times 1.414 = 2,828$ volts. (Art. 3867.)

(1804) (a) If the alternator has 10 poles, or 5 pairs of poles, and runs at the rate of 1,500 R. P. M., its frequency will be, by formula 646, $n = 5 \times \frac{1500}{60} = 125$ cycles per second. (Art. 3956.) Ans.

(b) The voltage between the collector rings at no load is given by formula 617,

$$\bar{E} = \frac{4.44 N T n}{10^8}.$$

N is the magnetic flux from one pole and equals 900,000; T is the number of turns connected in series and is equal to $\frac{2000}{5} = 400$. Hence,

$$\bar{E} = \frac{4.44 \times 900,000 \times 125 \times 400}{100,000,000} = 1,998 \text{ volts.} \quad (\text{Art. 3960.}) \text{ Ans.}$$

(1805) If an E. M. F. E be applied to a condenser of J farads, the quantity of charge which the condenser will take up will be $Q = J E$ coulombs. This follows from the definition of a farad. In this case, since $J = 20$ microfarads, and $E = 1,000$ volts, $Q = .000020 \times 1,000 = .020$ coulomb. But coulombs = amperes \times seconds, or $Q = C t$, where C is the average current.

$$\text{Then } Q = .1 \times t, \text{ and } t = \frac{.020}{.1} = .2 \text{ second.}$$

The current of $\frac{1}{5}$ of an ampere would, therefore, have to flow for $\frac{1}{5}$ second to charge the condenser up to a potential of 1,000 volts. (Arts. 3900 and 3905.)

(1806) If the motor has 6 poles, or 3 pairs of poles, we must have, by formula 647, the relation $s = \frac{n}{p} = \frac{60}{3} = 20$ rev. per second. The speed is therefore 20 revolutions per second, or 1,200 rev. per minute, when the machine is not loaded, because at no load an induction motor should run almost exactly in synchronism with the alternator driving it.

(1807) The current flowing through a synchronous motor armature varies in proportion to the load which the machine is carrying by virtue of the change in phase relation between the counter E. M. F. of the motor and the E. M. F. supplied by the alternator driving it. When a load is thrown on the machine, the angular position of the motor armature is displaced a little from the angular position occupied at the same instant by the armature of the alternator. The E. M. F. of the motor, therefore, lags a little behind that of the alternator and thus allows a current to pass between the two machines. (Art. 4035.)

(1808) The general effect of inductance is to increase the size of wire necessary to transmit a given amount of power beyond what would be required if no inductance were present. In other words, it requires some E. M. F. to overcome the inductance as well as the resistance, and if the total amount of drop in the line is fixed, it is evident that the wire has to be made just so much larger to keep the total drop within the specified limits. If the load on the line is inductive, the current for a given amount of power is also increased, and if the drop were to be kept the same, the wire would have to be larger than would be necessary if the load were non-inductive. (Art. 3934.)

(1809) (a) The reactance due to self-induction is greater than that due to capacity; hence the effect of the self-induction will predominate and the current will lag behind the E. M. F.

(b) The resultant reactance is $20 - 15 = 5$ ohms, and the resistance being 10 ohms, the tangent of the angle of lag is $\frac{5}{10} = .5$;

or, $\tan \Phi = .5$,
and the angle of lag $\Phi = 26^\circ 34'$.

(1810) The field of an alternator which is not provided with compound coils may be adjusted by having an adjustable rheostat either in the field circuit of the alternator or in the shunt field circuit of the exciter, or in both, as shown

in Fig. 1521. It is customary to have both rheostats, because a number of alternators can then be excited from one exciter and their field currents adjusted independently. This could not be done if the rheostat in the alternator field circuit were not used. By varying these two rheostats the strength of field and, hence, the voltage of the alternator may be easily adjusted. (Art. 3966.)

(1811) If the secondary of the motor were of high resistance, there would have to be a considerable E. M. F. induced in the conductors to set up the current to produce the required torque. This means that a motor with such an armature would require a large slip, and there would consequently be a considerable falling off in speed from no load to full load. Such a motor, therefore, would give poor speed regulation. (Art. 4043.)

(1812) (a) The machine generates 1,100 volts with a Y-connected winding; hence the voltage generated in each phase must be, by formula 650,

$$\bar{\varepsilon} = \frac{1,100}{\sqrt{3}} = 635 \text{ volts.}$$

Consequently, if the armature be connected up Δ , the line voltage will be 635, because in this case the line voltage is the same as the voltage per phase. (Arts. 3992 and 3993.) Ans.

(b) If the current output were 50 amperes with the Y winding, it means that the wire on the armature must be capable of carrying 50 amperes, because the current per phase is the same as the line current in such a winding. (Art. 3990.) If the winding were connected Δ , the allowable line current would therefore be, by formula 654,

$$\bar{C} = 50 \times \sqrt{3} = 86.6 \text{ amp. Ans.}$$

(1813) (a) Eddy-current losses act in the same way as an additional current in the secondary; that is, they simply increase the primary current over and above what it should be for the given secondary current. This means that the eddy-current loss has to be made up for by taking additional

current from the line, thus lowering the efficiency of the transformer.

(b) Eddy-current losses may be reduced by laminating the core or building it up out of thin sheets of iron lightly insulated from each other. This breaks up the circuits in which the eddy currents tend to flow, and so prevents their generation. (Art. 4017.)

(1814) The automatic adjustment of a transformer to different conditions of load is brought about by the reaction of the primary and secondary coils. The magnetism produced by the secondary is opposed to that of the primary, and, consequently, the resulting magnetizing effect is zero. The result is that the magnetic flux remains practically constant at the value which is set up by the magnetizing current. (Art. 4009.) Since the flux remains constant, the E. M. F. induced in the secondary must also be constant. (Art. 4010.)

(1815) The current which a transformer takes from the line on open circuits has to set up the magnetic flux N and supply the energy necessary to make up for the core losses. The no-load current consists, therefore, of two components, one of which represents the magnetizing current (i. e., the current which is necessary to set up the flux N against the reluctance of the magnetic circuit) at right angles to the E. M. F., and therefore wattless, while the other component represents the current necessary to make up for the core losses, and is in phase with the E. M. F. The no-load current is the resultant of these components. If the magnetic reluctance and core losses are large, the no-load current will be large, and if the transformer is so designed as to make these quantities as small as possible without interfering with the design in other respects, the no-load current will be reduced to the smallest practical amount for any given case. (Art. 4011 and following.)

(1816) It is necessary that an induction motor should exert a strong torque when starting up under load, and in

order to do this, the reaction between the armature currents and the magnetic field must be strong. If no resistance were inserted in the secondary circuit, the armature currents would be very heavy and a strong torque would result, were it not for the fact that these strong secondary currents react on the primary so as to greatly weaken the field. In order, then, to have a strong starting torque, these secondary currents must be limited to a certain extent, and this is done by inserting a starting resistance. It would not do to leave this resistance in while the motor was running, as it would make the speed regulation bad and also lower the efficiency. The resistance is therefore arranged so that it may be cut out when the motor gets up to speed. (Art. 4043.)

(1817) (a) The slip of an induction motor is the difference in speed between the revolving armature and the revolving field set up by the primary windings. It is usually expressed in percent. of the synchronous speed. (Art. 4042.)

(b) If the armature were standing still, the slip would be the same as the speed of the revolving field or 100%.

(1818) If \bar{E} be the effective alternating voltage and V the direct-current voltage, we have, for a three-phase rotary transformer,

$$\bar{E} = .612 V;$$

hence, $\bar{E} = .612 \times 220 = 134.6$ volts. (Art. 4053.)

(1819) The E. M. F. to overcome self-induction is the equal and opposite of the E. M. F. of self-induction. The E. M. F. of self-induction is at right angles to the magnetization because it is equal to the rate of change of the magnetization. The magnetism is *changing* most rapidly when it is passing through its zero value; hence the induced E. M. F. is a maximum when the magnetization and current are zero. When the current is flowing *into the coil*, or in the *positive direction*, the *induced* E. M. F. is opposed to the current, or is in the negative direction; hence, the curves representing current and induced E. M. F. are as shown in

Fig. 1400. The E. M. F. to overcome self-induction is the equal and opposite of the induced E. M. F., and is therefore 90° ahead of the current in phase. (Arts. 3879 and 3880.)

(1820) (a) The hysteresis loss, like the eddy-current loss, causes an increase in the primary current over and above what would be called for by the current which the secondary is delivering. The hysteresis loss therefore lowers the efficiency, and also causes an increase in the power which the transformer consumes both on open circuit and when loaded.

(b) The hysteresis loss is caused by a kind of molecular friction in the iron, which causes a resistance to changes of magnetism. This resistance per unit volume of iron depends upon the quality of the iron and the density at which it is worked. It follows, therefore, that in order to keep down the hysteresis loss, iron of very good quality should be used and the core should be worked at a low magnetic density.

(c) In most lighting systems the line pressure is maintained all day, so that the iron losses are continual, whereas the copper loss is limited to the time that current is used. On this account iron losses should be kept very small. (Arts. 4017 and 4018.)

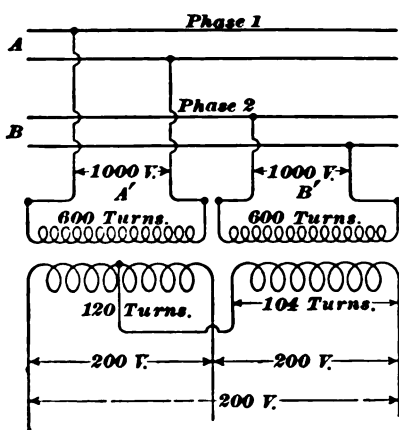

FIG. 110.

(1821) (a) The two transformers would be connected up as shown in Fig. 110.

(b) The primaries of the two transformers are each wound with 600 turns of wire, and are connected across the two-phase mains *A* and *B*, as shown. The secondary of *A'* must furnish 200 volts, and since the primary voltage is 1,000, the secondary turns must be $\frac{200}{1000} \times 600 = 120$.

The secondary turns on B' are $\frac{\sqrt{3}}{2}$ times as many as on A' , as shown in Art. 4027; hence, the turns on the secondary of $B' = \frac{\sqrt{3}}{2} \times 120 = 104$ turns, nearly.

(1822) Open slots are used because they do not give rise to such a high inductance in the armature and field. (Art. 4046.)

(1823) (a) The secondary of the transformer has to generate 30 volts when the primary pressure is 2,000 volts. There are 800 turns on the primary; hence there must be $\frac{30}{2,000} \times 800 = 12$ turns on the secondary.

(b) The cross-section of the wire must be $20 \times 1,000$, or 20,000 circular mils, which is about the cross-section of a No. 7 B. & S. wire.

(c) The output of the transformer would be 20 amperes at 30 volts = 600 watts. (Art. 4028.)

(1824) The pressure between each of the pairs of alternating-current mains is 400 volts. Hence the direct-current pressure will be $V = \frac{400}{.707} = 565.7$ volts. (Art. 4052.)

(1825) (a) The pressure furnished by the main winding will be, by formula 617,

$$\bar{E} = \frac{4.44 N T n}{10^8}$$

450 R. P. M. = $4\frac{5}{8}$ rev. per sec. There are 8 pairs of poles; hence, by formula 646, the frequency $n = 8 \times 4\frac{5}{8} = 60$ cycles per sec. There are 800 conductors, or 400 turns, on the armature, and $N = 1,250,000$.

Then, $\bar{E} = \frac{4.44 \times 1,250,000 \times 400 \times 60}{100,000,000} = 1,332$ volts. (Art. 3960.) Ans.

(b) The voltage generated in the teaser winding will be $\frac{1}{2}$ of that in the main winding, since the winding has $\frac{1}{2}$ the

number of turns on the main winding. The teaser voltage will therefore be $\frac{1,332}{4} = 333$ volts. The pressure between the middle and outer rings will be the resultant of $\frac{1,332}{2}$ volts and 333 volts at right angles to the main voltage. Hence, the voltage between outer and middle rings is

$$\sqrt{\left(\frac{1,332}{2}\right)^2 + 333^2} = 745 \text{ volts, nearly. (Art. 3998.)}$$

(1826.) (a) The primary coil must generate a back pressure of 2,000 volts; hence we have

$$\bar{E} = \frac{4.44 N T n}{10^8},$$

$$2,000 = \frac{4.44 \times 500,000 \times T \times 125}{10^8},$$

or $T = \frac{10^8 \times 2,000}{4.44 \times 500,000 \times 125} = 720$ turns, nearly. Ans.

(b) If the secondary voltage is to be 100, the ratio of transformation is 20, and the secondary turns, $\frac{1,400}{20} = 70$. (Art. 4003.) Ans.

(1827) (a) 20 H. P. delivered at the pulley is equal to 20×746 watts. The watts delivered are, then, 14,920. The commercial efficiency is .8; hence the *actual* watts which must be delivered to the motor will be $\frac{14,920}{.8} = 18,650$. The power factor is .85; hence the apparent watts which will be delivered will be $\frac{18,650}{.85} = 21,941$. This motor is supplied from three-phase mains at a voltage of 220; hence, since watts = $\bar{C} \bar{E} \sqrt{3}$ (Art. 3994), we have

$$21,941 = \bar{C} 220 \times \sqrt{3},$$

or $\bar{C} = \frac{21,941}{220 \times \sqrt{3}} = 57.6$ amp. Ans.

(b) If the field windings are connected up Δ , the current in them will be, by formula **655**,

$$\frac{\text{line current}}{\sqrt{3}} = \frac{57.6}{\sqrt{3}} = 33.2 \text{ amp. Ans.}$$

(1828) In order to obtain a pressure of 10,000 volts at the end of the line, the pressure at the station would have to be 11,000 volts when the full load was being transmitted. $200 \text{ H. P.} = 200 \times 746 = 149,200 \text{ watts.}$

Hence, $\text{current} = \frac{149,200}{10,000} = 14.92 \text{ amperes.}$

$$\text{Current} \times \text{impedance} = 1,000 \text{ volts,}$$

or $\text{impedance} = \frac{1,000}{14.92}.$

The line is 25 miles long, and the total length of wire is 50 miles; then,

$$\text{Impedance per mile} = \frac{1,000}{14.92} \times \frac{1}{50} = 1.34 \text{ ohms.}$$

The wires are strung 18 inches apart, and the frequency is 60. By referring to Table 114 (Art. **3934**) it is seen that the impedance per mile of No. 3 B. & S., 18 in. apart, frequency 60, is 1.223 ohms per mile, while that of No. 4 is 1.467. No. 3 wire would, therefore, probably be used. Ans.

(1829) (a) No; the magnetic flux remains practically constant, no matter what the load is, because the total magnetizing effect of the coils does not change with the load. (Art. **4009**.)

(b) The core losses also remain practically constant, as these depend upon the intensity of the magnetic flux, and must be constant as long as the flux remains the same. (Art. **4017**.)

(1830) If the current in the system is lagging, the power factor is less than 1, and the volt-amperes, or apparent watts, are greater than the true watts. For a given amount of power supplied and a fixed line voltage, it follows that the current required will be greater than if the power

factor were 1. The alternator *current* output is therefore reached before the machine is delivering the actual *power* or *watts* which it is capable of, and the useful output is thereby limited. (Art. 3930.)

(1831) The Cardew voltmeter, or, in fact, any alternating-current voltmeter, may be used to measure the current in a circuit by causing the current to flow through a known non-inductive resistance and measuring the drop through the resistance by means of the voltmeter. Since the current and E. M. F. in the non-inductive resistance are in phase, $\bar{C} = \frac{\bar{E}}{R}$, where \bar{C} is the current, and \bar{E} is the drop through the resistance R . That is, \bar{E} is the reading given by the voltmeter. (Art. 3937.)

(1832) Draw a line $O b$, Fig. 111, to scale, representing the current of 50 amperes. Since this is to be resolved into

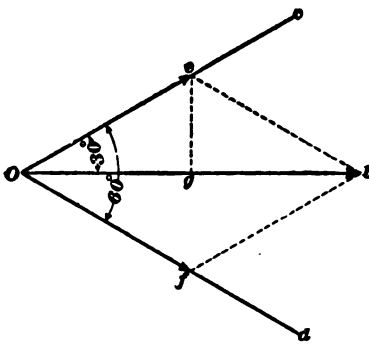

FIG. 111.

two equal currents differing 60° in phase, draw from O the lines $O c$ and $O d$, making angles of 30° with $O b$. From b draw the lines $b e$ and $b f$ parallel to $O d$ and $O c$ respectively. Then will $O e$ and $O f$ represent the two required currents to scale. By scaling off the figure, it is found that $O e = O f = 28.8$ amp. The value of $O e$ may

also be found by trigonometry as follows: Drop the perpendicular $c g$. Then, $O g = \frac{50}{2} = 25$; $\cos 30^\circ = \frac{O g}{O e}$;

and $O c = \frac{25}{\cos 30^\circ} = \frac{25}{.866} = 28.8$ amp. Ans.

(1833) (a) Frequency = 60, number of pairs of poles = 5.

By formula 647, rev. per second = $\frac{50}{2} = 12$, or rev. per minute at no load = 720. Ans.

(b) The slip is 5%; therefore the armature runs $720 \times .05 = 36$ rev. per minute less than the revolving field. The speed at full load will, then, be $720 - 36 = 684$ rev. per minute.

(1834) (a) The method of constructing a sine curve is explained in Art. 3846 and is illustrated in Fig. 1438.

(b) A sine curve is changing most rapidly at the points where it crosses the horizontal, that is, when it is passing through zero. The slant of the curve is greatest where the curve crosses the axis, hence the change in the ordinate corresponding to a change in time is greater at this point than anywhere else.

(1835) (a) The output is 150 K. W. Then, by formula 652,

$$150,000 = \bar{C} \bar{E} \sqrt{3};$$

or, line current $\bar{C} = \frac{150,000}{1,000 \times \sqrt{3}} = 86.6$ amperes. Ans.

(b) The current in the armature winding will be, by formula 655,

$$\bar{c} = \frac{86.6}{\sqrt{3}} = 50 \text{ amperes. Ans. (Art. 3993.)}$$

(1836) A non-inductive resistance of known value is connected in series with the circuit, the power in which is to be measured. The drop across the non-inductive resistance, across the circuit in which the power is expended, and also the drop across both combined, is measured, thus giving three voltmeter readings. If \bar{E}_1 is the drop across the resistance, \bar{E} , the drop across the circuit in which the power is being measured, and \bar{E} the drop across both combined, then, by formula 641,

$$W = \frac{1}{2R} (\bar{E}^2 - \bar{E}_1^2 - \bar{E}^2),$$

where W is the watts expended and R the value of the non-inductive resistance. (Art. 3948.)

(1837) (a) Open-circuit windings are preferred because they are better adapted for the production of high voltages than closed-circuit windings. They allow more conductors to be connected up in series, thus giving the high voltage which is usually required for alternating-current work. (Art. 3954.)

(b) The kind of winding used does not affect the frequency. The only quantities which affect the frequency of an alternator are the number of poles and the speed. The type of winding affects only the voltage and current output of the machine. (Art. 3951.)

(1838) (a) The load on the secondary is $100 \times 50 = 5,000$ watts.

The apparent input in watts is $1,000 \times 6.5 = 6,500$ watts.

Hence, the apparent efficiency is $\frac{5,000}{6,500} = .769$ or 76.9%.
Ans.

(b) The real watts supplied to the primary = $6,500 \times .85 = 5,525$. Ans.

(c) The true efficiency is, therefore, $\frac{5,000}{5,525} = 90.5\%$.
Ans.

(1839) Three-phase Y-connected windings can not be used for rotary transformers because the winding of a rotary transformer has to be at the same time both a direct-current and an alternating-current winding. Windings for continuous-current machines are of the closed-circuit type, hence the alternating-current winding must also form a closed circuit. This means that the Δ winding has to be used in such machines. (Art. 4053.)

(1840) If the opening in the coil is much narrower than the pole-piece, there is danger of some of the E. M. F.'s in the different turns opposing each other, because they will be cutting lines in the same direction at once. The result of this would be to diminish the total E. M. F. generated by the alternator. (Art. 3959.)

DESIGN OF ALTERNATING-CURRENT APPARATUS.

(QUESTIONS 1841-1918.)

(1841) It has been shown that, other things being equal, the hysteresis loss is proportional to the frequency. The eddy-current loss is proportional to the square of the frequency. It follows, therefore, that a machine of given size and output which runs at a high frequency will usually have a larger core loss than one running at a low frequency. The number of poles on continuous-current machines is usually small compared with the number on alternators, hence the frequency of the magnetic cycles in direct-current armature cores is not generally as high as it is in the cores of alternator armatures. For this reason alternators are liable to have larger core losses than continuous-current machines of corresponding speed and output. (Arts. 4059, 4068 to 4070.)

(1842) If the inductance of an armature is very high and the current sufficiently large, all the E. M. F. generated may be used to drive the current through the armature against this inductance, and the useful terminal E. M. F. will therefore fall off to zero. If the inductance were very high and the field excitation not raised as the machine was being loaded, this limiting current might be less than the rated full-load current of the machine. (Art. 4060.)

(1843) If an armature is well ventilated, it should be capable of radiating from .04 to .06 watt per square inch per degree rise, which, with 40° C. rise, would mean a total radiation of from 1.6 to 2.4 watts. The student will understand

that these are only average values, because this quantity depends very largely on the construction of the armature and the peripheral speed at which it runs. The radiation constant in individual cases might, therefore, vary considerably from the above values. (Art. 4071.)

(1844) It has been shown that when the armature has self-induction, as is nearly always the case, the effect of the armature reaction is both to distort and to weaken the field. It follows, then, that if the field is not correspondingly strengthened by increasing the exciting current, the voltage at the terminals of the machine will fall off. (Arts. 4073, 4074.)

(1845) If the armature reaction is made excessive, the field may be so weakened as the load is applied that the E. M. F. will decrease when the current tends to increase, thus keeping the current constant. (Art. 4081.)

(1846) If the alternator runs at a speed of 450 R. P. M. and has 16 poles, the frequency will be $\frac{450}{60} \times 8 = 60$ cycles per second.

(a) In this case there are 16 slots, and since there are 16 poles, we have only one group of conductors per pole; consequently we may use formula 617,

$$\bar{E} = \frac{4.44 N T n}{10^8},$$

because all the conductors will be active at the same instant. There are 16 slots, with 30 conductors in each, making in all 480 conductors, or 240 turns. We have, then,

$$\bar{E} = \frac{4.44 \times 3,000,000 \times 240 \times 60}{10^8} = 1,918 \text{ volts. Ans. (Art. 4086.)}$$

(b) If we used 32 slots, with 15 conductors per slot, we would have the same total number of conductors as before, but only half of them would be active at the same instant. The E. M. F. in this case would therefore be .707 times that which was obtained with the 16-slot arrangement, or, by formula 664,

$$\bar{E} = 1,918 \times .707 = 1,356 \text{ volts. Ans. (Art. 4087.)}$$

(c) If 48 slots with 10 conductors per slot are used, the E. M. F.'s in the three sets will be displaced, as shown in Fig. 1591, and the E. M. F. obtained would be .667 times that given by the concentrated winding. We would have, then, by formula **666**,

$$\bar{E} = 1,918 \times .667 = 1,279 \text{ volts. Ans. (Art. 4088.)}$$

(1847) (a) Bars are generally used for the windings of machines of which the current output is large, or, in general, in any armature where a very large wire or a large number of wires in multiple would be required to carry the current. Low-voltage machines are usually bar-wound, because the lower the voltage the greater is the current for a given output.

(b) Wire conductors are preferred for machines where the current output is comparatively small and the voltage high. A conductor made up of a number of wires in multiple is often used where it is desired to make the conductor flexible. (Arts. **4103** to **4105**.)

(1848) Two-layer windings are largely used because they enable the ends of the coils to pass each other without interfering, and utilize all the available space at the end of the armature. They also have the advantage of accommodating one coil for each slot; for with such windings there are as many slots as coils, whereas with a single-layer winding there would have to be twice as many slots as coils (one slot for each side of each coil). (Art. **4093**.)

(1849) (a) If the alternator runs at the rate of 300 R. P. M. and has 12 poles, the frequency will be $\frac{300}{60} \times 6 = 30$ cycles per second. If the armature has 12 slots, there will be only one group of conductors per pole, and we may write

$$T = \frac{\bar{E} \times 10^8}{4.44 \times N \times n'}$$

or $T = \frac{1,500 \times 10^8}{4.44 \times 3,000,000 \times 30} = 375 \text{ turns. Ans. (Art. 4086.)}$

(b) If the winding is placed in 24 slots, one half the conductors will be idle while the other half is active, so that we will have the relation

$$T = \frac{\bar{E} \times 10^8}{4.44 \times N \times n \times .707}$$

and since \bar{E} is to be 1,500 volts in both cases, the value of T must be

$$T = \frac{1,500 \times 10^8}{4.44 \times 3,000,000 \times n \times .707} = 530 \text{ turns.}$$

In order, then, to obtain the same voltage, 155 turns more have to be used with the subdivided winding than with the concentrated winding. Ans. (Art. 4087.)

(1850) (a) A wire having a diameter of .001 inch would have a cross-sectional area of 1 circular mil. One foot of copper wire having this cross-section has a resistance at ordinary temperatures of about 10.4 ohms.

(b) At the temperatures usually met with in well-designed electrical machinery the resistance per mil-foot is about 11.5 ohms. (Art. 4139.)

(1851) When the coils are heavy, they generally contain a large number of turns, thus causing the voltage between adjacent layers to be considerable, and making it necessary to provide insulation between the layers, as explained in Arts. 4110 and 4214.

(1852) If the winding is to be arranged in two layers, there will be as many slots as there are coils. In this case we are to provide for a two-coil winding, i. e., two coils per pole per phase. The machine has 16 poles and is to be wound for three phases; hence there will be $16 \times 3 \times 2 = 96$ slots and 96 coils. (Arts. 4087, 4088.)

(1853) When the field is excited by a separately excited winding only, the coils are subjected to no higher pressure than that generated by the exciter. In case the machine is provided with compound coils which are in connection with the armature winding, the full pressure of the

machine is tending to break down the insulation and set up a short circuit through the frame and armature core. When this method of field excitation is used, it follows that the compound coils should be thoroughly insulated from the separately excited coils, and from the frame of the machine as well. (Arts. **4161**, **4162**.)

(**1854**) In large machines it is not necessary to rectify all the current in order to supply the compound coils. A shunt across the rectifier terminals is therefore mounted on the armature, which revolves with it. By this means a considerable portion of the current is allowed to flow around the rectifier, which cuts down the amount of current to be handled by the rectifier brushes and reduces the sparking. (Arts. **4182** and **4202**.)

(**1855**) The principal factor limiting the output of an alternator is the heating effect due to the core losses and copper losses, as explained in Arts. **4059** to **4062**. The output of an alternator is not usually a strictly definite quantity, because the same machine may be capable of a greater output under one set of conditions than it would under another. For example, a machine could give a larger output without overheating in a large airy dynamo room than it could if it were placed in the hold of a ship where the ventilation was poor and the temperature high.

(**1856**) The effects of armature reaction in alternators are not of such importance as in direct-current machines because the reaction does not give rise to any sparking. The only bad effect it can have is to cause a falling off in the terminal voltage, and this can be compensated for by strengthening the field. (Art. **4061**.)

(**1857**) (*a*) Eddy currents may be avoided to a large extent by laminating the core and insulating the laminations from each other sufficiently to prevent the currents from flowing between the disks.

(*b*) The eddy-current losses in alternators are apt to be high if the core is not carefully built up, because of the high frequency.

(c) The eddy-current loss increases with the square of the frequency; thus, doubling the frequency makes this loss four times as great. (Art. 4070.)

(1858) Armatures may be wound to have low inductance by using a small number of turns per coil or using a large number of slots with few conductors in each slot. (Art. 4079.)

(1859) The machine has 8 poles and runs at a speed of 900 R. P. M.; its frequency is therefore $\frac{900}{60} \times 4 = 60$ cycles per second.

(a) The armature has a total of 24 slots, hence there must be 8 slots per phase, or 1 slot per pole-piece per phase. There will then be 480 conductors, or 240 turns in each phase connected in series, and since there is only one group per phase, we may write as the E. M. F. generated in each phase

$$\bar{E} = \frac{4.44 N T n}{10^8} = \quad (\text{See formula 617.})$$

$$\frac{4.44 \times 2,500,000 \times 240 \times 60}{10^8} = 1,598 \text{ volts. Ans.} \\ (\text{Art. 4086.})$$

(b) If 48 slots are used, with 30 conductors in each slot, we shall have the same total number of conductors as before, but we shall have 16 slots to each phase, or two groups of conductors per pole-piece. Then, by formula 669,

$$\bar{E} = \frac{4.44 N T n}{10^8} \times .965 =$$

$$1,598 \times .965 = 1,542 \text{ volts. Ans. (Art. 4090.)}$$

(c) If the whole 1,440 conductors were evenly distributed, we would have

$$\bar{E} = \frac{4.44 N T n}{10^8} \times .95 =$$

$$1,598 \times .95 = 1,518 \text{ volts. Ans. (Art. 4090.)}$$

(1860) About 4,500 feet per minute would be a fair value for a machine of this size and output. (Arts. 4082, 4083.)

(1861) (a) From 14 to 18 mils, the thicker iron being used for low-frequency machines.

(b) The cores are usually light, because of the small magnetic flux which they have to carry as compared with direct-current machines. This is a consequence of the use of a large number of poles, the flux being so split up that the cross-section of iron in the core does not need to be very large to carry it. (Arts. 4095, 4096.)

(1862) A distributed winding generally results in a large number of crossings of the coils at the ends of the armature, thus making them difficult to insulate for high voltages. If high pressure is needed from such a machine, it can be generated at a low pressure and stepped up by means of transformers. (Art. 4089.)

(1863) (a) If the output is 200 K. W. and the full-load voltage 2,300, the full-load current will be $\frac{200,000}{2,300} = 86.9$ amperes. If we allow 500 circular mils per ampere, we would then require a cross-section of $86.9 \times 500 = 43,450$ circular mils. Ans. (Art. 4125.)

(b) Two No. 7 wires in multiple would give 41,640 circular mils, or four No. 10 wires would give 41,520 circular mils. One No. 4 wire would give 41,740 circular mils, but this would be too stiff to wind up easily into coils.

(1864) (a) If k represents the resistance of 1 foot of the wire 1 mil in diameter or 1 circular mil in area, then $L \times k$ would be the resistance of the given length of wire if it had a cross-section of only 1 circular mil, L being the length expressed in feet. The resistance of any wire of given length is inversely proportional to the area of its cross-section; for example, doubling the cross-section halves the resistance, etc. It follows, then, that if the conductor has a cross-section of m circular mils, its resistance will be

$$R = \frac{L \times k}{m}. \quad (\text{See formula 680, Art. 4139.})$$

(b) The hot resistance of 1 mil-foot of copper is about

11.5 ohms, hence we have for the given length and cross-section, by formula **682**,

$$R = \frac{1,600 \times 11.5}{11,500} = 1.6 \text{ ohms. Ans. (Art. 4139.)}$$

(1865) The output would not be changed, because, in changing from a **Y** to a Δ winding, the voltage is reduced by the same ratio that the current output is increased. The size of slot required will be about the same in either case, and the size of the armature required will be the same. (Art. **4151**.)

(1866) Shafts for induction motors should be specially stiff on account of the short air-gap used. (Art. **4269**.)

(1867) (a) The density in the core of a 125-cycle transformer may be taken as 20,000 lines per square inch for a fair average value. This would make the value of the flux $N = 200,000$ lines. (Art. **4211**.)

(b) We have, by formula **697**,

$$E_p = \frac{4.44 N T_p n}{10^8},$$

or
$$1,000 = \frac{4.44 \times 200,000 \times T_p \times 125}{10^8};$$

hence, $T = \frac{1,000 \times 10^8}{4.44 \times 200,000 \times 125} = 900$ turns, nearly. Ans. (Art. **4222**.)

(c) If the secondary voltage is to be 50, the number of secondary turns required will be, by formula **698**,

$$T_s = T_p \times \frac{E_s}{E_p} = 900 \times \frac{50}{1,000} = 45 \text{ turns. Ans. (Art. 4223.)}$$

(1868) Alternators with armatures having high inductance will show a considerable falling off in terminal pressure from no load to full load, on account of the armature reaction and the induction drop in the armature. In order to keep the voltage constant, an additional field excitation must be supplied, and the greater the armature reaction and inductance the larger must be the additional excitation.

This additional excitation is supplied by means of the series coils; hence they must be more powerful for armatures with high inductance than for those with low inductance. (Art. **4184.**)

(**1869**) 30,000 lines per square inch may be taken as an average value of the density in cast-iron yokes. In some machines the density is lower than this, in order to make the yoke have enough cross-section to give sufficient mechanical strength. The density may be run somewhat higher than 30,000 without danger of saturation, but the above may be taken as an average value. (Art. **4169.**)

(**1870**) If the magnetic circuit of a transformer is broken by an air-gap, the magnetic reluctance is greatly increased. A large magnetic reluctance requires a large magnetizing current to set up the flux necessary to produce the counter E. M. F. The effect of an air-gap would then be to considerably increase the no-load current. (Art. **4213.**)

(**1871**) The series coils may be supplied with a current which varies in proportion to the load by connecting them to the secondary coil of a transformer, the primary of which is in series with the armature. This transformer revolves with the armature, and as the primary and secondary windings are not electrically connected in any way, the insulation of the series coils is not subjected to a high potential. (Art. **4201.**)

(**1872**) If the motor is to run at 1,500 revolutions per minute, we must have (see formula **646**) $n = p \times s$, or $125 = p \times \frac{1400}{60}$, whence $p = 5$, and the number of poles will therefore be 10. The coils used in winding the field will bridge over $\frac{1}{6}$ of the circumference, thus giving rise to a 10-pole field when current is sent through them. (Art. **4253.**)

(**1873**) When an armature is run on open circuit in a fully excited field, there will be a rise in temperature due to the losses which occur in the core. We have a mass of iron

in which the magnetism is being constantly changed, hence the conditions necessary for setting up hysteresis and eddy-current losses are present, and these core losses will occur whether the armature is delivering current or not. (Art. 4063.)

(1874) (a) The safe working temperature of an armature is determined by the temperature which the insulating materials are capable of standing continuously without deterioration.

(b) About 40° C. (Arts. 4064, 4065.)

(1875) A low-resistance armature requires a small amount of slip, consequently the falling off in speed from no load to full load is small compared with what it would be if the armature resistance were high and the slip correspondingly large. (Art. 4247.)

(1876) When the armature has no self-induction, the current in the armature coils is in phase with the E. M. F. In such a case the armature exerts no demagnetizing action on the field, but tends only to distort it, crowding the lines of force to one side of the pole-pieces. (Art. 4073.)

(1877) Armatures with concentrated windings consisting of a small number of heavy coils generally have high inductance. Coils such as are used on armatures of this class usually have a large number of turns, and the self-inductance is consequently high. (Art. 4078.)

(1878) For an armature of this size we may take 5,000 feet as the belt as a fair value for the belt speed. This will give us $\pi D = 691$.

$$\text{Diameter of pulley} = \frac{5,000 \times 12}{\pi \times 45} = 42\frac{1}{2} \text{ in., nearly.}$$

By Art. 692,

$$\text{Width of belt} = 7 \times \frac{5,000 \times 12}{2,000} = 33 \text{ in.}$$

A row of 12 bolts on each side of the belt would give 32 inches as the width of the pulley. Arts. (Art. 4200.)

(1879) The secondary-core losses are small because the frequency in the secondary is very low. The hysteresis loss is proportional to the frequency, and the eddy-current loss to the square of the frequency; hence a low frequency will result in small core losses. (Art. 4241.)

(1880) If the current in the armature lags behind the E. M. F., a current is flowing in the coils when they are directly under the poles, and this current tends to demagnetize the field. The current in the conductors also tends to distort the field, so that when the current lags behind the E. M. F., the effect is not only to distort the field, but also to demagnetize it. (Arts. 4074, 4075.)

(1881) (a) Inductances in series are added like resistances; hence, if we have 10 coils, each having an inductance of .01 henry, the total inductance will be .1 henry.

(b) If each coil consists of one-half the number of turns, its inductance will be one-quarter of what it was before, because the inductance is proportional to the square of the number of turns. The inductance of each coil in the second case will therefore be $\frac{1}{4} \times .01 = .0025$ henry. There are 20 coils connected in series, hence the total inductance in the second case will be $20 \times .0025 = .05$ henry. The total number of turns has not been changed, but the inductance has been reduced to one-half of what it was in the former case. (Art. 4079.)

(1882) (a) Windings for induction-motor fields are usually almost identical with the winding which would be used for the corresponding polyphase armature. Each phase consists of a number of coils grouped together and spaced around the periphery of the field in the same way that they would be arranged on a polyphase armature.

(b) Windings placed in slots give rise to less magnetic leakage, thus making the inductance of the motor less when loaded, and thereby increasing the power factor. (Art. 4244.)

(1883) The C^2R loss in small alternators is a considerably larger percentage of the output than in the case of large machines. The percentage rapidly decreases, however, until a point is soon reached beyond which it decreases very little. To decrease the C^2R loss much below 1.5 or 2% requires too large an expenditure in the shape of copper. (Art. 4066.)

(1884) (a) It was pointed out in Art. 4068 that the hysteresis loss in a given mass of iron depends upon the quality of the iron, and is proportional to the volume, to the frequency, and to the 1.6 power of the magnetic density. The loss then in a given mass of iron worked at a given frequency and density is a quantity which can at once be calculated when the magnetic quality of the iron is known.

(b) Laminating the core will have no effect upon the core, provided the volume and quality of the iron are not changed in any way. Usually, laminating the core will decrease the actual cross-section of iron, and this might cause a slight increase in the hysteresis loss due to the increased density. The object in laminating a core is to keep down the eddy-current loss, and it has little or no effect on the hysteresis loss, which is a loss in the iron itself, not a loss due to currents eddying around in the iron.

(1885) (a) The core loss in the first transformer is 120 watts; hence, watt-hours lost per day = $120 \times 24 = 2,880$, or 2.88 kilowatt-hours. The cost of this per year will then be $2.88 \times .10 \times 365 = \105.12 . The first cost of the transformer is \$30, so that the cost of the core losses plus interest and depreciation will be $\$105.12 + \$3 = \$108.12$.

The core loss in the second transformer is 90 watts. The loss in watt-hours for 1 day will be $90 \times 24 = 2,160$. This core loss will cost per year $2,160 \times .10 \times 365 = \78.84 . The transformer costs \$50, so that the interest and depreciation will amount to \$5 per year, making the total cost \$83.84.

(b) The second transformer; for, although the first cost of this transformer is greater than that of the other, it will be much the cheaper to operate, the first cost being less in

either case than the expense of operating. (Arts. **4230** to **4232**.)

(**1886**) The speed is 900 revolutions per minute and the field has 8 poles; consequently the frequency will be 60 cycles per second. (See formula **646**.) Taking curve *B*, Fig. 1584, we find the watts lost per cubic inch per 100 cycles at a density of 25,000 to be about .275. The total loss will therefore be

$$W = \frac{2,200 \times .275 \times 60}{100} = 363 \text{ watts. Ans. (Art. } \mathbf{4068}.)$$

(**1887**) The higher the peripheral speed the greater will be the amount of heat which can be radiated with a given rise in temperature. (Art. **4071**.)

(**1888**) The strength of the series coils may be varied by placing a non-inductive resistance or shunt across their terminals. By adjusting this resistance, the proportion of the total current which passes through the coils may be varied as desired. For example, if the shunt had a resistance equal to that of the coils, the current would divide about equally between the two. (Art. **4182**.)

(**1889**) The eddy-current loss increases as the square of the frequency; doubling the speed would double the frequency; hence the eddy-current loss would be made four times as great. It might also be noted here that the hysteresis loss would be made only twice as large, as this loss increases directly with the frequency. (Art. **4070**.)

(**1890**) If the resistance is inserted in the field, the field current is cut down and the field strength thereby reduced. The strong armature currents react on this weak field, making it still weaker, and resulting in a small starting torque. When the resistance is inserted in the armature, the whole line voltage is applied to the field and is effective in setting up a strong magnetic flux. The resistance in the armature circuit limits the secondary currents and prevents them from weakening the field set up by the primary, so that a good starting torque is the result. (Arts. **4246**, **4247**.)

(1891) (a) The quantities which determine the size of wire to be used for the field winding are: the ampere-turns to be set up, the mean length of a turn in feet, the resistance of a mil-foot of the wire; and the voltage applied to the coils.

(b) Let l_m be the mean length of a turn, p the number of pairs of poles on the machine, E the exciter voltage, e the drop in the regulating rheostat, Ct the ampere-turns supplied by one pair of coils, and 11.5 the resistance of 1 mil-foot of copper at the working temperature of the field. Then,

$$\text{Circular mils cross-section of field wire} = \frac{p \times l_m \times Ct \times 11.5}{E - e}.$$

(Arts. 4176, 4177.)

(1892) (a) The angular distance between the arms of the rocker depends upon the number of poles on the machine. The arms must be so arranged that when one brush presses on one segment of the rectifier, the other presses on the other segment. There are as many segments as poles, so that the angular distance between the arms and brushes will depend upon the angular distance between the poles.

(b) If the machine has 16 poles, there will be 16 segments in the rectifier, and the angular distance from center to center of segments will be $22\frac{1}{2}^\circ$. The brushes would be set so as to bring them as far apart as possible, and still have them in contact with the two different segments. This would make the angle between the tips $7 \times 22.5 = 157.5^\circ$. (Art. 4197.)

(1893) (a) The air-gap should be made small in order to keep down the magnetizing current and increase the power factor of the machine by decreasing the cross-section of the leakage path. A small increase in the length of the air-gap would make quite a large increase in the current necessary to set up the magnetic flux in the field.

(b) The air-gap density should generally be low, otherwise a large magnetizing current will be required. It will usually be found to lie somewhere between 20,000 and 30,000 lines per square inch. (Art. 4249.)

(1894) (a) The flux through the yoke is one-half that through the pole-pieces in the case of a multipolar field with circular yoke and radial pole-pieces.

(b) The flux through the pole-pieces is equal to the flux through the air-gap multiplied by the coefficient of magnetic leakage; that is, the flux through the poles has to be greater than that through the air-gap by an amount sufficient to make up for the lines which leak across without going through the air-gap. (Arts. 4167 to 4169.)

(1895) The yoke is usually made of cast iron rather than steel in the case of alternators because there is no need for making special efforts to make the yoke cross-section small. The required cross-section is usually small anyway, on account of the small magnetic flux, so that a steel yoke is not necessary, besides being more expensive and difficult to cast. (Art. 4156.)

(1896) (a) There are 72 slots, with 12 conductors per slot, in the primary winding, making a total of 864 conductors, or 288 conductors per phase. In the secondary winding there are 48 slots, with 2 bars per slot, making a total of 96 bars, or 32 bars per phase. In the primary we have 288 conductors per phase connected in series, while in the secondary there are 32 connected in series. If the primary current in each phase is 50 amperes and the power factor of the secondary is 1, the secondary current will be

$$\frac{288}{32} \times 50 = 450 \text{ amperes. Ans.}$$

(b) If we allow 800 circular mils per ampere, the cross-section of the secondary winding bar in *circular mils* will be

$$450 \times 800 = 360,000.$$

To reduce this to square mils, we must multiply by $\frac{\pi}{4}$; hence the cross-section in square mils will be

$$360,000 \times .785 = 282,600 \text{ sq. mils. Ans. (Art. 4261.)}$$

(1897) (a) A unicoil or concentrated winding is one in which there is only one group of conductors per pole, so

that all the conductors in a given phase are active at the same instant.

(b) The chief advantages of this style of winding are: (1) Ease of arrangement on the armature. (2) Ease with which high insulation can be secured. (3) A high E. M. F. generated for a given length of active conductor.

(c) The disadvantages of concentrated windings are: (1) High armature reaction. (2) High armature self-induction. Both these tend to produce bad regulation for constant pressure. Concentrated windings also localize the heat generated in the coils, so that the coils are more apt to get hot than in armatures where they are spread out more. (Arts. 4085, 4086.)

(1898) For a density of 40,000 lines per square inch, we find the loss per cubic inch per 100 cycles to be .60 watt. (See curve B, Fig. 1584.) The total loss in the teeth will then be

$$\frac{200 \times .60 \times 125}{100} = 150 \text{ watts.}$$

The density in the core under the teeth is 20,000, and the loss per cubic inch per 100 cycles corresponding to this density is about .19 watt. The total loss in the core proper will therefore be

$$\frac{500 \times .19 \times 125}{100} = 118.75 \text{ watts.}$$

The total loss would then be

$$150 + 118.75 = 268.75 \text{ watts. Ans. (Art. 4068.)}$$

(1899) (a) Since the alternator runs at 600 revolutions per minute and has 12 poles, its frequency will be 60. There are 24 slots in all, or 12 for each phase; consequently, there is only one group of conductors per pole-piece per phase. There are $12 \times 50 = 600$ conductors, or 300 turns in each phase.

$$\text{Then, } E = \frac{4.44 N T n}{\sqrt{2}} =$$

$$\frac{4.44 \times 300 \times 60 \times 300 \times 60}{10^8} = 1,598.4 \text{ volts. Ans.}$$

(Art. 4087.)

(b) If the winding were spread evenly over the surface, the voltage obtained would be reduced 10%, or we would have to multiply the expression above by .90. Hence we have

$$\bar{E} = 1,598.4 \times .9 = 1,438.56 \text{ volts. Ans. (Art. 4090.)}$$

(1900) Bolts passing through the cores of armatures or transformers are liable to give rise to eddy currents by short-circuiting the disks. Whenever it is necessary to pass bolts through such cores, they should be insulated lightly by means of a paper tube, but it is best when possible to make the construction such that the bolts do not need to pass through the core. (Art. 4070.)

(1901) Stationary armatures are best adapted for high voltages because there is usually more room on them for insulation, and, not being subjected to vibration of any kind, the insulation is not liable to be injured. The use of the stationary armature also does away with the necessity of insulating collector rings, brush-holders, etc., for high potentials. (Art. 4111.)

(1902) (a) The useful output at full load will be 5,000 watts. The input will be $5,000 + 60 + 50 + 95 = 5,205$ watts. The full-load efficiency will therefore be $\frac{5,000}{5,205} = 96.06\%$. Ans.

(b) At $\frac{1}{2}$ load the core loss will be the same as before, but the copper losses will be only $\frac{1}{4}$ as great, because the current will be one-half as great in the primary and secondary (loss varies with the square of the current). The copper loss in the primary at $\frac{1}{2}$ load will therefore be 15 watts, and in the secondary 12.5 watts. The total losses at $\frac{1}{2}$ load will then be 122.5 watts. The useful output will be 2,500 watts, so that the efficiency is $\frac{2,500}{2,622.5} = 95.3\%$. Ans.

(c) The total useful output during the day is $5,000 \times 6 = 30,000$ watt-hours.

The total hysteresis loss during the day is $95 \times 24 = 2,280$ watt-hours.

The total C^2R loss during the day is $(60 + 50) \times 6 = 660$ watt-hours.

Total loss in 24 hours 2,940 watt-hours.

Hence,

$$\text{All-day efficiency} = \frac{30,000}{32,940} = 91.07\% \quad \text{Ans.}$$

(Arts. 4230 to 4232.)

(1903) No; there can be no hysteresis loss when the magnetism is steady. If the field exciting current were fluctuating there might be some loss, but as soon as the current becomes steady the frequency is 0; consequently the hysteresis loss is 0. (Art. 4068.)

(1904) (a) Oiled linen tape and mica. Coils should also be well treated with insulating varnish after all moisture has been driven off by baking. Tape is usually sufficient by itself, except for coils intended to stand high pressures, in which case it is best to use mica in addition to the tape.

(b) Slots are usually lined with a trough made up of alternate layers of paper and mica. Other materials, such as micanite and leatheroid, are also used. (Arts. 4110 to 4117.)

(1905) Highly saturated teeth in a direct-current machine tend to keep the armature from reacting strongly on the field, and thus reduce sparking. In the case of an alternator or induction motor, the highly saturated teeth could do no good in this respect, and would only tend to make the hysteresis and eddy-current loss large. (Art. 4119.)

(1906) (a) The use of oil ensures largely against breakdowns in insulation, because if the insulation is punctured at any point the oil at once fills up the gap. Oil also serves to conduct the heat away from the coils to the case of the transformer and thus get rid of it to the surrounding air. (Art. 4210.)

(*b*) It is important that the insulation between the primary and secondary coils should be high because there is always a tendency for the high-tension primary current to jump across, especially if there should happen to be a ground on the secondary circuit. Any connection between the primary and secondary would bring the high primary pressure into connection with it and be liable to injure the apparatus connected to the circuit. (Art. **4214**.)

(**1907**) About 30,000 lines per square inch. The value might vary slightly either side of this amount without making any appreciable change in the armature-core loss or in the ampere-turns required for the magnetic circuit. (Art. **4120**.)

(**1908**) If the total output is 75 K. W. at 1,100 volts, the current in each phase will be

$$\frac{37.5 \times 1,000}{1,100} = 34.09 \text{ amperes.}$$

Each phase has a resistance of .75 ohm.; hence the $C^2 R$ loss in each phase at full load will be

$$(34.09)^2 \times .75 = 871.6 \text{ watts.}$$

The total loss in the armature will therefore be

$$871.6 \times 2 = 1,743.2 \text{ watts. Ans. (Art. } \mathbf{4145}.)$$

(**1909**) (*a*) For cast-iron pole-pieces the air-gap density should not run much over 30,000 lines per square inch, as this will bring the density in the cast-iron pole-pieces quite high enough when allowance is made for magnetic leakage.

(*b*) With wrought-iron pole-pieces the density in the air-gap may be as high as 40,000 or 45,000 lines per square inch. (Art. **4121**.)

(**1910**) The method of obtaining the length of the face of iron parallel to the shaft, in order to limit the density to the desired amount, has been explained in Art. **4257**. This assumes that the intensity of the magnetization decreases as we move either side of the center of the pole face according to the sine law. This is nearly the case in motors with

distributed wound fields. The formula giving the required relation then is

$$l = \frac{N \times 2 \phi}{2 \times d_f \times B}$$

(1911) (a) A distributed winding is one which is split up into a large number of coils and spaced around the armature, as distinguished from one which is provided with a few heavy coils only.

(b) These windings have the advantages of low self-induction and consequent good regulation for constant potential. They also radiate the heat generated in the windings more easily than armatures having heavy coils. They have the disadvantages that they give a lower E. M. F. for a given length of active conductor and are more difficult to insulate and construct. (Arts. 4084 to 4086.)

(1912) (a) If the line voltage is 500 and the winding is Δ -connected, the pressure generated in each phase must be 500; hence we have

$$\bar{E} = \frac{4.44 N T n}{10^8} \times .95.$$

$$500 = \frac{4.44 \times 500,000 \times T \times 60 \times .95}{10^8}$$

$$T = \frac{500 \times 10^8}{4.44 \times 500,000 \times 60 \times .95} = 396 \text{ turns, nearly. Ans. (Art. 4257.)}$$

(b) If the power factor is .85 when 10,000 true watts are being delivered, the apparent watts will be $\frac{10,000}{.85} = 11,765$, nearly.

We have $W = \bar{C} \bar{E} \sqrt{3}$,

or $11,765 = \bar{C} 500 \sqrt{3}$.

$$\bar{C} = \frac{11,765}{500 \sqrt{3}} = 13.59 \text{ amp. Ans. (Art. 4251.)}$$

(c) Each phase would take $\frac{1}{3}$ the input, or $\frac{11,765}{3}$ apparent

watts. The voltage per phase is 500; hence the current per phase will be

$$\frac{11,765}{3 \times 500} = 7.84 \text{ amp. Ans.}$$

The same result might also be obtained by dividing the line current by $\sqrt{3}$, because in a Δ -connected armature the current in each phase is equal to the line current divided by $\sqrt{3}$.

(1913) (a) If the flux from one pole is 2,500,000 lines, the flux through a section of the armature under the slots will be $\frac{1}{2}N$, or 1,250,000 lines. The density is to be 30,000 lines per square inch; hence the area of cross-section of the iron will be

$$\frac{1,250,000}{30,000} = 41.66 \text{ sq. in. Ans.}$$

(b) Since the length of the iron part of the core parallel to the shaft is 15 in., the depth of iron under the slots must be

$$\frac{41.66}{15} = 2.77 \text{ in., say } 2\frac{3}{4} \text{ in.}$$

The inside diameter will be $28 - (4 + 5\frac{1}{2}) = 18\frac{1}{2}$ in. Ans. (Art. 4136.)

(1914) (a) Magnetic leakage may, to a large extent, be prevented by splitting the coils up into a number of sections and sandwiching the primary and secondary sections between each other. This reduces the magnetomotive force of any one coil, and thus reduces the tendency to leakage. If the coils are arranged one over the other, with very little space between them, and made such that the leakage path will be long and of small cross-section, the magnetic reluctance of the leakage path will be high, and the leakage consequently small. (Art. 4213.)

(b) If the secondary current is 50 amperes and the resistance of the secondary .02 ohm, the drop due to the secondary resistance will be $50 \times .02 = 1$ volt.

The current in the primary corresponding to 50 amperes in the secondary will be $\frac{50}{20} = 2.5$ amperes, neglecting the magnetizing current. The drop in the primary at full load will then be $2.5 \times 5 = 12.5$ volts. This 12.5 volts drop in the primary will cause a drop in the secondary of $\frac{12.5}{20} = .625$ volt, and the total drop due to the resistance of both coils will be 1.625 volts. **Ans.**

(1915) The mean length of a turn is 40 inches, or $4\frac{2}{3}$ feet. The ampere-turns supplied by 1 pair of coils is 4,000. The voltage of the exciter is 220 volts and the drop in the regulator 25 volts, so that the voltage actually applied to the field is 195. Applying formula 690, we have

$$m = \frac{4 \times 4\frac{2}{3} \times 4,000 \times 11.5}{195} = 3,145 \text{ cir. mils.}$$

No. 15 B. & S. has a cross-section of 3,257 circular mils, so that this size would be suitable. (Art. 4177.)

(1916) (a) The machine has to deliver a total of 50 K.W. or $\frac{50}{3}$ K.W. in each phase. The voltage generated per phase will be 1,100, because the armature is to be Δ wound. The full-load current in each phase will therefore be

$$\frac{50,000}{3 \times 1,100} = 15.15 \text{ amp.}$$

The loss in each phase will then be

$$(15.15)^2 \times 1.5 = 344.4 \text{ watts.}$$

The total C^2R loss will be $344.4 \times 3 = 1,033.2$ watts. **Ans.**

(b) The drop in each phase will be $\bar{C}R = 15.15 \times 1.5 = 22.7$ volts, and since the phases in a Δ winding are connected directly across the line, the drop in the line pressure due to the armature resistance will also be 22.7 volts. (Art. 4151.)

(1917) If the poles are not laminated, eddy currents will be set up in them by the teeth of the armature sweeping past the faces. The coarse armature teeth set up tufts

of magnetism which sweep across the pole-pieces, and thus set up eddy currents if the pole tip is not laminated or broken up in some way by grooves or wrought-iron pieces cast in, as explained in Art. **4155**.

(1918) See Art. **4143**. The total output is 175 K. W. ; hence the output in each phase will be $\frac{175,000}{2}$ watts. The voltage is 3,000; hence the current in each phase is

$$\frac{175,000}{2 \times 3,000} = 29.16 \text{ amp.}$$

Allowing 500 circular mils per ampere, we get the cross-section necessary:

$$29.16 \times 500 = 14,580 \text{ cir. mils.}$$

This is between a No. 8 and No. 9 B. & S. The former would probably be used, as it gives a little over the required section rather than under it.

INDEX.

	<i>Page.</i>		<i>Page.</i>
A.			
Addition of sine curves	2567	Alternators, Pitch	2657
Air gap, Density in	2431, 2778	" Polyphase	2670
" gap density, Limiting value of	2405	" Revolving-field and inductor	2667
" gap, Length of	2417, 2806	" Single-phase	2646
" gap of induction motor, Length of	2877	" Table of poles, output, and speed of	2656
All-day efficiency	2862	" Three classes of	2650
Alternating-current circuits, Power expended in	2619	" Three-phase	2676
" current, Explanation of	2560	" Two-phase	2671
" current measuring instruments	2633	" 100 K. W. single-phase, Design of	2778
" current motors	2713	Ampere-turns, Armature	2399, 2411
" current, Transmission lines for	2628	" turns, Back	2402
" current, Wattless and power component of	2626	" turns, Cross	2399, 2403
" current waves, Examples of	2561	" turns for multiple-circuit winding	2413
" currents, General theory of	2559	" turns for two-circuit winding	2413
" currents and E. M. F.'s, Composition and resolution of	2577	" turns of field, Calculation of	2810
" E. M. F.'s, Addition of	2574	" turns of field magnets, Calculation of	2423
" E. M. F.'s, Relation between values of	2581	" turns, Total	2433
Alternation, Definition of	2563	Amplitude of sine curves	2566
Alternators, Calculation of E. M. F. generated by	2658	Angle of advance	2572
" Connections for	2834	" of lag	2598, 2614
" Construction of	2650	" of lag, Definition of	2572
" General remarks on design of	2735	" of lead	2572
" Illustrations and examples of	2840	Area of armature core	2432
" Limitation of output of	2736	Armature ampere-turns, Effect of	2399
" Mechanical construction of	2821	" ampere-turns for multipolar circuit winding	2413
" Monocycle	2687	" ampere-turns for two-circuit winding	2413
		" ampere-turns, Limiting values of, for drum winding	2407
		" ampere-turns, Limiting values of, for ring winding	2408

INDEX

	Page		Page
.....	211	211
.....	212	212
.....	213	213
.....	214	214
.....	215	215
.....	216	216
.....	217	217
.....	218	218
.....	219	219
.....	220	220
.....	221	221
.....	222	222
.....	223	223
.....	224	224
.....	225	225
.....	226	226
.....	227	227
.....	228	228
.....	229	229
.....	230	230
.....	231	231
.....	232	232
.....	233	233
.....	234	234
.....	235	235
.....	236	236
.....	237	237
.....	238	238
.....	239	239
.....	240	240
.....	241	241
.....	242	242
.....	243	243
.....	244	244
.....	245	245
.....	246	246
.....	247	247
.....	248	248
.....	249	249
.....	250	250
.....	251	251
.....	252	252
.....	253	253
.....	254	254
.....	255	255
.....	256	256
.....	257	257
.....	258	258
.....	259	259
.....	260	260
.....	261	261
.....	262	262
.....	263	263
.....	264	264
.....	265	265
.....	266	266
.....	267	267
.....	268	268
.....	269	269
.....	270	270
.....	271	271
.....	272	272
.....	273	273
.....	274	274
.....	275	275
.....	276	276
.....	277	277
.....	278	278
.....	279	279
.....	280	280
.....	281	281
.....	282	282
.....	283	283
.....	284	284
.....	285	285
.....	286	286
.....	287	287
.....	288	288
.....	289	289
.....	290	290
.....	291	291
.....	292	292
.....	293	293
.....	294	294
.....	295	295
.....	296	296
.....	297	297
.....	298	298
.....	299	299
.....	300	300

<i>Page.</i>	<i>Page.</i>		
Component of E. M. F. to overcome resistance	2589	Core transformer, Magnetic density in	2845
" of E. M. F. to overcome self-induction	2589	" volume, Determination of	2851
Components of impressed E. M. F.	2588	Cores, Armature	2470
Composition and resolution of currents and E. M. F.'s	2577	" Slotted	2415
Compound of series-field winding	2816	Counter E. M. F. of motor	2521
" winding, Magnetization curves applied to	2443	Critical resistance	2454
" wound dynamo, Connection diagram for	2515	" value of frequency	2616
Conductor, Armature	2462, 2477, 2769	Cross ampere-turns, Effect of	2399
" Connection of, to commutator	2478	" ampere-turns, Value of	2403
" Determination of resistance of	2788	" and armature ampere-turns, Limiting values of, for drum winding	2407
Conductors in core of induction motor	2887	" and armature ampere-turns, Limiting values of, for ring winding	2408
" of armature, Dimensions of	2780	Current density in armature conductors	2415
" of transformer, Dimensions of	2853	" E. M. F. and output of three-phase alternators, Relation between	2683
Condensance	2607	" in primary of induction motor	2878
Condenser charges	2602	" Limiting volume of	2409
" Description of	2600	" Maximum volume of	2410
" E. M. F.	2604	" Wattless	2622
Connecting transformers	2703	" Wattless, and power components	2626
Connection diagrams	2514	Currents and E. M. F.'s, Composition and resolution of	2577
Connections, Delta and star	2678	Curves applied to compound winding	2443
" for alternator	2834	" Characteristic	2449
" of induction motors	2892	" of magnetization	2440
" Series-motor	2542, 2545	Cycle, Definition of	2562
" Shunt-motor	2541	Cylindrical winding	2767
" Terminal	2510		
Construction of dynamos	2468	D.	<i>Page.</i>
" of transformer	2865	Delta and star connections	2678
Copper losses in transformer	2841	Densities in magnetic circuit	2431
" wire table	2427	" Magnetic	2421
Core, Cross-section of	2508	Density in air gap	2431, 2778
" Density in	2422	" in armature core	2423, 2777
" in conductors of induction motor	2887	" in armature teeth	2421, 2776
" losses	2462	" in magnet core	2422, 2432
" losses in alternators	2740	" in pole pieces	2432
" losses in induction motor	2871, 2872	" in yoke	2422, 2432
" losses in transformers, Effect of	2699	Design of alternators, General remarks on	2735
" of alternator armature, Design of	2781	" of armature core of alternator	2781
" of armature, Density in	2777	" of continuous-current motors	2549
" of armature, Dimensions of	2780	" of field	2806
" of transformer	2844	" of field magnets	2799
" of transformer, Dimensions of	2852	" of induction motor	2869
" transformer, Description of	2701		

	<i>Page.</i>		<i>Page.</i>
Design of 12-horsepower dynamo	2426	E. M. F., to overcome capacity, Calculation of	2606
“ of 10-horsepower induction motor	2878	E. M. F.'s, Relation between values of	2581
“ of 10-horsepower series motor	2553	End connectors	2478
“ of 10-horsepower shunt motor	2551	Energy losses	2458
“ of 100-K. W. single-phase alternator	2778	External characteristics, Method of deriving	2449
“ of 8-K. W. transformer	2850	“ characteristics of shunt dynamos	2452
Diagrams, Connection	2514	Eyebolts, Sizes of	2505
Differentially wound motors	2539		
Disks, Armature	2471, 2762	F.	<i>Page.</i>
Dynamo, Electrical efficiency of	2439	Farad, Definition of	2602
“ Example in design of	2426	Field ampere-turns, Calculation of	2423, 2810
“ Frame of	2502	“ and armature connections in induction motor	2723
“ Mechanical construction of	2468	“ coils, Insulation of	2805
Dynamometer, Siemens	2639	“ coils, Loss in	2830
Dynamos and motors compared	2518	“ Design of	2806
“ Bearings for	2499	“ frame and bed, Construction of	2821
“ Characteristics of	2452, 2456	“ frame of induction motor	2894
“ Efficiencies of, for various outputs	2460	“ Laminated	2508
E.	<i>Page.</i>	“ losses	2463
Eddy-current losses	2466, 2744	“ magnet coils	2803
Effective value of alternating E. M. F.	2580	“ magnets, Design of	2799
Efficiency, All-day	2862	“ of induction motor	2869
“ Commercial	2457	“ Revolving	2802
“ curve of transformer	2860	“ spools, Heating of	2395
“ Electrical	2457	“ winding, Compound or series winding of induction motors	2816
“ of dynamo, Electrical	2439		2716, 2832
“ of dynamo for various outputs	2460	Flux in poles of induction motor	2884
“ of motor	2522	“ through pole pieces and yoke	2808
“ of transformer	2858	Frame of dynamo	2502
Electrical efficiency	2457	Frequency, Critical value of	2616
“ efficiency of dynamo	2439	“ Definition of	2573
“ resonance	2616	Friction losses	2461
Electrodynamometers	2637	“ Magnetic	2462
Electrostatic voltmeters	2642	Full-load current in primary of induction motor	2878
E. M. F., Component of, to overcome resistance	2589		
“ Component of, to overcome self-induction	2589	G.	<i>Page.</i>
“ Condenser	2604	Gears and pinions for motors	2558
“ Counter	2521		
“ generated by alternators, Calculation of	2658	H.	<i>Page.</i>
“ induced, Calculation of	2586	Heat losses in induction motor	2890
“ Maximum, average, and effective values of	2579	Heating in armature	2393
“ Motor	2521	“ in armature, Loss due to	2394
“ Ratio of transformation of	2731	“ in dynamo	2394
		“ in field spools	2395
		“ of alternator armatures	2737
		“ of transformers	2844

	<i>Page.</i>		<i>Page.</i>
Henry, Definition of	2587	Lag, Angle of	2598, 2614
Hysteresis	2462	Laminated fields	2508
" loss	2741	Leakage in magnetic circuit	2470
		Limiting value of air-gap density	2404
I.	<i>Page.</i>	" value of cross and armature ampere-turns, drum winding	2407
Ideal transformer, Action of	2605	" value of cross and armature ampere-turns, ring winding	2408
Impedance, Definition of	2596	" volume of current	2409
" resistance, and reactance, Relation between	2567	Line, Self-induction of	2629
Impressed E. M. F.'s, Components of	2588	Long shunt	2444
Induced E. M. F.'s, Calculation of Inductance	2588	Loss due to heating of armature	2394
Induction motor	2716	" due to hysteresis	2741
" motor, Armature of	2894	" Eddy-current	2744
" motor, Armature winding of	2721	" in field coils	2820
" motor, Conductors in core of	2887	Losses, Core	2462
" motor, Connections of	2892	" Energy	2458
" motor, Core losses in	2871, 2872	" Friction	2461
" motor, Field and armature connections of	2723	" in armature	2465
" motor, Field frame and bedplate of	2894	" in eddy currents	2466
" motor, Field winding of	2716, 2892	" in field	2463
" motor, Heat losses in	2890	" in transformers	2841
" motor, Limitation of output of	2870	" of power in dynamos	2461
" motor, Magnetic densities in	2871, 2872		
" motor, Mechanical construction of	2894	M.	<i>Page.</i>
" motor, Operations of	2724	Magnet core, Density in	2427, 2432
" motor, Power factor of	2877	" spools	2509
" motor, Remarks on design of	2869	Magnetic circuit, Densities in	2431
" motor, Table of poles, output, and speed of	2725	" circuit of dynamo	2468
" motor windings	2873	" core. Cross-section of	2508
" motor, 10-horsepower, Design of	2878	" density in transformer core	2845
Input	2458	" densities	2776, 2421
Instruments for measuring alternating current	2632	" densities in induction motors	2871, 2872
" Plunger type of	2634	" flux in poles of induction motor	2832
Insulation of alternator armature	2772, 2774	" flux through pole pieces and yoke	2808
" of field coils	2805	" friction	2462
" of transformer coils	2848	" leakage in transformer	2693
Iron losses in transformer	2841	" leakage in transformer, Effect of	2698
		Magnetization curve	2440
K.	<i>Page.</i>	" curve applied to compound wiring	2443
Keys	2497	" curve from test	2441
		Magnetizing current	2693
		" current of transformer	2863
		Maximum value of alternating E. M. F.	2579
		" volume of current	2410
		Measuring instruments, Classes of	2633

	<i>Page.</i>		<i>Page.</i>
Measuring instruments for alternating currents	2632	Power factor of a circuit	2625
Mechanical construction of alternator	2821	" factor of induction motor	2877
" design of motor	2553	" measurement	2643
Microfarad, Definition of	2603	Primary and secondary coils, Arrangement of	2856
Monocycle alternator	2687	" and secondary turns, Calculations of	2854
Motor, Counter E. M. F. of	2521	" winding of induction motor	2873, 2880
" Efficiency of	2523	Pulleys for alternators	2833
" E. M. F.	2521		
" Explanation of action of	2519	R.	<i>Page.</i>
" Methods of reversing	2546	Radiating surface of armature	2744
" Output of	2549	Railway-motor armature	2557
" Series	2533	Ratio of transformation	2692
" Shunt	2530	Ratios of transformation of E. M. F.	2731
" Torque of	2524	Reactance, Definition of	2593
Motors, Alternating-current	2713	" resistance, and impedance, Relation between	2597
" and dynamos compared	2518	Reaction brush holder	2491
" Classification of	2520	Rectifier	2666
" continuous-current, Design of	2549	Regulating rheostat	2546
" Differentially wound	2539	Regulation transformer	2865
" Gears and pinions for	2558	Regulator, Stillwell	2711
" Induction	2716	Resistance, Critical	2454
" Mechanical design of	2553	" in a characteristic of conductors, Determination of	2788
" Principles of operation of	2517	" of shunt	2438
" Stationary	2553	" of transformer coils, Effect of	2698
" Street-railway	2554	" reactance, and impedance, Relation between	2597
" Synchronous	2713	Resolution of currents and E. M. F.'s	2577
Multipolar rotary transformers	2731	Resonance, Electrical	2616
O.	<i>Page.</i>	Revolving-field and inductor alternators	2667
Output	2458	" fields	2802
" and C^2R loss, Relation between	2739	Rheostat, Regulating	2546
" of alternator, Limitation of	2736	" Starting	2540
" of dynamo, Factors limiting	2391	Rocker-arm	2493
" of induction motor, Limitation of	2870	" arm, Construction of	2831
" of motor, Determination of	2549	Rotary transformers	2726
P.	<i>Page.</i>	" transformers, Multipolar	2731
Period, Definition of	2564	Rotation, Speed of	2430
Phase, Explanation of	2568, 2571	Rotor	2870
" splitting	2725		
Pilot lamp	2515	S.	<i>Page.</i>
Pitch of alternator	2657	Secondary and primary coils, Arrangement of	2856
Plunger instruments for alternating currents	2634	" and primary turns, Calculation of	2854
Pole pieces	2505	" winding in induction motor	2875
" pieces, Density in	2432		
Poles, Bore of	2807		
Polypphase alternators	2670		
" armature windings	2757		
Power component of current	2626		
" expended in alternating-current circuits	2619		

	<i>Page.</i>		<i>Page.</i>
Secondary winding of induction motor	2886	Speed of armature of induction motor	2880
Segments of commutator	2482	" of rotation	2430
Self-induction, Coefficient of	2587	" regulation of series-motor	2536
" induction, Explanation of	2584	" regulation of shunt motor	2532
" induction of armature	2749	Spiders of armature	2472, 2765
" induction of transmission line	2699	Spools	2508
Separately excited winding, Calculation of	2812	Squirrel-cage winding	2721
Series and shunt winding, Proportion of	2444	Star and delta connections	2678
" motor connections	2542, 2545	Starting box	2540
" motor, Description of	2533	" rheostat	2540
" motor, Design of	2553	Stationary motors	2553
" motor on constant-current circuit	2537	Stator, Definition of	2869
" motor on constant-potential circuit	2534	Stillwell regulator	2711
" motor, Speed regulation of	2536	Street-railway motors	2554
Shaft for alternator	2832	Stud, Brush-holder	2492
" of armature	2495	Switches, Automatic	2544
" of induction motor	2894	Synchronous motors	2713
Shell transformer, Description of	2702		
Short shunt	2444	T.	<i>Page.</i>
Shunt and series winding, Proportion of	2444	Tap bolts, Standard hexagonal head	2305
" current, Value of	2437	Teeth, Density in	2421, 2776
" dynamos, Characteristics of	2452	" Size of	2428
" Long	2444	Terminal blocks	2511
" motor, Action of	2531	" board	2510
" motor connections	2541	" connections	2510
" motor, Description of	2530	Three-ammeter method of measuring power	2635
" motor, Design of	2551	" phase alternator	2676
" motor, Speed regulation of	2532	" phase alternator, Armature winding for	2793
" Resistance of	2438	" phase alternator, Relation between E. M. F. and output of	2683
" resistance, Relation of, to armature resistance	2439	" phase system	2575
" Short	2444	" phase transformer	2729
" wires, Size of	2435	" voltmeter method of measuring power	2643
" wound dynamo, Connection diagram for	2513	Torque, Determination of	2525
Siemens dynamometer	2639	" of motor	2524
" wattmeter	2641	Total ampere-turns in magnetic circuit	2433
Sine curves, Addition of	2567	Transformation, Ratio of	2692
" curves, Construction of	2564	Transformer coils and core, Arrangements of	2846
" curves, Maximum, average, and effective values of	2579	" coils, Effect of resistance of	2698
" curves, Properties of	2567	" coils, Winding and insulation of	2548
Single-phase alternators	2646	" conductors, Dimensions of	2853
" phase concentrated winding	2753	" Construction of	2865
" phase distributed windings	2753	" core	2843
" phase transformers	2727	" core, Dimensions of	2852
Slip in induction motors	2720	" core, Magnetic density in	2845
Slotted cores	2415		
Speed of armature	2395		
" of armature of alternator	2751		

	<i>Page.</i>		<i>Page.</i>
Transformer, Design of 8 K. W.	2550	Voltmeter, Electrostatic	2642
" Efficiency of	2658	Volume of current, Limiting	24-9
" General theory of	2649	W.	<i>Page.</i>
" ideal, Action of	2695	Wattless component of current	2626
" Losses in	2841	" current	2622
" Magnetizing current	2563	Wattmeter, Siemens	2641
" Regulation of	2565	Wave winding	2761
" Three-phase	2774	Winding, Barrel or cylindrical	2450, 2767
" Two-phase	2728	" for three-phase alter-	
Transformers, Classes of	2699	nator	2793
" Connection of	2703	" for two-phase alternator	2771
" Construction of	2701	" of transformer coils	2848
" Heating of	2844	" separately excited, Cal-	
" multipolar, Rotary	2731	culation of	2512
" Reasons for using	2688	" Single-phase concen-	
" Remarks on design	2841	trated	2753
" Rotary	2726	" Single-phase distributed	2753
" Single-phase	2727	" Squirrel-cage	2721
" Special uses of	2709	" Wave	2761
Transmission lines for alternating	2628	Windings, Arrangements of	2444
Two-phase alternator	2671	" Induction-motor	2273
" alternator, Armature		" Polyphase	2757
winding for	2791	" series and shunt, Pro-	
" system	2575	portion of	2444
" transformer	2728	Wire, Size of, to transmit power	2628
V.	<i>Page.</i>	Wires, Binding	2451
Value of shunt current	2437	Y.	<i>Page.</i>
Ventilation of armature	2480	Y-connection for three-phase alter-	
		nator	2640
		Yoke, Density in	2422, 2432

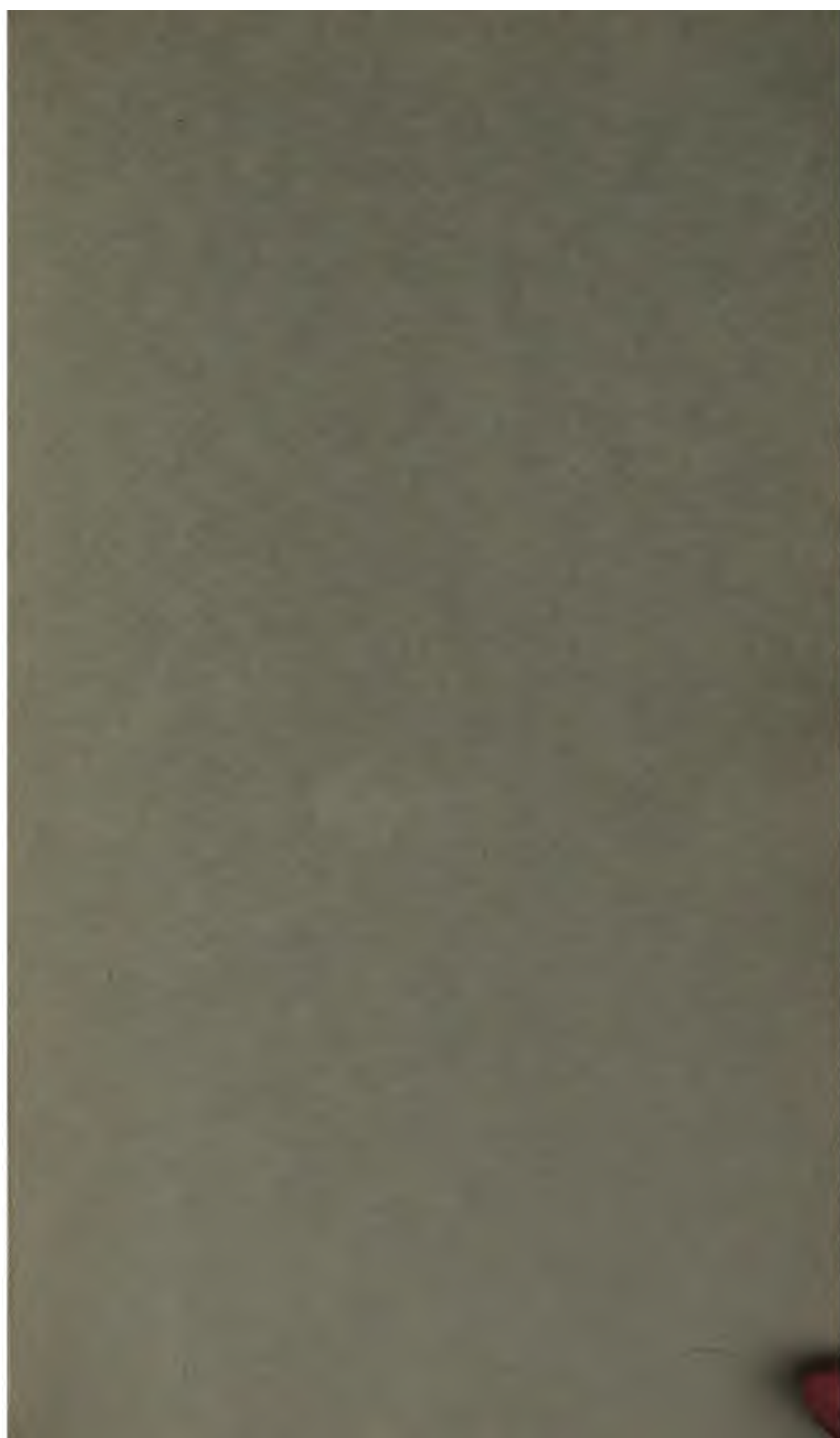

SEP 20 1929

The first part of the document discusses the importance of maintaining accurate records of all transactions. It emphasizes that every entry, no matter how small, should be recorded to ensure the integrity of the financial data. This includes not only sales and purchases but also expenses, income, and any other financial activities.

The second part of the document provides a detailed breakdown of the accounting process. It outlines the steps involved in recording transactions, from identifying the event to posting it to the appropriate ledger accounts. This section also covers the importance of double-entry bookkeeping and how it helps in maintaining the balance of the books.

The third part of the document discusses the various methods used to summarize and analyze the financial data. This includes the preparation of the income statement, balance sheet, and statement of cash flows. It also touches upon the importance of comparing the current period's performance with the previous period and with industry benchmarks.

The fourth part of the document addresses the challenges and common mistakes in accounting. It highlights the need for attention to detail and the importance of regular reconciliation of accounts. It also discusses the consequences of errors and how they can be corrected.

The fifth and final part of the document provides a summary of the key points discussed throughout the document. It reiterates the importance of accuracy, consistency, and transparency in accounting practices. It also offers some final thoughts on the role of accounting in the overall success of a business.