



This is a digital copy of a book that was preserved for generations on library shelves before it was carefully scanned by Google as part of a project to make the world's books discoverable online.

It has survived long enough for the copyright to expire and the book to enter the public domain. A public domain book is one that was never subject to copyright or whose legal copyright term has expired. Whether a book is in the public domain may vary country to country. Public domain books are our gateways to the past, representing a wealth of history, culture and knowledge that's often difficult to discover.

Marks, notations and other marginalia present in the original volume will appear in this file - a reminder of this book's long journey from the publisher to a library and finally to you.

Usage guidelines

Google is proud to partner with libraries to digitize public domain materials and make them widely accessible. Public domain books belong to the public and we are merely their custodians. Nevertheless, this work is expensive, so in order to keep providing this resource, we have taken steps to prevent abuse by commercial parties, including placing technical restrictions on automated querying.

We also ask that you:

- + *Make non-commercial use of the files* We designed Google Book Search for use by individuals, and we request that you use these files for personal, non-commercial purposes.
- + *Refrain from automated querying* Do not send automated queries of any sort to Google's system: If you are conducting research on machine translation, optical character recognition or other areas where access to a large amount of text is helpful, please contact us. We encourage the use of public domain materials for these purposes and may be able to help.
- + *Maintain attribution* The Google "watermark" you see on each file is essential for informing people about this project and helping them find additional materials through Google Book Search. Please do not remove it.
- + *Keep it legal* Whatever your use, remember that you are responsible for ensuring that what you are doing is legal. Do not assume that just because we believe a book is in the public domain for users in the United States, that the work is also in the public domain for users in other countries. Whether a book is still in copyright varies from country to country, and we can't offer guidance on whether any specific use of any specific book is allowed. Please do not assume that a book's appearance in Google Book Search means it can be used in any manner anywhere in the world. Copyright infringement liability can be quite severe.

About Google Book Search

Google's mission is to organize the world's information and to make it universally accessible and useful. Google Book Search helps readers discover the world's books while helping authors and publishers reach new audiences. You can search through the full text of this book on the web at <http://books.google.com/>

NYPL RESEARCH LIBRARIES



3 3433 06633647 4

3-VBA
International

✓
**INTERNATIONAL
LIBRARY OF TECHNOLOGY**

**A SERIES OF TEXTBOOKS FOR PERSONS ENGAGED IN THE ENGINEERING
PROFESSIONS AND TRADES OR FOR THOSE WHO DESIRE
INFORMATION CONCERNING THEM. FULLY ILLUSTRATED
AND CONTAINING NUMEROUS PRACTICAL
EXAMPLES AND THEIR SOLUTIONS**

**SULPHURIC ACID ✓
ALKALIES AND HYDROCHLORIC ACID ✓
MANUFACTURE OF IRON ✓
MANUFACTURE OF STEEL ✓**

SCRANTON:
INTERNATIONAL TEXTBOOK COMPANY

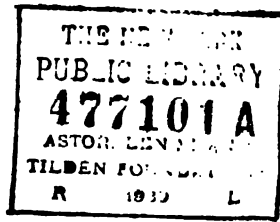

Copyright, 1902, by INTERNATIONAL TEXTBOOK COMPANY.

Entered at Stationers' Hall, London.

Sulphuric Acid: Copyright, 1902, by INTERNATIONAL TEXTBOOK COMPANY.
Entered at Stationers' Hall, London.

Alkalies and Hydrochloric Acid: Copyright, 1902, by INTERNATIONAL TEXTBOOK
COMPANY. Entered at Stationers' Hall, London.

Manufacture of Iron: Copyright, 1902, by INTERNATIONAL TEXTBOOK COMPANY.
Entered at Stationers' Hall, London.

Manufacture of Steel: Copyright, 1902, by INTERNATIONAL TEXTBOOK COM-
PANY. Entered at Stationers' Hall, London.

All rights reserved.

PREFACE

The International Library of Technology is the outgrowth of a large and increasing demand that has arisen for the Reference Libraries of the International Correspondence Schools on the part of those who are not students of the Schools. As the volumes composing this Library are all printed from the same plates used in printing the Reference Libraries above mentioned, a few words are necessary regarding the scope and purpose of the instruction imparted to the students of—and the class of students taught by—these Schools, in order to afford a clear understanding of their salient and unique features.

The only requirement for admission to any of the courses offered by the International Correspondence Schools, is that the applicant shall be able to read the English language and to write it sufficiently well to make his written answers to the questions asked him intelligible. Each course is complete in itself, and no textbooks are required other than those prepared by the Schools for the particular course selected. The students themselves are from every class, trade, and profession and from every country; they are, almost without exception, busily engaged in some vocation, and can spare but little time for study, and that usually outside of their regular working hours. The information desired is such as can be immediately applied in practice, so that the student may be enabled to exchange his present vocation for a more congenial one, or to rise to a higher level in the one he now pursues. Furthermore, he wishes to obtain a good working knowledge of the subjects treated in the shortest time and in the most direct manner possible.

In meeting these requirements, we have produced a set of books that in many respects, and particularly in the general plan followed, are absolutely unique. In the majority of subjects treated the knowledge of mathematics required is limited to the simplest principles of arithmetic and mensuration, and in no case is any greater knowledge of mathematics needed than the simplest elementary principles of algebra, geometry, and trigonometry, with a thorough, practical acquaintance with the use of the logarithmic table. To effect this result, derivations of rules and formulas are omitted, but thorough and complete instructions are given regarding how, when, and under what circumstances any particular rule, formula, or process should be applied; and whenever possible one or more examples, such as would be likely to arise in actual practice—together with their solutions—are given to illustrate and explain its application.

In preparing these textbooks, it has been our constant endeavor to view the matter from the student's standpoint, and to try and anticipate everything that would cause him trouble. The utmost pains have been taken to avoid and correct any and all ambiguous expressions—both those due to faulty rhetoric and those due to insufficiency of statement or explanation. As the best way to make a statement, explanation, or description clear is to give a picture or a diagram in connection with it, illustrations have been used almost without limit. The illustrations have in all cases been adapted to the requirements of the text, and projections and sections or outline, partially shaded, or full-shaded perspectives have been used, according to which will best produce the desired results. Half-tones have been used rather sparingly, except in those cases where the general effect is desired rather than the actual details.

It is obvious that books prepared along the lines mentioned must not only be clear and concise beyond anything heretofore attempted, but they must also possess unequalled value for reference purposes. They not only give the maximum of information in a minimum space, but this information is so ingeniously arranged and correlated, and the

indexes are so full and complete, that it can at once be made available to the reader. The numerous examples and explanatory remarks, together with the absence of long demonstrations and abstruse mathematical calculations, are of great assistance in helping one to select the proper formula, method, or process and in teaching him how and when it should be used.

Three of the volumes of this library are devoted to subjects pertaining to Applied Chemistry. The present volume contains descriptions of the following industries: manufacture of sulphuric acid, manufacture of alkalies and hydrochloric acid, manufacture of iron, and manufacture of steel. The manufacture of sulphuric acid, a comparatively new industry in this country, is increasing rapidly; the subject is thoroughly treated and liberally illustrated with detail plans of the latest constructions and improvements. Manufacture of Alkalies and Hydrochloric Acid treats on the manufacture of sodium chloride, soda, ammonia recovery, cryolite soda process, sodium sulphate, sodium thiosulphate, sodium hydrate, hydrochloric acid, chlorine, bleaching powder, etc., including the latest electrolytical processes and a description of the analytical methods of intermediate and finished products. Manufacture of Iron presents a complete description of modern blast-furnace practice, and contains besides valuable formulas for the calculation of blast-furnace burdens. Manufacture of Steel is a complete review of the art of steel making as practiced in this country. It has been our endeavor to expound the dominant principles that govern these industries and give at the same time a detailed account of the various manufacturing processes, with special consideration of the most modern American practice.

The method of numbering the pages, cuts, articles, etc. is such that each subject or part, when the subject is divided into two or more parts, is complete in itself; hence, in order to make the index intelligible, it was necessary to give each subject or part a number. This number is placed at the top of each page, on the headline, opposite the page number;

and to distinguish it from the page number it is preceded by the printer's section mark (§). Consequently, a reference such as § 30, page 26, will be readily found by looking along the inside edges of the headlines until § 30 is found, and then through § 30 until page 26 is found.

INTERNATIONAL TEXTBOOK COMPANY.

VI^a

CONTENTS

	<i>Section</i>	<i>Page</i>
SULPHURIC ACID		
Introduction	27	1
Principles Governing the Manufacture of Sulphuric Acid	27	7
The Production of Sulphur Dioxide or Burner Gas	27	21
Furnaces and Burners for the Produc- tion of Burner Gas	27	23
Brimstone Burners	27	25
Pyrites Burners	27	27
Testing the Burner Gas	27	32
Calculation of Volume of Burner Gas	27	40
The Catalytic, or Contact, Process	27	43
The Chamber Process	28	1
Apparatus Employed in the Chamber Process	28	5
Surface Condensers	28	16
Operation of the Chamber Process	28	28
Purification of Chamber Acid	28	42
Concentration of Dilute Acid Solutions and the Production of Sulphuric Mono- hydrate	28	48
ALKALIES AND HYDROCHLORIC ACID		
Sodium Chloride	29	1
Sodium Carbonate	29	9
The Solvay Process	29	11

ALKALIES AND HYDROCHLORIC ACID— <i>Cont'd</i>		<i>Section</i>	<i>Page</i>
Cryolite Soda Process	29		32
Salt Cake	29		34
Soda by the Le Blanc Process	29		46
Sodium Hydrate	29		74
Sodium Bicarbonate	29		84
Hydrochloric Acid	30		1
Chlorine	30		8
Bleaching Powder	30		29
Potassium Chlorate	30		37
Electrolytic Methods	30		44
Electrolytic Preparation of Alkali and Chlorine	30		66
Fused Electrolyte	30		69
Dissolved Electrolyte	30		73
Potassium Chlorate	30		84
Analytical Methods	31		1
Ammonia Soda	31		1
Salt-Cake Process	31		17
Le Blanc Process	31		20
Chance-Claus Sulphur Recovery	31		29
Sodium Bicarbonate	31		32
Hydrochloric Acid	31		36
Chlorine, Bleaching Compounds, Chlo- rates	31		41
MANUFACTURE OF IRON			
Introductory	32		1
Iron Ores	32		3
Classification of Iron Ores	32		3
Distribution of Iron Ores in the United States	32		5
Valuation of Iron Ore	32		7
Preparation of Ores	32		7
Fuel for Blast Furnace	32		14
Fluxes	32		16
Blowing Engines	32		18
Stoves	32		19

CONTENTS

v

<i>MANUFACTURE OF IRON—Continued</i>	<i>Section</i>	<i>Page</i>
Pipe Stoves	32	19
Regenerative Stoves	32	21
The Furnace	32	26
Casting	32	39
Slags	32	45
Calculation of Burdens	32	48
Classification of Iron	32	53
Practical Suggestions	32	61
MANUFACTURE OF STEEL		
Introductory	33	1
The Open-Hearth Process	33	5
Acid and Basic Open-Hearth Systems	33	23
Gaseous Fuel Used in Open-Hearth Furnaces	33	30
Natural Gas	33	30
Artificial Gas	33	32
The Acid Open-Hearth Process	33	44
The Basic Open-Hearth Process	33	60
The Bessemer Process	34	1
The Acid Bessemer Process	34	13
The Basic Bessemer Process	34	20
Recarbonization	34	33
The Crucible Process	34	44
Alloy Steels	34	56
Steel Castings	35	1
Defects in Steel	35	5
Effects of the Usual Elements Present in Steel	35	11
Examination of the Finished Product	35	15
Recent Progress in Steel Making	35	25
Treatment of the Ingot	35	32
Refractory Materials	35	37

INDEX

NOTE.—All items in this index refer first to the section (see the Preface) and then on the page of the section. Thus, "Alloy steels 34 56" means that alloy steels will be found on page 56 of section 34.

	<i>A</i>	<i>Sec.</i>	<i>Page</i>		<i>Sec.</i>	<i>Page</i>
Absorption chambers for bleaching powder.....	30		30	Acker process for the electrolysis of salt.....	30	71
Acid and basic open-hearth systems.....	33		23	Afterblow of basic Bessemer process.....	34	25
" Bessemer converter, Lining of.....	34		14	Air-quenched steel.....	34	56
" Bessemer process.....	34		13	" valves for open-hearth furnace.....	33	19
" Bessemer process, Chemical changes in the converter of.....	34		16	Alkali, total, Determination of, in black ash.....	31	22
" Bessemer process, General arrangement of plant of.....	34		19	" total, Determination of, in caustic bottoms.....	31	25
" Bessemer process, Temperature in converter of.....	34		17	" total, Determination of, in caustic liquor.....	31	34
" free, Determination of, in salt cake.....	31		19	" total, Determination of, in caustic mud.....	31	25
" free, Determination of, in still liquor.....	31		43	" total, Determination of, in caustic soda.....	31	26
" Mixed.....	28		58	" total, Determination of, in fished salts.....	31	34
" Nordhausen or fuming sulphuric.....	37		4	" total, Determination of, in lye from extraction of black ash.....	31	23
" open-hearth process.....	33		44	" total, Determination of, in soda ash.....	31	28
" open-hearth process, Addition of ore in.....	33		55	Alkaline sodium compounds, Determination of, in tank waste.....	31	27
" open-hearth process, Charge of.....	33		45	Alloy steels.....	34	56
" open-hearth process, Finishing the heat in.....	33		58	Alumina, Determination of, in lye from extraction of black ash.....	31	24
" open-hearth process, Removal of metalloids in.....	33		54	" Determination of, in salt cake.....	31	19
" open-hearth process, Slag in.....	33		53	" Determination of, in soda ash.....	31	16
" pumps.....	35		25	" in lye, Determination of.....	31	3
" refractories.....	35		26			
" sulphuric, Definition of.....	27		3			

	<i>Sec.</i>	<i>Page</i>		<i>Sec.</i>	<i>Page</i>
Aluminum bleach.....	30	36	Arsenic, Stahl method for re-		
" Effect of, in steel...	35	14	moving, from cham-		
" Use of, in basic steel	34	43	ber acid	28	47
Ammeters.....	30	55	Available sulphur.....	27	15
Ammonia, Determination of, in			" sulphur in burner		
ammonia liquor..	31	7	gas.....	27	14
" Determination of, in					
ammoniacal brine	31	7	B	<i>Sec.</i>	<i>Page</i>
" Determination of, in			Barilla.....	29	10
bicarbonate from			Barium chlorate.....	30	42
filters.....	31	13	Basic Bessemer process.....	34	20
" Determination of, in			" Bessemer process, Action		
mother liquor....	31	14	of basic fluxes in.....	34	30
" liquor, Analysis of..	31	6	" Bessemer process, Blow-		
" liquor, Determina-			ing the charge.....	34	25
tion of ammonia in	31	7	" Bessemer process, Con-		
" liquor, Determina-			trol of blowing in.....	34	26
tion of specific			" Bessemer process, Oxi-		
gravity of	31	6	dation of the elements in	34	27
" lost in Solvay proc-			" Bessemer process, Pig		
ess.....	29	31	iron used in.	34	22
" recovery in Solvay			" Bessemer slags as fertil-		
process.....	29	28	izers.....	34	31
" soda, Analysis of...	31	1	" converter.....	34	23
" soda, Properties of..	29	31	" fluxes, Action of, in basic		
" used in Solvay proc-			Bessemer process.....	34	30
ess.....	29	14	" hearth materials.	33	62
Ammoniacal brine	29	20	" open-hearth charge.....	33	64
" brine, Analysis of	31	7	" open-hearth charge, Cal-		
" brine, Carbona-			culation of.....	33	66
ting.....	29	21	" open-hearth furnace,		
" brine, Determina-			Thermal conditions in..	33	72
tion of ammo-			" open-hearth process.....	33	60
nia in... ..	31	7	" open-hearth process, Ad-		
" brine, Determina-			vantages of	33	61
tion of salt in...	31	7	" open-hearth process, De-		
Anions.....	30	60	phosphorization in.....	33	79
Anode.....	30	60	" open-hearth process, De-		
Anthracite for blast furnace...	32	16	sulphurization in.....	33	81
Apparatus employed in the			" open-hearth process,		
chamber process			Melting in	33	72
for sulphuric acid	28	5	" open-hearth process, Use		
used in Bessemer			of ore in.....	33	71
process	34	3	" open-hearth slag.....	33	74
Area reduction test of steel....	35	21	" refractories.....	35	42
Arsenic, Determination of, in			" steel, Use of aluminum in	34	43
hydrochloric acid...	31	39	Baumé specific gravity scale,		
" Freiberg process for			European	27	6
removing, from			" specific gravity scale,		
chamber acid.....	28	43	United States.....	27	6
" in iron... ..	32	60	Bauxite.....	35	44
" Precipitation of, in			" as hearth material....	33	62
the Freiberg proc-			Bell of blast furnace.....	32	32
ess.....	28	46	Bertrand-Thiel process for		
" Purification of cham-			making steel.....	35	30
ber acid from.....	28	43	Bessemer converter.....	34	12

INDEX

ix

	<i>Sec.</i>	<i>Page</i>		<i>Sec.</i>	<i>Page</i>
Bessemer process.....	34	1	Blast furnace, Hanging and		
“ process, Acid.....	34	13	slipping in.....	32	65
“ process, Apparatus			“ furnace, Hopper of.....	32	32
used in.....	34	1	“ furnace, Miscellaneous		
“ process, Blast for....	34	16	matters concerning		
“ process, Blowing en-			operation of.....	32	66
gine for.....	34	16	“ furnace, Reactions in....	32	40
“ process, Casting in..	34	19	“ furnace, Reactions in....	32	44
“ process, Cupolas for.	34	4	“ furnace, Scaffolds in.....	32	64
Bicarbonate from filters, Anal-			“ furnace slag, Composi-		
ysis of.....	31	11	tion of.....	32	45
“ from filters, De-			“ furnace slags, Fusibility		
termination of			of.....	32	46
ammonia in.....	31	18	“ furnace tuyeres.....	32	29
“ from filters, De-			Bleach, Electrolytic.....	30	82
termination of			“ liquors, Analysis of....	31	50
moisture in.....	31	13	“ liquors, Determination		
“ from filters, De-			of available chlorine		
termination of			in.....	31	48
sodium bicarbo-			“ liquors, Determination		
nate in.....	31	11	of carbonates in.....	31	49
“ from filters, De-			“ liquors, Determination		
termination of			of caustic alkali in...	31	49
total alkali in...	31	11	“ liquors, Determination		
Billet.....	35	34	of chlorates in.....	31	48
Bittern.....	29	8	“ liquors, Determination		
Black ash.....	29	48	of chlorides in.....	31	48
“ ash, Analysis of.....	31	21	“ Valuation of.....	30	33
“ ash, Analysis of lye from			Bleaching powder.....	30	29
extraction of.....	31	23	“ powder, Absorption		
“ ash, Composition of. . .	29	56	chambers for.	30	30
“ ash, Cyanides in.....	29	54	“ powder, Analysis of	31	50
“ ash, Determination of			“ powder, Chlorine for		
caustic soda in.....	31	22	making.....	30	31
“ ash, Determination of			“ powder, Composi-		
free lime in.....	31	21	tion of.....	30	33
“ ash, Determination of			“ powder, Lime for		
salt in.....	31	23	making.....	30	30
“ ash, Determination of so-			“ powder, Properties of	30	32
dium carbonate in.....	31	23	“ powder, Uses of....	30	35
“ ash, Determination of so-			Blind roaster for salt cake....	29	41
dium sulphate in.....	31	22	Bloom.....	35	34
“ ash, Determination of			Blooming mill.....	35	34
total alkali in.....	31	22	Blowholes in steel castings..	35	9
“ ash, Lixiviation of.....	29	57	“ in steel, Prevention		
“ ash, Properties of.....	29	56	of.....	35	11
“ ash, Sampling of.....	31	21	Blowing basic Bessemer charge	34	25
Blanquette.....	29	10	“ engine for Bessemer		
Blast for Bessemer process....	34	16	process.....	34	16
“ for blast furnace, Practi-			“ engine.....	32	18
cal suggestions for....	32	61	“ in the blast furnace....	32	25
“ furnace.....	32	26	“ out the blast furnace....	32	26
“ furnace, Bell of.....	32	32	Blumenberg electrolytic pro-		
“ furnace, Calculation of			cess for potassium chlorate....	30	87
burdens for.....	32	48	Bombonnes for condensing hy-		
“ furnace, Charging of....	32	35	drochloric acid.....	30	4

	<i>Sec.</i>	<i>Page</i>		<i>Sec.</i>	<i>Page</i>
Bottom of acid Bessemer converter.....	34	14	Burner gas, Calculation of volume of	27	40
" of basic converter	34	23	" gas, Collecting sample of.....	27	36
" stuff.....	35	45	" gas, Furnaces and burners for the production of.....	27	23
Breaking through of flame.....	34	17	" gas, Production of.....	27	21
Bridging in lime kiln.....	29	18	" gas, Purification of.....	27	50
Brimstone.....	27	8	" gas, Reheating of.....	27	52
" burner, Harrison-Blair.....	27	26	" gas, Reich's test for sulphur dioxide in.....	27	36
" burners.....	27	25	" gas, Testing.....	27	36
Brine, Ammoniacal.....	29	20	" Harrison-Blair brimstone.....	27	26
" ammoniacal, Analysis of.....	31	7	Burners and furnaces for the production of burner gas.....	27	23
" ammoniacal, Analysis of.....	31	1	" Brimstone.....	27	25
" ammoniacal, Determination of ammonia in.....	31	7	" Pyrites.....	27	27
" ammoniacal, Determination of salt in.....	31	7			
" Determination of calcium oxide in	31	3	C	<i>Sec.</i>	<i>Page</i>
" Determination of ferric oxide and alumina in.....	31	2	Calcination of iron ores.....	32	9
" Determination of inorganic sediment in.....	31	2	" of sodium bicarbonate.....	29	26
" Determination of magnesia in.....	31	3	Calcining furnace for sodium bicarbonate.....	29	27
" Determination of sodium chloride in.....	31	3	" kiln, Gjera.....	32	10
" Determination of specific gravity of.....	31	1	" soda crystals.....	29	63
" Determination of sulphur trioxide in.....	31	3	Calcium carbonate, Determination of, in quicklime.....	31	6
" Evaporation of, by grainers.....	29	6	" carbonate, Determination of, in soda ash... ..	31	16
" for Solvay process, Purification of.....	29	20	" carbonate for LeBlanc soda process.....	29	48
" Kettle evaporation of..	29	5	" chloride, Determination of, in still liquor.....	31	44
" Pan process for evaporation of.....	29	5	" fluoride from cryolite soda process.....	29	34
" Salt from.....	29	4	" oxide, Determination of, in brine.....	31	3
" Solar evaporation of....	29	4	" oxide, free, Determination of, in quicklime.....	31	6
" used in Solvay process.....	29	14	Calorific value of producer gas.....	33	42
" Vacuum pan process for the evaporation of....	29	6	Carbide of silicon.....	34	35
Brown hematite.....	32	4	Carbon as hearth material	33	62
" hematite, Distribution of, in United States... ..	32	6	" Control of, in recarbonizing.....	34	40
Huckstays.....	33	7	" dioxide, Determination of, in manganese ore.....	31	42
Bunte, Burette.....	31	8	" dioxide, Determination of, in slaked lime.....	31	43
" Burette, Reagents for..	31	11	" dioxide for Solvay process	29	15
Burdens for blast furnace, Calculation of.....	32	48			
Burette, Bunte.....	31	8			
Burned ball.....	29	51			
Burner gas, Available sulphur in.....	27	13			
" gas, Available sulphur in.....	27	14			

	<i>Sec.</i>	<i>Page</i>		<i>Sec.</i>	<i>Page</i>
Carbon dioxide for Solvay process, Washing of.	29	18	Caustic liquor, Filtration of...	29	77
" Effect of, in steel.....	35	12	" mud.....	29	82
" for LeBlanc soda process	29	48	" mud, Analysis of.....	31	35
" in iron	32	55	" mud, Determination of calcium carbonate in	31	35
" Oxidation of, in basic Bessemer process....	34	28	" mud, Determination of total alkali in.....	31	35
Carbonate iron ore, Distribution of, in United States.....	32	6	" pots.....	29	80
Carbonates, Determination of, in bleach liquors.....	31	49	" soda, Analysis of.....	31	36
Carbonated lye, Analysis of...	31	24	" soda, crude materials for, Analysis of.....	31	32
" lye, Determination of, sodium bicarbonate in.....	31	25	" soda, Determination of, in black ash.....	31	22
Carbonating ammoniacal brine	29	21	" soda, Determination of, in lye from extraction of black ash.....	31	23
" tower for Solvay process.....	29	22	" soda, Determination of, in soda ash.....	31	28
Carborundum.....	34	35	" soda, Determination of total alkali in....	31	36
Casting from blast furnace....	32	30	" soda, Uses of	29	83
" in Bessemer process...	34	19	Causticizing sodium carbonate	20	76
" steel, Composition of..	35	3	Centrifugal ventilator for Solvay process.....	29	25
" steel, Tropenas process for.....	34	31	Chamber acid, Freiberg process for removing arsenic from.....	28	43
Castings, Steel.....	35	1	" acid, Purification of.	28	42
Castner-Kellner electrolytic process for salt.....	30	78	" acid, Purification of, from arsenic.....	28	43
Catalytic or contact process for the manufacture of sulphuric acid.....	27	43	" acid, Stahl method for removing arsenic from.....	28	47
Cathode.....	30	60	" crystals	28	3
Cations.....	30	60	" process, Diagram of.	28	33
Caustic alkali, Determination of, in bleach liquors.	31	49	" process for sulphuric acid.....	28	1
" bottom.....	29	81	" process for sulphuric acid, Control of....	28	38
" bottoms, Analysis of..	31	34	" process for sulphuric acid, Operation of.	28	28
" bottoms, Determination of insoluble matter in.....	31	35	" process for sulphuric acid, Reactions of.	29	2
" bottoms, Determination of salt in	31	35	" process for sulphuric acid, Starting of.	28	35
" bottoms, Determination of sodium carbonate in.....	31	35	Chambers, Lead.....	24	11
" bottoms, Determination of total alkali in	31	35	Chance-Claus process for recovery of sulphur from tank waste.....	29	69
" lime, Determination of, in caustic mud...	31	35	Charcoal for blast furnace....	32	14
" liquor, Analysis of....	31	33	Charge, crucible, Melting of...	34	50
" liquor, Determination of salt in.....	31	34	" for basic open-hearth furnace.....	33	64
" liquor, Determination of specific gravity of	31	33	" for basic open-hearth furnace, Calculation of	33	66
" liquor, Determination of total alkali and sodium carbonate in...	31	34			

	<i>Sec.</i>	<i>Page</i>		<i>Sec.</i>	<i>Page</i>
Charge for crucible.....	34	49	Coke used in Solvay process..	39	15
" of acid open-hearth furnace, Calculation of	33	47	Cold shortness.....	35	13
" of acid open-hearth furnace, Melting the	33	52	Combustion of sulphur	27	12
Charging acid open-hearth furnace, Method of....	33	46	Commercial methods for determining the strength of sulphuric-acid solutions weaker than the monohydrate.....	27	5
" machine, Wellman...	33	25	Concentrating pots for the manufacture of potassium chlorate.....	30	40
" of blast furnace.....	32	35	Concentration and distillation of sulphuric acid starting with the Glover's tower....	28	56
Chemical changes in the converter of acid Bessemer process.....	34	16	" of dilute sulphuric acid solutions.....	28	48
" composition of steel, Relation of, to strength.....	35	22	" of sulphuric acid by the Kessler process.....	28	55
" examination of steel	35	16	" of sulphuric acid in glass retorts or stills	28	52
Chlorate, potassium, Analysis of.....	31	50	" of sulphuric acid in iron....	28	51
Chlorates, Analysis of.....	31	50	" of sulphuric acid in lead pans.....	28	48
" Determination of, in bleach liquors....	31	48	" of sulphuric acid in platinum	28	49
Chloride of lime.....	30	29	" of sulphuric acid in porcelain or glass beakers or dishes....	28	53
Chlorides, Determination of, in bleach liquors.....	31	48	Condensation of hydrochloric acid.....	30	1
Chlorine	30	8	Condenser, Falding	28	19
" available, Determination of, in bleach liquors.....	31	48	" Gilchrist.....	28	18
" by nitric-acid process	30	28	" Lunge	28	16
" by the Weldon process.....	30	20	Condensers, Surface.....	28	16
" Deacon's process for..	30	22	Conditions in the chambers in the manufacture of sulphuric acid.	28	30
" direct from salt.....	30	9	" in the Glover's tower.....	28	29
" for making bleaching powder.....	30	31	Conductivity of solutions.....	30	49
" from hydrochloric acid.....	30	10	" of solutions, Determination of.	30	52
" Liquid.....	30	29	" of solutions, The effect of temperature on....	30	49
" Source of.....	30	9	" vessel.....	30	50
Chrome steel.....	34	60			
Chromite.....	35	44			
" as hearth material...	33	62			
Cinder notch.....	32	31			
Claus kiln for sulphur recovery	29	71			
Clay for making crucibles.....	34	47			
" ironstone.....	32	5			
Clays.....	35	38			
Clear liquor, Determination of calcium chloride in.....	31	44			
Coal, Analysis of.....	31	7			
" used in Solvay process...	29	15			
Coke, Analysis of....	31	7			
" for blast furnace.....	32	14			
" tower for condensing hydrochloric acid.....	30	4			

	<i>Sec.</i>	<i>Page</i>		<i>Sec.</i>	<i>Page</i>
Conductors, Electric.....	30	59	Cupola mix	34	7
Constant-temperature bath....	30	50	" stuff.....	35	45
Contact mass or material used in the manufacture of sulphuric acid in the contact process..	27	45	Cupolas for Bessemer process.	34	4
" ovens.....	27	53	" Tuyeres for.....	34	5
" process for sulphuric acid, Diagram of....	27	54	Curtain drip.....	28	40
" process for the manu- facture of sulphuric acid.....	27	43	Cut-off gas valves.....	38	29
Control of blowing in basic Bessemer process.....	34	26	Cyanides in black ash.....	29	54
Converter, Basic.....	34	23			
" Bessemer	34	12	D	<i>Sec.</i>	<i>Page</i>
" for acid Bessemer process, Bottom and tuyeres of....	34	14	Dampers for open-hearth fur- nace.....	33	23
" Frasch.....	27	49	Darby method of recarbonizing	34	41
" Tropenas.....	34	31	Davis-Colby ore roaster.....	32	13
Copper, Effect of, in steel.....	35	14	Deacon-Hasenclever process for the purification of hydro- chloric acid.....	30	24
" in iron.....	32	60	Deacon's plus-pressure furnace for salt cake.....	29	41
" nickel pyrrhotites....	27	8	" process for chlorine..	30	22
Copperas slate.....	27	8	Dead melting steel.....	34	51
Corbin electrolytic process for potassium chlorate.....	30	86	Denaturated salt.....	29	9
Cowper stove	32	21	Density of sulphuric acid, De- termination of.....	27	5
Cranes	33	26	Dephosphorization in basic open-hearth process.....	33	79
Crook's stove.....	32	25	Desulphurization in basic open- hearth process.....	33	81
Crucible charge	34	49	" in basic open- hearth process, Saniter Process for.	33	83
" charge, Melting of....	34	50	Desulphurizing ores, Rules for	32	14
" furnace.....	34	44	Diagram of chamber process..	28	33
" process.....	34	44	" of contact process for sulphuric acid.....	27	54
" steel, Composition of.	34	54	" of manufacture of sulphuric acid.....	28	60
" steel, Superiority of..	34	53	Dissociation, Electrolytic.....	30	62
Crucibles for steel manufac- ture.....	34	45	Distiller liquor in Solvay pro- cess.....	29	30
" Manufacture of.....	34	48	Dolomite	33	43
" Materials for manu- facture of.....	34	46	" as hearth material...	33	63
" Teeming or pouring of	34	52	Downcomer.....	32	31
Crushing iron ores.....	32	8	Drop of flame.....	34	17
Cryolite soda process.....	29	32	Duplex process for making steel	35	22
" soda process, Calcium fluoride from.....	29	34	Dust catcher.....	32	32
" soda process, Sodium aluminate from.....	29	34			
Crystal soda, Analysis of.....	31	29	E	<i>Sec.</i>	<i>Page</i>
Crystallizing pans for the man- ufacture of potassium chlo- rate.....	30	41	Eau de Javel.....	30	4
Cupola, Flux for.....	34	7	" de Javel.....	30	35
" Fuel for.....	34	6	" de Labarraque.....	30	35
" lining.....	34	6	Elastic-limit test of steel.....	35	19
			Electric conductors.....	30	59
			" current, Sources of ..	30	41
			" polarization	30	63

	<i>Sec.</i>	<i>Page</i>		<i>Sec.</i>	<i>Page</i>
Electricity, Quantity of.....	30	54	Evaporation of brine, Kettle...	29	5
Electrodes.....	30	60	" of brine, Pan pro-		
" for the electrolysis			cess for.....	29	5
of salt.....	30	68	" of brine, Solar....	29	4
" Platinizing.....	30	51	" of sodium hydrate	29	78
Electrolysis.....	30	60	" of tank liquor....	29	60
" of salt.....	30	66	Evaporator, Yaryan.....	29	78
" of salt by Castner-			Exit gas, Determination of per-		
Kellner process..	30	78	centage of sulphur dioxide in	27	39
" of salt by Green-			Explosion doors of blast fur-		
wood process....	30	74	nace.....	32	33
" of salt by Har-					
greaves-and-Bird			P	<i>Sec.</i>	<i>Page</i>
process.....	30	77	Faldding condenser.....	28	19
" of salt by Hulin's			" lump burner.....	27	27
process.....	30	69	Faraday's law.....	30	60
" of salt by processes			Ferric oxide, Determination of,		
using a mercury			in lye from extraction		
cathode.....	30	78	of black ash.....	31	24
" of salt by proces-			" oxide, Determination of,		
ses using dia-			in salt cake.....	31	19
phragms.....	30	74	" oxide, Determination of,		
" of salt by the			in soda ash.....	31	16
Acker process .	30	71	" oxide in brine, Deter-		
" of salt by the Le			mination of.....	31	2
Sueur process...	30	75	Ferromanganese.....	32	59
" of salt, Conditions			" 	34	34
favoring.....	30	67	Ferrosilicon.....	34	34
" of salt with dis-			Ferrous carbonate.....	32	5
solved electro-			Fertilizers, Basic Bessemer		
lyte....	30	73	slags as.....	34	31
" of salt with fused			Filter for filtering caustic		
electrolyte.....	30	69	liquor.....	20	77
Electrolytes.....	30	60	Filters for Solvay process.	29	24
Electrolytic bleach.....	30	82	Filtration of caustic liquor.	29	77
" dissociation.	30	62	Fished salts, Analysis of.....	31	34
" methods for the			" salts, Determination of		
production of al-			oxidizable compounds		
kali and chlorine	30	66	in.....	31	34
" potassiumchlorate	30	84	" salts, Determination of		
Electromotive force....	30	56	sodium sulphate in...	31	34
" force, Measure-			" salts, Determination of		
ment of.....	30	57	total alkali in.....	31	34
" force of polariz-			Flux for cupola.....	34	7
ation, Calcula-			Fluxes, basic, Action of, in basic		
tion.....	30	64	Bessemer process....	34	30
Elongation test of steel... ..	35	20	" for iron ores.	32	16
Engines, Blowing.....	32	18	Foaming in basic open-hearth		
Evaporating pans with heat be-			furnace.....	33	70
low.....	29	61	Foreblow of basic Bessemer		
Evaporation of brine by grain-			process.....	34	25
ers.....	29	6	Forehearth of Wellman rolling		
" of brine by vacu-			furnace.....	33	16
um pan process. 29	6	6	Forster valve.....	33	21
			" water-seal producer....	33	35
			Franklinite.....	32	6

INDEX

xv

	<i>Sec.</i>	<i>Page</i>		<i>Sec.</i>	<i>Page</i>
Frasch converter.....	27	49	G		
Fraser-Talbot mechanical producer.....	33	36	Gall-and-Montlaur process for potassium chlorate.....	30	85
Free acid, Determination of, in salt cake.....	31	19	Gas, Artificial, as fuel for open-hearth furnace.....	33	23
“ lime, Determination of, in black ash.....	31	21	“ Burner.....	27	13
Freezing process for the production of sulphuric monohydrate, Lunge.....	28	59	“ from bleaching-powder chambers, Testing of....	31	47
Freiberg process for removing arsenic from chamber acid.....	28	43	“ from decomposer, Analysis of.....	31	46
“ sulphureted hydrogen generator.....	28	44	“ from gasometer, Analysis of.....	31	30
Fuel for blast furnace.....	32	14	“ from sulphate pan, Analysis of.....	31	45
“ for cupola.....	34	6	“ Natural, as fuel for open-hearth furnace.....	33	30
“ for making producer gas.....	33	38	“ Natural, Composition of..	33	31
“ Gaseous, used in open-hearth furnaces.....	33	30	“ Producer.....	33	33
Fuming sulphuric acid.....	27	4	“ valves for open-hearth furnace.....	33	19
Furnace, Blast.....	33	26	Gaseous fuel used in open-hearth furnaces.....	33	30
“ Crucible.....	34	44	Gases from ammoniasaturator, Washing.....	29	24
“ for calcining sodium bicarbonate.....	29	27	“ lime-kiln, Analysis of....	31	30
“ for salt cake, Deacon's plus-pressure.	29	41	Gay-Lussac tower.....	28	21
“ Herreshoff, of the MacDougall type...	27	37	“ Lussac towers, Number of	28	37
“ Maletra-Fal ding.....	27	30	Gerster's formula.....	27	21
“ muffled, MacDougall type of.....	27	34	Gibb's electrolytic process for potassium chlorate.....	30	87
“ Open-hearth.....	33	6	Gilchrist condenser.....	28	18
“ open-hearth, Construction of.....	33	7	Gjers calcining kiln.....	32	10
“ pit.....	35	33	Glauber's salt.....	29	35
“ Rhenania muffled type of.....	27	31	Glover's tower.....	28	8
“ rolling, Advantages of.....	23	17	“ tower, Conditions in..	28	29
“ Spence, Reciprocating type of... ..	27	31	Grading of crude sulphur.....	27	9
“ Wellman rolling... ..	33	15	Grainers for evaporating brine	29	6
Furnaces and burners for the production of burner gas.....	27	23	Graphite.....	35	45
“ for Le Blanc process, Mechanical.....	29	51	“ for making crucibles.	34	46
“ for Le Blanc soda process.....	29	49	Greenwood process for the electrolysis of salt.....	30	74
“ for salt cake, Mechanical... ..	29	44	Grinding crystals of potassium chlorate.....	30	42
“ open-hearth, Capacity of.....	33	18	“ soda ash.....	29	63
“ Reheating.....	35	33	Gritting ore roaster.....	32	12
			H	<i>Sec.</i>	<i>Page</i>
			Hadfield's manganese steel....	34	59
			Hanging in blast furnace . . .	32	65
			Hargreaves-and-Bird process for the electrolysis of salt....	30	77
			Harrison-Blair brimstone burner.....	27	26
			Hart system for absorption of hydrochloric acid... ..	30	5
			Hasenclever method for purification of hydrochloric acid.	30	7

	<i>Sec.</i>	<i>Page</i>		<i>Sec.</i>	<i>Page</i>
Hearth materials, Basic.....	33	62	Hydrochloric acid, Qualitative tests for arsenic in.....	31	40
" materials, Neutral	33	63	" acid, Uses of.....	30	8
" of open-hearth furnace	33	44	Hydrogen sulphide.....	27	8
Hematite, Brown.....	32	4	" sulphide generator, Freiberg.....	28	44
" brown, Distribution of, in United States	32	6	" Sulphureted.	27	10
" Red.....	32	4			
" red, Distribution of, in United States..	32	6	I	<i>Sec.</i>	<i>Page</i>
Herreshoff furnace of the Mac-Dougall type.....	27	30	Ingot, Treatment of.....	35	32
Honeycomb in ingots.....	35	10	Inorganic sediment in brine, Determination of.....	31	2
Hopper of blast furnace.....	32	32	Insoluble matter, Determination of, in caustic bottoms.....	31	35
Hulin's process for the electrolysis of salt.....	30	60	" matter in limestone, Determination of..	31	4
Hydrates and solutions of sulphur trioxide.....	27	1	" matter in quicklime, Determination of..	31	6
" of sulphur trioxide, Nomenclature of..	27	3	Ions	30	60
Hydrochloric acid, Analysis of acid, Analysis of finished product	31	38	" Migration velocity of.....	30	62
" acid, Analysis of waste gases from absorption of.....	31	36	Iron, Arsenic in.....	32	55
" acid, Apparatus used for condensing.....	30	3	" Carbon in.....	32	55
" acid, Commercial	30	6	" Copper in.....	32	60
" acid, Condensation of.....	30	1	" Elements contained in....	32	55
" acid, Determination of arsenic in	31	39	" Grading of, by analysis..	32	54
" acid, Determination of hydrochloric acid in..	31	41	" Grading of, by fracture..	32	54
" acid, Determination of selenium in.....	31	40	" Manganese in.....	32	58
" acid, Determination of sulphuric acid in.....	31	39	" notch	32	31
" acid, Determination of sulphurous acid in.....	31	39	" notch, Trouble with.....	32	65
" acid, Oxidation of, by oxides of manganese	30	10	" ore, Valuation of.....	32	7
" acid, Process of manufacture of	30	1	" ores, Classification of ...	32	3
" acid, Purification of.....	30	7	" ores, Classification of....	32	53
" acid, Purification of, by the Deacon-Husenclaver process.....	30	24	" ores, Crushing.....	32	8
			" ores, Distribution of, in the United States.....	32	5
			" ores, Preparation of.....	32	7
			" ores, Roasting	32	9
			" ores, Washing.....	32	7
			" Phosphorus in	32	57
			" pyrites.....	27	8
			" Silicon in.....	32	57
			" Sulphur in.....	32	59
			" Titanium in.....	32	60
			K	<i>Sec.</i>	<i>Page</i>
			Kennedy's stove.....	32	25
			Kessler process, Concentration of sulphuric acid by.....	28	55
			Kestner automatic pump.....	28	25
			Kettle evaporation of brine....	29	5
			Killing steel	34	51
			L	<i>Sec.</i>	<i>Page</i>
			Ladle lining and patching.....	35	45
			" steel.....	33	27

INDEX

xvii

	<i>Sec.</i>	<i>Page</i>		<i>Sec.</i>	<i>Page</i>
Lead chambers.....	28	11	Lime used in the manufacture		
" chambers, Admission of			of sodium hydrate.....	29	75
" chambers, Conditions in.	28	30	Limestone.....	35	43
Le Blanc process, Advantages			" Analysis of.....	31	4
and disadvantages			" Determination of in-		
of mechanical fur-			soluble matter in.	31	4
nace in.....	29	54	" Determination of		
" process, Management			lime in.....	31	5
of mechanical fur-			" Determination of		
nace in.....	29	53	magnesia in.....	31	5
" process, Mechanical			" Efficiency of, as		
furnaces for.....	29	51	flux.....	23	17
" process, Waste in....	29	67	" used in Solvay pro-		
" soda process.....	29	46	cess.....	29	13
" soda process, Calcium			Limonite.....	32	4
carbonate for....	29	48	" Distribution of, in		
" soda process, Carbon			United States.....	32	6
for.....	29	48	Lining for cupola.....	34	6
" soda process, Details			" of acid Bessemer con-		
of.....	29	48	verter.....	34	14
" soda process, Fur-			" of basic converter.....	34	23
naces for.....	29	49	Linings, Acid and basic, for		
" soda process, Hand			open-hearth furnace	33	25
furnaces for.....	29	49	" Protection of blast-		
" soda process, Man-			furnace.....	32	28
agement of furnace			Liquid chlorine.....	30	29
for.....	29	50	Liquor, caustic, Analysis of...	31	33
" soda process, Raw			" from carbonators, An-		
materials for.....	29	47	alysis of.....	31	11
Le Sueur process for the elec-			Lixiviation of black ash.....	29	57
trolysis of salt.....	30	75	Loewig's process for manufac-		
Lime, Addition of, in basic			ture of sodium hydrate.....	29	83
open-hearth process..	33	69	Lump burner, Falding.....	27	27
" as hearth material.....	33	62	Lunge condenser.....	28	16
" caustic, Determination			" freezing process for the		
of, in caustic mud....	31	35	production of sulphu-		
" Determination of, in			ric monohydrate.....	28	59
limestone.....	31	4	" plate column.....	28	16
" Determination of, in salt			" plate tower for condens-		
cake.....	31	20	ing hydrochloric acid..	30	5
" free, Determination of,			Lye, carbonated, Analysis of...	31	24
in black ash.....	31	21	" from black ash, Analysis		
" kiln for making carbon			of.....	31	23
dioxide for Solvay			" from black ash, Determi-		
process.....	29	15	nation of caustic soda in	31	23
" kiln gases, Analysis of.	31	30	" from black ash, Determi-		
" kiln gases, Analysis of.	31	7	nation of salt in.....	31	23
" milk of, Analysis of....	31	14	" from black ash, Determi-		
" milk of, Determination			nation of silica, ferric		
of specific gravity of.	31	14	oxide, and alumina in...	31	24
" slaked, Analysis of.....	31	43	" from black ash, Determi-		
" total, Determination of,			nation of sodium carbo-		
in black ash.....	31	21	nate in.....	31	23
" used in making bleach-			" from black ash, Determi-		
ing powder.....	30	30	nation of sodium ferro-		
			cyanide in.....	31	24

	<i>Sec.</i>	<i>Page</i>		<i>Sec.</i>	<i>Page</i>
Lye from black ash, Determination of sodium sulphate in.....	31	21	Manganese steel.....	34	58
“ from black ash, Determination of sodium sulphide in.....	31	23	“ Weldon's process for the recovery of, from still liquors.....	30	16
“ from black ash, Determination of specific gravity of.....	31	23	Massick stove.....	32	25
“ from black ash, Determination of total alkali in..	31	23	Mechanical furnaces for salt cake.....	29	44
“ from black ash, Determination of total sulphur in	31	24	“ pans for the evaporation of tank liquor	29	63
“ Purification of.....	29	59	Metalloids, Removal of, in open-hearth acid process....	33	54
M			Microscopical examination of steel	35	15
MacDougall type of muffled furnace.....	27	34	Migration velocity of ions.....	30	63
Magnesia.....	35	42	Milk of lime, Analysis of.....	31	14
“ Determination of, in brine.....	31	3	“ of lime, Specific gravity of	31	14
“ Determination of, in limestone.....	31	5	Mill, Blooming	35	34
“ Determination of, in quicklime.....	31	6	“ Plate	35	36
“ Determination of, in salt cake.....	31	20	“ Slabbing.....	35	37
Magnesium carbonate, Determination of, in soda ash.....	31	17	“ Universal.....	35	37
Magnesite as hearth material..	33	63	“ Universal plate.....	35	37
Magnetite.....	32	4	Mills, Rolling.....	35	34
“ Distribution of, in United States.....	32	5	“ Steel.....	35	32
Maletra-Falading furnace.....	27	30	Mirabilite.....	29	35
Manganese, Effect of, in steel.	35	12	Mixed acid.....	28	58
“ in iron.....	32	58	Mixer for Bessemer process....	34	9
“ in Weldon mud, Determination of	31	44	Moisture, Determination of, in bicarbonate from filters.....	31	13
“ Loss of, in recarbonizing.....	34	39	“ Determination of, in manganese ore ..	31	41
“ ore, Analysis of... ..	31	41	Monell steel process.....	35	29
“ ore, Determination of acid necessary to decompose.....	31	43	Monohydrate of sulphur trioxide.....	27	3
“ ore, Determination of available oxygen in.....	31	42	Montejus's pump with acid egg	28	26
“ ore, Determination of carbon dioxide in.....	31	43	Mother liquor, Analysis of....	31	13
“ ore, Determination of moisture in	31	41	“ liquor, Determination of ammonia in	31	14
“ Oxidation of, in basic Bessemer process.....	34	27	“ liquor, Determination of salt in	31	14
			Mud, Caustic	29	33
			“ caustic, Analysis of.....	31	35
			“ Weldon.....	30	19
			“ Weldon, Analysis of	31	44
			Muffle roaster for salt cake....	29	41
			Muffled furnace, MacDougall type of.....	27	34
			“ type of furnace, Rhenania.....	27	34
			N		
			Natural gas as fuel for open-hearth furnace.....	33	30
			“ gas, Composition of..	33	31

	<i>Sec.</i>	<i>Page</i>		<i>Sec.</i>	<i>Page</i>
Natural gas, Introduction of, into furnace.....	33	32	Ore, Valuation of iron.....	32	7
Neutral hearth materials.....	33	62	Ores, Classification of iron.....	32	3
" refractories.....	35	43	Oven, Contact.....	27	53
Nickel, Effect of, in steel.....	35	14	" Nitrating.....	28	5
" steel.....	34	59	Oxides, Effect of, in steel.....	35	14
Niter oven, Definition of.....	27	25	Oxygen, available, Determination of, in manganese ore.....	31	42
Nitrating by potting.....	28	5	" Effect of, in steel.....	35	14
" by use of nitric acid.....	28	7			
" oven.....	28	5	P	<i>Sec.</i>	<i>Page</i>
Nitric-acid chlorine process.....	30	28	Pan process for the evaporation of brine.....	29	5
Nitrous vitriol.....	28	5	Pauli's method for purification of lye.....	29	60
Nitrosulphuric acid.....	28	3	Pechiney-Weldon method for removing cyanides from black ash.....	29	54
Nomenclature of solutions and hydrates of sulphur trioxide.....	27	3	Phosphorus, Effect of, in steel.....	35	13
Nordhausen sulphuric acid.....	27	4	" in iron.....	32	57
	O	<i>Sec.</i>	" Oxidation of, in basic Bessemer process.....	34	28
Ohm's law.....	30	59	Physical testing of steel.....	35	16
Open-hearth furnace.....	33	6	" testing of steel, Results in.....	35	25
" hearth furnace, Artificial gas as fuel for.....	33	32	Pig iron used in basic Bessemer process.....	34	22
" hearth furnace, acid, Calculation of charge of.....	33	47	Pigs.....	32	40
" hearth furnace, Capacity of.....	31	18	Pipe stoves for heating blast.....	52	19
" hearth furnace, Charge of acid.....	31	32	Pipes in ingots.....	35	10
" hearth furnace, Construction of.....	33	7	" in steel, Prevention of.....	35	11
" hearth furnace, Gas and air valves for.....	33	19	Pit furnace.....	35	33
" hearth furnace, Hearth of acid.....	33	44	Pitting in steel.....	35	10
" hearth furnace, Method of charging acid.....	33	46	Plate column, Lunge.....	28	16
" hearth furnace, Method of heating acid.....	33	52	" mill.....	35	36
" hearth furnace, Ports to.....	33	13	" mill, Universal.....	35	37
" hearth furnace, Roof of.....	33	7	" tower, Lunge, for condensing hydrochloric acid.....	30	5
" hearth furnaces, Gaseous fuel used in.....	33	30	Platinizing electrodes.....	30	51
" hearth process, Acid.....	33	44	Platinum black.....	27	46
" hearth process, Charge of acid.....	33	45	Polarization, Electric.....	30	63
" hearth process for steel.....	33	5	Ports to open-hearth furnace.....	33	13
" hearth process, Talbot continuous.....	35	25	Potassium chlorate.....	30	37
" roasters for salt cake.....	29	36	" chlorate, Analysis of.....	31	50
Ore, Addition of, in acid open-hearth process.....	33	55	" chlorate, Apparatus used in the manufacture of.....	30	38
" Definition of.....	32	8	" chlorate by Blumenberg electrolytic process.....	30	36
" Reduction of, in blast furnace.....	22	42	" chlorate by electrolysis.....	30	84
" Use of, in basic open-hearth process.....	33	71	" chlorate by Galland-Montlaure electrolytic process.....	30	45

	<i>Sec.</i>	<i>Page</i>		<i>Sec.</i>	<i>Page</i>
Potassium chlorate by Gibbs electrolytic process	30	87	Purification of lye.....	29	59
“ chlorate by the Corbin electrolytic process	30	86	Pyrite	32	5
“ chlorate, Determination of potassium chloride in ..	31	50	Pyrites burners.....	27	27
“ chlorate, Drying the crystals of	30	42	“ Copper and iron.....	27	8
“ chlorate, Grinding the crystals of	30	42	Pyrrhotites, Copper-nickel.....	27	8
“ chlorate, Lime used in the manufacture of.....	30	37			
“ chlorate, Process of manufacture of	30	38	Q	<i>Sec.</i>	<i>Page</i>
“ chlorate, Raw materials used in manufacture of.....	30	37	Qualitative tests for arsenic in hydrochloric acid	31	40
“ chlorate, Recrystallization of	30	41	Quicklime, Analysis of	31	5
“ chloride, Determination of, in potassium chlorate	31	50	“ Determination of calcium carbonate in.....	31	6
Pots, Caustic	29	80	“ Determination of free calcium oxide in.....	31	6
Potting	27	25	“ Determination of insoluble matter in.....	31	6
Pouring crucibles	34	52	“ Determination of magnesia in.....	31	6
Precipitation of arsenic in the Freiberg process.....	28	46			
Producer, Forter water-seal	33	35	R	<i>Sec.</i>	<i>Page</i>
“ Fraser-Talbot mechanical.....	33	36	Reactions in blast furnace.....	32	40
“ gas.....	33	33	“ of the chamber process for sulphuric acid	28	2
“ gas, Calorific value of.....	33	42	“ Producer	33	39
“ gas, Composition of	33	41	Reagents for Bunte burette	31	11
“ gas, Fuel for making	33	38	Recarbonization.....	34	33
“ Operation of.....	33	40	“ in the furnace	34	36
“ reactions.....	33	39	“ in the ladle.....	34	39
“ Siemens.....	33	33	Recarbonizers.....	34	34
Producers, Arrangement of.....	33	43	Recarbonizing, Darby method of	34	41
“ Water-seal.....	33	35	“ in acid Bessemer process	34	18
Protection of blast-furnace linings.....	32	28	“ with coal or coke.....	34	41
Pump, Kestner automatic.....	28	25	Reciprocating type of furnace, Spence	27	31
“ Montejus's with acid egg	28	26	Recrystallization of potassium chlorate	30	41
Pumps, Acid.....	28	25	Red hematite	32	4
Purification of brine for Solvay process.....	29	20	“ hematite, Distribution of, in United States.....	32	6
“ of chamber acid.....	28	42	“ liquors, Analysis of.....	31	25
“ of chamber acid from arsenic.....	28	43	“ liquors, Determination of sodium sulphide, sulphite, thiosulphate, and sulphate in	31	25
“ of hydrochloric acid.....	30	7	“ shortness.....	35	12
			Reduction of ore in blast furnace.....	32	43
			Refractories, Acid.....	35	39
			“ Basic.....	35	42

	<i>Sec.</i>	<i>Page</i>		<i>Sec.</i>	<i>Page</i>
Refractories, Clay.....	35	38	Salt cake, Determination of sodium sulphate in.....	31	20
" Neutral.....	35	43	" cake, Mechanical furnaces for.....	29	44
" Silicious.....	35	41	" cake, Open roasters for..	29	36
Refractory materials.....	35	37	" cake process, Analysis of materials for.....	31	17
" mixtures.....	35	45	" cake, Properties of.....	29	45
Regenerative stoves for heating blast.....	32	21	" cake, Salt for making....	29	35
Regenerator, Siemens.....	33	8	" cake, Sulphuric acid for making.....	29	36
Reheating furnaces.....	35	33	" cake, Uses for.....	29	45
" of burner gas.....	27	52	" cake, Yield of.....	29	45
Reich's test for sulphur dioxide in burner gas.....	27	36	" Denaturated.....	29	9
Resistance capacity.....	30	53	" Determination of, in ammoniacal brine.....	31	7
" electrical, Measurement of.....	30	47	" Determination of, in black ash.....	31	23
Rhenania muffled type of furnace.....	27	34	" Determination of, in caustic bottoms.....	31	35
Roaster, Davis-Colby ore.....	32	13	" Determination of, in caustic liquor.....	31	34
" Grittinger ore.....	32	12	" Determination of, in fished salts.....	31	34
Roasting iron ores.....	32	9	" Determination of, in lye from extraction of black ash.....	31	23
" Sources of loss of sulphur in.....	27	15	" Determination of, in mother liquor.....	31	14
Rock salt.....	29	3	" Determination of, in salt cake.....	31	19
Rolling furnace, Advantages of	33	17	" Determination of sodium chloride in.....	31	17
" furnace, Wellman.....	33	15	" Determination of sulphur trioxide in.....	31	18
" mills.....	35	34	" Determination of water in	31	17
Roof of open-hearth furnace...	33	7	" Electrolysis of.....	30	66
	S		" Electrolysis of, by Castner-Kellner process....	30	73
Sal mirabile.....	29	35	" Electrolysis of, by Greenwood process.....	30	74
Salt, Analysis of.....	31	17	" Electrolysis of, by Hargreave-and-Bird process.....	30	77
" cake.....	29	34	" Electrolysis of, by processes using a mercury cathode.....	30	78
" cake, Analysis of.....	31	19	" Electrolysis of, by processes using diaphragms	30	74
" cake, Apparatus and method of manufacture of.....	29	36	" Electrolysis of, by the Le Sueur process.....	30	75
" cake, Blind or muffle roaster for.....	29	41	" Electrolysis of, with dissolved electrolyte.....	30	73
" cake, Crude materials for	29	35	" Electrolysis of, with fused electrolyte.....	30	69
" cake, Deacon's plus-pressure for.....	29	41	" for making salt cake.....	29	35
" cake, Determination of alumina in.....	31	19			
" cake, Determination of ferric oxide in....	31	19			
" cake, Determination of free acid in.....	31	19			
" cake, Determination of lime in.....	31	20			
" cake, Determination of magnesia in.....	31	20			
" cake, Determination of matter insoluble in acids in.....	31	19			
" cake, Determination of salt in.....	31	19			

	<i>Sec.</i>	<i>Page</i>		<i>Sec.</i>	<i>Page</i>
Salt from brine.....	29	4	Soda, ammonia, Analysis of...	31	1
" from sea-water.....	29	1	" ammonia, Properties of...	29	31
" Occurrence of.....	29	1	" Artificial.....	29	11
" Rock.....	29	3	" ash, Analysis of.....	31	16
Sand for making crucibles....	34	48	" ash, Analysis of.....	31	27
Saniter process for desulphurization in basic open-hearth process.....	33	83	" ash, Determination of caustic soda in.....	31	28
Saturator for making ammoniacal brine.....	29	20	" ash, Determination of ferric oxide and alumina in	31	16
Scaffolds in blast furnace....	30	64	" ash, Determination of magnesium carbonate in.....	31	17
Sea-water, Salt from.....	29	1	" ash, Determination of silica in.....	31	16
Segregation in steel castings..	35	5	" ash, Determination of sodium bicarbonate in...	31	16
Selenium, Determination of, in hydrochloric acid.....	31	40	" ash, Determination of sodium carbonate in....	31	15
Settling pans for manufacture of potassium chlorate.....	30	40	" ash, Determination of sodium carbonate in....	31	28
Shank's lixiviation system of black ash.....	29	57	" ash, Determination of sodium carbonate in....	31	16
Shunt circuit.....	30	58	" ash, Determination of sodium sulphate in.....	31	17
Side blowing.....	34	18	" ash, Determination of sodium chloride in.....	31	16
Siemens producer.....	33	33	" ash, Determination of sodium sulphide in.....	31	26
" regenerator.....	33	8	" ash, Determination of total alkali in.....	31	28
" valve.....	33	20	" ash, Finished.....	29	64
Silica, Determination of, in lye from extraction of black ash.....	31	24	" ash, Grinding of.....	29	63
" Determination of, in soda ash.....	31	16	" ash, Methods of stating strength of.....	29	65
Silicious refractory materials..	35	41	" ash used in the manufacture of sodium hydrate	29	75
Silicon, Effect of, in steel.....	35	14	" by the Le Blanc process....	20	46
" in iron.....	32	57	" caustic, Analysis of.....	31	36
" Loss of, in recarbonizing.....	34	40	" crystal, Analysis of....	31	29
" Oxidation of, in basic Bessemer process.....	34	27	" crystals.....	29	63
Silicospiegel.....	34	34	" crystals, Calcination of..	29	63
Skew back.....	33	8	" Natural.....	29	9
Slab.....	35	34	" process, Cryolite.....	29	32
Slabbing mill.....	35	37	Sodium aluminate from cryolite soda process....	29	34
Slag, Basic open-hearth.....	33	74	" bicarbonate.....	29	64
" Composition of blast-furnace.....	32	45	" bicarbonate, Analysis of.....	31	32
" in acid open-hearth process.....	31	53	" bicarbonate, Calcination of.....	29	36
Slags, Blast-furnace.....	32	45	" bicarbonate, Determination of, in bicarbonate from filters.....	31	11
" Fusibility of blast-furnace.....	32	46	" bicarbonate, Determination of, in carbonated lye.....	31	25
" Handling of.....	32	47	" bicarbonate, Determination of, in soda ash	31	16
Slaked lime, Analysis of.....	31	43			
" lime, Determination of carbon dioxide in....	31	43			
" lime, Determination of water in.....	31	43			
Slipping in blast furnace.....	32	65			
Soaking pit.....	35	33			

INDEX

xxiii

	<i>Sec.</i>	<i>Page</i>		<i>Sec.</i>	<i>Page</i>
Sodium bicarbonate, Dry process for purification of	29	85	Sodium hydrate, Soda ash used in the manufacture of	29	73
“ bicarbonate, Wet process for purification of	29	84	“ hydrate, Uses of.....	29	83
“ carbonate	29	9	“ sulphate.....	29	34
“ carbonate, Causticizing	29	76	“ sulphate, Determination of, in black ash..	31	23
“ carbonate, Crystals of	29	63	“ sulphate, Determination of, in fished salts	31	34
“ carbonate, Determination of, in black ash..	31	23	“ sulphate, Determination of, in lye from extraction of black ash.....	31	24
“ carbonate, Determination of, in caustic bottoms.....	31	35	“ sulphate, Determination of, in red liquors	31	25
“ carbonate, Determination of, in caustic liquor.....	31	34	“ sulphate, Determination of, in salt cake..	31	20
“ carbonate, Determination of, in lye from extraction of black ash.....	31	23	“ sulphate, Determination of, in soda ash..	31	17
“ carbonate, Determination of, in soda ash..	31	16	“ sulphate for Le Blanc soda process.....	29	47
“ carbonate, Determination of, in soda ash..	31	28	“ sulphide, Determination of, in black ash..	31	22
“ carbonate, Uses of....	29	65	“ sulphide, Determination of, in lye from extraction of black ash.....	31	23
“ chlorate.....	30	42	“ sulphide, Determination of, in red liquors	31	25
“ chloride	29	1	“ sulphide, Determination of, in soda ash..	31	28
“ chloride, Determination of, in brine.....	31	3	“ thiosulphate.....	29	73
“ chloride, Determination of, in salt.....	31	17	“ thiosulphate, Determination of, in red liquors.....	31	25
“ chloride, Determination of, in soda ash..	31	16	Soft ball.....	29	51
“ compounds, total, Determination of, in tank waste.....	31	27	Solutions for resistance capacity.....	30	54
“ ferrocyanide, Determination of, in lye from extraction of black ash.....	31	24	Solvay process.....	29	11
“ hydrate.....	29	74	“ process, Ammonia lost in.....	29	31
“ hydrate, Crude materials used in manufacture of.....	29	75	“ process, Ammonia recovery in.....	29	28
“ hydrate, Details of process of manufacture of.....	29	76	“ process, Ammonia used in.....	29	14
“ hydrate, Evaporation of.....	29	78	“ process, Ammoniacal brine of.....	29	20
“ hydrate, Lime used in the manufacture of..	29	75	“ process, Brine used in..	29	14
“ hydrate, Loewig's process for manufacture of.....	29	83	“ process, Carbon dioxide for	29	15
“ hydrate, Removal of sulphur from.....	29	81	“ process, Carbonating ammoniacal brine for	29	21
			“ process, Carbonating tower for.....	29	22
			“ process, Coal and coke used in.....	29	15
			“ process, Details of.....	29	15

	<i>Sec.</i>	<i>Page</i>		<i>Sec.</i>	<i>Page</i>
Solvay process, Distiller liquor			Steel, Effect of copper, nickel,		
in.....	29	30	and aluminum in.....	35	14
" process, Filters for.....	29	24	" Effect of manganese in..	35	18
" process, Limestone			" Effect of oxides or oxy-		
used in	29	13	gen in.....	35	14
" process, Purification of			" Effect of phosphorus in.	35	13
brine for.....	29	20	" Effect of silicon in.....	35	14
" process, Raw materials			" Effect of sulphur in.....	35	13
used in.....	29	13	" Effects of work and heat		
" process, Washing of			on.....	35	21
carbon dioxide for...	29	18	" Effects of usual elements		
Sows.....	32	40	present in.....	35	11
Spathic ore.....	32	5	" Hadfield's manganese...	34	59
Specific gravity, Determina-			" History of manufacture		
tion of, of lye from			of	33	2
extraction of black			" ladle.....	33	27
ash.....	31	23	" ladle.....	34	19
" gravity of milk of			" making, Recent progress		
lime, Determination			in.....	35	25
of.....	31	14	" Manganese.....	34	58
" gravity of ammonia			" Microscopical examina-		
liquor, Determina-			tion of.....	35	15
tion of.....	31	6	" mills.....	35	32
" gravity of brine, De-			" Nickel.....	34	59
termination of.....	31	1	" Open-hearth process for	33	5
" gravity of caustic			" Physical testing of.....	35	16
liquor, Determina-			" Processes of manufac-		
tion of	31	33	ture of.....	33	3
" gravity of sulphuric			" Properties of, deter-		
acid, Determination			mined in testing.....	35	19
of.....	27	5	" Relation of chemical		
" gravity scale, Euro-			composition to strength		
pean, Baumé.....	27	6	of.....	35	22
" gravity scale, Twad-			" Results in physical test-		
dell.....	27	6	ing of.....	35	25
" gravity scale, United			" Superiority of crucible..	34	53
States Baumé.....	27	6	" Test pieces of.....	35	18
Spence reciprocating type of			" Tungsten.....	34	56
furnace.....	27	31	Steels, Alloy.....	34	56
Spiegeleisen.....	32	59	" Aluminum, copper, and		
"	34	34	titanium.....	34	60
Stahl method for removing ar-			Still for decomposition of hy-		
senic from chamber acid.....	28	17	drochloric acid by man-		
Steam, Admission of, to the			ganeses dioxide.....	30	12
lead chambers.....	28	33	" for recovery of ammonia		
Steel, Air-quenched.....	34	56	in Solvay process	29	29
" castings.....	35	1	" liquor, Determination of		
" castings, Blowholes in ..	35	9	free acid in.....	31	43
" castings, Composition of	35	3	" liquors from the decompo-		
" castings, Segregation in	35	5	sition of hydrochloric acid		
" castings, Solidity of.....	35	2	by manganese dioxide... ..	30	15
" Chemical examination of	35	16	Stopper head.....	33	27
" crucible, Composition of	34	54	Stoves for heating blast.....	32	19
" Defects in.....	35	5	" Pipe, for heating blast..	32	19
" Definition of.....	33	1	" Regenerative, for heat-		
" Effect of carbon in.....	35	12	ing blast.....	32	21

INDEX

xxv

	<i>Sec. Page</i>		<i>Sec. Page</i>
Strength of solutions weaker than the monohydrate, Commercial methods for determining the.....	27 5	Sulphuric acid, Chamber process for.....	28 1
Sulphides, metallic, Preparation of.....	27 11	" acid, Concentration and distillation of, starting with the Glover tower.....	28 56
Sulphur, Available.....	27 15	" acid, Concentration of, by the Kessler process.....	28 55
" available, Determination of, in tank waste.....	31 29	" acid, Concentration of dilute solutions of.....	28 46
" Available, in burner gas.....	27 14	" acid, Concentration of, in glass beakers or dishes.....	28 53
" Combustion of.....	27 12	" acid, Concentration of, in glass retorts or stills.....	28 52
" compounds, oxidizable, Determination of, in fished salts....	31 34	" acid, Concentration of, in iron.....	28 51
" dioxide or burner gas, Production of.....	27 21	" acid, Concentration of, in lead pans....	28 48
" dioxide, Reich's test for in burner gas....	27 36	" acid, Concentration of, in platinum....	28 49
" Effect of, in steel....	35 13	" acid, Conditions of, in the chambers..	28 30
" Grading of crude....	27 9	" acid, Conditions of, in the Glover tower.....	28 29
" in iron.....	32 59	" acid, Contact mass or material used in the manufacture of, by the contact process.....	27 45
" in tank waste, Recovery of, by Chance-Claus process.....	29 69	" acid, Control of chamber process for.....	28 38
" Oxidation of, in basic Bessemer process....	34 28	" acid, Definition of..	27 3
" recovered.....	27 8	" acid, Determination of, in hydrochloric acid.....	31 39
" Removal of, from Le Blanc caustic soda..	29 81	" acid, Determination of specific gravity or density of.....	27 5
" Sources of loss of, in roasting.....	27 15	" acid, Diagram of manufacture of... ..	28 60
" Thermochemistry of the combustion of..	27 12	" acid for making salt cake.....	29 36
" total, Determination of, in lye from extraction of black ash	31 24	" acid, Nordhausen or fuming	27 4
" trioxide, Determination of, in salt.....	31 18	" acid, Operation of chamber process for.....	28 28
" trioxide, Hydrates and solutions of ..	27 1	" acid, Preparation of raw material for manufacture of... ..	27 9
" trioxide in brine, Determination of.....	31 3		
" trioxide, Monohydrate of.....	27 3		
" trioxide, Nomenclature of solutions and hydrates of.....	27 3		
Sulphureted hydrogen.....	27 8		
" hydrogen generator, Freiberg.	28 41		
Sulphuric acid, Catalytic or contact process for the manufacture of.....	27 43		

INDEX

xxvii

	<i>Sec.</i>	<i>Page</i>		<i>Sec.</i>	<i>Page</i>
Water gas.....	33	34	Wellman charging machine...	33	25
“ seal producer.....	33	35	“ rolling furnace.....	33	15
“ seal producer, Forter...	33	35	“ rolling furnace, Forehearth of.....	33	16
Weldon and Deacon processes			Wheatstone bridge.....	30	47
for chlorine, Com- parison of.....	30	27	Whitwell stove.....	32	23
mud.....	30	19	Wootz steel.....	33	3
“ mud, Analysis of.....	31	44			
“ mud, Determination of manganese in	31	44	Y	<i>Sec.</i>	<i>Page</i>
“ mud, Determination of total base in	31	44	Yaryan evaporator.....	29	78
“ process for chlorine...	30	30	Yield, and method of calcula- ting yield of sulphuric hy- drate.....	27	17
“ process for the recov- ery of manganese from still liquors	30	16			
			Z	<i>Sec.</i>	<i>Page</i>
			Zinc blende.....	27	8

SULPHURIC ACID

(PART 1)

INTRODUCTION

1. General Remarks and Definitions.—Before considering the technology of *sulphuric acid*, it is of the greatest possible importance to have a clear idea as to just what sulphuric acid is and the place it occupies among the oxides and acids of sulphur. The technical processes to be described, instead of seeming complicated will then appear consequent and logical, and the bewildering chemical and commercial terminology with which the evolution of the manufacture has incrustated the subject will be cleared away, or at least will be more readily understood.

2. Hydrates and Solutions of Sulphur Trioxide.—It was stated in *Inorganic Chemistry* that sulphur trioxide SO_3 , when absolutely pure is a colorless, mobile liquid of 1.940 sp. gr. at $16^\circ C.$, and when cooled it solidifies into long, transparent prismatic crystals. If a little water is added, a mass of opaque, white, asbestos-like crystals will result, which melt at about $50^\circ C.$

If 10.11 per cent. of water is added to the pure sulphur trioxide, a transparent crystalline mass is obtained, melting at $35^\circ C.$ and readily decomposing at moderate heat into H_2SO_4 and SO_3 .

If 18.37 per cent. of water is added to pure sulphur trioxide, a limpid, colorless, oily fluid is obtained of 1.8372 sp. gr.

§ 27

For notice of copyright, see page immediately following the title page.

at 15° C. (Lunge 1.8385), which solidifies at 0° C. into large, plate-shaped crystals and readily decomposing at moderate heat into H_2O and SO_2 .

If 31.04 per cent. of water is added to the pure sulphur trioxide, large, clear, hexagonal, columnar crystals that melt at 8.5° C. are obtained.

All these mixtures of pure sulphur trioxide and water, or solutions of sulphur trioxide in water, possess characteristics, such as crystallization, melting points, change of volume, etc., that show them to be definite chemical compounds or hydrates of sulphur trioxide.

Again, if from 14 to 18 per cent. of water is added to pure sulphur trioxide, a thick, oily liquid that throws off dense white fumes on exposure to the air is obtained. These fumes are the vapor of sulphur trioxide combining with the moisture of the air and forming a non-volatile hydrate.

If 23.67 per cent. of water is added to the pure sulphur trioxide, a thick, oily liquid is obtained of 1.835 sp. gr. and stable at ordinary temperatures. This is the oil of vitriol of commerce, or 66° Baumé sulphuric acid (in the United States).

In the same way, water may be added in other percentages; in some cases hydrates, but nearly always simply solutions, result.

3. If these hydrates exist at low temperatures as definite crystalline compounds, and if on a rise of temperature they all decompose with more or less ease with the disengagement of either sulphur trioxide or water, and if in their ordinary form they present all the properties of simple solutions, it follows that between sulphur trioxide SO_2 and water H_2O there exists a consecutive series of homogeneous liquids or solutions, among which must be distinguished definite compounds, or hydrates; therefore, it is quite justifiable to look for other definite compounds between sulphur trioxide and water, which are distinguished by the variation of properties of any kind uniformly occurring with a solution of any uniform percentage of sulphur trioxide and water. Few of

2°

these variations of properties of definite solutions have been determined with sufficient accuracy.

In other words, the term **sulphuric acid** is the generic name of a series of solutions of sulphur trioxide in water, some of which are chemical hydrates of the sulphur trioxide and most of which are merely solutions of convenient strength for use in the arts.

4. In Table I are given the principal characteristics of the various commercial solutions of sulphur trioxide in water. The best known hydrates are also shown. It will be noticed that none of the hydrates are recognized commercially.

5. **Nomenclature of Solutions and Hydrates of Sulphur Trioxide.**—The term sulphuric acid is usually applied to the monohydrate of sulphur trioxide SO_3, H_2O , and yet at the same time it covers the whole range of hydrates and solutions containing a smaller percentage of SO_3 than the monohydrate, and also the hydrates and solutions containing more SO_3 than the monohydrate. As the moment that moisture is added to sulphur trioxide it becomes an acid, the term sulphuric acid therefore applies to the whole range of hydrates and solutions of SO_3 in water. There is no reason why the monohydrate should monopolize the term sulphuric acid other than the fact that it marks the margin of the acids of sulphuric trioxide that are stable in liquid form at ordinary temperatures; and even this is not quite correct, as the actual monohydrate itself, even at $40^\circ C.$, begins to give off fumes of sulphur trioxide, and even in a dry atmosphere becomes weaker until it contains 1.5 per cent. of water. At this point, however, it really becomes stable, so far as the separation of the sulphur trioxide is concerned, and in a dry atmosphere will remain unchanged.

It is this sulphuric acid that contains not more than 98.5 per cent. of H_2SO_4 , or 80.41 per cent. of SO_3 and 19.59 per cent. of water, that it has been possible to make by the

so-called *chamber process*, aided by concentration (evaporation of water) and by distillation, and which has therefore been commercially available. If stronger acid were required, recourse to the fortification of this acid by sulphur trioxide made at great cost was necessary. The 80.41-per-cent. SO_2 , or 98.5-per-cent. H_2SO_4 , or as near to it as possible, was fortified with sulphur trioxide until it became 81.63-per-cent. SO_3 acid (monohydrate), and if a greater strength or a so-called fuming acid were required, more sulphur trioxide was added, and the acid thus fortified considered as the monohydrate plus a certain percentage of free sulphur trioxide.

6. Nordhausen or Fuming Sulphuric Acid.—As until comparatively recently the only commercial sulphur trioxide was produced as a **fuming** or **Nordhausen acid** (i. e., an acid containing a greater percentage of sulphur trioxide than the monohydrate) and very costly to make, every effort was made to bring the chamber acid to its greatest strength (to eliminate by evaporation as much water as possible). For, as the proportion of sulphur trioxide to water in monohydrate is 81.63 to 18.37, every part of water in the acid to be fortified first requires 4.444 parts of sulphur trioxide to form the monohydrate before any so-called free sulphur trioxide or $H_2SO_4 + SO_3$ is obtained. With the one exception of pyrosulphuric acid, disulphuric acid, or solid oleum, terms applied to the hydrate $H_2S_2O_7$, or $2SO_3 + H_2O$, there is no nomenclature that covers the whole range of acids from the monohydrate, or 81.63-per-cent. sulphur trioxide, to the sulphur trioxide itself, except the terms fuming or Nordhausen acids; the first is descriptive of a characteristic of these acids and the second is the name of a town in Prussian Saxony where a warehouse for the storage of these acids was located, the factories being at Braunlage, Goslar, and other places.

As, therefore, the term sulphuric acid is used not only to define the actual sulphuric monohydrate, but also to describe the whole range of hydrates and solutions of sulphur trioxide, it becomes necessary for *accurate* expression

to define the hydrate or solution referred to in terms of percentage of sulphur trioxide contained in it. When acids stronger than commercial oil of vitriol (76.33 per cent. of SO_3) were rare and acidum sulphuricum distillatum (80.41 per cent. of SO_3) was the strongest commercial acid known, it was, of course, natural that the strength of all acids should be referred to the monohydrate, or nearest, hydrate.

7. Commercial Methods for Determining the Strength of Solutions Weaker than the Monohydrate. For ascertaining the strength of those solutions weaker than the monohydrate, recourse is had to their specific gravity—a fairly accurate method up to a certain point, but uncertain just about the reference point (monohydrate), as in passing from 79.99 per cent. of SO_3 (98 per cent. of H_2SO_4) to 81.63 per cent. of SO_3 (100 per cent. of H_2SO_4) the specific gravity decreases from 1.8415 to 1.8372. The specific gravity, however, rises just so soon as the monohydrate point is passed and SO_3 is slightly in excess.

In commercial acids a further cause of inaccuracy exists, owing to the effect on the specific gravity of the almost constant impurities present. Furthermore, commercial methods of observing the specific gravity are neither uniform nor accurate, even apart from the inaccuracy of the instruments themselves.

8. Specific-Gravity, or Density, Determinations.—The hydrometer used in connection with sulphuric acid is simply an instrument for determining its specific gravity, or density, in comparison with distilled water at 15° C. (or 60° F. in the United States). With commercial acids the use of the hydrometer should be limited to the solutions containing up to 76.33 per cent. of SO_3 (93.5 per cent. of H_2SO_4). Specific-gravity determinations beyond this point are unreliable on account of impurities in the acid, and all determinations above this point should be made alkalimetrically. Apparently, it should be easy to make the hydrometric scale an exact basis of universal calculation, but in practice there are many different hydrometer scales. One of the

difficulties is the uncertainty as to the standard of maximum density. In Europe this is generally understood to be 1.842 sp. gr. at 15° C., or 66° Baumé. As this specific gravity would correspond to a fuming acid, it is difficult to see on what this standard is based. The specific gravities of solutions of sulphur trioxide, just between 97 and 100 per cent. of H_2SO_4 (79.19 and 81.63 per cent. of SO_3), are given in Table II.

TABLE II

SPECIFIC GRAVITY OF SOLUTIONS OF SULPHUR TRIOXIDE

H_2SO_4	SO_3	Specific Gravity
97.00	79.19	1.8410
97.70	79.76	1.8415
98.20	80.16	1.8410
98.70	80.57	1.8405
99.20	80.98	1.8400
99.45	81.18	1.8395
99.70	81.39	1.8390
99.95	81.59	1.8385
100.00	81.63	1.8372

9. In England, the Twaddell scale starts with a maximum specific gravity of 1.850, or 170°. Each intermediate degree represents a difference of .005 in specific gravity. In the United States, the Baumé scale is also used, the 66°, however, corresponding to 93.5 per cent. of H_2SO_4 , or 76.3265 per cent. of SO_3 , or a specific gravity of 1.835.

The modulus, or formula of division, where d = specific gravity and n = the number of degrees, for the European Baumé is

$$d = \frac{144.3}{144.3 - n},$$

and for the United States Baumé is

$$d = \frac{145}{145 - n}.$$

Throughout this work, the United States Baumé is used, as it is the one universally adopted by sulphuric-acid manufacturers in this country. In addition to these scales, those of Gerlach and others are used in different parts of Europe and in different factories in the same country. All of which tends to show that the only precise and accurate way of describing the acids of sulphur trioxide is in terms of percentage contents of such oxide.

PRINCIPLES GOVERNING THE MANUFACTURE OF SULPHURIC ACID

10. When sulphur dioxide SO_2 and oxygen are brought together under certain conditions, they combine to form sulphur trioxide SO_3 . This in the presence of water vapor becomes hydrated, and these hydrates are known as sulphuric acid. The conditions under which sulphur dioxide and oxygen may combine are varied. For the commercial manufacture of sulphuric acid, this combination is brought about in two ways.

1. By what is known as *contact* or *catalytic action*, the two gases are brought together in the presence of certain substances, as finely divided platinum, and other substances described farther on, that have the peculiar power to cause them to unite chemically. The dry sulphur trioxide thus formed is absorbed in the proper amount of water, to give an acid of the desired strength.

2. The two gases are brought together in the presence of steam and some of the higher oxides of nitrogen, as, for instance, N_2O_5 . The oxide of nitrogen gives up oxygen to the sulphur dioxide and forms, in the presence of water vapor, sulphuric acid. The lower oxide of nitrogen formed immediately takes up oxygen from the air present and is regenerated.

The reaction is quite complicated but is continuous. A small amount of oxide of nitrogen serves to oxidize an

indefinite amount of sulphur dioxide to the trioxide. This is the reaction used in the so-called *chamber process*.

In the discussion of the two processes for the manufacture of sulphuric acid, the above-mentioned reactions will be quite fully dealt with. Before discussing these, however, the various sources of sulphur and the preparation of sulphur dioxide will be taken up.

11. Raw Materials Used in the Manufacture of Sulphuric Acid.—Commercial sulphuric acid is derived from the following raw materials:

1. Brimstone (*a*) derived from sedimentary deposits accompanied by or derived from gypsum, found in Sicily, Louisiana, etc.; (*b*) derived to a limited extent from volcanic deposits (Solfatara).

2. Recovered sulphur (*a*) from alkali waste (Chance and Klaus processes); (*b*) from spent oxides from gas works.

3. Sulphureted hydrogen obtained as a by-product in the manufacture of ammonium sulphate, etc.

4. Iron pyrites, in which the principal value is the sulphur.

5. Iron pyrites with copper pyrites, in which the principal value is copper (sometimes also gold and silver) and the sulphur may be considered as a metallurgical by-product.

6. Zinc blende, in which the principal value is zinc.

7. Copper-nickel pyrrhotites, in which the principal value is the metal.

8. Copperas slate (*Vitriolschiefer*), which is oxidized to ferrous and then to ferric sulphate in the Nordhausen process for the manufacture of fuming sulphuric acid; also other acid sulphates of the alkalies, which, upon being heated, are first changed into pyrosulphates and then split up into neutral sulphates and sulphur trioxide.

It will be noted that these raw materials divide themselves into the following classes: (*a*) Where the sulphur is the principal or only value, as brimstone and most iron pyrites; (*b*) where the sulphur is a recovered or a by-product from a

previous chemical process, and, therefore, only available locally or under special conditions, as hydrogen sulphide, alkali waste, etc; (*c*) where the sulphur is of secondary value and is virtually a waste product in a metallurgical operation; (*d*) where the sulphur is derived from sources that are only suited on account of their cost for special processes and products, as the various sulphates.

12. The history of the manufacture of sulphuric acid commercially shows, as may be expected, that at first brimstone, as being technically the simplest raw material, was exclusively used. This was, in turn, supplanted by iron pyrites. Iron pyrites are now being largely driven out by the waste gas produced in the desulphurization of copper, zinc, nickel, gold, and silver ores, and it is not difficult to see that in time the great bulk of acid will be produced as an adjunct to the various metallurgical processes. Literally, in the United States thousands of tons of sulphur are being delivered into the air as sulphurous gas every day of the year by the various metallurgical works. The capital invested in the present plants, the capital cost of making the necessary changes to render the gas available, remoteness from present markets, and other necessary costly adjustments alone prevent this sulphur from being recovered as sulphuric acid.

As to the use of sulphates for the manufacture of fuming acid, this industry is practically dead, having been replaced entirely by the catalytic or contact process described farther on.

13. Preparation of the Raw Material. — Brimstone or sulphur requires little or no preparation, as it comes to the market in suitable condition to be put into the burners. Crude sulphur in the Sicilian warehouses is graded according to its purity and also, in a way, according to the method employed in its extraction.

Grading is done by simple inspection, without sampling or assaying. Three qualities are recognized: *firsts*, *seconds*, and *thirds*. Light-colored sulphurs are included in the first

two grades and darker varieties in the thirds. Seconds and thirds are subdivided into "vantaggiata," "buona," and "corrente." Firsts are nearly chemically pure and of a canary-yellow color, while seconds vantaggiata are but slightly inferior. Seconds buona have a fine chrome-yellow color; seconds corrente have a dirty yellow color; and thirds are chocolate brown on the exterior, shading to greenish brown inside.

14. For the American trade, two special classes are made, *seconda uso America*, best seconds, which is a mixture of seconds corrente and thirds vantaggiata; and *terza uso America*, best thirds, a mixture of terza vantaggiata and terza buona. The chemical purity of these classes differs comparatively little. The various grades of seconds range from 99.85 to 99.70 sulphur; and of thirds, from 99.64 to 99.58 sulphur. The principal difference—namely, that of color—is due to temperature and other points connected with the fusion.

15. The spent oxides of gas works, which contain sulphur, are first treated for the recovery of the salts of ammonia, ferrocyanides, and sulphocyanides, and are then roasted as if they were the fines, or dust, of the metallic sulphides and in the same class of furnaces.

16. Sulphureted hydrogen, when ignited in the air, burns with a blue flame, water and sulphur dioxide resulting

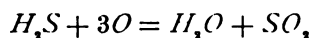

with limited air access, or when the flame is cooled by the introduction of a cold body; only hydrogen burns and the free sulphur separates. Advantage is taken of this reaction to use the hydrogen sulphide produced in the Chance process for the utilization of alkali waste for the manufacture of sulphuric acid; or by the Klaus process, for the recovery of sulphur. The hydrogen-sulphide gas is simply burned in a suitable combustion chamber and the resulting SO_2 passed to the lead chambers, or otherwise oxidized to SO_3 .

17. The **metallic sulphides**, the bisulphides of iron, or iron and copper pyrites, can be roasted both in the form of small lumps or as dust, or fines, and by their own heat of combustion alone. The monosulphides, or copper- or nickel-bearing pyrrhotites and zinc blendes must be roasted as fines and with the aid of additional fuel. Many pyrites are so friable as to crumble to fines when being mined, and many pyrites carrying copper, gold, silver, and other valuable metals are in the form of concentrates, or fines; such ores are disseminated, when found, among large proportions of quartz or other gangue matter, or consist of the sulphides of several metals, which it is desirable to separate before further metallurgical treatment.

If these ores occur in massive form, they must first be broken into small pieces. This is done either by hand or by rock breakers. The method used will depend on local conditions, such as cost of labor, etc., and on the mechanical condition of the ore, such as friability, etc. The ore must then be screened and sized. As a rule, except in the case of a very free-burning iron pyrite or under special conditions, such as extreme friability of the ore and insufficient facilities for roasting the fines, the largest size produced should pass through a 3-inch ring; the next size should pass through a 2-inch ring; and so on. Too much emphasis cannot be given to the necessity for properly sizing the ore and burning one size only in the same burner. This applies not only to the lump ore but also to the smalls and fines.

18. In the first place, it is evident that for a "dead" roast, or a roast of equal efficiency, the capacity of any given furnace will be controlled by the time taken to roast the largest pieces. Therefore, to secure the efficient and economical use of costly apparatus, the economy of power and labor, or in other words, maximum output at minimum cost, it is necessary to have a reasonably close sizing of the charge of raw ore to any given furnace. Moreover, that serious class of troubles met with in roasting ores, called *clinkering*, *scarring*, etc., and much of the labor of breaking

up and barring the bed of ore in a lump burner is the direct result of improper sizing. These scars, or clinkers, are really the formation of a fusible matte of ferrous sulphide FeS , owing to the irregular passage of air through the bed of ore on the furnace grates. If the ore is reasonably sized, air will be uniformly admitted through the bed and each piece of ore will get sufficient air for its complete oxidation. Moreover, the resulting regularity in the condition of the furnaces will tend to produce uniformity in the conditions of the burner-gas and the acid-making process.

19. Combustion of Sulphur and Its Thermochemistry.—When brimstone or a metallic sulphide is heated in the air, or burned, the following reaction takes place:

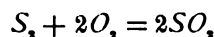

In this respect, the combustion of sulphur appears to form an exception to the general rule of thermochemistry—viz., that where two or more compounds are possible as the products of chemical combination, that product will be formed which produces the greatest heat in the reaction; for example, C and O can form carbon monoxide CO or carbon dioxide CO_2 , and carbon dioxide is the usual product of complete combustion; sulphur and oxygen can form sulphur dioxide SO_2 and sulphur trioxide SO_3 , yet sulphur dioxide is the usual product of combustion. The reason for this is that the heat of the oxidation of sulphur to the trioxide is so great as to cause the dissociation of the trioxide into the dioxide and oxygen, or in other words, that the difference in the temperature of the production and dissociation of sulphur trioxide is so slight that unless some means are taken to carry off the heat of the reaction effectively it cannot exist. This fact becomes highly important in the consideration of the various contact processes.

As a matter of fact, the gas produced by the combustion of brimstone or the metallic sulphides *always* contains varying proportions of sulphur trioxide, so that technically the equation given above does not quite represent the reaction of the combustion of sulphur in air.

The fact that the burner gas contains varying quantities of sulphur trioxide is shown by the formation of free sulphuric acid, when such gases are washed in water or dilute sulphuric acid or passed over iron filings before being used in the manufacture of sulphite pulp.

20. Burner Gas.—Burner gas, whether derived from the combustion of brimstone or the metallic sulphides, forms the basis of the manufacture of sulphur trioxide and all its hydrates and solutions. It consists, according to the raw material used, of a mixture of sulphur dioxide and sulphur trioxide, nitrogen, oxygen, and many impurities, such as flue dust, iron, silica, arsenious and hydrofluoric acids, and compounds of selenium, thallium, zinc, lead, etc.

21. As air consists approximately of 79 parts, by volume, of nitrogen and 21 parts, by volume, of oxygen, and as 1 volume of oxygen on combining with sulphur forms 1 volume of sulphur dioxide, which in turn requires $\frac{1}{2}$ volume of oxygen to form the trioxide, it is plain that 14 per cent. of sulphur dioxide in the burner gas is the highest theoretical percentage possible; as each 14 volumes of sulphur dioxide containing 14 volumes of oxygen requires 7 volumes of oxygen to form sulphur trioxide, or 21 volumes of oxygen in all, in which case the burner gas would contain the following:

Volumes of oxygen as sulphur dioxide.....	14
Volumes of oxygen to form sulphur trioxide....	7
Volumes of nitrogen.....	79
	—
Total	100

In practice, however, even if pure sulphur is used to produce the burner gas, this percentage would not be practicable, as no matter what process is used a certain excess of oxygen is found necessary. This excess of oxygen is usually not less than 5 per cent. and the proportions therefore are about as follows:

Volumes of oxygen as sulphur dioxide.....	14.0
Volumes of oxygen to form sulphur trioxide..	7.0
Volumes of oxygen excess.....	5.0
Volumes of nitrogen with the sulphur trioxide	79.0
Volumes of nitrogen with the excess of oxygen	18.8
Total.....	<u>123.8</u>

From which it is evident that even when burning brimstone or pure sulphur, the percentage of sulphur dioxide in the burner gas should not exceed 11 per cent. As a matter of practice, 10 per cent. is rarely exceeded, as with less air sublimation of the sulphur is likely to take place unless great care is used.

22. When the question is one of roasting the metallic sulphides, it is evident that the matter is further complicated, as oxygen (and with it nitrogen) must not only be admitted to oxidize the sulphur to the trioxide and to provide for the necessary excess, but also to oxidize the metallic contents of the ore. The calculation will, of course, be different for the various ores used, but it may be stated in general terms that the burner gas produced when burning the metallic sulphides should range from 5 to 8 per cent. of sulphur dioxide. A less percentage than 5 per cent. can only be used (on account of its dilution with inert nitrogen) at the expense of a larger and, therefore, more expensive plant; nor, with reasonably well-constructed burners, need the percentage of sulphur dioxide fall below 5 per cent. unless under very exceptional circumstances.

23. Available Sulphur.—As all the raw material for the production of burner gas contains varying quantities of impurities, and as it is quite impossible, at the temperatures existing in the various furnaces used in sulphuric-acid manufacture, to entirely desulphurize any of these raw materials—various percentages of sulphur remaining in the ash or cinder—it is manifestly advisable to base figures relating

to the process or yield upon the amount of sulphur actually available or existing in the burner gas as oxides of sulphur SO_2 or SO_3 . The loss in the desulphurizing process is estimated separately, and it is to this available sulphur that

all calculations will refer. Certain losses of sulphur occur in the process of desulphurizing by the escape of gas during charging and discharging and the various manipulations connected with the roasting. Losses also occur by partially roasted ore passing through the furnace; this is generally due to carelessness on the part of the burner men. Other quite unavoidable losses are caused by the temperature of the furnace being insufficient to convert the sulphides of certain metals occurring with the iron pyrites into oxides, they remaining in the cinder as sulphates.

TABLE III

Each per cent. contained in pyrites of.....	Zn	.5
Will render unavailable per cent. of sulphur	ZnO	.39
	Cu	.5
	CuO	.4
	Pb	.15
	PbO	.14
	CaO	.57
	MgO	.8
	Fe ₂ O ₃	.6

24. Sources of Loss of Sulphur in Roasting.—As the metallic sulphides are sold to sulphuric-acid manufacturers on the basis of total sulphur contents, it is well, in comparing the relative values of any ores, to consider how much sulphur will be inevitably bound in this way as sulphates in the cinder and therefore, under no condition will be of value to the manufacturer or available for oxidation to the trioxide.

Table III is based on the assumption that all these sulphides are converted to sulphates, which is by no means the case.

25. The following illustrations show what is meant by “available” sulphur, the cause of loss of sulphur in roasting, and the relation

of this loss to the yield or output of acid and to the value of any given ore to the manufacturer.

ILLUSTRATION 1.—An iron bisulphide of great purity, such as the Aguas Tenidas in Spain, contains:

Iron.....	46.60%
Sulphur.....	53.15%
Silica.....	.20%
Arsenic	} Traces
Copper	
Silver	
Gold	

Such an ore with reasonable care can be roasted down so that the cinders will not contain more than .5 per cent. of sulphur. As the cinders will weigh only about 80 per cent. of the ore, the total loss of sulphur will be only .4 per cent., and this, so far as the metallic sulphides are concerned, would seem in practice to be the irreducible minimum, the manufacturer obtaining from the ore 52.75 per cent. of sulphur, or 99.24 per cent. of the sulphur for which he pays. In addition to this loss, there will be more or less loss from the escape of gas from the burners, varying with the excellence of construction of the burners and the care exercised by the burner men. Other losses at the burners will amount, say, in all to .6 per cent., making the total loss in ore buying and roasting 1 per cent. of the sulphur contents, leaving 98.12 per cent. of the sulphur *available* for acid making, or as sulphur oxides in the burner gas.

ILLUSTRATION 2.—A Norwegian pyrites contains by analysis:

Sulphur.....	44.50	Lime.....	2.10
Iron.....	39.22	Magnesia.....	.01
Copper.....	1.80	Oxygen, as Fe_2O_3 ..	.50
Zinc.....	1.18	Insoluble.....	10.70

It is plain that on a complex ore of this nature the loss in roasting the bisulphide cannot be less than the loss in roasting the ore of the previous example, or .5 per cent., in addition to which the ore contains impurities that will hold sulphur in the cinders as sulphates, as stated in the above table. The roasting losses will stand as follows:

	Percentage of Sulphur
Roasting loss on bisulphide of iron in cinders.....	.40
Sulphate of zinc in cinders, 1.18 at .50.....	.59
Sulphate of copper in cinders, 1.80 at .50.....	.90
Sulphate of lime in cinders, 2.10 at .57.....	1.20
Sulphate of magnesia in cinders, .01 at .80.....	.08
Sulphate of iron in cinders, .50 at .60.....	.30
Total loss.....	3.39

In such an ore, therefore, the manufacturer will under no circumstances be able to obtain from the ore more than 41.11 per cent. of the

sulphur, or 92.38 per cent. of the sulphur for which he pays. Adding the further loss of .6 per cent. of sulphur in gas, etc. in the roasting process, it brings his total loss up to 3.99 per cent. of sulphur, leaving 40.51 units of sulphur, or 91 per cent. of the sulphur, available for acid making or as sulphur oxides in the burner gas.

In purchasing ore, it is further necessary to consider the effect of low-sulphur contents on costs of freight, labor of handling, and room taken up in the furnaces and storage bins, etc.; for instance, in purchasing brimstone, 1 per cent. of these costs, at the outside, is on waste material, while in dealing with an ore containing 50 per cent. of available sulphur, 50 per cent. of these costs on the above accounts is on waste material, and so on.

26. Yield and Method of Calculating Yield of Sulphuric Hydrate.—The possible theoretical yield obtainable from 1 unit of actual sulphur, say 1 pound or 1 kilogram, is 2.5 pounds or kilograms of sulphur trioxide or 3.0625 pounds or kilograms of sulphuric monohydrate H_2SO_4 , which corresponds to 100 per cent. of either of the above products; of course, such yields are never realized in practice. A yield of 98 per cent. (2.45 pounds of sulphur trioxide or 3.0013 of H_2SO_4) is probably the extreme average limit of even the best-managed and best-constructed acid works, while 97 per cent., or even 96 per cent., is considered extremely good average work.

As these figures are based on actual chemically pure sulphur, the importance of the above remarks becomes evident. At various factories, various and very loose data are used for the calculation of yield. Some factories express their yield in terms of sulphur shown by assay in the ore, without reference to the loss shown by sulphur held as sulphates, which can, under no circumstances, be recovered. Others neglect the gas losses in the desulphurizing furnaces. The safest way is to consider the available sulphur as that actually contained in the burner gas as sulphur oxides; or in practice to deduct from the assay value in sulphur of any particular ore a sufficient percentage to allow for the inevitable loss in the cinder and gas at the furnaces.

TABLE IV
YIELDS IN POUNDS OR KILOGRAMS OF SULPHURIC-ACID SOLUTION PER 100 POUNDS OR KILOGRAMS OF AVAILABLE SULPHUR OR SULPHUR OXIDES ACTUALLY CONTAINED IN BURNER GAS

Percentage of Theoretical	Sulphuric Anhydride $SO_3 = 100\%$	$\left\{ \begin{array}{l} SO_3 = 60\% \\ H_2SO_4 = 40\% \end{array} \right\}$ $SO_3 = 92.65\%$	$\left\{ \begin{array}{l} SO_3 = 40\% \\ H_2SO_4 = 60\% \end{array} \right\}$ $SO_3 = 88.98\%$	$\left\{ \begin{array}{l} SO_3 = 20\% \\ H_2SO_4 = 80\% \end{array} \right\}$ $SO_3 = 85.81\%$	Monohydrate $H_2SO_4 = 100\%$ $SO_3 = 81.6926\%$	Distilled $H_2SO_4 = 98.5\%$ $SO_3 = 80.41\%$	Extra Concentrated $H_2SO_4 = 97\%$ $SO_3 = 79.18\%$	Oil of Vitriol $H_2SO_4 = 93.5\%$ $SO_3 = 76.33\%$	Glover-Tower Acid $H_2SO_4 = 81.35\%$ $SO_3 = 66.41\%$	Pan Acid $H_2SO_4 = 77.6\%$ $SO_3 = 63.35\%$	Chamber Acid $H_2SO_4 = 63.18\%$ $SO_3 = 50.76\%$
100	Pounds 250.00	Pounds 269.83	Pounds 280.96	Pounds 293.05	Pounds 306.25	Pounds 310.91	Pounds 315.73	Pounds 327.53	Pounds 376.45	Pounds 394.63	Pounds 492.51
99	247.50	267.13	278.15	290.12	303.19	307.80	312.56	324.26	372.69	390.70	487.59
98	245.00	264.43	275.34	287.19	300.13	304.69	309.41	320.99	368.93	386.76	482.67
97	242.50	261.74	272.53	284.36	297.06	301.58	306.25	317.72	365.17	383.81	477.74
96	240.00	259.04	269.72	281.33	294.00	298.47	303.09	314.44	361.40	378.86	472.82
95	237.50	256.34	266.91	278.40	290.94	295.36	299.93	311.16	357.64	374.92	467.89

The same laxity is shown in estimating the consumption of nitrate of soda used in the chamber process. At one factory it will be expressed in terms of the actual available sulphur; at another, on the sulphur assay of the ore used; at another, even on the tonnage of pyrites burned. In the case, therefore, of a factory using an ore containing 42 per cent. of sulphur by assay, of which 38 per cent. only was actually available, the percentage of sodium nitrate is actually at different factories expressed as follows:

Sodium nitrate used per ton of ore.....	1.14%
Sodium nitrate used per ton of sulphur by assay.....	2.71%
Sodium nitrate used per ton of sulphur actually available.....	3.00%

27. Table IV covers the yields, on actual sulphur, of the principal solutions of sulphur trioxide in practical use.

The estimation of yield in a factory is not a very simple matter. In fact, it is impossible to obtain the actual yield except as the general average of a great number of observations and measurements extending over a considerable period.

28. Sometimes every day, though usually once a week, a record is taken of all the acid of various strengths in all the apparatus and storage tanks of the system. The dimensions of all this apparatus are usually tabulated, so that every inch in depth corresponds to a certain cubic capacity. The cubic contents of the acid of different strengths being thus ascertained, all these acids of different strengths are reduced by Table I to one strength—in a fertilizer factory, for instance, to terms of 50° Baumé; in other factories to terms of monohydrate, or 66° Baumé.

In reducing these acids, careful note should be taken of their temperature—although this is not usually done, the error probably being considered as a constant one. In this allowance for temperature, Table V is used by the Manufacturers' Association of the United States.

TABLE V

 ALLOWANCE FOR TEMPERATURE

At 10° Baumé	46.	Fahrenheit = 1° Baumé
20° Baumé	31.8	Fahrenheit = 1° Baumé
30° Baumé	30.25	Fahrenheit = 1° Baumé
40° Baumé	31.46	Fahrenheit = 1° Baumé
50° Baumé	34.69	Fahrenheit = 1° Baumé
60° Baumé	40.00	Fahrenheit = 1° Baumé
66° Baumé	43.24	Fahrenheit = 1° Baumé

From the total stock of acid obtained in this way is deducted the amount on hand at the previous time of stock taking; and the amount deducted from stock during the period, either for use in other departments or sold, is added. The result gives approximately the amount made during the intervening period, and the yield is deduced either from Table V or by calculation from the amount of sulphur used during that period, a record of which has also been kept. These records and measurements are usually taken by the superintendent or acid maker and are checked by him at intervals, together with some one of the proprietors or general officers of the company. After a certain time, the general average of the work done at any given plant can be ascertained with fair accuracy so long as the same raw material is used and the sulphur available has been determined with sufficient accuracy.

29. Sometimes the yield is roughly estimated, especially in the contact process, by the difference in content of sulphur oxides contained in the burner and exit gases. The formula given in Art. **53**, for use in testing the burner gas, enables this calculation to be made.

30. Another calculation that must often be made by an acid maker is in connection with the mixing of acids of

various strengths in such a way as to produce an acid of any desired strength. This is done by Gerster's formula for mixing a strong solution of sulphur trioxide with a weak solution of sulphur trioxide to produce an intermediate solution of sulphur trioxide of any desired strength. This formula is as follows:

$$x = 100 \frac{b - a}{a - c}, \quad (1.)$$

when x = quantity of weak solution required to mix with 100 parts of the strong solution;
 a = total sulphur trioxide in 100 parts of the solution desired;
 b = total sulphur trioxide in 100 parts of the strong solution;
 c = total sulphur trioxide in 100 parts of weak solution.

When the percentages of the solutions are given in terms of monohydrate instead of sulphur trioxide, it is only necessary to multiply the percentages of the monohydrate H_2SO_4 by .816326 to reduce them to terms of SO_3 , as mentioned in Table I.

THE PRODUCTION OF SULPHUR DIOXIDE OR BURNER GAS

31. General Remarks.—Commercial processes for the manufacture of sulphuric acid are not intermittent, but continuous. It follows, therefore, that to secure regularity in these processes all the separate factors must be as regular and uniform as it is possible to make them. Furthermore, the process consists of a series of chemical combinations, which in any given plant are proportioned as to volume to the size of that plant. If absolute regularity can be secured in the various chemical combinations, then the maximum work or output will be secured from such plant. Any irregularities will result either in an incomplete series of

combinations and consequent waste of raw material, or a reduction in output and consequent waste of capital outlay, owing to incomplete utilization of the plant, or both.

The first requisite, therefore, in sulphuric-acid manufacture is a uniform steady stream of gas of constant composition and volume. This gas should be produced at the least cost for labor and repairs and with as complete an oxidation of the sulphur in the furnace as possible. Unfortunately, all furnaces, except some mechanical furnaces for desulphurizing fines and one or two furnaces for burning brimstone are intermittent in their action. That is, the brimstone or ore is fed to them and the desulphurized cinder discharged at intervals. It is only, therefore, by the most skilful and careful work and attention to numerous details that even an approximation can be had to the desirable condition of the burner gas above referred to.

32. To counteract the intermittent character of the individual furnace, the following points must be observed:

1. A considerable number of furnaces of small capacity are used, and are charged and discharged in series. For example, a sulphuric-acid works is designed to oxidize in 24 hours 14,000 pounds of actual sulphur to the trioxide. The ore available is iron pyrite in lump form, containing 50 per cent. of sulphur, about 1.5 per cent. of which will be lost either by being retained in the cinders or on other accounts, making the ore contain 48.5 per cent. of available sulphur; 28,800 pounds of ore will be required daily. To roast this ore, twenty-four burners will be used, each having a capacity for roasting 1,200 pounds in 24 hours. This ore is charged to each furnace in two charges of 600 pounds each, one every 12 hours, or the whole charge is divided up into forty-eight charges of 600 pounds each, so that one furnace of the twenty-four will be charged with 600 pounds of ore every half hour during the 24 hours. Furnaces are selected to be charged in rotation in such a way as to preserve as nearly as possible even conditions in every part of the bench of burners.

2. The furnaces are so constructed that the amount of air admitted to each furnace may be under as complete control as possible. It is evident that when any furnace has received a new charge of ore containing 50 per cent. of sulphur, it will require more air than it will 6 hours later, when much of the sulphur is burned off, and still more than it will when the sulphur is almost entirely burned off. In fact, the admission of much air when the ore only contains a small percentage of sulphur merely tends to cool the furnace and so prevent the thorough roasting of the ore. By judiciously regulating the admission of air to the individual burners, the general average of the gas in the flue common to all the burners is kept reasonably strong; and by the subdivision of the whole charge as above, a general average of gas is maintained that is as near an approach to continuous, uniform work as is possible under the circumstances.

FURNACES AND BURNERS FOR THE PRODUCTION OF BURNER GAS

33. General Remarks.—In the production of the burner gas and the efficient desulphurization of the various raw materials by the different furnaces now to be described—while various points peculiar to the management of each furnace will be pointed out—nothing but actual experience will secure satisfactory results. The minutest details tending to secure regularity must be insisted on in the management of the furnaces. Each ore or material has its own peculiar behavior in the furnaces, which when understood must be attended to.

When natural draft is used, meteorological conditions must be constantly considered and the drafting of the furnaces modified accordingly. Much trouble and anxiety is saved in this respect by the use of fans, or other apparatus devised to make the draft positive and controllable. Above all, it must be kept constantly in mind that the desired

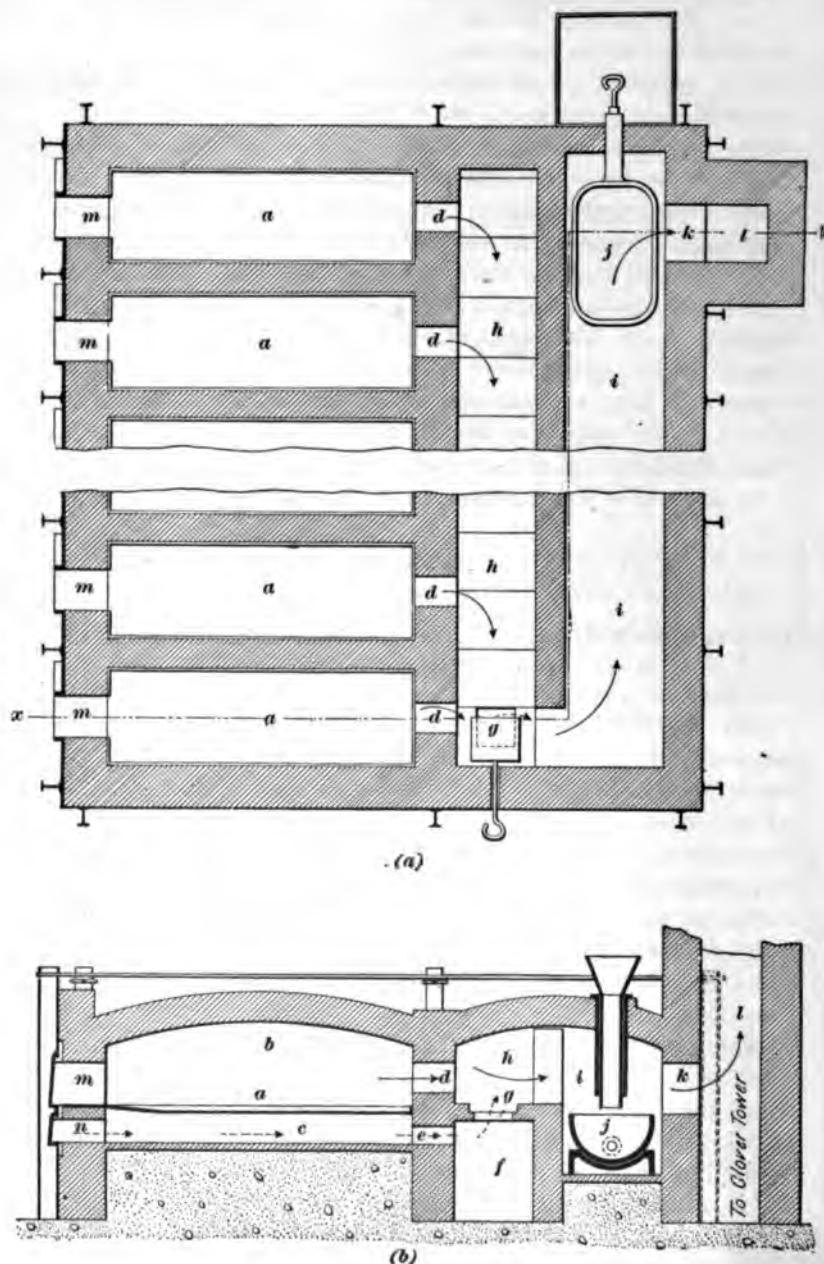

(a)

(b)

FIG. 1

object is a uniform stream of burner gas of constant composition and volume, with as complete desulphurization of the ore as may be possible.

If the further oxidation of the sulphur dioxide of the burner gas to the trioxide is to be carried out by means of the chamber process, it is necessary to mix the burner gas at this point with nitric-acid fumes. The nitration of the gas will only be mentioned here in so far as it forms an adjunct to the desulphurizing furnaces; in other words, when the nitric acid is supplied by the decomposition of sodium nitrate and sulphuric acid by the heat of the burner gas. This method of adding the nitric acid is called *potting*, as it is done in large cast-iron pots, placed in a chamber or enlargement of the main gas flue of the furnaces, which is called the *niter oven*.

BRIMSTONE BURNERS

34. One of the simplest forms of **brimstone burners** is shown in Fig. 1 (*a*) and (*b*), (*a*) being the plan showing several burners connected with the common flue *h*, and (*b*) a vertical section on the line *xy*. The sulphur is charged through the door *m* upon the cast-iron pan *a*, where it is burned. The supply of air to the burning sulphur is carefully regulated. The gases containing the sulphur dioxide collect in the chamber *b* and pass through the flue *d* into the common flue *h*. To prevent overheating pan *a*, air is admitted under it through *n*, passing through *c*, *e*, *f*, and *g*, where it finally mixes with the gases and sublimed sulphur coming from *h*, as shown in (*a*). These mixed gases now pass into the combustion chamber *i*, where the combustion is completed.

If the burner gas is to be used for making sulphuric acid by the chamber process, it is mixed with fumes of nitric acid evolved in the pot *j* by the action of sulphuric acid on niter. The gas now passes through the flues *k* and *l* to the Glover tower. If it is to be used in the contact process, the nitrating is omitted.

35. Harrison-Blair Brimstone Burner.—This burner, which is of the continuous-feed and intermittent-discharge type, is shown in plan and longitudinal section in Fig. 2 (*a*) and (*b*). The brimstone is fed into the burning pan *a* through the funnel *d*, which is kept full. The brimstone settles as fast as that on the pan melts. Air for the combustion is supplied through the door *c*. The sulphurous gases pass from the chamber *b* through the flues *e* and *f*

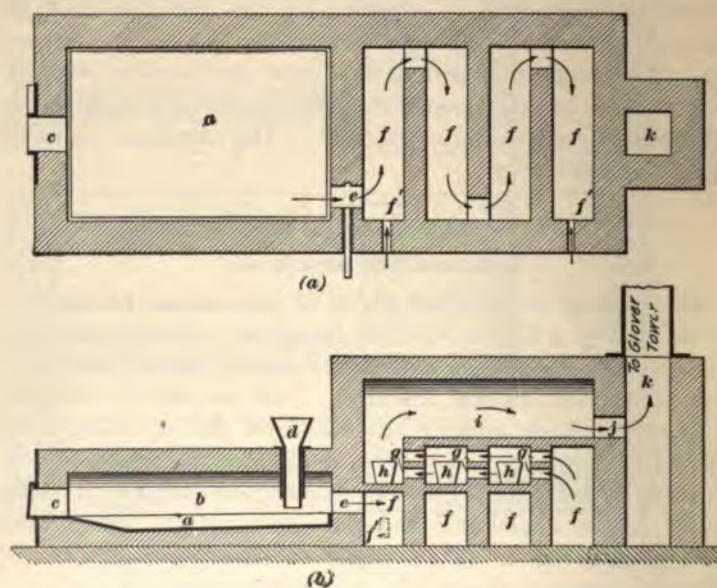
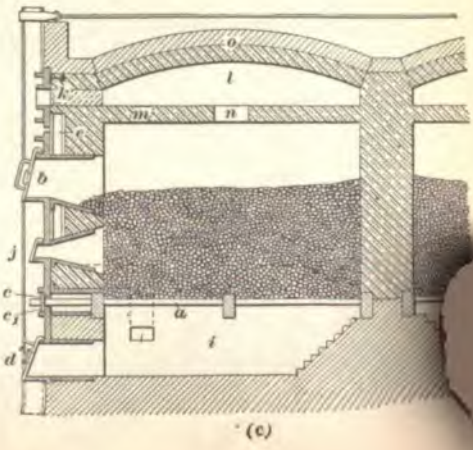
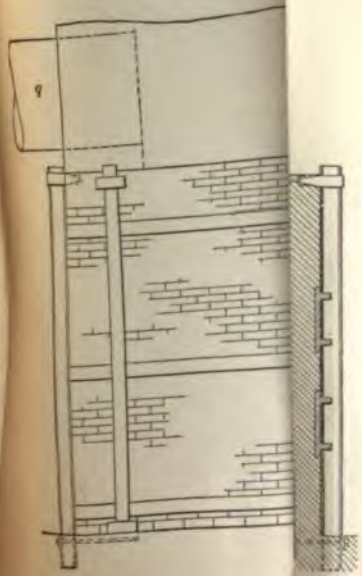
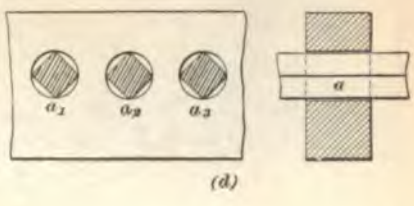
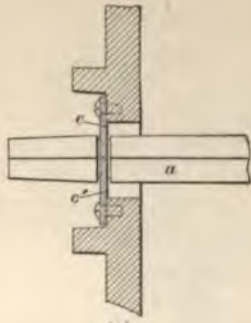
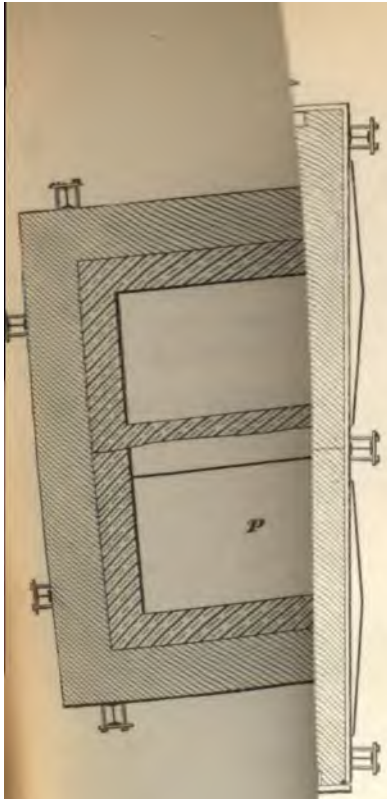

FIG. 2

into the flue or chamber *i*; additional air for completing the combustion is supplied to *f* through the openings *f'*. In passing from *f* to *i*, the gases are led through a series of baffle walls lined with pigeonholed brick, shown at *g*, and over the niter pots *h*. From the flue *i* the nitrated gases pass through the flues *j* and *k* to the Glover tower. About once in 24 hours the ashes are removed through the door *c*.



PYRITES BURNERS

36. Furnaces, or burners, for roasting pyrites for the recovery of the sulphur, as SO_2 , are of many styles, depending both on the nature of the pyrites used and on the manner of their operation. The following descriptions will serve to illustrate the most important forms.

37. Falding Lump Burner.—This furnace is used for self-roasting ores. It has an intermittent feed and is operated by hand. A bench of six furnaces is shown in detail in Fig. 3 (*a*), (*b*), (*c*), (*d*), and (*e*). (*a*) is a side elevation, also showing vertical sections through several parts; (*b*) is a plan showing horizontal sections through several different parts; (*c*) shows a vertical section from front to back through the center of an individual furnace; (*d*) and (*e*) will make themselves clear in the following description:

38. At *a* is the grate upon which the ore is burned. The thickness of the bed of ore carried on the grates will be from 2 to $2\frac{1}{2}$ feet, as shown in (*c*), but will vary somewhat according to the sizing and character of the ore. It must in any case permit a passage of the air uniformly through its mass and not in spots or against the furnace walls. The ore is shoveled into the furnace through the charging door *b*, and must be spread as evenly over the surface of the bed as possible, being slightly deeper against the walls of the furnace, as shown in (*c*). The grate bars *a* are usually bars of square wrought iron from $1\frac{1}{2}$ to 2 inches square, slightly rounded where they pass through the supporting cast-iron bearers *a*₁, *a*₂, *a*₃. These bars must be spaced so as to be best adapted for the size of the ore to be burned. When the ore is sized by screens, it is a good plan to have a certain number of furnaces spaced to accommodate each size of ore. If the grates are spaced too closely, the larger lumps will not pass through and the draft will soon be seriously interfered with; if they are spaced too far apart, the bed will drop through too rapidly and be difficult to control. At the front of the furnace the bars pass through a wrought-iron plate *c* and *c'*, that can be removed in two sections; as the

bars are turned down to a circular section where they pass through the plates, the plates fit closely and prevent the entrance of "false" air into the furnace; the plates also tend to steady the grate bars. In order to drop the roasted ore through the grate, use is made of a large wrench, or key, fitting on to the square end of each grate bar. Each grate bar is by this means twisted backwards and forwards a few times, until an amount of roasted ore has been dropped through the grate into the cinder pit *i* equivalent to the amount of ore about to be charged through the charging door *b*. The roasted cinder is removed by means of the door *d'*. The cinder-pit door *d'* is provided with a slide or gate valve *d* for regulating the admission of air for combustion.

39. The furnace illustrated has hollow front walls *e*, which serve to prevent radiation of heat from the furnace, permitting the burner gas to be passed to the Glover tower at a high temperature; or, if desired, permitting the air supply for combustion of the ore to be preheated. The air passes through the regulator *h* into the air duct *f*, hollow tiles *c*, and side channels *g*, beneath the furnace grate. The door *j* is used for inserting a bar in case of bad clinking low down in the bed. The bricked-up opening *k* enables the flue *l* to be cleaned when obstructed with flue dust. Each furnace has a roof *m*, in which is an opening *n*, through which the burner gas finds its way into the main flue *l* formed by the longitudinal arch *o*, and thence into the flue *p* common to both sides of the furnace bench, whence it is carried by the cast-iron pipe *q* to the Glover tower. In case nitration by means of potting is to be used, the niter oven will be placed in *p*, which also serves as a dust collector for coarse flue dust that may be carried over.

40. To start this furnace, about 2 feet of roasted ore is put upon the grates. (Incompletely roasted ore and brick-bats broken so that they can be passed through the grates may be used.) A light wood or coke fire is then lighted on

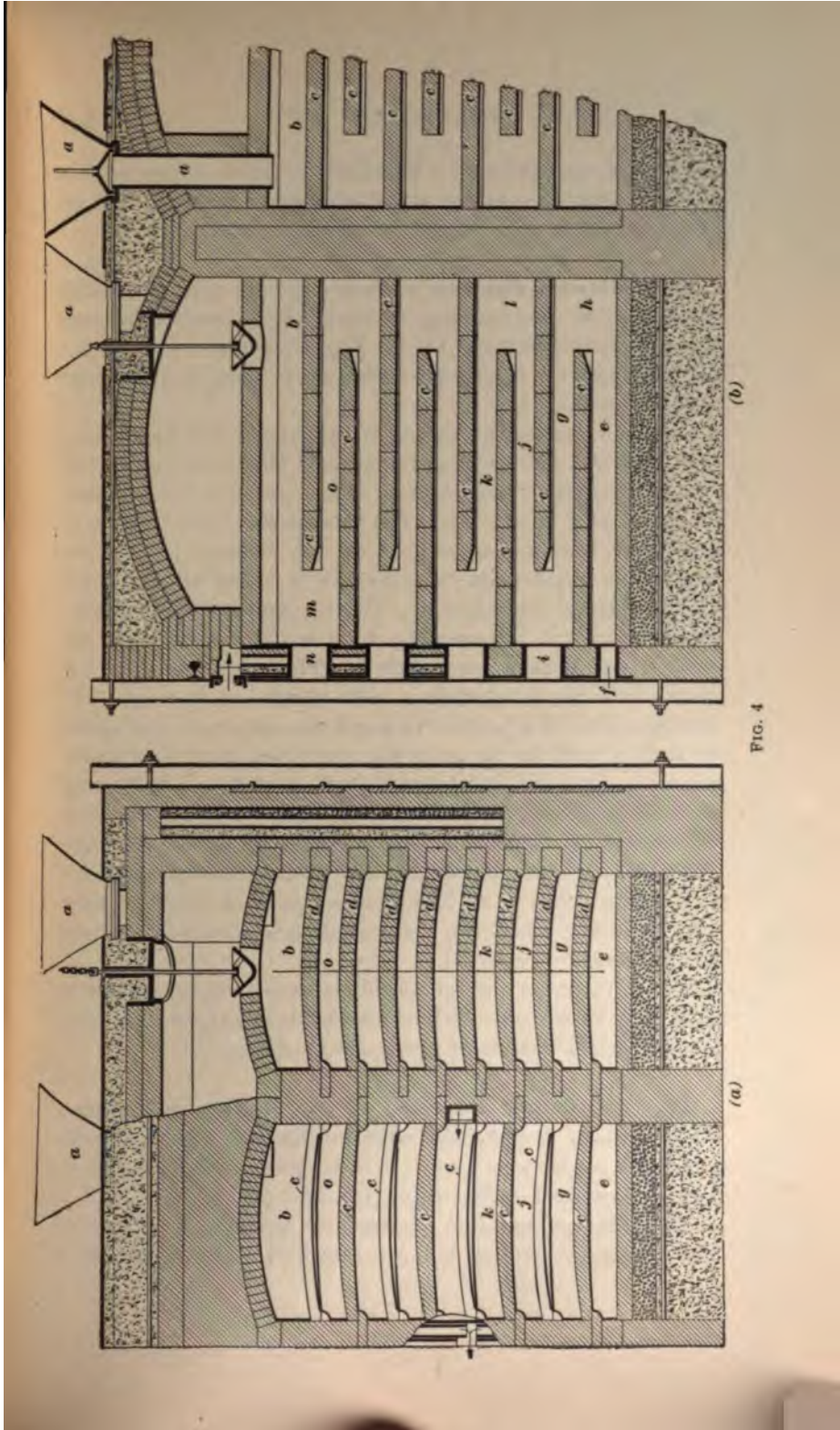

FIG. 4

the bed of each furnace. When the furnace is heated to a dull-red heat, the coke or wood ash may be removed and ore charged and the gas turned into the acid plant.

41. Maletra-Falding Furnace.—This type of furnace is adapted to the roasting of fines. It is worked by hand and has an intermittent feed. Fig. 4 (*a*) and (*b*) shows two sectional views of it, corresponding parts being lettered alike in both views.

Ore is introduced by means of the hopper and bell *a* on to the back end of the upper shelf *b*. These shelves can be constructed either with fireclay slabs *c, c, c*, or brick arches, as shown at *d, d, d*. After the furnace has been brought to a red heat ore is spread over all the shelves. After the expiration of a certain time the ore is raked off the lower shelf *e* through the door *f*. The ore from shelf *g* is then pushed through the opening *h* on to shelf *e*, through the door *i*, and spread over shelf *e*. The ore from shelf *j* is raked forwards on to shelf *g*, over which it is spread. The ore from shelf *k* is pushed through the opening *l* and spread on shelf *j*, and so on until the ore from shelf *b* is finally raked through the opening *m* by means of door *n* and spread on shelf *a*. Every shelf in the furnace is now covered with ore except the upper shelf *b*. A charge of ore is now introduced through the hopper and bell *a* on to the upper shelf *b* and spread over it. The furnace is now left for from 6 to 12 hours, when the lower shelf is discharged and the whole operation repeated.

These furnaces are generally constructed in groups of from four to sixteen, each of which has a capacity of from 1,600 to 2,000 pounds of pyrites in 24 hours.

42. Herreshoff Furnace of the MacDougall Type. This furnace is provided with mechanical rotary stirrers and has a continuous feed. It is designed for burning fines, and is illustrated in Fig. 5 (*a*), (*b*), and (*c*).

This furnace has five shelves, or hearths, *a, a, a, b, b*. The rotating, central, hollow, cast-iron column *c* carries a



pair of arms on each shelf. The column and arms adjacent to the column are kept safely cool by a current of cold air drawn through the holes *d* by natural draft created by the 30-foot stack *e*. The teeth, or stirrers, operating on hearths *a*, *a*, *a* are set at such an angle as will gradually work the ore from the center to the periphery, where it falls through ports *f* on to the hearths *b*, *b* and finally through discharge port *f'*, which is closed by a balance valve suitably weighted to control the discharge. The teeth on the stirrers, operating on hearths *b*, *b*, are set at such an angle as to gradually work the ore from the periphery to the center, where it falls through the annular ports *g*. The ore is fed to the furnace by means of the hopper and plunger feed *h*, *h'*, which is operated by the central revolving column *c* in such a way as to supply a desired quantity of ore at each revolution of the stirrer arms. These usually make a complete revolution once in 2 minutes and can be taken out and replaced by means of the doors *i*, *i*, *i*, *i*, *i*.

43. The air for supplying the necessary oxygen for the combustion of the ore and the production of a suitable burner gas is admitted on the lower shelf through gate valves *k*, *k*, etc., and passing through the furnace over the roasting ore, finally leaves the furnace as burner gas through the cast-iron pipe *l*, which connects with the common, or main, cast-iron burner-gas flue *m*.

If the mechanical construction of this furnace has been properly attended to, it can be readily started by first removing the arms, covering the hearths with a bed of roasted ore or cinder, then heating it to a dull-red heat by means of light wood fires on each shelf, then replacing the arms and feeding the ore in the usual way.

44. Spence Reciprocating Type of Furnace.—This style of furnace is designed for self-roasting fines. It has a continuous feed, the ore being carried from one shelf to another by means of a reciprocating device. Its mechanism is

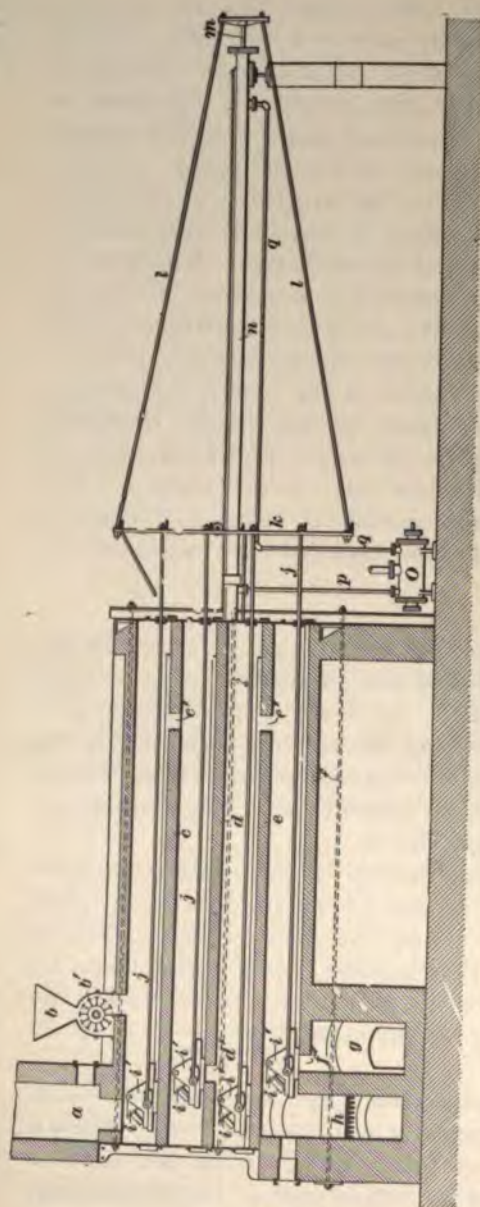

FIG. 6

shown in Fig. 6. The exit flue *a* is for the burner gases. The hopper *b* is kept full of ore, which is fed into the furnace in front of the rake *i* upon the hearth *c* by the continuous feed *b'*. As the rake *i* is drawn over the hearth *c* by the reciprocating mechanism shown at the right of the figure, it draws and spreads the accumulated ore over the hearth and causes part of it to fall through the opening *c'* upon the next lower hearth *d*. On its return stroke the rake on hearth *d* carries this ore over the hearth in the opposite direction, it then falling through the opening *d'*. From the lower hearth *f* it falls through *f'* into the pit *g*. A similar operation takes place on each hearth.

45. The ore rakes have triangular cast-iron teeth and extend

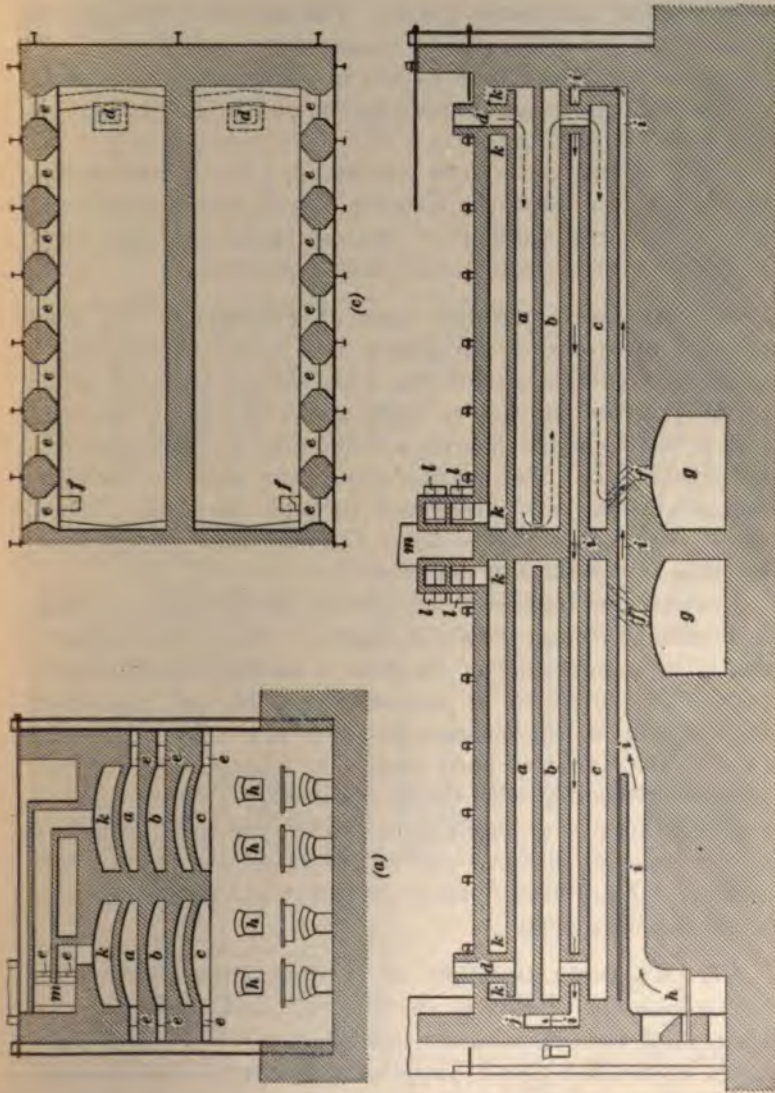

FIG. 7

across the furnace; they are attached to the skids *i'*. The reciprocating mechanism consists of a hydraulic cylinder *n* with a piston and piston rod *m*. The motion of the piston is transmitted to the rakes by means of the rods *l* and *j* and the frame *k*. Water is furnished to either end of the cylinder through the pipes *p* and *q* by the pump *O* by means of automatic valves.

When the furnace is to be started up, a fire is built in the fireplace *h*, but after the furnace is well under way it is bricked up, the sulphur of the ore being the only fuel necessary for the continuation of the operation.

46. Rhenania Muffled Type of Furnace.—This furnace is for roasting refractory ores; the feed is intermittent. It is illustrated in Fig. 7 (*a*), (*b*), and (*c*). *a*, *b*, and *c* are the hearths, or shelves, upon which the ore is burned. Ore is fed upon the hearth *a* from time to time through the openings *d*. The ore is worked from shelf to shelf by means of slice bars introduced through the doors *e*, and finally passes through the ports *f* to the cinder pits *g*, from which it is periodically removed.

Heat for combustion is supplied by the fireboxes *h*; this heat passes through the whole length of the double furnaces and returns by means of the flues *i*, passing into the stack at *j*. The products of combustion of the ore pass over the ore and in the opposite direction into a flue *k*, on the top of the furnace, and thence by dampers *l* into the stack *m* connecting with the Glover tower.

These furnaces are built in blocks of four, fired by means of two fireboxes with two doors each, at one end of the block of four; the fire flues *i* pass from end to end of all four furnaces and back again.

47. MacDougall Type of Muffled Furnace.—This furnace closely resembles in structure and operation the Herreshoff furnace already described. When these furnaces are muffled, that is, supplied with separate and distinct combustion chambers and flues for the purpose of introducing heat into the furnace other than that produced by

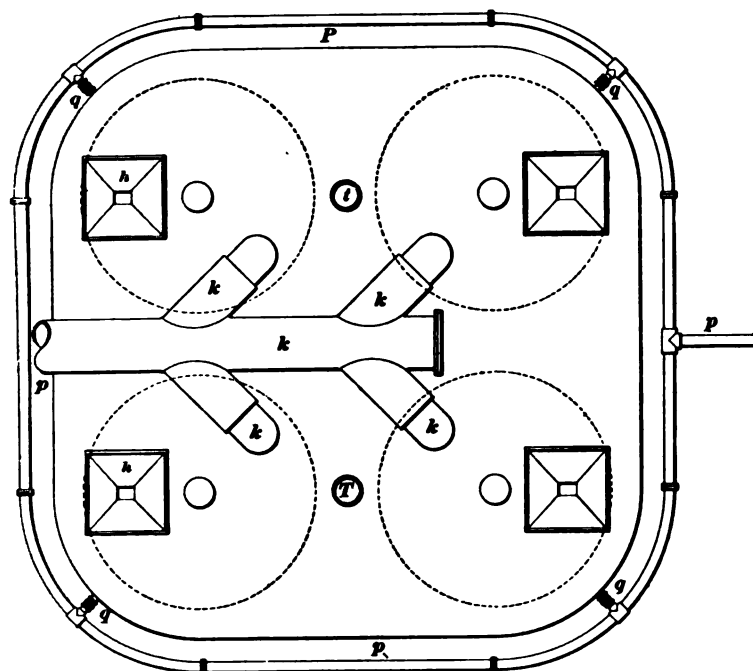

(a)

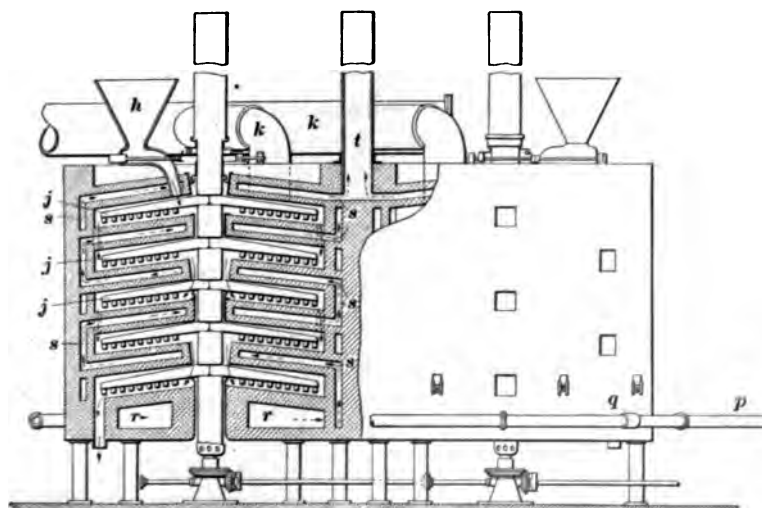

(b)

FIG. 8

the combustion of the ore itself, and the products of combustion are kept separate and distinct from the burner gas, they are constructed in groups of four. The feed is continuous. The fuel used may be oil, natural, or producer gas.

Fig. 8 (*a*) and (*b*) shows this furnace in plan and vertical section. The revolving arms *j* are operated in the same manner as in the Herreshoff furnace. Ore is fed in through the hopper *h* to the upper hearth and gradually worked outwards by the revolving arms and down to the next lower hearth, then towards the center and through another opening to the third hearth, etc. The fuel is supplied by means of the pipe *p* and branches *q* to the combustion chamber *r*, and thence to the flues *s* around the muffles. The products of combustion pass off through the stacks *t* and the burner gas through the pipes *k*.

TESTING THE BURNER GAS

48. Collecting the sample.—Gas is aspirated from the flue common to all the furnaces at a point chosen so as to secure a reliable average of the gas. If there is any doubt as to the gas being an average, it should be aspirated at several points until a point yielding a satisfactory average is obtained.

49. Reich's Test for Sulphur Dioxide.—This test, which is described fully in *Quantitative Analysis*, is generally used, but is modified for sulphuric-acid works as follows: The deci-normal solution of iodine, containing 12.65 grams of iodine per liter, and the starch solution are prepared in accordance with the instructions given in *Quantitative Analysis*. The solutions must be kept in a dark, cool place. It is a good precaution to use small bottles, holding just sufficient for the day's tests, for use in the works, leaving the stock in the laboratory.

As in practice it is often necessary to make tests in several different parts of the works, it becomes necessary, for making the test, to fit up a simple cheap apparatus that

can be left at each place. The apparatus shown in Fig. 9 can be readily put together and arranged on a rough shelf or shelves, in almost any place, so as to be ready for instant use. A pipette being left on the shelf, it is only necessary to carry around the two small bottles of solutions. A spare 2-liter jar being kept on the shelf, the aspirating water can be saved, or in case many tests must be made and

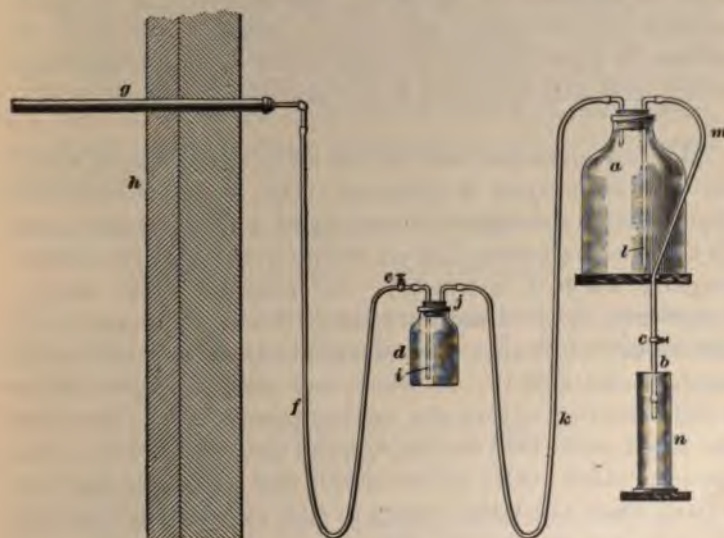

FIG. 9

water-supply pipes are available, a water aspirator can be used; failing this, a steam aspirator. In some works the pipes through which the gas is aspirated are all led to the laboratory, and being supplied with valves and a steam aspirator, tests can be made in the laboratory without going to the different parts of the works. This is a very convenient though somewhat costly plan.

50. This apparatus consists of a 1-inch iron pipe *g* penetrating the flue *h*, the gas in which is to be tested. This pipe is connected by means of the rubber tube *f* and pinch cock *c* with the absorption bottle *d*. The glass tube *i* penetrates

the rubber stopper and extends nearly to the bottom of the bottle. The exit tube *f* extends just through the stopper. By this arrangement, the gas drawn through *f* bubbles through the reagent in *d*. The rubber tube *k* connects *d* with the 4-quart aspirating bottle *a*. In construction, this aspirator is similar to the absorption bottle, the positions of the tubes being reversed. When filled with water, the latter is siphoned off through *l* and *m*, creating a partial vacuum in the upper part of *a*. During operation, the volume of water (which is equal to the volume of gas used) drawn from *a* is measured in the graduated cylinder *n*.

51. To make the test, fill the large bottle *a* with water; see that the stopper is perfectly tight; start the siphon by slight suction through the nozzle *b* and close the pinch cock *c*; fill the 8-ounce bottle *d* about one-quarter full of clean water (slightly warmed in winter); and pour into this about a teaspoonful of the starch solution. Then, by means of the pipette take 10 cubic centimeters of the deci-normal iodine solution and add to the water and starch solution in the 8-ounce bottle; replace the rubber stopper tightly and close the pinch cock *c* between the flue and the small bottle. Then open the pinch cock *c* at the nozzle and allow the water to waste; when the water ceases to run, proving the tightness of corks and connections throughout the apparatus, open the pinch cock *c* between the flue and the small bottle *d*. Take the small bottle in the left hand, keeping the right hand on the pinch cock *c* at the nozzle, and shake the bottle not too violently, holding it to the light in such a way that any change in color can be readily noted; when a considerable change occurs in the color, stop the flow of water with the right hand. If the color does not entirely disappear, aspirate a little gas carefully until it does; then close the pinch cock *c* between the flue and the small bottle. The tube *f* between the flue and this pinch cock is now filled with the gas to be tested. Remove the stopper from the small bottle and add 10 cubic centimeters of the iodine solution with the pipette; replace the cork tightly; open the

pinch cock nearest the flue; then, with the pinch cock *c* in the right hand carefully waste water until the liquid in the glass tube, terminating the tube from the flue, is depressed to the bottom; or, in other words, until the tube is filled with the gas to its extreme end in the small bottle. Just before the first bubble of gas would escape and pass through the solution, allow the water to commence running into the graduated measuring jar; shake the small bottle as before and stop the water running the instant the color is discharged. The number of cubic centimeters of water that the jar holds at the point of discharge of color from the solution represents the volume of gas required to decolorize the solution, from which the percentage of sulphur dioxide in the burner gas is calculated.

52. The reaction taking place is as follows:

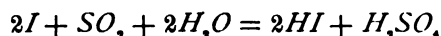

Omitting any correction for temperature and pressure, the percentage of sulphur dioxide is calculated by means of the following formula:

$$p = \frac{111.4 \times n}{m + 1.114 \times n} \quad (2.)$$

p = percentage of SO_2 ,

n = the number of cubic centimeters of $\frac{1}{10}$ normal iodine solution used;

m = the number of cubic centimeters of water run into the measuring jar.

If the percentage of sulphur dioxide in the gas is very small, and, thus, *m* is very large in proportion to *n*, the formula may be simplified into

$$p = \frac{111.4 \times n}{m} \quad (3.)$$

In testing exit gas, using 10 cubic centimeters of a $\frac{1}{10}$ normal or centi-normal solution of iodine, formula 2 becomes

$$p = \frac{111.4}{m + 1.114} \quad (4.)$$

As in the case of formula 3, when the percentage of SO_2 is very small and m is very large in proportion to n (as it usually is), the formula becomes

$$p = \frac{111.4}{m}. \quad (5.)$$

By means of the following tables, the percentage of sulphur dioxide in burner and exit gases can be read directly from the volume of water in the measuring jar.

53. To calculate the yield of sulphur dioxide from the difference in content of SO_2 in the entering and exit gases, the following formula is used:

$$\text{Yield} = \frac{2a - 2b}{2a - 3ab} \quad (6.)$$

where a = the percentage of SO_2 in the entering gas;
 b = the percentage of SO_2 in the exit gas.

CALCULATION OF VOLUME OF BURNER GAS

54. The general principles contained in *Theoretical Chemistry* regarding corrections for temperature and pressure and the corrections of gaseous volumes treated in *Physics*, *Theoretical Chemistry*, and *Quantitative Analysis* apply to burner gas. A rough approximation of the volume of burner gas at 0° C. and 960 millimeters barometric pressure, or at 32° F. and 29.92 inches barometric pressure may be made as follows:

55. One liter of sulphur dioxide weighs 2.86336 grams, or 1 cubic foot weighs .1787 pound. Therefore, 1 pound of sulphur burned in 24 hours produces 11.191968 cubic feet of sulphur dioxide, or .0077722 cubic foot per minute; therefore, neglecting the sulphur trioxide formed,

$$\frac{(.77722 \times \text{actual available sulphur burned in 24 hours})}{\text{average per cent. of } SO_2 \text{ in burner gas produced}} =$$

the cubic feet of burner gas per minute;

TABLE VI

TABLE FOR FINDING THE PERCENTAGE OF SO_2 IN BURNER GAS WHEN USING 10 CUBIC CENTIMETERS OF DECI-NORMAL IODINE SOLUTION (CALCULATED BY FORMULA 2)

Per Cent. of SO_2	Cubic Centimeters of Water	Per Cent. of SO_2	Cubic Centimeters of Water	Per Cent. of SO_2	Cubic Centimeters of Water	Per Cent. of SO_2	Cubic Centimeters of Water
.0	3.2	337.0	5.5	191.0	7.8	132.0
1.0	1,103.0	3.3	327.0	5.6	188.0	7.9	130.0
1.1	1,002.0	3.4	317.0	5.7	184.0	8.0	128.0
1.2	917.0	3.5	307.4	5.8	181.0	8.1	126.0
1.3	846.0	3.6	298.0	5.9	178.0	8.2	125.0
1.4	785.0	3.7	290.0	6.0	175.0	8.3	123.0
1.5	732.0	3.8	282.0	6.1	172.0	8.4	122.0
1.6	685.0	3.9	275.0	6.2	169.0	8.5	120.0
1.7	644.0	4.0	267.0	6.3	166.0	8.6	118.0
1.8	608.0	4.1	261.0	6.4	163.0	8.7	117.0
1.9	575.0	4.2	254.0	6.5	160.0	8.8	116.0
2.0	546.0	4.3	248.0	6.6	158.0	8.9	114.0
2.1	519.0	4.4	242.0	6.7	155.0	9.0	113.0
2.2	495.0	4.5	236.0	6.8	153.0	9.1	111.0
2.3	473.0	4.6	231.0	6.9	150.0	9.5	106.0
2.4	453.0	4.7	226.0	7.0	148.0	10.0	100.0
2.5	435.0	4.8	221.0	7.1	146.0	10.5	95.0
2.6	417.0	4.9	216.0	7.2	144.0	11.0	90.0
2.7	402.0	5.0	212.0	7.3	142.0	11.5	86.0
2.8	387.0	5.1	207.0	7.4	139.0	12.0	82.0
2.9	373.0	5.2	203.0	7.5	137.0		
3.0	360.0	5.3	199.0	7.6	135.0		
3.1	348.0	5.4	195.0	7.7	134.0		

or, letting x = cubic feet of burner gas per minute at 0° C. ;
 a = available sulphur in pounds burned in
 24 hours;
 b = average percentage of sulphur dioxide in the
 burner gas produced;

$$\text{then, } x = \frac{.77722 \times a}{b}. \quad (7.)$$

TABLE VII

TABLE FOR FINDING THE PERCENTAGE OF SO₂ IN EXIT GAS
 WHEN USING 10 CUBIC CENTIMETERS OF CENTI-
 NORMAL IODINE SOLUTION (CALCULATED
 BY FORMULA 4)

Per Cent. of SO ₂	Cubic Centimeters of Water	Per Cent. of SO ₂	Cubic Centimeters of Water	Per Cent. of SO ₂	Cubic Centimeters of Water	Per Cent. of SO ₂	Cubic Centimeters of Water
.05	2,226.9	.55	201.5	1.05	105.0	1.55	70.8
.10	1,112.9	.60	184.6	1.10	100.1	1.60	68.5
.15	741.6	.65	170.3	1.15	95.8	1.65	66.4
.20	555.9	.70	158.0	1.20	91.7	1.70	64.4
.25	444.5	.75	147.4	1.25	88.0	1.75	62.6
.30	370.2	.80	138.2	1.30	84.6	1.80	60.8
.35	317.2	.85	130.0	1.35	81.4	1.85	59.1
.40	277.4	.90	122.6	1.40	78.5	1.90	57.5
.45	245.5	.95	116.2	1.45	75.0	1.95	56.0
.50	221.7	1.00	110.3	1.50	73.2	2.00	54.6

For example, 10,000 pounds of available sulphur is burned in 24 hours with the production of a burner gas containing 7.5 per cent. of sulphur dioxide, substituting in formula 7,

$$x = \frac{.77722 \times 10}{7.5} = \frac{7.7722}{7.5}$$

= 1,036.3 cubic feet of burner gas per minute, containing 7.5 per cent. of sulphur dioxide.

This quantity of gas at normal pressure is corrected for a temperature of, say, 60° F. or 15.6° C. by the following formula:

$$V_t = V_o + \frac{t V_o}{273} \quad (8.)$$

V_t = volume at the given temperature;

V_o = volume at 0° C.;

t = temperature in degrees C. at which volume is to be calculated.

Substituting, $V_o = 1,036.3$ cubic feet, $t = 15.6^\circ \text{C.}$,

$$V_t = 1,036.3 + \frac{1,036.3 \times 15.6}{273} = 1,095.5 \text{ cubic feet per minute.}$$

The approximate temperature at which the burner gas leaves the common flue of a bench of burners is about 1,000° F., or, say, 538° C., and at this temperature the volume of burner gas produced as above would be 3,078.5 cubic feet per minute. With gas containing only 5 per cent. of sulphur dioxide, the quantities at 0° C. and 538° C. would be, respectively, 1,554.4 and 4,617.6 cubic feet per minute.

56. It is evident, therefore, that great economy in the size of the apparatus is effected by keeping the gas as strong as possible; and also that in order to prevent unnecessary obstruction in the flues and apparatus, attention must be given to designing them of suitable capacity to handle the volumes of gas in accordance with the approximate temperature of the gas at the different stages of the process.

THE CATALYTIC, OR CONTACT, PROCESS

57. Preliminary Remarks Concerning Contact Phenomena.—In considering the so-called contact phenomena in chemistry, it must not be forgotten that contact is a necessary condition for every chemical reaction. Other conditions remaining constant, the rate of progress of a chemical

reaction is accelerated by increasing the number of points of contact. To insure complete reaction between solids, it is necessary to reduce them to very fine powder and to mix them as thoroughly as possible. These considerations may throw some light on the large class of contact reactions; that is, such as appear to proceed from the mere presence of certain special substances. Porous or powdery substances are very prone to act in this way, especially spongy or very finely divided platinum and charcoal. A number of other substances, such as finely divided silica, act in a similar way.

Another consideration is the action, by contact, that two substances rich in oxygen have upon each other, in that so long as they are separate they retain their oxygen; but upon contact oxygen is liberated from both of them. As, for example, a solution of bleaching powder, which does not evolve oxygen when heated by itself, but upon the addition of a small quantity of certain oxides, for instance, cobalt oxide, first oxidizes the cobalt oxide to a higher oxide, which in contact with the bleaching powder decomposes into oxygen and the lower oxide. This resulting lower oxide, on contact with the bleaching powder, again results in the higher oxide, which again gives up its oxygen and produces the lower oxide, and so on

58. The action of nitrogen oxides in the chamber process is noteworthy as showing that intermediate forms of reaction may be found in the contact, or catalytic, phenomena. In this case a small quantity of nitrous oxide induces a definite chemical reaction between large masses of sulphur dioxide, oxygen, and water, forming sulphuric acid, the N_2O being finally again liberated, as will be seen when considering the chamber process.

In the case of the combination of sulphur dioxide and oxygen by contact action, it is possible that either on account of an electrical action induced by the contact, or for some other obscure cause, a polarization or increased activity of the oxygen in the air is procured, enabling it to combine with the sulphur dioxide.

59. Richter suggests that as all bodies having a high heat of formation, and also those being decomposed at a high heat, must have their heat of formation removed or conducted away in order that their production may be at all possible; the catalytic action of many metals, for example, platinum, in this reaction, may be due to their conducting off the heat; or else that the bodies in question forming a galvanic chain, the chemical energy is removed as electricity, just as in the union of hydrogen and oxygen at ordinary temperatures due to the formation of a polarization current.

60. Contact Mass or Material Used in the Manufacture of Sulphuric Acid by the Contact Process. Broadly speaking, there are four contact masses in commercial use for the manufacture of sulphuric acid, viz.: (1) Asbestos, clay, pumice, or other porous material impregnated or coated with platinum. (2) Porous or fibrous material as above impregnated with cupric sulphate (blue vitriol). (3) Mass composed of crusts formed of an earthy or alkaline water-soluble salt impregnated or coated with platinum. (4) Ferric oxide (roasted pyrites).

For the first class of contact masses, where the platinum is combined with a fibrous or porous material insoluble in water, there are two principal methods of preparation, the first being to add finely divided platinum (platinum black), previously prepared, to the fibrous or porous material; and the second, to add either a dry or liquid salt of platinum to the inert material and then subject the mixture to a process that will reduce the platinum.

61. The usual methods for preparing the first class of contact masses are as follows:

1. The powdered fibrous or porous material is mixed with platinum black, a combustible material required to secure porosity (flour, bran, sawdust, cork dust, etc.), and an agglutinative substance (gelatine, gum, etc.).

2. The fibrous or porous material is mixed with an oxide or dry salt of platinum, a combustible material, and an agglutinative. It is then dried and reduced by calcination.

3. The fibrous or porous material is soaked in a platinum-salt solution, reduced by one of the methods described in the paragraphs immediately following, and after the addition of the combustible organic matter and agglutinative, is molded, dried, and calcined.

4. The fibrous or porous material is first impregnated with a platonic chloride and then reduced by one of the following methods: (a) By plunging the saturated material into a solution of ammonium chloride, ammonium-platonic chloride $(NH_4)_2PtCl_6$ is formed. The whole is then dried and calcined. (b) By plunging the material into a bath consisting of an alkaline solution of soda and of platinum chloride containing sufficient sodium formate to reduce the platinum, evaporating, washing, and drying. (c) The material saturated with platinum salts can be dried and submitted to the action of hydrogen or of gas rich in hydrogen, such as ordinary illuminating gas or even of hydrocarbon compounds. (d) The following methods for the preparation of platinum black may also be used.

62. Platinum black or finely divided platinum can be made as follows: (a) Platonic chloride $PtCl_4$ is treated in a concentrated potash lye with alcohol. The resulting powder is washed successively with alcohol, hydrochloric acid, potash, and water. (b) Platinum sulphate can be reduced by alcohol. (c) By the calcination of a platonic chloride, as calcium-platonic chloride $CaPtCl_6$, or ammonium-platonic chloride $(NH_4)_2PtCl_6$. (d) By precipitating platonic chloride with zinc. (e) By heating an ammoniacal salt of platinum, mixed with shreds of cork, in an open crucible. (f) By the reduction of platonic chloride with admixture of sodium carbonate, sugar, etc. (g) If 50 grams of platonic chloride be dissolved in 60 cubic centimeters of water and 70 cubic centimeters of a 40-per-cent. solution of formaldehyde be added, the mixture cooled, and then a solution of 50 grams of sodium hydrate in 50 grams of water added, the platinum is precipitated. After washing with water, the precipitate passes into solution and forms a black liquid

containing soluble colloidal platinum. If the precipitated platinum be allowed to absorb oxygen on the filter, the temperature rises 40° C. and a very porous platinum black is obtained that vigorously facilitates oxidation.

Instead of the second class of contact material, some manufacturers use cupric sulphate at a red heat as contact mass. The salt is mixed into a paste with finely ground clay, molded into the desired shape, and dried.

63. In the third class of contact masses (under the Schroeder-Grillo patents), instead of the solid or integral insoluble bases above referred to, use is made of the soluble salts of the alkalies and of the alkaline earths, and of the heavy metals, which salts, for the production of the contact mass, are dissolved in water and then mixed with a solution of the finely divided platinum salt, especially platinic chloride. It can be used in a solution so diluted that in 100 parts of the salt, serving as base or vehicle, less than 1 part of platinic chloride is sufficient. Even contact bodies of .1 per cent., and less, of platinum contents are very efficacious. This mixture of solutions is then evaporated and the resulting salt crusts dried and broken up to about a uniform granular size. The powder that is formed in this reducing, or breaking-up, operation is dissolved afresh in water and treated as before until all the material has been converted into uniform granular size. The reduction of the metallic platinum in the finest subdivision between the molecules of the salts serving as vehicles for the platinum takes place automatically upon heating. In practice, the salts are always sulphates.

The technical advantage of this contact mass lies partly in the simplicity of its preparation; in its activity, on account of the extremely fine division of its platinum; and on the relatively small quantity of platinum required, both because of its fine division and because the base used also possesses catalytic activity. It is also regenerated readily and the platinum can be easily and completely recovered, on account of the solubility of its base, or vehicle, in water.

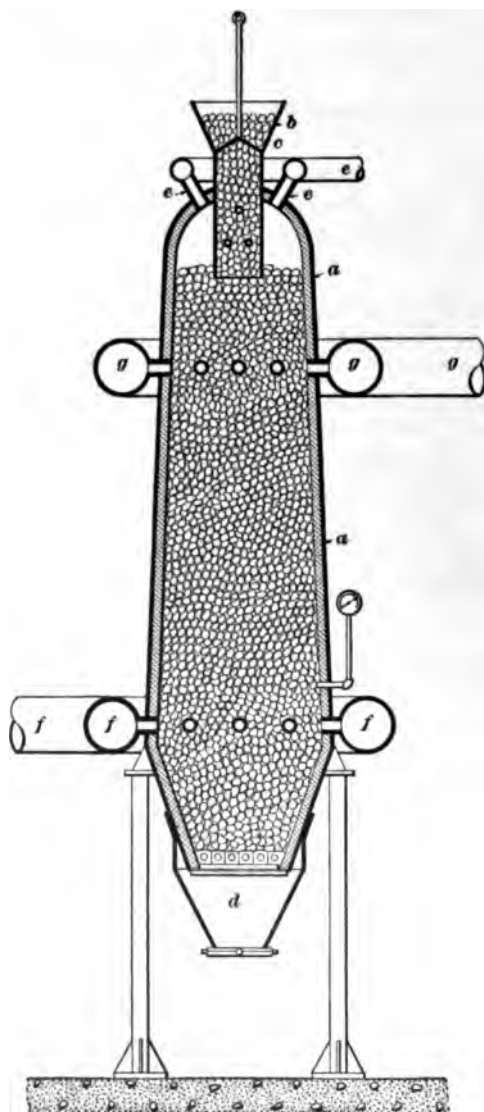

FIG. 10

When ferric oxide, the contact mass of the fourth class, is used, it is in the form of pyrites cinders (desulphurized iron pyrites), and these cinders must be porous and fresh. One advantage claimed for this mass is the removal of the arsenic from the burner gas in its passage through the cinders. It is also necessary to dry the air supplied to the roasting furnaces and to dilute the gas with further admissions of dry air after combustion and before it passes through the contact mass of cinders.

64. Frasch Converter.—A further elaboration of this process is the Frasch converter, which serves to dispense with the necessity for furnaces of special construction and to render it possible to use the burner gas produced by any furnaces of ordinary construction, including the gas from roasting zinc blendes or pyrrhotites, or, in fact, any metallurgical gas.

This converter is based on the fact that in comparison to the amount of pyrites desulphurized to produce the sulphur dioxide, a much smaller quantity of ferric oxide than the ore produces will suffice to oxidize the sulphur dioxide produced to sulphur trioxide; so that the heat produced by roasting the larger part of the ore can be avoided or regulated by roasting the ore in ordinary burners and conducting the burner gas, at a comparatively low temperature, to a converter in which only enough pyrites is burned to maintain the proper temperature and at the same time produce sufficient ferric oxide for the contact substance.

65. The Frasch converter, shown in Fig. 10, consists of a steel cylinder *a*, similar to a cupola furnace, lined with firebrick. Pyrites are charged into the converter through the hopper *b* by means of the bell *c*. The ferric oxide is discharged at the bottom into the double-valve hopper *d*, so as to prevent the admission of air during discharging. This converter is on the down-draft principle. Air is admitted through the pipes *e* and the products of combustion carried away through the pipes *f*. When the furnace is lighted and supplied with iron pyrites, a bed of burned

477101A

pyrites (ferric oxide) is formed, in which there will be various zones of temperature from the upper to the bottom layer of its contents. These zones of temperature can be largely governed by the quantity of pyrites charged to or discharged from the furnace, but in any case a zone of fresh ferric oxide of suitable temperature can be maintained in the furnace at some point. Burner gas (containing sulphur dioxide) from outside sources, whether ordinary pyrites burners or metallurgical furnaces, are now admitted through the pipe *g*, and in passing through the zone of ferric oxide of suitable temperature, the sulphur dioxide is converted into the trioxide.

66. Purification of Burner Gas.—The burner gas, as it comes from the desulphurizing plant, always contains some, and often many, impurities. Of these, flue dust, hydrofluoric acid, arsenic, and selenium have a most detrimental effect upon the contact mass, partly chemical but principally mechanical, as they tend to glaze over and destroy the porosity of the mass, thus rendering it inert. It is further desirable to prevent the formation of dilute sulphuric acid, and its corrosive effect on the apparatus and connections, by at once extracting the sulphur trioxide and moisture contained in the burner gas.

This can be readily accomplished by first passing the gas through a tower constructed in every respect as a Glover tower, which is described later, except that it is packed with smaller pieces of quartz. This tower acts as a scrubber and collects most of the impurities, at the same time cooling the gas to a point where it will more readily deposit the impurities still remaining, in the next purifying apparatus. The heat of the gas also concentrates such weak acid as is formed by the sulphur trioxide and moisture contained in the gas, together with such additional water as may be found necessary to run down the tower. A necessary proportion of this acid, when concentrated sufficiently (to 62° Baumé), and separated from solid impurities by settlement, may be used in the next apparatus to absorb the

moisture driven from the first scrubbing tower. After absorbing this moisture in its dilute condition, it is again run over the first tower and again concentrated, together with the new acid formed in the first tower. The unused increment, ultimately representing the daily quantity of sulphur trioxide contained in the burner gas, is, if pure enough, passed on to be further strengthened by the addition of sulphur trioxide in the main part of the contact plant. If impure, it is sold or used for purposes for which it may be suitable.

67. This first tower also serves another valuable purpose, in that the heat from the burner gas concentrating the dilute acid in the tower forms a considerable volume of steam, which is intimately mixed with the burner gas passing through it. This admixture with steam prevents the formation of volatile hydrogen compounds of the impurities, especially of arsenic, phosphorus, or their compounds, which would otherwise be formed by the action of the concentrated sulphuric acid on the metal of the coolers and the impurities, and which could only be removed with difficulty.

After passing through this first tower, the gas is taken through a long connection to the bottom of a second tower, through which it ascends, meeting a flow of sulphuric acid of at least 62° Baumé (concentrated acid from the first tower). This tower is constructed exactly like a Gay-Lussac tower, which is also described later, except that it is packed with very much smaller pieces of quartz or coke. In this tower the gas is dried and deposits nearly all the remaining impurities.

The burner gas is now passed through a tower of the same construction as the last, but which is dry (neither water nor acid being used) and serves as a final drying filter and cooling apparatus.

68. Other Methods of Purifying the Burner Gas. The above description of the tower system of scrubbing the gas sufficiently discloses the various purifying operations necessary. Other apparatus merely accomplish the same

end by more or less approximate means. Just as in the purification and preheating of boiler feedwater, the requirements, partly chemical and partly mechanical, are accomplished by different forms of apparatus, although the underlying principles are practically the same in all.

In some cases, cooling is first accomplished by long flues between the desulphurizing furnaces and the purifying apparatus. This method is crude and unscientific, as it gives an opportunity for the sulphur trioxide and the water contained in the burner gas to condense, to the great deterioration of the flue and the loss of the acid so formed. Then, again, the steam (required as above) is added direct to the gas from a boiler, instead of utilizing the heat of the burner gas to produce it in the first tower.

69. It has further been proposed to absorb the burner gas in kieselguhr or diatomaceous earth. On the further application of heat, the gas is given off while the impurities are retained in the silicious filter.

The burner gas is now a pure mixture of sulphur dioxide, oxygen, and nitrogen, at about the average temperature of the atmosphere, and is consequently, since leaving the roasting furnaces, reduced in volume about two-thirds, or from 3 volumes to 1.

At this stage of the manufacture, in order to overcome the resistance to the gases likely to be met with in the succeeding apparatus, it is generally necessary to interpose either a compressor or blower. This resistance, according to the methods used, will later vary from a few millimeters of water to 5 or 6 pounds to the square inch. The resistance, in cases where it is small, may be overcome by a vacuum draft at the exit of the system.

If the gas is properly purified and *dried*, iron or phosphor bronze may now be used for the valves, pistons, cylinders, and various connections in contact with the gas.

70. Reheating the Gas.—The gas must now be reheated to the temperature necessary to start the reaction. This varies according to the contact mass used and according to

the richness of the gas in sulphur dioxide. Generally speaking, it will vary from 300° C. to 360° C. with platinized asbestos or the Schroeder-Grillo mass, consisting, as previously stated, of finely divided platinum, with soluble alkaline salts as a carrier, or base.

This reheating can be done by the application of the direct heat of a special fire to coils of tubes through which the gas passes, as in a hot stove. It can also be passed through special apparatus or coils of pipes heated by the dried heat of the desulphurizing furnaces; in other words, utilizing the heat of the oxidation to sulphur dioxide. Or it can be made to pass around the ovens containing the contact mass, thus keeping the temperature of the contact ovens below the dissociation point of sulphur trioxide, and in this way utilizing the heat of the oxidation of the sulphur dioxide to the trioxide.

The above oxidations are exothermic and are as follows:

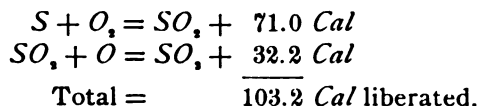

The temperature of the gas about to enter the contact oven must be most carefully regulated.

71. Contact Ovens.—The usual form for contact ovens varies, but generally it consists of cylinders of varying diameters and lengths in which the contact mass is either filled solid, placed on perforated shelves, molded into special shapes, or otherwise disposed of so as to secure the most complete contact with the gas passing through, and at the same time to offer as little resistance to the passage of the gas as possible. Various means are taken to supply additional heat to the ovens at the entering point of the gas when necessary, and similarly to cool the ovens and prevent undue accumulation of heat near the exit of the gas.

If the gas is properly purified and the contact mass is therefore kept in active condition, the whole secret of success with the contact ovens is to maintain such temperatures

as may have been found most advantageous in each individual plant, and with each special contact mass used, and, of course, under any circumstances, between the temperatures necessary to start the reaction and the dissociation point of sulphur trioxide. The gas issuing from the contact oven is now a mixture of sulphur trioxide, nitrogen, and excess of oxygen, and, with a properly working process, very small quantities of sulphur dioxide; and nothing remains but to absorb or dissolve the sulphur trioxide in water, allowing the inert nitrogen and oxygen to pass from the apparatus into the atmosphere.

72. This is usually done on the principle of the reflux cooler; that is, the gas is passed through or over and in the opposite direction to that of a stream of water or weak acid. Consequently, the strongest gas meets the strongest acid and the weakest gas meets the weakest acid, which more readily absorbs it. As the absorbing apparatus is generally of wrought iron, it is usual to start the process with acid not weaker than 60° Baumé.

The combination of sulphur trioxide and water is also exothermic.

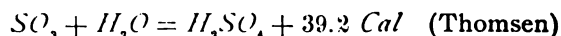

73. Diagram of Contact Process.—In Fig. 11 is shown a diagram of the apparatus used in a sulphuric-acid plant employing the contact process. The course of the various materials and products is indicated by the arrows. *A* is a bench of pyrites burners. The burner gas passes through the flue *a*₁ to the first cleaning tower *B*. Weak sulphuric acid is constantly flowing down this tower, becoming concentrated by the hot burner gas and absorption of the sulphur trioxide contained in the burner gas, and finally flows out at the bottom into the cooler *C* at a strength of from 62° to 64° Baumé. From the cooler *C*, the strong acid passes to the tank *D* and is delivered by the pump *D*₁ to the storage tank *T*, or to the tank *F* over the second cleaning tower *E*. A constant stream of strong sulphuric acid from the tank *F*

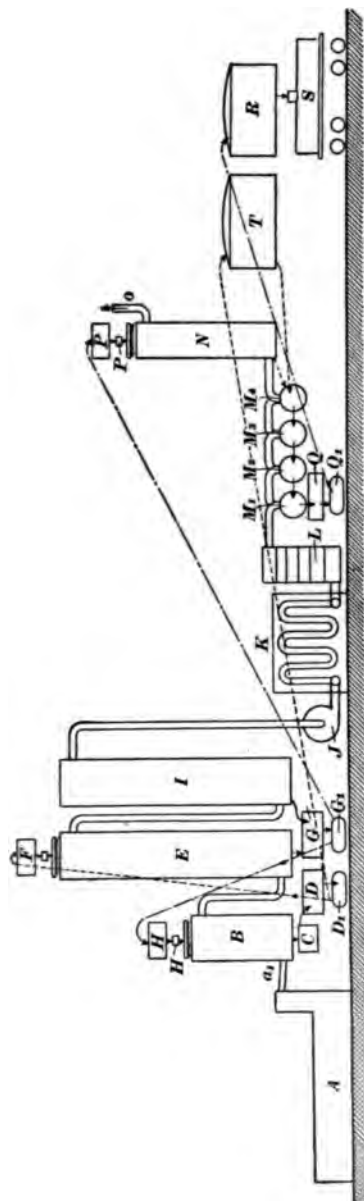

FIG. 11

is kept flowing down this tower. In this tower, the burner gas coming from the top of *B* is further cleaned and then passes to the drying tower *I*; the circulation of the gases through the train of apparatus is maintained by the fan *J*. Before entering the contact ovens, the mixed gases are reheated to the proper temperature for the combination of the sulphur dioxide and oxygen in the reheater *K*.

74. The contact oven *L* consists of cast-iron rings with perforated shelves, or diaphragms, upon which is placed the contact mass.

The sulphur trioxide formed in the contact oven now passes through the absorption cylinders *M*₁, *M*₂, *M*₃, *M*₄. These are cylindrical iron tanks connected in such a way that the gas passes from end to end, meeting the weak acid flowing in the opposite direction. Both the gas and the acid in *M*₁ are richest in sulphur trioxide, while in *M*₄ the gas and acid are weak, and such weak acid absorbs sulphur

trioxide most readily. The strong acid, which is ready for the market as it comes from M_1 , is collected in the tank Q and is delivered by the pump Q_1 to the storage tank R .

The gases coming from the last absorption tank M_4 contains still a small amount of unabsorbed sulphur trioxide. In order to recover this, the gases are passed through the tower N , which is supplied with weak acid from the tank P , which absorbs the last traces of sulphur trioxide. The nitrogen and oxygen remaining pass into the air through the pipe o . The tank car S receives acid for shipment from the storage tank R .

SULPHURIC ACID

(PART 2)

THE CHAMBER PROCESS

INTRODUCTION

1. We have seen that the oxidation of sulphur, under ordinary conditions, produces so much heat as to render the existence of the trioxide possible only to a limited extent, except in the presence of a third material possessing so-called "contact" properties, such as pyrites, cinders, spongy platinum, cupric sulphate, etc. Also, that some of these so-called contact substances, while producing a chemical reaction, remain themselves in the end unchanged, whatever intermediate reactions they may or may not have taken part in. In some of the contact phenomena, such intermediate reactions can be traced, or, at any rate, such is the only way of accounting for them. In the case of contact phenomena connected with the complete oxidation of sulphur into the trioxide, it is apparently possible that electrical action is set up, which permits the formation of the trioxide either by converting the excessive heat into another form of energy, or which renders the oxygen, free or combined with the sulphur dioxide, more active. In any case, the contact substance in the final result appears to suffer no chemical change or deterioration, but only the inevitable mechanical loss in handling.

§ 28

For notice of copyright, see page immediately following the title page

2. It will now be seen that the **chamber process** is in nature a contact process, inasmuch as a definite chemical reaction between large volumes of sulphur dioxide, oxygen, and water is induced by a small quantity of nitrous oxide N_2O , which is recovered unchanged save for mechanical loss; and yet without which the reaction would not have taken place. In this case of contact action, however, the intermediate reactions have been studied and are fairly well understood.

When using the nitrous oxides as contact substance, or oxidizer, of sulphur dioxide, the presence of water is absolutely necessary and, consequently, only a hydrate or solution of sulphur trioxide can be formed. If water were not present, sulphur trioxide would be formed, but it would combine with the nitrous acid to form nitrososulphuric acid, or chamber crystals, $(HO)(NO_2)SO_3$. Water dissolves these crystals, forming sulphuric acid and releasing the oxides of nitrogen. Furthermore, water must be largely in excess of the quantity required to produce the hydrate H_2SO_4 , as otherwise the oxides of nitrogen would be absorbed and retained in the sulphuric acid; in fact, it must be so much in excess as not to produce an acid stronger than about 69 per cent. of the monohydrate (54° to 55° Baumé).

3. **Reactions of the Chamber Process.**—The following explanation of the reactions that take place appears to be the most rational and the one that coincides most closely with the conditions of the actual chamber process.

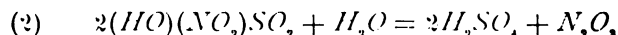
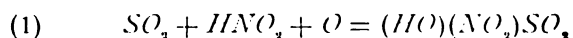

If, in the above reactions, sulphur dioxide, nitrous acid, oxygen, and water be simply taken in definite quantity, then a definite quantity of sulphuric hydrate and nitrous oxide will be formed according to the above equations. The reaction would end and the excess of sulphur dioxide, if any, would pass on unchanged; but in the presence of excess of air

and water the nitrous oxide is converted into nitrous acid, according to the following equation :

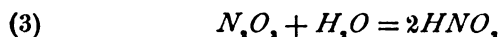

which again combines, according to equation (1) with the sulphur dioxide so long as the latter is present in sufficient quantity.

Or, in the presence of excess of oxygen (air) and water (vapor or steam), sulphur dioxide, nitrous acid, and oxygen form nitrososulphuric acid (chamber crystals). This is immediately decomposed by water into sulphuric hydrate and nitrous oxide N_2O . The sulphuric hydrate condenses in the apparatus as a stable compound, while the nitrous anhydride, with the water, forms nitrous acid, and the above reactions are repeated until the sulphur dioxide is practically all converted into sulphuric hydrate H_2SO_4 .

4. In addition to the above principal reactions, another set of reactions appears to take place in the Glover tower and the first part of the first chamber, that is, where the sulphur dioxide is largely in excess, and in which the nitrososulphuric acid is partially decomposed by it.

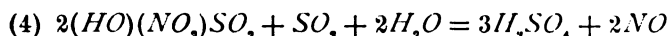

the oxide thus formed combining directly with the sulphur dioxide, oxygen, and water to form nitrososulphuric acid.

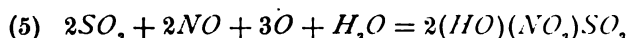

which is converted into sulphuric hydrate and nitrous oxide according to equation (2).

If the above reactions could be started with the exact quantities of nitrous acid, sulphur dioxide, water, and oxygen necessary, it is evident, to secure a continuous process, all that would be necessary would be to secure a continuous supply of the exact quantities of sulphur dioxide, oxygen, and water, and return to the beginning of the process the nitrous oxide accumulated at the end of the process by simply supplying any mechanical loss common to all commercial processes.

This is approximately what is done in the chamber process. The nitrous oxide cannot, however, be returned direct, as the oxygen, being supplied as air, carries with it a very large proportion of inert nitrogen, which must be gotten rid of. It becomes necessary, therefore, to separate

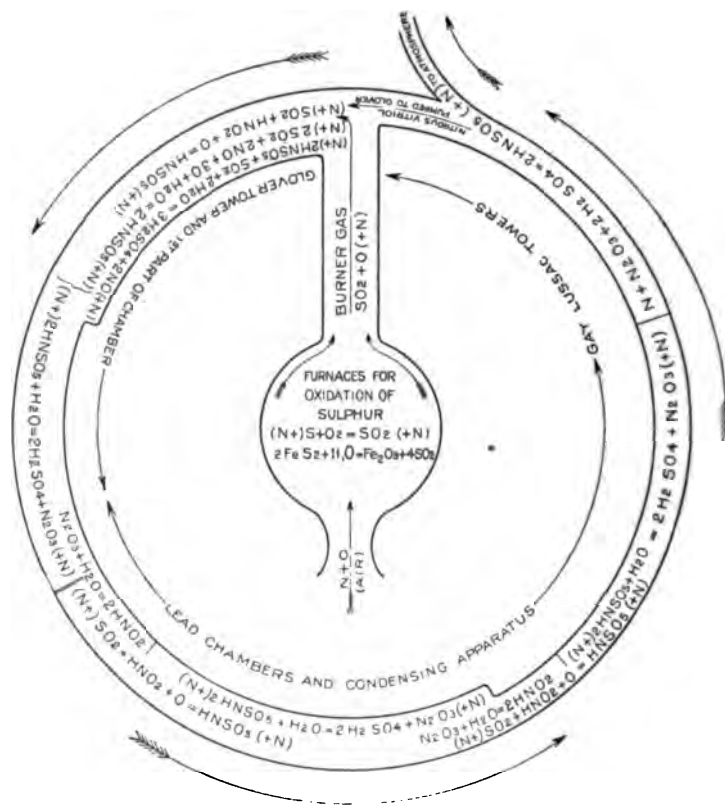
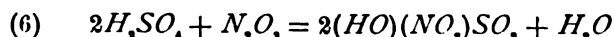

FIG. 1

the nitrous oxide from the inert nitrogen in such a way that the N_2O can again be made available and the inert nitrogen wasted into the atmosphere.

Advantage is taken of the power of the stronger solutions of sulphur trioxide from 60° to 66° Baumé, to absorb and retain the nitrous oxide in fairly stable solution.



In other words, nitrososulphuric acid is formed. When dissolved in a large excess of the sulphuric-acid solution, the product is termed *nitrous vitriol*. The nitrous anhydride so absorbed can be set free, however, on dilution of the acid and especially in the presence of sulphur dioxide. When this nitrous vitriol is diluted, in the presence of sulphur dioxide at the beginning of the process, so as to set free the nitrous anhydride and complete the cycle, the reaction is represented by equation (4) above given. The diagram in Fig. 1 shows the chemical reactions that take place during a complete cycle. To read it, begin at the center and follow the direction of the arrows.

APPARATUS EMPLOYED IN THE CHAMBER PROCESS

5. In the manufacture of sulphuric acid by the so-called chamber process, the first essential piece of apparatus is a sulphur or pyrites burner provided with some means of nitrating the burner gas. Any of the burners previously described may be used.

6. Nitrating Oven.—Fig. 2 (*a*) and (*b*) shows an attachment to the burners by which nitrating by potting may be accomplished. Fig. 2 (*a*) is a horizontal section through the niter pots *d*, and Fig. 2 (*b*) is a vertical longitudinal section through one of these niter pots. The extreme end of a bench of lump pyrites burners is shown at *a*. The flues *b* from the burners enlarge into the niter ovens *c*, in which are placed the cast-iron niter pots, or "pigs," *d*. The cast-iron dishes *e* underneath the niter pots catch any acid material boiling over from the pots and prevent its penetrating the brickwork of the furnace. A cast-iron hopper, or funnel, *f* provides for the introduction of niter and sulphuric acid into the niter pots, the acid being stored in the tank *g* and conducted by a lead pipe and cock to the

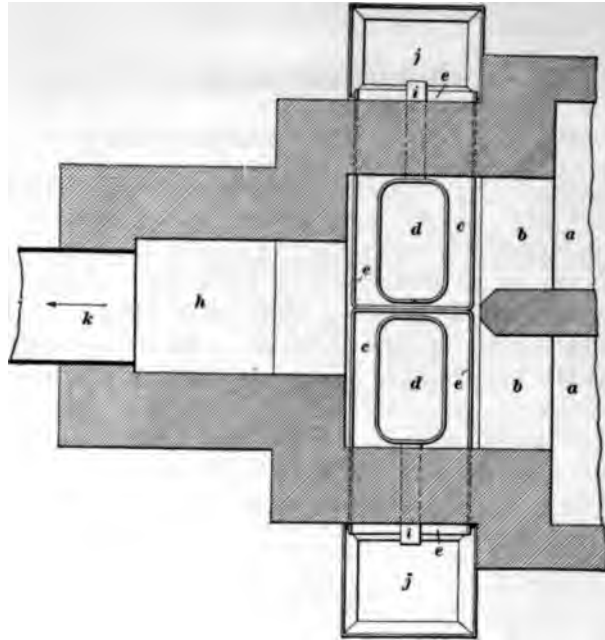

(a)

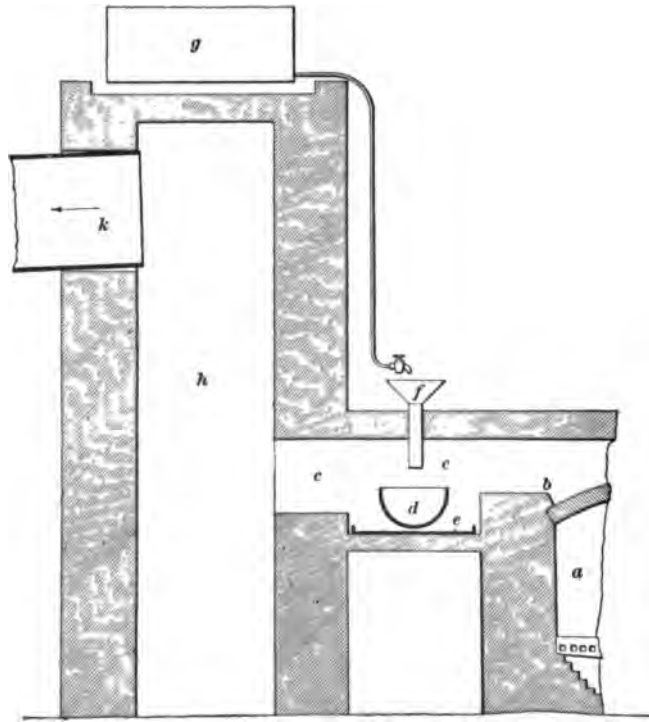

(b)

FIG. 2

hopper. The common flue and dust chamber *h* leads to the cast-iron flue *k*, through which the gas is carried to the Glover tower.

When the burners are in operation, the pots *d* are supplied with niter and a regulated amount of sulphuric acid added. The fumes of nitric acid thus formed mix with the hot burner gas and pass to the Glover tower. The sodium sulphate formed in the pots is removed through the cast-iron neck *i*, which is usually kept closed with a wooden plug, into the cast-iron dishes *j*. When cold and solid, it is broken up and removed.

7. This method of nitrating by "potting" is by no means satisfactory, because it adds another element of periodic irregularity to what should be a continuous process, and because, unless in the hands of careful and skilled workmen, it is a wasteful and a dirty process. It is also difficult in this way to supply the chambers with nitrous oxide just in the quantity and at the time when it is most wanted—that is, when something in the process is going wrong. Sometimes, also, on account of faulty construction, there is insufficient heat to decompose the niter rapidly enough or else the heat is too great and too direct and the sulphuric acid is evaporated before it has reacted completely with the sodium nitrate.

Wherever, therefore, the size of the plant justifies the manufacture of nitric acid on a small scale or where it is in any way possible, nitration should be secured by the use of nitric acid run into the Glover tower with the nitrous vitriol. This is accomplished by means of a small glass siphon from the nitric-acid tank or carboy, fitted with a glass cock and discharging from the cock into a glass funnel with a bent neck, so as to form a seal or lute and fixed into the center of the top lead of the tower. It does not matter how weak or impure the nitric acid may be for this purpose; indeed, in some works, the spent acid from the manufacture of nitroglycerin is used, as the acid is almost instantly decomposed upon entering the tower.

8. Glover Tower.—The apparatus in which the sulphur dioxide, oxygen, and nitrogen of the burner gas are mixed with the nitrous oxide N_2O , derived from the nitrous vitriol used in this stage of the process, water vapor and the nitrous fumes from the nitrating ovens, which after the process is once under way is only sufficient to make up for the mechanical loss, is known as the **Glover tower**. In this tower, the gases and vapors are not only thoroughly mixed, but the dilute sulphuric acid constantly flowing down is both denitrated and concentrated by the hot gases, rendering it strong enough to be again used for absorbing N_2O , at the end of the process.

9. The heat of combustion of the sulphur to SO_2 in the furnaces is usually more than sufficient to concentrate the whole of the make of chamber acid if entirely utilized to 66° Baumé, or to 93.5-per-cent. H_2SO_4 . In a well-constructed plant, that is, where the heat is fairly well utilized, the Glover tower will concentrate from one and one-half times to twice the entire make of chamber acid to 60° or 62° Baumé (62- to 80-per-cent. H_2SO_4), or, in other words, this quantity of chamber acid can be used to dilute the nitrous vitriol and will leave the Glover tower at 60° Baumé, or over. Of course, if it is not desired to keep this amount of acid in circulation between the Glover and Gay-Lussac towers, the nitrous vitriol may be diluted in whole or in part with water.

The temperature of the burner gas entering the Glover tower will vary, of course, with the construction and length of connections, but will average probably about 550° C. The greatest possible temperature produced by the combustion of sulphur will, of course, vary with the nature of the raw material. Mendeléeff estimates the highest possible temperature of actual sulphur burning in air to be 1,974° C. and in oxygen 7,258° C.

10. The construction of the Glover tower is clearly shown in Fig. 3. It consists of a circular brick-lined tower *e*

covered with a lead sheathing *p* and lead pan *o* at the bottom, and is filled to near the exit pipe *g* with a packing *f*

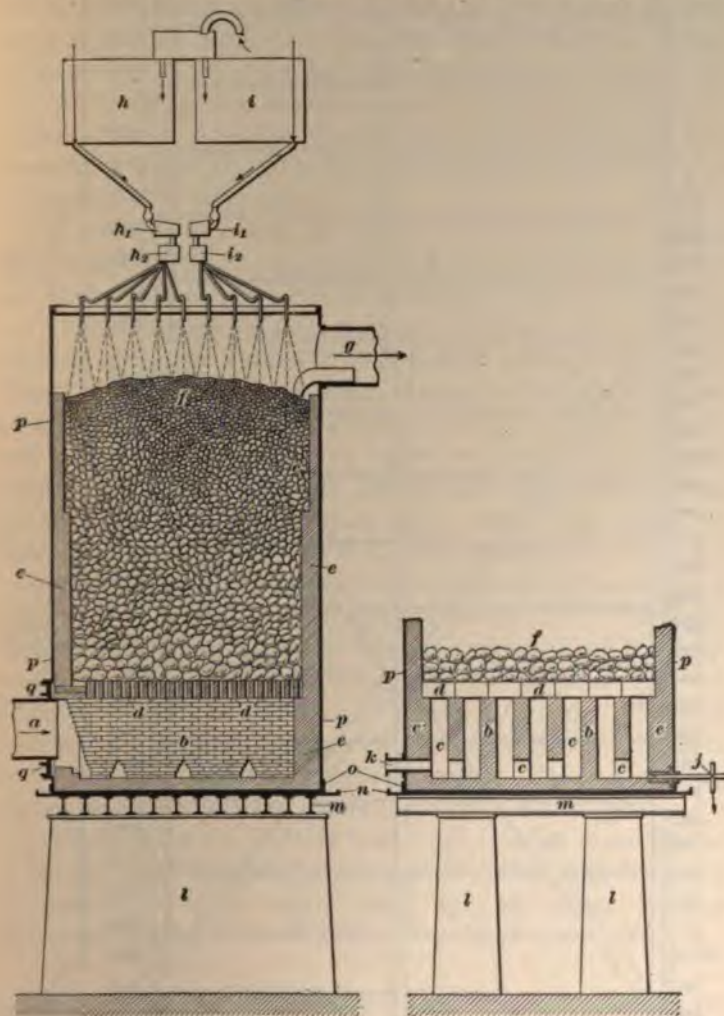

FIG. 3

consisting of broken quartz, the pieces being large at the bottom, but decrease in size towards the top. This packing

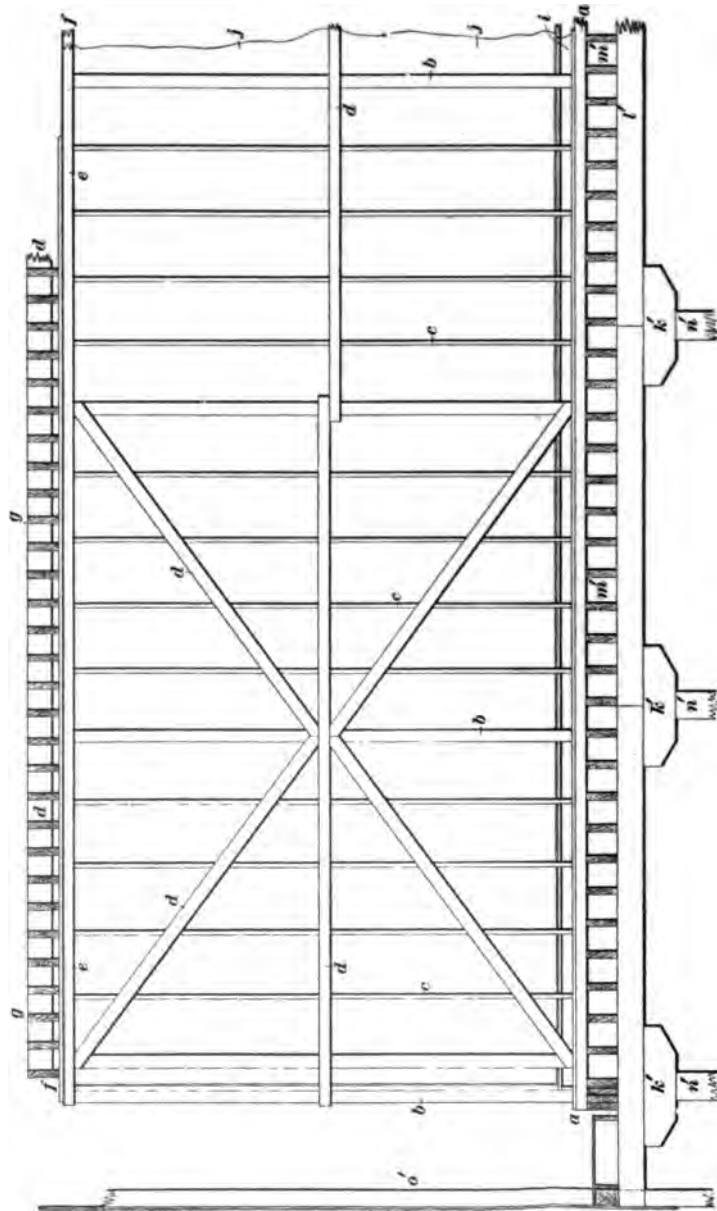

FIG. 4

rests upon the grill tiles d , which are supported by the walls b . The tank h contains dilute or chamber acid, which flows through the equalizer h_1 and the distributor h_2 over the top of the packing. On the other side is a similar arrangement i , i_1 , and i_2 for the distribution of nitrous vitriol, which is strong sulphuric acid coming from the Gay-Lussac tower, described later, and heavily charged with nitrous oxide N_2O , this N_2O being set free on dilution of the vitriol in this tower.

The burner gas enters the tower at the bottom by means of the pipe a , which is surrounded next the tower by the cast-iron cooling ring q , which prevents the heat from injuring the lead sheathing next the pipe. The gas is distributed through the gas spaces c and passes through the grill tiling up through the packing, coming in intimate contact with the dilute acids from above, which are giving up N_2O , and become mixed with the latter and also with steam formed by the hot burner gas on the dilute acid. This mixture of burner gas, nitrous oxide, and steam passes on through the pipe g into the first lead chamber.

As previously stated, the rapid evaporation of the moisture concentrates the down-flowing acid considerably. The denitrated and concentrated acid having a strength of from 60° to 62° Baumé is drawn off at j ; the lead-covered cast-iron plate, or dish, u catches the acid or other leakage. The exit pipe k is for use when the tower is washed by flooding with acid in too large quantity to pass through j . The tower is supported on the foundation walls l and the I beams m .

In dimensions, the Glover tower will average about 24 feet in height and 12 feet in diameter. The construction is necessarily heavy, in order that it may withstand the high temperatures.

11. Lead Chambers.—The thoroughly mixed gases from the Glover tower containing nitrous oxide N_2O , and water vapor are allowed to pass to the chambers in which the oxidation of the sulphur dioxide to trioxide and the formation of sulphuric hydrates takes place. These chambers

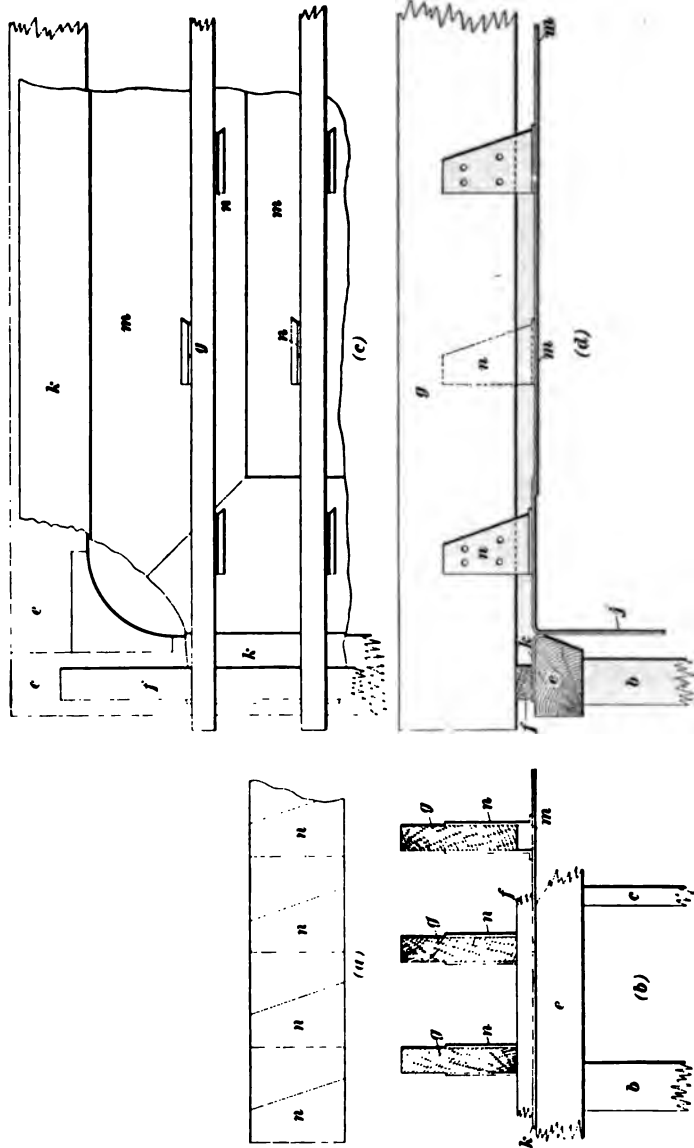

FIG. 5

are usually three in number, of greatly varying dimensions, but average between 50 and 100 feet long by from 20 to 30 feet wide and 20 to 30 feet high. They are connected together in series, the communication between them being comparatively small. The construction of the chambers is shown in Figs. 4, 5, 6, and 7.

Fig. 4 is a side elevation, showing the method of framing. The chamber building is built on posts n' upon which are the corbels k' supporting the stringers l' . The joists m' are laid on these stringers, and upon these are laid the sills a of the chambers. The posts b and the intermediate uprights c are erected upon the sills and stiffened by the braces d . The crown tree e surmounts the posts and intermediates, and on this the top joists g are laid. The floor of the chamber is covered with sheet lead, so as to form a pan whose edge is shown at i . The edge of the lead curtain forming the inside lining of the sides is shown at j . The end wall of the chamber building is shown at o' .

12. In Fig. 5 (*a*), (*b*), (*c*), and (*d*) is shown the method of attaching and supporting the lead lining. Fig. 5 (*a*) shows the method of cutting the lead straps for supporting the lead lining. Fig. 5 (*b*) shows the top joists g with the lead straps n attached, the lower ends of the straps being burned to the top lead m . Fig. 5 (*c*) is a plan of the top, showing the method of fitting the lead lining into the corners. The top lead m is supported from the top joists g . The crown tree is at e . A long horizontal strap k is nailed to the crown tree and supports the side lead at the top where it is attached to the top lead. The attachment of the top and side leads is best shown in Fig. 5 (*d*), which is self-explanatory.

In Fig. 6 (*a*), (*b*), and (*c*), further details of the attachment of the side and pan lead are shown. Fig. 6 (*a*) shows a horizontal section through the posts b and the uprights c at a corner, showing the attachment of the side straps l to both posts and lead. Fig. 6 (*b*) is a side elevation towards the bottom of the chamber, showing the method of attaching

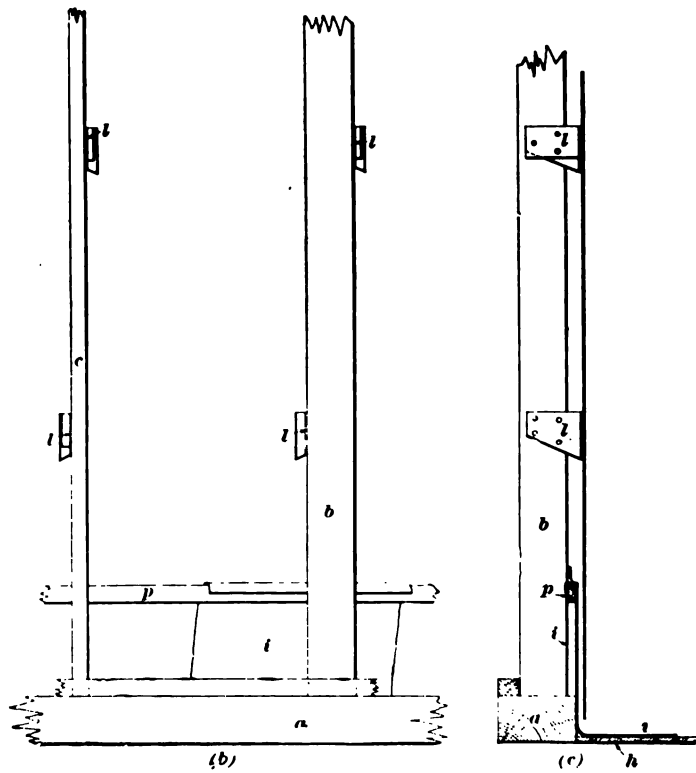
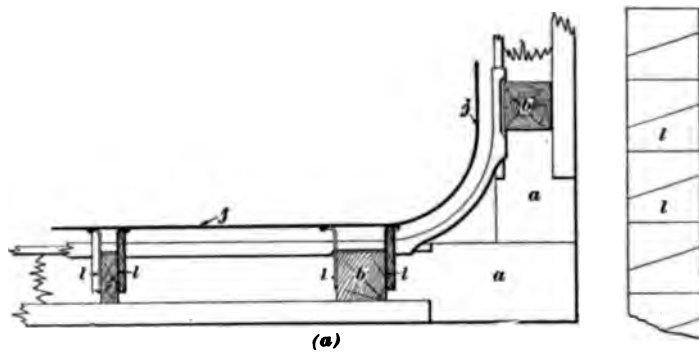

FIG. 6

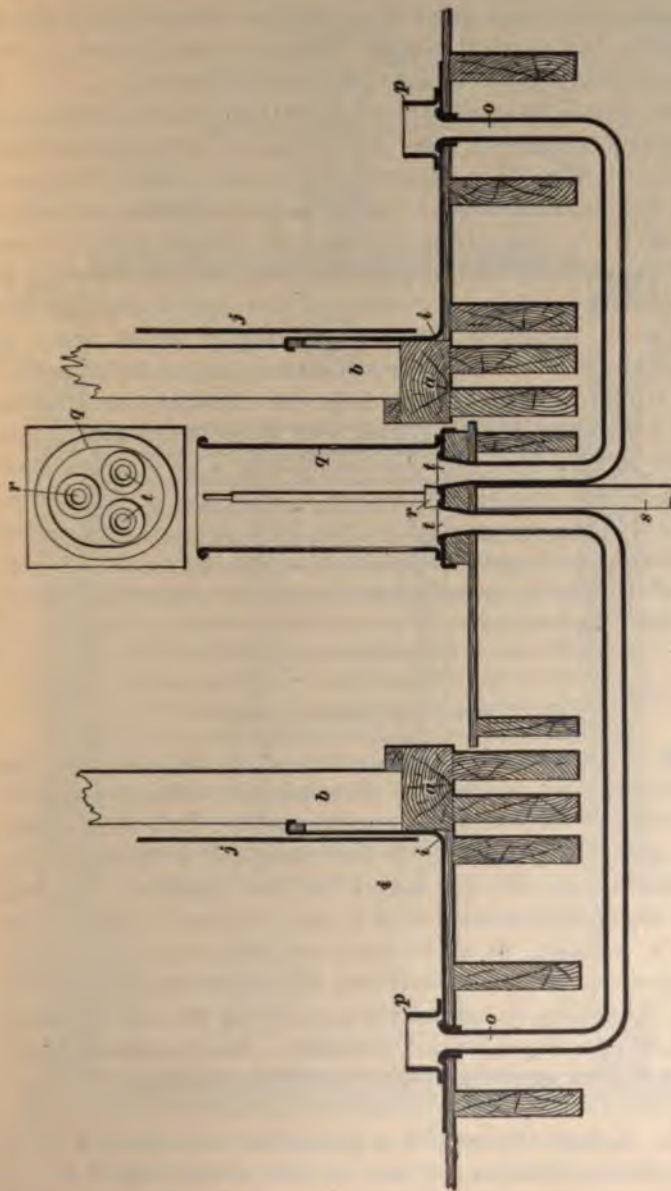

FIG. 7

the sides of the lead pan *i* by rolling the top over the strip *p*. Fig. 6 (*c*) is a vertical section through a side, showing the relative positions of the side lead *j* to the pan *i*.

This pan is kept about two-thirds full of acid and at all times the curtains or sides should dip at least 2 inches into the acid. When it is desired to draw acid from the chambers, it is done by means of the arrangement shown in section in Fig. 7. A pipe *o* is burned into the bottom of the chamber; the entrance to this pipe is protected from the wash of the flowing acid and a stratum of cool acid is kept on the bottom by means of a loose lead ring *p*, which may be removed when it is necessary to entirely empty the chamber. The pipes from two or more adjacent chambers meet in the cylindrical lead boot *q*. This boot is provided with a lead plug *r* or valve and seat communicating with a pipe *s* leading from the chambers to a tank or wherever it can flow by gravity. The entrances *t* to the boot from the chambers can also be plugged, so that acid can be drawn from either chamber or both, and the level in the two chambers can be regulated as desired.

SURFACE CONDENSERS

13. Immediately on the entering of the gas into the chambers, the formation of sulphuric acid commences. This acid is formed as a very fine mist. This mist gradually and slowly settles on the sides and bottoms of the chambers. As the gas leaves the first chamber it is very advantageous to condense this mist of already formed acid that it contains, so as to leave the gas free to enter into renewed activity upon entering the second chamber. The same thing may be said of the gas leaving the second chamber and entering the third chamber. Many proposals have been made to secure condensation at these points.

14. Lunge Condenser.—Lunge has introduced what he calls **plate columns** for this purpose, consisting of a lead tower, or column, fitted with flat, perforated, earthenware

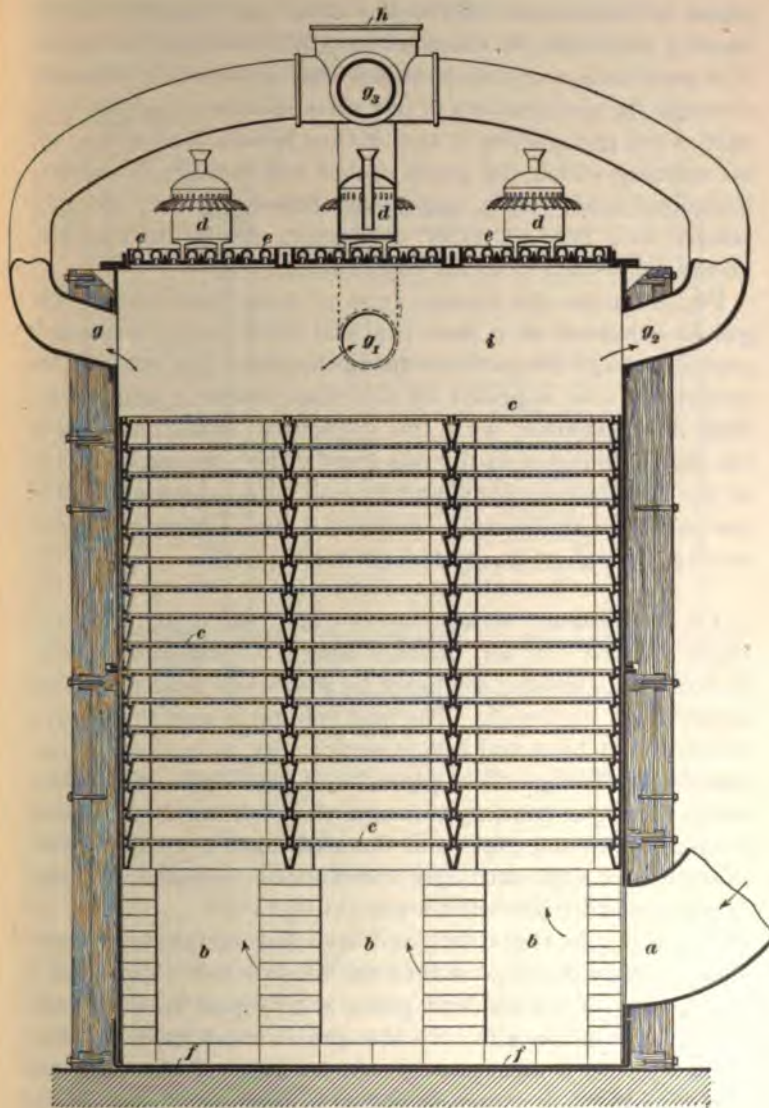

FIG. 8

plates in layers one above the other and about 2 inches apart. A stream of chamber acid is run over the plates. The perforations are so arranged that the acid in dropping through the perforations of one plate splashes upon the solid part of the plate below it and is thus broken into spray, upon meeting which the gas is cooled and deposits its mist of contained acid. This apparatus, therefore, may be considered as a type of spray condenser, similar to the well-known form used in steam engineering.

Fig. 8 shows the Lunge type of spray condenser. The gas is admitted at *a* into the lead-lined box *b*, whence it passes through the perforations in the plates *c, c*, meeting the stream of acid supplied by the distributors *d* and lutes *e*. This acid, together with the condensed mist contained in the gas, is collected in the pan *f* and either run back into one of the chambers or conveyed by lead pipe to storage. The gas passes on to the vent chamber *i* and through the collecting pipes *g, g₁, g₂, g₃*, and the main pipe *h*.

15. Gilchrist Condenser.—The Gilchrist pipe columns consist of an oblong tower, or column, of lead pierced in its smaller diameter by a series of lead pipes open to the air at each end. The lead column is surrounded by a wooden breaching and flue in such a way as to cause a current of air through these pipes, thus tending to keep them cool. The gas passing through this column is cooled by contact with these pipes and the acid mist is condensed on them. This apparatus may therefore be considered a type of air-cooled surface condenser.

Fig. 9 shows the Gilchrist air-cooled surface condenser. The gas is admitted at *a* into the lead box *b*. This box is pierced by numerous lead pipes *c, c, c*, open at both ends. The acid mist contained in the gas is condensed on these pipes and the comparatively cool surfaces of the lead box and runs to the bottom of the box *b*, whence it is carried to a chamber, or storage, by a pipe *d*. The gas then passes through the collecting pipe *e* to the vent chamber. The lead box is surrounded by a wooden breaching, so that the

air entering *g* from below is drawn through the lead pipes *c, c, c* into the breaching *g'* and thence to the draft pipe *f*, thus tending to keep the apparatus cool.

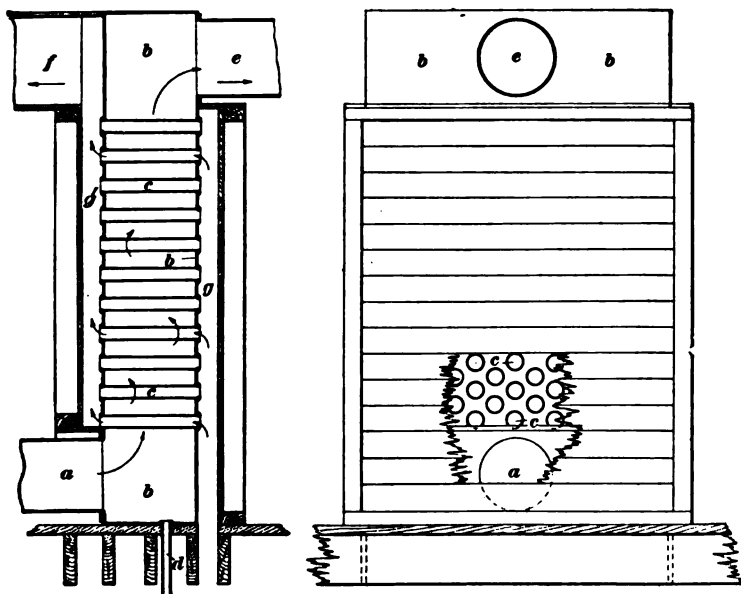

FIG. 9

16. The Falding Condenser.—The Falding surface condenser consists of a series of lead pipes surrounded by water as the cooling medium. They are arranged in such a way as to secure a maximum efficiency with a minimum use of water. This apparatus may therefore be considered as a type of water-cooled surface condenser.

Fig. 10 shows the Falding water-cooled surface condenser. In this condenser, the entering gas is broken up into a number of small streams through lead pipes *a, a, a*. These pipes dip almost to the bottom of a series of water-cooled lead pipes *d, d*, of larger diameter, with closed bottoms. The annular space between these pipes contains a strip of lead, which forces the gas to return in a spiral through acid to the top of the annular space, whence it

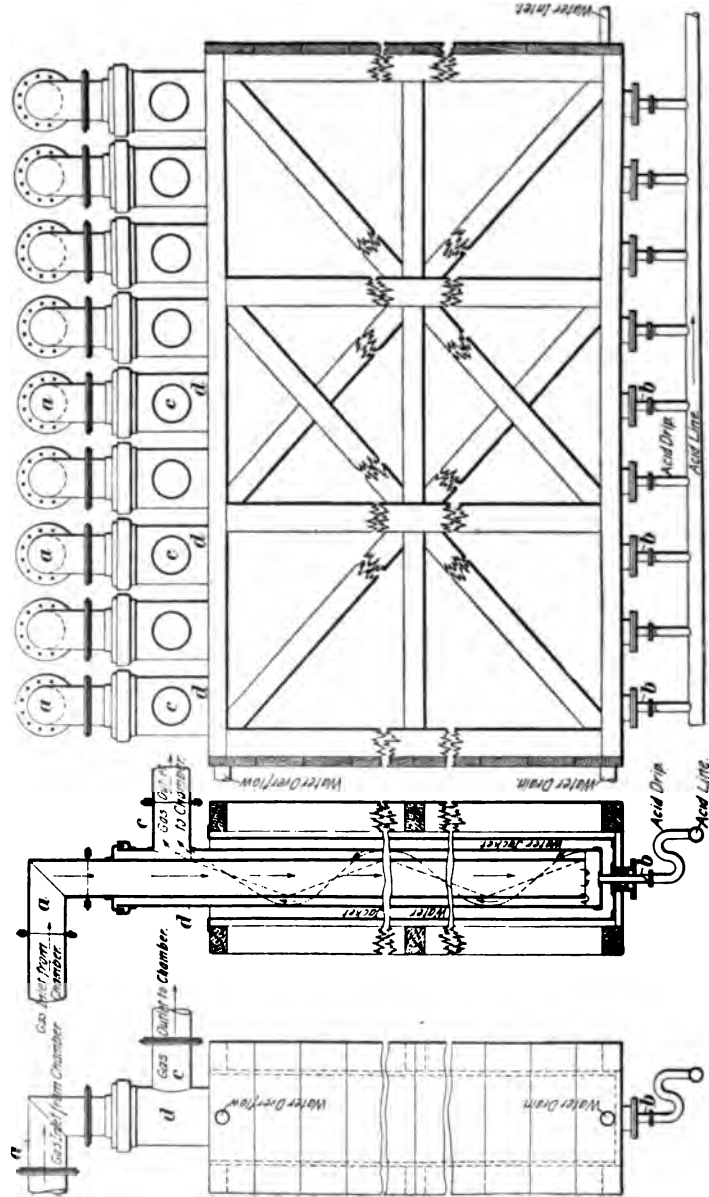

FIG. 10

passes through pipes c, c into the next chamber or into a header or manifold and thence into the next chamber. The condensed acid mist runs from the apparatus at b .

17. Other Condensers.—Many manufacturers use simple lead towers filled with quartz, brick, or special earthenware shapes. These towers do not take sufficient account of the necessity for cooling, and while they are efficient to a certain extent, they are not sufficiently so when their cost relative to an equal amount of chamber spaces is taken into consideration.

If all operations have been properly conducted, the gases coming from the last lead chamber are practically free from sulphur dioxide, and consist of inert nitrogen, the excess of oxygen, and nitrous oxide N_2O . This latter gas, if freed from the other two gases, may be used over again as an oxidizer for more sulphur dioxide. This separation depends on the fact that nitrous oxide N_2O is readily absorbed by concentrated sulphuric acid forming the so-called nitrous vitriol, while the other useless gases are unabsorbed. The apparatus in which this absorption takes place is called the *Gay-Lussac tower*.

18. Gay-Lussac Tower.—This piece of apparatus is in construction very similar to the Glover tower, but differs from it in that it is of somewhat lighter build. Its height is greater, the average height being about 50 feet, and its diameter is somewhat less, being about 8 to 10 feet.

The details of the Gay-Lussac tower are shown in Fig. 11. The brick walls e are of light weight and are covered with a lead sheathing p . Under the brick bottom is the lead pan o resting in the lead-covered cast-iron dish u . The tower is supported on the **I** beams m by the foundation walls l .

The filling f is of broken quartz, coarse at the bottom but becoming finer at the top, as in the Glover tower. The tank h contains strong, 62° Baumé, sulphuric acid, which flows through the equalizer t and the distributors s over the top of the packing.

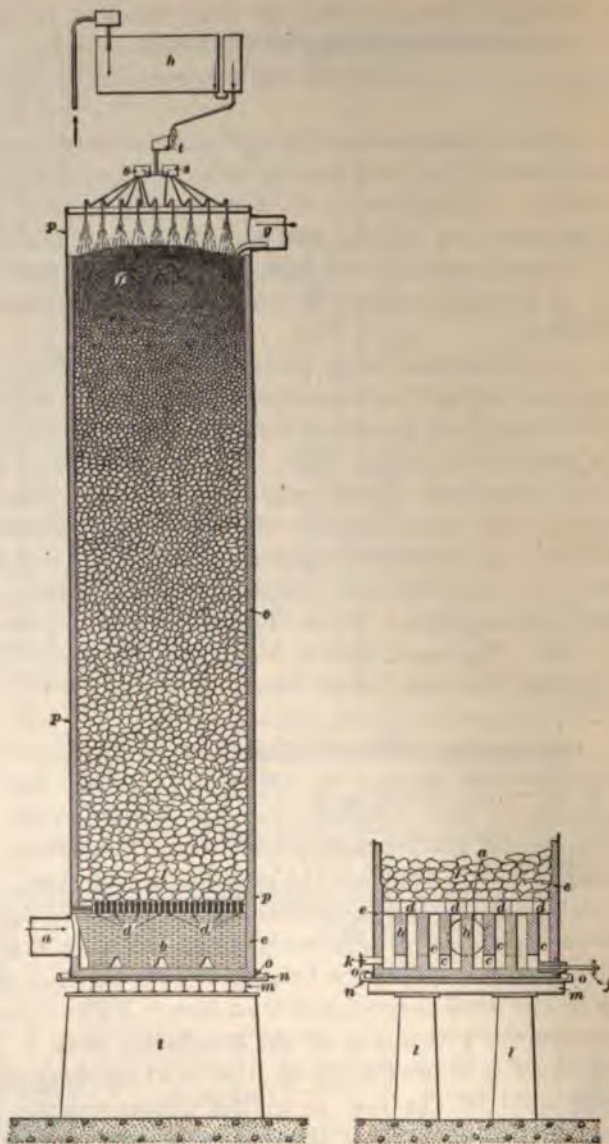

FIG. 11

During operation, the mixed gases from the chambers enter at the bottom through the pipe *a*, pass through the gas spaces *c* in the supporting wall *b*, and up through the grill *d* into the packing material. As the gases ascend, they come in contact with the descending concentrated sulphuric acid, which absorbs the N_2O . The unabsorbed gases pass through the pipe *g* into the air or, more commonly, into a second Gay-Lussac tower, which absorbs any N_2O that may have escaped absorption in the first tower. The nitrous vitriol is drawn off at the bottom of the tower at *j*. The exit *k* is for flushing purposes.

The nitrous vitriol coming from the Gay-Lussac tower is pumped to the tank over the Glover tower and is used in the Glover tower, where it gives up its N_2O , which again passes through the system.

19. Diagram of Chamber Process.—The disposition of the various pieces of apparatus already described and the cause of the various materials and products is indicated in the diagram shown in Fig. 12. Reference to this diagram will enable one to keep a general idea of a plant in mind and better understand the process as the details are discussed.

In the figure, *A* is a bench of pyrites burners, niter oven, etc. The burner gas is conducted through the pipe *d* to the Glover tower *E*, where it meets the dilute acids and oxides of nitrogen. The fan *J* carries the gases through the pipe *i* to the first chamber *K*, where oxidation of the sulphur dioxide takes place, thence to the second and third chambers *M* and *N*, through the flues *i*₁ and *i*₂ and surface condensers *L* and *L*₁. The acid drained from the bottom of each chamber and the condensers is collected in the tank *R*₂.

The pump *S*₂ of one of the styles shown in Figs. 13 and 14 delivers this acid to the tank *H*₁, over the Glover tower, or to the storage tank *U*, whence it goes to the tank car *V*. The strong acid coming from the Glover tower is collected in tanks *Q* and *R*₁ and is delivered by the pump *S*₁ to the tank *H*₂, over the second Gay-Lussac tower *P* and to the

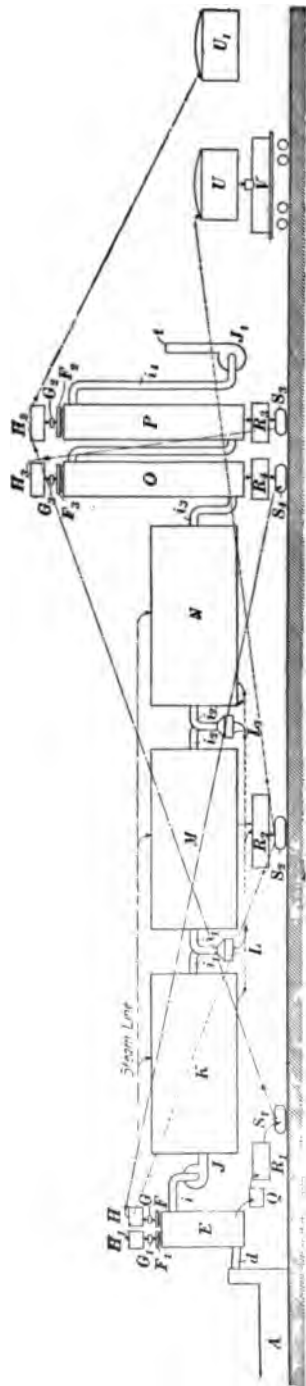

FIG. 13

storage tank U_1 . The gases from the last chamber N are conducted through the pipe i_1 to the first Gay-Lussac tower O and thence to the second Gay-Lussac tower P , their flow being maintained by the fan J_1 . The exhausted gases pass to the atmosphere at t . The nitrous vitriol from the first Gay-Lussac tower is collected in the tank R_1 and is delivered by the pump S_1 to the tank H over the Glover tower. The nitrous vitriol from the second Gay-Lussac tower, containing but little N_2O_3 , is collected in the tank R_2 and is delivered by the pump S_2 to the tank H , over the first Gay-Lussac tower. In different works, this scheme varies somewhat in detail, but not in its essential points.

20. Acid Pumps.—In both the catalytic and chamber processes, it is necessary to transfer large volumes of acid from one part of the works to another. This is done by means of pumps of peculiar construction, some of which are designed to act automatically, so as to give a continuous flow of acid. Two styles of pumps, the *Kestner automatic* and *Monteju's acid egg*, are here described.

21. Kestner Automatic Pump.—This apparatus, shown in Fig. 13, is automatic and works continuously; it is constructed of cast iron for strong acid, but is lead lined for weak acids. It is operated by compressed air. The acid chamber is connected by the vertical pipe b with the valve box c , which must be placed higher than the tank supplying the apparatus, so that in no case acid can rise within a foot or two of it. Acid is admitted from the supply to a by means of the pipe d and check-valve e . The float f connected with the counterbalanced compressed-air valve g by means of the rigid rod h running inside the vertical pipe b and stuffingbox i , is raised by the inflowing acid until it opens the compressed-air valve g . The compressed air from the pipe l communicating with i at j flows through the pipe b into the acid chamber a , driving the acid up through the pipe k to a receiving tank; for instance, on top of a tower. As soon as chamber a is empty the float falls, closing the air valve, and the operation is repeated. The air valve and

float are so balanced that the total movement of the rod does not exceed $\frac{1}{16}$ inch. The great advantage of this apparatus is that it insures a steady flow of acid (which can be accurately controlled) over the towers.

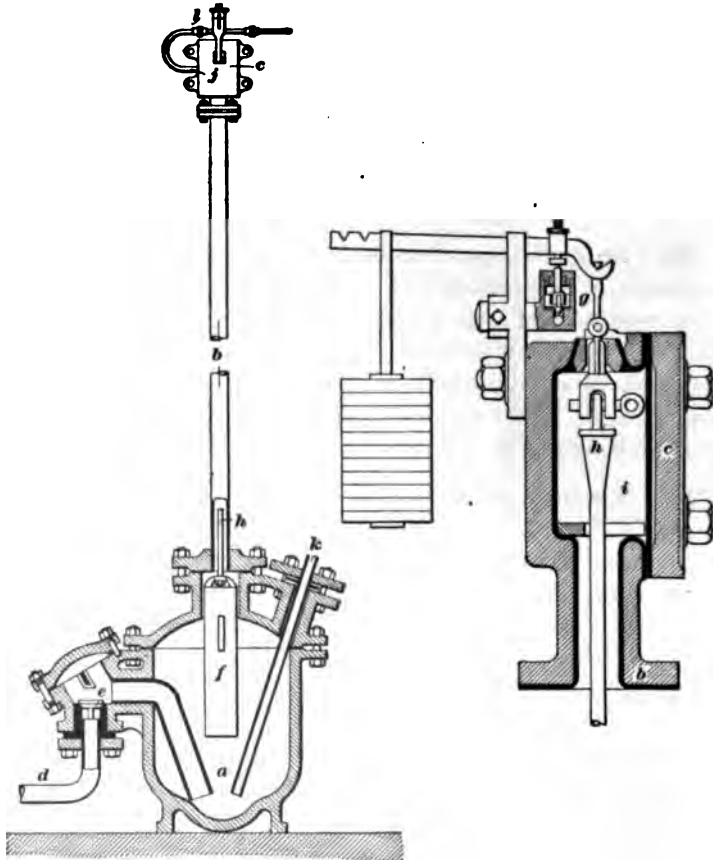

FIG. 13

22. Montaju's Pump With Acid Egg.—This pumping arrangement is illustrated in Fig. 14. The tank *A* containing the acid communicates at *e* with the receptacle or "egg" *G* by means of the pipe *b*, the flow being controlled

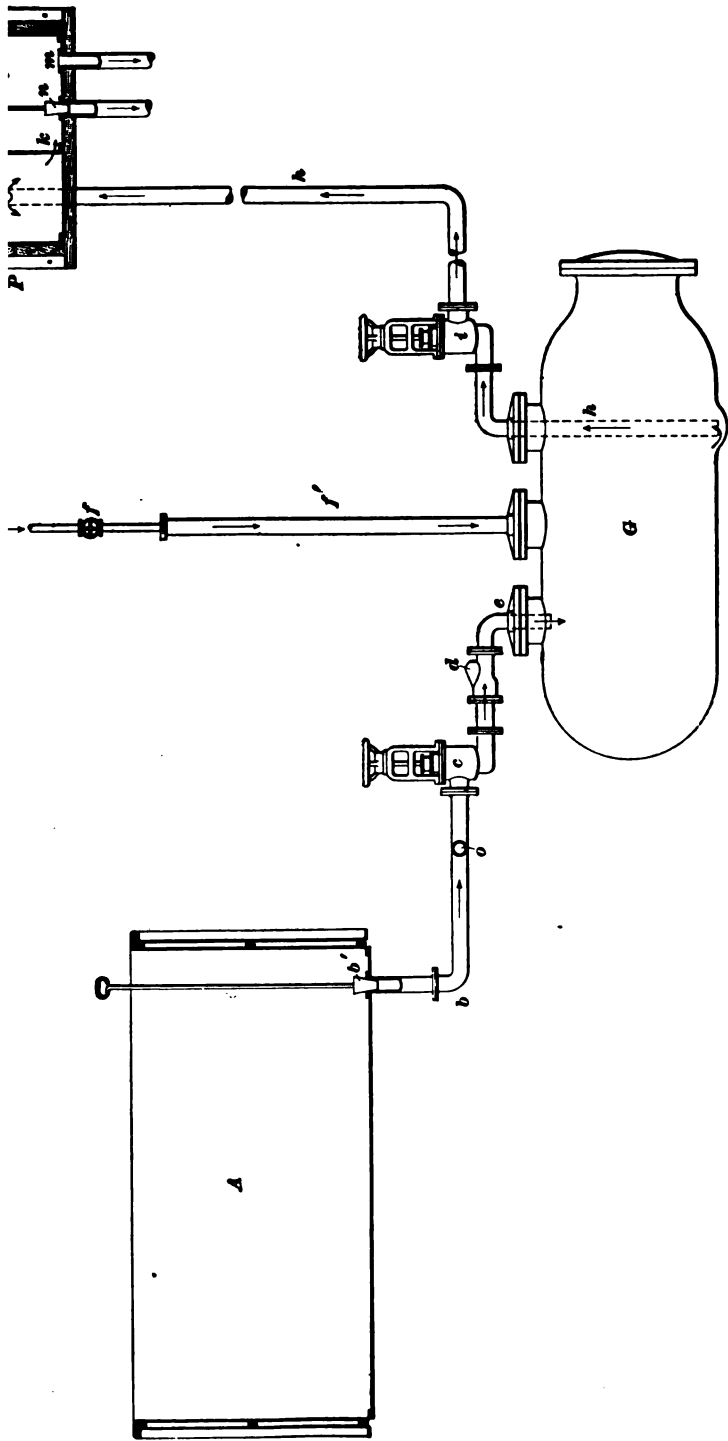

FIG. 14

by the globe valve *c*. The plug valve *b'* is merely auxiliary, and should not be relied on, as it can only with difficulty be made to withstand the back pressure. The check-valve *d* is used under ordinary circumstances. This valve permits the flow of acid into the egg until the acid rises to the level of the valve, which, when the compressed air is let into the egg, immediately seats itself and prevents the air from forcing the acid back into tank *A*.

Compressed air is admitted to the egg by means of the pipe *f'* and the valve *f*. The pipe *h* controlled by the valve *i* delivers the acid from the egg to the splash box *j* of the distributing tank *P*. When air is admitted to the egg, as it cannot pass valves *d* and *c*, and valve *i* being open, it forces the acid to a height of from 50 to 100 feet through *h* into the splash box *j*, which is a lead-lined box with two openings, through the lower of which the acid escapes into *j'*, an open part of the tank, and thence through the exit *m* into a receiving tank on top of the towers and an upper opening of large area, whereupon the air escapes into the atmosphere without splashing the acid over things. The exit *n* from *j'* into another receiving tank is provided in case the egg is used for pumping two kinds of acid, the plug being simply moved from *n* to *m* and a branch connection to a second supply tank being inserted at *o*, the flow of acid from either supply tank into the egg being then controlled by plugs *b'*.

OPERATION OF THE CHAMBER PROCESS

23. If the reactions involved in the chamber process have been understood, the importance of extreme regularity both as to volume and composition, of the supply of the substances entering into these reactions will appear obvious. For, although the process involving these reactions is a continuous one, and in fact more especially on this account, if loss is to be avoided and success attained, the supply of the necessary ingredients must be as exact as if the process were an isolated reaction involving the complete union

of carefully weighed proportions. The materials in question are: (1) A constant stream of burner gas of uniform volume and percentage of sulphur oxides and free oxygen. (2) A uniform supply of finely divided water or water vapor of constant tension. (3) A uniform supply or circulation of nitrous vitriol containing a constant percentage of nitrous oxide N_2O_2 . (4) A uniform supply of nitric oxide or acid for making good the oxides of nitrogen lost in the process (mechanically or otherwise).

It is only by careful watchfulness, honest work, and proper management, together with a rationally constructed plant, that a near approximation can be made to the requirements as to absolute uniformity called for. When, however, such approximation is reached, the difficulties of the chamber process disappear and the operation will proceed month after month with little, if any, variation, and with uniform results.

24. Conditions in the Glover Tower.—The burner-gas, having an average temperature of about 550° C., in passing from below through the Glover tower meets a finely divided stream of nitrous vitriol $2H_2SO_4 + N_2O_2$, greatly diluted with chamber acid or with water, or both, and often carrying with it nitric acid, sufficient to supply the loss inevitable in the process amounting from 1.5 to 3 per cent. (The consumption of oxides of nitrogen is always given in terms of percentages of sodium nitrate $NaNO_3$, calculated on the available sulphur burned.) This stream of mixed acids enters the top of the tower at from 40° to 50° Baumé, according to the degree of concentration and denitration required and the concentrating efficiency of the tower. The hot, moist, sulphurous gas drives off the nitrogen oxides in the upper part of the tower, and as it descends to the lower and hot zone, the water is expelled from the dilute acid as steam. The acid is thus concentrated to from 60° to 62° Baumé, or in special cases to 64° Baumé, or even to 66° Baumé and flows from the tower, while a stream of gas containing a mixture of oxides

of sulphur and nitrogen, steam, oxygen, and nitrogen, passes over to the first chambers.

25. Conditions in the Chambers.—The gas thus entering the first chamber contains all the elements necessary for the production of the hydrate or solution of sulphur trioxide and in a condition of maximum activity. At this point, the percentage of sulphur oxides is greatest, the free oxygen is in greatest excess, and the oxides of nitrogen NO and N_2O , are such as possess the most powerfully oxidizing effect. The temperature of the gas (80° to 100° C.) is also conducive to an active reaction. Therefore, it is at this zone of reaction that one would naturally look for a large make of acid, and such is actually the case, for between the Glover tower and the first forty feet of the first chamber, with all the elements and conditions of the process at their best, from 60 to 80 per cent. of the whole acid is made.

26. In a properly constructed plant, that is, a plant consisting of rightly proportioned Glover tower, chambers, and Gay-Lussac towers, a sufficient quantity of nitrogen oxides should be supplied to the gas by means of the Glover tower to raise the temperature of the reaction (as shown by the thermometers penetrating the sides of the chambers, say at a distance of 25 feet from the end that is nearest the Glover tower) to from 95° to 100° C. This, of course, does not apply to the oxides of nitrogen supplied to the system to replace the mechanical loss, but to the nitrogen oxides recovered at the end of the process and gradually accumulated as nitrous vitriol (nitrososulphuric acid dissolved in a large excess of 60° to 62° Baumé sulphuric hydrate or solution) and which is run over the Glover tower in dilute form to again utilize its contained oxides of nitrogen. The oxides of nitrogen so stored may be termed *niter in circulation*, and it is evident that, according to the quantity of this nitrous vitriol of uniform percentage contents of nitrogen oxides accumulated, put into circulation at the Glover and recovered at the Gay-Lussac towers, so will be the ratio

of active nitrogen oxides to the sulphur oxides at this critical initial point; i. e., the Glover tower and first part of the first chamber.

27. Provided always that the towers are properly proportioned to fulfil their functions of denitration and absorption (or recovery), it is desirable to accumulate and put into and keep in circulation about 20 per cent. of niter (by niter is meant oxides of nitrogen calculated as nitrate of soda $NaNO_3$, on the available sulphur burned). This will secure an active process at the beginning and a rapid oxidation of the gradually lessening percentage of oxides of sulphur after the first active zone has been passed, owing to the large excess of active oxides of nitrogen in the chamber gas, and, consequently, a rapid change of these oxides of nitrogen to nitrous oxide N_2O , in which form it is capable of being at once absorbed in the Gay-Lussac tower. This will, on the other hand, prevent the process becoming sluggish and slow, with the consequent danger of sulphur dioxide escaping into the Gay-Lussac tower unoxidized, where it will decompose and so prevent the complete absorption of the nitrous oxide by the sulphuric acid, which takes place according to the following equations:

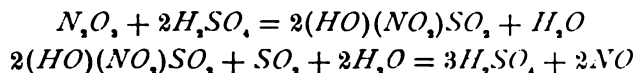

The oxide NO will not be absorbed, but passes with the inert nitrogen into the atmosphere. It will also avoid (by at once absorbing from the process) the danger of the N_2O , being changed to NO , or even to nitric acid HNO_3 , when in the first case it would be lost as stated above, or in the second case it would not only be lost but would rapidly destroy the lead of the apparatus and contaminate the acid made.

28. After the first 40 or 50 feet of travel of the gas in the first chamber, the temperature indicated by the side thermometers will rapidly diminish. This would naturally be expected as the reactions become less intense, on account of

the lesser proportion of sulphur dioxide contained in the gas, and also its greater diffusion in the chamber and its saturation with a mist of already formed sulphuric hydrate. The length of the active zone, of course, varies according to the volume of burner gas passed into a chamber of any given size, and also to the intensity of the first reactions, depending on the proportion of nitrous vitriol kept in circulation; but sooner or later, and generally within the first 60 feet, the reactions, as indicated by the thermometers, will become sluggish and will so continue until the gases have been thoroughly mixed and the various elements brought into more intimate contact by passing them through a pipe connection and in their mixed condition allowing them to again expand in a second lead chamber. For this reason, it is now usual in the United States to limit the length of the first chamber to from 50 to 75 feet.

29. Where a positive method of controlling the currents of a gas (such as the use of fans, etc.) exists, it is preferable, in the case of large volumes of burner gas being handled, to divide the gas between two or more first chambers of limited length, so as to secure a large zone of great activity rather than an extended zone of rapidly diminishing activity or sluggish reaction.

The condition of the gases at the end of the first chamber, or after the zone of great activity, is such as to call not only for a thorough mixing but also for a cooling and a condensing of the mist of acid already formed. Radiation of heat from the surface of the chambers, while very considerable, is not sufficient by itself to conduct away the heat of the active zone so as to secure the best results. The towers, surface-, air-, and water-cooled condensers and plate columns employed have already been described. These apparatus, by bringing the gases again into intimate contact, also undoubtedly start the reactions into renewed activity.

30. The second chamber in a properly proportioned set and with sufficient nitrous vitriol in circulation (in other

words, with a sufficiently active process) will almost entirely oxidize the remaining sulphur dioxide, so that with or without further surface condensers between the second and the third chamber, the oxidation will be completed at once on entry into the third chamber, which then acts merely to dry and cool the gas, now consisting of inert nitrogen, the excess of oxygen, and nitrous oxide, and render it fit for absorption in the Gay-Lussac towers. For cooling and drying the gas, a long pipe connection between the last chamber and the Gay-Lussac tower is of great advantage; it can, however, be replaced by a surface condenser of any of the types previously mentioned.

In this description of the passage of the gas through the sulphuric-acid plant, it must be remembered that while the gas enters the chambers containing a large proportion of water vapor derived from the concentration or evaporation of the dilute acid supplied to the Glover tower, this water is rapidly absorbed by the formation of the sulphuric hydrate and precipitated to the pans of the chambers.

More water, either as finely divided spray or as steam, must be added. Steam is the usual medium employed, either low-pressure steam (20 pounds per square inch) or exhaust steam from a neighboring engine, or both.

31. Admission of Steam to the Chambers.—It is well to have sufficient points of admission for the steam, either on the top or sides of the chambers, each point being supplied with an indicating valve, so that the steam may ultimately be supplied just at such points and in such quantities as experience may show to be the best in each individual case, and under varying conditions of conducting the process. Just as it is with the burner gas and the supply of nitrogen oxides, so must the flow of steam to the process be in every respect uniform. To secure this, the steam pipes must be well covered and trapped and the main line supplying steam to the branches must be supplied with steam gauges and an efficient reducing valve, which must be constantly watched and kept in order. The arrangement of

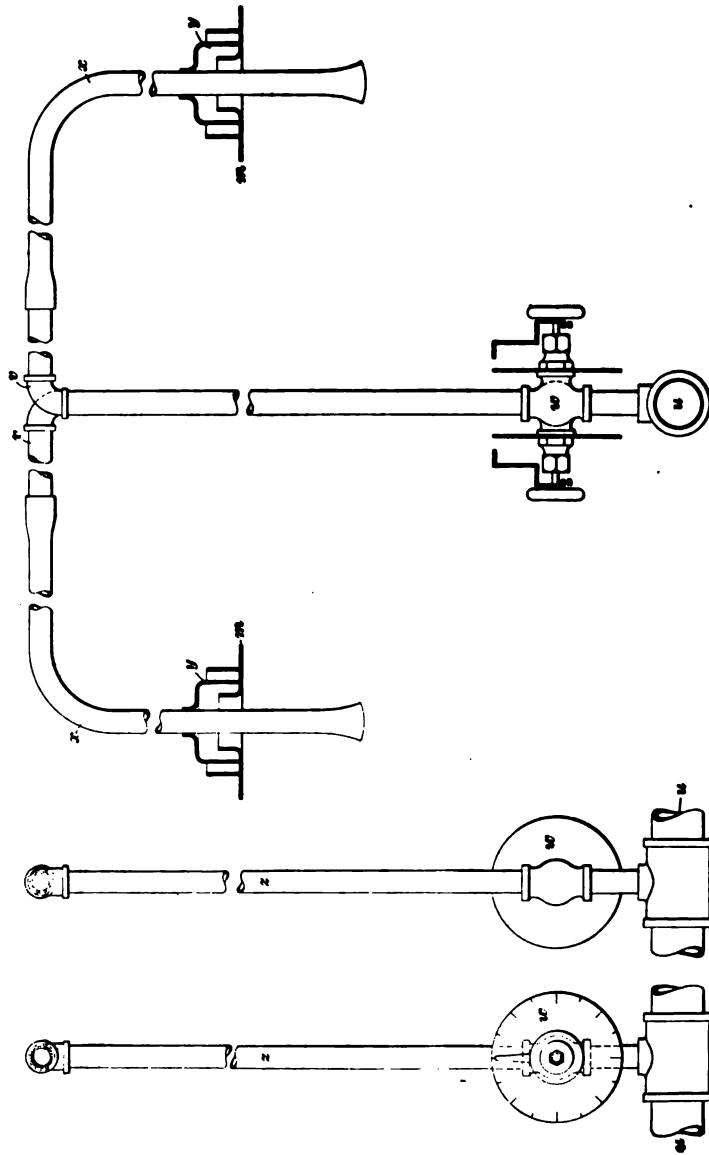

FIG. 15

the steam-pipe connections is shown in Fig. 15. The main supply pipe *u* is laid between the chambers, the vertical pipe *z* extending from it to the top and having branches *v* to the chambers right and left. The lead terminal pipes *x* enter the chambers by means of the hydraulic lutes *y*, which are ordinary water seals. At *m* is the top lead of the chamber. The indicating valves *w* serve to regulate the flow of steam to the chambers. If steam is admitted to the sides of the chambers, the lead terminal pipes enter the side leads or curtains through specially constructed stuffing-boxes.

With uniformity in the supply of gas, nitrogen oxides, and steam, and a draft subject to proper control once started, the chamber process becomes continuous and simply requires careful watching to maintain the regularity of the conditions. A careless burner man, by admitting too much air to the furnaces and thus reducing the percentage of sulphur dioxide in the burner gas, or a careless tower man in sending an irregular flow of nitrous vitriol over his Glover, will very quickly destroy the harmony of the reactions and too quickly disarrange the process to such an extent that first the supply of nitrogen oxides in circulation and then the sulphur dioxide itself will be pouring out into the atmosphere and the process will have resolved itself into the same, or almost the same, conditions, the acid maker has to confront when "starting up his chambers" or, in other words, at the beginning of everything.

32. Starting the Chamber Process.—This part of the operation requires the exercise of care and judgment, and it will take from 24 hours, where fans are used, to three or four times as long before the process is normal. The Glover tower, with its massive packing, absorbs much heat, and it will take considerable time for it to reach a temperature at which it will perform its double functions of denitration and concentration in a satisfactory manner, more especially as the acid that must be run into it from above has a constant cooling effect. At the same time, the Gay-Lussac

towers become saturated with sulphur dioxide, which prevents the proper absorption of the nitrous oxide, and the formation, consequently, of a stock of nitrous vitriol for the Glover tower. These difficulties, of course, are exaggerated where no stock of 60° to 62° Baumé acid or of nitrous vitriol is on hand, and where the process has to be started with a supply of chamber acid alone (or even of water), as is generally the case in an isolated chamber system.

When such is the case, the chamber pans must be filled with sufficient acid of from 50° to 54° Baumé to form a hydraulic lute with the curtains or side and end sheets of the chamber lead.

A small quantity of acid must be run down the Glover tower until the packing is thoroughly moistened, and the Gay-Lussac towers should also be supplied with acid. Whether nitrogen oxides are to be supplied by "potting," or by the direct use of nitric acid on the Glover tower, arrangements must be made that will enable an abnormal amount to be used until such time as the towers are working properly and the stock of nitrous vitriol for circulation is secured. It will be advisable, at first, to supply an amount of nitrogen oxides equal to at least 8 or 10 per cent. of sodium nitrate, on the available sulphur.

The burner gas is then turned into the Glover tower and the chamber system. At first and until the Glover tower is performing its functions properly, it will be necessary to supply steam to the first part of the first chamber. This, however, will have to be done with extreme caution, as too great an excess of water is likely to cause the formation of nitric acid HNO_3 , which will cause the rapid deterioration of the chamber lead.

33. As the Glover tower gets hotter it will concentrate the limited amount of acid with which it is supplied, to about 60° Baumé, and the quantity of acid can then be gradually increased. This stronger acid is at once supplied

to the Gay-Lussac towers, which will then commence to absorb a little nitrous oxide; with patience and watchful care matters will gradually assume a normal condition. A sufficient stock of nitrous vitriol having been accumulated, and the steam admission, pumping arrangements, and the flow of acid over the various towers regulated, the extra niter supply will be reduced to a point where it is just sufficient to supply the daily loss and maintain the circulating supply of nitrous vitriol intact. The acid concentrated by the Glover tower should test 62° Baumé at 60° F. (66.4-per-cent. SO_3). Such part of it as is intended to be run over the Gay-Lussac towers should be run from the Glover tower into a cooler and cooled as thoroughly as the temperature of the cooling water will allow. It is then pumped to the supply tank on the second Gay-Lussac tower, where it meets with the gas just leaving the system and poorest in N_2O . It will run from this tower containing varying percentages of nitrososulphuric acid, and is known as the first, or weak nitrous vitriol. It is then pumped to the first Gay-Lussac tower, or the tower nearest to the last chamber, where it meets the gas strongest with N_2O . Sufficient acid should be supplied to these towers to permit a nitrous vitriol containing 2.5 to 3 per cent. of N_2O , to run from this first tower. This second, or nitrous vitriol, proper, is then passed to the stock tanks for nitrous vitriol, an exactly equal amount, both in quantity and percentage of N_2O , being taken from the stock tanks and pumped to the top of the Glover tower and run down the tower together with a sufficient stream of weak sulphuric acid to dilute it sufficiently to secure denitration and also to secure its concentration in the Glover tower to 62° Baumé.

34. All well-equipped plants are now being built with two Gay-Lussac towers, both because in this way it is possible to secure sufficient cubic capacity without undue height or diameter, and because if, for any reason, the process becomes irregular ("goes back") and sulphur dioxide gets into the first tower, decomposing the nitrous vitriol,

then the second tower will still absorb and to a considerable extent take up the work which the first tower is doing badly, the first tower, in the meantime, assuming the functions which should have been performed by the last chamber. In this way, time is secured to find out just where the trouble is and remedy it before much harm is done. If, however, the trouble is not found and remedied, the sulphur dioxide will gradually get into the second tower and the process will be "lost," or in other words, with the exception that the Glover tower is hot, the acid maker will have to proceed as in starting up the system.

35. It must be borne in mind, and too great emphasis cannot be given to the statement, that when the chamber process begins to go wrong, *it is on account of a break in the uniformity of the supply of the various elements.* - Either the burner gas is richer or poorer in sulphur dioxide, the nitrous vitriol is poorer in nitrous oxide on account of the acid supplied by the Glover tower being weaker than 62° Baumé, or too much or too little steam or higher or lower pressure steam is being supplied. When such irregularity is noticed, the acid maker must at once increase the flow of nitrous vitriol from his stock over the Glover tower. He will then immediately test his burner gas, nitrous vitriol, steam, etc. until he finds where the irregularity is occurring. This remedied in time, the process will rapidly become normal again and the increased supply of nitrous vitriol may be cut off gradually, in the meantime more 62° Baumé acid being run over the Gay-Lussac towers so as to recover as far as possible the nitrous vitriol temporarily taken from stock.

As the activity of the chemical reactions going on in the chambers is proportional to the heat produced by them, it is plain that in a regular normal process the temperature at the most active and least active zones will bear a constant ratio to one another, so long as the process is regular; this fact affords a very delicate indicator of the regularity of the process.

36. If a chamber thermometer, placed in the side of the first chamber about 20 feet from the entrance of the gas from the Glover tower, that is, in the zone of greatest activity, registers 100° C., and a thermometer placed in the side of the second chamber, or a zone of lesser activity, registers 70° C., *when the process is at its best and working with absolute regularity*, the difference between the two readings represents the relation between the greatest and lesser activity of that process when normal. If these temperatures vary so as to disturb *this difference of 30° C. so little as 1° C.*, it is time for the acid maker to investigate his process and find out what is wrong. This will often enable him to save serious disturbance in his process before it has manifested itself in any other way. It must be noted that it is a disturbance of the difference or ratio, however, and not of the actual temperatures. The zones of most and least active reaction ebb and flow slightly in the chambers so that the actual readings of the thermometers may both be a degree or two higher or lower at various times of the day and especially at various seasons of the year.

In addition to the temperature readings, the manometer also affords a delicate test. Manometers registering the tension of the contents of the first and last chambers will show a constant *difference* of pressure when the process is regular and constant; such *difference* once determined when the process is at its best will be maintained so long as normal conditions prevail.

As a guide to the proper supply of steam at various zones of the process, drip pans are placed on the sides of the chambers, which enable a sample of the acid forming on the sides of the chambers to be taken and tested with the hydrometer and otherwise examined. This acid, being taken from the cool sides of the chambers, contains more water than the average of the acid being formed in the chamber. This difference is about 3° Baumé. A curtain or side drip reading of 50° Baumé would, therefore, represent approximately an average formation of 53° Baumé acid *in that portion of the chamber*.



37. Curtain Drip.—For taking these samples the device shown in Fig. 16 is employed. To the curtain or side lead

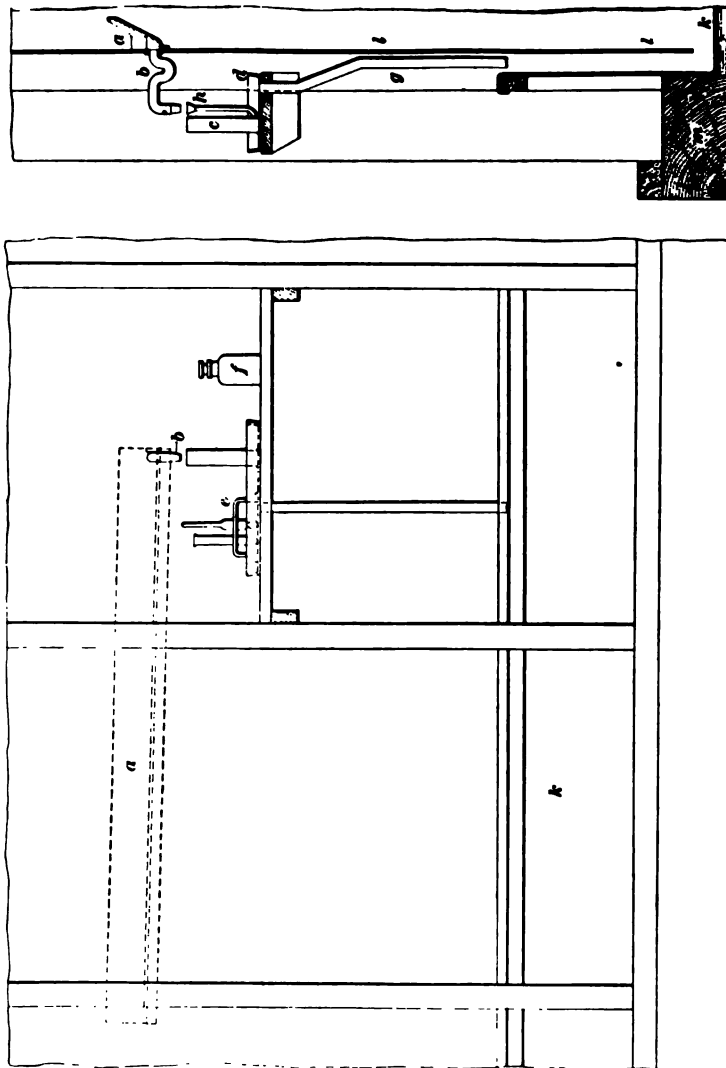

is attached an inclined lead trough *a* about 4 feet long. At its lower end is attached the pipe *b*, which passes through the

curtain *l*, and is bent so as to form a lute or seal. Acid caught in the trough *a* runs through the pipe *b* and drips into the funnel *h*, communicating with the hydrometer jar *c*. This jar, together with a rack for the hydrometer, etc., stands in a lead tray *d* from whose bottom the drip pipe *g* leads to the chamber pan *k*. As acid is constantly dripping into *h* and overflowing from *c*, the acid in *c* varies according to that forming in the chamber, and hence tests of this give a fair indication of the condition of affairs in the chamber at that point.

Different acid makers prefer to keep the drips of the different chambers stronger or weaker. This is within certain limits immaterial. The acid in the first chamber, in spite of the large amount of water supplied by the Glover tower, will rarely fall below 52° Baumé. The acid formed in the chambers should, however, never be allowed to get strong enough to absorb and retain more nitrous anhydride than is absolutely inevitable, especially in so far as such chambers are concerned from which acid is withdrawn from the system. This strength will also be about 52° Baumé, and the tendency to absorb nitrogen oxide will increase with every degree Baumé above this point. Nor, on the other hand, must the acid get so weak as to permit the formation of nitric acid in the chambers. This strength will be about 45° Baumé. Therefore, the acid formed in the chambers must in no case be weaker than 44° or 45° Baumé, nor should it be much, if any, stronger than 52° Baumé.

Although the drips are highly useful adjuncts in controlling the chamber process, samples of the bottom acid should also be taken at intervals, and in each individual chamber the acid maker must learn in this way to compare the actual strength of the acid formed in the chambers as he finds it with the strength of the acid as shown by his drip tests. Such tests of the bottom acid are most satisfactory when taken from a tank that has been filled with acid drawn off from the chamber.

THE PURIFICATION OF CHAMBER ACID

38. General Remarks.—In addition to the impurities brought into the process with the burner gas, as was previously mentioned, some of which will not travel beyond the Glover tower, chamber acid will contain sulphates of lead derived from the slow deterioration of the lead apparatus, and also small quantities of nitrogen oxides and even nitric acid. From a commercial standpoint, the impurities that are most injurious are the arsenic and selenium compounds and even distillation will not entirely eliminate these, unless special precautions are taken. They will pass over into the products made from acid contaminated with them (for example, into muriatic acid and calcined salt cake made from salt and arsenical sulphuric hydrate). If acid contaminated with arsenic or selenium is used for “pickling” sheet iron or wire, preparatory to galvanizing or covering the sheets with zinc, tin, or lead, the galvanic action set up in the dilute acid bath will cause the arsenic or selenium to precipitate and become deposited on the iron sheets, which will prevent the adhesion of the zinc, tin, or lead, and result in “blistered” sheets.

39. Most other impurities, especially lead or iron sulphates, will separate in the tanks by sedimentation, or, at the worst, will produce a discoloration of the acid that does not unfit the acid for most commercial purposes. Fortunately, very few of the metallic sulphides contain selenium except in minute traces. Practically all the metallic sulphides contain arsenic, and many of these best adapted otherwise for sulphuric-acid manufacture contain it in considerable quantity. Arsenic, therefore, is the principal impurity of chamber acid, and on account of its poisonous characteristics, it becomes especially necessary to eliminate it. When sulphuric hydrate is used for refining crude petroleum, or for the manufacture of mixed acid for making nitroglycerin, arsenic is not detrimental, or at least the manufacturers do not object to arsenical acids. The arsenic contained in the enormous quantities of sulphuric hydrate

used in the manufacture of superphosphates and fertilizers may even be of advantage in destroying insects, etc.; but for other purposes, and especially for processes connected with the manufacture of food products, its elimination becomes absolutely necessary. If the manufacturer is not prepared to thoroughly purify his product from arsenic and intends it for the general market, or for galvanizing, food products, or other similar purposes, then he must limit his choice of raw material, often to his great disadvantage as to cost, to such raw materials as are practically free from arsenic (as brimstone, some few of the iron bisulphides, etc.). If his ores contain only a little arsenic, he can sometimes obtain a fairly pure acid from the second chamber, using the acid produced in the Glover tower and first chamber for purposes less exacting of purity; this, however, is a dangerous makeshift.

40. Purification From Arsenic.—As all methods for the purification of acid from arsenic are based on its precipitation and ultimate removal by sedimentation, it is evident that this operation must take place when the acid is of least density; in other words, while it is still chamber acid (50° to 52° Baumé) and before further concentration.

This statement must, however, be qualified in regard to such manufacturers of 66° Baumé and extra-concentrated acid who are equipped to manufacture such acids by distillation, as will be hereafter described.

In many metallurgical plants, where the acid is a by-product and the principal value is in the metallic contents of the metallic sulphides, and in cases where the cheapness or other advantages outweigh the disadvantage of considerable arsenical contents in the raw material, the *whole output* must be treated for the elimination of the arsenic.

41. Freiberg Process for Removing Arsenic.—Where this is necessary, the only practical process is a modification of what is known as the **Freiberg process**. This process depends on the conversion of arsenious oxide into arsenious

sulphide by means of sulphureted hydrogen gas, the precipitation taking place according to the following equation: $As_2O_3 + 3H_2S = As_2S_3 + 3H_2O$. As sulphureted hydrogen will decompose strong sulphuric acid as follows, $3H_2S + H_2SO_4 = 4H_2O + 2S$, it is better to purify the acid as little over 50° Baumé as possible. By this process it is stated that at Freiberg, acid containing as high as .14 per cent. of arsenic can be purified until it contains only .0002 per cent. of arsenious oxide As_2O_3 .

42. In chemical works, where sulphate of ammonia is prepared from the *gas liquor* of illuminating gas works, the sulphureted hydrogen is a troublesome by-product, but can be made readily available for purifying the acid in the Freiberg process. It contains, however, some pyridine bases that must first be eliminated if acid of good color is required. If this source of sulphureted hydrogen is not available, then it must be prepared by treating iron sulphide with dilute sulphuric hydrate $FeS + H_2SO_4 = FeSO_4 + H_2S$. The iron sulphide may be prepared in a simple little furnace by heating scrap iron or rails with brimstone. On the large scale, however, it can be very cheaply produced in a cupola furnace by smelting pyrites fines or inferior pyrites with silicious slag.

The iron sulphide so produced is broken into rather large pieces and filled into a generator, where it is treated with any available dilute sulphuric acid, such as is often produced about an acid works from the washings of tanks, tank cars, etc., and too dirty for general commercial purposes. These generators are all made on the same general plan (practically that of Kipp's apparatus, but they are constructed out of lead, wood, and iron, and are often made large enough to hold a charge of iron sulphide sufficient to last several weeks.

43. Freiberg Sulphureted Hydrogen Generator.—A simple and efficient generator for sulphureted hydrogen is shown in Fig. 17. It consists of a cast-iron generator *A* with flanged top and manhole *b* and an acid reservoir *c*. This

generator, as well as reservoir *c*, is lined with lead. The generator is partially filled with iron sulphide *d* through the manhole *b* and the tank with weak sulphuric acid. The acid will then flow from the reservoir *c* to the generator *A*, and on coming in contact with the iron sulphide will form sulphureted hydrogen. The valve *e* and pipe are for carrying away the hydrogen sulphide; when the valve *e* is open, the hydrogen sulphide passes constantly away; when *e* is

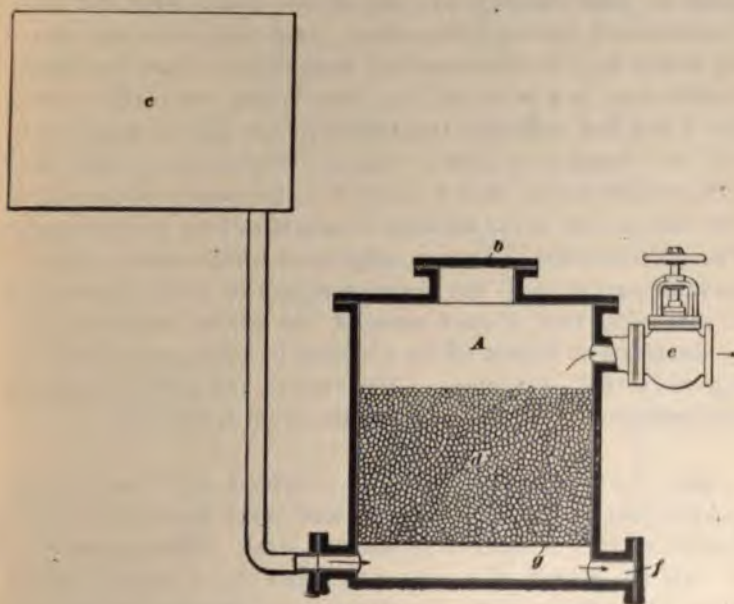

FIG. 17

closed, the pressure in *A* rises until the acid is driven back into the tank *c*, and the evolution of hydrogen sulphide practically ceases. The weight of the acid in reservoir *c* being carried by the pressure in *A*, upon opening the valve *e* the acid again flows into *A* and generation of gas recommences. A cleaning vent is provided at *f*, from which the iron sulphate can be removed when the acid is spent—i. e., entirely converted into iron sulphate—and *g* is a screen of perforated lead.

44. Precipitation of the Arsenic.—The chamber acid is then run by gravity into a series of gas-tight lead-lined boxes or tanks. Each box in the series is provided with a perforated coil of pipe in the bottom connecting on the outside with the main supply pipe for sulphureted hydrogen and a valve controlling the admission of the gas; it is also connected at the top by means of pipes and valves with every other box in the series, in such a way that the gas may be made to pass through any one of the boxes first and then consecutively through the others; and, also, that any one of the boxes may be disconnected temporarily from the series. In this way, in a series of, say, four boxes, when the acid in box 1 has had sufficient treatment by the gas, it may be cut out and boxes 2, 3, and 4 remain. When box 2 has been treated sufficiently, then boxes 1, 3, and 4 remain in operation. The box so cut out is allowed to settle as long as necessary. The precipitation of arsenic sulphide has then taken place to such an extent that the upper stratum of acid, amounting to three-quarters or even more of the whole contents, may be decanted or drawn off by a siphon in a pure state, requiring no further treatment. The rest of the acid containing the precipitated arsenious sulphide must be filtered.

45. Each series of boxes is provided with two simple gravity filters, which consist of lead-lined boxes filled with broken quartz or sand of graduated sizes. The impure acid is run by means of a pipe and valve on to one of these filter beds, from which it will emerge practically free from arsenic. When one filter becomes foul the other filter is put into commission and the foul one cleansed by the removal of the arsenious sulphide from its surface.

The exit gas pipe from the last box of any one or more series of boxes enters the bottom of the tower shown in the construction. Just sufficient acid is run into this tower to prevent the escape of any sulphureted hydrogen that has not been absorbed in the boxes. The apparatus for the precipitation and filtration of the arsenic sulphide, together with all pipe connections, is illustrated in Fig. 18 (*a*) and (*b*).

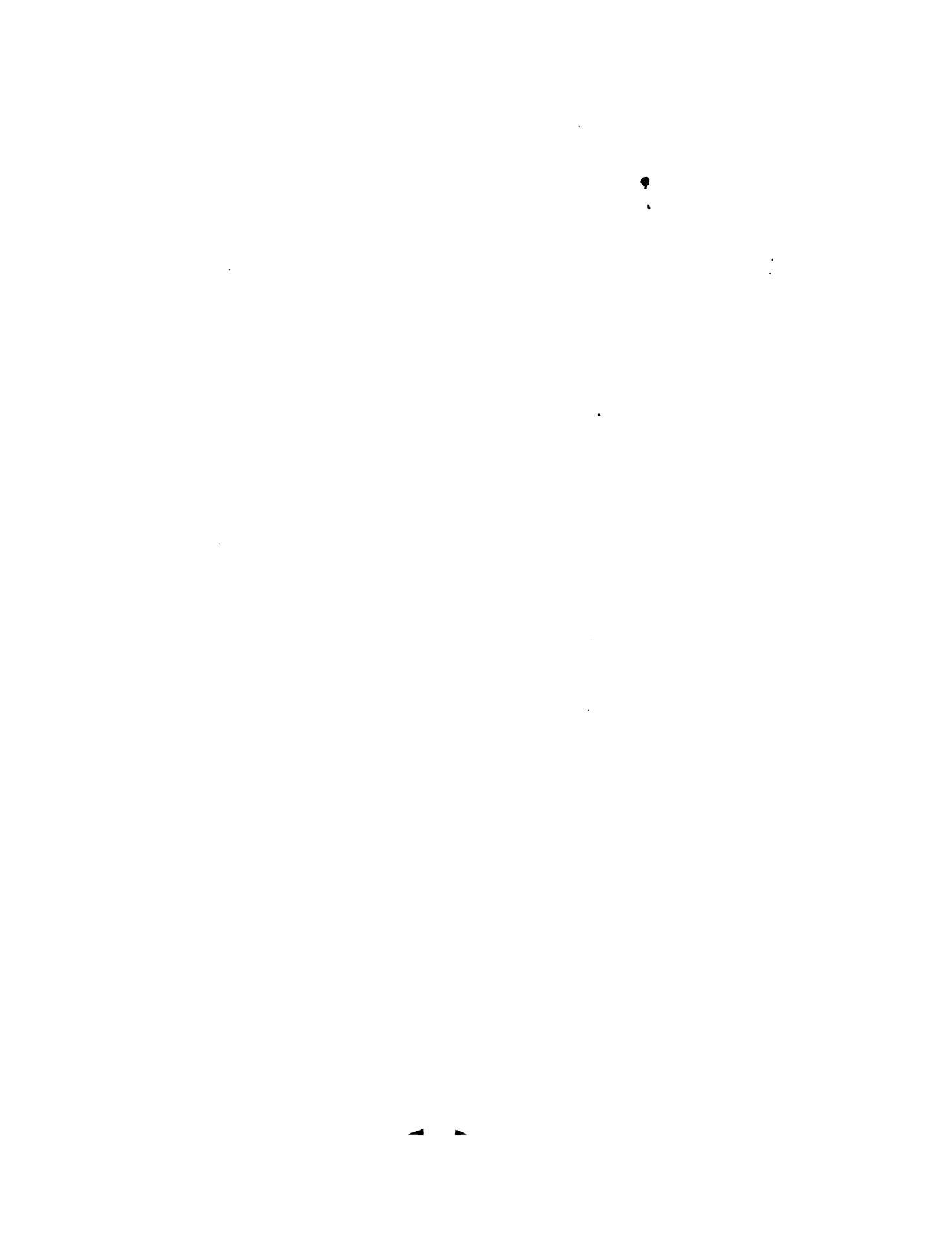

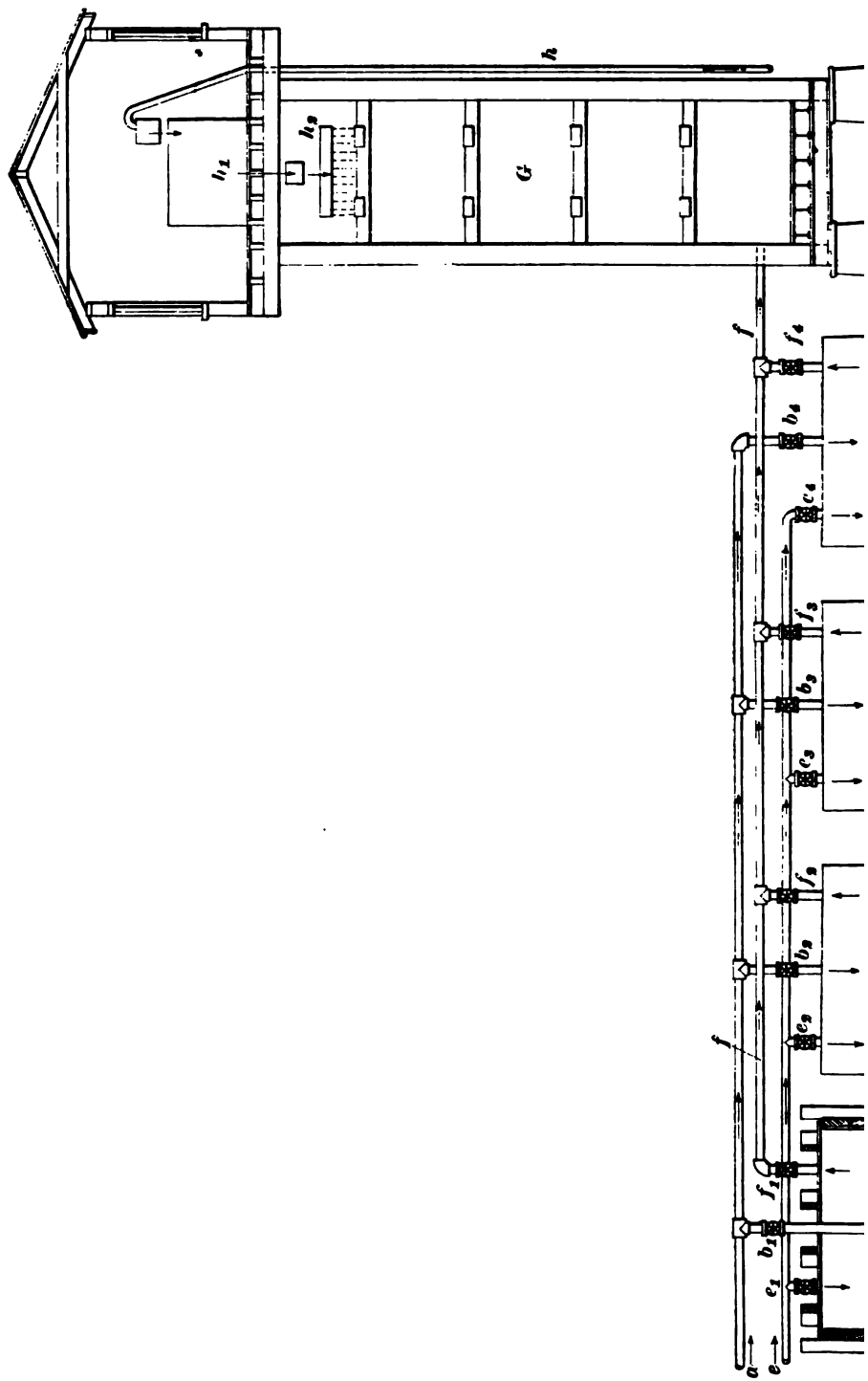

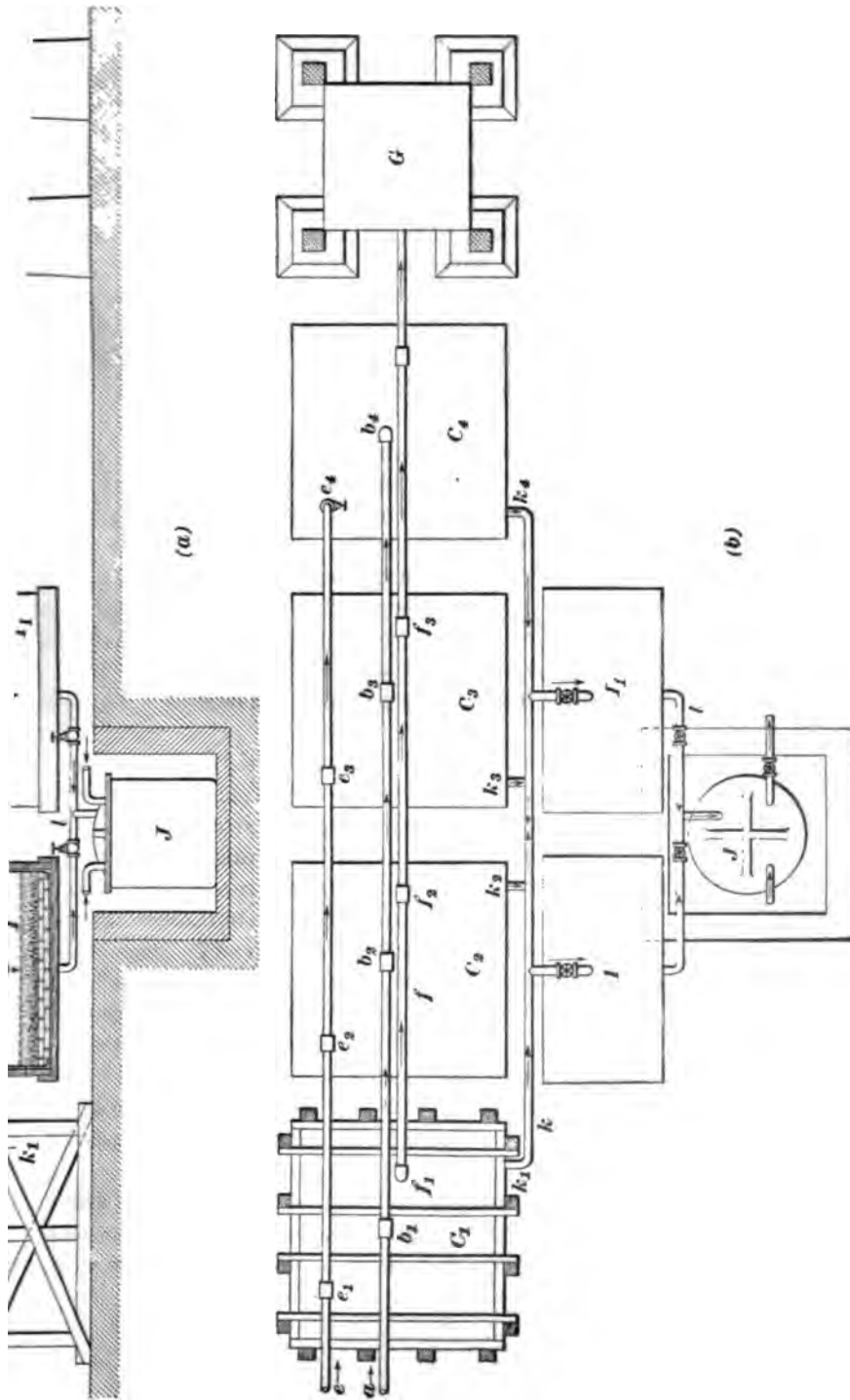

FIG. 18

The main pipe *a* brings sulphureted hydrogen from the generator shown in Fig. 17. The branches and valves *b*₁, *b*₂, *b*₃, and *b*₄ communicate with the gas-tight, lead-lined boxes *C*₁, *C*₂, *C*₃, and *C*₄, and the perforated coils *d*₁, etc.

The acid pipe line *e* is for filling the boxes *C*₁, *C*₂, *C*₃, and *C*₄ with chamber acid by gravity, fitted with branches and valves *e*₁, *e*₂, *e*₃, and *e*₄.

The return gas pipe *f* collects the hydrogen sulphide remaining after it has percolated through the acid in the boxes and conveys it to tower *G*. It is fitted with branches and valves *f*₁, *f*₂, *f*₃, and *f*₄.

The tower *G* is packed in various ways, and a stream of weak arsenical acid runs down through it, meeting the weak hydrogen sulphide not taken up by the arsenical acid in boxes *C*₁, *C*₂, *C*₃, and *C*₄. This stream must be regulated to completely utilize the hydrogen sulphide and prevent its loss into the atmosphere. The tower is fitted with acid supply line *h*, tank *h*₁, and distributor *h*₂.

The filters *I* and *I*₁ are used alternately. A blow case or acid egg *J* is used for pumping the purified acid to the storage tanks.

After a box is sufficiently treated with hydrogen sulphide the gas valve is closed and the manhole opened. The box is then allowed to stand for from 12 to 24 hours, when the arsenic sulphide will be found to have settled to such an extent that about three-fourths of the contents of the box may be decanted off by means of a siphon and passed direct to storage. The remaining quarter is drawn through pipe *k* and branches *k*₁, *k*₂, *k*₃, and *k*₄ into whichever one of the filters happens to be in commission. This filter strains out the arsenic sulphide, permitting the purified acid to run through pipe *l* into the pumping apparatus, whence it also passes to storage. The tank is then again filled with acid and another tank cut out for treatment.

46. Stahl Method for Removing Arsenic.—For the purification from arsenic of comparatively small quantities of acid, Doctor Stahl's method is very satisfactory. The

acid is diluted to 40° or 42° Baumé heated to 80° C., and a solution of barium sulphide of 8.3° Baumé is run in at the bottom of the vessel in such a way that no hydrogen sulphide escapes. The arsenic trisulphide is filtered off on a sand bed placed on a layer of quartz lumps, and in this way the arsenic will be reduced to .01 per cent., but as the acid on standing in the filter again takes up a little arsenic, it is treated with gaseous hydrogen sulphide and is thus reduced to .005 per cent. arsenic.

Arsenic may also be precipitated as a sulphide by means of the sulphides of sodium, calcium, iron, and ammonium, and by sodium and barium thiosulphates, but for most purposes these substances are objectionable either on the ground of cost or because they leave objectionable impurities dissolved in the acid treated.

CONCENTRATION OF DILUTE ACID SOLUTIONS AND THE PRODUCTION OF SULPHURIC MONOHYDRATE

47. The acid solutions resulting from the reactions of the chamber process consist (1) of chamber acid averaging about 50° Baumé, rarely over 52° to 54° Baumé, and often diluted for purpose of purification as low as 40° Baumé; (2) of acid concentrated to 60° to 62° Baumé by the heat of the burner gas in the Glover tower.

The concentration of these two products varies materially and must be separately considered.

48. Concentration In Lead Pans.—The first concentration of the dilute chamber-acid solutions, varying from 40° to 54° Baumé, which come under the first class above, is always effected in shallow lead pans. Concentration in lead can only be made to 60° Baumé or slightly over, as the lead pans are rapidly acted on by hot acid of greater strength. The evaporation is carried on in these pans by means of (a) waste heat; (b) direct heat applied either (c) above or (d) below the pans, derived from coal, coke, natural or producer gas, oil or petroleum, tar, or applied as steam.

Practically, except in special cases, steam is not found satisfactory and the benches used are of two varieties, viz., those in which the heat is passed over and those in which the heat is passed under the pans.

Pans used to be placed over the brimstone burners, utilizing the heat of combustion. When pyrites began to take the place of brimstone, the pans were still placed above the burners. This practice is now almost entirely done away with, partly because of the large amount of dust involved by the use of pyrites and partly because of the trouble caused by leaks from the pans saturating the costly masonry of the furnaces with acid and of the difficulty of repairs to the pans when so placed, but principally because the introduction of the Glover tower utilizes the waste heat of the furnaces to much better advantage. Fig. 19 includes a pan bench arranged to be fired from below.

The dilute solution flows continuously through the pan bench in quantity to insure its leaving the bench a uniform density of about 60° Baumé. This acid must now be further concentrated, either in glass, porcelain, or platinum. After the acid reaches a strength of 64.5° Baumé, it may be further and finally concentrated in iron stills or the final concentration may be made in glass or platinum. Below this strength (64° to 65° Baumé) it acts too strongly on the iron. The concentration in porcelain cannot be carried beyond about 65.5° Baumé.

49. Concentration in Platinum, or Partly in Platinum and Partly in Iron.—In Fig. 19 is shown a bench of platinum pans or stills *i*, *o*, and *q*, also the bench of lead pans *e*, *f*, and *g*, in which the preliminary concentration is made.

Platinum stills of circular or oblong shape with rounded corners are made of many different patterns; some are provided with platinum covers; some have water-cooled leaden covers or hoods, as in Fig. 19. The principle, however, is the same in all; they are practically evaporating kettles for continuous service, provided with an inlet and

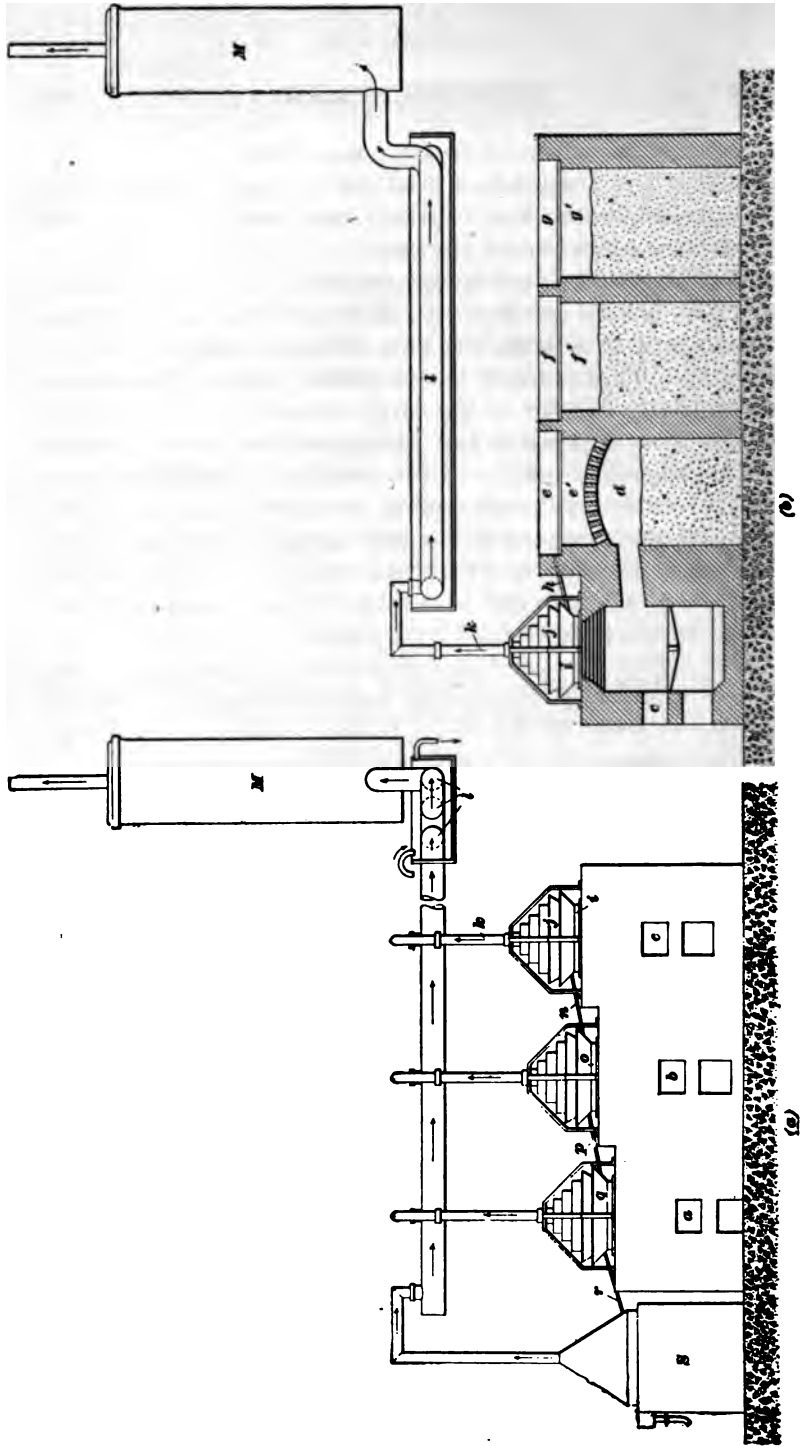

FIG. 10

exit for the stream of acid and with means for eliminating and condensing the steam or weak distillate. During the gentle evaporation of these dilute hydrates in the lead pans, little but water, in the shape of steam, is driven off; after the solution reaches a density of 60° Baumé, more and more of the hydrate is driven off with the water; when the solution reaches a density of 66° Baumé (93.5-per-cent. H_2SO_4), the distillate will attain a density as high as 60° Baumé (77.6-per-cent. H_2SO_4). When the solution in the pans contains in the neighborhood of from 95- to 98-per-cent. H_2SO_4 , the distillate will have a density of 66° Baumé (93.5-per-cent. H_2SO_4). Much of this distillate is too weak for a reconcentration. It is sometimes run into the drain, but should be used for diluting the nitrous vitriol on the Glover tower. The apparatus shown in Fig. 19 (*a*) and (*b*) is continuous in its operation.

The fireplaces *a*, *b*, and *c* communicate with the common flue *d*. This flue at one end is arched over with "pigeon-hole" or open brickwork, permitting the fire gas to pass into *e'*, under and from end to end of a lead pan *e*. The heated gas returns under lead pan *f* through flue *f'*, and then passes through flue *g'* under lead pan *g* to the stack.

Chamber acid is run into lead pan *g*, whence it flows to pan *f* and thence to *e*, from which it passes by platinum pipe *h* to platinum dish *i*, covered by a lead water-cooled hood *j*. The steam and acid vapors escape by pipe *k* into water-cooled condenser *l* and thence into the small condensing tower *M*. Acid then flows from platinum dish *i* by platinum tube *n* into platinum dish *o*, provided with water-cooled lead hood and exit to condenser. From platinum dish *o* the acid passes through platinum pipe *p* into platinum dish *q*, also provided with hood and exit to condenser. As the acid leaving *o* will have reached a strength of from 64.5° to 65° Baumé, an iron dish is often substituted for platinum dish *q*. The acid then runs through platinum pipe *r* into cooler *S*, and thence to storage.

50. Concentration in Iron.—Different manufacturers have different views as to the material best suited to this

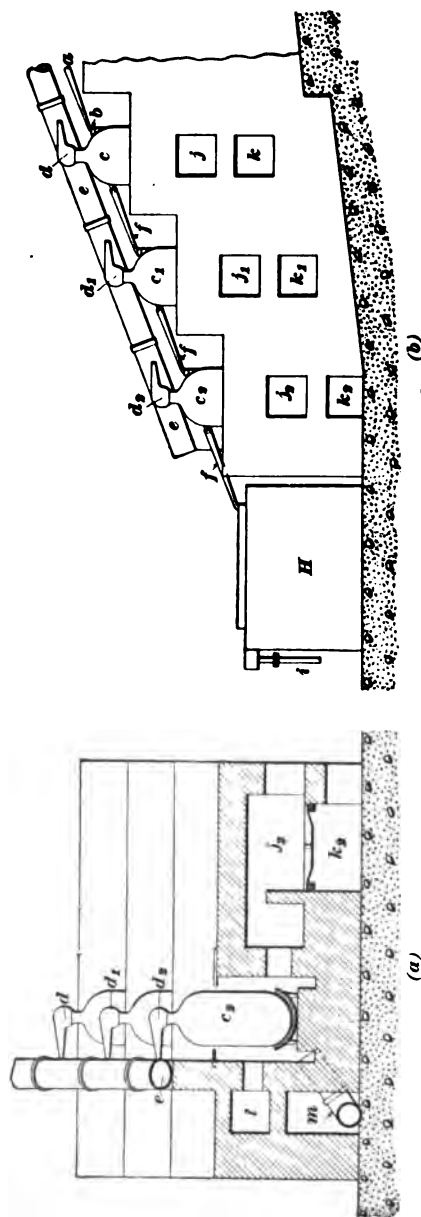

FIG. 20

final concentration. Iron, if properly cast and of suitable composition, is but little acted on by acid of 64.5° Baumé, and it is, of course, very much cheaper than platinum: On the other hand, for the manufacture of the extra concentrated acid, from 97- to 98-per-cent. H_2SO_4 or 79- to 80-per-cent. SO_3 , iron is also more suitable. Hot acid stronger than 94-per-cent. H_2SO_4 acts strongly on platinum, but has very little action on iron. In this country final concentration in iron may be said to be the rule and the practice is rapidly gaining ground in Europe.

51. Concentration in Glass Retorts or Stills.—This practice is practically obsolete in the United States, but the following description of the apparatus sometimes used will be of interest. In Fig. 20 (a) is shown

a side view and section of the furnaces and retorts, and Fig. 20 (*b*) shows an end view of the same. The glass retorts c , c_1 , and c_2 are arranged in steps as shown. The acid from the pan bench flows by gravity through the pipe a and funnel b into the highest retort c . The overflow from c flows through the pipe f to c_1 , and so on down the series; the concentrated acid from the last retort c_2 flows to the cooler H , from which it can be drawn by means of the pipe i . The weak distillate is carried through the "goose-necks" d , d_1 , and d_2 to the vapor flue e . A separate fire is maintained under each retort in the fire-boxes j , j_1 , and j_2 . At k , k_1 , and k_2 are the ash-pits. The flue l carries the fire gases to the stack. In case of breakage of retorts, their contents are carried off by means of the conduit m .

52. Concentration in Porcelain or Glass Beakers or Dishes: Systems of Negrier, Webb, Levinstein, and Others.—The principles involved in all these systems of

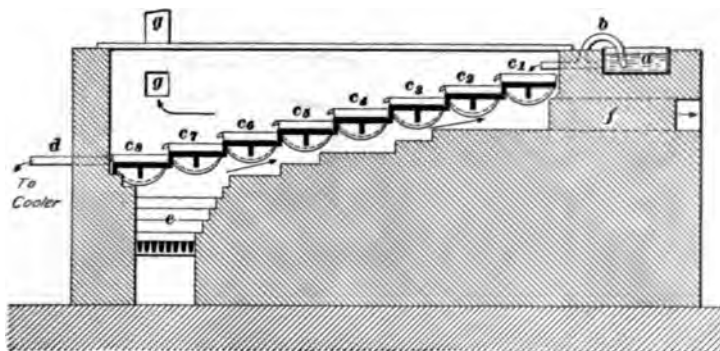
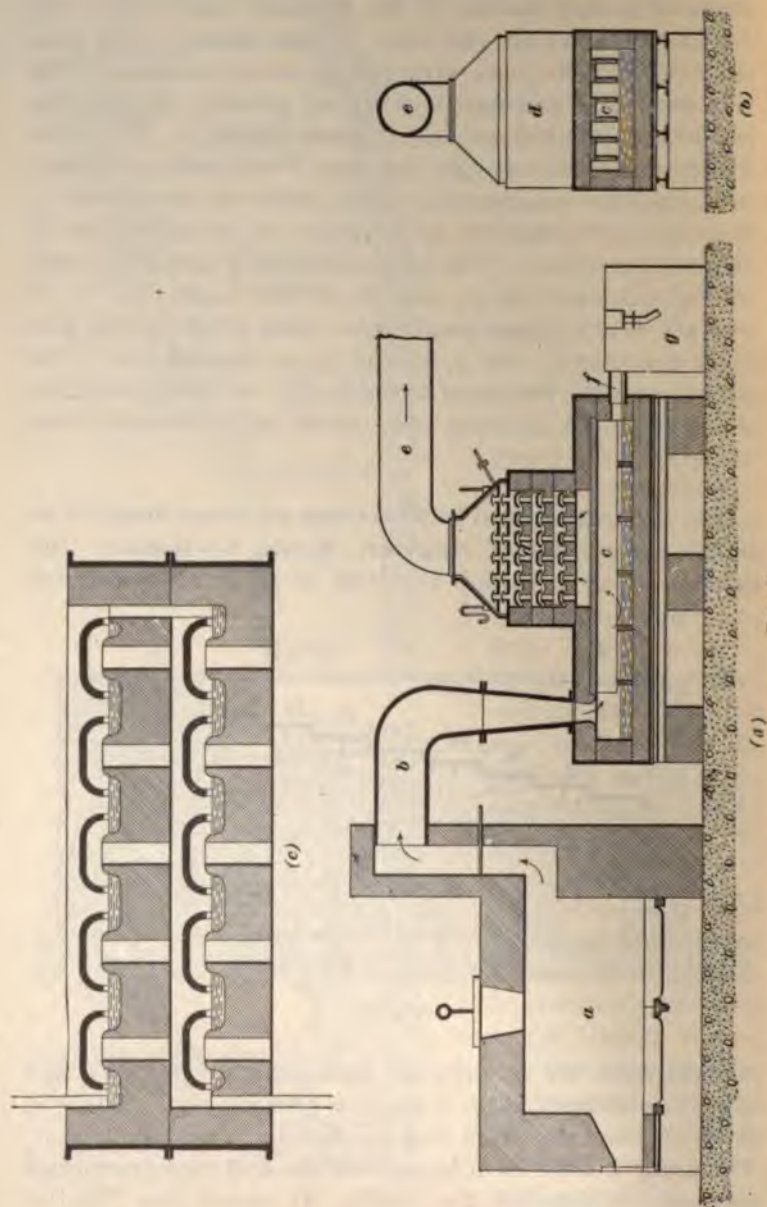

FIG. 21

concentration are very similar, and, generally speaking, are merely modifications in details of construction. The acid flows continuously from dish to dish or beaker to beaker. The firing is done from below and the acid vapor is carried away by a separate flue. Fig. 21 shows the Negrier



apparatus and illustrates this method of concentration. All these methods, however, are open to the objection that it is very difficult to prevent the escape of acid fumes into the air.

The operation of the Negrier apparatus shown in Fig. 21 is as follows: Pan acid from *a* flows through conduit *b* into the first porcelain dish *c*₁ and so on by means of the lip on the dishes from one dish to the other *c*₁, *c*₂, *c*_n until the strong, concentrated acid reaches the conduit *d*, through which it is taken to a cooler and the storage.

Heat is provided by fireplace *e*. The products of combustion pass under the porcelain dishes until they reach the flue *f* and are carried to the stack. The distillates and water vapor pass through the flue *g* and are carried to a suitable condensing apparatus or to the stack.

53. Concentration by the Kessler Process.—This method consists of the direct use of heated air or fire gas for evaporating the water from dilute sulphuric-acid solutions. The current of hot gas produced from a coke fire or producer is brought into immediate contact with the dilute acid. In this process, the following conditions must be fulfilled: The current of hot air or gas must be brought into contact with a sufficiently large surface of acid to immediately and considerably reduce its temperature. The air or gas must then be completely saturated with steam and acid vapor. The apparatus must not only be able to resist the action of hot acid and acid vapors, but must be so constructed that the crusts and deposits formed can either be readily removed or will not interfere with the efficiency of the apparatus. *Under these conditions, the acid can be concentrated at a temperature far below its boiling point.* In order to produce acid of 95-per-cent. H_2SO_4 , boiling at 284° C., the temperature need not exceed 170° to 180° C.; for the most highly concentrated acid boiling at 320°, a temperature of 200° to 230° C. will suffice.

54. The Kessler still is shown in detail in Fig. 22 (*a*), (*b*), and (*c*). Apart from the coke fireplace *a*, the apparatus is

divided into two parts, respectively, the saturator *c* and the recuperator *d*. The hot air enters the saturator at about 300° C. to 450° C. and leaves it at 150° C. The acid mist or vapor passing out of the saturator is retained in the recuperator, which acts as a dephlegmating or distilling column.

Fig. 22 (*a*) is a longitudinal section through the whole of the apparatus. A large coke fire in the furnace *a* supplies the hot air that passes through the flue *b* to the saturator *c*.

The saturator is constructed of lava (from the town of Volvic in France) with deflecting plates in such a way as to bring the hot gas into close and immediate contact with a large surface of acid, thus securing immediate reduction in temperature and saturation of the gas with the steam and acid vapors formed. The acid vapors contained in the gases leaving the saturator are recovered in the recuperator *d*.

The recuperator *d*, shown enlarged in Fig. 22 (*c*), is a dephlegmating column, also constructed of Volvic lava. It is supplied with weak acid. In the recuperator the gas leaving the saturator at 150° C. is reduced in temperature to 85° C., at which temperature all the acid vapor contained in the gas is condensed, while the steam or water vapor passes out of the apparatus at *e*. The concentrated acid passes from the apparatus at *f* into the cooler *g*.

The solutions can be concentrated to 98-per-cent. H_2SO_4 , and Glover tower acid can be used. The fuel used to concentrate 100 parts of 95-per-cent. H_2SO_4 from 54° Baumé or 68.25-per-cent. H_2SO_4 is stated to be 8 parts of small gas coke for the hot-air producer and 3 or 4 parts of coal for power for the exhauster. No weak acid is made, and the product is clear and free from nitrogen compounds; no cooling water is required; the apparatus takes up little room and requires little repair.

55. Concentration and Distillation, Starting With the Glover Tower.—It has already been stated that the

heat produced in the desulphurizing furnaces is sufficient, if properly conserved, to concentrate the whole of the acid made in any chamber plant to 66° Baumé.

This can be done in the Glover tower if the tower is constructed so as to stand the action of the hot, concentrated acid. There are, however, two drawbacks to this plan. The first is the impure condition of the concentrated acid, which thus contains most of the impurities of the burner gas, rendering it fit commercially for only a few purposes, and the second drawback is the danger of the Glover tower under these conditions not performing its denitrating function properly. The latter objection can be overcome in several ways. Two towers can be placed one above the other, the burner gas passing from the lower to the upper tower. The upper tower denitrates the nitrous vitriol and supplies a stream of hot acid from 58° to 60° Baumé to the lower tower, the function of the lower tower being simply one of concentration. If two chamber systems are near to each other, as is often the case in a chemical plant, then the Glover tower of one system may be employed as a denitrator and the Glover tower of the other as a concentrator; the burner gas from the two towers, the one intensely nitrous and the other not nitrous, being thoroughly mixed with a fan and passed on and distributed by the fan to the two-chamber systems. In this case all the nitrous vitriol is run down the ore tower and denitrated, the resulting denitrated acid of 60° to 62° Baumé being concentrated to 66° Baumé in the concentrating tower.

The drawback of impurity, however, still remains, and except when an unusually pure metallic sulphide is used as raw material, the acid is only fit for limited use.

56. A modification of this plan, however, has now been in use at several works for some years, producing a very pure acid at a very low cost. This consists in denitrating and concentrating the acid in a suitably constructed Glover tower until it has a density of 64.5° Baumé, at which point, it will be remembered, hot acid attacks iron but little.

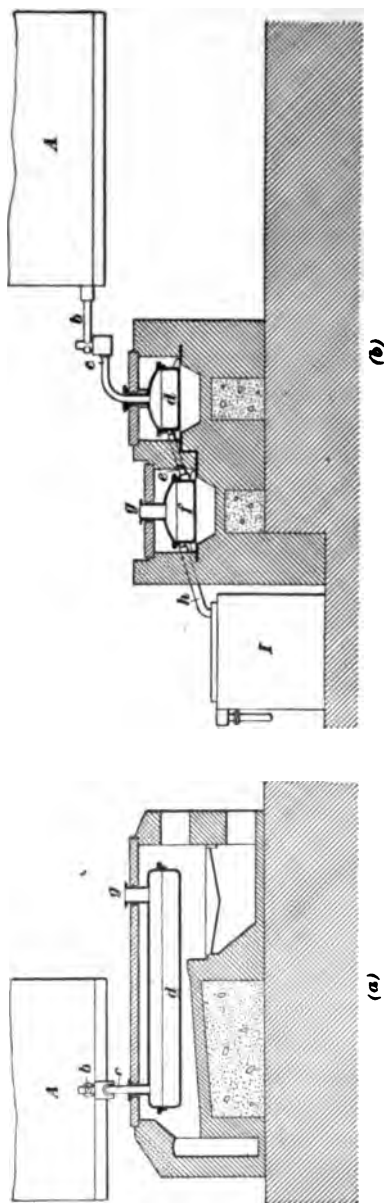

FIG. 28.

This acid, with the full heat imparted to it by the Glover tower (170° to 200° C.), is run from the tower directly into a large cast-iron still (about 8 feet \times 2 feet \times 6 inches). This still has a cast-iron cover and is so set in the brickwork of the fire that the fire gas plays all around it. In this still it is rapidly concentrated to about 95-per-cent. H_2SO_4 , or some degree of strength higher than 93.5-per-cent. H_2SO_4 (66° Baumé). The 95-per-cent. H_2SO_4 acid is then run into a connecting iron still, also completely surrounded with the fire gases. In this still it is further concentrated to a very impure 98-per-cent. H_2SO_4 . As nearly all the 98-per-cent. H_2SO_4 acid made in this country is made for the manufacturers of nitroglycerin, who do not call for a pure acid, and as after being mixed with nitric acid to make the so-called *mixed acid*, in which form it is sold to manufacturers of nitroglycerin, it is usually filtered to remove

1

1
2
3
4

5
6
7

8

solid impurities, the impure condition of this acid is of little moment. The important fact is that the distillates produced by these two stills, respectively, are pure distillates of 60° Baumé and 66° Baumé, both of which are commercial solutions largely used in the arts in this country. Furthermore, as the acid runs hot from the Glover tower to the first iron still, means are taken to add very small quantities of ammonium-sulphate solution, .1 to .5 per cent. on the 66° Baumé acid produced. This not only destroys any nitrogen compounds remaining in the strong, hot acid, but also converts the volatile arsenious acid into non-volatile arsenic acid, which therefore either remains in the stills or the 98-per-cent. concentrate and does not pass over with the distillate of 66° Baumé and 60° Baumé acid.

The apparatus employed in this method of concentration is shown in Fig. 23 (*a*) and (*b*). The Glover tower *A*, Fig. 23 (*b*), is connected by the platinum pipe, or nozzle *b*, and the platinum box and tube *c* with the first iron still *d*. In this still the acid is concentrated to a strength higher than 93.5-per-cent. H_2SO_4 , generally to about 95-per-cent. H_2SO_4 . The distillate from this still will average about 60° Baumé.

The acid from the first still *d* flows to the second still *f* through the pipe *e*. In this still the acid is concentrated to 97.5-per-cent. H_2SO_4 . The distillate passing out at *g* averages about 66° Baumé. The concentrated acid finds an outlet through the pipe *h* into the cooler *I*. A longitudinal section of one of the stills is shown in Fig. 23 (*a*).

57. Lunge Freezing Process for the Production of Sulphuric Monohydrate.—The solution employed should contain at least 97-per-cent. H_2SO_4 , and in order to obtain a good yield of monohydrate should be stronger. The solution is first cooled and then charged into the iron cells of an ordinary ice plant. When the solution in the cells is properly frozen, the cells are dipped in warm water to detach the frozen solution from the sides of the cells. The frozen mass is then crushed and passed to a cast-iron

centrifugal separator, in which the crystallized mass of monohydrate is separated from a solution of about 94-per-cent. H_2SO_4 . The pure crystal monohydrate is then melted in a water-jacketed enameled pan and run into carboys or other packages.

58. By the above methods is produced the strongest acid which it is possible to produce by the chamber process. For obtaining the monohydrate or stronger solutions of SO_3 , we have already seen that the old Nordhausen process has been replaced by the contact process.

59. The diagram, Fig. 24, shows the various methods of manufacturing and concentrating sulphuric acid, and also the relations of the several processes of manufacture.

A very useful function of the contact process is as an adjunct to an existing chamber process, where it can be used for strengthening the solutions of sulphur trioxide produced in the lead pans or the Glover tower, thus replacing the concentrating plant or enabling a stronger acid to be produced than is possible by concentration, and at the same time increasing the capacity of the plant.

ALKALIES AND HYDROCHLORIC ACID

(PART 1)

CHEMICAL METHODS

SODIUM CHLORIDE

OCCURRENCE OF SALT

1. Sodium chloride, or common salt, as the raw material from which practically all the compounds of sodium as well as hydrochloric acid, chlorine, and bleaching powder are more or less directly made, easily stands foremost in its importance to the human race among the substances occurring in nature. Fortunately it occurs in large quantities in the ocean, it issues from the earth in many places as brine from salt springs, and most important of all, it occurs in large solid beds in almost all countries.

SALT FROM SEA WATER

2. The average amount of solid material in the Atlantic Ocean is about 34 grams per liter, of which a little more than three-fourths is salt, while the remainder consists

§ 29

For notice of copyright, see page immediately following the title page.

2 ALKALIES AND HYDROCHLORIC ACID § 29

of chlorides, bromides, iodides, and sulphates of potassium, magnesium, and calcium. The Pacific Ocean contains about the same amount of solids of approximately the same composition, while various inland seas range from comparatively dilute to saturated solutions. Table I gives the composition of the more important large bodies of salt water.

TABLE I

	Atlantic Ocean. Per Cent.	Pacific Ocean. Per Cent.	Mediterranean Sea. Per Cent.
Solid salts.....	3.63	3.50	3.37
H_2O	96.37	96.50	96.63
SOLID CONTENTS:			
$NaCl$	77.03	73.96	77.07
KCl	3.89		2.48
$CaCl_2$			
$MgCl_2$	7.86	13.19	8.76
$NaBr$ }	1.30	1.01	.49
$MgBr_2$ }			
$CaSO_4$	4.63		
$MgSO_4$	5.29	4.63	2.76
K_2SO_4		3.18	8.34
$CaCO_3$ }		3.85	.10
$MgCO_3$ }			

Salt is obtained from sea water either by evaporating the water by means of the heat of the sun or by freezing out the water; for it would not pay to use fuel for evaporating such a dilute solution. For this purpose a low, level shore is selected and a series of basins are hollowed out and lined with beaten clay, which keeps the water from soaking away. The brine is kept circulating from one of these basins to the next until the sun's heat and the hot wind has concentrated

it to the crystallization point, when it is allowed to stand until about 50 per cent. of the salt has crystallized out. The remainder of the brine, which contains so much magnesium salts that they would separate out with the salt, is called *bittern*. This is run into another vat for the separation of the potassium and magnesium salts, or it is run back into the ocean. Salt is produced by this means in this country in large quantities along Great Salt Lake, Utah, and at a few places in California. In Europe the principal production is in Southern France and Italy; in Siberia considerable salt is obtained by freezing the water instead of evaporating it.

ROCK SALT

3. The most important source of salt is the large, solid deposits that have been left by the partial or complete drying up of inland seas at some prehistoric period. The same process is going on today at the Dead Sea, the Great Salt Lake, and other places. These deposits have in the course of time become covered with a layer of earth that varies from a few feet to several hundred feet in depth. When this layer of earth is not too thick, the salt can be most economically obtained by running down shafts and mining. In Louisiana the salt lies only 14 to 16 feet below the surface and is mostly mined; there are also one or two mines worked in Kansas and in New York, although in these States the shafts go down 800 feet or more. The most important and extensive salt mines in the world are at Stassfurt, Germany, which produce not only large quantities of pure salt, but also the greater part of the world's supply of potassium salts. The Louisiana rock salt is very pure, but practically all the rest produced in this country contains iron and other impurities and has comparatively little sale. The salt is largely obtained from these deposits by boring down to them, running in water to form a strong brine, pumping this out, and treating it like any other brine.

SALT FROM BRINE

4. **Brines** may be divided into two classes: Natural brines, which flow from springs or wells from a natural reservoir and may be quite dilute; and artificial brines, which are made by running water into a rock-salt deposit. These may always be made saturated if desired. Weak natural brines are concentrated in some parts of France and Germany by means of a *graduator* until they are strong enough to pay for artificial evaporation. This method is now going out of use, however, and such brines are either worked by solar evaporation or are discarded altogether. In the United States the processes used for evaporating brines are the following, named in the order of the number of plants using the system: *Grainers, solar evaporation, open pan, vacuum pan, and kettle.*

5. **Solar Evaporation.**—This method depends on the direct heat of the sun. The brine as it is pumped from the wells first goes to a settling tank, where the iron, which is usually present in the form of acid ferrous carbonate, is precipitated by the escape of the carbon dioxide and the oxidizing action of the air as ferric hydroxide. Other sedimentary material also separates out at the same time. The brine is then run into shallow wooden vats, usually 18 to 20 feet wide, 100 to 400 feet long, and about 8 inches deep, where it is allowed to stand until salt crystals begin to separate out, by which time most of the calcium sulphate has deposited. Finally the concentrated brine goes to the salt pans, which are similar to the above but not quite so deep. Here the salt separates as crystals and the brine is renewed from time to time until a salt layer of about 3 inches is obtained. The residue of the brine, which contains most of the chlorides of calcium and magnesium, is then run to waste and the salt "harvested" by scraping it together and putting it into tubs with perforated bottoms, where it is allowed to thoroughly drain.

The vats are built on piles and arranged so that the brine, after being pumped into the settling tank, can run by gravity

to the other vats. In countries where very little rain falls, especially during certain seasons of the year, the vats can stand uncovered continuously. In the eastern part of the United States, however, where frequent rains occur, it is necessary to provide the vats with movable covers, which can be rolled back during fair weather. The salt obtained by this process is in large, bulky, cubical crystals that occlude considerable quantities of mother liquor, and on account of the deliquescent calcium and magnesium chlorides thus mixed with the salt, it becomes moist in damp weather.

6. Kettle Evaporation.—In the kettle process the brine is evaporated in cast-iron kettles about 4 feet in diameter by 2 feet deep and heated either by direct fire or a steam jacket. When necessary for the removal of the iron, the brine is mixed with a little milk of lime and allowed to settle; it is then run into kettles and evaporated. The calcium sulphate, which separates out first, is removed from time to time until the salt begins to crystallize. The salt is removed from the kettle at intervals, drained in baskets, and then dumped into bins to thoroughly dry.

When heated by direct fire, the kettles are arranged in rows of from sixteen to twenty-five over the flues; and as those at the front end are the hottest, the brine evaporates most rapidly at that point giving the finest crystals, while the kettles at the back end produce crystals more like the solar salt. With steam-jacketed kettles, the product is much more uniform.

7. The Pan Process.—This is probably the oldest of all methods using artificial heat, for the Romans at the time of their occupation of England used practically the same arrangement as the present, except that their pans were of lead and only about 6 feet square. The pans *a* (Fig. 1) now used are made of iron and are from 70 to 150 feet long, 20 to 25 feet wide, and 12 to 18 inches deep. They are heated by direct fire. The grates, of which there are three or four for each pan, with the doors *b* for charging, are situated at the front end of the pan and are connected to a

chimney, which is placed at the rear end of each pan by flues that lead under the pan. The brine, after having been purified by milk of lime and settled, is led into the back part of the pan, where it becomes slowly heated and concentrated so that it deposits its calcium sulphate as it slowly flows towards the front and hotter portion of the pan, where the

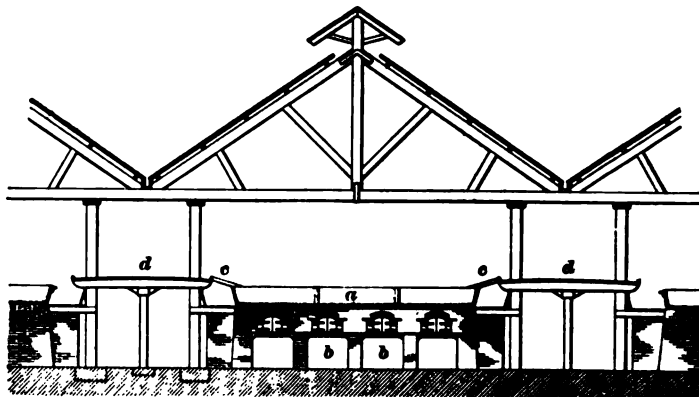

FIG. 1

greater part of the salt is deposited. At intervals the salt is scraped together and on to the draining boards *c* by means of long-handled wooden hoes. The workmen pass between the pans on the wooden walks *d*. The roof is cut out at the peak to allow the steam to escape, but it is covered with a cap to keep out the rain.

8. Grainers.—An important modification of the pan process is the so-called grainer. The pan is made of either iron or wood and of the same general dimensions as the above, except somewhat deeper. The evaporation is caused by steam circulating through pipes that are raised about 6 inches above the bottom of the pan and are kept constantly covered with brine; in other respects the operation is practically the same as in the pan process.

9. Vacuum Pan Process.—This process leads to a very fine grade of salt, and on this account is used in several

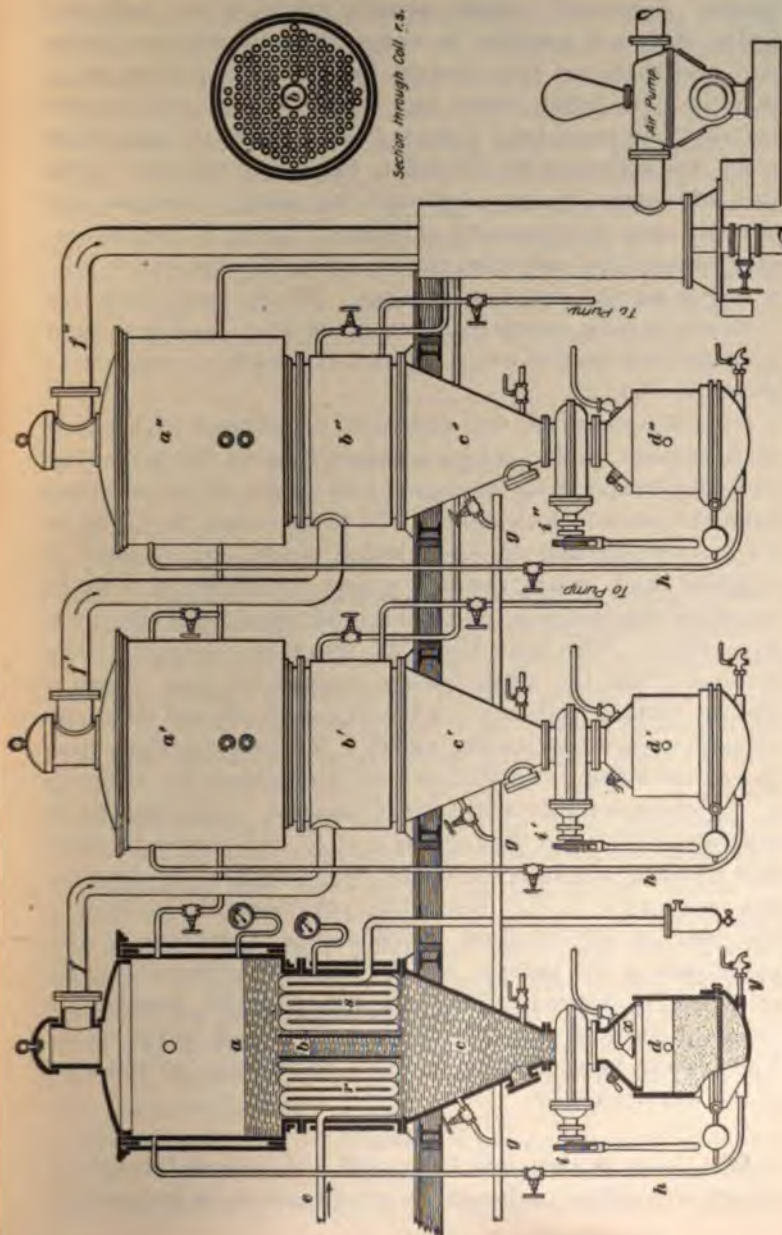

FIG. 2

places. Since salt is about equally soluble in hot and cold water, it is not possible to concentrate the solution in the pan and then run the solution outside to crystallize, as is done in many other cases; but if the vacuum pan is used for anything more than bringing the brine to its saturation point, the salt must be allowed to deposit in the pan. This can, of course, be accomplished by using a simple pan covered over and partially exhausted, but it is then necessary to open the pan from time to time to remove the salt, which is an obvious disadvantage. To do away with this difficulty several continuous-acting vacuum pans have been proposed, the best of which is Pick's triple-effect evaporator, shown in Fig. 2.

In this apparatus, the principle is followed of keeping each element under a less pressure than in the preceding one, and evaporating its contents by means of steam taken from the preceding element. The brine enters at *g*, and at *rs* is a vertical coil of pipes, which in the first element is supplied with steam through *e* and is sufficiently long to condense the steam so that it flows as water from the opposite end *s*. The heat from the steam coil evaporates the brine *ac*, and the steam passes through the pipe *f* into a similar vertical coil at *b'*, where it condenses and boils the brine in *a'c'*, which stands under a less pressure than that in *ac*; the steam from *a'c'*, in turn, evaporates the brine in *a''c''*, which is under a still lower pressure. The salt as it separates collects in the funnels *c, c', c''*, and can be brought into the filter chambers *d, d', d''* when desired by turning the valve at *i, i', i''*. Each filter chamber has a filter in the bottom portion from which a pipe *h* returns to the upper part of the element, so that the mother liquor may be returned, if desired. The salt may then be washed by means of the rose *x* and the wash water run off by the tap *y*. The salt can be withdrawn through an opening in the side of the filter chamber.

10. In preparing fine table salt, the brine is frequently mixed with sodium carbonate to precipitate, so far as possible,

the calcium as carbonate, and then with a little soap, or some similar substance, to remove the remainder of the calcium and magnesium as the insoluble soaps of these elements.

In certain European countries, salt used for food is taxed, but when used for manufacturing purposes the tax is very light. To prevent fraud, salt to be used for manufacturing must be *denatured*; that is, rendered unfit for food purposes. This is accomplished by mixing with the salt some one of an almost endless number of substances, among which may be named sodium sulphate, crude petroleum, coal dust, iron oxide, alum, carbolic acid, etc.

SODIUM CARBONATE

NATURAL AND ARTIFICIAL SODA

11. Natural Occurrence.—Sodium carbonate occurs in nature widely distributed. It is seldom found, however, as the normal carbonate, but as a partial decomposition product of sodium bicarbonate of the composition Na_2CO_3 , $NaHCO_3 \cdot 2H_2O$, commonly known as *trona* or *urao*. It has long been known in Egypt, where it is called *Wadi Atrium*, or *Natrium*; in Hungary it is called *Szekso*. It is also found in Russia and other countries. Very large deposits are found in many parts of the United States, especially in Wyoming and California. In the former State are found lakes that contain over 2 pounds of crystallized sodium carbonate per gallon of water and only a small amount of sodium chloride. Coal is found only 15 miles away, so that it is estimated that it is possible to make from 98 to 99 per cent. of pure sodium carbonate at one dollar a ton. A company has recently been incorporated to undertake its manufacture.

Probably the largest deposits of natural sodium carbonate in the world occur in California. Mono Lake in that State has a surface of 65 square miles, and is estimated to contain

10 ALKALIES AND HYDROCHLORIC ACID § 29

75,000,000 tons of sodium carbonate and 18,000,000 tons of sodium bicarbonate. It is high in the mountains, however, where fuel is scarce and solar evaporation is out of the question; besides, the difficulty of removing the finished product makes the working of this deposit impossible, for the present at any rate. Owen Lake, however, which has an area of about 110 square miles, has a sodium-carbonate content of from 40,000,000 to 50,000,000 tons, and is constantly being added to at the rate of about 200,000 tons each year. The soda is here obtained by solar evaporation and considerable quantities are produced. A third large deposit, which has recently been discovered in Mexico, is about $2\frac{1}{2}$ miles from Adair Bay on the Gulf of California. This deposit covers an area of about 60 acres to a depth of from 1 to 3 feet, and is only covered by about 3 inches of sandy silt. The average sample of the dry soda showed 76 per cent. of sodium carbonate, 5 per cent. of sodium sulphate, 1 per cent. of sodium chloride, and about 18 per cent. of soluble matter.

The source of the natural soda is probably feldspar rocks that are decomposed by the atmospheric conditions. The sodium carbonate formed is washed by rains into lakes, and, lacking outlets, their waters become supersaturated. Probably some is also made by the transformation of sodium chloride to sodium sulphate by calcium or magnesium sulphate, then the sodium sulphate is reduced to sodium sulphide by certain Algæ, and the sulphide is converted into the carbonate by the action of carbon dioxide.

12. Until nearly the end of the 18th century, practically all the world's supply of soda came from these natural deposits and from the ashes of certain plants that grow in or near the sea. The most of the soda came from this latter source. For this reason, at that time, potassium carbonate, which is found in the ashes of land plants, was much the cheaper and more commonly used alkali. The plant soda was made in Spain, where it is called *barilla*; in France it is called *varil* or *blanquette*.

13. Artificial Soda.—The artificial preparation of sodium carbonate, frequently called *soda ash*, dates back to the latter part of the 18th century and has now become one of the largest of the chemical industries. While a large number of processes for the manufacture of soda have been proposed, the only ones at present in use on a large scale are *Le Blanc's process*, the *cryolite soda process*, the *ammonia-soda* or *Solvay process*, and the *electrolytic process*. These processes are named in the historical order in which they became important, but they will be treated in the order of their present importance in the production of soda ash in America.

THE SOLVAY PROCESS

14. Historical.—The fact that when solutions of sodium chloride and ammonium bicarbonate are mixed, a part of the sodium separates out as sodium bicarbonate, was probably known in the early part of the last century. It was not until 1838, however, that it was recognized as a possible method for the manufacture of sodium carbonate. In that year H. G. Dyar and J. Hemming took out an English patent for making sodium carbonate by means of the reaction

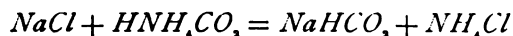

and then heating the sodium bicarbonate to drive off the carbon dioxide and water, leaving sodium carbonate. This patent covered the chemistry of the process practically as it is worked at the present time, and also many of the mechanical principles. At that time, however, the cost of ammonia was too great and they did not succeed in keeping the loss low enough to make the process profitable. About 1855, Schloesing and Rolland patented in England some improvements on the above process and at a factory in France actually manufactured about 25 tons of soda a month for nearly 2 years. They did not succeed in recovering the ammonia sufficiently well, however, and abandoned the method. Various other inventors worked

upon the process between 1838 and 1863, and fortunes in time and money were spent to no avail. In the latter year, Ernest Solvay, a Belgian, took up the process without knowing much about the other work that had been done upon it. He worked upon the process until 1873 before the mechanical difficulties were overcome and the method became an assured success. From 1873 until the present time the process has been constantly growing in importance and strength, so that now far more than half of the world's supply of soda is made by this method.

15. Outline of the Process.—The process, in brief, consists in preparing carbon dioxide from limestone, passing this gas into an ammonium-hydrate solution to form ammonium bicarbonate, mixing salt solution with the ammonium bicarbonate, and getting sodium bicarbonate and ammonium chloride. The sodium bicarbonate is then calcined to form soda ash and the carbon dioxide is led back into the process. The ammonium chloride is decomposed by milk of lime, the ammonia is set free to be used over again, and the chlorine goes to form calcium chloride, which is mostly run to waste. The reactions are then

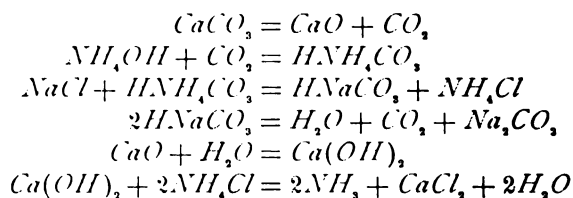

These reactions do not, however, take place in quite so many steps, for the sodium-chloride and ammonium-hydroxide solutions are first mixed and the carbon dioxide then run in. The reaction between sodium chloride and ammonium bicarbonate is a reversible one, so that if we should start with sodium bicarbonate and add ammonium chloride to it, we would have a certain amount of sodium chloride and ammonium bicarbonate formed. The reaction can, therefore, never be complete. It will be driven farther in the desired direction the more of an excess of salt

there is present; and as salt is cheap, it is customary to allow an excess of salt over the amount necessary to react with the ammonium bicarbonate. The latter substance is thus more completely used. Formerly it was very common to employ solid salt, but this practice is now quite generally given up and an excess of saturated brine is used.

RAW MATERIALS

16. Limestone.—The nearer pure calcium carbonate the limestone is naturally, the better it is, but the impurities in this case are not so serious an objection as in the Le Blanc soda process. A too high percentage of silica, iron, or alumina is objectionable, as it causes the limestone to clinker if the temperature is sufficiently high to burn the limestone rapidly. When the lime clinkers, *dead burns*, it is almost impossible to slake it and the lime is worthless. A high percentage of magnesium carbonate is also undesirable in a limestone, as it lowers the efficiency of the quicklime, for the magnesium oxide cannot be used to liberate ammonia from its salts nor to make caustic soda. The limestone from different parts of the same quarry differs considerably, as is seen in the following average analyses of the limestone used by one of the large United States ammonia-soda works for three consecutive months:

Constituents	October. Per Cent.	November. Per Cent.	December. Per Cent.
SiO_2 (insol. in HCL)	2.95	5.60	3.95
Al_2O_3 and Fe_2O_380	.90	.30
$CaCO_3$	94.20	83.26	88.39
$MgCO_3$	2.36	10.41	7.75
Total	100.31	100.17	100.39

A hard, compact limestone is the most suitable, as, although it takes a little longer to burn, it gives a quicklime

that is easier to thoroughly slake, and the slaked lime is usually of a better quality.

17. Brine.—The salt used in this process is in solution, and the solution may be made from solid salt at the works. Usually, however, the soda works are so situated that natural brine or artificial brine, made by dissolving the rock salt from its bed, can be used. As pure a brine as possible is desirable, but the ordinary brine used generally contains more or less calcium and magnesium salts, and sometimes iron compounds are also present. The magnesium salts are the most injurious, for they are not so rapidly precipitated by the ammonium carbonate in the purification process (see Art. 21), and the magnesium carbonate separates out later when vat liquor is being cooled and is liable to then stop the conducting pipes. A sample of the Tully brine used by the Solvay Process Company, at Syracuse, New York, in 1892, gave the following analysis:

Constituents	Grams per Liter
Sediment020
$CaSO_4$	4.306
$CaCl_2$	2.718
$MgCl_2$250
Total impurities.....	7.294

This same brine contained at that time 292.88 grams of sodium chloride per liter. This is a good brine, although a little low in salt.

18. Ammonia.—Although the ammonia is used over and over in the preparation of ammonia soda, there is, nevertheless, always more or less of a loss that must be made up by an addition from outside. The usual sources of ammonia are the coal-gas works and, at the present time, the by-product coke ovens. This ammonia, from whatever

source, comes to the works in the form of crude sulphate, or frequently as gas liquor, which is a solution of a mixture of ammonium salts. So long as it contains little or no free acid, it is acceptable and is purchased strictly on the basis of the ammonia that it will yield by distillation with lime. A good gas liquor should contain at least 16 per cent. of ammonia.

19. Coal and Coke.—Coal is used entirely for the boilers, and any grade of coal that is suitable for firing boilers can be used here. Coke is used mostly in the lime kiln, and should be good oven coke and as free from sulphur as possible; for with high sulphur, sulphur dioxide is liable to get into the gas, and at any rate it will yield a lime high in sulphates. This, if used for making caustic soda, will cause the formation of large quantities of sodium sulphate in the caustic liquor, which necessarily means a loss of soda as well as the necessity of fishing this salt from the caustic as it is boiled down.

DETAILS OF THE PROCESS

20. Carbon Dioxide and Lime.—Since lime is required for the recovery of the ammonia and carbon dioxide is necessary for the preparation of the bicarbonate, they are both best made at the works from limestone. The gas must be at least 30 per cent. carbon dioxide and, since the ash of the fuel does not especially interfere in the use of the lime, the coke, which is the fuel used for burning the lime, is charged in layers with the limestone.

The most suitable form of lime kiln for use is shown in Fig. 3. This kiln consists of a shaft from 24 to 40 feet high and tapering both ways to two-thirds the distance from the top. The outer shell of iron is lined with firebrick. In the larger furnaces two rows of brick are used. The whole kiln is supported by the iron pillars *c*, which rest on iron bases set in brickwork. The top of the kiln is provided with a cover *a* that can be raised to charge the kiln and is then

lowered and rests in a lute of sand or water in *b*. At *d* are shown 3-inch holes that are ordinarily kept closed with

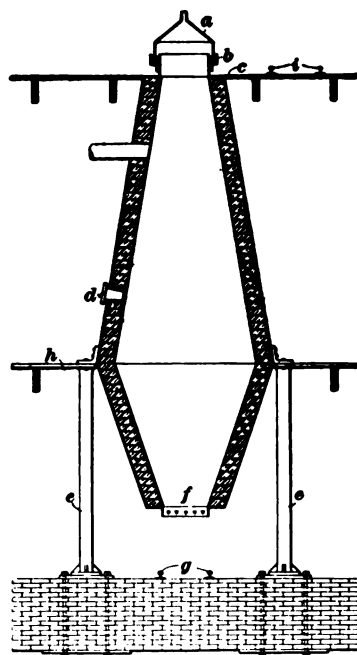

FIG. 3

plugs, but which may be opened to serve as peep holes to observe the state of the kiln, to admit more air if necessary, and sometimes to break down the charge. At *f* the kiln is provided with grate bars that hold the lime in place until it should be removed, when a car is run under on the track *g* and by moving or turning the bars, the lime emptied into the car. A platform is placed at *h* for the convenience of the workmen using the peep holes *d*, and a platform at *c* for charging purposes. The limestone and coke are all elevated to the platform *c* and then, by means of cars running on the track *i*, the material is

carried to the different kilns and charged in alternate layers. A pipe for conducting away the gas is provided about 4 feet from the top of the kiln, the escaping gas being quite cool at this point, say not over 300° C. The relative amounts of the limestone and coke that should be charged must vary at each place, depending on the composition of the limestone and the coke. The following considerations will help us in deciding the matter, however.

The best temperature for burning limestone is about 850° C., but if, owing to impurities in the limestone or to too high ash in the coke, the limestone tends to fuse at this temperature, a lower one must be employed and a longer time spent in the burning. Damp limestone burns at a

lower temperature and better than dry limestone, for the moisture aids the dissociation of the limestone into carbon dioxide and calcium oxide.

Theoretically considered, 1 kilogram of pure calcium carbonate requires 373.5 calories of heat for its decomposition, and in burning carbon to carbon dioxide, 1 kilogram of carbon yields 8,080 calories of heat. Therefore, 1,000 kilograms of calcium carbonate should be burned by about 46 kilograms of pure carbon. Considering that the escaping gases carry away heat with them from 1,000 kilograms of calcium carbonate, we have 440 kilograms of carbon dioxide. Furthermore, the 46 kilograms of carbon will give 169 kilograms of carbon dioxide, making in all 609 kilograms of carbon dioxide. It has a specific heat of .22 calory, and if it escape at 300° C., it will carry with it $609 \times 300 \times .22 = 40,194$ calories of heat. Then, to burn the carbon, we use air, which is four-fifths nitrogen, so that the air necessary to burn 46 kilograms of carbon contains $490\frac{2}{3}$ kilograms of nitrogen. This has a specific heat of .244, and therefore will carry with it $490\frac{2}{3} \times 300 \times .244 = 35,917$ calories. Therefore, the escaping gases will take a total of 76,011 calories of heat, which must be supplied by burning more carbon. This will require about 9.4 kilograms more carbon, which in turn will furnish gas to convey heat, and the amount can be calculated as above. We will then find that theoretically about 57 kilograms of carbon will burn 1,000 kilograms of calcium carbonate. There is still, however, to be added in, the loss of heat through radiation from the sides of the kiln, from the quicklime, which is not quite cold when drawn, and also the heat required to evaporate the moisture in the limestone. Taking all of these factors into consideration, it has been found to be a pretty safe rule to allow 120 kilograms of pure carbon for every 1,000 kilograms of calcium carbonate. Then, if our limestone is 90 per cent. calcium carbonate, it will require $1,000 \div .90 = 1,111.1$ kilograms of limestone to give 1,000 kilograms of calcium carbonate; and if the coke is only 95 per cent. carbon, it will require 126.3 kilograms of coke.

Having thus decided upon his charge, the foreman must watch the results to know if it is right, and he must also regulate the air supply. He must not allow the temperature to get too high, or the lime will fuse, dead burn; nor fall too low, or too long a time will be required in the burning. If an insufficient amount of air is supplied, carbon monoxide will appear in the gas and the air must be increased; on the other hand, too much air will show itself by oxygen in the gas. Ordinarily the supply of air must be regulated to burn the coke properly and not have an excess. If the kiln tends to get too hot and dead burn the lime, it is necessary to reduce the supply of coke. It is often found necessary to allow part of the limestone to go unburned in order not to dead burn the rest of the charge and at the same time avoid carbon monoxide in the lime-kiln gas.

One of the most frequent mechanical difficulties with which the lime-kiln man must contend is *bridging*; that is, the charge tends to clog at some point of the lower part of the kiln, and the loose material underneath works out through the grate (at *f*, Fig. 3), leaving an arch in the kiln that prevents the remainder of the charge from feeding down. When this is observed, it must be remedied at once by breaking down the arch by means of iron bars. If the bridge is very low in the kiln, the bars can be inserted from below; otherwise, they must be used through the peep holes *d*. The carbon dioxide, from the limestone and coke, mixed with the nitrogen of the air, used to burn the coke, is removed from the kiln by a pipe about 4 feet below the top. It contains, as especially undesirable impurities, sulphur dioxide from the sulphur in the coke and considerable dust. These are removed, as far as possible, by thoroughly washing the gas before sending it to the carbonating tower. The scrubber used for this purpose is shown in Fig. 4. The gas from the kilns enters the scrubber through *a*, which, inside of the apparatus, is perforated its entire length so that the gas will be uniformly distributed. The gas rises through the spray of falling water to the first plate *c*, where it must bubble through a column of water, then again through the spray to

the second plate *c*, and so on until it passes out through *e*, to the carbonating tower. Meanwhile water is admitted through *b* in such quantity that it stands at a suitable height on each plate. Each plate *c* has a tube *f* leading to the next lower one, so that if the water enters too fast or the holes in *c* become stopped, the water can overflow through this pipe. If necessary, the gas can also ascend by this pipe to the next section of the washer. Finally the wash water collects in the bottom of the washer and siphons off through *d*.

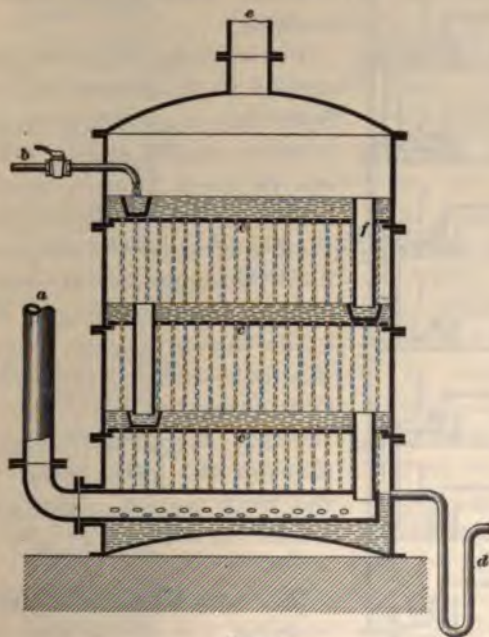

FIG. 4

The lime as it comes from the kiln is slaked with just enough water to cause it to crumble, and is then thrown into a large vat with revolving paddles. In this vat it is churned with sufficient water to bring it to a specific gravity of 1.16, when it is pumped through a screen to remove the lumps of unburned limestone, and then to the ammonia distilling apparatus (see Art. 27).

21. Purification of the Brine.—The brine must be freed from the calcium, magnesium, and other impurities as soon as possible after it enters the works. For this purpose it is used to wash the gases that escape from the ammonia saturators (see Art. 22), and from the carbonators (see Art. 23). These waste gases contain ammonia and carbon

dioxide, so that they form ammonium carbonate in the brine, and precipitate the iron as hydrate and the calcium and magnesium as carbonates.

For washing the gases, coke towers similar to those used in condensing hydrochloric acid are sometimes used. A more suitable style of washer, and one in much more common use, is shown in Fig. 5. In this apparatus, the brine enters at *c* and slowly overflows through corresponding pipes until it finally passes out at the bottom. Meanwhile, the gases from the saturator and the carbonator enter at *a* under the cap *b*, which causes the gas to spread out and pass through the brine before going to the next section. The gas finally passes out at *d*.

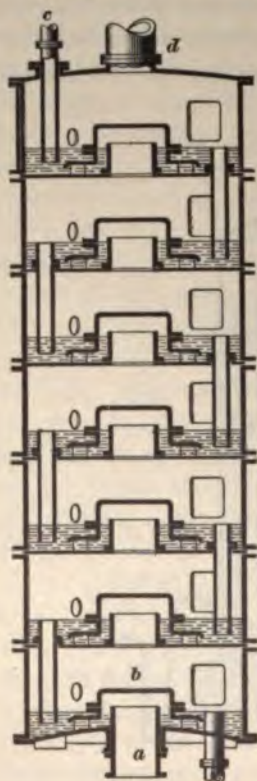

FIG. 5

22. Ammoniacal Brine.—By washing the waste gas, the brine receives enough ammonium carbonate to purify it, and must now be treated with ammonia. This saturation of the brine with ammonia takes place in an apparatus similar to that shown in Fig. 5, except that not so many sections are necessary. For saturating enough brine to make 50 tons of sodium carbonate a day, a saturator made up of 2 or 3 sections like the above, of 8 feet diameter, and

For saturating enough brine to make 50 tons of sodium carbonate a day, a saturator made up of 2 or 3 sections like the above, of 8 feet diameter, and

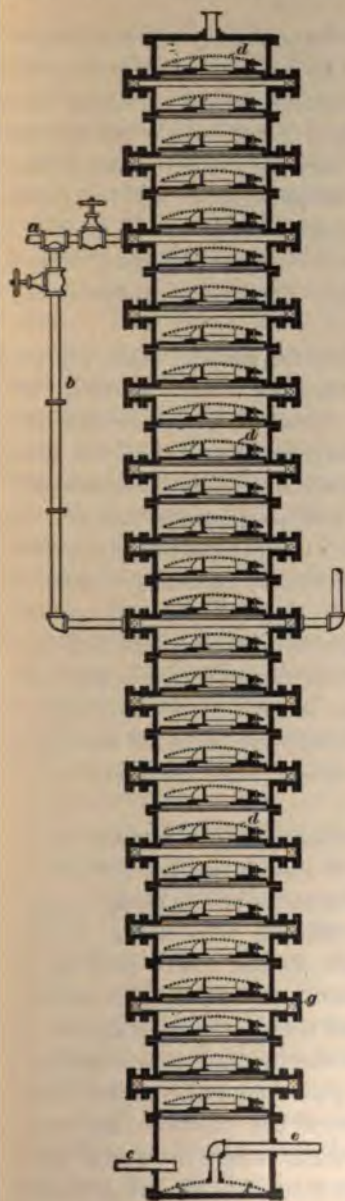

FIG. 6

having a depth of 15 or 18 inches of liquor in each section, is sufficient. The brine must be run through the saturator at such a rate that it contains from 65 to 70 grams of ammonia per liter when it leaves the tower. The ammonia and ammonium carbonate have now thrown out the calcium, magnesium, and iron, and this precipitate remains suspended in the liquid, which is run into the cooling and settling tanks. The settling vats are built with a conical bottom, so that the impurities will collect in the narrow part and may be drawn off at intervals by opening a valve in the bottom. If the brine does not settle, it must be filtered, but usually this will not be the case. The brine is cooled in a vat to as low a temperature as the available water will cool it, and should now be clear and contain 70 grams of ammonia and 270 grams of sodium chloride per liter.

23. Carbonating the Ammoniacal Brine.
From the settling tanks the

ammoniacal brine goes to the carbonating towers, Fig. 6. These are iron towers from 60 to 65 feet high and about 6 feet in diameter. They are made up of sections, each about $3\frac{1}{2}$ feet high and bearing iron plates, one at the bottom and the other one about half way up. Each plate is surmounted with a dome-shaped diaphragm *d* that is perforated with a large number of holes.

Between each pair of plates are a number of pipes *g*, Fig. 7, which conduct water to regulate the temperature in the tower.



FIG. 7

The carbonating usually takes place in two similar towers. In the first, the ammonium hydrate is converted into ammonium carbonate and then the brine is run to the second tower to be finished. In this way less ammonia is lost and the controlling of the temperature is easier.

The temperature in the second tower, especially, must be very carefully controlled; for if too cold, a fine, muddy precipitate of sodium bicarbonate is deposited, which is hard to filter and work with; while if the temperature is too high, the yield of sodium bicarbonate is very much diminished. A temperature is therefore selected that gives the best mean course between the two difficulties; this temperature is between 30° and 40° C.

The ammoniacal brine, by standing in the settling tanks, becomes thoroughly cooled. The gas enters the carbonator against a pressure of $1\frac{1}{2}$ to 2 atmospheres, and in being pumped against this pressure becomes heated. To make it more easy to regulate the temperature in the lower part of the tower, this gas is cooled to about 28° C. before entering the carbonators. In this way all the materials entering the towers are thoroughly cooled and the increase in temperature in the tower is due entirely to the chemical reactions there taking place. The brine enters the carbonating tower through the pipe *a b*, Fig. 6, which enters the tower about half way down, although a branch of this pipe is provided, which enters near the top of the tower and may be used

when occasion demands. The advantage of introducing the brine at about the middle of the carbonator is, that the ammonia has a chance to meet the carbon dioxide sooner and is converted into carbonate before the top of the tower is reached. The ammonium carbonate being less volatile than the ammonia, less ammonia is lost from the carbonator by this method of working. The carbon-dioxide gas enters the tower through *c*, which is arranged in a rose at the end so as to distribute the gas uniformly over the bottom of the tower. This gas, rising through the ammoniacal brine, converts the ammonia and ammonium carbonate into ammonium bicarbonate, which, in turn, throws out the sodium bicarbonate in fine crystals. These, for the most part, pass to the bottom of the tower, in suspension in the liquid, and flow away through the pipe *c*.

A small amount of these crystals constantly adhere to the plates and finally enough collect to clog the holes so much that the free passage of the gas is interfered with. For this reason, every 10 days or 2 weeks, it is necessary to empty the carbonating tower and clean it by blowing in hot water and steam to dissolve these crystals. The tower must then be cooled again before use. A number of towers are usually employed, so that the process does not stop, fresh towers being brought into use when it is necessary to clean one.

Since the ammonia is the most expensive substance entering into the process, the effort is constantly made to use it as completely as possible, even at a sacrifice of other materials. For this reason, only about two-thirds or three-fourths of the salt entering the carbonator is converted into sodium bicarbonate, the remainder being allowed to remain unchanged in the escaping liquid; a portion of the carbon dioxide also escapes unused, although the higher the percentage of carbon dioxide in the gas used, the better it is utilized.

A rough test to show that the carbonator is working properly is to draw a cylinder of the liquor as it runs from the tower and allow it to stand for $\frac{1}{2}$ hour. It should then have a precipitate of sodium bicarbonate equal to from

one-third to one-fourth its total volume. The bicarbonate should be coarse-grained, and when taken from the filters and crushed in the hand no water should run out of it.

24. Washing the Gases.—The gases escaping from the ammonia saturators contain considerable ammonia and therefore cannot be allowed to escape directly into the open air. The gases from the carbonators consist mainly of nitrogen, carbon dioxide, and ammonia, and, of course, must also be washed. The general method of working with these gases is the same in each case, so that they can most conveniently be considered together. It has been found that it is an advantage to keep the saturators as well as the washers under a slightly diminished pressure. Since the ammonia stills connect directly with the saturators, the effect is to give a reduced pressure in the stills, which causes the ammonia to be given off more easily and prevents leaks. Fig. 5 shows a suitable form of washer for this purpose. In order to avoid all loss of ammonia, so far as possible, two of these washers are used. For the first washer, brine is used to absorb the ammonia and carbon dioxide; the brine then goes directly to the saturator. The second washer uses as a wash liquid dilute sulphuric acid, which removes the last traces of ammonia.

25. Filtration.—The liquor running away from the carbonating tower consists of the sodium bicarbonate in suspension and salt, ammonium chloride, and ammonium bicarbonate in solution. The sodium bicarbonate is separated from the mother liquor by vacuum filters or centrifugal machines. Two forms of vacuum filters are in use; the older, the so-called *sand filter*, consists of a box about 10 or 15 feet long, 3 feet wide, and about the same depth. The bottom is perforated and then covered with a layer of large pebbles, then smaller ones, and finally a coating of sand. This is covered with a cloth and a series of slats laid on to protect the filter when the bicarbonate is shoveled out. The filter is fastened tightly to a large

receptacle, from which the air can be exhausted, thus producing suction and more rapid filtration. A vacuum of from one-half to two-thirds of an atmosphere is maintained. This receiver also serves to catch the mother liquor. Above each filter is suspended a water pipe that extends the whole length of the filter and is sufficiently free that it can swing the width of the trough. This pipe is perforated with fine holes and enables the workman to easily wash the precipitate. When one of these filters has been filled and the precipitate washed, it is necessary to shovel out the material by hand, which requires a number of men.

For this and other reasons another form of filter has been introduced into many of the most progressive establishments. This consists of a cylinder about 4 feet long and 3 feet in diameter, the circumference of which is finely perforated and covered with cloth. This cylinder revolves in a large trough filled with the liquor from the carbonating tower; as a vacuum is maintained on the inside of the cylinder, the mother liquor passes to the inside and away, while the sodium bicarbonate is held to the cloth by the outside pressure of the atmosphere. As the cylinder revolves, the portion with the precipitate comes up out of the liquor and meets a fine spray of water, which thoroughly washes it. It then passes on until it meets a scraper, which removes it from the filter and starts it on its way towards the calciner.

Another form of filter, which is somewhat used for the crude bicarbonate, but more especially for the purified bicarbonate, is the *centrifugal*, which produces a rapid and complete separation of the mother liquor from the crystals, but suffers the inconvenience of the sand filter, that the crystals must be shoveled out by hand.

The centrifugal filter consists of an inner shell, the sides of which are made of wire gauze or perforated metal and an outer casing. The inner portion is free to swing about its axis; and when a liquid is brought into it, the centrifugal force throws the contents to the outside, where the solid part adheres and the liquid passes through to the outer compartment, where it drains off.

The crude bicarbonate from the filters contains considerable water, otherwise it is remarkably pure. Its average composition is

$NaHCO_3$	70.0 to 75.0%
Na_2CO_3	3.0 to 5.0%
$NaCl$2 to .7%
NH_351%
H_2O	20.0 to 26.0%

26. Calcination.—The next step in the process is the drying of the bicarbonate and its conversion into soda ash;

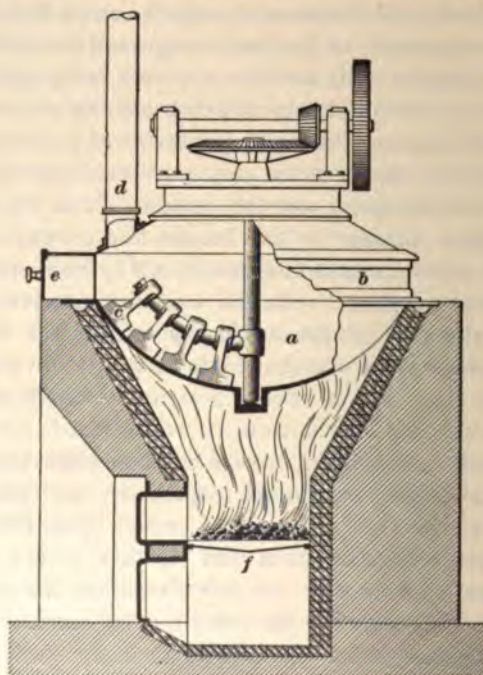

FIG. 8

at the same time, the small amount of ammonia contained in the crude bicarbonate is driven off and saved. Of the large number of arrangements for calcining the bicarbonate, only the two most in use will be described here.

The pan form of drying and calcining apparatus is shown in Fig. 8. It consists of an iron pan *a* covered tightly by an iron cover *b*. Through the top of the cover an iron shaft runs in a gas-tight box and bears the scrapers *c*. These are set at an angle to the bottom of the pan, so that when they revolve they scrape the bicarbonate and carbonate away and prevent its burning fast, as well as thoroughly mixing the charge. The pan is heated from the outside by a fire on the grate *f*. The damp bicarbonate is charged in through the door *e*, which is then closed and the gases escape through the pipe *d*. When the calcination is complete, the soda ash is withdrawn through the same door *e*.

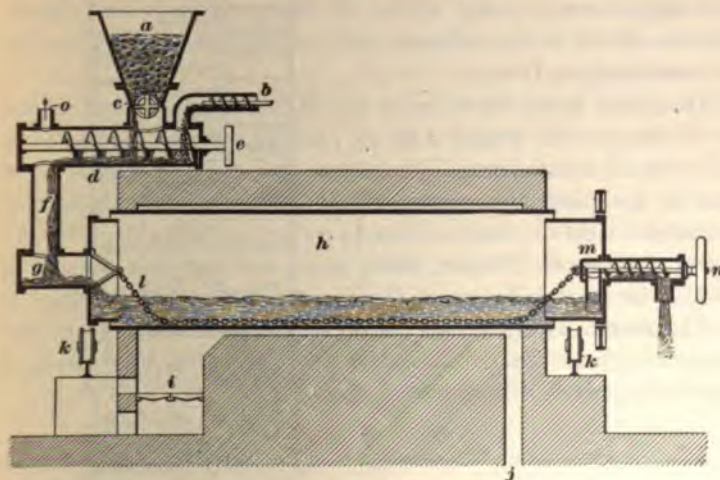

FIG. 9

A second form of calciner is shown in Fig. 9. This is superior to the pan form in that it requires comparatively little labor to operate it. The moist bicarbonate is charged into the hopper *a* and is fed into the conveyer *d* by the wheel *c* and carried forwards by the worm *e*. At the same time a suitable amount of calcined soda ash is fed in by the worm *b* to keep the bicarbonate in a condition to move. The mixture is carried forwards to *f*, where it falls to *g* and then passes into the iron cylinder *h*, which is heated by the

fire from the grate *i*. The flames from that grate surround the cylinder and finally go to the chimney through the flue *j*. The cylinder *h* revolves about its long axis on the rollers *k*. The chain *l* scrapes the charge loose from the sides and mixes it. At *m* a scoop arrangement is caused to dip periodically into the charge and bring a portion of it to the worm *n*, which conveys it outside to carriers. The liberated gases and vapors pass out through *g*, *f*, and *o*.

A modification of the Thelan pan is sometimes used. It is covered over and the gases escape through a pipe in the top cover. The scrapers, instead of revolving, move back and forth over the bottom. It is found most practical in this apparatus to only drive off the ammonia and three-fourths of the carbon dioxide and to finish the calcination in a reverberatory furnace.

The gases from the calciner are passed through condensers to condense the water and to recover the ammonia as a solution of ammonium bicarbonate, which is then run to a special distilling apparatus. The carbon dioxide, from the decomposition of the sodium bicarbonate, should, theoretically, be almost 100 per cent. pure, and for this reason it should be especially good for finishing the carbonating of the ammoniacal brine, but owing to unavoidable leaks in the apparatus, it is but little better than the lime-kiln gas and is usually mixed directly with that gas.

27. Ammonia Recovery.—The mother liquor that comes from the bicarbonate filters contains the greater part of the ammonia that was contained in the ammoniacal brine; 15 to 20 per cent. of this total ammonia is present as ammonium bicarbonate and the remainder as ammonium chloride. This mother liquor is run into storage tanks, where enough gas liquor is added to make up for the loss of ammonia in the process. The gas liquor contains free ammonia, ammonium sulphate, sulphide, etc. By the addition of this liquor the solution going to the still is kept as nearly uniform in composition as possible. Besides the ammonium salts, this mother liquor contains the sodium chloride from the brine

that is unacted upon, sodium bicarbonate, and small quantities of other salts.

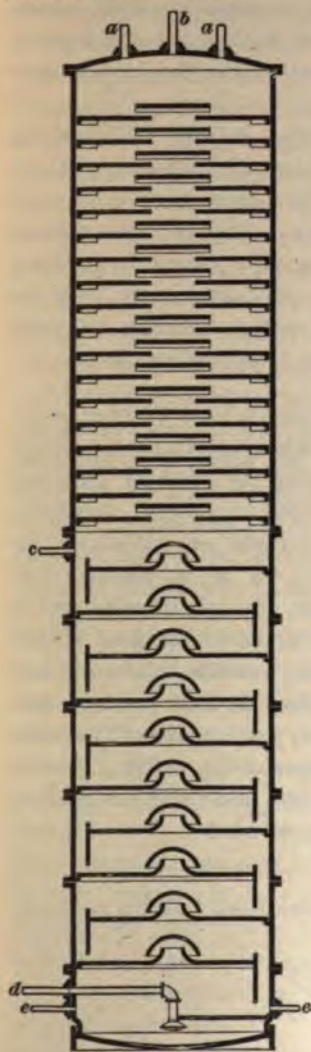

FIG. 10

pipes *a, a*. At *c*, a carefully regulated stream of milk of lime enters and mingles with the descending solution of

The old system of managing this liquor was to use a common still and run in a charge of liquor and a charge of lime and then heat. This has, however, been given up for a continuous system in practically all works of importance. A still of this latter type is shown in Fig. 10.

The lower part is built up of wrought-iron rings and is divided into compartments by iron plates having a hole in the center, which is covered with a hood-shaped piece of iron. The upper part is built up of cast-iron sections, also divided by plates, which serve to break up the liquor as it passes down the tower. The liquor to be distilled comes from the storage tanks and enters the upper part of the distiller at *b* and passes down over the baffle plates, meeting the ascending current of hot gases from the lower part of the apparatus. In this upper half, which is called the heater, the ammonium carbonate is decomposed and driven off, together with the free ammonia. All the gases escape through the exit

ammonium chloride and other ammonium salts. Steam is blown in at *d* through a rose and carries the ammonia set free by the lime into the upper part of the apparatus, where it mingles with the other gases and passes out through *a*. At *e* is the waste-liquor outlet, from which the liquor that is free from ammonia escapes.

The gases from the distiller consist mainly of ammonia and carbon dioxide saturated with water vapor at 80° or 85° C. and must be cooled and dried before they go to the saturators for the ammoniacal brines. This is accomplished by passing the gases through a long pipe coiled in running water. The gas then passes into the saturators and the condensed liquor is returned to the still or sent to a special still along with the condensed liquor from the calciners.

28. Distiller Liquor.—The composition of the liquor running from the distiller is somewhat variable, depending on the quality of lime used in making the milk of lime and on other conditions. It may be stated in general, however, that it contains as magnesium hydrate or oxide all the magnesium that was in the lime, for it is found to be inadvisable to attempt to use little enough lime to utilize the magnesium oxide, and in the presence of lime it will not act. It also contains calcium hydrate, calcium carbonate, and, principally, calcium chloride and sodium chloride. The clear liquor does not vary so much. The clear liquor taken from a series of distillers at the Solvay Process Company's works at Syracuse in 1897, and used for making paper filler, had the following composition:

Constituents	Grams per Liter	Constituents	Grams per Liter
$CaCl_2$	75 to 85	$CaSO_4$	1
$NaCl$	50 to 75	$Ca(OH)_2$	1

In this distiller waste the chlorine of the salt is lost, and in addition it occupies valuable land and pollutes streams.

The pollution of the streams is, however, not to be compared with that from tank waste (see Art. 83), and this waste does not suffer decomposition yielding offensive products, as does the other. The best way to dispose of this waste appears to be to build tight earth walls around an area and run in the waste. In this way the water and most of the substances in the solution leach away; as the lime becomes carbonated, the residue does comparatively little damage. Very many efforts have been made to utilize the waste, or at least to obtain the chlorine contained in it, but they have met with little success. Also numberless methods have been proposed for liberating the ammonia in such a manner that the chlorine would be left in a little more accessible form, but these also are of but little value.

A small amount of calcium chloride produced by this process is used for circulating in pipes in cold-storage and ice machines, and it has also been utilized somewhat in the manufacture of artificial stone. An important use for it would be in the manufacture of paper filler, if there were sufficient demand for the material; but as compared with the calcium chloride produced, the demand for paper filler is insignificant.

29. Ammonia Lost.—When the ammonia-soda process was first tried, 20 and more parts of ammonium sulphate per 100 parts of sodium carbonate were lost, so that it is small wonder that it did not pay. This loss has been considerably reduced, although down to 1890 it was as high as 4 parts of the sulphate per 100 parts of carbonate. It has since been steadily reduced until, in England, in 1897, the loss was about 2 parts per 100, and now in the best-managed works in this country it is without doubt reduced to from $\frac{1}{2}$ to 2 parts per 100. This loss of ammonia plays a very important part in the process, as will be realized if we consider that ammonium sulphate costs about ten times as much as sodium carbonate.

30. Properties of Ammonia Soda.—The sodium carbonate made by this process is remarkably pure, having an approximate composition of

Na_2CO_3	98.40%
$NaCl$	1.28%
Na_2SO_407%
SiO_202%
Fe_2O_3 and Al_2O_301%
$CaCO_3$12%
$MgCO_3$04%

Some purchasers, having become used to the less pure Le Blanc soda, even yet demand that sort of soda ash. This leads the ammonia-soda manufacturer to add salt, or sodium sulphate, or both, to his ash and sell it as a lower grade soda ash. The soda ash made by the ammonia-soda process is of a considerably lower density than that made by the Le Blanc process, so that in equal bulk we will only have about 2 parts by weight of ammonia soda to 3 parts by weight of the Le Blanc soda. For making soda solutions, the lighter soda dissolves more readily, and for this purpose is preferred. On the other hand, the denser soda is much to be preferred for use in furnaces where the charge must be fused, for it is less easily carried away by the fire gases. The denser is also better for packing to ship, as it requires much less space. The light ammonia soda can be concentrated into the more dense form by calcining in a Mactear or reverberatory furnace.

CRYOLITE SODA PROCESS

31. In the southern part of Greenland there occurs a mineral of the composition Na_3AlF_6 , called cryolite, and so far as known, it does not occur in any quantity in any other place. In Greenland, however, it is found in large quantities; the quarry now being worked is 300 feet long by 150 feet wide and 120 feet deep, and shafts have been sunk 120 feet farther without showing any sign of diminution of the supply of material. It can only be mined in the summer, however, and the short season tends to limit the output. This mineral was first considered as a source of soda by Julius Thomsen, a Dane, in the first half of

the last century. He developed a method for working the material, and in 1854 obtained the exclusive right to mine the cryolite and work it up into sodium carbonate and other materials in Denmark. He afterwards sold his right to a company, and in 1865 the Pennsylvania Salt Manufacturing Company obtained the right to two-thirds of all the cryolite mined. At the present time there is one soda works in Denmark using cryolite, but the greater part of the mineral brought down is worked up by the American company at its works at Natrona, Pennsylvania.

The method of working cryolite at the present time is, even to the furnace used, practically that proposed by Thomsen 50 years or more ago. The cryolite is first decomposed by calcining it with limestone, when the following reaction takes place:



32. The calcination of the mixture takes place in the reverberatory furnace, which must be of a special construction, however, for the mixture must be kept at a red heat, but the temperature must not get so high that the mass fuses, for the fused mass is very difficult to lixiviate. The furnace is built with flues under the hearth, so that the charge can be heated from the bottom as well as from the top, and the temperature can, by this means, be carefully regulated.

33. According to the above reaction, 100 parts of the cryolite would require 143 parts of calcium carbonate; but in practice about 150 parts of pure calcium carbonate are used for 100 parts of cryolite, as the excess renders the mixture less liable to fusion and increases its porosity when calcined. Of course, quicklime can be used in place of the limestone, and at Natrona this is partly done. The mix at that place is by weight, 100 parts of cryolite, 20 parts of limestone, and 80 parts of quicklime. A charge for a furnace is 950 pounds of this mixture, and during calcination it loses 75 pounds. A charge of this size requires about 1 hour to finish.

After calcination, the charge is allowed to cool and then lixiviated. A solution of sodium aluminate is obtained, and the insoluble calcium fluoride is left in the tank.

34. Calcium Fluoride.—This is of comparatively little value, although it is used for making hydrofluoric acid and fluorides of the other metals. It is sometimes used by glass manufacturers, but must never exceed 6 to 9 per cent. of the mix, for otherwise too much silica is volatilized and the silicon tetrafluoride acts on the furnace to too great an extent. It is also employed as a flux in certain metallurgical operations.

35. Sodium Aluminate.—The sodium aluminate is carbonated by carefully washed lime-kiln gases; sodium carbonate is left in solution while the aluminum is precipitated as the hydrate. If the carbonation takes place at the ordinary temperature, the aluminum hydrate separates in a gelatinous condition, and it is almost impossible to wash the soda from it. If, however, a suitable higher temperature is selected, the precipitate obtained is granular and can be easily filtered and washed on a filter press. The soda solution is then evaporated and allowed to crystallize. The crystals are sold as such, dehydrated and sold as soda ash, or converted into bicarbonate; they are especially suited for this latter purpose on account of their high purity. Sometimes the soda solution is converted into caustic soda.

The aluminum hydrate is calcined and sold as aluminum oxide for the manufacture of metallic aluminum, or is treated with sulphuric acid for aluminum sulphate or for alum.

SALT CAKE

36. Sodium Sulphate.—Sodium sulphate occurs naturally in Egypt, Spain, and other European countries, while in this country it is found in immense deposits in Wyoming and in some parts of California. It is so extremely cheap, however, and these deposits are at present so inaccessible that

it does not pay to mine them. The native anhydrous sodium sulphate is called *thenardite*; the hydrated, *mirabilite*.

Sodium sulphate was first described by Glauber in 1658, although it was probably known before that time. He prepared it by the action of sulphuric acid on salt and recommended it as a medicine for internal and external use. He gave it the name *sal mirabile*, and later it was called *sal mirabile Glauberi*. The crystallized salt is even yet called *Glauber's salt*.

The manufacture of this substance, which, when artificially prepared, is usually known as salt cake, depends almost entirely on the reaction between sodium chloride and sulphuric acid. The latter may be used ready made or formed at the instant of its action. In the first case, acid sodium sulphate is first formed; afterwards, the normal salt, so that the reactions are:

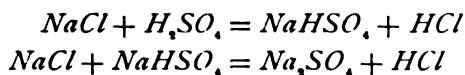

In the second method, instead of sulphuric acid, sulphur dioxide, oxygen, and steam are brought together with the salt, giving the reaction

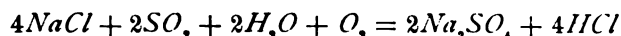

The first method is the older and at the same time the most used process for making salt cake.

• —————

CRUDE MATERIALS

37. Salt.—The kind of salt best suited to the making of salt cake is what is known in this country as cattle salt. The coarse crystals form a spongy mass that readily absorbs the acid and aids the decomposition in this way. The fine-grained, so-called, *table salt* is totally unsuited for this purpose.

The salt as it comes to the works usually contains about 95 per cent. of sodium chloride and about 5 per cent. of water, with other minor impurities.

38. Sulphuric Acid.—The ordinary impurities occurring in sulphuric acid are usually of very little importance in this connection. When the salt cake is to be used for glass making, the iron in the acid should be kept as low as possible, and arsenic, on account of its getting into the hydrochloric acid, is sometimes objectionable. The concentration of the acid should be 60° or 60.4° Baumé. Weaker acid is not good on account of its acting strongly on the decomposing pans, causing slow work and weak hydrochloric acid. Acid as weak as 55.5° Baumé may be used, although it is undesirable, and weaker than this should never be tolerated. An acid stronger than 60.4° Baumé, on the other hand, causes a too rapid evolution of the hydrochloric acid.

APPARATUS AND METHOD OF MANUFACTURE

39. The apparatus used in the manufacture of salt cake varies considerably in detail, but according to its essential features may be divided into *open roasters*, *blind roasters* or *muffles*, and *mechanical furnaces*.

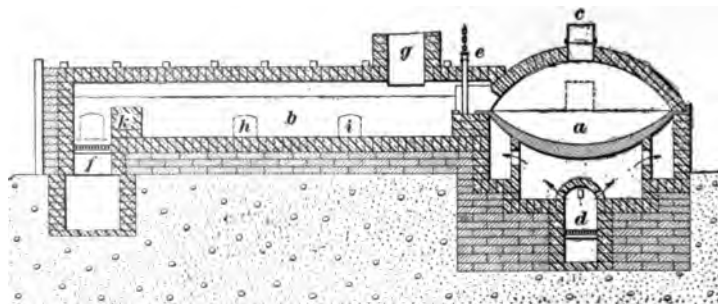

FIG. 11

40. Open Roasters.—The open roaster shown in Fig. 11 consists of two parts, the *pan a* and the *roaster b*.

41. The Pan.—Since the pan must stand the action of sulphuric acid, it was at first assumed that it must be made of lead, but this material has the decided disadvantage of soon wearing out by the action of the tools used in mixing

the salt and acid, and in transferring the product to the roaster *b*. A very low and carefully regulated temperature must also be employed on account of the low melting point of the lead. Lead has, therefore, been almost entirely discarded in favor of iron for pans, although even now, where it is desired to make a salt cake very free from iron, lead pans are used. The iron pans are from 9 to 11 feet in diameter and from 1 foot 9 inches to 2 feet 6 inches in depth. They are made about 6 inches thick on the bottom and taper to about 2 inches at the edge, and are covered with a brick arch with an outlet pipe *c* for the escape of the hydrochloric acid. The pans are supported by their edges by supporting walls, and are heated by direct fire from a grate *d*, which is covered by a section of an arch to spread the flame and prevent overheating in one place and so burning the iron. Since the pans are heated nearly or quite to redness, when the batch is transferred to the roaster and, in rapid work, a new charge of, possibly damp, salt introduced before the pan has cooled very much, they must be able to withstand considerable temperature changes, as well as the action of the acids.

Between the pan and the roaster is a slide *e*, which is best made of two thin sheets of iron placed a few inches apart with a packing of salt, to keep the hydrochloric acid from the pan separate from that of the roaster. By this means the condensation of the pan acid is easier and a much purer acid is obtained than would be gotten from the mixed gases. The connection between the pan and roaster is only kept open long enough to permit of the transfer of the batch of salt cake.

42. Management of the Pan.—Salt to the amount of from 500 to 1,000 pounds, depending on the preference of the management, but usually 800 to 900 pounds, is shoveled into the pan through the working door, and then enough sulphuric acid, of 60° to 60.4° Baumé (taken cold), having been previously heated, is run in through a pipe in the cover of the pan and the mixture heated.

The amount of sulphuric acid used is naturally regulated by the charge of salt and the moisture in the salt. Theoretically,

every 58.5 parts, or pounds, of salt should have 49 parts, or pounds, of sulphuric acid H_2SO_4 ; that is, every 100 parts, by weight, of $NaCl$ requires 83.75 parts, by weight, of H_2SO_4 . Sulphuric acid of 60° Baumé is 78-per-cent. H_2SO_4 , and therefore 100 parts of $NaCl$ requires 107.37 parts of sulphuric acid of 60° Baumé. Since, however, the salt used is only about 95 per cent. $NaCl$, the amount of 60° Baumé acid will be 102 parts, by weight, for every 100 parts, by weight, of salt. Some allowance must, however, be made for loss of sulphuric acid, by volatilization, in the pan and roaster, so that in most works, for making strong salt cake, about $2\frac{1}{2}$ parts, by weight, of sulphuric acid in excess of the amount calculated is added for each 100 parts, by weight, of salt. The practice, then, is to add 104.5 parts, by weight, of 60° Baumé sulphuric acid to each 100 parts, by weight, of salt charged. If weaker acid is used, the calculation of the amount of acid can be carried out in the same way.

The charge of acid is never weighed, but is measured so that it must be added each time at the same temperature. The salt and acid are analyzed daily in the laboratory and tables are furnished the pan man, so that by determining the specific gravity of the acid coming to him, at a constant temperature, he can easily determine the amount of acid to add. The best temperature for the acid is a matter of opinion, but it should never be below 50° C., while some use it at nearly 100° C. The hotter the acid, the less it acts on the pan; but with too hot acid, the hydrochloric acid is given off too rapidly and it is difficult to condense it, while a thorough mixing of the batch is almost impossible. An acid of about 60° C. is considered the best.

Under the best conditions of working, the batch in the pan foams badly and has a tendency to foam over. This difficulty can be quite largely met by adding a small piece of paraffin as soon as the sulphuric acid is run in.

As soon as the acid is added to the salt the mixture is thoroughly stirred by the pan man, for which purpose he uses a long-handled iron rake inserted through a hole in the working door. At best, considerable hydrochloric-acid gas

escapes during this operation, but by heaping salt about the handle of the rake where it passes through the door, the escape of the gas is reduced as much as possible. When the mixture has been brought to the consistency of thin mud and all the lumps of salt have been broken, the rake is withdrawn and the door closed as tightly as possible by piling salt against it. The door itself is made of slate or of lead-covered cast iron and is set in a frame of acid-resisting stone. The workroom should be thoroughly ventilated to relieve the workmen, so far as possible, from the inconvenience of the acid that unavoidably escapes.

In this operation in the pan, the first half of the reaction takes place and, theoretically, 50 per cent. of the total hydrochloric acid is evolved. Practically, the heating of the pan is continued until about 70 per cent. of the total hydrochloric acid is given off, for it is advisable to have as much of the hydrochloric acid evolved in the pan as possible. The pan hydrochloric acid is purer and easier to condense than that from the roaster. The batch in the pan is considered finished when the mixture offers considerable resistance to the moving backwards and forwards of the rake, owing to the stiffness of the mass. The finishing of the batch then requires a higher heat than can be obtained in the pan. Assuming the roaster bed to be empty, at a bright red heat, and the batch in the pan finished, the slide *c* is raised, the pan door opened, and the pan man, by means of a long-handled, spoon-like shovel, transfers the charge to the roaster, where it is at once spread out evenly by the roaster man. There is always a tendency for the acid salt cake to stick to the pan, especially if it is not set so as to be evenly heated. This is best remedied by care in setting the pans so that the heating will be uniform; where such cakes do form, they should be removed before adding a new charge, otherwise the pan is very likely to crack.

43. Open Roaster.—The open roaster *b*, shown in Fig. 11, consists of a shallow basin from 12 to 15 feet long and narrow enough for the batch to be handled by the workmen

using long-handled hoes. It is simply a form of reverberatory furnace and is lined with carefully placed firebricks. The material is heated by direct flame from a coke fire on the grate *f* and the products of combustion, together with the hydrochloric acid, escape through the pipe *g*. Since all the fire gases mix with the hydrochloric acid in the open roaster, it is very much diluted and its complete condensation to a strong acid solution is very difficult.

44. Management of the Roaster.—The batch is spread evenly over the bed of the roaster and at intervals of from 10 to 15 minutes must be turned over and all lumps broken. For this purpose the furnace man uses a wrought-iron rake and a bar of wrought iron flattened at the end into a blade. The tools are introduced into the furnace through the doors *h* and *i*, and are suspended from hooks hanging from the ceiling in front of the furnace door. By thus suspending the tools, part of their weight is taken off from the furnace man, but the work is hard and disagreeable at best. The furnace must be kept hot to get the batch off as quickly as possible, but it must not be allowed to get too hot or the batch will flux. A small amount of fluxing can be taken care of and the lumps broken, but if it once gets ahead of the furnace man, especially next the fire-bridge *k*, it is almost fatal to the charge, for it cannot be controlled and the salt cake is then almost useless for the black-ash furnace. The way to avoid this fluxing is to carefully watch the fire.

The furnace work is finished when no more vapors are given off, even on turning the batch and when it is quite red hot, but it must never flux at any point. The salt cake is then drawn by means of wrought-iron hoes into steel barrows and carried to the storeroom. The hydrochloric acid given off in the open roaster is mixed with the gases and dust from the grate, so that its condensation to a strong acid is difficult and there is danger of the condensers becoming stopped by the dust. To obviate this difficulty, the *blind*, or *muffle*, roaster has been adopted by many manufacturers.

45. Blind, or Muffle, Roaster.—This roaster employs a pan of practically the same dimensions and setting as the open roaster, and it is sometimes heated by the waste gases from the muffle heating. It is better, however, to heat it by its own fire, as in the preceding case, for although it saves some fuel when waste heat is employed, direct firing makes the working of the pan independent of the muffle, which is in many cases a decided advantage. The essential difference between this method and the preceding one is in the roaster. Here, instead of having the batch heated by the direct fire, with its numerous disadvantages, the batch is brought into a closed muffle and heated by the heat conducted by the muffle walls from the outside flues. The muffle walls are made of brick and must be quite thin, or it will not be possible to get the charge sufficiently hot. Since the walls are thin, they are liable to be damaged by the tools used in working the material, or they may crack on account of the temperature changes. Since the pressure inside the muffle is greater than on the outside, if such a crack forms, large quantities of hydrochloric acid may escape into the chimney gases and great damage be done before the leak is discovered. These difficulties led Deacon to devise his *plus-pressure furnace*.

46. Deacon's Plus-Pressure Furnace.—In the muffle roaster just described, the fire-grate is nearly on the same level as the muffle, and a draft is produced by means of a chimney; so that necessarily the flues about the muffle are under diminished pressure, while, on account of the acid-absorption apparatus, the acid in the muffle is under greater pressure than the atmosphere. The result of this is, therefore, that if there is a leak in the muffle, the hydrochloric acid will escape into the chimney. Deacon reverses this condition, not by diminishing the pressure in the muffle, but by increasing the pressure in the flues by putting the fire-grate *a*, Fig. 12, much lower than the muffle *c*. The hot gases rising in the vertical flue to the muffle flues *b, b*, produce a pressure on the latter, so that if there is a leak in

the muffle, the flue gases go in and do comparatively little harm. It is practically putting the muffle at the top of the chimney instead of at the bottom, as in the other style. As shown in the illustration, the fire gases rise from the grate *a*, pass over the muffle and then through a series of flues on the under side of the muffle, and finally go to heat the pan or go direct to the chimney, as the manufacturer prefers.

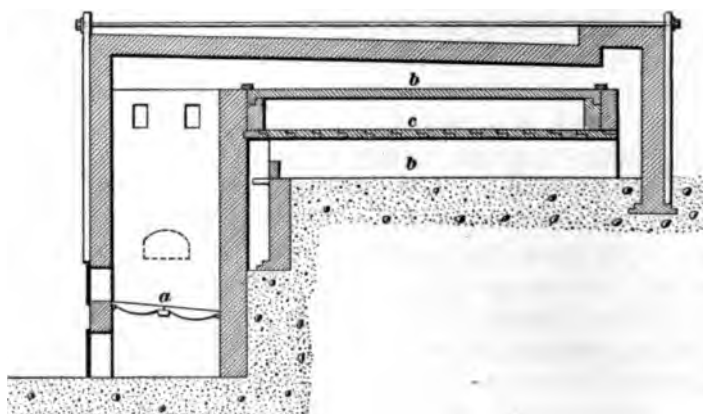

FIG. 12

47. All that has been said about the working of open roasters applies equally well to the muffle furnaces. The heating of the whole furnace bed is more uniform and the danger of overheating is not so great.

The advantages of the two styles of roaster may be summarized as follows: The open roaster works more rapidly because the charge can be got hotter, and therefore gives a large yield of salt cake. For the same reason, it is possible to make a stronger salt cake, i. e., one containing a higher percentage of normal sodium sulphate. Less repairs are needed, and it is impossible for the acid to accidentally escape anywhere except through the condensers. The muffle roaster, on the other hand, makes possible a better condensation of the hydrochloric acid, and therefore produces a cheaper and stronger acid. It requires less acid per unit of salt, and coal, instead of the more expensive

coke, can be used for firing. More fuel is required, however, so that the last item probably does not represent

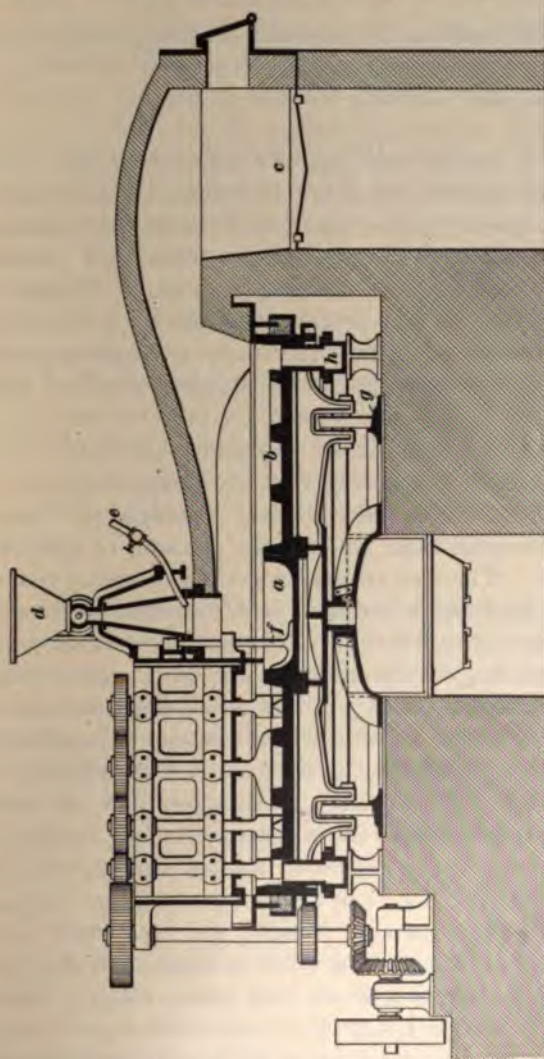

FIG. 13

much saving. The advantages of the two systems are so evenly divided that some firms prefer one system and

some the other, so that the two systems are about equally used.

48. Mechanical Furnaces.—In the preceding methods of working, the batch must be transferred from the pan to the roaster and carefully worked to prevent the leaving, in the finished product, of lumps of salt unacted upon. It requires a certain amount of skill to do this properly, and so the manufacturer is to a certain extent in the hands of his workmen; furthermore, every time the furnace door is opened, acid gas escapes into the room and produces an unhealthy atmosphere for the workmen. These considerations have led to various attempts to perform all this work mechanically, but the only arrangement that is commercially successful is the Mactear furnace, shown in Fig. 13.

This furnace consists of the pan *a* in the center of the movable hearth *b*, and is heated by the gas from the grate *c*. The salt is fed in continuously through the hopper *d*, and at the same time the proper amount of acid flows in through *e*. The two substances mix and partly react in the pan, and then the mixture is slowly worked over on to the hearth by the stirrer *f*. The hearth revolves on small wheels running on the tracks *g*, and by this motion and the stirrers extending from *f* to the outer edge and turned by the outside cogs, as shown, the charge is worked to the outer edge by the time the reaction is completed. The salt cake then flows into the annular trough *h*, by means of which it is conducted from the apparatus. All the joints of the apparatus are closed by aprons dipping into lutes of molten sulphate, but even this does not altogether protect the outside from the acid fumes.

These furnaces have the advantages that they do away with a large amount of manual labor, yield a continuous product, and allow the hydrochloric acid to be more easily condensed, for it comes in a continuous, uniform stream, while in the hand furnace the evolution of acid is variable. But they have the disadvantage that the hydrochloric

acid cannot be made so strong as with hand work, and the machinery is expensive and requires a large amount of repairs. These disadvantages have restricted the use of this furnace, so that probably not over 15 per cent. of the salt cake made at the present time is made by them.

49. Yield of Salt Cake.—The yield of salt cake will naturally differ in different works and with different apparatus, but the amount that may be expected with good work, etc. will be about as follows: 100 parts, by weight, of pure salt should, theoretically, yield 121.5 parts, by weight, of salt cake. As already pointed out, the salt used rarely contains over 95 per cent. of sodium chloride; and, of course, this must lower the yield of salt cake. If, however, we adopt the rational method of calculating the percentage yield on the sodium chloride actually used, the yield should be very nearly theoretical. Works are in operation that produce 121.2 parts of salt cake for 100 parts of pure chloride used.

50. Properties of Salt Cake.—A good quality of salt cake should be finely granular and yellowish white, or better, pure white in color. A deep yellow or reddish-brown color shows much iron, while a dirty-gray color indicates incomplete decomposition of the salt. The salt cake should not contain over 1 per cent. of free sulphuric acid, nor more than .6 per cent. of sodium chloride. When intended for use in glass manufacture, the iron should not exceed .2 per cent. Fe_2O_3 .

51. Uses for Salt Cake.—Sodium sulphate is most largely used in making sodium carbonate by the LeBlanc process. It is also used in making glass and ultramarine, and in dyeing and coloring. It finds a smaller use in making sodium acetate and other sodium salts from the corresponding calcium salts, and the crystallized sodium sulphate (Glauber's salts) is used in medicine.

SODA BY THE LE BLANC PROCESS

52. **Le Blanc's process** for making sodium carbonate from salt consists in first making sodium sulphate, as already described, and then converting this into sodium carbonate by fusing the sulphate with a mixture of calcium carbonate and carbon. De la Métherie had previously proposed heating sodium sulphate with carbon to reduce it and convert it into the carbonate, so the point especially made by Le Blanc was the introduction of calcium carbonate into the mixture, and this was the important step that made the process a commercial success.

The process comprehends the starting with sulphur in its elementary form, or the much less valuable iron pyrites, with calcium carbonate, carbon, and sodium chloride as raw materials, and ending with the sodium as carbonate, the chlorine free or as hydrochloric acid, the calcium carbonate as when starting, and the sulphur free, so that the only material used up is the carbon, and there are no by-products. It is not possible to realize this condition entirely, however, and it is only comparatively recently that it has been possible to recover the sulphur commercially.

This round can be represented by the following reactions:

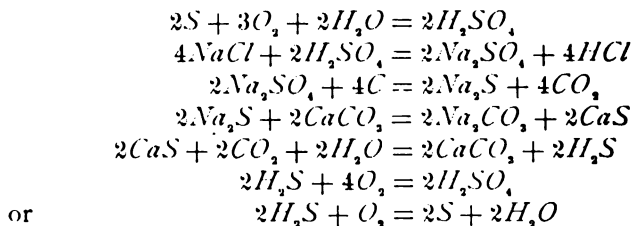

Or, combining them, we get

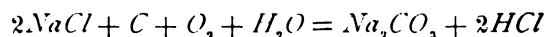

That is, theoretically, for 117 parts, by weight, of salt, only 12 parts, by weight, of carbon are required to convert it into sodium carbonate and hydrochloric acid, which makes it apparently a cheap and simple process. The practice is, however, not nearly so fine, for actually 400 to 500 parts of

carbon are required to every 117 parts of salt. In addition to this, there is a large amount of money invested in the plant and constantly required for labor and repairs; besides, the reactions do not go as smoothly as represented.

53. The reaction that takes place when carbon, sodium sulphate, and calcium carbonate are fused together has been the subject of almost endless discussion, especially with regard to the calcium compound, for it is well known that an insoluble calcium sulphide is not formed with either hydrogen sulphide or ammonium sulphide; therefore, it was long held that the calcium compound formed in the above must be an oxysulphide CaO, CaS . It is impossible to go into a discussion of this subject, but it may be taken as definitely settled that the reactions take place practically as represented above, the calcium sulphide formed being insoluble. At the end of the operation the reaction

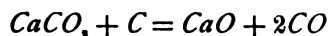

begins, and serves as a signal for the withdrawing of the charge, for the carbon monoxide comes up through the material and burns with long, pointed flames, called *candles*, and thus indicates that the transformation is complete. This reaction continues for a long time after the charge is withdrawn and while it is cooling, so that the escaping gas leaves the material porous, and for that reason much easier to lixiviate in a later stage of the work.

RAW MATERIALS

54. Sodium Sulphate.—As the preparation of salt cake has already been described, we will avoid repetition by considering it here as one of the raw materials. The sodium sulphate should be fine and porous, not fluxed, and should contain 96 or 97 per cent. of sodium sulphate. It is better if it contains a little free acid, as this lessens the probability of its containing much salt. The acid should not, however, exceed 2 per cent., and the salt not over $\frac{1}{4}$ or 1 per cent.

55. Calcium Carbonate.—The calcium carbonate is usually chalk or high-grade limestone. All impurities are bad, and magnesium and silica are especially so because they form insoluble compounds containing sodium and so cause a loss of sodium compounds. The limestone is crushed to the size of a pea or bean before being used, but does not need to be fine, and is better if not too fine. Caustic mud (see Art. 97) and calcium carbonate from the sulphur recovery (see Art. 82, *et seq.*) are also sometimes used, but they are so light that they do not flux well.

56. Carbon.—The carbon is supplied in the form of powdered coal, which should be low in ash, not over 7 per cent. being allowable, and one that gives a high yield of coke. The presence of a moderate amount of pyrites does not interfere, but the less nitrogen present the better, for it leads to the formation of cyanides, cyanates, and ferrocyanides, the latter introducing iron into the ash.

DETAILS OF THE PROCESS

57. The mixture varies considerably in the proportions of the constituents, probably partly on account of impurities in the coal and limestone, but even taking that into account there is a wide variation, each works using the mix that it considers gives the best result. The theoretically correct proportions can, of course, be calculated from the reactions given in Art. 52. Leaving out the reaction

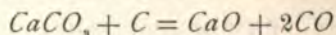

the proportion will be 100 pounds of salt cake, 70 pounds of calcium carbonate, and 17 pounds of carbon; taking this reaction into account, it will be approximately 100 pounds of salt cake, 75 pounds of limestone, and 20 pounds of carbon. In practice much more coal is required, for some of it burns and some is left in the product. On account of this coal that remains in the flux, the fused mixture is black and is called *black ash*.

In the hand-worked furnaces about an average mixture is 100 pounds of salt cake, 98 pounds of good limestone, and 48 pounds of coal, but in the mechanical furnaces, which are now largely used, the charge is frequently cut down to as low as 100 pounds of salt cake, 80 pounds of limestone, and 30 pounds of coal.

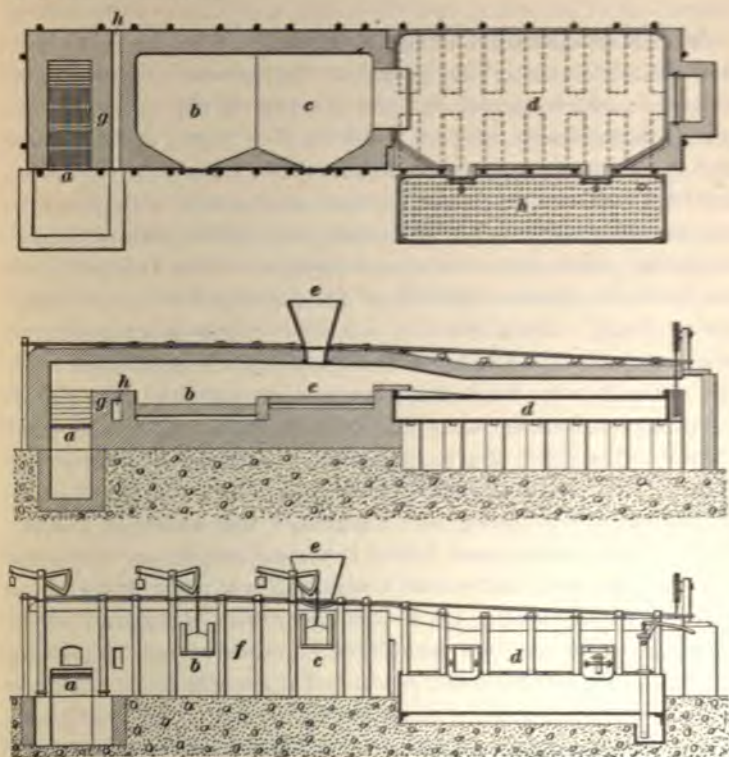

FIG. 14

58. Hand Furnaces.—These are simply reverberatory furnaces adapted to this special purpose. Fig. 14 shows a front elevation and vertical and horizontal sections of one of these furnaces. The fire-grate is at *a* and the hot gases pass over the bridge *g* on to the bed of the furnace *b c*, which is divided into two sections, and then over the liquid

to be evaporated in the pan *d*. The fire-bridge *g* is built with a flue *h*, which permits the air to circulate freely, thus keeping the bridge cool and retarding its burning out. The bed of the furnace is usually about 15 feet long by 7 feet wide, and a charge of about 700 pounds, more or less, of the mixture is worked at a time.

59. Management of the Furnace.—The charge is first introduced on to the back half of the furnace, through the hopper *e*, and is spread out and allowed to get hot and dry, being occasionally turned. When it is thoroughly heated and the front part of the furnace is hot, the charge is transferred to this part of the furnace and a new charge introduced in the back. The principal part of the making of the black ash takes place on this front bed of the furnace, and here also the work and skill of the furnace man comes into play. Very soon after the mixture is brought on to the working bed of the furnace it begins to melt in places; then the furnace man must turn the mixture so that the melted portion of the material is turned under and the under part comes to the top. By working the mixture in this way, the furnace man must gradually thoroughly mix the whole mass of material and bring it to a rather soft state of fusion. This requires an almost white heat, and to get up the temperature as well as to rest himself, the furnace man up to this point only works for a few minutes at a time and then closes the furnace door for about 10 minutes before mixing again. The chemical action only begins when the mixture is in a state of pasty fusion (it never gets past the pasty stage), and when this condition is reached the reaction must be finished as quickly as possible. The furnace man is busy from now on, stirring and mixing the mass and working it towards the door of the furnace. When the reaction is completed, flames of carbon monoxide, colored yellow by the sodium (so-called candles), will appear and the black ash is then worked out into a barrow. The proper time must be selected for "balling" together and withdrawing the charge, for otherwise it will be underdone or overdone. If not

allowed to remain in the furnace long enough, it will contain unchanged sodium sulphate, and also be dense and hard to lixivate; when in this condition it is called *soft ball*, for the last reaction, which gives the gas and causes the porosity, has not had an opportunity to start. On the other hand, if left too long, the gas of this last reaction will escape while the material is still in a soft condition and it will then settle into a hard mass, *burned ball*, which is difficult to lixivate. Under proper working, however, the material is balled together when candles appear, and it is brought into an iron barrow, where, by the continued action between the carbon and the limestone, gas continuously escapes as the material cools, and so leaves it porous; the slaking of the lime so formed assists in the lixiviation. The principal difficulties occurring in the black-ash furnace are the forming of these "soft" or "burned" balls, and the avoiding of them depends almost entirely on the furnace man. The way to avoid them is to have the furnace hot, keep the batch well mixed, and to bring the temperature well up at the end of the work; then, with proper judgment as to the time to withdraw the charge, good results are not difficult to obtain.

60. Mechanical Furnaces.—Although the tools are suspended by chains and hooks, the continuous handling of them at the high temperature that exists is very hard for the workmen, and much depends on the good will of the workman to get a good result. For these reasons, and to save the cost of the expensive hand labor, mechanical furnaces are very desirable. The first furnaces of this kind that were tried were very expensive to operate on account of the frequent repairs made necessary by the great wear and tear. Furthermore, it was difficult to watch for the candles and draw at the proper time to avoid overburned ash. The excessive repairs were finally done away with by adopting a barrel-shaped furnace, shown in Fig. 15, which revolves around its long axis. The furnace proper *a* consists of an iron shell lined inside with firebricks. The shape is that of a barrel; it either conforms to the

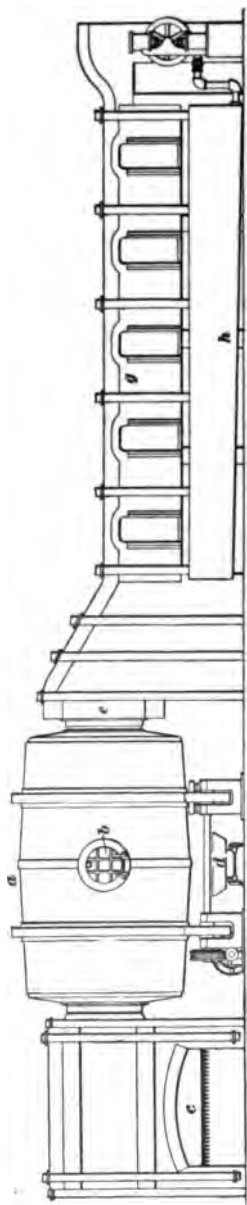

FIG. 15

outside shell, or, if that is cylindrical, the bricks are laid thicker at the ends than in the middle. Two rows of these lining bricks are laid higher than the rest, to break up the mass and mix it, and also to better expose it to the fire gases as it drips from these projections. These furnaces are from 15 to 30 feet long and average about 6 feet in diameter at the ends, and from 10 to 12½ feet in the middle; they are heated by the fire gases, which pass in at one end and out at the other. The furnace is heated by the gases from the grate at *c*, or sometimes by producer gas, although for some reason this latter does not seem to be much used. The hot gases pass into *a*, where they bring about the conversion of the salt cake into black ash, and then pass out through *c* to *g*, where they pass over the top of pans containing the liquor from the lixiviation of black ash and evaporate it. At *b* is shown the manhole through which the black-ash mixture is introduced, and from which, at the end of the process, the black ash is discharged into the wagons *d*. The draining pan for the black salts is shown at *h*.

61. Charge for the Mechanical Furnace.—The theoretical charge for the mechanical furnace

will naturally be the same as already calculated for the hand furnace, and the same conditions of water and impurities in the limestone and coal rule here. It is found, however, that there is less burning of the mixing coal and less mechanical loss of the constituents of the mixture, so that not so large an excess over that theoretically demanded is now used for the mechanical furnace. The average proportions of the constituents of the black-ash mixtures to be used with a mechanical furnace are 100 parts of salt cake, 82 parts of limestone, and 30 parts of good coal. The size of the charge will naturally vary with the size of the furnace, but an average charge is from $1\frac{1}{2}$ to 3 tons of the mixture.

62. Management of the Mechanical Furnace.—The operation consists in charging in all the limestone and about two-thirds of the coal, without drying. The cover is then put on and the cylinders slowly revolved (about 1 revolution in 3 to 4 minutes) until the appearance of a bluish flame of carbon monoxide around the manhole shows that at least a part of the limestone has been converted into lime. As soon as this operation is completed, which requires from 1 to $1\frac{1}{2}$ hours, the cylinder is turned so that the charging hole is up and the finely ground salt cake and the coal are dumped in. The cover is then replaced, the draft through the cylinder diminished, and the slow turning resumed. After about 15 minutes, the mixture is hot enough so that the danger of carrying away parts of the mixture is not so great and the draft is restored; in a few minutes, the appearance of a bright yellow flame around the manhole shows that a part of the charge is becoming fused. The rate of revolution of the cylinder is then brought up to 3 or 4 revolutions per minute. The charge is now watched through peep holes and when yellow flames (candles) are seen to break from it, it is time to stop. The furnace is now revolved a few times as quickly as possible to bring the mass together. It is then turned so that the charging hole is up, the cover is removed, and the furnace turned so that the charge runs out into the wagons *d*. If the furnace is

worked properly, the gas should continue to be given off while the material is in the barrows and thus a porous black ash is produced.

In some works the method proposed and patented by Mactear is adopted. This consists in making a mixture of, say, 100 parts of salt cake, 73 parts of limestone, and 40 parts of coal. This mixture is put together into the furnace and the reaction brought to an end, as shown by candles, then from 6 to 10 per cent. of the weight of salt cake, of quicklime, and from 14 to 16 per cent. of furnace cinders are added and the furnace turned quickly two or three times to thoroughly mix the materials and then the whole run out. This method saves considerable time in working, as the preliminary conversion of a portion of the limestone into lime is saved, and the material is left in a condition considered by many to be the best for lixiviation.

63. Advantages and Disadvantages of the Mechanical Furnace.—The mechanical furnace has the advantage over the hand furnace that it makes the manufacturer more independent, as the only skilled man needed is the foreman, and he can tend to several of these furnaces. It gives a large output with a comparatively small amount of manual labor, and at the same time a more uniform material is obtained.

On the other hand, the revolving furnaces are expensive to build, and as frequent repairs are necessary, they are expensive to maintain.

64. Cyanides.—One of the most disagreeable impurities occurring in black ash is the sodium cyanide formed from the nitrogen in the coal. This cyanide will unite with iron, if opportunity is offered, and make sodium ferrocyanide, which it is very hard to remove from the solution, but which decomposes at the end, when the soda ash is calcined, into sodium carbonate and ferric oxide, coloring the soda ash. In the hand furnaces, usually no attempt is made to remove the sodium cyanide from the black ash, but for mechanical furnaces the Pechiney-Weldon method works

nicely. This process depends on the fact that when sodium cyanide is fused with sodium sulphate the cyanide is decomposed. It is not known exactly what the reaction is, but probably the following equation very nearly expresses the truth:



The operation consists in adding a little salt cake to the first finished black ash in the furnace, giving the furnace a few turns to mix the charge thoroughly, and then discharging the black ash at once into the barrows. The amount of salt cake required must be determined for each furnace and mixing coal, as the amount of cyanide will vary as these conditions vary. As there is no time to analyze the black ash just before adding the salt cake, a fixed amount must be decided upon and then added to each charge of ash. This is best done by determining the amount of cyanides in several charges of black ash from a furnace, averaging these, calculating the amount of salt cake necessary by the above equation, and then adding from four to six times the theoretical amount to the charge each time just before emptying the furnace, as above stated. For example, if an average analysis shows $\frac{1}{2}$ per cent. of sodium cyanide, there will be $\frac{1}{2}$ pound of sodium cyanide in 100 pounds of the mixture, and from the equation

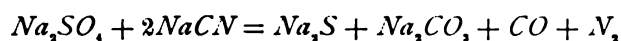

we have $142 : 98 = x : .5$; or, theoretically, it will require .72 pound of sodium sulphate. It is not very easy to get material of this character in extremely close contact, however, so the excess is necessary, and if we select six times the theoretical amount, we should add 4.32 pounds of salt cake for every 100 pounds of the mixture used. This is rather an extreme case, as usually the cyanide will not run so high.

Another method for attaining the same end, and one that is much preferred by many manufacturers, consists in adding regulated amounts of salt cake to each furnace charge

until the amount is found that gives the most satisfactory result.

So far nothing has been said concerning the excess of salt cake added, and we might naturally consider that there would be excess of lime and coal enough in the black ash to convert it into sodium carbonate, and no doubt there is. It has been found better practice, however, to add about an equal weight of finely ground limestone to the salt cake used before adding it to the mixture in the furnace.

A mixture that has given good results with this process is salt cake, 100 parts; limestone, 78 parts; coal, 37.5 parts; and as a final addition, a mixture of 6 parts of salt cake and 7 parts of powdered limestone.

65. Properties of Black Ash.—A good black ash from a hand furnace should have on the fracture a brownish black or dark slate-gray color, and a porous, pumice-like structure. It should be uniform in appearance throughout the ball and should not have many black spots of coal or white ones of limestone. Balls that are pale pink or reddish are usually also dense and burned, and will be found on analysis to be high in sodium sulphide and sodium sulphate. Each man's work for the day should be tested in the laboratory for, at least, total alkali, sodium sulphide, and sodium sulphate.

Black ash from a mechanical furnace appears quite different from that from a hand furnace, being dense and of a higher color. It would be almost impossible to lixiviate this ash were it not for the free limestone contained in it, which, on slaking, breaks up the pieces of black ash, so that the water can get at it to dissolve out the sodium carbonate.

66. Composition of Black Ash.—Black ash naturally varies somewhat in composition, but usually has about 40 per cent. of soluble matter, consisting of the carbonate, oxide, chloride, sulphate, sulphite, thiosulphate, aluminate, silicate, cyanide, and sulphocyanide of sodium; while the insoluble portion consists mainly of the sulphide, carbonate and oxide

of calcium, ferrous sulphide, aluminum oxide, silica, magnesium oxide, carbon, sand, and insoluble sodium compounds of aluminum and silicon. Of course, sodium carbonate, calcium sulphide, and calcium oxide are the preponderating substances.

67. Lixiviation of Black Ash.—The black ash when removed from the furnace is very hot and must be allowed to lie and cool until it can be conveniently broken and handled. This usually requires about 2 days. It should not, however, be allowed to lie longer than is necessary, for the moisture, carbon dioxide, and oxygen of the air act upon it. The carbon dioxide converts the lime into calcium carbonate, and the calcium sulphide into calcium carbonate and hydrogen sulphide. The oxygen converts calcium sulphide to calcium sulphate and various intermediate oxidation products. Finally the moisture aids in the formation of sodium sulphate, sulphide, etc., from the calcium salts and sodium carbonates, and thus causes a loss of the valuable sodium carbonate.

Various difficulties must be overcome in the lixiviation; for the lime is slaked and tends to react with the sodium carbonate, as above, while the calcium sulphide also reacts to form the sulphide of sodium. This takes place especially rapidly if the solution is hot and dilute. Furthermore, the oxidation of the calcium sulphide to sulphate and then a reaction between that and the sodium carbonate takes place here as well as in the preceding case, unless the material is protected from the air. It is necessary then to lixiviate away from the air as rapidly as possible and to keep the liquid cold. These last two conditions seem to be and are directly opposed to each other, but the temperature is selected that will give the most rapid extraction with the least trouble in other directions.

68. Shank's Lixiviation System.—This system for lixiviating the black ash has practically displaced all other systems, as it is rational, simple, and efficient. The lixiviating apparatus consists of one large tank divided into from

four to eight water-tight compartments. Each compartment has a false bottom of perforated sheet iron, which serves to support the lumps of black ash and acts as a filter for the solution of sodium carbonate. A pipe leads from under the false bottom of each section of the apparatus to near the top of the other sections, so that the different sections may be connected together at will; each section has a pipe for supplying fresh water when necessary. Frequently they are fitted with steam connections as well, so that the liquid may be warmed, if desirable.

In working, the water or dilute lye flows in at the top of the section, and as it dissolves more material it becomes heavier and sinks to the bottom of the tank; it is then forced into the next tank by the fresh incoming lye; this process is continued until it finally flows away sufficiently concentrated. The pipes are so arranged that the contents of the various tanks are always completely covered. The process is continuous, the water flowing into the tank containing the most nearly extracted black ash and flowing away from the last and most recently charged tank as long as the specific gravity does not fall below 1.25. As soon as the specific gravity of the lye from the last tank falls below 1.25 it is turned into a tank recently filled with new ash and the exhausted ash is washed with water until the wash water has a specific gravity of only 1.005. Then the waste is sent to the dump and the tank is freshly charged to serve as the end tank in its turn. The best temperature for lixiviation to give concentrated solutions is about 50° C., which is usually reached by the heat from the slaking of the lime when the lye comes in contact with the fresh ash. If this does not occur, the temperature can be raised by blowing in steam. In the first one or two tanks of the series, where the lye is weak, the temperature is not allowed to get below 35° C. The black ash, as can be shown by extracting with alcohol, contains no sodium hydrate or sodium sulphide, the lye obtained from its lixiviation contains not only these substances, but various other soda compounds formed by interchange during the lixiviation.

Although the composition of the various lyes differs considerably, depending on the conditions of lixiviation, etc., the following analysis of a lye of 1.25 sp. gr. will give an idea of the general character of such solutions. The solution contained 313.9 grams of solid substance per liter, and the solid had the following composition:

Sodium carbonate ..	71.30%	Sodium sulphate.....	.24%
Sodium hydrate	24.50%	Sodium cyanide.....	.09%
Sodium chloride....	1.90%	Alumina.....	1.51%
Sodium sulphide....	.10%	Silica.....	.19%
Sodium thiosulphate	.37%	Iron.....	traces

69. Purification of the Lye.—The lye contains considerable finely divided suspended matter, and is therefore allowed to stand for a time in a warm place to allow it to settle and become clear. The iron compounds if left in the lye would decompose at a later stage of the process and color the ash. The sodium ferrocyanide may be decomposed by heating the lye to 180° C., the following reaction taking place between the sodium ferrocyanide, sodium thiosulphate, and sodium carbonate:

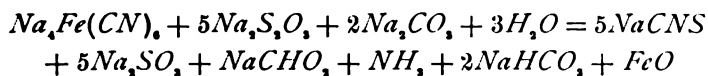

This method is, however, difficult and expensive, so that it is far better to use the Pechiney-Weldon method and so exclude the ferrocyanide from the black ash, and thus from the lye. The iron sulphide may be separated by allowing the lye to stand exposed to the air, when the iron sulphide slowly separates out. This method is slow, however, and it is better and more usual to allow the lye to flow down ropes and chains in tall towers, up which are passing carbon dioxide and oxygen from the black-ash furnaces or from lime kilns. By this means the caustic soda is carbonated, forming sodium carbonate; the iron is precipitated, and the sodium sulphide is converted into sodium carbonate with the liberation of the hydrogen sulphide. This last reaction is not complete under practical conditions, so that sometimes

zinc hydrate is mixed with lye at this point to complete the removal of the sodium sulphide.

70. Paull's Method.—This method for purifying the tank liquor consists in mixing it with a little Weldon mud (see *Alkalies and Hydrochloric Acid*, Part 2) and then blowing in air and steam until the sodium sulphide is thoroughly oxidized and the iron, silica, and alumina are precipitated; about 2 pounds of manganese dioxide to every 100 pounds of sodium carbonate in the solution is a suitable proportion, although sometimes a smaller amount of the manganese dioxide will work very well.

If, for the sake of convenience, we consider Weldon mud as manganese dioxide, the reactions may be written as follows:

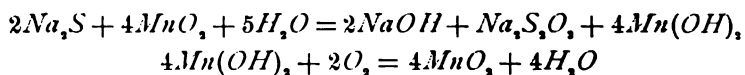

Since the manganese dioxide is continuously recovered, except the small amount carried away mechanically, it may be used over and over until, through the precipitation of ferric hydrate, silica, aluminum hydrate, etc., the precipitate becomes too bulky to handle, when it must be thrown out and new Weldon mud supplied.

71. Evaporation of the Tank Liquor.—The tank liquor after settling and purification is evaporated to obtain the sodium carbonate. We may conveniently divide the methods for evaporating the tank liquor into three classes, i. e., in pans by surface heat, in pans by heat underneath, and in pans with mechanical stirrers, by means of which the sodium carbonate crystals are fished out as soon as formed. Of these three methods, that using surface heat is the most common; it is very convenient, for it utilizes the waste heat from the black-ash furnace.

72. Surface-Heat Evaporation.—The pans for this purpose are shown in connection with the black-ash furnaces in Figs. 14 and 15. They are of very simple construction and are made of about $\frac{3}{8}$ -inch sheet iron. They are provided

with two or three doors, as the case may be, and are so formed that the contents (crystals and mother liquor) can be drawn out on the draining table $\frac{1}{2}$ in Figs. 14 and 15. During the evaporation of the liquor the doors are closed, and to make them tight, are luted on with clay.

In working the pan after the doors are closed, the pan is filled with the clear settled liquor and the waste gases from the black-ash furnace allowed to pass over the surface of the liquor. This soon brings the liquor to a boil, and the current of hot gas, by carrying away the vapor as fast as it is formed, rapidly concentrates the solution. From time to time fresh liquor is run in until the pan is nearly filled with crystals, when the evaporation is allowed to continue until the mixture of crystals and mother liquor has about the consistency of mortar. The doors are then removed, the mother liquor allowed to run off, and the whole mass brought on to the draining table. The mother liquor, "red liquor," is allowed to drain off until another panful is nearly ready to run out, when the crystals are removed to a special drainer, where they are allowed to lie and drain 24 hours.

The surface evaporation has the advantage that it is rapid, but the disadvantage that the sulphur dioxide from the fire gases is all absorbed here and causes a loss of sodium carbonate. Dust from the black-ash furnace is also carried over into the pan and makes the salts impure.

73. Pans With Heat Below.—Pans heated below have the disadvantage that they do not last so long and that they are neither so effective nor economical, but, on the other hand, they give a purer product and the loss of sodium carbonate, through the acids in the heating gas, is avoided. Various shapes of pans are in use for this purpose, but those built boat shaped (i. e., with sloping sides and narrow bottom) and heated more along the sides than on the direct bottom, are the best; for in these, by the boiling, the sodium carbonate crystals as they separate settle in the narrow, bottom portion of the pan, where they are away from the direct heat of the fire and from which place they can be

scooped out. There is always more or less trouble even with this style of pan, however, through the crystals burning fast to the bottom of the pan.

74. Mechanical Pans.—These pans are also heated by outside fire, but they have mechanical stirring devices that not only prevent the crystals sticking to the bottom of the pan, but save labor by working the crystals to the end of the pan and finally lifting them out to drain. By this system, fresh liquor can be run in continuously and the salts removed until the mother liquor gets too thick with caustic soda and sodium sulphide, when it is drawn off and fresh liquor started again. The most satisfactory pan of this

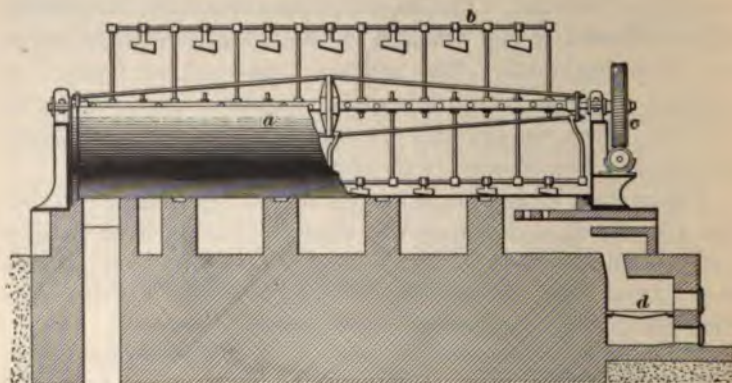

FIG. 16

type is the Thelan pan shown in Fig. 16. This consists of a semicircular iron pan *a*, which is heated on the outside by the fire from the grate *d*. The hot gases circulate under the pan and escape to the chimney at the opposite end. The scrapers *b*, which are rotated by the shaft and gear *c*, prevent the separated salt from burning fast to the pan and move it to the end, where it is lifted to a draining apron. From the draining apron the salt is moved to a large draining table, where it is allowed to drain 24 hours before being calcined.

75. Calcining the Crystals.—The salt that separates in the evaporating pans is dark in color and is known as the black salt. It consists mainly of monohydrated sodium carbonate $Na_2CO_3 \cdot H_2O$, and must be calcined to remove the water and oxidize any remaining sodium sulphide and organic matter. The calcining usually takes place in a reverberatory furnace similar to a black-ash furnace, and the charge may be brought to a dull-red heat, but must not be fused. During the drying, the material must be turned over occasionally and the lumps broken up, but further than this the operation requires very little attention, outside of the charging and discharging of the furnace and tending to the fire.

76. Grinding the Soda Ash.—By calcining the black salt, the material is caused to cake together so that it is necessary to grind it before putting it on the market. This operation is carried out in ordinary mills, such as are used in grinding grain in making flour.

SODA CRYSTALS

77. Sodium carbonate crystallizes at ordinary temperatures with 10 molecules of water, forming crystals generally known as sal soda, or washing soda. These crystals contain 63 per cent. of water, and many people consider the crystallized material so much better than the calcined soda ash that they are willing to pay the freight on all the water in order to have the crystals. This attitude was justified before ammonia soda came into the market in such large quantities, for the soda crystals were purer than any of the soda ash then available. At the present time most of the crystal soda is sold for household purposes. It is better than soda ash for laundry purposes, for it dissolves quickly, and so avoids the danger of particles of the undissolved soda getting on the linen and damaging it. The soda crystals $Na_2CO_3 \cdot 10H_2O$ are manufactured from the calcined soda ash. This substance is dissolved in hot water

and allowed to stand and settle until quite clear, when it is run into iron crystallizing pans. The size and shape of these pans vary considerably, but these features are not of material importance; the essential thing is a pan that will cool slowly and not render the solution impure. These pans are allowed to stand from 5 days, in winter, to 15 days, in summer, for all the crystals that will to separate. When the crystallization is seen to be complete, by no more crystals forming, a hole is broken in the crust and the mother liquor drawn off. The crystals are then drained and packed.

Soda crystals made from pure soda ash are soft and unsatisfactory, so that it has been found advisable to have enough sodium sulphate in the solution that the crystals will contain from 1 to 1½ per cent. of sodium sulphate. For some reason, this admixture of sodium sulphate renders the crystals hard.

78. Yield.—Owing to a number of causes, only about 70 per cent. of the sodium occurring in the sodium sulphate is finally obtained as sodium carbonate. The main sources of loss are a mechanical carrying away of part of the charge by the fire gases in the black-ash furnace, and a volatilization of another part by the high heat. A portion of the sodium sulphate fluxes, with the brick lining of the furnace and the coal ashes, and forms insoluble sodium compounds. There is always a more or less incomplete conversion of sodium sulphate into sodium carbonate, and a further loss by, necessarily, incomplete lixiviation. Finally, the action of the water in causing a reverse reaction causes a loss of soda.

79. Finished Soda Ash.—The finished product from the Le Blanc method of the manufacture of soda ash should be nearly, or quite, white and should show very few reddish specks after grinding. It should not contain over 2½ per cent. of sodium hydrate (unless intended for special purposes), nor should the insoluble matter exceed 1 per cent. It should not be possible to detect sulphides in it, and the sulphite should

not exceed .1 per cent. Sodium chloride and sulphate are always present and are harmless, but they should not exceed $\frac{1}{4}$ per cent.

80. Uses of Sodium Carbonate.—Sodium carbonate is used for an almost unlimited number of purposes, for some of which sodium bicarbonate, or caustic soda, is also used and frequently to better advantage than when soda ash is employed. The most important uses for soda ash may be enumerated as follows:

(1) The manufacture of the various kinds of glass. In the place of soda, salt cake is frequently used for this purpose. (2) The making of various kinds of hard soap. Caustic soda is also used for soap making. (3) The manufacture of borax and various other sodium compounds. (4) In the preparation of starch, the manufacture of glucose, the preparation of the fatty acids, the purification of oils and of pyroligneous products, and otherwise in the organic manufactures. (5) For scouring, dyeing, etc. in cloth manufacturing.

81. Methods for Stating Strength of Soda Ash. Soda ash may contain varying amounts of sodium sulphate, sodium chloride, and various other substances that have no value as alkali. The methods of determining the amount of available alkali in a sample of soda are more suitably explained in a treatise on chemical analysis; but since the methods for stating this value vary considerably, it is desirable that they should be explained here.

The French express the value of their soda ash in degrees Descroizilles. It is based upon the reaction between sodium carbonate and sulphuric acid, and is expressed in terms of the number of parts, by weight, of 100 per cent. of sulphuric acid that are necessary to neutralize 100 parts of the substance. Since 53 parts, by weight, of sodium carbonate neutralize 49 parts, by weight, of sulphuric acid, then 100 parts, by weight, of chemically pure sodium carbonate will neutralize 92.45 parts, by

weight, of sulphuric acid; therefore, chemically pure soda is 92.45° Descroizilles. By the same reasoning, chemically pure sodium hydroxide is 122.5° Descroizilles.

The Germans very rationally report the percentage of sodium carbonate in the sample. Since, however, by the method of determining this percentage, caustic soda will also be determined and reported as carbonate, which may have the peculiar effect of showing a substance to be 120 per cent. pure, this method is not so suitable as the English method.

TABLE II

Percentage Sodium Carbonate Na_2CO_3	Actual Alkali Na_2O	English Alkali Test Na_2O	Liverpool Alkali Test Na_2O	Descroizilles Degrees
79.51	46.5	47.11	48.00	73.57
82.07	48.0	48.63	49.54	75.87
85.48	50.0	50.66	51.61	79.03
88.90	52.0	52.68	53.67	82.19
90.61	53.0	53.70	54.70	83.77
94.03	55.0	55.72	56.77	86.93
97.45	57.0	57.75	58.83	90.09
99.16	58.0	58.76	59.87	91.68
100.02	58.5	59.27	60.38	92.45

The English rate their alkali on the percentage of real or available alkali; that is, on the percentage of Na_2O in the case of both sodium carbonate and hydrate. This method seems to be the most sensible, for it is the real alkali that is of value, and it does not matter so much in what form it is; therefore, the percentage of the valuable constituent is given. This system is also somewhat used in France and is there called the Gay-Lussac degree. Unfortunately, when this system was established in England, the values of the atomic weights were not exactly

determined, and so 32 was used as the equivalent weight of Na_2O , instead of the more correct value 31. Although it is now well known that this error exists, it is still retained, either through dishonesty or a neglect to change. Besides, in the Liverpool district, a mistake was, and is, made in such a way in making the calculation that an even greater error is made in the manufacturers' favor in stating the strength of the alkali.

In the United States, the English system is pretty generally adopted, using the correct equivalent for Na_2O ; although in New York and some other large cities, where considerable soda is imported from England, the English and Liverpool degrees are also in use.

Table II shows the relation between the different methods for stating the value of soda ash.

TANK WASTE

82. The residue that is left after the removal of the soluble constituents from the black ash consists mainly of the sulphide and carbonate of calcium with small amounts of various other substances and is generally called the tank waste. Practically all the sulphur that was contained in the sodium sulphate is left in this waste, and therefore, unless it can be recovered, it represents an enormous loss of money. In addition to that, it requires room for dumps, and by weathering it produces an almost intolerable nuisance, due to the escape of hydrogen sulphide and sulphur dioxide into the air. The weathering of the tank waste also causes the formation of polysulphides of sodium and calcium, forming the so-called yellow liquors, which run into the streams and sewers and contaminate them and which also saturate the soil of the neighborhood, spoiling the wells and doing other damage.

Table III gives an idea of the composition of tank waste from the mechanical furnace and the hand furnace.

TABLE III
COMPOSITION OF TANK WASTE FROM MECHANICAL
AND HAND FURNACES

Constituents	Revolver. Per Cent.	Hand Furnace. Per Cent.
Sodium carbonate.....	2.9	2.5
Calcium carbonate.....	24.7	33.2
Calcium hydrate.....	1.0	9.0
Calcium sulphide.....	54.7	37.3
Calcium thiosulphate.....	.5	2.0
Calcium sulphite.....	trace	
Calcium sulphate.....	trace	.3
Calcium silicate.....	2.5	1.0
Carbon.....	8.4	6.4
Alumina.....	.8	.5
Ferrous sulphide.....	1.5	2.5
Sand.....	2.0	5.0

These analyses are made on the dry substance, so that in addition to the above we must calculate about 30 per cent. of water in the composition of the waste.

The disposal of this waste material has been one of the important problems of the Le Blanc manufacturer ever since the industry became of sufficient importance for the waste to be noticed, and it still continues to trouble him, although the problem has been fairly well solved. It is best disposed of, when the works are located near the coast, by loading it upon scows, towing it out to sea, and dumping it. This, of course, wastes the sulphur, but it avoids the nuisance. Where it cannot be conveniently sent to sea and it does not pay to employ one of the recovery processes to work it up, the waste is spread out evenly and then packed down to prevent, as far as possible, the infiltration of rain.

The processes that have been proposed for recovering the sulphur from the waste are numerous, but only one has been

permanently successful. Even now only a part of the waste is worked for sulphur recovery.

83. Chance-Claus Process.—The only process that has ever been commercially successful and the only one that is in successful operation today for the recovery of the sulphur from tank waste, is the so-called Chance-Claus process. This process depends essentially on the decomposition of the waste by carbon dioxide, which reaction was proposed by Gossage in 1836. He believed in the process so thoroughly that he spent 30 years of his life and a fortune in money striving to perfect it, but without success. His principal difficulty was that he could not get the escaping gas rich enough in hydrogen sulphide and its composition varied too much. The attainment of this result, together with a method for getting the sulphur from the hydrogen sulphide, comprise the achievements of Chance and Claus in this direction.

84. In carrying out the process, the tank waste is made to a slurry with water and then charged into a cylinder. A battery of seven cylinders is usually employed, which are so arranged that the gas can be passed from one cylinder to any other. In operation six cylinders are in use and one is being emptied and recharged. The gas used must be of regular composition and contain not less than 30 per cent. of carbon dioxide. This is best obtained from lime kilns similar to those used in the ammonia-soda process. It is passed into the cylinder containing the most nearly exhausted material and sets free the hydrogen sulphide according to the reaction

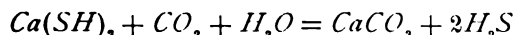

This hydrogen sulphide passes into the following cylinders, where it is absorbed by the calcium sulphide

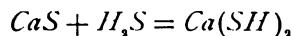

Since the most recently charged cylinder is placed last, the hydrogen sulphide is practically all absorbed and the escaping gas is almost completely free from it and might

escape directly into the air. For the sake of safety, however, it is usually run through a purifier similar to those used to purify coal gas and containing either oxide of iron or lime. When the contents of the last two or three cylinders are nearly converted into calcium sulphhydrate, the escaping gas begins to be stronger in hydrogen sulphide. At this point the back cylinders are tested to see if the gas will burn, for this is an indication that it is 30 per cent., or stronger, in hydrogen sulphide. As soon as the gas from one of the intermediate cylinders is found to be strong enough, it is put in connection with a gas holder and the gas collected until its composition falls below 30 per cent. of hydrogen sulphide. (The water lute of the gasometer is shut off from the air by a heavy layer of oil to prevent the escape of the gas into the air.) When the gas contains less than 30 per cent. of hydrogen sulphide, it is turned into freshly charged cylinders, and the first cylinder, the contents of which should be so free from sulphides by this time that they do not blacken lead paper, is emptied and recharged with fresh slurry. The water from this residue is so pure that it can be run directly into the streams and the solid material, which contains over 85 per cent. of calcium carbonate, can be used for fresh black-ash mix, or for making cement.

85. The hydrogen sulphide is so strong that it can be burned direct for the manufacture of sulphuric acid, and it yields an exceedingly pure acid free from arsenic. The greater part of the gas is converted into sulphur, however, for the sulphur is more valuable in the free condition than in sulphuric acid. The thing that has probably done the most to make the Chance-Cläus sulphur-recovery process commercially successful is the method of converting the hydrogen-sulphide gas into sulphur. This consists in passing through iron oxide heated to dull redness a mixture of hydrogen sulphide and air in the proportions given by the equation

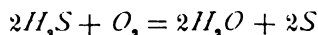

When the kiln is first started, it is necessary to heat the iron oxide to the proper temperature; but when once started, the reaction keeps the temperature of the oxide high enough to continue the reaction.

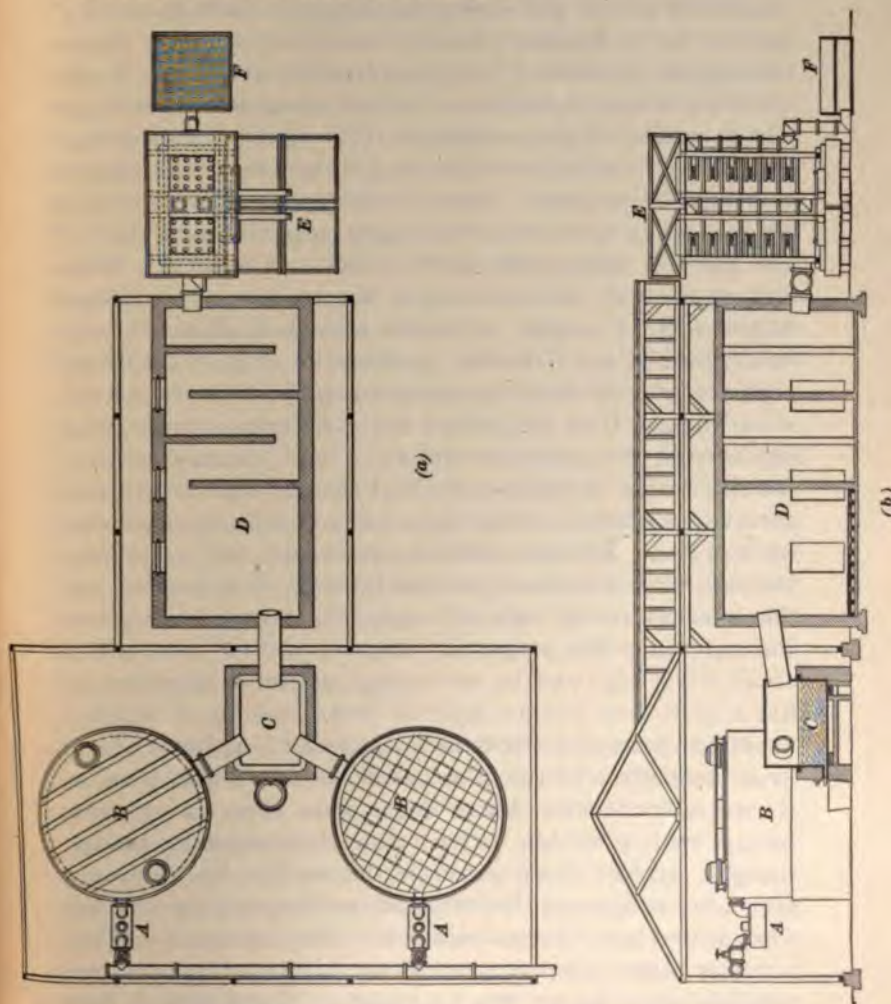

86. Claus Kiln.—Fig. 17 shows the Claus kiln as at present used in the Chance-Claus sulphur-recovery process.

The gas is mixed in the gas holders with a proper amount of air for its decomposition, according to the preceding equation.

The composition of this mixture must be very carefully determined by analyses, and the amount of air regulated so that there will be just sufficient oxygen to burn the hydrogen of the hydrogen sulphide, but no excess. By determining the amount of hydrogen sulphide in the gas in the holder, it is easy to calculate the amount of air necessary to add to make the proper mixture. From the equation it is seen at once that each volume of hydrogen sulphide requires $\frac{1}{2}$ volume of oxygen. Then, if the gas in the holder is 32 per cent., by volume, hydrogen sulphide, each liter of the gas will contain .32 liter of hydrogen sulphide, which will require .16 liter of oxygen, but the air only contains 21 per cent. of oxygen, so that we must take $\frac{1}{4}$ liter of air, or .76 liter of air. That is, 3 volumes of air must be mixed with every 4 volumes of the gas from the holder. Of course, when the gas from the holder has a different composition, the amount of air must be varied; so that it is very essential for the success of this process that the gas be of a very uniform composition, and that the work be constantly controlled by analyses. The gas mixture passes from the gas holder through its conduction pipe and the lute *A*, to prevent the flame from striking back and exploding the gas holder, into the top of the kiln proper *B*. This is made of iron and is about 9 feet high and, on an average, 25 feet in diameter; it has a grate that bears a layer of broken bricks, on which is about 12 inches of ferric oxide. At first the gas was passed in at the bottom of the kiln, but it was found that here, as is generally the case where a gas must come in intimate contact with a solid, a better result is obtained by passing the gas mixture down through the oxide. In starting a kiln, a fire is built on the iron oxide and kept going until the oxide is red hot; the gas mixture is then turned in and the reaction between the oxygen of the air and the hydrogen sulphide takes place. The temperature of the oxide is kept up without any further outside heat. The best temperature is about 230° C., taken at the exit pipe from the kiln. The

reaction is a reversible one, so that it will never be quite complete, and it is not possible to add an excess of oxygen to force it, for in that case sulphur dioxide in too large quantities would be formed.

From the kiln the products pass into a small chamber *C*, where the molten sulphur deposits, while the gases and sulphur vapor pass into the larger chamber *D*, where the sulphur vapor deposits as flowers of sulphur and some of the steam is condensed. This chamber contains walls part way across, as shown in the figure. These walls serve as baffle plates and separate the fine sulphur, which would otherwise be carried into the washing tower and clog it, and at the same time be lost. From *D* the gases pass through the washing tower *E*, down which water is kept flowing to remove sulphur dioxide from the gas. It then passes through a purifier *F* containing lime or iron oxide to remove the last of the hydrogen sulphide, so that the gas escaping into the air is practically pure nitrogen.

This process, when working well, recovers from 85 to 90 per cent. of the sulphur in the waste and entirely abates the nuisance otherwise due to the waste decomposing in the open air. The cost of the installation of the plant is small and its operation is not expensive, but the price of sulphur is at present so low that it hardly pays to recover it, and if it were not for disposing of the waste, the process would probably go out of use.

87. Sodium Thiosulphate.—Since sodium thiosulphate, or what is more commonly known as sodium hyposulphite, or hypo, is made almost exclusively from tank waste, it deserves a few words here. It is made by blowing air through the waste suspended in water until all the sulphide is converted into calcium sulphite and thiosulphate, and then adding sodium sulphate, or carbonate, which gives the insoluble calcium salt and leaves sodium thiosulphate in solution. This is boiled with sulphur to convert the sulphite into thiosulphate, then crystallized out and purified by recrystallization.

Another method is to pass sulphur dioxide into the waste, thus converting the sulphide into thiosulphate according to the reaction

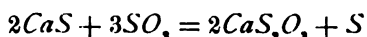

and then converting it into the sodium salt as above. Sodium thiosulphate forms soluble salts with silver, thus dissolving silver iodide and chloride. For this reason it is largely used in photography and the metallurgy of silver. It is also used as an antichlor in paper making, in certain kinds of dyeing, and for various other uses.

SODIUM HYDRATE

88. Historical.—The manufacture of sodium hydrate on the large scale at a factory does not date back nearly so far as the manufacture of soda ash. It is true that caustic soda has been used for soap making almost as long as soap has been known, but for a long time it was made at the soap manufactory and used in the form of solution. It was not until 1850 that the manufacture of caustic soda, as such, began, and then only on a small scale; and it was not until 1860 that the manufacture attained any considerable importance. From that time on, however, more and more caustic soda has been made, until now it is an important branch of the alkali industry.

89. Sodium Carbonate and Lime.—The most common process for the preparation of caustic soda is by means of the reaction between sodium carbonate and slaked lime. This reaction is

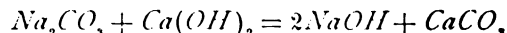

Since the reaction is a reversible one, it is not desirable to make the sodium hydrate too strong, for the stronger the solution is in caustic soda, just so much more tendency is there for it to go towards the formation of calcium hydrate and sodium carbonate. On the other hand, although dilute solutions lead to a high percentage transformation of the

sodium carbonate, they require large apparatus and much heat to drive off the water, in the making of the solid caustic. It is, therefore, necessary to pursue a middle course. A solution of sodium carbonate of 1.1 sp. gr., that is, about 10 per cent., is generally considered to be the most advantageous strength for conversion into the hydrate. With a solution of this strength, about 97 per cent. of the sodium carbonate used can be converted into caustic soda, which gives a fair strength of solution.

CRUDE MATERIALS

90. Soda Ash.—The soda from the Le Blanc process is well suited for making caustic soda, for it frequently contains considerable caustic, which has been formed by the lixiviation of the black ash, and so requires less lime than would otherwise be the case. By the addition of a large excess of limestone to the black-ash charge, practically all the sodium can be obtained as the hydrate; this method is sometimes employed. A suitable furnace charge to employ when the tank liquor is to be used for making caustic is 100 parts, by weight, of salt cake, 110 parts of limestone, and 65 parts of coal. A part of the limestone is frequently replaced by caustic mud (see Art. 97) in the proportion of about 20 parts of the mud to 1½ parts of limestone. The red liquid (mother liquor from the black salt) from the Le Blanc process, in which is concentrated much of the caustic originally in the black ash, is frequently utilized for making caustic soda.

At the ammonia-soda works the sodium bicarbonate mixed with water is first boiled by steam in a closed apparatus, so that the ammonia and from 75 to 80 per cent. of the bicarbonate carbon dioxide are driven off and utilized in the carbonating towers, while the sodium-carbonate solution, which contains about 20 per cent. of the bicarbonate, is used for making caustic soda.

91. Lime.—The lime used for making caustic must be of good quality, for a low percentage of CaO not only makes

necessary the introduction of large amounts of impurity into the causticizing tank, but it also gives a caustic liquor that settles badly and so interferes with the work. A satisfactory lime should contain at least 85 per cent of CaO .

DETAILS OF THE PROCESS

92. Causticizing the Sodium Carbonate.—The causticizing of the sodium carbonate takes place in an iron cylinder, placed horizontally and provided with agitators *a*, Fig. 18. The charge is introduced at *b*, and when finished,

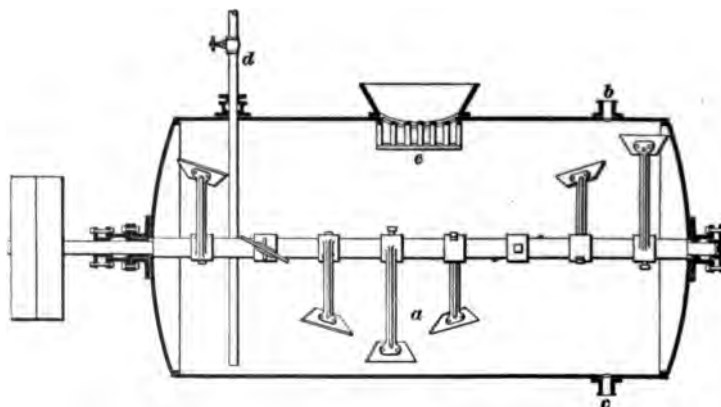
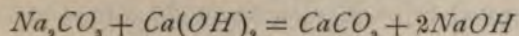

FIG. 18

is drawn off to the filter at *e*. During the causticizing these openings are closed with plugs. Steam may be blown in through the pipe *d* to heat the liquor, while *c* is a rack for the lime when this is used unslaked. In many works this rack is dispensed with and the lime is slaked and screened from lumps before going to the causticizer in the shape of milk of lime. For this operation, sufficient sodium carbonate of from 1.10 to 1.11 sp. gr. is run in so that when the lime is added the causticizer will be nearly filled. At the ammonia-soda works the liquor comes hot from the decomposition of

the bicarbonate; in other cases it is better to heat it. Sufficient lime is now added to fulfil the equation



Theoretically, 106 grams of the sodium carbonate will require 56 grams of calcium oxide, or 62.2 grams of quicklime containing 90 per cent. of calcium oxide. Since the above reaction is a reversible one, it is an advantage to have an excess of lime present, so that about 10 per cent. in excess of that theoretically required is employed.

The mixture is now kept, by blowing in steam, at a temperature of about 80° C. and is constantly stirred by the paddles for 2 or 3 hours, when about 92 per cent. of the sodium carbonate will be causticized.

93. Filtration.—It is now necessary to separate the caustic liquor from the calcium carbonate and other suspended material (caustic mud), and although this is done at



FIG. 19

some works by letting the liquor stand and settle, it is usually filtered. For this purpose, such a filter as is shown in Fig. 19 is employed. It consists of an iron tank about 20 × 20 feet and 4 or 5 feet deep. This tank is supported a little above the floor by brick piers and the bottom is so sloped that the liquor drains towards the pipe *a*. On the bottom of the tank are strips *b*, cut out so that the liquor can circulate

in the apparatus and will finally flow away through *g*. This condensed steam can be used for boiler feedwater, or similar purposes, if desired. The liquid flowing through the tubes is in such a thin layer that as it boils it mixes with the steam and fairly foams, so that the liquid comes in contact with all parts of the tubes and gets the full benefit of the heat, thus evaporating rapidly. The foaming mixture of steam and solution issues from the tubes *a*, and by striking against the baffle plates in *b b*, is separated. The solution settles and flows through *c* into the next element in the series, where it goes through the tubes in the same way. The steam passes upwards through the "catch-all" *d*, where the last of the particles of the solution, which are carried mechanically by the steam, are separated and the solution flows through *h* into the next element. The steam then goes through *i*, which connects with *f* of the next element, into the next element, and there boils the solution which it has just left. This solution now passes through the tubes of the next element under a lower pressure than it had in the preceding case.

This system probably gives the most efficient evaporation of any style of evaporating arrangement and is very compact, as the elements can be placed one above the other. The inventor of this apparatus claims that from 23½ to 25 pounds of water can be evaporated with it in triple effect, and 30½ pounds in quadruple effect per pound of coal, while in the ordinary vacuum pan only 8½ pounds of water are evaporated for the same amount of fuel. The apparatus has the further advantage that it is nearly automatic in its action, thus requiring but little attention, and since it contains only a small amount of liquid at one time, it can be easily stopped and started. The steam for the first element is generated in a boiler kept for that purpose, but for each following element it is supplied as pointed out above.

95. Caustic Pots.—The evaporation cannot be successfully carried beyond a specific gravity of 1.3 in the Yaryan,

for at this point the dissolved salts, such as sodium carbonate, sodium sulphate, etc., begin to separate out. The solution is then run into the iron pots, where the evaporation is finished. The salts that crystallize out are from time to time "fished" out, and the heating is continued until the water is all expelled and fused caustic left in the pot. The caustic pots are of cast iron and similar in shape to the cast-iron pans used in making salt cake. They are ordinarily about 6 or 8 feet in diameter and from 3 to 5 feet deep in the deepest part. The caustic pots are cast with a rim, so that they can be supported on brickwork over a grate, by which they are heated. A coal fire is generally used for heating the pots, but since the fire must be allowed to die down when the pot is finished, it has been found very advantageous to use a gas fire for this purpose.

The caustic in the course of its evaporation attacks the metal apparatus with which it comes in contact, so that by the time it is finished the fused caustic contains copper, iron oxide, and various other substances in suspension, as well as aluminum, silicon, manganese, etc. in solution. The substances in solution do not usually seriously affect the caustic in value, although the manganese is frequently plainly shown by the green manganate color. It is, however, advisable to remove the suspended matter so far as possible, and for this purpose, after all the water has been driven off, the fires are cooled somewhat and the fused caustic allowed to stand. The fused caustic is then ladled into sheet-iron drums, which as soon as cold are sealed air-tight. In each pot there is a residue, containing the settled impurities, which is called the *caustic bottom*. The caustic bottoms are put into drums and sold cheaply for making an inferior grade of soap. When this is not possible, they are left in the pots until they get too bad, when they are dissolved in water, filtered, and reconcentrated.

96. Removal of Sulphur.—In the case of caustic made from Le Blanc soda, the final removal of the sulphur takes place in the pots. The sulphide is best oxidized to

thiosulphate, as already stated, by blowing in air. The final oxidation of the thiosulphate is, however, very slow, so that it is assisted by adding niter, a little at a time, until all the sulphide and thiosulphate have been oxidized to sulphate. Sometimes, instead of oxidizing the sulphide and so obtaining it in a comparatively valueless form, the sulphur is precipitated as zinc sulphide by using zinc oxide. The reaction is



The zinc sulphide is separated before evaporating the caustic liquor, and by calcination can be reconverted into the oxide. After the removal of the sulphur, the caustic is treated as in the above case.

97. Caustic Mud.—The material left on the filter in the filtration of caustic soda goes by the name of caustic mud and consists, especially when ammonia soda is used, principally of calcium carbonate. The composition of the caustic mud from the filter of a works making caustic soda from ammonia soda is given below:

CaCO_3	72.05%
Ca(OH)_2	15.39%
Mg(OH)_2	5.61%
SiO_2	2.80%
$\text{Fe}_2\text{O}_3 + \text{Al}_2\text{O}_3$	1.70%
CaSO_429%
NaOH48%
H_2O	1.62%
	99.94%

Many propositions have been made for utilizing this material, among others, to use it instead of limestone in the black-ash charge; to use it for making Portland cement; to use it for whitening and to press it into form for crayon. It has found some use in the still, instead of lime, to set ammonia free from its salts; probably, however, the greater part of this material is still run to waste.

98. Loewig's Process.—When sodium carbonate and ferric oxide are mixed and fused together, carbon dioxide is given off and sodium ferrite formed according to the reaction

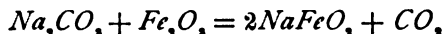

For calcination, a revolving furnace is usually employed and the mass heated to a dull red. After fusion, the sodium ferrite is allowed to cool and then washed with cold water until all the soluble material is removed, then water of 80° to 90° C. is employed and the sodium ferrite decomposed into sodium hydrate and ferric oxide. The reaction is

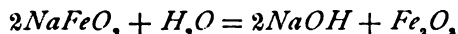

The lixiviation can be so carried on that a caustic liquor of 1.3 sp. gr. is obtained direct. This is the strength at which the caustic leaves the Yaryan in the lime process, so that a considerable saving is made in apparatus and fuel, for this liquor can go direct to the pots. From that point its treatment is the same as for caustic made from ammonia soda by the lime process. The iron oxide used in this process is a high-grade natural ore, as free as possible from silica and other impurities, for these would lead to a loss of soda through the formation of insoluble compounds. The iron oxide obtained by igniting precipitated ferric hydrate is not suitable for this purpose, for on account of its fineness it gives a product hard to lixivate and filter. On the other hand, the residue from the lixiviation of the sodium ferrite can be used repeatedly and extra iron oxide is only needed to make up for the mechanical loss. The process is not especially valuable for making caustic from Le Blanc soda, for the tank liquor must be evaporated and might as well be causticized in solution and then evaporated. On the other hand, it seems very well suited for working the solid ammonia soda. Caustic soda of an excellent quality can be made by this process.

99. Uses of Caustic.—Sodium hydrate is used principally in the making of soap, wood pulp for paper making,

and the purification of petroleum and other oils, although considerable quantities are also employed in the purifying of phenol and other organic substances. It is also now used in considerable quantities in the preparation of coal-tar dyes and in making sodium silicate and other sodium compounds.

SODIUM BICARBONATE

100. The sodium bicarbonate of the ammonia-soda process may be used just as it comes from the filters for some purposes, but for most uses this is too impure. A few years ago, practically all the sodium bicarbonate was made direct from the Le Blanc soda crystals by spreading them on racks and passing carbon dioxide over them. This had the disadvantage of leaving all the impurities of the soda ash in the bicarbonate, and later the method was improved by dissolving the soda ash in water, or fusing it in its water of crystallization, and passing in carbon dioxide. The bicarbonate then crystallized out, and most of the impurities were left in solution. The soda from cryolite was especially valuable for making bicarbonate on account of its great purity. The making of sodium bicarbonate from ammonia soda had the disadvantage for some time that it was difficult to free it from ammonia. That difficulty has been overcome, however, and at the present time practically all the best bicarbonate of soda is made from the crude bicarbonate of the ammonia-soda process. Two processes are in use for purifying the crude bicarbonate, the *wet* and the *dry*.

101. Wet Process.—This process consists in dissolving the crude bicarbonate in hot water and saturating the solution with carbon dioxide, then allowing it to cool and the bicarbonate to crystallize out. The solution can be heated to 65°C. without more than atmospheric pressure, or to a higher temperature if a higher pressure is applied. By this method almost all of the salt and other impurities of the crude bicarbonate are left in solution. The recrystallized bicarbonate is filtered off by means of a centrifugal

machine and dried at a low temperature on traveling bands of cloth.

102. Dry Process.—This process consists in driving off ammonia and moisture by a hot current of carbon dioxide. It is not as good as the other, for it only removes the volatile impurities from the bicarbonate.

However made, the bicarbonate is ground fine before packing it for shipment.

The following analysis shows the high grade of purity attained by the bicarbonate prepared from the ammonia-soda crude bicarbonate. This sample was prepared by the wet method, which is the one most used.

$HNaCO_3$	99.400%	$Al_2O_3 + Fe_2O_3$.	.009%
Na_2CO_3380%	Na_2SO_4007%
$NaCl$023%	$CaCO_3$021%
SiO_2008%	$MgCO_3$011%

1. The first part of the document is a list of names and titles, including "The Hon. Mr. Justice" and "The Hon. Mr. Justice".

ALKALIES AND HYDROCHLORIC ACID

(PART 2)

CHEMICAL METHODS

HYDROCHLORIC ACID

PROCESS OF MANUFACTURE

1. The manufacture of hydrochloric acid is almost inseparably connected with the manufacture of salt cake, and really consists in the condensation of the acid set free in the salt-cake manufacture. In a few works salt is decomposed for the hydrochloric acid alone; in which places the charge of salt is always in excess of the sulphuric acid, for the salt is much cheaper than the acid and the more expensive sulphuric acid is more completely utilized than it is in the ordinary salt-cake process. A purer hydrochloric acid is also obtained in this case. The apparatus and methods of working are, with the above exception, the same as in the making of salt cake. We shall, therefore, merely consider the condensation of the hydrochloric acid that has been made in the salt-cake manufacture.

2. Condensation of Hydrochloric Acid.—During the early years of the manufacture of salt cake, the hydrochloric

§ 30

For notice of copyright, see page immediately

title page.

2 ALKALIES AND HYDROCHLORIC ACID § 30

acid had very little value and was allowed to escape freely into the air. But the action of the gas was so bad on vegetation and, although it has not been proved that it has an injurious effect on animals and men, it became such a nuisance as the works increased in number that, in 1862, the Lord Derby Alkali Act was passed in England forbidding manufacturers to allow more than 5 per cent. of their hydrochloric acid to escape into the atmosphere. The present English Alkali Act only allows .2 grain of hydrochloric acid per cubic foot of chimney gas to escape into the atmosphere. This makes it necessary to absorb the acid in water; we have passed also from the time when the salt cake was a source of profit and the acid a troublesome by-product to the time when the acid is the chief source of profit. The problem that now confronts the manufacturer is how to get the most complete absorption of the hydrochloric acid in the cheapest manner, and at the same time make the strongest solution of the acid possible. Hydrochloric acid being a gas, its concentration in solution depends on the temperature and pressure; under ordinary conditions, the strongest acid is about 40 per cent., while in practice the best working gives about 36 per cent. in winter and 30 or 32 per cent. in summer.

3. Usually the pan acid is absorbed separately from the roaster acid, for the pan gases contain a comparatively high percentage of hydrochloric-acid gas and can be more easily absorbed to a strong acid solution, while the roaster gases tend to give a much weaker and more impure acid. The gas from the pan is cool enough, so that it can be conducted away in glass or earthenware pipes; the gas from the roaster, however, is so hot that it would crack these pipes and either brick flues or iron pipes are used. The brick flues are disadvantageous, because they do not permit rapid cooling; iron pipes are much better, for they permit very rapid cooling, but they cannot be used after the temperature of the gas gets below 200° C. After the roaster acid is fairly cool, it receives the same treatment as the pan acid, so that they will be considered together.



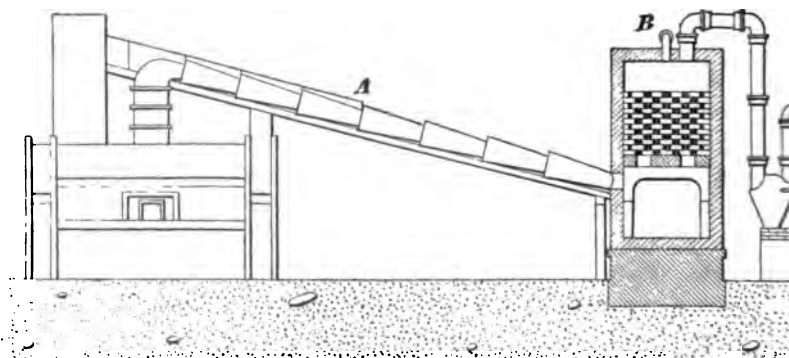
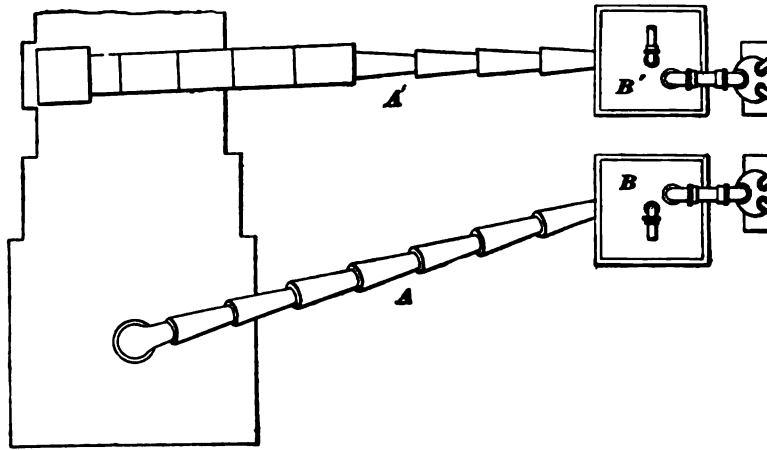

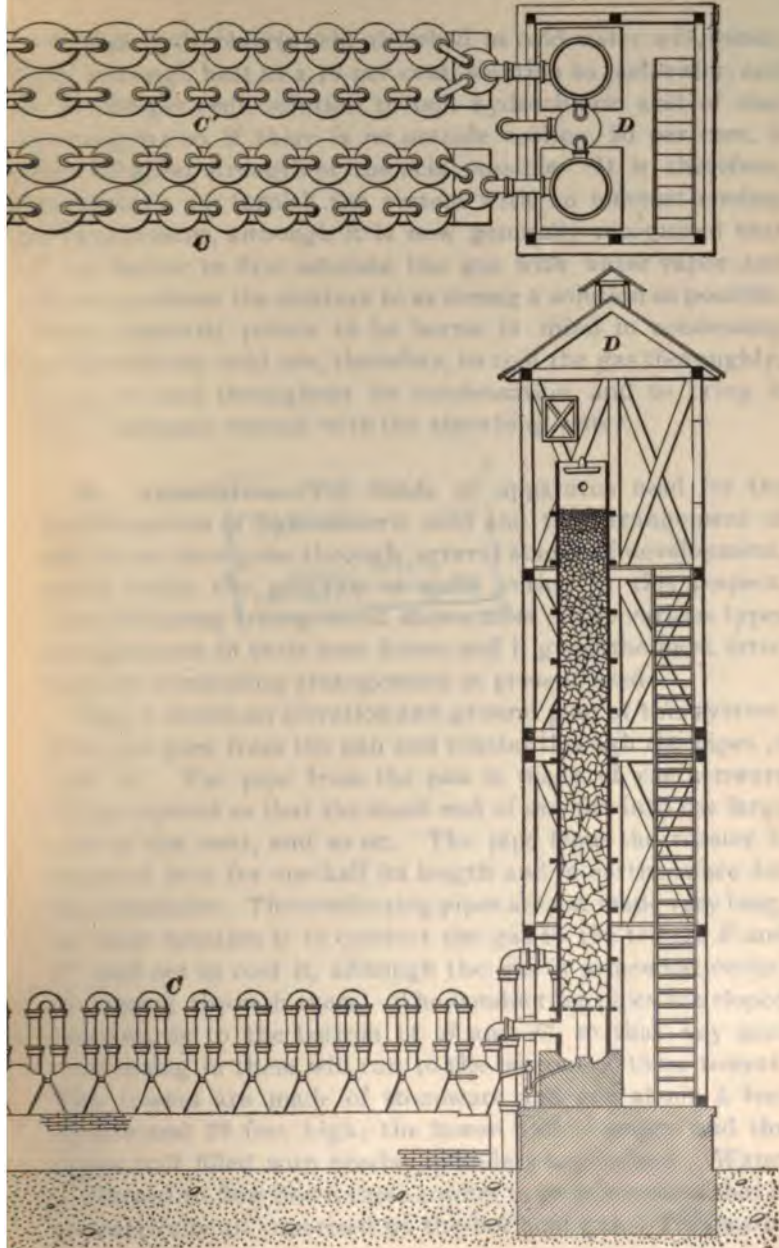

1. The first part of the document discusses the importance of maintaining accurate records of all transactions and activities. It emphasizes the need for transparency and accountability in financial reporting.

2. The second part of the document outlines the various methods and techniques used to collect and analyze data. It highlights the importance of using reliable sources and ensuring the accuracy of the information gathered.

3. The third part of the document focuses on the analysis and interpretation of the data. It discusses the various statistical methods and models used to identify trends and patterns in the data.

4. The fourth part of the document discusses the implications of the findings and the potential impact of the research. It highlights the need for further research and the importance of sharing the results with the relevant stakeholders.

5. The fifth part of the document provides a summary of the key findings and conclusions. It emphasizes the need for continued monitoring and evaluation of the situation and the importance of taking appropriate action based on the findings.

10

Cold hydrochloric acid absorbed in cold water will generate enough heat at a 16-per-cent. solution to boil water, and at a 20-per-cent. solution to boil hydrochloric acid of that strength; so, if there is no outside cooling, 20 per cent. is the highest strength of the acid possible. It is, therefore, necessary to furnish the system with an efficient cooling arrangement, although it is now generally recognized that it is better to first saturate the gas with water vapor and then condense the mixture to as strong a solution as possible. The essential points to be borne in mind in condensing hydrochloric acid are, therefore, to cool the gas thoroughly, keep it cool throughout its condensation, and to bring it into intimate contact with the absorbing water.

4. Apparatus.—The kinds of apparatus used for the condensation of hydrochloric acid and the arrangement of the same have gone through several stages of development, until today the practice is quite varied in this respect. The following arrangement shows most of the various types of apparatus in their best forms and it gives the most satisfactory condensing arrangement at present used.

Fig. 1 shows an elevation and ground plan of this system. The gas goes from the pan and roaster through the pipes *A* and *A'*. The pipe from the pan is made of earthenware tubes tapered so that the small end of one fits into the large end of the next, and so on. The pipe from the roaster is made of iron for one-half its length and of earthenware for the remainder. The conducting pipes are not made very long, as their function is to conduct the gas to the towers *B* and *B'* and not to cool it, although the gas is somewhat cooled in passing through them. The conducting pipes are sloped downwards to the bottom of *B* and *B'*, so that any acid condensing in them will run to the bottom of these towers. The towers are made of stoneware and are about 4 feet square and 12 feet high; the lower half is empty and the upper half filled with fireclay cylinders set on end. Water is allowed to flow down these towers in such amounts that it is practically all vaporized by the hot acid gas. This water

4 ALKALIES AND HYDROCHLORIC ACID § 30

serves the double purpose of washing the sulphuric acid from the gas and of cooling it. The fairly cool gas, saturated with water vapor, now enters the bombonnes *C* and *C'*, where it meets a stream of water flowing in the opposite direction to the flow of the gas. This water and the tall connecting pipes of the bombonnes finally condense most of the hydrochloric-acid gas; a certain amount of the acid always escapes condensation here, however, and is removed by the coke tower *D*.

The bombonnes, Fig. 2, are made of earthenware and are fitted with rather long earthenware pipes *a* to cool the gas, as well as to conduct it from one bombonne to the next. The bombonnes are also connected at *b* by ground joints, or a glass tube and rubber stoppers; on the inside of each bombonne there is a pipe *c* to conduct the incoming liquid to its bottom and naturally the upper portion flows on to the next bombonne in order. From twenty to thirty

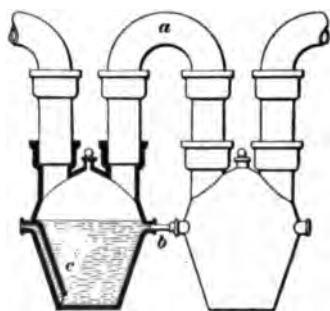

FIG. 2

of these bombonnes are used in series for each pan. The coke tower is made of acid-proof stone slabs fastened together by iron bands soaked in tar; it should be about 5 feet square and 30 or 40 feet high. As the name indicates, the packing used is usually coke, but porous stone and various forms of earthenware have been used. The towers are best used in pairs, the acid gas entering at the bottom of one, and rising to its top, is carried by a pipe to the bottom of the next tower, and escapes at the top of this. Water constantly flowing down over the coke absorbs the acid. The packing of the tower requires considerable attention; for if the packing is too loose or the pieces of coke are too large, not enough surface is offered for the acid; on the other hand, if the packing is too tight there is not enough draft. The coke used in packing the towers should

be the hardest oven coke. In the bottom of the tower the largest and longest pieces should be used and smaller pieces in order, until, after an eighth of the way up, pieces 6 or 8 inches by 2 inches mixed with some smaller ones can be used. After one-third of the tower is carefully packed, the rest can be filled by dumping in coke, freed from all pieces under 2 inches by riddling.

5. Lunge Plate Tower.—Another form of coke tower, or condenser, is obtained by using the Lunge plates. The

plate tower, Fig. 3, only occupies from $\frac{1}{10}$ to $\frac{1}{30}$ the space required for coke towers, and gives an even more efficient absorption for the gas. Of course, the size of the tower will vary with the work required of it, but for ordinary cases the best tower consists of nine earthenware cylinders, each 3 feet in diameter and 3 feet 3 inches high, set together as indicated in the figure. The first cylinder *A* is left empty, the next three *b* are filled with sixty Lunge plates, the next one *c* is left empty, the next two *d* are filled with coke, and the last two *e* are empty. Whatever size of tower is used, this is the best distribution of the filling. The gas passes in at *g*, meets a descending stream of water, which absorbs the hydrochloric acid, and flows out at *h* into the bombones. The waste gases pass out through *f*.



FIG. 3

6. Hart System.—A system recently patented by Hart for the absorption of hydrochloric acid has much to recommend it in compactness and simplicity, and although it has not been used long enough to warrant its being called an established method, it deserves some

consideration. It consists of a series of glass pipes *a*, Fig. 4, through which water runs. The water is fed in continuously at *b* and flows from one pipe to the next until it finally runs into *c* as strong acid. These pipes are cooled by water

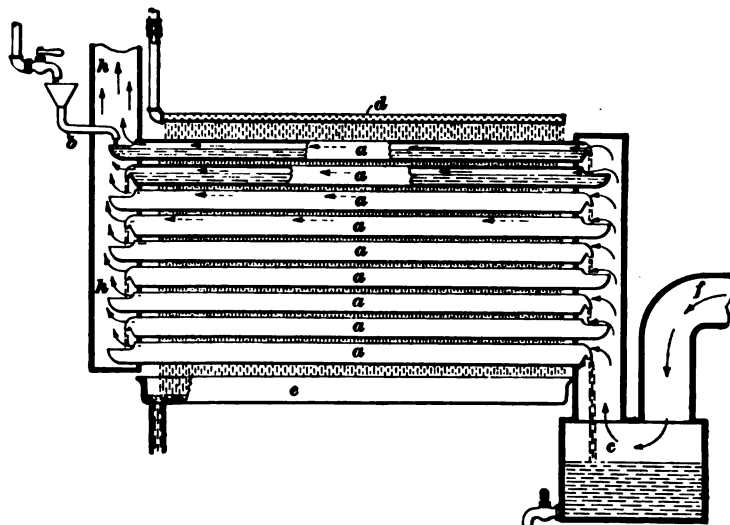

FIG. 4

running over them from a perforated pipe *d*, the excess being carried off in *c*. The gas comes in at *f*, passes over the strong solution of acid in *c*, and then through the pipes to the flue *h*, where it goes to the chimney.

7. Commercial Hydrochloric Acid.—This is a yellow-colored solution of the gas in water, usually claiming a specific gravity of 1.2, but rarely containing over 30 or 35 per cent., by weight, of hydrochloric-acid gas, and seldom, if ever, reaching so high a concentration as 40 per cent. of the acid. Its yellow color is mainly due to organic matter, for it seldom contains enough iron to seriously affect its color. It contains, as other impurities, sulphuric acid, chlorine, arsenic, and frequently lead and calcium chlorides.

8. Purification of Hydrochloric Acid. — For many purposes, the crude hydrochloric acid will answer very well, but for others it must be as nearly chemically pure as possible. For this reason a method of purification that is suitable in one case will be useless in another; and, furthermore, the question of cost must frequently be taken into consideration. An adoption of one of the following methods will usually meet every demand.

The cheapest and most effective method for purifying hydrochloric acid, especially from sulphuric acid, is the so-called *Hasenclever method*. This consists in treating the strong water solution with concentrated sulphuric acid or calcium chloride and blowing air through the mixture. The hydrochloric acid is evolved free from practically all the impurities except the arsenic, and may be used in the gas form, as is usually done, or reabsorbed in water. In carrying out the Hasenclever method, 100 parts of the crude hydrochloric acid is run into a stone jar with 550 parts of sulphuric acid of 60.4° Baumé, and the mixture stirred mechanically or by means of a current of air when there is no objection to having air mixed with the hydrochloric acid. The sulphuric acid is thus reduced to 55° Baumé and is reconcentrated by surface heat.

Sulphuric acid and sulphur dioxide may also be cheaply removed from hydrochloric-acid gas by passing it through towers containing solid sodium chloride. Where arsenic-free acid is needed, it is best to start with arsenic-free sulphuric acid. If the acid is diluted to 1.12 sp. gr. and barium sulphide is added, the arsenic will be precipitated as the sulphide and the sulphuric acid as barium sulphate. The gas may then be distilled off and reabsorbed in water.

Another method consists in adding a solution of stannous chloride in concentrated hydrochloric acid to the strong hydrochloric acid. Arsenic separates out, the reaction probably being

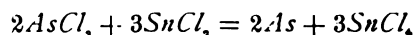

This leaves stannic chloride in the acid unless it is redistilled.

Arsenic and chlorine may be removed by digesting the acid with scrap copper for some hours; the arsenic is precipitated and the chlorine combines with the copper. The acid is then redistilled.

9. Uses of Hydrochloric Acid.—About three-fourths of all the hydrochloric acid made is used in the preparation of chlorine. The remainder is used for making the chlorides of various metals, various acids, as carbonic, etc., gelatine, superphosphates, for purifying animal charcoal, in dyeing and bleaching, in the manufacture of dyestuffs, for the preparation of various food products, in various metallurgical operations, etc.

CHLORINE

10. Historical.—About the time that soda ash was beginning to be made by the Le Blanc process, Scheele (1774) found that by certain reactions he could obtain a new substance from hydrochloric acid. He did not consider that this new gas was an element, but called it “dephlogisticated muriatic acid.” Even after the phlogiston theory had been disproved, the idea still prevailed that an acid must contain oxygen, and that since this new gas was made by taking hydrogen away from muriatic acid, it must also contain oxygen. It was not until 1810 that Davy succeeded in proving the elementary character of chlorine, and this view was not accepted by Berzelius until 1821.

In 1785 Berthollet recognized the bleaching effect of chlorine on cloth and proposed its use on a commercial scale. He advised using chlorine water for this purpose. The chlorine water did not keep well, however, and its preparation on a large scale was not convenient; so in 1789 the plan of passing the chlorine into a solution of potash was originated at the Javel works, near Paris. In this manner, potassium hypochlorite, known as *Eau de Javel*, was made.

Early in 1798 Charles Tennant, an Englishman, tried to patent a process for absorbing chlorine in milk of lime, but the patent was not allowed on account of having been anticipated by some one. In April of the next year, however, he patented the absorption of chlorine by dry, slaked lime, and so established the making of bleaching powder by our present method. During 1799 he made 52 tons of bleach, which he sold at \$700 a ton; this is striking contrast to the large amount now turned out every year, and selling at an average of \$25 or \$30 a ton, or even less.

11. Source.—Just as sodium chloride is the substance from which practically all the sodium carbonate of commerce is made, so it is also the chief source of chlorine. Potassium chloride and magnesium chloride furnish a small supply, and calcium chloride and some other chlorine compounds have been proposed as suitable material for the furnishing of chlorine, but the problem of getting the chlorine from these substances in a commercial way has not yet been solved.

12. Chlorine Direct From Salt.—In spite of the fact that the making of chlorine and sodium carbonate began to be important commercially at about the same time, and that the manufacture was frequently carried on by the same firm, and usually in the same locality, the chlorine was made direct from salt, and the hydrochloric acid from the salt-cake furnaces allowed to go to waste and become a nuisance in the neighborhood. The operation of making chlorine consisted in mixing salt and manganese dioxide and treating the whole with sulphuric acid. This brought about the reaction

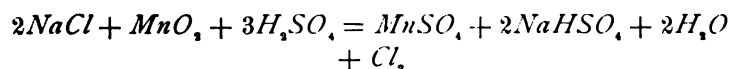

and all the chlorine was obtained from the salt, but at the expense of large quantities of sulphuric acid. A portion of this sulphuric acid can be saved if the temperature is kept

high enough to drive the reaction to the formation of the normal sodium sulphate. The reaction then becomes

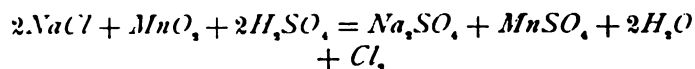

This reaction is only obtained, however, at a temperature above 120° C., which is not easy to obtain with steam, and any other method of heating is almost out of the question on account of the material necessarily used for decomposition vessels. This process is still sometimes carried out in the chemical laboratory and at a few places where chlorine is only needed in comparatively small quantities.

13. Chlorine From Hydrochloric Acid.—When the Le Blanc soda works began to increase in size and number, the escape of the hydrochloric acid into the air became such an unbearable nuisance that it had to be abated by absorbing the acid in water. This soon made hydrochloric acid abundant and cheap, so that it then came into use for making chlorine. The preparation of chlorine from hydrochloric acid consists essentially in the removal of the hydrogen from the acid by an oxidizing agent. In selecting the oxidizing substance, its cheapness and efficiency must both be taken into account, as well as the ease in handling and the resulting products. Naturally, an oxidizing substance that can be easily and cheaply regenerated by means of the air is much to be preferred to one that must be thrown away when once used.

14. Oxidation by Oxides of Manganese.—Just as oxides of manganese were used to act with salt and sulphuric acid for the preparation of chlorine, so they have been used more recently with hydrochloric acid for the same purpose, for they occur in nature in large quantities, but in varying states of oxidation. The oxides of manganese occurring in nature are manganosite MnO and pyrolusite MnO_2 , which represent the high and low degrees of oxidation, and the intermediate oxides braunite Mn_3O_4 , manganite Mn_2O_3 , H_2O ,

hausmannite Mn_2O_3 , wad, and psilomelane. The last two contain the manganese mostly in the form of manganese dioxide, but also contain varying quantities of other metals. The reactions that occur between the oxides of manganese and hydrochloric acid are as follows:

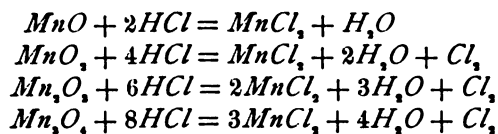

It will be readily seen that manganese dioxide yields the highest amount of chlorine for a given amount of hydrochloric acid, and that the presence of other oxides, as well as of iron, calcium, and other metals, is a disadvantage, as it lowers the oxidizing power of the ore and uses acid to no purpose. The manganese ore is usually bought according to its percentage of available oxygen, which is considered to represent the amount of manganese dioxide in the ore.

The hydrochloric acid is, of course, used in solution, and the stronger the solution, the better it is. At best, only 50 per cent. of the acid in the solution can be made to yield chlorine, as will be seen from the second reaction. The reaction does not continue after the strength of the acid has fallen to 5 per cent. and usually, under ordinary working conditions, 7 or 8 per cent. of the acid is left in the residual liquors. These latter percentages do not mean those of the acid originally present, but are the actual percentages of acid in the solution, so that it is easily seen that a far greater percentage of the acid is left unused when an acid of 10 per cent. original strength is used than when one of 35 per cent. is employed. Working under the best conditions by this method, rarely over 30 or 33 per cent. of the total chlorine of the acid is obtained in an available form.

15. Apparatus.—The stills for the decomposition of hydrochloric acid by means of manganese dioxide are made

either of earthenware or of silicious sandstone, which has been boiled in tar to make it acid proof. A small still used

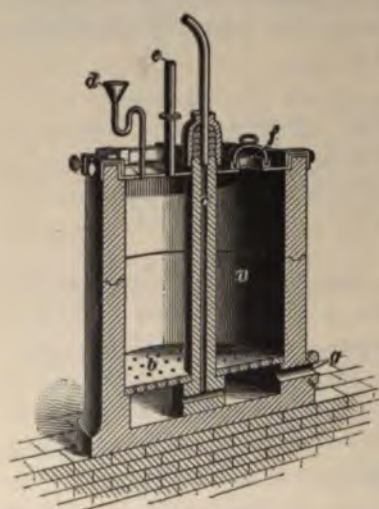

FIG. 5

in works of limited capacity, and sometimes also in larger establishments, is shown in Fig. 5. It is made from sandstone and consists of two parts joined by a tongue and groove with rubber cement. A little above the bottom of the still is a narrow ledge upon which rests the perforated section *b*. The manganese ore in small lumps is placed on *b* and the hydrochloric acid run in through *d*. The chlorine gas, as it is evolved, passes out through *e*, and as the

action slackens, steam is run into the still through *c*, and coming out under the false bottom, mixes and heats the contents of the still. At *f* is a manhole, which serves for introducing the manganese ore and for cleaning the still; the residual liquor is drawn off through *g*.

In Fig. 6 is shown another form of still, which is very suitable for the preparation of chlorine on a small scale, although it is hardly suited for larger

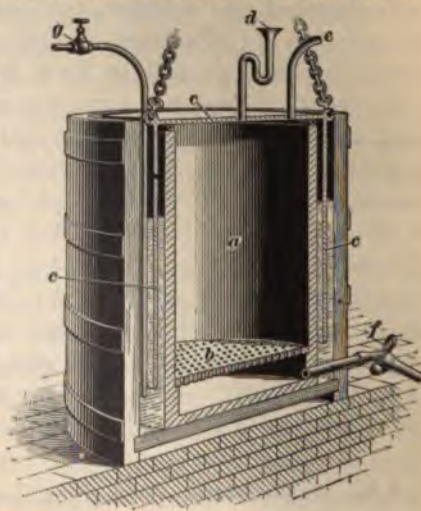

FIG. 6

works. It consists of a sandstone or earthenware still *a*, provided with a false bottom *b*, as in the above case. The still *a* is set in a wooden case and surrounded by a concentrated salt solution, which serves as a lute for the bell *c*. This bell is suspended by chains on pulleys and counterpoised by weights, so that it can be easily moved up and down as desired. In the top it is provided with a funnel tube *d* for the introduction of the acid, and an exit tube *e* for the chlorine. The spent liquor is drawn off through *f*. By blowing in steam through *g*, the salt solution can be warmed as desired and the contents of the still brought to the desired temperature without diluting the still liquor by blowing in steam.

Another form of still, which is shown in Fig. 7, is made from sandstone slabs grooved together and made tight by

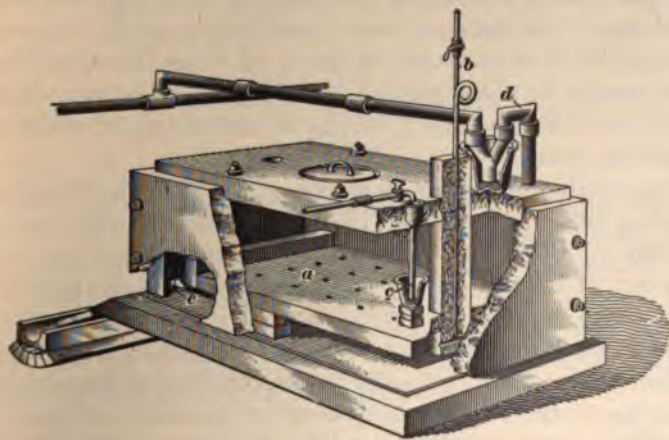

FIG. 7

means of rubber cords that fill the connecting grooves. These stills work on the same principle as those just described, but are much larger and better suited for work on a large scale. In this apparatus the lumps of manganese ore rest on the false bottom *a* and the acid is run in through *c*. The lower end of the tube *c* dips into a cup, which is continually filled with hydrochloric acid, and so forms a lute to prevent

the chlorine escaping through the tube. Steam is introduced through *b* when necessary, and the chlorine escapes through *d*. The waste liquor can be drawn off through *e* into a trough and run away.

16. Management of the Stills.—The operation consists in charging with manganese ore and then running in hydrochloric acid as rapidly as the reaction will permit. The evolution of chlorine is allowed to continue without heat for from 8 to 12 hours, when steam is blown in at intervals. Steam cannot be blown in continuously, for the temperature would become too high and too much hydrochloric acid and water would be carried over into the chlorine. The chlorine would also be likely to come off too rapidly. The pipes for conducting the chlorine are either of lead or earthenware and the gas is often conducted from several stills into one large main pipe. In this case, when a still is stopped to be cleaned and refilled it is necessary to cut it off from the main pipe. This cannot be accomplished by using valves or stop-cocks, but is brought about by a variety of means, two of which are described here.

One of these methods is shown at *d*, Fig. 7. The conducting tube is connected with a Y tube shortly after leaving the still, and this Y tube, which is open at its lower end, sets in a jar, as shown. When it is desired to bring the tube into action, the liquid in the jar is lowered to below the branching point of the Y, but its lower end is left covered. The chlorine cannot escape to the outside, but can easily pass through the branches of the Y to the large conducting main. When it is necessary to close the tube, it is easily done by filling the jar with water or a solution of salt. The branches of the Y will then be filled and the passage stopped. With this arrangement, it is necessary to empty or fill the jar each time a change is desired, which is inconvenient.

A much better arrangement consists in making a U bend in the tube, Fig. 8. At the lower end of the U a small tube is connected, to which may be fastened the flexible tube *a*. The tube *a* is connected to the cup *b*, which contains a strong

salt solution. When *b* is raised, the solution flows into the **U** tube and shuts off the flow of gas; when *b* is lowered, however, the solution flows out of the **U** tube into *b* and the passage is open for the gas.

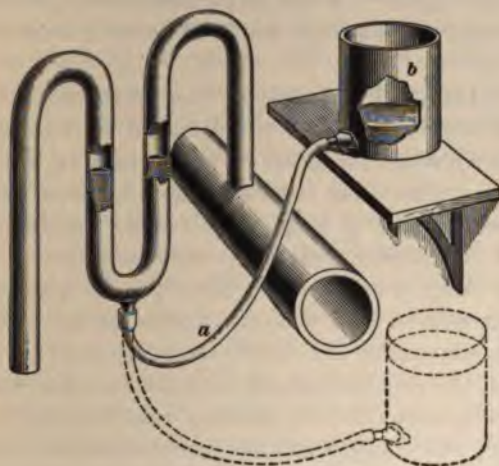

FIG. 8

17. Still Liquors.—The liquors from the stills contain, in the form of chlorides, all the manganese, aluminum, iron, calcium, etc. that were contained in the ore, together with considerable hydrochloric acid. Although the liquor varies considerably with the grade of manganese ore used and the strength of the hydrochloric acid, the following may be considered as a fairly representative analysis:

<i>HCl</i>	6.62%	<i>FeCl₃</i>46%
<i>AlCl₃</i>62%	<i>H₂O</i>	81.73%
<i>MnCl₂</i>	10.57%		

This liquor, on account of the large amount of acid that it contains, is hard to dispose of, for if given a chance it will act on the mortar in the foundations of buildings and even on the stones themselves. If run into the streams, it kills the fish and acts in a generally disagreeable manner. However disposed of, when it is first run from the still it evolves

a disagreeable odor of chlorine. In addition to all these bad qualities, the still liquor also carries away with it all the manganese, and as manganese ore began to be scarce and the price to increase, a method for treating these liquors became almost a necessity. Of the large number of processes proposed for this purpose only one will be described here.

18. Weldon's Process.—It has long been known that manganese hydrate can be precipitated by lime water and that it is somewhat oxidized by the oxygen of the air. All attempts to utilize these facts for the recovery of manganese were, however, for a long time futile, for the oxidation proceeded too slowly and could only be driven to the formation of Mn_2O_3 , or at best Mn_3O_4 . It was only when Weldon discovered that with an excess of calcium hydrate the oxidation went on more rapidly and to a greater degree that the process had any commercial possibilities. It is now practically the only process used for the recovery of manganese, and it figures in the preparation of a large percentage of all the chlorine made. The process consists in first neutralizing the still liquor with powdered chalk. An excess of chalk is to be avoided, as in settling it increases the precipitate and so increases the loss of manganese. Sufficient chalk has been added when the liquor no longer gives an acid reaction with litmus paper. The neutralized liquor is then run into settling tanks, where the excess of chalk and the iron and aluminum hydrates are allowed to deposit. The clear liquor is then run into the blowers, where it is heated to 55° C. and mixed with enough calcium hydrate to precipitate all the manganese as hydrate and then from one-fifth to one-half more of the lime is added. The calcium hydrate used for this purpose should be as pure as possible; it must especially be free from magnesium compounds, for the magnesium chloride is not decomposed by the chalk in the neutralizing tank, but goes to the oxidizer, where it is precipitated by the lime and goes on to use up hydrochloric acid at a later stage of the process. As soon as the manganese hydrate has been precipitated and a

proper amount of lime in excess is present, air is forced through the mixture and the oxidation begins. The air is blown through the apparatus for from $2\frac{1}{4}$ to 4 hours, depending on the apparatus, although at the same works the time for blowing is about the same for each batch. At the end of the first blow, a calcium manganite of practically the composition $CaO(MnO_2)_2$, together with other manganites, is formed. Then, without stopping the blowing, a suitable amount of manganese chloride (about one-fourth the amount originally taken) is run in and the blowing continued until this is oxidized as far as possible.

The oxidizing of the manganese hydrate requires considerable care and experience, for the blower must be started at exactly the right time and at the proper speed. If it is started too strongly before a sufficient excess of lime is added, the manganese is oxidized to Mn_2O_7 , and after this is once formed it is very difficult to force the oxidation any farther. Such a result is called a "red" or "foxy" batch on account of its being a brownish-red color instead of black, as it should be. On the other hand, if the blower is not started quickly and strongly enough, the contents of the oxidizer become thick, so that it is very difficult to force the air up through it; such a result is called a "stiff batch." The only remedy is to start the blower at full strength and carry the batch by this point, if possible. A stiff batch may also be caused by too high a temperature or too little calcium chloride in the mixture. The best mixture contains about 3 gram molecules of calcium chloride to each gram molecule of manganese chloride. For the total oxidation, it is estimated that 300,000 cubic feet of air are required to recover the manganese for each ton of bleach made. At many works the addition of the manganese chloride and the continuation of the oxidation is not practiced. That it is advisable, however, is shown by a consideration of the reactions taking place in the Weldon process.

19. Reactions.—If we leave out of consideration the neutralization of the still liquor, which really is not one of

the parts of the process proper, the first reaction is the precipitation of the manganese hydrate, which, if represented for 100 gram molecules of manganese chloride, is

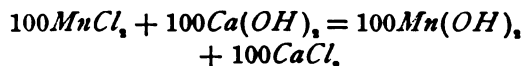

For oxidation, the extra lime is added, as mentioned above, and air blown in; the reaction then taking place, neglecting the nitrogen of the air, may be represented thus:

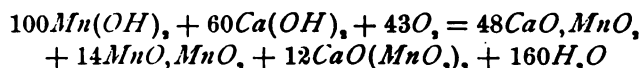

This is, if we consider the oxidizing and basic parts separately, equal to $86MnO_2 + 74(CaO + MnO)$. Thus, out of 100 gram molecules of manganese chloride we get 86 gram molecules of MnO_2 , or active material for oxidizing the hydrochloric acid; but we have also 74 gram molecules of substances that neutralize and so destroy hydrochloric acid and yield no chlorine. Now, if we add an extra quantity of manganese chloride, a part of the above material reacts, and we get

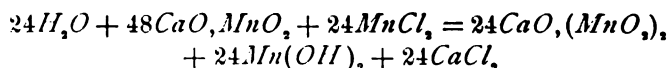

Then, by blowing, the manganese hydrate is oxidized according to the equation

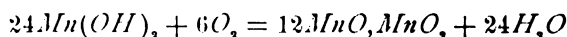

By collecting the above equations and adding them algebraically, we have

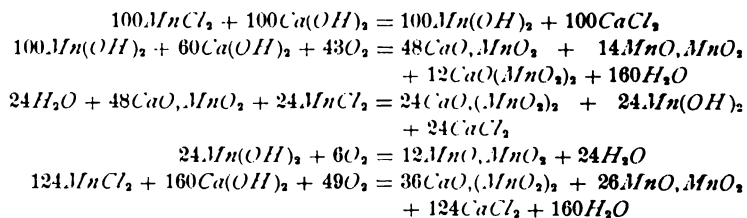

From this last equation it may be noted at once that at the end of our operations we have a mixture of $36CaO$,

$(MnO)_2$, and $26MnO, MnO_2$, or $98MnO_2 + 36CaO + 26MnO$, from 124 gram molecules of manganese chloride. That is, we have 79 per cent. of the manganese in the form of the dioxide, as against 86 per cent. of the manganese in this condition before the last addition of manganese chloride. The present condition is much better, however, for although the percentage of the manganese converted to the dioxide is somewhat smaller than before, the amount of base present is much more reduced than the active manganese. Before the second addition of manganese chloride, there are 74 gram molecules of base to 86 gram molecules of manganese dioxide, that is, 53.75 per cent. of the total number of gram molecules that can react with hydrochloric acid is manganese dioxide. When the operation is completed, however, there are only 62 gram molecules of base to 98 gram molecules of the manganese dioxide, or 61.25 per cent. of the active gram molecules is manganese dioxide. It is obvious, then, that the second addition of manganese chloride and longer blowing is a decided advantage.

20. Weldon Mud.—The mixture of calcium and manganese manganites obtained by the above operations is a black, shiny precipitate, which is in suspension in a solution of calcium chloride. This mixture is run from the oxidizers to the settling tanks, where it is allowed to stand for 3 or 4 hours. At the end of this time the precipitate will have settled into the lower half of the solution and the clear calcium chloride solution can be drawn off from the top; the shiny mass remaining is called Weldon mud. The Weldon mud finds several uses besides the preparation of chlorine; it is used in gas purifiers, to remove iron from alum, to remove sulphides from caustic soda, and for several similar purposes. Weldon at one time recommended it for neutralizing the still liquors instead of chalk, but later abandoned it for that purpose. At present it is used quite extensively in that way, for it not only saves the chalk, but also utilizes the acid of the liquor to neutralize the bases in the mud, and so increases the efficiency of the mud as an

oxidizing agent. The use of Weldon mud for neutralizing the still liquors has the disadvantage that all the impurities, such as calcium sulphate, iron, and aluminum, are left in the mud. This makes it necessary to occasionally neutralize a batch with chalk and allow the impurities to settle out. When this method is used, great care is taken to keep sulphuric acid out of the hydrochloric acid. Sometimes calcium chloride is added to precipitate the sulphuric acid before the hydrochloric acid is used.

CHLORINE BY THE WELDON PROCESS

21. Of course the chief use for Weldon mud is the generation of chlorine, and for this purpose it is much more active than manganese ore. The stills used are similar to those already described, but the method of working is somewhat different from that when manganese ore is used. In working with the Weldon mud, the hydrochloric acid is run as hot as possible directly from the condensers into the stills, and the Weldon mud is then added slowly, so as to regulate the flow of chlorine until sufficient for the acid is present. Too much must not be added, especially if the still liquors are neutralized by chalk, for in that case the manganites, that are unacted upon, will settle with the mud from the neutralized liquors and be lost. When the color of the liquor in the still shows that enough mud has been added, steam is blown in and the chlorine driven off as completely as possible. It is possible in this way to leave only from $\frac{1}{2}$ to 1 per cent. of free hydrochloric acid in the still liquor. This is equivalent to about 3 per cent., as counted on still liquor from manganese ore, for the water in the Weldon mud makes its still liquor more dilute than that from manganese ore. From $1\frac{1}{2}$ to 3 per cent. of the manganese is lost in the cycle of operations, and this is supplied by continuously decomposing the necessary amount of manganese ore in a small still and adding its liquor to the general supply. Only about 30 per cent. of the chlorine in the hydrochloric acid is obtained in the bleaching powder.

The remainder is, for the most part, run to waste as calcium chloride.

22. Apparatus.—The apparatus by means of which this cycle of operations is performed is shown in Fig. 9, which represents a cross-section through part of it. Starting with

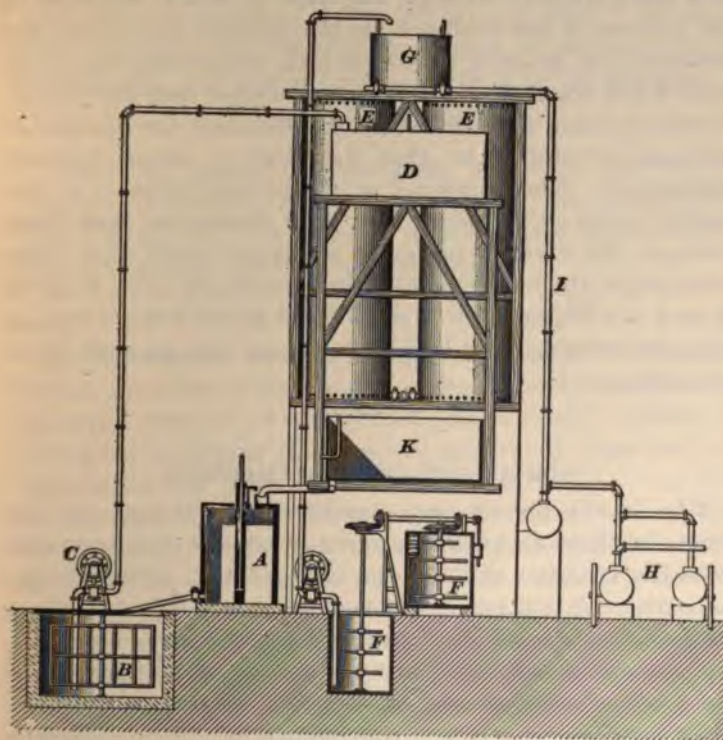

FIG. 9

the still liquor from the still *A*, the liquor runs into the neutralizing tank *B*, where it is mixed with chalk or Weldon mud and thoroughly stirred. It is then pumped, by means of the pump *C*, through the pipe shown, to the settling tank *D*. If chalk has been used for neutralizing, the mud obtained is valueless. If Weldon mud was used, however, the mud here obtained can be used in the chlorine still.

From *D* the neutralized liquor goes to the oxidizers *E, E*. Lime is, meanwhile, slaked in *F, F*, and made to the proper consistency. It is then pumped, by the pump and pipe shown, to the reservoir *G*, from which place it is run in proper quantities into the oxidizers *E, E*. Air is forced into the mixture through the pipe *I*, which extends to the bottom of the oxidizers, by the blowers *H*. From the oxidizers the batch is drawn off into the settling tanks *K*, from which the mud is again run as needed into the still *A*. It will be noted that almost all the materials are moved as solutions or slimes, so that the work is almost entirely mechanical. The solutions or slimes are pumped to the highest point of the plant and then allowed to flow down through the various pieces of apparatus until they once more reach the lowest point. Practically the same number of men are required for a small plant as for a large one, so that the working of a large plant is on this account more economical.

DEACON'S PROCESS FOR CHLORINE

23. In the process just described the manganese has acted simply as an oxidizing agent to remove the hydrogen from the chlorine and set the latter free. Although the steps are a little farther removed, there is a direct analogy between this operation when the Weldon manganese-recovery method is employed and the making of sulphuric acid where nitric oxide is used as a carrier of oxygen from the air. And, just as recently the problem of causing sulphur dioxide to combine directly with the oxygen of the air by passing a mixture of the two gases over platinized asbestos or ferric oxide has been solved in a practical manner, so, much earlier, it was found that when hydrochloric acid and air are passed over porous material saturated with salts of copper, lead, or manganese the oxidation of the hydrochloric acid takes place direct.

It was discovered and patented by Oxland in 1845 that when a mixture of hydrochloric acid and air is passed

§ 30 ALKALIES AND HYDROCHLORIC ACID 23

through a tube filled with red-hot pumice, the following reaction takes place:

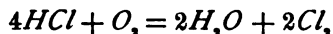

This is a reversible reaction, however, and, under the conditions here stated, the decomposition of the hydrochloric acid is very incomplete. Ten years later, 1855, Vogel found that when cupric chloride is heated it decomposes into cuprous chloride and chlorine according to the reaction

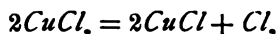

Then by passing hydrochloric acid and air over the cuprous chloride, an oxychloride of the composition $CuCl_2, 3CuO, 3H_2O$ is formed, which finally goes over into cupric chloride, the final reaction being

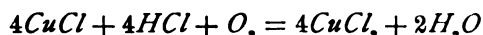

It was found, however, that in practical working only about one-third of the chlorine was obtained from the cupric chloride, instead of the theoretical one-half. There was also a loss of copper salts, and on account of these and other difficulties, the process was never successful.

The idea occurred to Deacon, however, to combine these two methods, and he took out his first patent to that effect in 1868. Various contact substances have been proposed and patented, but certain salts of copper are found to be the best. In general, the process as carried out now consists in passing a suitable mixture of hydrochloric acid and air through tubes containing clay balls saturated with a copper salt. Copper sulphate is generally used to saturate the balls, but it is claimed that this is soon converted into the chloride. The reactions taking place in the tube are generally considered to be

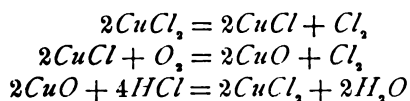

It is held by some, however, that the copper salt only acts catalytically, and the reaction is direct between the acid and the oxygen.

DETAILS OF THE PROCESS

24. Hydrochloric Acid.—The acid used for the Deacon process must be of as uniform a composition as possible and free from dust, sulphuric acid, and arsenic compounds, for otherwise the contact substance deteriorates very rapidly. The uniformity of composition is not hard to get when the acid is liberated from its solutions. When it goes to the decomposer direct from the salt-cake oven it is not so easy to maintain a uniformity, for the acid is given off rapidly at first and more slowly later. This difficulty is largely avoided, however, by connecting several furnaces to each decomposer, so that by charging the salt-cake furnaces in rotation a nearly uniform flow of acid gas is obtained. Where the acid is used direct from the salt-cake ovens, only the pan acid is used; for this is much purer than that from the roaster, and the acid from the latter can be condensed and sold as acid or used in the Weldon process. At the present time it is customary at many works to condense all the hydrochloric acid produced and then liberate the gas from its solution by running it into hot, concentrated sulphuric acid and blowing a current of air through the mixture; a very pure hydrochloric-acid gas is thus obtained. This method of purifying the hydrochloric acid was worked out by Hasenclever, and has done much to make the Deacon process a success; for this reason, the process is frequently referred to as the **Deacon-Hasenclever process**.

Calcium chloride has been proposed for setting hydrochloric acid free from its solutions. It possesses no advantage over sulphuric acid for this purpose, however, and the latter is more generally used.

25. The hydrochloric acid is mixed with about an equal volume of air, which furnishes the theoretical amount of oxygen necessary to decompose it. Since, however, even in the presence of a catalytic substance, the reaction is not complete, an excess of air will drive the decomposition of the hydrochloric acid farther. The disadvantage, however, enters here, that the excess of air dilutes the already much

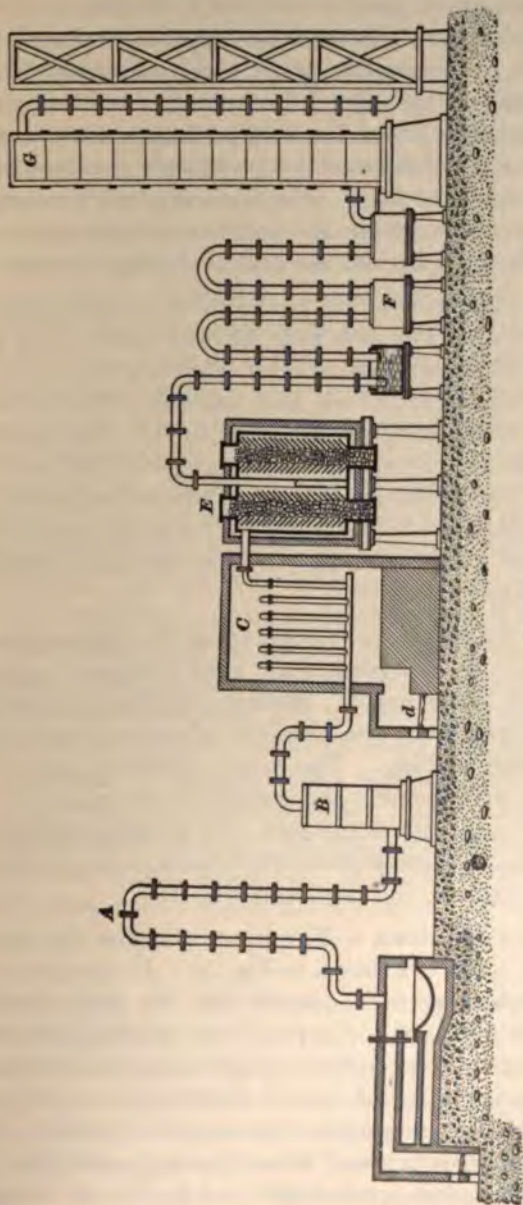

FIG. 10

diluted chlorine, so that it is better to allow a portion of the acid to escape decomposition than to produce such dilute chlorine. The mixture of air and hydrochloric acid must be as dry as possible—the drier the better—before going to the decomposer. It has been found in practical working, however, that very satisfactory results are obtained if the mixture is cooled to 37° C. Gas saturated with moisture at that temperature works in the hot decomposer nearly as well as perfectly dry gas, and the cost of drying is saved.

26. A portion of the reactions in the decomposer absorbs heat and a part evolves heat, but the sum total of these reactions is an evolution of several calories of heat for each gram molecule of hydrochloric acid oxidized. There is not enough of this heat, however, to make up for loss through radiation and also bring the gas mixture to the best temperature for the decomposition. It is, therefore, advisable to heat the gas mixture to about 450° C. before it goes to the decomposer, as it is found that this is the best temperature for decomposition.

27. The gas that issues from the decomposer consists of a mixture of hydrochloric acid, chlorine, oxygen, nitrogen, and water vapor. Both the hydrochloric acid and the water vapor must be removed if the chlorine is to be used for bleach making. The gases, therefore, pass through a cooling arrangement to condense the water as much as possible, and with it the acid. It is then washed with water and is finally passed through towers, down which sulphuric acid is sprayed, to completely dry it.

28. Apparatus.—The apparatus for carrying out the Deacon process is shown in Fig. 10. It consists of a cooling and condensing arrangement for the gases as they come from the salt-cake furnace or from the Hasenclever purifier. This cooling and condensing apparatus consists usually of a long, upright pipe *A* and a small coke or plate tower *B*. The gas mixture goes to the heater *C*, which consists of a series of pipes, up and down through which the gas must pass. The pipes are enclosed and heated by the gases from

a fire on the grate *d*. The gases having been heated to about 450° C. pass into the decomposer *E*. Several forms of this piece of apparatus have been proposed, but the one here represented is the most satisfactory. It consists of a large circular outer chamber, into which the mixture of air and acid passes from the heater. Arranged inside of this chamber, so that the gas must pass through them, are the cylinders containing the catalytic material. The walls of these cylinders are made similar to Venetian blinds, so that the gas must take a downward course on entering, and after traversing the filling, it takes an upward course on leaving. The gases from the whole system collect in the center and are drawn off by a pipe to the purifying apparatus. Each cylinder is arranged so that it can be cut out of action when necessary for emptying and refilling, for the catalytic material deteriorates slowly by use and must be renewed about every 12 weeks. Frequently, in the style of decomposer represented here, all the cylinders are kept in continuous action, and when it is necessary to recharge them the fresh material is charged at the top as rapidly as the old is withdrawn at the bottom. For cooling and washing the gas that comes from the decomposer, a large number of methods have been proposed, but the one illustrated at *F* is probably the most efficient and at the same time the most simple. It consists of upright pipes, which serve to cool the gases, and end in troughs of water, which washes out the hydrochloric acid. Finally, the gas is completely dried by sulphuric acid in the towers *G*. A suitable vacuum is maintained in the whole apparatus by means of a pump placed beyond *G*.

29. Comparison of the Weldon and Deacon Processes.—It is difficult to say whether the Weldon or the Deacon process leads in the production of chlorine at the present time, and it is equally difficult to say which process is the better, as this depends on general conditions.

In the old manganese-dioxide method, theoretically 50 per cent. of the chlorine of the acid was obtained free,

but in practice not over 30 to 33 per cent. was realized. In the Weldon process, only 40 per cent. of the chlorine of the acid is theoretically available, but about 30 to 33 per cent. is also obtained here and the manganese is recovered as well. In both cases a strong chlorine is made. In the Deacon process, 100 per cent. of the chlorine in the acid is theoretically obtainable, and in practice 50 to 80 per cent.; the rest is recovered as acid to be used over. The chlorine is much diluted, however, only averaging 7 to 10 per cent. chlorine, so that it is not so suitable for as many purposes as the stronger gas obtained from the other methods.

THE NITRIC-ACID CHLORINE PROCESS

30. A number of processes have been proposed that involve the oxidation of hydrochloric acid by means of nitric acid, according to the reaction

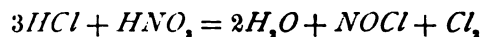

This gives two-thirds of the chlorine in a free state and leaves one-third combined in nitrosyl chloride. It is then necessary to set the chlorine free from this compound and regain the nitric acid by oxidation. This is accomplished by treating the nitrosyl chloride with concentrated sulphuric acid and then with air and steam. All the different processes belonging to this class employ this reaction, and only differ in the methods of mixing the materials so as to obtain the best results. They all give a high yield of very concentrated chlorine; there is very little loss of hydrochloric acid, and 95 per cent. of the nitric acid can be recovered and returned to the process. On the other hand, the handling and concentrating of such large quantities of acid as are required are difficult and dangerous, and the wear and tear on the apparatus is very considerable.

31. Where chlorine is used in large quantities it is sometimes made on the spot, either directly from salt or from hydrochloric acid. The use of salt is, however, almost

obsolete, and the carrying of hydrochloric acid is inconvenient and somewhat dangerous. For this reason it can rarely be economically made at any place far removed from alkali works. On the other hand, the chlorine gas is bulky and must be converted into some compact form for shipment.

32. Liquid Chlorine.—Chlorine is a gas that is comparatively easily liquefied, for it becomes liquid when cooled to -34° C. at the ordinary atmospheric pressure, or when subjected to a pressure of 6 atmospheres at the ordinary temperature. It is such a corrosive substance, however, that until recently it was not considered possible to find pumps to work it, or tanks to hold it when it was compressed. The pumps used in compressing chlorine consist, for the most part, of a plunger that works in petroleum and forces the petroleum against a column of sulphuric acid. The chlorine collects over the acid, and when the acid is raised the chlorine is forced into a tank and compressed. Moist chlorine acts very strongly on iron at the ordinary temperature; but when perfectly dry, chlorine has practically no action on iron, and iron tanks can be safely used for storing and shipping it when in the liquid form. One volume of liquid chlorine is equal to 400 volumes of chlorine gas at ordinary conditions of temperature and pressure.

BLEACHING POWDER

33. When chlorine is passed over dry, slaked lime a compound is formed that again gives up the chlorine when treated with an acid. This compound was at first supposed to be calcium hypochlorite $Ca(OCl)_2$, and was called *chloride of lime*. It is now more commonly known as *bleaching powder*. Bleaching powder only yields 100 volumes of chlorine for each volume of the substance and requires acid to set it free. It is, nevertheless, a most convenient means for the transportation and storing of chlorine and is almost universally used.

34. Lime.—The lime used for making bleaching powder should be very pure and well burned. Impurities are bad in various ways, for in addition to making it impossible to make a strong bleach, if the lime does not contain a high percentage of calcium oxide, clay and similar substances cause the bleach solutions to settle badly. Iron and manganese cause a colored bleach, which does not sell well, and these substances cause a more rapid decomposition of the bleach than would otherwise occur. A limestone of as great purity as possible having, therefore, been selected, it is burned in such a manner as to avoid having the ashes of the fuel mix with the lime. A reverberatory furnace is frequently used for this purpose. The carefully burned quicklime is slaked by sprinkling with water; and as an excess of water cannot be used, it is better to let the lime lie for 2 or 3 days to allow it to slake well through before using. Perfectly dry, slaked lime does not work well with chlorine and, on the other hand, too great an excess of water must be avoided or the lime will cake together and not chlorinate through. Theoretically, calcium oxide requires 32 per cent. of its weight of water to convert it into the hydrate, and from 2 to 4 per cent. of water in addition to this, depending on the dehydration of the chlorine, is generally used. After slaking thoroughly, the lime is sifted through a sieve having from 12 to 25 holes to the linear inch. The finer the division of the lime, the better it absorbs the chlorine. It is now ready to spread in the *absorption chambers*.

35. Absorption Chambers.—The chambers for absorbing the chlorine are commonly large rooms made of brick or stone laid in asphalt cement; though they are sometimes made of lead, which is probably the best material and is not much more expensive than the other. The floors are either of asphalt or lead. The lime in the chambers must be turned over when the layer is thick, so that the chambers must be high enough for a man to stand upright in while turning and removing the material. An ordinary chamber is about

100 feet long, 30 feet wide, and $6\frac{1}{2}$ feet high. It is usually estimated that 200 square feet floor space is required per ton of bleach per week. The slaked lime is spread on the floor in a layer from 2 to 4 inches thick and is furrowed by a rake to give a large absorbing surface. The gas passes into the chamber at the top of one end and out of the top of the opposite end. The chlorine, being heavy, settles to the bottom of the chamber and is very rapidly absorbed at first and then more slowly, as the lime becomes more nearly saturated. In the case of single chambers, when the absorption becomes too slow, the gas is shut off and, after freeing the chamber of chlorine, men go in and turn and relevel the lime. In the more modern works, where three or more chambers are worked together, the turning can be avoided, for the strong gas goes into the most nearly finished chamber and then to fresher lime, so that the chlorine does not escape. When the layer of lime is not over 2 inches thick the operation will usually be finished without turning the material; when the layer is over 2 inches, the material must usually be turned. A second passing of the gas will usually bring the available chlorine in the bleach to 36 to 38 per cent., and that is sufficient. If this is not obtained, the material must be turned a second time and then treated with gas again. If this does not bring the bleach to the desired strength, it must be packed and sold for what it will bring, for further treatment with chlorine will only result in the decomposition of the bleach already formed.

36. Chlorine.—The chlorine must be free from carbon dioxide and hydrochloric acid and as free from water as possible. The stronger the chlorine the better, and very dilute chlorine, such as comes from the Deacon method, cannot be used in this form of apparatus. The chlorine must be introduced into the chamber very slowly, so as to avoid a rise in temperature, for if the temperature is too high, chlorates will form and the bleach decompose, giving oxygen. On no account should the temperature go above 40° or 45° C., and a lower temperature is better.

37. The opening of the chamber to turn or remove the bleach is disagreeable, for the chlorine escapes into the air. This is obviated somewhat by letting the chambers stand for some time before opening, or, better, by sprinkling a little fine dust of calcium hydrate in from the top. At best there is a great deal of hard and disagreeable work connected with the process, and the plant covers a large area. The attempt has been made to do away with these difficulties by stirring the lime mechanically while it is being chlorinated. By this means the lime is chlorinated rapidly and discharged into the barrels without much hand labor. The great disadvantage exists that, by such rapid absorption of the chlorine, the temperature gets too high. This has been somewhat obviated lately by cooling the apparatus from the outside.

38. As already mentioned, the apparatus that is suitable for strong chlorine cannot be used for the more dilute chlorine obtained in the Deacon method, for the absorption is too slow with such weak gas. Deacon avoided this difficulty by using large stone chambers in which shelves were placed close together. On the shelves the finely powdered slaked lime was spread in layers not over $\frac{1}{4}$ inch thick and the chlorine passed downwards over these shelves. This arrangement works very well, but it requires very large chambers. For each ton of bleach produced in a week a shelf space of 1,373 square feet is necessary. With the dilute chlorine, the absorption is not so rapid and the mechanical chlorinating apparatus can be used to good advantage.

39. Properties of Bleaching Powder.—The chloride of lime should be a white powder or in lumps that will easily break. It is acted on by the carbon dioxide of the air, and so loses strength if left open; even when protected from the air it slowly loses strength, especially when it is jarred as in transport. It has a peculiar odor, probably due to chlorine. It is usually packed tightly in barrels to exclude air and moisture, and these should be kept out of the sun as far as possible. The bleach loses about 1 per cent. of chlorine in packing (probably chlorine that is mechanically held in the

bleach) and then should have from 33 to 38 per cent. of available chlorine at the works. When bleach is imported into this country, it rarely contains over 32 or 33 per cent. of available chlorine, the rest being lost in transportation.

40. Composition of Bleaching Powder.—When bleaching powder was first made, it was considered to be calcium hypochlorite $Ca(OCl)_2$. It was then shown that this was improbable and that certain considerations seemed to lead to the view that it was a mixture of calcium chloride and hypochlorite $CaCl_2 + Ca(OCl)_2$. There are, however, several reasons for thinking that this formula is incorrect. Among others, it might be mentioned that if it contained calcium chloride it should be deliquescent, but bleach is not; calcium chloride is soluble in alcohol, but it cannot be extracted from bleach by this means. Lunge has proposed the formula $Ca \begin{matrix} Cl \\ < \\ OCl \end{matrix}$ for the substance, and has so well supported this view by experiment, that it is generally accepted as correct. When bleach is dissolved in water, it breaks up into calcium chloride and hypochlorite.

41. Valuation of Bleach.—The only constituent that bleaching powder contains that is of value is the chlorine that can be utilized for bleaching purposes. The amount of the available chlorine is determined by analysis, and in most countries, outside of France, the value of the bleaching powder is expressed in terms of the percentage of the available chlorine contained, as shown by analysis. For example, a 32-per-cent. bleach means that the bleach under consideration contains 32 per cent. of chlorine that is available for bleaching purposes. In France, and to some extent outside of that country, the strength of the bleach is expressed in Gay-Lussac degrees—that is, the number of cubic centimeters of chlorine gas, reduced to the standard conditions of 0° C. temperature and 760 millimeters of mercury pressure that 1 gram of the bleaching powder will yield. If we remember that 1 gram of chlorine under standard conditions occupies 314.7 cubic centimeters, it is easy to calculate the

Gay-Lussac degrees from the percentage in the composition. For example, if we have 32 per cent. of available chlorine in a sample of bleach, each gram of the bleach contains .32 gram of available chlorine and will yield $314.7 \times .32 = 100.7$ cubic

TABLE I

Gay-Lussac Degrees	English Degrees	Gay-Lussac Degrees	English Degrees	Gay-Lussac Degrees	English Degrees
63	20.02	85	27.01	107	34.00
64	20.34	86	27.33	108	34.32
65	20.65	87	27.65	109	34.64
66	20.97	88	27.96	110	34.95
67	21.29	89	28.28	111	35.27
68	21.61	90	28.60	112	35.59
69	21.93	91	28.92	113	35.91
70	22.24	92	29.23	114	36.22
71	22.56	93	29.55	115	36.54
72	22.88	94	29.87	116	36.86
73	23.20	95	30.19	117	37.18
74	23.51	96	30.41	118	37.50
75	23.83	97	30.82	119	37.81
76	24.15	98	31.14	120	38.13
77	24.47	99	31.46	121	38.45
78	24.79	100	31.78	122	38.77
79	25.10	101	32.09	123	39.08
80	25.42	102	32.41	124	39.40
81	25.74	103	32.73	125	39.72
82	26.06	104	33.05	126	40.04
83	26.37	105	33.36	127	40.36
84	26.69	106	33.68	128	40.67

centimeters of chlorine under standard conditions, or it is 100.7° Gay-Lussac, strong. These are sometimes called *French degrees*, and the percentage of available chlorine in the bleach is frequently called *English degrees*. Table I

shows at once the relation between the Gay-Lussac degrees and the English degrees.

42. Uses.—Bleaching powder is mostly used for bleaching vegetable fibers. The fiber to be bleached is first saturated with the bleach in clear solution, it is then “soured” by passing it through dilute acid, and is finally washed. Since the bleaching powder must be dissolved, it would seem that it might better be made direct in solution, as was done in the early days of the industry. The solution of bleaching powder does not keep well, however, and the large amount of water makes it inconvenient and expensive to transport. The liquid bleach is, therefore, only made in the few cases where the bleaching establishment is near an alkali works. In making liquid bleach, the chlorine is not passed through the milk of lime, for this would put too much pressure on the chlorine stills, but goes over the surface of the liquid and is so absorbed.

43. Eau de Javel.—The first bleach that was made was prepared by passing chlorine into a solution of potassium carbonate (crude potash). As the works were situated at Javel, near Paris, it took its name from that place. A little later sodium carbonate was substituted for the potash, and the solution made from this substance became known as *Eau de Labarraque*. This latter substance is still sometimes made and used for certain purposes. When the chlorine is passed over a sodium-carbonate solution, the first action is to convert the carbonate into the bicarbonate and form hypochlorous acid, according to the reaction

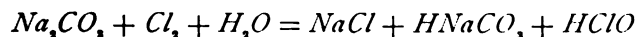

If the chlorine is passed long enough, the bicarbonate is decomposed and the carbon dioxide evolved. This reaction is

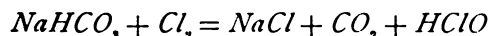

In this case, however, chlorate is likely to be formed. Another class of liquor, which is more stable than the above,

is made by passing chlorine over caustic soda. The solution must be left slightly alkaline and kept cool to prevent the formation of the chlorate. The reaction then is



By this means we have a fairly stable solution of bleaching material. Until recently it was not considered possible to make this bleach solution stronger than 15 per cent. of available chlorine, and that strength kept badly. It has been found, however, that this instability is caused by the presence of sodium ferrate, which acts catalytically and causes the solution to decompose. When the sodium hydrate is carefully purified from iron, solutions of the hypochlorite containing as high as 50 per cent. of available chlorine can be made, and solutions with 35 per cent. of available chlorine are quite stable. Solutions with 20 per cent. of available chlorine can be kept for weeks with practically no change. The solution must be kept slightly alkaline, however, or the hypochlorite will change over into the chlorate.

44. With aid of the bleach liquors so far spoken of, it is necessary to use acid to get the bleach effect, and then it is necessary to wash thoroughly. Sometimes this is disadvantageous, and other hypochlorites are made that decompose more readily on the fiber and so do not need acid. These are practically all made from the calcium hypochlorite. The aluminum bleach is the most important of these, and its method of preparation is typical of the method used in the preparation of all the others.

The aluminum bleach consists of a solution of a mixture of aluminum chloride and hypochlorite that is made by treating a solution of calcium bleach with aluminum sulphate; the calcium sulphate separates out and the aluminum compounds are left in solution. The aluminum hypochlorite is very unstable and is only made as needed. It is so very unstable that it decomposes on the fiber without the use of acid, and the aluminum compound left is antiseptic, so that it not only does not need to be washed out, but in

many cases it is a decided advantage to leave it on the bleached material. For example, when used to bleach paper stock the aluminum chloride prevents fermentation when the stock is stored.

POTASSIUM CHLORATE

45. There are at present two general methods for making potassium chlorate, the electrolytic, which will be discussed in its proper place, and the chemical. The most generally used chemical process consists in making calcium chlorate and converting this into potassium chlorate by adding potassium chloride and allowing the less soluble potassium chlorate to crystallize out. The calcium chlorate is made by absorbing chlorine in milk of lime; so that probably calcium hypochlorite is first formed and this is transformed into the chlorate. The reactions taking place are doubtless

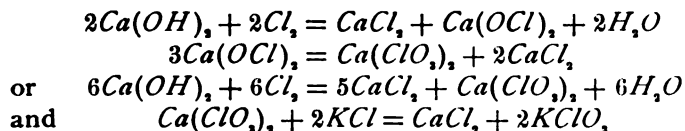

A greater saving is made in this way than would be made by starting with caustic potash instead of caustic lime.

RAW MATERIALS

46. Lime.—The lime used for this process should be the very best and as free from impurities as possible. It is usually burned in a reverberatory furnace. The thoroughly burned lime is slaked, made into milk of lime, and strained before it goes to the absorbers. It should then be used without delay, as otherwise calcium carbonate will form, and this leads to a loss of chlorine.

47. Chlorine.—Chlorine made by either the Weldon or the Deacon process can be used, and generally no attempt

is made to remove the water and carbon dioxide. The hydrochloric acid is only removed when it occurs in such large quantities as in the Deacon process. Chlorine made by Weldon's process is much preferred, as it is stronger and so gives better absorption.

48. Potassium Chloride.—The potassium chloride used is almost entirely imported from Germany and contains from 90 to 93 per cent. of potassium chloride. The other constituents are mostly soluble and do but little harm. The following analysis gives a fair idea of the average composition of commercial potassium chloride, so-called *muricates*.

H_2O	4.50%	Na_2SO_430%
Organic.....	.05%	$CaCl_2$25%
Insol. and Fe_2O_3	.15%	$MgCl_2$50%
Al_2O_347%	$NaCl$	2.25%
$Al_2(SO_4)_3$20%	KCl	92.00%

49. Water.—The water, especially that used for crystallization, must be pure. Suspended matter tends to prevent the formation of crystals and leaves them impure when formed. The presence of sulphides leads to the formation of lead sulphide, for there is usually lead in the final liquor from the lead crystallization pans. Sulphates are liable to be reduced by organic matter and so lead to the presence of sulphides, so they must be excluded; for the lead sulphide would make the crystals dark colored and spoil their sale. Iron and carbonates are also objectionable, but are not so bad as the other substances.

APPARATUS AND PROCESS

50. Absorbers.—In making the calcium chlorate, the chlorine must be passed over the surface of the milk of lime. The absorption of the chlorine by this material takes place in large, flat, quadrangular tanks, which are built of slabs of sandstone. Where the sandstone slabs come together,

they are grooved out and a thick rubber cord is introduced. The whole is then tightly fastened together with iron tie-rods placed around the outside. In order that the absorption may take place more readily, each tank is fitted with an agitator that stirs and splashes the milk of lime so that an intimate mixture of it and the chlorine takes place. These agitators pass into the tanks through hydraulic lutes; the manholes in the tanks are also provided with hydraulic lutes, so that the tanks are closed tightly when in operation.

The absorbers are usually set up in series of from three to five, so that the liquor can flow from one to the next and the chlorine enters the absorber that is most nearly finished and leaves the one newly charged. The gas that leaves the last absorber is nearly free from chlorine, but is finally run through a tower, down which milk of lime is flowing, in order to remove the last trace of chlorine before the gas escapes into the air.

In carrying out the operation, the lowest absorber is emptied when the absorption is complete and the contents of each absorber run into the next lower one. The upper absorber is then charged with milk of lime of 1.085 or 1.100 sp. gr. (that is, about 113 grams CaO per liter). The absorber should not be charged over two-thirds full, for there is danger that it will foam over at some stage of the absorption. Chlorine is now passed into the lowest absorber and continued until all of the lime is converted into calcium chloride and calcium chlorate. As the chlorine is absorbed, the temperature of the absorbing liquid gradually rises and must be carefully watched. The temperature should not be allowed to exceed $55^{\circ} C.$; or the yield of chlorate will suffer in consequence. The temperature can be very easily regulated by regulating the flow of chlorine. The charge requires from 12 to 30 hours from the time it is first run in until it is finished. The time depends on the size of the absorbers and the strength of the chlorine gas and the milk of lime. Slow absorption, using weak solutions, gives the best results from a chemical point of view, but, on the other hand, more concentrated

solutions and quick absorption save time and fuel, so that a balance must be struck for each locality, depending on the price of coal.

The end of the reaction in the absorber is shown by the appearance of a pink color, due to the formation of calcium manganate from manganese in the lime or carried over with the chlorine. Another rapid test consists in filtering off a little of the solution and adding dilute hydrochloric acid to it. An effervescence, or evolution of chlorine, shows that the solution still contains calcium hypochlorite and that the operation is incomplete.

51. Settling Pans.—When the absorption is completed, the finished liquor is run into large iron pans, where it is left for from 3 to 10 hours for the insoluble matter, such as sand, calcium carbonate, etc., to settle out. The capacity of the settling pans must at least equal the capacity of the absorbers, for on account of the sand, etc., that settle in these pans their actual capacity is frequently much less than their nominal. When the liquor has settled thoroughly, it is pumped by means of force pumps having gun-metal barrels to a higher level, in order that it may then run by gravity through the rest of the operations. The best suction pipe for the pump is a short rubber hose, which can be moved so as to suck the liquor close to the mud, without getting part of the latter into the concentrating pots.

The mud is allowed to accumulate in the pans until they are nearly half full, it is then washed two or three times; the wash water is used in making milk of lime, while the mud is thrown out.

52. Concentrating Pots.—The liquor from the settling pans is carefully gauged and a sample sent to the laboratory for analysis. Meanwhile, the liquor goes to the concentrating pans, which are best made of cast iron and are similar in size and shape to those used in making caustic soda (see *Alkalies and Hydrochloric Acid*, Part 1), and is here warmed. By this time the analysis of the liquor should be made and the amount of potassium chloride necessary to

convert the calcium chlorate into potassium chlorate is calculated. This amount, plus about $1\frac{1}{2}$ per cent., is then added and the whole concentrated to about 1.31 sp. gr. (taken hot). In winter, a slightly lower specific gravity will answer.

53. First Crystallizing Pans.—The concentrated liquor is now baled into the crystallizing pans. These are usually U-shaped and are set into brickwork a slight distance above a cement floor. These pans are built of iron and should be of such a size that the contents of a pot just fills a certain number of them. The room in which these pans are set should have a cement floor that slopes towards a catch basin. The pans are left for 9 or 14 days, depending on the time of year, to crystallize the liquor.

The crystals are filtered off by means of a centrifugal machine, thoroughly washed with water to remove the calcium chloride and iron, and then recrystallized.

The mother liquor, which is mainly calcium chloride, contains from 10 to 35 grams of potassium chlorate per liter, and is cooled to -10° C. by artificial means. In this way the amount of potassium chlorate is reduced to about 3 grams per liter.

54. Recrystallization.—The crystals obtained by the first recrystallization always contain considerable impurities and are therefore placed in a large, lead-lined, iron cylinder, water is added and steam blown in until the solution has a strength of 1.10 to 1.11 sp. gr. (taken hot). This apparatus is placed high enough so that the solution can be drawn direct to the crystallizing pans through 3-inch, steam-heated steel pipes. These operations are carried out in a separate building and with all possible cleanliness. The crystallizing vats are usually of iron and are lead-lined; a convenient size is 5 feet by 4 feet, and 3 feet deep. They should be raised a little above the cement floor, so that leaks can be detected; and the floor should slope to a catch basin, to avoid loss of the liquor accidentally spilled. From 7 to 10 days are allowed for the crystals to separate out; they are

then filtered off in a centrifugal machine and washed until not over .05 per cent. of chlorides is shown by testing.

The mother liquor is used for dissolving fresh crystals until it reaches a specific gravity of about 1.08, when it is too impure and is stored until enough is obtained, when it is boiled down and crystallized for crude crystals. The mother liquor from these is run into the ordinary concentrating pots.

55. Drying the Crystals.—The thin transparent crystals are thoroughly drained and then put on to the drying table, which consists of a table of boiler iron having an up-turned rim and covered with lead. It is heated by steam.

56. Grinding the Crystals.—For many purposes the dry crystals can be marketed direct; but for others, they must be ground to a fine powder. This is a very dangerous business and must be performed with the greatest care. The engine for driving the mill is situated outside of the building and all inflammable material is excluded so far as possible. The crystals are ground between small stones (about 26 inches in diameter), of which only the top one revolves. The crystals are fed in at the center of the top stone through a hopper and are best ground warm from the drying table, as in this way the mill clogs less. The ground crystals are then sifted through mechanically rocked sieves and the fine powder is packed.

OTHER CHLORATES

57. Sodium Chlorate.—Sodium chlorate is more soluble than the potassium salt, and for this reason is better suited for many purposes. It is, however, for the same reason, not so easy to make, for it cannot be readily separated from the other substances in solution. It can be made from the calcium-chlorate solution by evaporating it to 1.5 sp. gr., and then cooling to 10° or 12° C. The calcium chloride is crystallized out until there is only 1.2 molecules of calcium chloride to 1 molecule of calcium chlorate. By then adding

sodium sulphate and a little sodium carbonate, all the calcium is precipitated and sodium chloride and chlorate are left in solution; then by boiling down, the salt is separated out and the chlorate is left alone in solution. The solution is then run off and cooled, when most of the sodium-chlorate crystallizes out free from salt.

Hargreaves makes sodium chlorate by the direct action of chlorine on crystalline sodium carbonate and systematic leaching, so as to

dissolve out the soluble chlorate and leave the less soluble salt behind. He places the crystallized sodium carbonate in the tower *b*, Fig. 11, which is supported on the grate *c c*; the chlorine enters at *d* and, passing upwards, is absorbed. Liquor from the tank *e* slowly trickles down over the charge and is run off through *f*, where it goes into the sieve, which holds back any solid material, and the liquid runs through into the cistern, from

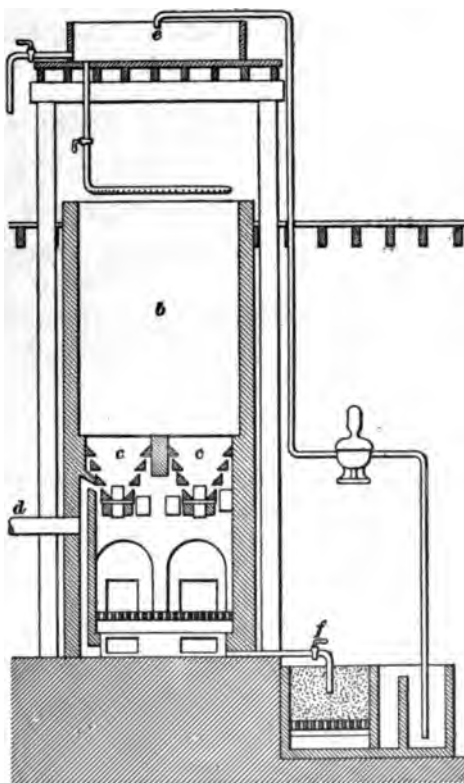

FIG. 11

which it is pumped back to *e* until it is saturated with sodium chlorate. It is then run off to pans and crystallized.

58. Barium chlorate and other chlorates can be made from sodium chlorate by mixing the chloride of the metal whose chlorate is wanted, evaporating down, and fishing out the sodium chloride. The metallic chlorate then separates out in cooling. These chlorates may also be made in a similar manner to the methods given above for the making of sodium chlorate.

ELECTROLYTIC METHODS

GENERAL PRINCIPLES

THE CURRENT

59. Sources of Current.—There are three methods for producing a continuous flow of electricity; i. e., the voltaic cell in some one of its various forms, the dynamo, and the thermopile. Of these, the voltaic cell is too expensive to be used as a source of electricity for electrolytic work on a commercial scale, for its action depends on the dissolving of expensive materials. In the thermopile we obtain a flow of electricity by heating the junction of two metals, and thus converting heat directly into electricity. This method is, however, wasteful of heat and is also too expensive for commercial use. The dynamo depends for its action on the rotation of a coil of wire in the field of force of a magnet, and as the coil can be rotated by means of a steam engine, or, better still, by water-power, it furnishes the most economical source of electricity at present known. The dynamo current is generally used direct from the machine, but it may be stored for future use by means of a special form of battery, called a storage battery. The storage battery also has the advantages that it can be transported and that it will yield a uniform current. Any voltaic cell which after being used can be returned to its original condition by the passage of an electric current in the opposite

direction is, in the perfect sense of the word, a storage battery. Only one form of battery has, however, proved itself useful for practical purposes. This consists of a plate of lead coated with lead peroxide on both sides and a plate of spongy lead dipped in a solution of sulphuric acid. If, under these conditions, the two lead plates are joined by a wire, the lead becomes transformed into lead sulphate and hydrogen separates on the lead-peroxide plate. Here the hydrogen is oxidized to water and the lead peroxide is reduced to lead oxide, which also goes over into lead sulphate. Now, when a current is passed into the cell, the reverse operations go on and the cell is returned to its original condition.

For convenience of reference, we will refer to the storage battery as our source of current, although it must be borne in mind that all the statements made will hold equally well for the current from any other source, at least so long as it is not an alternating current.

60. Just as when two unconnected dishes of water are placed on different levels there is a latent power in the water in the higher dish that gives it a tendency to flow into the lower one, which it does when they are connected by an open tube; so the plates of the storage battery are latent so long as they are not connected, but as soon as they are joined by a wire a current flows from the plate that corresponds to the higher dish into the plate that corresponds to the lower dish of water. In the case of the water, we say it has a "head" of a certain amount, measured by the difference of level of the two dishes; in the case of the electricity, we call it a difference of potential and measure it in a unit called a *volt*. This difference of potential of the plates of a cell is called the *electromotive force* of the cell. The water in flowing through the tube is retarded by the friction in the tube, and therefore does not reach the lower level with as much force as would otherwise be the case. The electricity is resisted by the conductor, and this resistance is measured in *ohms*. The

quantity of electricity, corresponding to the quantity of water, is measured in *coulombs* and its rate of flow in *amperes*.

Or, since electricity is, unlike water, an imponderable substance, or rather, a manifestation of energy, perhaps its analogy to heat is a better one than the above. In this case, the difference of potential, or electromotive force, corresponds to the difference of temperature of two points, the resistance of the conductor corresponds to the non-conductivity of the connecting medium for heat, and the quantity of current corresponds to the quantity of heat, in calories, that passes from the point of higher temperature to that of lower.

61. Units of Measurement.—Just as in measuring distance, a certain distance, as the foot, or meter, is arbitrarily selected as a unit to express the distance, or in measuring differences of temperature some definite difference of temperature, as a degree, is selected to express the difference of temperature; so in electrical measurements, a unit has been carefully selected in which to express the amount of the various values in which we deal.

The unit of resistance, the *ohm*, is the resistance at 0° C. of a column of mercury 1 square millimeter in section and 1.0626 meters long. The unit quantity of electricity, the *coulomb*, is the quantity of electricity that will deposit 1.118 milligrams of silver from the solution of a silver salt under suitable conditions. The unit of difference of potential, or electromotive force, the *volt*, is the difference of potential that will send 1 coulomb per second through a resistance of 1 ohm. The unit of the rate of flow of a current, the *ampere*, is the rate of flow that will carry 1 coulomb past a point on the conductor each second. The unit of electrical power, the *watt*, is the product of the volt and ampere and is equivalent to $\frac{1}{746}$ horsepower, or, in other words, 746 watts equal 1 horsepower. The unit of electrical energy, the *volt coulomb*, or *joule*, is the product of the volt and coulomb and is equivalent to .24 calory.

The current density is measured by the number of amperes entering or leaving the solution per unit surface of the electrodes. It is usually expressed in amperes per square decimeter, although other units of surface are also sometimes used, as the square meter or square foot, etc.

MEASUREMENTS

62. Resistance.—Electrical resistance may be measured by an apparatus called a Wheatstone bridge. A bridge when completed, ready for taking measurements, consists of three main parts: (1) An adjustable resistance box containing a number of coils, the exact resistance of each coil being known; (2) a galvanometer for detecting small currents; and (3) a battery of several cells. The coils of the resistance box are divided into three groups, two of which are called proportional or balance arms, and the third is known as the adjustable arm. Each proportional arm is composed of three and sometimes four coils of 1, 10, 100, and 1,000 ohms resistance, respectively. The adjustable arm contains a large number of coils ranging from .1 ohm up to 10,000 ohms.

The operation of the bridge depends upon the principle of the relative difference of potential between two points in a divided circuit of two branches.

The electrical connections of the bridge are shown in the diagram, Fig. 12. *M* represents the resistance of one of the balance arms, which will be

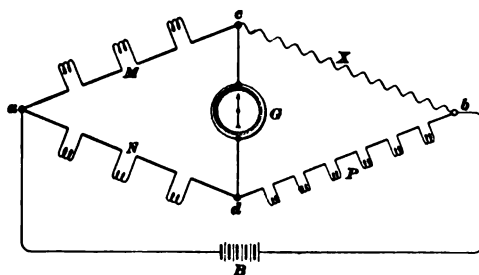

FIG. 12

termed for convenience the upper balance arm; *N* represents the resistance of the other balance arm, which

will be termed the lower balance arm; P represents the resistance of the adjustable arm; and X represents an unknown resistance, the value of which is to be determined. One terminal of the detecting galvanometer G is connected at c , the junction of the upper balance arm and the unknown resistance; the other terminal is connected at d , the junction of the lower balance arm and the adjustable arm. One pole of the battery is connected at a , the junction of the two balance arms; the other pole at b , the junction of the adjustable resistance and the unknown resistance. The current from the battery divides at a , part of it flowing through resistances M and X , and the rest through N and P . When the resistances M , N , P , and X fulfil the proportion $\frac{M}{N} = \frac{X}{P}$, then the two points c and d will have the same potential, and no current will flow through the galvanometer G . Since the resistances of M , N , and P are known, the resistance of X will be given by the fundamental equation $X = \frac{M}{N} \times P$, when the arms are so adjusted as to cause no deflection of the galvanometer. For example, suppose that the two ends of a copper wire are connected to the terminals b and c , and after adjusting the resistance in the arm so that the galvanometer shows no deflection, the resistances of the different arms read as follows: $M = 1$ ohm, $N = 100$ ohms, and $P = 112$ ohms. Then, substituting these values in the fundamental equation gives

$$X = \frac{M}{N} \times P = \frac{1}{100} \times 112 = 1.12 \text{ ohms.}$$

The coils of resistance can be bought already put up in boxes and standardized so that it is frequently more convenient to buy them in that way than to make them. They are called resistance boxes. In these resistance boxes, the ends of the wire of each spool are fastened to metal pieces a , Fig. 13, so arranged that the metal pieces can be connected by a metal pin b . When the pin b is in place, the

current can flow from one plate *a* to the next through the pin, and there is practically no resistance. When the pin is removed, however, the current must flow through the wire, and the resistance is introduced.

Just as a certain resistance is found when it is attempted to pass an electric current through a wire, so is a resistance met when a solution is used as a conductor. The determination of the amount of this resistance is a matter of importance.

63. Conductivity of Solutions.

Although it is customary to speak of the resistance of a wire, we sometimes hear the conductivity spoken of, and in the case of solutions, it is much more common to speak of the conductivity than of the resistance. The unit of conductivity, which has no special name, is the conductivity of a body that, for 1 centimeter length and 1 square centimeter base, has a resistance of 1 ohm. The specific conductivity of a solution is the conductivity of a centimeter cube of the solution. The conductivity of solutions is, however, expressed as the equivalent conductivity of the solution; this is the specific conductivity multiplied by the number of equivalent weights in grams of the dissolved substance in 1 cubic centimeter of the solution. By the term equivalent weight we mean the molecular weight divided by the number of valences represented in the metal part of the salt; or in the case of acids, by the number of acid-hydrogen atoms. For example, $\frac{H_2SO_4}{2}$, HNO_3 , CH_3COOH , $\frac{K_2SO_4}{2}$, $\frac{CaCl_2}{2}$, etc., if the formulas are expressed in terms of the atomic weights, are equivalent weights.

64. Effect of Temperature.—The conductivity of solutions increases very rapidly with a rise of temperature.

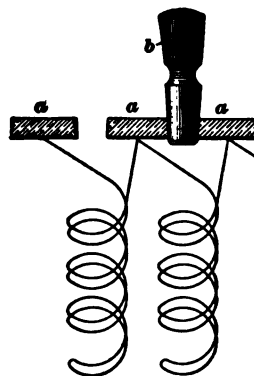

FIG. 13

The amount of the increase varies for different solutions, but it averages about 2 per cent. of the conductivity for each degree rise of temperature; of course, a fall of temperature gives the reverse effect. It is therefore very necessary to keep the solution at a definite temperature while making the conductivity measurements. For this reason the vessel containing the solution is kept in a constant-temperature bath during the whole time of the measurement.

65. Constant-Temperature Bath.—A suitable constant-temperature bath for technical work is made by wrapping a wooden pail in felt, as by this means water at nearly the temperature of the room can be kept at a constant temperature for a long time. (Most determinations are made at either 18° or 25° C.) With an arrangement of this kind the desired temperature can be obtained by mixing hot and cold water, and the temperature watched by a thermometer hanging in the water. When higher temperatures are to be used or a number of determinations are to be made at one time, more elaborate apparatus can be arranged, with stirrers and automatic temperature regulators.

66. Conductivity Vessel.—The form of the conductivity vessel will be different, depending on the conductivity of the solution. For solutions of low conductivity, as the organic acids, ammonia, etc., a resistance vessel is necessary with broad electrodes placed close together; for better conducting solutions, as inorganic acids, salts, and caustic alkalies, a small surface of electrodes with a rather long and small connecting tube is more suitable.

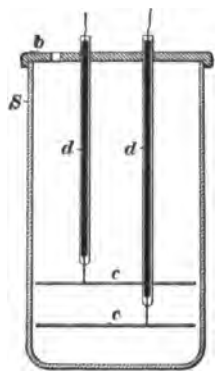

FIG. 14

For the first class of solutions, such a vessel as is shown in Fig. 14 is the most suitable. It consists of a cylindrical glass vessel *S*, fitted with a hard-rubber cap *b* having three holes, one for a pipette, when it is necessary to introduce or remove liquid,

and the other two for the electrodes. The electrodes consist of two circular platinum disks *c, c* fastened by means of heavy platinum wire into the capillary glass tubes *d, d*. The capillary tubes are filled with mercury, which makes a connection between the ends of the platinum wires from *c, c* and the copper wires that lead to the other connections. The glass tubes *d, d* are securely fastened by means of sealing wax into the cover *b*, so that the platinum disks *c, c* always hold their relative positions.

For the better conducting solutions, a vessel of the form shown in Fig. 15 is very suitable. It consists of the glass

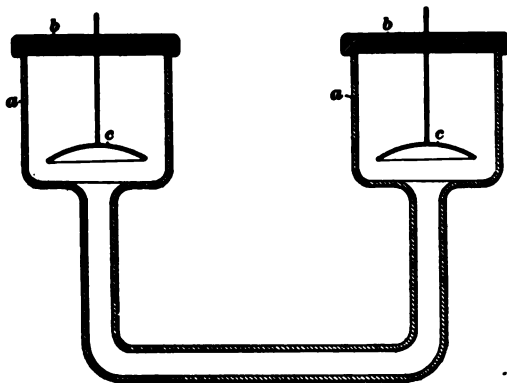

FIG. 15

vessel *a*, each arm of which is provided with a hard-rubber cap *b* bearing the curved platinum electrode *c*.

67. Platinizing the Electrodes.—The electrodes in either vessel should be coated with a good layer of platinum black, which is best obtained by introducing the clean platinum electrodes into a 3-per-cent. solution of platinum chloride containing $\frac{1}{4}$ per cent. of lead acetate, and passing the current from four Daniell cells for 5 or 10 minutes and then reversing the current and passing it for an equal length of time in the reverse direction. The electrodes must be thoroughly washed before they are ready for use.

68. Determination of the Conductivity of Solutions. In determining the conductivity of solutions, use is made of the apparatus described in Art. 62, except that on account of the polarization (see Art. 83) by the passage of the current, it is not possible to use a direct current. Instead of the direct current, it is necessary to have a current that flows at one instant in one direction, and the next instant in the opposite direction, for by this means polarization can be largely avoided. The alternation of the current can be produced by means of an induction coil that is introduced between the battery *B*, Fig. 12, and the Wheatstone bridge. The difficulty then arises that the galvanometer cannot be used, for the rapidly alternating current would simply cause the needle of the galvanometer to tremble. Therefore, in place of the galvanometer *G*, a telephone is used, which gives a buzzing sound as long as a current flows through it, and so shows when the branches of the bridge are equal.

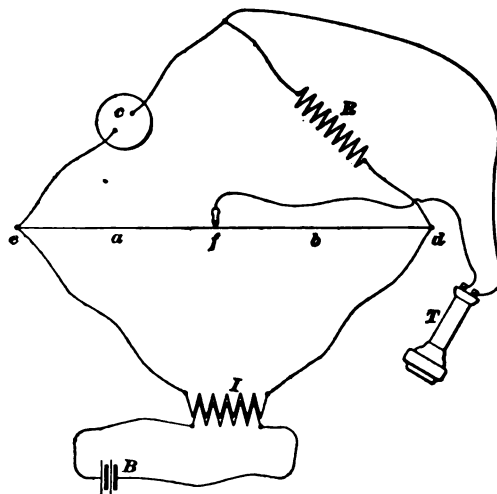

FIG. 16

This arrangement is shown in Fig. 16. The battery *B* furnishes the current to the induction coil *I*, where it is made to alternate rapidly. The conductivity vessel is represented by *c*, and a known resistance by *R*. *R* and *c* make

up two sides of the Wheatstone bridge and the wire $e a b d$, which is stretched over a graduated scale, and has a sliding contact f , makes up the other two sides. In making a determination, the solution is placed in the conductivity vessel c , which vessel is put in a constant-temperature bath. The resistance R is selected so as to be nearly equal to the unknown resistance (or conductivity). (If the resistance of the solution in c is totally unknown, a preliminary determination will show the approximate value of c , when R can be suitably selected.) The induction coil I is then started and the contact f slid until the noise ceases in the telephone T . By then reading the length of a and b on the scale, the ratios $\frac{a}{b} = \frac{c}{R}$ are known. That is, we know a , b and R , and since $R \frac{a}{b} = c$, c is easily calculated and the conductivity equals $\frac{1}{c}$. To get the specific conductivity, which is the conductivity of a cube with 1 centimeter edge of the solution, it is necessary to know the surface measurements of the electrodes and their distance apart. This is not easy, however, so that use is generally made of what is called the resistance capacity of the vessel.

69. Resistance Capacity.—In order to determine the resistance capacity, use must be made of some compound that can be obtained in a pure state, of which a solution of definite strength can be prepared and whose specific conductivity is already known. In order, however, to obtain accurate results, the resistance capacity of the vessel in which the determination is made has to be ascertained.

Calling the specific conductivity of a certain solution l , that of the same solution in the vessel used L , and the desired resistance capacity of the vessel K , we obtain the formula

$$K = \frac{l}{L}.$$

In all further determinations with the same vessel, the value K can be used, as it represents a constant so long as the electrodes keep their relative positions. From this it follows that having determined the conductivity of any

other solution in the same vessel, the specific conductivity of any such solution may be obtained by the formula

$$l = KL.$$

70. Solutions for Resistance Capacity.—The following solutions are suitable for use in determining the resistance capacity of a vessel:

Sulphuric-acid solution, 30 per cent. H_2SO_4 , has a specific gravity of 1.223 at 18° C. Ordinary chemically pure sulphuric acid is suitable for making the solution. The specific conductivity at 18° C. is $l = .7398$. A \pm error of .005 in the specific gravity determination causes a \pm error of .0004 in the conductivity value.

A magnesium-sulphate solution has a specific gravity of 1.19. at 18° C. Commercial chemically pure magnesium sulphate is good enough for use. The specific conductivity at 18° C. is $l = .04922$. An error of .003 in the specific gravity corresponds to an error of .00001 in the specific conductivity.

Other solutions are sometimes used, but these will usually meet the needs of the worker in the electro-alkali industry.

71. Quantity of Electricity.—This is measured by determining the amount of silver deposited by the current; or, since there is a direct relation (see Art. 80) between the amount of silver and any other metal that may be separated, copper and, sometimes, hydrogen are separated instead of the silver. A suitable arrangement for carrying out this measurement consists of a copper plate or wire gauze that can be accurately weighed and two other copper plates. In measuring the quantity of electricity, the weighed plate is hung, between the other two copper plates, in a solution of 15 grams of copper sulphate, 5 grams of sulphuric acid, and 5 grams of alcohol in 100 cubic centimeters of water. When the current passes, the copper is dissolved from the outside plates and deposited on the weighed one, so by weighing the middle plate at the end of the process, the amount of current that has passed can be readily calculated. Each coulomb deposits .329 milligram of copper and, therefore, the total weight, in milligrams, of copper deposited divided by .329

gives at once the number of coulombs of electricity that has passed through the voltmeter. Another very popular style of apparatus for this purpose consists in passing the current through a solution of sulphuric acid, using platinum electrodes, and measuring the gas evolved.

The same arrangement can be used for measuring amperes; for, noting the time required to deposit on the plate, we have all the information necessary for our calculation. For the number of coulombs divided by the number of seconds required for them to pass gives the number of amperes. For example, if the voltmeter shows 40 coulombs in 40 seconds, then we have 1 ampere

72. Ammeters.—Although the preceding arrangement is the most exact for the measurement of the quantity of the current of electricity, there are instruments, known as ammeters, which have a sufficient degree of accuracy for most technical work and, on account of their great convenience in handling, are very largely used. The instruments have been given in a great number of forms, but probably the most convenient and accurate is that shown in Fig. 17, known as the Weston ammeter.



FIG. 17

The Weston instrument depends for its operation upon the fact that if a coil, free to move, is pivoted in a magnetic field, it will swing round its axis when a current is passed through it. In these instruments a rectangular coil is delicately pivoted between the poles of a permanent magnet, and when a current flows through the coil, it is deflected, carrying with it a pointer that swings over the scale shown in the figure. The movements of the coil are counterbalanced

by small spiral springs; the greater the current, the greater is the deflection of the coil. The ammeter is inserted in the circuit so that all the current will pass through.

73. Electromotive Force.—The electromotive force is measured most exactly by using a standard cell of known electromotive force and comparing the unknown electromotive force with it. The best known standard element is Clark's, which consists of a rod of zinc in a saturated solution of zinc and mercury sulphates, and has mercury for the other pole. Such an element, when carefully made, has an electromotive force of 1.4336 volts at 15° C. This cell varies considerably with the temperature on account of the varying solubility of the zinc sulphate with varying temperature. The high temperature coefficient is a decided disadvantage, so that the Weston cell, which has a comparatively small temperature coefficient, is becoming popular. It consists of a cadmium amalgam in a saturated solution of cadmium and mercury sulphates, with mercury for the other pole.

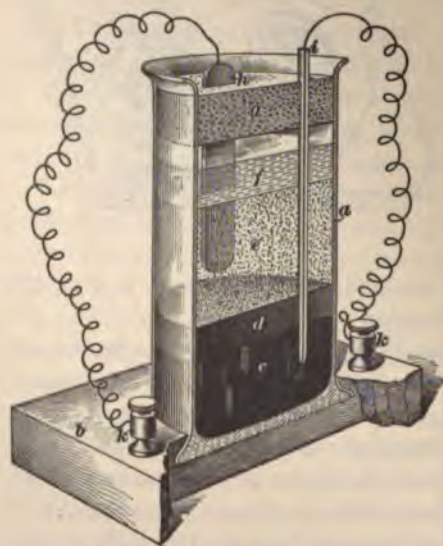

FIG. 18

A very suitable form of the Clark element, and one that can be conveniently made in any laboratory, is shown in Fig. 18. It consists of a small glass cylinder *a* set in a wooden block *b*, and containing mercury *c* in the bottom; then a layer of mercurous sulphate *d*, covered with a mixture of zinc-sulphate crystals *e* and saturated zinc-sulphate solution *f*. A cork *g* is then soaked in melted paraffin,

and a zinc stick h and a glass rod i , in which a platinum wire is fused, are fastened into the cork and the whole inserted in the cylinder. A layer of wax is then placed over the stopper, and wires lead from the platinum wire and the zinc stick to the binding screws k, k .

74. Measurement of Electromotive Force.—It is not advisable to compare a number of cells direct with a standard element, for it taxes the capacity of the element too much. We can check up the capacity of a constant element against the standard, and then use it for comparison. The determination depends on the fact that if we close a constant cell with a resistance, the fall of potential will be uniform over the whole length of the resistance. Furthermore, if a cell is connected with another cell of equal but opposed electromotive force no current will flow.

The operation consists in closing the cell E , Fig. 19, with a resistance ab . The fall of potential is uniform then for

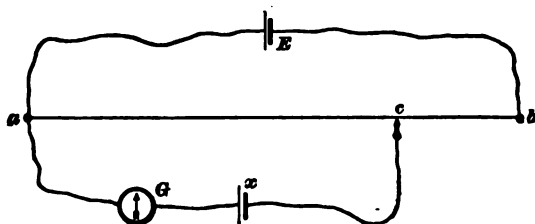

FIG. 19

each portion of ab . The wires connecting E with a and b are so large that they have practically no resistance compared with ab . From a a wire leads through the galvanometer G and the unknown cell x to the slide contact c . At intervals, to check the constancy of E , the standard cell is introduced at x , and c is moved until no current flows. Then ac represents the fraction of the electromotive force of E that is equal to the electromotive force Y of the standard cell. The standard cell is then replaced by the one to be measured, and the point c , at which no current flows, is again established. Calling this resistance ac' , then the

electromotive force of the cell being measured is equal to $Y \frac{a c'}{a c}$. If a Clark standard cell is being used, $Y = 1.4336$ and $1.4336 \frac{a c'}{a c} =$ unknown electromotive force.

A small storage battery is a very suitable cell for E , and the distance $a c$ need only be determined twice a day.

75. The Voltmeter.—For a great many purposes an instrument called a voltmeter is sufficiently accurate and much more convenient for measuring electromotive forces than the method just described. It is really an ammeter having a *high* resistance and provided with a scale calibrated to read volts instead of amperes. If we call the current c , the electromotive force e , and the resistance R , then $e = c R$ (see Art. 77). Then, if the resistance of the instrument is infinitely large compared to the resistance of the rest of the circuit, the instrument having been calibrated to read volts can be used to read direct. A voltmeter is connected across the circuit, so that the entire current does not flow through it.

76 Shunt Circuit.—When a wire leads continuously from one side of a battery, or other source of current, to the other side, it is called a circuit. If, however, two points of the circuit are connected by a wire, it is called a *shunt circuit*. For example, in Fig. 20 the wire $a c b$ forms a circuit from the battery E . When a wire is

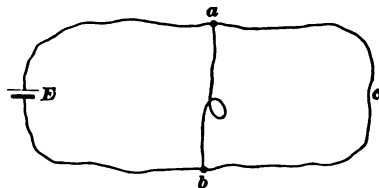

FIG. 20

brought across from a to b , a shunt circuit, or shunt, is formed. If the wire $a b$ has a small resistance compared with $a c b$, then the current will mostly pass across $a b$, and in the reverse case the opposite is true. If they are of equal resistance, the current will be equally divided. If it is desired to obtain the difference of potential between the

points *a* and *b*, a high-resistance voltmeter is inserted in the shunt *ab* and the difference of potential is read direct.

77. Ohm's Law.—The relation existing between the current, the electromotive force, and the resistance of a system is known as **Ohm's law**. It is that the current is directly proportional to the electromotive force and inversely proportional to the resistance,

$$\text{current} = \frac{\text{electromotive force}}{\text{resistance}}$$

78. Electric Conductors.—When an electric current passes through a wire, the wire may become hot or suffer other physical changes, but it remains essentially the same as before. On the other hand, if the current passes through a solution, it decomposes the dissolved substance and its products collect at the points where the current enters and leaves the solution. This leads to a division of electric conductors into two classes. All electric conductors that are not decomposed by the electricity passing through them are called conductors of the first class; all conductors that are decomposed by the electricity passing through them are called conductors of the second class, or electrolytic conductors.

There is an indefinite number of conductors of the second class, most of which may, however, be comprehended in the general title of solutions. Comparatively few pure substances other than the metals conduct electrolytically. Such substances as hydrochloric, nitric, and sulphuric acids, which in water solution are good conductors, do not conduct at all when in the pure, dry condition. By the pure, dry state is meant hydrochloric-acid gas condensed to a liquid and mixed with no other substance; the same is meant for nitric acid and sulphuric acid. Water is also a *very* poor conductor. Fused salts, however, conduct quite well and some few, as lead and silver chlorides, conduct somewhat in the solid condition when not too far from their melting point.

ELECTROLYSIS

79. As stated above, sulphuric acid, although a non-conductor when pure and dry, when dissolved in water is a good conductor and the solution is an electrolyte. Solutions in general that conduct are called **electrolytes**, although the term is frequently applied to the dissolved substance. For instance, in the above case it is customary to speak of sulphuric acid as an electrolyte, meaning that its water solution is a good conductor.

The current enters and leaves the solution by wires, and these, where they dip into the solution, are called electrodes. When a current is passed through a sulphuric-acid solution, oxygen separates at one electrode and hydrogen at the other. The electrode at which oxygen, or, in general, the acid radical, separates is called the *positive electrode*, or *anode*; and the one at which hydrogen, or, in general, the metallic radical separates, is the *negative electrode*, or *cathode*. Since by the passing of an electric current through an electrolyte, matter separates out at the electrodes, the electrolyte must be decomposed and matter must be carried with the current, for the concentration about the electrodes soon differs from the rest of the solution.

The matter that travels with the current is called *ions*. The ions that travel towards the anode are called *anions*, and those that travel towards the cathode are called *cations*. The ions are perfectly definite substances, but frequently they are not the substances that separate at the electrodes, for at the instant they are set free they may react with the solvent to form new substances; for example, the ions from sulphuric acid are hydrogen and SO_4 , the hydrogen separates as such, but the SO_4 breaks down and gives oxygen and sulphuric acid once more. In the electrolysis of sodium sulphate the ions are sodium and SO_4 , but the sodium reacts with the water to give hydrogen and sodium hydrate, and the SO_4 acts as in the above case, giving oxygen and sulphuric acid.

80. Faraday's Law.—When a certain amount of electricity passes through a solution of sulphuric acid, a definite

amount of hydrogen is liberated; and for the same amount of current, the same amount of hydrogen is liberated independent of the rapidity or slowness with which the current acts, the concentration of the solution and the temperature. Each gram of hydrogen liberated by an electric current corresponds to the passage of 96,540 coulombs; it makes no difference what substance is electrolyzed to give hydrogen, so long as only hydrogen is liberated at the cathode 1 gram will be freed when 96,540 coulombs of electricity has passed. If we, therefore, pass an electric current successively through solutions of hydrochloric acid, sulphuric acid, phosphoric acid, etc., exactly the same amount of hydrogen will be liberated.

What has been stated for hydrogen holds true for other elements and combinations of elements. If in electrolyzing a solution of sulphuric acid the hydrogen given off at the cathode and the oxygen at the anode (having waited until secondary reactions, which appear at the beginning of the electrolysis have stopped) are measured, it is found that the volume of the hydrogen is twice that of the oxygen. That is, the gases are liberated in the proportions in which they combine. *Equivalent weights of the substances are liberated.* Furthermore, if an electric current is passed successively through solutions of sulphuric acid, copper sulphate, silver nitrate, ferrous sulphate, and ferric sulphate, if the solutions are suitably prepared to avoid secondary actions at the electrodes, we will get, when 1 gram of hydrogen is liberated, 31.5 grams copper, 108 grams silver, 28 grams of iron from the ferrous solution, and 18.7 grams iron from the ferric solution. If the atomic weights of these elements are noticed, it will be found that the above values are in each case the atomic weight of the element expressed in grams divided by its valence. This relation was first noticed by Faraday and is known as **Faraday's law**. Briefly stated, it is that chemically equivalent quantities of substances are separated by the same amount of an electric current. For every 96,540 coulombs of current that pass, if no side reactions enter in, 1 gram equivalent each of the cation and of the anion is obtained.

81. Electrolytic Dissociation.—The way in which the current is carried in an electrolyte has long been a subject for speculation. It is now possible, however, to account for the quantitative phenomena of electrolysis by assuming that the dissolved substance is dissociated before the passage of the current. For example, when sodium chloride is dissolved in water, it is dissociated to a greater or less extent into sodium ions and chlorine ions, each of which bears a charge of electricity. That substances are so dissociated is also made very probable by measurements of the boiling and freezing points of solutions of electrolytes. Now, when the current passes through the solution, for every 96,540 coulombs of electricity passed, a gram equivalent of the cation and of the anion separates out, gives off its charge at the proper electrode, and becomes an ordinary substance again.

Substances are usually not entirely dissociated in solution, but consist of a mixture of undissociated and dissociated molecules. In water solution, most of the salts and the stronger acids and bases are quite highly dissociated at moderate dilution, and the dissociation ranges from this to zero dissociation for non-conductors.

Since the electricity is carried by the ions, its conductivity by a solution must depend on the number of free ions in solution and the speed with which they move. An increase in the concentration of a solution increases the number of free ions and its conductivity, but this conductivity is not proportional to the increase in concentration, for the more concentrated a solution is, the less is it dissociated.

82. Migration Velocity.—The speed with which the ions move depends on the viscosity of the solvent and the individual kind of ion. The speed with which some ions travel at 18° C. in water solution, with a difference of potential between the electrodes of 1 volt, is given in Table II.

It will be seen that the velocity with which ions move through water varies considerably, hydrogen and hydroxyl far exceeding all others. Hydrogen moves about five times as rapidly as chlorine, so that in the electrolysis of

hydrochloric acid there is a tendency for the concentration of the acid to rapidly decrease at the anode and increase at the cathode.

TABLE II

Cations	Centimeters per Hour	Anions	Centimeters per Hour
<i>H</i>	10.80	<i>OH</i>	5.60
<i>K</i>	2.05	<i>Cl</i>	2.12
<i>NH₄</i>	1.98	<i>I</i>	2.19
<i>Na</i>	1.26	<i>NO₃</i>	1.91
<i>Ag</i>	1.66	<i>C₂H₃O₂</i>	1.04

83. Polarization.—When a suitable electric current is passed between copper electrodes through a zinc-sulphate solution, the copper dissolves from the anode to form copper sulphate, and the zinc is deposited on the cathode. If after the current has been passing for some time, the source of current is cut out and the copper plates are connected by a wire, a current will flow in the opposite direction from the first one. This phenomena is known as polarization. If the electromotive force of the above cell is measured, it will be found to be about 1.1 volts. That is, a Daniell cell has been formed, and the condition very soon after the direct current begins to pass is the same as if a current were running against a Daniell cell. Therefore, it will not be possible to keep up the passage of electricity through a cell of this kind unless the original current has an electromotive force greater than the electromotive force of polarization.

The passage of a current through copper electrodes in a solution of copper sulphate simply dissolves copper from the anode and deposits it on the cathode, so that in this case there is no polarization and a current of the smallest electromotive force will flow continuously.

Almost all cases of electrolysis give polarization, and the passage of the current can only be continued when the electromotive force of the source of the current is greater than

the electromotive force of polarization of the solution. This electromotive force of polarization can be measured directly or it can be calculated from the heat of the reaction that would cause the polarization.

84. Calculation of the Electromotive Force of Polarization From the Heat of Reaction. — When a metal reacts in an electric cell, there is a certain amount of energy set free that may be evolved as heat or as electric energy, as circumstances may favor the one or the other. If, therefore, the heat of the chemical reaction is known, the electromotive force of the cell can be approximately calculated. This will, however, not be the exact value for the cell, for a temperature coefficient, which varies with the kind of cell, also enters into the calculation. Since the electromotive force of polarization is only the current tendency set up by the separated product, it can also be calculated in the same way as the direct electromotive force.

If we call the electromotive force of polarization ϵ and represent the valence of the ion by n , then, when 1 gram ion has separated out, or if we have the gram ion formed from the electrode and going into solution, we have the electrical energy $n\epsilon 96,540$ volt coulombs. This, in calories, is $n\epsilon 96,540 \times .24 = n\epsilon 23,170$ calories. If we represent the heat energy by Q , then $Q = n\epsilon 23,170$ and $\epsilon = \frac{Q}{n 23,170}$ volts.

We can calculate from this very nearly the minimum electromotive force necessary to electrolyze a solution, assuming that no secondary reactions enter in. For example, if a solution of hydrochloric acid is electrolyzed, hydrogen separates at one pole and chlorine at the other. These, from their tendency to combine, will give an electromotive force opposed to the decomposing current, which can be calculated by the above formula. The heat of formation of a gram molecule of hydrochloric acid in dilute solution is 39,300 calories and the valence of hydrogen is 1; therefore $\epsilon = \frac{39,300}{23,170} = 1.69$ volts and it will require a current of at least that

electromotive force to pass continuously through such a solution.

85. Summary.—We may briefly summarize our ideas about the electrolysis of a solution in the following laws:

1. Every electrolyte is, by the passage of the current, decomposed into two parts—the cation and the anion. These are in certain cases the positive and negative elements of the compounds, as in sodium chloride where the ions are sodium and chlorine; in other cases they are combinations of elements, as in potassium ferrocyanide, where the cation is potassium and the anion is the ferrocyanide radical.

2. The metal of a compound usually separates at the cathode, but in certain cases, as in ferrocyanides, one metal goes to the anode.

3. Water solutions of salts of the metals that decompose water naturally do not give the metal at the cathode, for as soon as the metal is separated it decomposes the water and forms a hydrate. Very strong solutions of the hydrates may be exceptions to this; also when a mercury cathode is used the metal dissolves in the electrode and is protected from decomposition.

4. The liberated ion appears only at the surface of the electrode.

5. There is a certain minimum electromotive force required for the electrolysis of a solution, which is determined by the heat of reaction of the liberated ions. If less than this minimum electromotive force is supplied, the current will pass until enough of the ions are liberated to set up the electromotive force of polarization, when the current will stop. In the case of the electrolysis of a solution between electrodes of the same metal as the positive ion, there will be no polarization and the weaker current will flow continuously.

6. The chemical work done is proportional to the minimum electromotive force of polarization, and if a greater electromotive force than the minimum is required, it will

not appear as chemical work in separating more ions, but as heat energy.

7. Various secondary reactions may take place as: (a) The decomposition of one or both of the ions (usually the negative one, however). For example, SO_4 may decompose into SO_2 and O . (b) The ions may react on the electrodes, as in the electrolysis of dilute sulphuric acid between zinc electrodes, in which case the SO_4 acts on the anode, giving $ZnSO_4$, and only hydrogen is set free. (c) Abnormal ions may be liberated, as the frequent formation of ozone O_3 , the deposition of a black porous deposit of copper and the deposition of lead or manganese dioxide on the anode.

ELECTROLYTIC PREPARATION OF ALKALI AND CHLORINE

INTRODUCTORY

86. Historical.—The fact that solutions are decomposed by the electric current has been known since the beginning of the 19th century, and a process was patented for the electrolysis of salt solutions during the first half of that century. It was not until the dynamo was perfected, however, that the commercial electrolysis of salt solutions could even be considered. About 1880 an interest in the subject began to be shown by applications being made for patents; but even in 1888 many leading men in the alkali industry considered the electrolysis of salt in a commercial way impractical. At the present time, however, there are several processes that may be considered commercially successful for the making of alkali and bleach from salt by electrolysis, and more than half of all the chlorate of the world is made by this method.

87. Electrolysis of salt.—This involves first the separating of the ions—sodium on the cathode and chlorine on the anode. Then, if we are electrolyzing fused sodium chloride, the chlorine is evolved and collected, and the

sodium separates as metal; if the temperature is kept suitably high, it can be drawn off and cast into bars. This process might be used for the preparation of metallic sodium, but it is possible to produce the metal more cheaply and easily by the electrolysis of the fused hydrate. If a solution of salt is used for electrolysis, the chlorine will be evolved as before, but the sodium acts on the water as soon as set free and forms sodium hydrate and hydrogen. As soon as formed, the caustic-soda solution begins to conduct a portion of the current and to be decomposed, liberating oxygen at the anode and wasting the current. There is also a possibility that a portion of the chlorine will get mixed with the caustic liquor, and so form sodium hypochlorite, which may, in turn, be converted into sodium chlorate or be reduced by the hydrogen to sodium chloride. These various processes may be represented by the equations

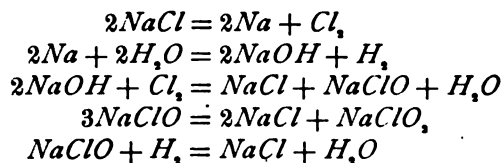

In addition to the loss of alkali and chlorine by its reversion to salt, we must remember that, as was pointed out with the sodium hydroxide, these substances all conduct and waste current.

88. Conditions Favoring Electrolysis.—The ideal conditions towards which we must aim in selecting a process for the electrolysis of salt, for the formation of sodium hydrate and chlorine, may be summarized as follows:

1. The process must work at as low a voltage as possible, in order to give the maximum decomposition per electrical horsepower.
2. The combination of the caustic soda and chlorine to form sodium hypochlorite must be avoided, in order to prevent a loss of current and to avoid great wear and tear on the electrodes. The accumulation of the sodium hypochlorite also prevents the continuous use of the electrolyte.

3. The products of the electrolysis must not be allowed to accumulate in the decomposition cell.

4. Strong and pure solutions of sodium hydrate must be obtained, in order to avoid the expense of concentrating the solutions and that the product may be salable.

5. The apparatus must be simple and need but little attention and repairs.

89. Electrodes.—The cathodes in the electrolysis of salt solutions cause very little trouble, as it is comparatively easy to find materials that are resistant to the action of caustic soda. With the anode it is, however, much different, for here is set free the very active chlorine, and, by secondary actions, the still more active oxygen and oxides of chlorine. The obtaining of anodes that would be sufficiently resistant, and at the same time not too expensive, was in the early days of this work one of the most difficult problems to solve.

The two conditions that a successful electrode must fulfil are that it shall be a good conductor and at the same time resistant towards the products of electrolysis. The only substances that satisfactorily meet these conditions are carbon and the platinum metals, with their alloys. Carbon, in the form of coke, is not badly acted on by chlorine, but oxygen and the oxides of chlorine act on it considerably and cause it to disintegrate. The overcoming of this difficulty was at one time almost despaired of, and recourse was had to making the electrodes as cheaply as possible from slabs of gas coke and frequently renewing them. At the present time, however, carbon electrodes are made by mixing finely ground coke with tar and some suitable metal or metallic oxide, pressing it into shape and heating it to drive off the more volatile substances. The electrodes are then subjected to the highest temperature of the electric furnace. By this means, carbides of the metal are formed, which are immediately decomposed with liberation of the metal, and the carbon is left behind in a fine graphite form. Carbon electrodes made by this, or a similar method, are now very

generally used in the production of caustic soda and chlorine by electrolysis.

The other possibility for anodes is an alloy of 90 per cent. of platinum and 10 per cent. of iridium, which is far more resistant towards the products of electrolysis than platinum alone. These electrodes are expensive, however, and are not so much used in the preparation of chlorine and caustic soda as the carbon electrodes. On the other hand, in the preparation of chlorates the platinum iridium alloy is almost exclusively used, as the use of carbon is practically out of the question on account of the oxidizing substances formed in large amounts.

FUSED ELECTROLYTE

90. The use of fused salt as an electrolyte offers certain difficulties that do not occur with the solution, and inventors have largely turned their attention to the perfecting of those processes that use solutions of salt in water. Three of the processes using fused salt as an electrolyte which have been patented deserve mention; they are *Vautin's*, *Hulin's*, and *Acker's*. Of these processes, Vautin's proved impractical and has apparently been abandoned, but the other two processes are in apparently successful operation.

HULIN'S PROCESS

91. Hulin's process consists in the electrolysis of a fused mixture of sodium and lead chlorides, using a lead cathode. One difficulty that is experienced ordinarily in the electrolysis of fused salt is, that both the sodium and chlorine rise to the top of the material and it is very hard to prevent loss by their reuniting. In this method, however, the lead cathode is fused, and at the bottom of the electrolyte, so that the chlorine is evolved and carried away from the top of the apparatus and the sodium remains as an alloy with the lead in the bottom. Vautin employed a similar arrangement, but attempted to electrolyze sodium chloride alone; this led to the formation of a crust of the lead-sodium alloy on the

surface of the cathode, with a subsequent high electromotive force and loss of sodium. Hulin avoids this difficulty by using an electrolyte of a mixture of sodium and lead chlorides, so that lead is continuously deposited with the sodium and an alloy of the proper composition built up. By this method, the mixture of chlorides must continuously become poorer in lead chloride, unless more of the substance is continuously added. This addition of lead chloride is best made, or rather the lead for the cathode is best supplied (for it consists in a simple transfer of lead from the anode to the cathode), by employing two anodes, one of carbon, the other of lead.

By allowing any desired fraction of the total current to pass through the lead anode, as much of it as is needed is dissolved in the electrolyte. It is found in practice that the best results are obtained by allowing 12 per cent. of the total current to pass through the lead anode and the remainder through the carbon anode. The electrolysis takes place in cast-iron crucibles, which are surrounded by bad heat-conducting material and lined with an insulator. The heat of formation of salt from sodium and chlorine is 97,600 calories and therefore, according to the formula $\left(e = \frac{Q}{n 23,170} \right)$ the electromotive force theoretically necessary to decompose fused sodium chloride is about 4.2 volts, for this value is calculated using the heat of formation of solid sodium chloride; that for the fused chloride will be less by the heat of fusion, and its electromotive force of polarization will also be less. In practice, each crucible employs a current density of 700 amperes per square foot of electrode surface and 7 volts electromotive force. By the use of such high current density it is possible to get a large amount of decomposition of the electrolyte per unit of electrode surface, and thus to employ a small plant.

The yield per electrical horsepower hour is 81 grams of chlorine and 54 grams of sodium. The chlorine is converted into bleaching powder by the usual method. The lead alloy, which contains from 23 to 25 per cent. of sodium, may be sold directly for many uses where metallic sodium is required. It is usually, however, treated with water, and by suitable working, a strong

solution of caustic soda of a high degree of purity is obtained. This caustic requires very little fuel for its evaporation, and for this reason is much better than the more dilute caustic obtained by many processes. The lead is left by this operation as a spongy mass, and together with considerable lead peroxide that is also formed, it makes a valuable by-product.

This process was considered so promising in 1899, that a company was formed with a capital of over \$500,000, and works, which are still in successful operation, were erected at Clavaux, France, for carrying out this method.

THE ACKER PROCESS

92. The Acker electrolytic process, which is at present in successful operation at Niagara Falls, differs from

the above in that it uses fused lead as the cathode and continuously removes the sodium from the sodium-lead alloy, so that the lead can be used continuously. The apparatus for carrying out this process is shown in Fig. 21. It consists of an iron base *a* embedded in brickwork *b*, which rest on brick pillars *c*, or it rests on the ground and has places excavated

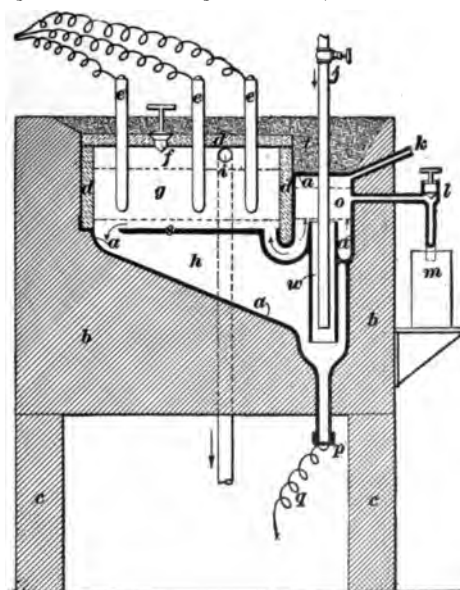
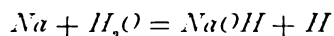

FIG. 21

for the parts projecting below the surface. The upper part consists of slabs *d* of acid-resisting slate or is made of fire-clay. These slabs are carefully luted into the iron shoulders,

as shown, by using fireclay. Through the top cover project the graphite anodes *e, e, e*, while at *f* is provided a charging hole for fresh salt. At *g* is molten salt and at *h* an alloy of molten lead and sodium. At *i* is a pipe for conducting away the chlorine. At *j* is a pipe for blowing in steam; *k* serves for conducting away the hydrogen; *l* conducts the fused caustic soda *o* to the shipping tin *m*. The extension *p* serves for drawing away the fused contents of the cell, when it is necessary to empty it for repairs, and *q* shows the cathode connection. At *s* is the iron plate that serves to separate the molten lead, which is the cathode proper, from the alloy below. The top is covered with a non-conducting material *t*, as asbestos wool.

To start the operation, the interior of the cell is heated by hydrogen flames until it is thoroughly hot; then melted lead and melted salt are run in, the covers and electrodes put in place, and the current started. The chlorine is given off at the anodes, rises to the surface, and is conducted away through the pipes *i*. The sodium separates on the surface of the fused lead, which acts as the cathode, and alloys with it. Meanwhile, superheated steam is blown in through *j* and causes the lead to rise in *w*, overflow, and circulate as shown by the arrows. As soon as the cell is in working order, the sodium alloy is decomposed in *w* by the steam and the fused caustic soda rises to the surface of the lead in *o* and runs off through *l* into the shipping can *m*; *l* contains a plunger valve so that the flow of caustic can be stopped if desired. The lead flows in the direction of the arrows, displaces the sodium alloy just formed, and so forms a system of circulation. The hydrogen, which is formed by the action of the steam on the sodium in the alloy, escapes through *k* and can be collected and burned over the salt, in the form of an oxyhydrogen flame, to keep up the temperature of the cell. Since the cell is well insulated, the heat from the steam and the heat of the reaction



nearly suffice to keep up the temperature of the cell to the proper point.

DISSOLVED ELECTROLYTE

93. The so-called wet processes, or those in which the sodium chloride is in solution as an electrolyte, comprise the most important methods for obtaining the products of electrolysis. A serious difficulty is encountered in working these processes, by the materials formed at the electrodes tending to mix and form compounds that are not wanted. The methods used for keeping separate the products formed about the electrodes may be divided into three general classes: (1) By a difference in the density of the liquids; (2) by diaphragms; (3) by using a mercury cathode

DIFFERENCE IN DENSITY

94. The processes depending on the difference in the specific gravity of the sodium hydrate formed and the rest of the solution, to keep the products of the reaction separate, place the anode at the top of the decomposition vessel, so that the chlorine is set free without traversing more than a small portion of the liquid. On the other hand, the cathode is placed at the bottom of the cell, and the caustic solution being heavy stays at the bottom and can be drawn off. Theoretically, this is a good arrangement, but practically it is almost impossible to prevent the diffusion and mixing of the chlorine and caustic soda. This difficulty is also increased by the hydrogen, which is set free at the cathode, rising through the electrolyte and mixing it. The *Richardson-and-Holland process* avoids the difficulty with the hydrogen by using a copper cathode covered with a coating of copper oxide. The copper oxide oxidizes the hydrogen as rapidly as it is formed. When necessary, the electrodes are removed and the copper oxide is regenerated by heating in the air. By this method a fairly good separation of the caustic soda and the chlorine can be maintained; this process was tried on a manufacturing scale, but it has been abandoned.

PROCESSES USING DIAPHRAGMS

95. The use of a diaphragm is a favorite device for keeping the solutions around the cathode and anode separate, but it is very difficult to find a diaphragm that will meet all the requirements. A diaphragm to be satisfactory must resist the action of the contents of the bath, must keep the anode liquor well separated from that of the cathode, and must not offer great resistance to the passage of the current. A large number of diaphragms have been proposed, but as none of them has been very satisfactory, it will be sufficient to consider two in connection with the most important processes of this type. Of the various forms of apparatus using diaphragms for electrolysis of a salt solution, Greenwood's is among the most satisfactory.

96. Greenwood Process.—Greenwood's apparatus consists of a circular iron cell *a*, Fig. 22, lined with copper, which also serves as the cathode. On the bottom of the cell is placed a slate slab *b*, upon which rests the diaphragm *c*, which consists of a series of V-shaped circular troughs of glass, or porcelain, and packed together by asbestos. The anode is a carbon piece with a core of type metal and stands inside the circular diaphragm. When in operation, a series of these cells are placed step-wise, as shown. The brine enters continuously at *d* and flows into the next cell through *f*; the chlorine escapes through *e* and the caustic goes to the next cell with the brine. Theoretically,

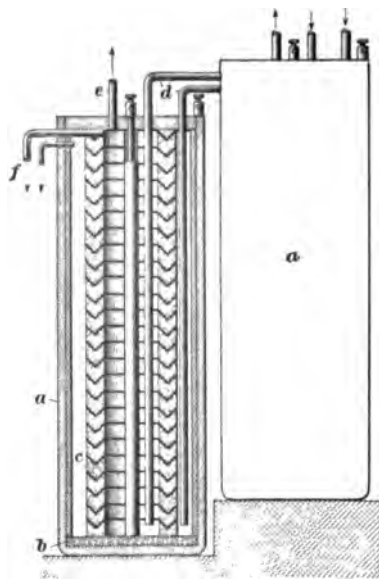

FIG. 22

about 2 volts are required for electrolysis, but in practice 4.4 volts and a current density of 100 or 110 amperes per square meter are used. The electrolyzed brine contains about 10.76 per cent. of salt and 2.2 per cent. of caustic soda. This must be evaporated down and the salt fished out. The process was in experimental operation in England as late as 1899, but it is very doubtful if any process that gives such a weak caustic, mixed with so much salt, can prove a success, for the expense of concentrating the solution and fishing out the salt is too great.

97. Le Sueur Process.—This is a combination of the density and diaphragm methods of separation, for while

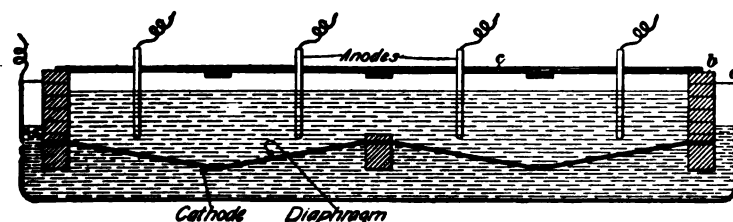

FIG. 23

it uses a diaphragm, the electrodes are so placed that the gravity separation will be as effective as possible. The electrolyzing vessel *a*, Fig. 23, consists of $\frac{1}{4}$ -inch boiler steel and is about 9 feet long, 5 feet wide, and $1\frac{1}{2}$ feet deep. The anode compartment is made by building up red bricks *b* in Portland cement somewhat higher than the electrolysis cell and covering it over with spruce planks *c*. Carbon has been discarded as an anode substance in favor of the 10-per-cent. iridium-platinum alloy already referred to.

The anodes are made according to a method devised by Le Sueur, which consists in rolling 4-inch pieces of the platinum-iridium wire very thin, except at one end; the unrolled ends are then bunched together and fastened in a glass tube, so that they just extend into the interior and the flat ends spread out. When the anodes are in place through the spruce cover to the anode compartment,

connection is made with the main conductor by means of a drop of mercury in each glass tube, an iron wire reaching to the top of each tube. These electrodes cost about 73 cents each and sufficient to make 200 tons bleach per month cost about \$5,000.

The anode compartment is separated from the cathode compartment by an asbestos diaphragm supported on a wire gauze, which at the same time serves as the cathode. By thus bringing the diaphragm close to the cathode, the resistance of the cell is diminished; and by making use of the gravity system, the caustic soda is kept quite well separated from the chlorine. It is nevertheless impossible to prevent some diffusion and the formation of sodium hypochlorite, which not only causes loss of current but also acts on the electrodes. This is avoided in the anode compartment by keeping the solution slightly acid with hydrochloric acid, which decomposes the hypochlorite and gives chlorine. The sodium hypochlorite that collects in the cathode compartment is converted into sodium chlorate and recovered. The diaphragm and cathode are arranged as shown and are also sloped to one end of the cell, so that the hydrogen passes to the higher parts and then out of the cell. The diaphragms last on an average 7 weeks, but have lasted as long as 24 consecutive weeks. The anodes and the cell itself are practically indestructible. Instead of the theoretical 2 volts, the process uses $6\frac{1}{2}$ volts and 1,000 amperes per cell. A solution containing from 10 to 15 per cent. of sodium hydrate can be separated by this process, but it also contains considerable salt. This liquor is concentrated under diminished pressure, the salt separated by centrifugal machines, and the evaporation completed in iron pots.

The efficiency of the process is about 87 per cent. of the theoretical amount of chlorine and somewhat less of sodium hydrate. The process is in successful operation on a commercial scale at Berlin Falls, New Hampshire, where the caustic is used in making wood pulp and the chlorine used to bleach the pulp. It is very doubtful if any process depending on either gravity or a diaphragm for the separation of the

caustic soda can be successfully operated to make solid caustic soda, for the expense of concentrating the necessarily dilute solution and the separation of the salt is too great, even if we leave out of consideration other objections.

98. Hargreaves-and-Bird Process.—This process can best be classed under the head of diaphragm processes, although strictly the diaphragm does not divide the cell. The process is distinctive, in that the walls of the cell are composed of the diaphragm and cathode. The diaphragm is composed of a layer of paper or some other suitable material, as a copper-wire gauze, covered with a layer of Portland cement, which, in turn, is covered with a layer of asbestos. This is impermeable to the salt solution, but allows the sodium ion to pass. The cell is put together with a copper-wire gauze, which serves as the cathode, on the outside, and the whole is set into an enclosing jacket. The carbon anodes are hung in the anode compartment and the brine to be electrolyzed slowly flows in at the bottom of the cell and passes out at the top, through the same pipes as the chlorine. During electrolysis the sodium ions migrate to the top cathode and are there, as rapidly as set free, converted into caustic soda by blowing in steam; or into soda crystals, by steam and carbon dioxide.

The diaphragm and cathodes are made 10 feet long and 5 feet high, and as one is on each side of the cell, it gives 100 square feet of cathode surface. A cell of this size decomposes on an average 237 pounds of salt every 24 hours and gives 365 pounds of 37-per-cent. bleach and 213 pounds of soda ash by the use of 2,300 amperes and 3.9 volts per cell. This represents an efficiency of about 97 per cent. of the electrical energy used. The brine is best obtained direct from the wells; in passing through the cell, 75 per cent. of it is decomposed. The dilute brine can be returned to the well to be resaturated. The chlorine can be converted directly into bleach and the caustic is strong and pure. When sodium carbonate is made, for the making of which this process is well suited, the solution is so concentrated

that the carbonate crystallizes out without concentration. The sodium carbonate so made is very pure, averaging when dehydrated 97.9 per cent. of Na_2CO_3 , 1.53 per cent. of $NaCl$, and .53 per cent. of Na_2SO_4 , etc. The sulphate is probably due to sulphur dioxide in the furnace gases that are used for carbonating.

The apparatus is simple and requires very little attention. The only part that suffers great wear is the diaphragm, and that is quite cheap. This process has been running satisfactorily in a small way for several years, but now a large plant is being established in England.

PROCESSES USING A MERCURY CATHODE

99. A large number of processes for the electrolysis of salt have been proposed in which a mercury cathode is used. These have the advantage that the sodium separates with the mercury as an amalgam and can be converted into hydrate outside of the cell. By this means a solution of caustic soda of high concentration and practically free from salt can be made. The process suffers from the disadvantage that only dilute amalgams can be made, for otherwise there is a loss of current, and therefore the mercury must be frequently changed. There is also a chance of a large loss of mercury, for when the sodium is acted on by the water, mercury is mechanically carried away by the hydrogen; also, considerable mercury is carried off in the form of vapor, even at ordinary temperatures.

100. Castner-Kellner Process.—This is the most satisfactory and successful process of this character; in fact, it has proved itself the most satisfactory of all processes for the electrolytic decomposition of salt.

The cell is divided into three compartments, the center of which contains the iron cathode *a*, Fig. 24, and serves for the decomposition of the sodium amalgam. The two end divisions serve as anode compartments and contain the carbon anodes *b, b*. One end of the cell rests on a knife edge *c*, and

the other is supported on the eccentric *d*, which revolves and thus slowly raises and lowers the end of the cell. Brine fills the two end compartments and is renewed, as necessary, by fresh brine flowing in; the exhausted brine goes to be resaturated. A thin layer of mercury covers the bottom of the apparatus, and is so regulated in amount that all of it practically flows alternately from the end compartments into the middle, as the cell rocks.

Strictly speaking, the ends of the cell are not anode compartments, but are alternately complete cells in which the salt is decomposed, the chlorine separating on the carbon anode and passing off, the sodium dissolving in the mercury cathode to form an amalgam. Then, as the cell tips, the

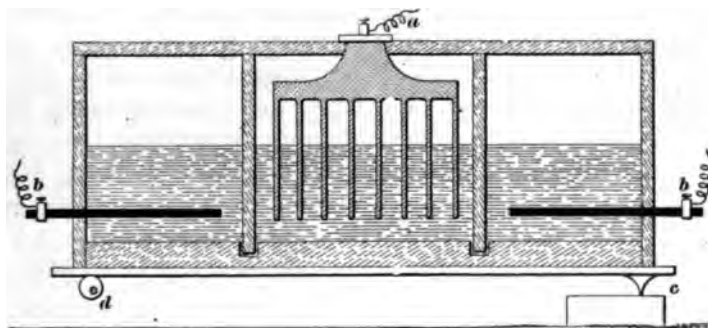

FIG. 24

amalgam flows into the center compartment, where it forms the anode of a primary battery, and the iron electrode here becomes the cathode of this battery. This has the advantage that the hydrogen, instead of coming from the surface of the mercury and so carrying that metal with it, comes from the iron cathode, and the sodium simply goes into solution from the mercury as caustic soda. This also has the advantage that the current from this battery aids in the electrolysis in the end cells. Owing to the frequent removal of the sodium amalgam from the anode cell, it rarely contains over .02 per cent. of sodium, and as a consequence the cell gives a high degree of efficiency, being from 88 to 90 per cent. of the theoretical.

Since no caustic soda is formed in the anode compartment there is no formation of sodium hypochlorite, and therefore the anodes have practically no wear. And since the electrolyte contains no hypochlorite, it can be used continuously by being conducted through a supply of salt so as to be resaturated. The resistance in the cell is very low, so that a current of 4 volts and 550 amperes per cell will decompose $56\frac{1}{2}$ pounds of salt every 24 hours and will yield $38\frac{1}{2}$ pounds of caustic soda and $34\frac{1}{2}$ pounds of chlorine. The caustic solution can be made of almost any desired concentration and is practically made about 20 per cent. sodium hydrate. It can be concentrated by simple evaporation and yields a caustic $99\frac{1}{2}$ per cent. pure. The chlorine obtained is from 95 to 97 per cent. pure, and for the rest contains a small amount of hydrogen. The cells are very simple and require but little attention, the work being almost automatic. Repairs are seldom needed, but when necessary any cell can be cut out from action without disturbing the work of the remainder. This process has been working with apparent success for several years in England, on the Continent, and in America. The English company has been able to declare 8-per-cent. annual dividends on a capital of over $1\frac{1}{2}$ million dollars.

101. Conclusions.—To sum up, then, we may conclude about as follows:

1. In the fusion processes, fused salt is a good conductor of electricity, and therefore very high current densities can be used, which means that a large output can be obtained from a small plant. Concentrated solutions of caustic soda, or, in the Acker process, even fused caustic soda can be made. On the other hand, the wear and tear on the cell, especially if heated from without, is very great and the cost of keeping the material fused must be considered. The hot chlorine is not so easy to handle as the cold chlorine from the other processes.

2. The process using gravity for separating the products has very few good points.

3. In the diaphragm processes the cells are cheap and the wear and tear on the cell is not great. They require very little skilled labor. They suffer, on the other hand, considerable loss of caustic soda and chlorine through their recombination and by reduction at the cathode, and have high resistance in the cell. This is, however, nearly proportional to the power of the diaphragm to stop diffusion, so the higher the resistance, the smaller is the loss of the products through mixing, and the reverse. They furnish a low strength of caustic, the concentration and purification of which is expensive.

The Hargreaves-and-Bird process cannot be included in this general statement, as it is not strictly a diaphragm process.

4. The mercury-cathode cell has very little loss through the recombination of the products of the reaction. The cells are quite free from wear and tear. A highly concentrated caustic-soda solution can be made if desired, but it is usually cheaper to concentrate the solution after it has attained a strength of about 20 per cent., than to overcome too great a resistance of the solution. The initial cost of the cells is high and a large amount of mercury is constantly in use. About 7 tons of mercury are required for each ton of caustic soda produced in a day. The power to move the cell is small, but must be considered in estimating the cost of working the plant, and it also adds to the complication of the plant.

Various estimates have been made of the cost of bleach and caustic by the electrolytic process, and practically all of them show that they cost more by this method than by the older processes. Nevertheless, the electrolytic processes are able to continue and pay dividends, so that apparently something is wrong with the calculations. The truth of the matter is that sodium hydrate can be made more cheaply by the ammonia-soda process than by any other, but this process cannot produce chlorine. The electrolytic process can produce chlorine more cheaply than the Le Blanc process, so that we must consider the electrolytic processes as

essentially processes for the production of chlorine and the caustic soda as a valuable by-product.

102. Electrolytic Bleach.—One of the main things that we have been struggling against so far has been the formation of hypochlorite in solution, but nevertheless, when a bleaching solution is wanted, the hypochlorites are just what are needed. As early as 1883 Hermite patented a process and advocated the use of electrolytic bleach. He

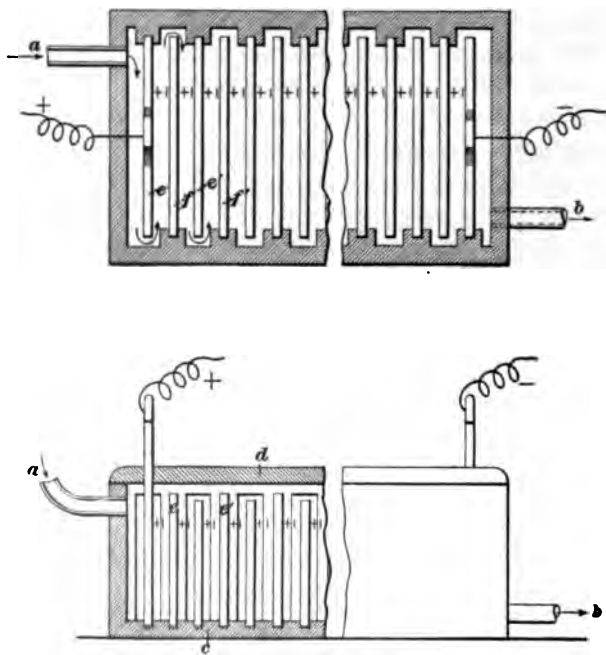

FIG. 25

proposed to electrolyze solutions of calcium chloride, magnesium chloride, or a mixture of one or both of these with salt in such a way as to obtain hypochlorites in solution. This is easily accomplished by placing the cathode over the anode, so that the chlorine, in rising, must pass through the caustic formed; and if the electrolyte is kept circulating

through the bleach vat, the apparatus lasts well and the process is satisfactory.

A very satisfactory apparatus for carrying out an electrolysis of this character has been invented by Kellner. Fig. 25 shows an apparatus of this character in vertical section and ground plan. It consists of the cell *c* with a cover *d*. The side walls, which act as insulators, carry electrode plates *e*, *e'*, etc. and *f*, *f'*, etc. of carbon, or metal with platinum on one side, which extend alternately into the cell, so that the electrolyte is forced to zigzag between them in passing from one end of the cell to the other. The first and last plates extend through the cover and serve for connecting with the current. This arrangement makes it possible to electrolyze the solution in a small space, and also enables the operator to use a current of high voltage, as is frequently available from electric-light plants. By regulating the number of intervening plates, the current can be reduced in voltage for each section of the cell, in the same manner as would be the case if a series of the same number of cells were used. In operation, the electrolyte enters *a* and flows in the direction of the current, finally leaving at *b*. The circulation of the brine is so regulated that about .05 per cent. of active chlorine is formed at each passage of the brine through the apparatus. When the brine has 1 per cent. of active chlorine, it is used for bleaching. The composition of the electrolyzed brine depends on the voltage, amperage, temperature, and the amount of sodium chloride present. The bleaching solution is clear, has an apple-like odor, and keeps better than a solution of bleaching powder having the same amount of available chlorine.

The question as to whether it will pay to use this method or not is one that every user of bleach must decide from the conditions prevailing at his factory. In most cases it is probably better and cheaper to allow the brine to be electrolyzed at some central plant, where the sodium can be saved as hydrate, and there to convert the chlorine into bleach, to be shipped to the place where it is needed. In some places where large quantities of

bleaching liquors are used, however, it will, without doubt, pay to make it on the spot, thus saving the carriage of large amounts of inert material in order to get the necessary chlorine.

POTASSIUM CHLORATE

103. It has been shown that if the products of electrolysis of an alkaline chloride are allowed to combine, the result is the formation of the hypochlorite. If now the conditions are suitable, the hypochlorite changes to the chlorate. The total result of the electrolysis of potassium chloride, when the solution is kept cool and the current density low, is represented by the equations

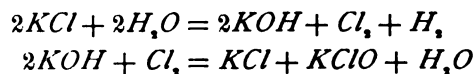

If the solution is allowed to heat up, however, the potassium hypochlorite goes over into potassium chlorate and chloride, according to the reaction

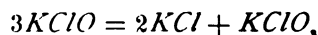

If we omit the intermediate reaction, we have

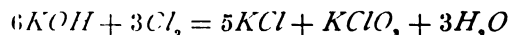

as the reaction for the formation of potassium chlorate from potassium hydrate and chlorine. Finally, neglecting all intermediate steps, we now write, as representing the final result of electrolyzing a solution of potassium chloride in such a manner as to give potassium chlorate, the reaction

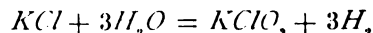

A glance at this reaction, recalling Faraday's law, will show that it takes at least six times as much electricity to make 1 molecule of potassium chlorate as is required to decompose a molecule of potassium chloride, or 6 molecules of potassium chloride are decomposed in order to get 1 molecule of potassium chlorate. It will thus seem that there is

a great waste of current in this process; but if it is considered that by the older chemical methods it required 6 atoms of chlorine to make 1 molecule of potassium chlorate, it will be seen that as much loss occurs in the older methods as in the electrolytic process. The greatest argument in favor of the electrolytic method is, however, that it has been running for several years and at a profit, so that apparently it can today make potassium chlorate at least as cheaply, and probably more cheaply, than it can be made by the old methods.

That it is possible to make chlorates by electrolysis was probably first noted by Stadion in 1816; the process was patented in England by Charles Watt, in 1851, and our present methods differ only in the details of the process and in the apparatus.

104. Gall-and-Montlaur Process.—This is the oldest process by which potassium chlorate has been successfully manufactured electrolytically. It uses lead-lined, rectangular tanks of about 11,000 gallons capacity and insulated from the floor by means of oil cups. The same means are used in insulating the whole building. The anodes are an alloy of 90 per cent. platinum and 10 per cent. iridium, while the cathodes consist of a nickel-iron alloy. Large quantities of hydrogen (about 19,000 cubic feet for each ton of potassium chlorate) are set free in the process, and if this comes in contact with chlorate or hypochlorite, it will reduce it and cause loss. To avoid the action of the hydrogen, the cathodes are enclosed in asbestos bags, which aid in carrying off the hydrogen. About a 25-per-cent. solution of potassium chloride is used in the electrolysis. This solution must be as pure as possible, for the presence of metallic oxides causes very rapid decomposition of the potassium hypochlorite first formed into potassium chloride and oxygen. An electromotive force of 5 volts and a current density sufficiently high to keep the temperature at 50° to 60° C. is employed in the electrolysis. The relative sizes of the cathode and anode are so arranged that there is a high current density at the

cathode and a low one at the anode. By this method of working it is possible to obtain a current efficiency of over 50 per cent. The process is in use at several places.

105. Corbin Process.—This process is quite similar to the Gall and Montlaur in that it produces the complete action in the cell. It makes use of secondary electrodes, however, and causes the electrolyte to circulate between them. The apparatus consists of cement cells with primary electrodes at the ends and a large number of platinum plates set in ebonite frames and placed from 12 to 15 millimeters apart, which act as secondary electrodes.

When the current passes, one side of the secondary electrode acts as cathode and the other as anode, and since the plates are so close together, the reaction between the caustic potash and chlorine takes place readily, and by a high density current the temperature is kept high enough, so that the chlorate forms at once. The process is in operation at Chedde, Savoy, but no details as to its success are available.

106. Blumenberg Process.—In this process it is attempted to avoid the secondary decompositions, the high density, and the reduction by hydrogen by first making caustic potash and chlorine, collecting them separately, and combining them outside of the cell. The potassium chloride is dissolved, filtered, and run into the storage tanks *A*, Fig. 26, from which it can run directly into the electrolysis cell. This consists of a simple cell *B*, divided into anode *c* and cathode *d* compartments by a simple diaphragm *e*. During electrolysis the potassium hydrate collects in the cathode compartment and the chlorine is saved in the gas holder *F*. When the electrolysis has continued long enough to give considerable caustic, the contents of both compartments *c* and *d* are allowed to mix in the pan *G*, and the chlorine is run in from the gas holder *F* to form the chlorate. Both the electrolysis cell and *G* are arranged so that they can be heated by means of steam pipes when necessary. From *G* the chlorate is run down into concentration and crystallization tanks. High efficiency is claimed for this process.

107. Gibbs Process.—The fact that during the formation of potassium chlorate by electrolysis large quantities of hydrogen are formed has already been mentioned. In order to avoid the reducing action of this gas, Gibbs makes use of the cathodes of copper oxide so that the hydrogen is oxidized as rapidly as it is set free. This also reduces the polarization at the electrodes. In other respects the Gibbs method has little that is peculiar to it, and this feature

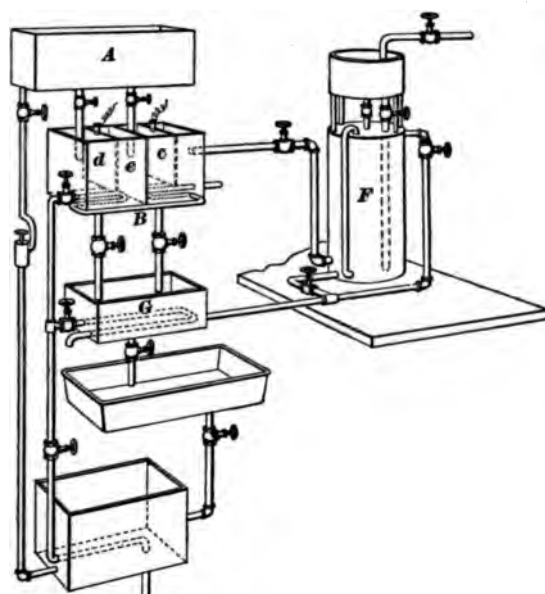

FIG. 26

seems to be adapted from the Richardson-and-Holland process for caustic and chlorine. In the cell the cathode is placed above, the anode below, and the temperature is kept at 80° or 90° C. When one-half of the potassium chloride in the cell has been converted into chlorate, the liquor is drawn off and the chlorate crystallizes out. The cathodes are then renewed, and those just used are reoxidized by heating in the air. This process is at present in successful operation at Niagara Falls.

108. It has recently been shown that the presence of alkaline carbonates or the alkaline-earth hydrates in the cell greatly increases the yield of the chlorate, and probably all of the factories use one of these substances or calcium chloride as a constituent of the cell solution. In just what way these materials act is at present unknown, although several theories have been advanced.

ALKALIES AND HYDROCHLORIC ACID

(PART 3)

ANALYTICAL METHODS

AMMONIA SODA

CRUDE MATERIALS

1. Brine.—1. The *specific gravity* is determined by means of a hydrometer or specific-gravity spindle; the amount of salt in the brine can then be stated with a fair degree of accuracy by reference to a table. This test is so rapidly made that it is used frequently for checking the brine as to its salt content when it comes to the works. Table I gives the percentage of sodium chloride corresponding to each specific gravity from 1 per cent. of salt to a saturated solution.

For convenience, special hydrometers are frequently used which are so graduated that percentage of salt is read direct, or the point where it stands in a saturated salt solution is marked 100 and the stem between this point and that which pure water gives is divided into 100 parts, so that the observer reads the percentage of the saturation of the brine.

§ 31

For notice of copyright, see page immediately following the title page.

2 ALKALIES AND HYDROCHLORIC ACID § 31

To obtain the number of grams of salt in a liter of its brine, we move the decimal point in the specific-gravity value one point to the right and multiply by the percentage

TABLE I

Specific Gravity	Per cent. NaCl	Specific Gravity	Per cent. NaCl	Specific Gravity	Per cent. NaCl
1.00725	1	1.07335	10	1.14315	19.000
1.01450	2	1.08097	11	1.15107	20.000
1.02174	3	1.08859	12	1.15931	21.000
1.02899	4	1.09622	13	1.16755	22.000
1.03624	5	1.10384	14	1.17580	23.000
1.04366	6	1.11146	15	1.18404	24.000
1.05108	7	1.11938	16	1.19228	25.000
1.05851	8	1.12730	17	1.20098	26.000
1.06593	9	1.13523	18	1.20433	26.395

of salt at the specific gravity observed. For example, if the specific gravity is 1.204, then $12.04 \times 26.39 = 317.74$ grams per liter.

2. *Inorganic sediment* is determined by filtering 500 cubic centimeters of the brine through a filter of known ash, igniting, and weighing. After subtracting the ash and multiplying the remainder by 2, the result is grams of inorganic sediment per liter of brine.

3. *Ferric Oxide and Alumina*.—200 cubic centimeters of filtered brine is acidified with a few cubic centimeters of nitric acid and heated for 10 minutes in order to oxidize any possible ferrous compounds, made slightly alkaline with ammonium hydrate, warmed 10 minutes, and filtered. The precipitate is redissolved in hydrochloric acid and the ferric oxide and alumina determined as usual. The number of grams of Fe_2O_3 and $Al_2O_3 \times 5 =$ grams of Fe_2O_3 and Al_2O_3 per liter of brine.

4. *Calcium oxide* is determined in the filtrate from the iron and alumina. One-half gram of ammonium chloride is added, and to the hot ammoniacal solution sufficient ammonium oxalate added to precipitate all the calcium. The calcium oxalate is filtered off, strongly ignited over a blast, and weighed as CaO . This weight, after subtracting the filter ash and multiplying by 5, gives the grams of CaO per liter of brine.

5. *Magnesia* is determined in the filtrate from the calcium precipitate by adding ammonium phosphate and strong ammonia solution, equal to one-third of the total volume of the solution, allowing to stand 24 hours, filtering, washing with dilute ammonia water, igniting at red heat, and weighing. The precipitate, after subtracting the filter ash, is magnesium pyrophosphate $Mg_2P_2O_7$. $Wt. Mg_2P_2O_7 \times .36036 \times 5 =$ grams MgO per liter of brine.

6. *Sulphur Trioxide*.—50 cubic centimeters of the filtered brine is acidified with a few drops of hydrochloric acid, diluted with an equal volume of distilled water, and heated to boiling. Boiling hot barium chloride is slowly added in slight excess and the whole allowed to stand until the precipitate completely settles. The barium sulphate is then filtered off and washed with hot water, first by decantation and then on the filter until free from chlorides. The precipitate is then ignited and weighed as usual. The weight of barium sulphate $BaSO_4 \times .34335 \times 20 =$ grams SO_3 per liter of brine.

7. *Sodium Chloride*.—The amount of salt in the brine is usually determined with sufficient accuracy by means of the hydrometer. If a more accurate determination is wanted, 10 cubic centimeters of the clear brine is diluted to 1,000 cubic centimeters and 10 cubic centimeters of this dilute solution is titrated with $\frac{1}{10}$ normal solution of silver nitrate, using potassium chromate as indicator. The number of cubic centimeters of $\frac{1}{10}$ normal solution of silver nitrate $\times .00355 \times 10,000 =$ grams of chlorine per liter.

4 ALKALIES AND HYDROCHLORIC ACID § 31

Or, without a very great error, we may state, number cubic centimeters $\frac{1}{10}$ normal $AgNO_3$ solution $\times .00585 \times 10,000$ = grams salt per liter.

2. Grouping of Substances Determined.—The most rational method of procedure is to report each substance as found, but it is a very common requirement that the results shall be reported grouped together so as to form salts. In this case, this result is obtained by combining the SO_3 and CaO to form $CaSO_3$, any excess of calcium and the magnesium are then combined with chlorine and the excess of chlorine is then calculated as salt. Ferric oxide and alumina are usually reported as such.

3. Limestone.—For the analysis of an average sample of the limestone used through the month, and, in general, for a careful control of the materials used, the method of analysis given for limestone in *Quantitative Analysis* should be used. It frequently happens, however, that it is necessary to analyze one or more samples of the rock each day as it comes from the quarries. In that case the following more brief method is preferable.

1. *Insoluble.*—1 gram of the limestone is treated with an excess of dilute hydrochloric acid, warmed, filtered, washed, ignited, and weighed. In case the limestone contains a large amount of organic matter, this may be determined by filtering through a filter paper that has been heated to $100^\circ C.$, cooled in a desiccator, and weighed. In this case the insoluble matter is dried at $100^\circ C.$, cooled, and weighed before ignition. The difference between the weight of the insoluble matter before and after ignition gives the amount of organic insoluble matter.

2. *Limc.*—Dissolve 1 gram of the sample in 25 cubic centimeters of normal hydrochloric acid and titrate back to the neutral point with normal soda solution, using methyl orange as indicator. The difference between the number of cubic centimeters of acid and alkali used gives the number

of cubic centimeters of acid neutralized by the limestone. The number of cubic centimeters of acid used $\times 2.8 =$ percentage of CaO ; or number of cubic centimeters of acid used $\times 5 =$ percentage of $CaCO_3$. By this method the magnesium carbonate in the limestone is reported as a calcium compound, but for most limestone used in the ammonia-soda industry this can be overlooked.

3. *Magnesia*. — In case the amount of magnesia is required, dissolve 2 grams of limestone in hydrochloric acid and precipitate the calcium directly by the addition of ammonium hydrate and ammonium oxalate to the hot solution. Allow to stand 10 minutes at a gentle heat, then filter and wash. Determine the magnesium in the filtrate by precipitating with ammonium phosphate. Make the solution strongly ammoniacal and let stand 2 hours with frequent, thorough stirring. The precipitate may then be filtered off, ignited, and weighed as $Mg_3P_2O_8$. $Mg_3P_2O_8 \times 18.018 =$ percentage of MgO in the limestone; $Mg_3P_2O_8 \times 37.868 =$ percentage of $MgCO_3$ in the limestone.

We can now correct the value obtained for lime. The molecular weight of $MgO = 40$ and of $CaO = 56$, therefore CaO is $\frac{56}{40}$, or 1.4 times heavier than MgO ; therefore the percentage of $MgO \times 1.4 =$ percentage of CaO that this percentage of magnesia would give as lime. In the same way we find that the percentage of $MgCO_3 \times 1.19 =$ percentage of $CaCO_3$. It is now possible to report the percentage of lime or calcium carbonate in the limestone with a fair degree of accuracy. For example, if it is found that the limestone apparently contains 95 per cent. of $CaCO_3$, and then find 2 per cent. of $MgCO_3$, the true percentage of $CaCO_3$ is $95 - (2 \times 1.19) = 92.62$ per cent.

4. *Quicklime*. — The analysis of the monthly average and the careful check determinations should be carried out in the same manner as is described for limestone in *Quantitative Analysis*. In reporting the result of the analysis, the carbon dioxide and sulphur trioxide are combined with the lime, and the remainder of the calcium and the magnesium

reported as oxides. Where less accurate results will answer, the following method is preferred.

1. *Insoluble*.—The amount of insoluble matter is determined as in Art. 3.

2. *Free Calcium Oxide*.—Weigh out 50 grams of an average sample of the lime, and after carefully slaking it, bring the mass into a 1,000-cubic-centimeter measuring flask, fill to the mark, and thoroughly mix. Pipette out, without allowing the suspended matter to settle, 100 cubic centimeters and dilute to 500 cubic centimeters, shake thoroughly and pipette out 100 cubic centimeters for titration with normal hydrochloric acid, using phenol phthalein as indicator. The number of cubic centimeters of acid required to just discharge the pink color multiplied by 2.8, gives the percentage of CaO .

3. *Calcium Carbonate*.—Titrate 1 gram of the sample, using methyl orange as indicator, as under Art. 3. By subtracting the number of cubic centimeters of normal acid required above from the number of cubic centimeters required here, the number of cubic centimeters of normal acid required for the calcium carbonate is obtained. This value multiplied by 5 gives the percentage of calcium carbonate.

4. *Magnesia*.—Determine as under Art. 3.

5. *Ammonia Liquor*.—The crude ammonia liquor as it comes to the works from the gas manufacturer frequently, especially in cold weather, contains crystals. The liquor is measured and the crystals weighed before sending them to the storage tanks, and a sample of each is sent to the laboratory for analysis.

1. *Specific Gravity*.—The specific gravity of the gas liquor is taken with a hydrometer. This determination is, however, of very secondary importance to the direct determination of the ammonia.

2. *Ammonia* is determined, both in the crystals and in the gas liquor, according to the volumetric method described in *Quantitative Analysis*.

6. **Coal and Coke.**—These are analyzed by the method described in *Quantitative Analysis*.

INTERMEDIATE PRODUCTS

7. **Ammoniacal Brine.**—The determinations ordinarily made are free and combined ammonia and salt.

1. *Free and Combined Ammonia.*—Dilute 10 cubic centimeters of the ammoniacal brine with distilled water to about 100 cubic centimeters, introduce it into a distilling flask (see *Quantitative Analysis*), and boil until all the ammonia and ammonium carbonate are driven off. The ammonia and ammonium carbonate are collected in normal sulphuric acid and determined as usual. The result is free ammonia.

A new receiver containing normal sulphuric acid is then attached and ammonia-free sodium-hydrate solution is introduced into the distilling flask. The combined ammonia is then driven over by the boiling and is determined by titrating the acid in the receiver.

2. *Salt.*—On account of the free alkali present in this brine the common method of titrating with silver nitrate cannot be used, unless the ammonia is exactly neutralized with nitric acid; even then the results lack exactness. The so-called Volhard method, which possesses the advantage that it can be used in a nitric-acid solution, is therefore used. This method is described in *Quantitative Analysis*.

8. **Lime-Kiln Gases.**—Carbon dioxide, carbon monoxide, and oxygen must be determined in the gases coming from the lime kiln. These determinations may be made with the Orsat-Muenke apparatus, described in *Quantitative Analysis*, under "Gas Analysis," or, on account of its cheapness, by means of the Bunte burette.

9. Bunte Burette.—The apparatus shown at *c*, Fig. 1, consists of a simple glass tube a little over 100 cubic centimeters capacity and closed at each end by well-

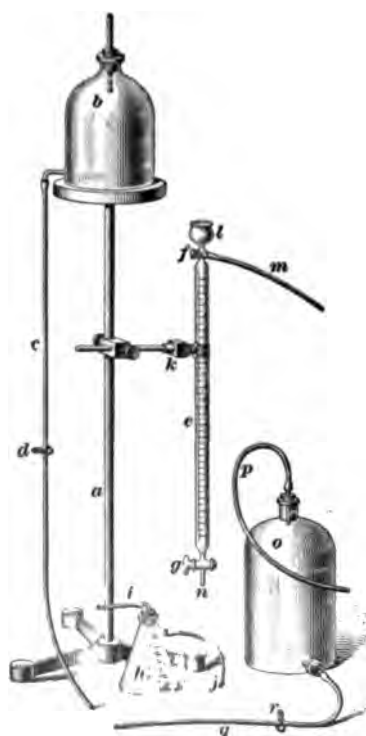

FIG. 1

fitting stop-cocks *g* and *f*. The stop-cock at *g* is the ordinary two-way style; the one at *f* is a three-way stop-cock, so that the tube can be put in connection with the source of gas through the end of the cock and the rubber tube *m*, or it can be connected with the cup-shaped receptacle *l*, which is made above *f*. The tube *c* is graduated in $\frac{1}{10}$ cubic centimeters for 100 cubic centimeters down from *f*. Frequently the burette is surrounded by a water-jacket to prevent variations of temperature. This is, however, an unnecessary accessory and seriously interferes with the manipulation of the burette.

10. Manipulation of the Bunte Burette.—The

burette is first filled with gas to be analyzed.

(a) If only a limited amount of gas is available for analysis, the burette is first filled with water from the reservoir *b*, Fig. 1. For this purpose the rubber tube *c* is attached to the tip of the burette *n*, the stop-cock *g* is opened, and *f* is turned so as to connect the burette with *m*. Then by releasing the pinch cock *d* water flows from *b* to fill the whole apparatus. The stop-cocks are then closed, *c* is removed from *n*, and *m* is attached to the gas supply. By then again opening the stop-cocks *f* and *g* the water flows out at *n* and

the burette fills with gas, which is then secured by closing the stop-cocks.

(*b*) When gas is abundant and under pressure, the tube *m* is attached to the source, *f* and *g* are opened, and 2 or 3 liters of gas allowed to flow through the burette, thus sweeping out the air and leaving a good sample of gas. By closing *f* and *g* the gas is enclosed.

(*c*) When the gas is abundant, but not under pressure, as happens in taking samples between the lime kilns and the pumps, it is necessary to attach an aspirator at *n* to draw the gas through the burette. A suitable arrangement for aspirating in this case consists of a large bottle *o*. This bottle is filled with water, the rubber tube *p* attached at *n*, the pinch cock *r* opened, and then the stop-cocks *g* and *f* opened. After 2 or 3 liters of gas have been drawn through the burette, first *g* and then *f* is closed, *p* is disconnected from *n*, and the sample is ready for analysis.

Having the burette filled with the sample of gas, the cup *l* is filled with water to a mark that is 1 centimeter above the stop-cock *f*, *c* is then attached to *n*, and *d* and *g* opened. Water thus flows into the burette and compresses the gas. When the water reaches the 100-cubic-centimeter mark, *g* is closed and *f* is turned to connect the burette with *l*. Gas will escape until the gas in the burette is under the atmospheric pressure, plus the pressure of 1 centimeter of water. *f* is then closed and the volume of gas read (it should be exactly 100 cubic centimeters). The rubber tube *i* of the suction flask *h* is then attached at *n*, *g* is opened, and, by sucking on *j*, the water is almost completely removed from the burette, leaving a partial vacuum; *g* is then closed, and *i* removed from *n*.

For the determination of carbon dioxide, a small beaker containing a suitable solution of caustic potash is brought under *n*, and *g* turned so that the alkali solution rises in the burette; *g* is then closed. The burette is then grasped at *l*, loosened from the clamp *k* (the ends of the burette are grasped between the first and second fingers of each hand

beyond the stop-cocks to avoid heating the gas by the hands), and after the water is emptied from *l*, the burette is thoroughly shaken, so that the gas is well mixed with the caustic potash. The burette is then replaced in the clamp *k*, *n* is brought under caustic-potash solution, and *g* again opened. The alkali will rise in the tube, and when it has filled as much as it will, *g* is once more closed and the burette shaken as before. This is repeated as long as the alkali solution continues to rise in the burette. Water is then filled to the 1-centimeter mark in *l*, *f* is opened to insure equal pressure, then closed, and the volume of gas read. The difference between this reading and 100 gives the volume percentage of the carbon dioxide in the gas mixture.

For the determination of oxygen, the caustic potash is removed as far as possible by means of the suction flask *h*, and alkaline pyrogallol allowed to rise in the burette in its place. The same operations as for carbon dioxide are performed until all the oxygen is absorbed. The volume of gas is then read. The difference between this volume and 100 gives the volume percentage of carbon dioxide and oxygen, and deducting the volume percentage of carbon dioxide leaves the volume percentage of oxygen in the gas.

In each of the above cases the gas is read over strongly alkaline liquids that tend to adhere to the burette and render the results inaccurate. This can be avoided by sucking out the alkaline liquid, allowing water to enter, rinsing the burette two or three times, each time sucking out the water, and then measuring the gas over nearly pure water.

The carbon monoxide is determined by sucking out the alkaline pyrogallol or water after measuring the oxygen, replacing it with a hydrochloric-acid solution of cuprous chloride, and proceeding as in the preceding cases. After the carbon monoxide has been completely absorbed, as shown by the absorbing liquid no longer rising in the burette, the absorbing liquid is sucked out as completely as possible and the gas washed two or three times with water to completely remove the hydrochloric acid. This diminution in volume of the gas gives the volume percentage of carbon monoxide

in the gas; the remainder of the gas is the volume percentage of nitrogen in the gas.

11. Reagents for the Bunte Burette.—The caustic potash is made by dissolving 100 grams solid potassium hydrate in 200 cubic centimeters of water.

The alkaline pyrogallol is made by dissolving 32 grams potassium hydrate in 200 cubic centimeters of water and 40 grams of pyrogallic acid in 200 cubic centimeters of water. The two solutions are thoroughly mixed and kept carefully guarded from the air in a rubber-stoppered bottle. It is even better to keep the two solutions separate and only mix them when needed for use.

The cuprous-chloride solution is made by dissolving 200 grams of cupric chloride in 500 cubic centimeters of water and 500 cubic centimeters of concentrated hydrochloric acid, and allowing the solution to stand tightly stoppered in a bottle containing copper turnings or strips of sheet copper until it becomes clear and colorless.

12. Liquor From Carbonators.—The free and combined ammonia are determined as described in Art. 7. These are the only determinations usually made.

13. Bicarbonate From the Filters.—1. *Total alkali* is determined by titrating 4.2 grams of the sample with normal sulphuric acid, using methyl orange as indicator. Each cubic centimeter of normal acid used corresponds to .738 per cent. of Na_2O in the sample.

2. *Sodium Bicarbonate.*—The determination of sodium bicarbonate in the presence of sodium carbonate depends on the reaction

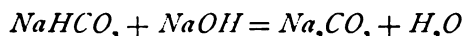

Silver nitrate is used as indicator, for it gives a white precipitate with sodium carbonate, but as soon as a single drop of caustic-soda solution is present in excess the silver carbonate precipitate turns brown, owing to the formation of silver oxide.

Normal sodium-hydrate solution is prepared by dissolving 50 grams of pure sodium hydrate in 1 liter of water and adding sufficient barium hydrate to more than precipitate all the carbon dioxide. The solution is then standardized as usual by titrating with normal sulphuric acid, using phenol phtal-ein as indicator, and then corrected to exactly normal strength. This solution must after standardization be carefully guarded from the carbon dioxide of the air.

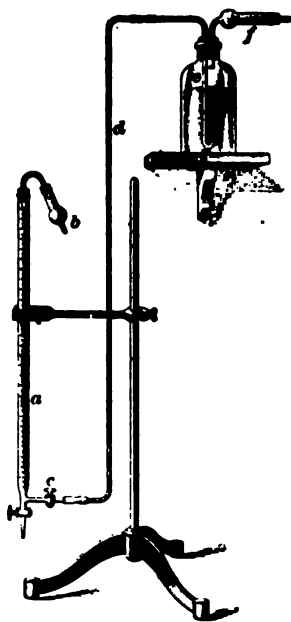

FIG. 2

A convenient arrangement for the solution and burette is shown in Fig. 2. The burette *a* is closed at the top with a stopper, through which passes a glass tube connecting with a sugar funnel *b*, which is filled with pieces of soda lime and so removes the carbon dioxide from the air that enters the burette. At the lower end of the burette a tube is blown on which connects, by means of the glass tube *d* and two short pieces of rubber tube, with the bottle *e* containing the standard solution. The bottle *e* is closed with a two-holed rubber stopper, through one hole of which leads the tube *d* to the burette, and through the other a glass tube to the sugar funnel *f* that contains the soda lime. The liquid can be started first by blowing on the end of *f* after the stop-cock *c* has been opened. After the apparatus is once in operation the burette can be repeatedly filled, by merely opening the stop-cock *c*, without exposing the solution to the air at any point.

The determination is made by weighing out in a beaker 4.2 grams of the sample, adding 100 cubic centimeters of water (not warmer than 20° C.), and running in the caustic-soda

solution until within about 1 cubic centimeter of the end reaction. The solution is then thoroughly stirred and the standard solution run in, at first .2, and then .1 cubic centimeter at a time, until a drop taken out and brought in contact with a 25-per-cent. silver-nitrate solution on a white plate shows a brown color at once. Even before the end point, the drops turn brown on standing. If the composition of the sample is not approximately known at first, it must be approximately determined by weighing out a portion of the sample and running in the standard caustic 2 or 3 cubic centimeters at a time and testing until the end point is passed. Then, for the final determination, somewhat less than this amount of the standard solution is taken as above. The number of cubic centimeters of the normal alkali used multiplied by 2 gives the percentage of sodium bicarbonate in the sample.

3. The percentage of *sodium carbonate* in the sample is given by multiplying the difference between the number of cubic centimeters of normal acid required for the total alkali and the number of cubic centimeters of normal caustic alkali required for sodium bicarbonate by $\frac{1}{2}$. For example, if it takes 39 cubic centimeters of normal acid to neutralize a sample and 35 cubic centimeters of normal alkali to convert the bicarbonate into the carbonate, then $39 \times .738 = 28.79$ per cent. of Na_2O ; $35 \times 2 = 70$ per cent. of sodium bicarbonate; and $(39 - 35) \times \frac{1}{2} = 5.05$ per cent. of sodium carbonate.

4. *Ammonia* is determined according to the volumetric method given in *Quantitative Analysis*.

5. *Moisture* is determined by weighing out 10 grams of the sample in a small platinum or porcelain evaporating dish and heating, at first carefully on a sheet of asbestos, and finally to from 300° to 400° C. The loss in weight, after deducting the carbon dioxide corresponding to the sodium bicarbonate, gives the moisture.

14. Mother Liquor.—The mother liquor from the filtration of the liquors from the carbonators is tested for free and combined ammonia and salt.

1. *Free and combined ammonia* are determined as under Art. 7.

2. *Salt* is determined by evaporating 10 cubic centimeters of the liquor to dryness in a platinum dish, heating the residue until the ammonium chloride is volatilized, then cooling and weighing.

15. Milk of Lime.—1. The determination of the *specific gravity* usually is sufficient for controlling the milk of lime. If the milk of lime is thin, it is thoroughly mixed and the reading on the hydrometer is quickly taken. If the milk of lime is thick, a rather broad cylinder is selected, the milk of lime thoroughly mixed, the hydrometer inserted, and the cylinder jarred on the table until the hydrometer will sink no lower, when it is read. A hydrometer called the *Baumé hydrometer*, with the spindle arbitrarily divided into so-called degrees, is frequently used for this purpose. Table II shows the degrees Baumé and grams per liter of calcium oxide corresponding to a considerable range of specific gravities.

2. *Complete Analysis.*—At intervals a complete analysis of the milk of lime is required. For this purpose the sample is thoroughly mixed, and 250 cubic centimeters measured out and filtered. The residue on the filter is taken without washing, dried at 100° C., and weighed. This weight multiplied by 4 gives the undissolved portion per liter.

The undissolved portion and the filtrate are then separately analyzed, exactly as under "Quicklime."

16. Waste From Ammonia Stills.—1. *Excess of lime* is the constituent of this waste, concerning which it is most important for us to have information—that is, the lime that is still available for liberating ammonia from its salts. For its determination, boil 100 cubic centimeters of the waste until no more ammonia is given off, then add ammonium sulphate in excess, boil again, and collect the ammonia evolved this time in normal acid (see the volumetric determination of ammonia, *Quantitative Analysis*). By titrating, the necessary information for finding the amount

§ 31 ALKALIES AND HYDROCHLORIC ACID 15

of ammonia evolved is obtained, and from this it is a simple matter to calculate the amount of free lime in the waste.

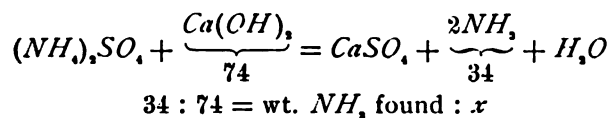

$x \times 10 =$ the amount of available lime per liter of the waste.

TABLE II

Specific Gravity	Degrees Baumé	Grams CaO in Liters	Specific Gravity	Degrees Baumé	Grams CaO in Liters
1.007	1	7.5	1.125	16	159
1.014	2	16.5	1.134	17	170
1.022	3	26.0	1.142	18	181
1.029	4	36.0	1.152	19	193
1.037	5	46.0	1.162	20	206
1.045	6	56.0	1.171	21	218
1.052	7	65.0	1.180	22	229
1.060	8	75.0	1.190	23	242
1.067	9	84.0	1.200	24	255
1.075	10	94.0	1.210	25	268
1.083	11	104.0	1.220	26	281
1.091	12	115.0	1.231	27	295
1.100	13	126.0	1.241	28	309
1.108	14	137.0	1.252	29	324
1.116	15	148.0	1.263	30	339

2. *Complete Analysis.*—Determine the specific gravity, the amount of undissolved material, and analyze the insoluble portion as in Art. 15. In the soluble portion:

(a) Titrate 50 cubic centimeters with normal sulphuric acid, using phenol phthalein as indicator, and calculate the result as $Ca(OH)_2$.

(b) Determine the calcium in 25 cubic centimeters, as usual, by precipitating with ammonia and ammonium oxalate, filtering, and titrating the precipitate with potassium

permanganate. Deduct the calcium corresponding to the amount of calcium hydrate found under (a) and calculate the remainder as calcium chloride in grams per liter.

(c) Determine the sulphur trioxide in 50 cubic centimeters by precipitating with barium chloride, and calculate the result as sodium sulphate in grams per liter.

(d) Determine the chlorine in 5 cubic centimeters by Volhard's method. Deduct the chlorine corresponding to the calcium chloride found under (b) and calculate the remainder as sodium chloride in grams per liter.

THE FINISHED PRODUCT

17. Soda Ash.—For the complete analysis of soda ash, the following determinations are usually made :

1. *Sodium Carbonate.*—Weigh out 2.65 grams of the dry substance, dissolve in about 150 cubic centimeters of water, and titrate with normal sulphuric acid, using methyl orange as indicator. The number of cubic centimeters of acid used multiplied by 2 gives the percentage of sodium carbonate.

2. *Sodium Bicarbonate.*—This substance rarely occurs in large amounts in soda ash, and its determination may usually be omitted. If there is a reason for determining it, use the method given under Art. 13.

3. *Sodium Chloride.*—Dissolve 5 grams of the sample in water and titrate by Volhard's method.

4. *Silica.*—Dissolve 50 grams of the sample in about 150 cubic centimeters of water and acidify with concentrated hydrochloric acid, evaporate to dryness on the water bath, take up with water and a little hydrochloric acid, filter, ignite, and weigh. Calculate as silica; of course it consists of everything insoluble in hydrochloric acid.

5. *Ferric Oxide and Alumina.*—Determine the ferric oxide and alumina in the filtrate from the silica by precipitating with ammonia as usual.

6. *Calcium Carbonate.*—Divide the filtrate from the above determination into two equal parts, and in one half

determine the calcium, as usual, with ammonia and ammonium oxalate, and calculate as calcium carbonate.

7. *Magnesium Carbonate*.—Determine the magnesium in the filtrate from the calcium determination, as usual, with ammonium phosphate, and calculate as magnesium carbonate.

8. *Sodium Sulphate*.—Determine the sulphur trioxide in the other half of the filtrate from the ferric oxide and alumina determination by means of barium chloride, as usual, and calculate as sodium sulphate.

A complete analysis of this character is necessary from time to time, usually each month, of an average of the soda ash made. For the daily control of the output, however, a determination of the sodium carbonate and the sodium chloride is generally sufficient.

SALT-CAKE PROCESS

CRUDE MATERIALS

18. *Salt*.—The usual determinations are as follows:

1. *Sodium Chloride*.—Weigh out 4 grams of the sample, dissolve in water, and dilute to 1,000 cubic centimeters. Take 50 cubic centimeters of this solution and titrate with $\frac{1}{10}$ normal silver nitrate, using about $\frac{1}{2}$ cubic centimeter of potassium chromate as indicator. This gives the total chlorine, and when no other substances are determined, this is all calculated as sodium chloride. When magnesium and other substances present as chlorides are determined, the chlorine of these is first subtracted from the total before calculating it as sodium chloride.

2. *Water*.—The determination of water in salt offers some difficulties on account of its tendency to decrepitate and so fly out of the dish in which one is heating it. The most satisfactory method of making the determination is to select a tall Erlenmeyer flask of Jena glass, of about 250 cubic centimeters capacity, and weigh it with a small

funnel in its mouth. About 5 grams of salt are then introduced and its weight exactly established by weighing flask, funnel, and salt. The funnel is then removed and the flask is heated for 3 or 4 hours on a suitable sand bath, which has a temperature of about 150° C. The funnel is then replaced in the mouth of the flask and the whole allowed to cool and then weighed. The funnel serves the purpose of preventing the air from circulating in the flask, so it can be cooled out of a desiccator. This determination gives all the water in the salt except part of that which is chemically combined with impurities. For most purposes the combined water can be neglected, but when it is necessary to determine it, this can be done by heating the flask to 300° or 400° C. with the funnel in its mouth, cooling and weighing.

3. *Sulphur Trioxide.* — Dissolve 10 grams of salt in about 300 cubic centimeters of water, acidify with hydrochloric acid, and digest at 70° or 80° C. for an hour to dissolve all the calcium sulphate present. Make this to 500 cubic centimeters, filter through a dry filter, and take 250 cubic centimeters for analysis. Determine the sulphur trioxide by precipitating, as usual, with barium chloride in a hot solution. Unless there are reasons for doing otherwise, the sulphur trioxide is calculated as calcium sulphate.

4. *Other Determinations.* — These determinations are sufficient for the daily work, unless salt happens to come in from a new source, when it must be analyzed like the average sample below. The daily samples are saved, however, and at the end of each month an average sample is prepared and, in addition to the above determinations, insoluble in acids, ferric oxide and alumina, calcium, and magnesium are determined. For this purpose 50 grams of the sample are dissolved in water and hydrochloric acid and the determinations are carried out as under Art. 1.

The magnesium is calculated as chloride, and the calcium in excess of the sulphur trioxide is calculated as calcium chloride. Conversely, any sulphur trioxide in excess of the calcium is calculated as sodium sulphate.

FINISHED PRODUCT

19. Salt Cake.—The determinations usually made are as follows:

1. *Free Acid.*—Dissolve 20 grams of the salt cake in water and dilute to 250 cubic centimeters. Take 50 cubic centimeters and titrate with normal sodium-hydrate solution, using methyl orange as indicator. The acidity is calculated as sulphur trioxide, although it may be due to hydrochloric acid and salts of the heavy metals, as well as acid sodium sulphate. If the salt cake contains large amounts of iron and aluminum salts, and it is desired to exclude the acidity due to these salts, the titration may be carried on without an indicator and the end point taken when flakes of the precipitate of the hydrates begin to appear. Each cubic centimeter of sodium-hydrate solution used corresponds to 1 per cent. of sulphur trioxide.

2. *Salt.*—Take 50 cubic centimeters of the solution prepared as above and determine the chlorine according to Volhard's method, using $\frac{1}{10}$ normal silver nitrate. Calculate all the chlorine to sodium chloride. Each cubic centimeter of silver-nitrate solution used corresponds to .0731 per cent. of salt.

For the daily determinations, these two substances are all that are necessary, except when the salt cake is being made especially free from iron for use in glass manufacture, when this must also be determined in each batch. For the monthly average sample and for certain cases for shipment, it is also necessary to make the following determinations:

3. *Insoluble in Acids.*—Determine in 50 grams of sample, as under "Silica," Art. 17.

4. *Ferric Oxide.*—Weigh out 20 grams of the sample, reduce with zinc and sulphuric acid, and titrate with permanganate, as directed in *Quantitative Analysis*.

5. *Alumina.*—Dissolve 20 grams of the sample in about 150 cubic centimeters of water, add hydrochloric acid, and

precipitate with ammonia as usual. After weighing the combined oxides, deduct the ferric oxide found above and calculate the remainder to the percentage of alumina.

6. *Lime*.—Determine, as usual, in the filtrate from the alumina determination.

7. *Magnesia*.—Determine, as usual, in the filtrate from the lime determination.

8. *Sodium Sulphate*.—The determination of the sodium sulphate in this case is a rather difficult matter and it is frequently taken as the difference between the total percentage of the other substances found and 100. Perhaps the most satisfactory method of procedure is to dissolve 2 grams of the sample in as little hot water as possible, make alkaline with ammonia, and precipitate so far as possible with ammonium carbonate. Filter and redissolve the precipitate in as little hydrochloric acid as possible and reprecipitate with ammonia and ammonium carbonate. Filter and unite the two filtrates in a platinum dish and evaporate to dryness, moisten the residue with sulphuric acid to be certain that the salt present is all converted into sulphate, heat to drive off the excess of acid, and weigh. Calculate the salt found by Volhard's method to sulphate, deduct this weight from that found above, and the remainder is sodium sulphate.

LE BLANC PROCESS

CRUDE MATERIALS

20. Salt cake is analyzed according to Art. 19.

21. Limestone is analyzed according to Art. 3.

22. Coal is analyzed according to the method given in *Quantitative Analysis*. In addition, determine the nitrogen by Kjeldahl's method, which also is described in *Quantitative Analysis*.

INTERMEDIATE PRODUCTS

23. Black Ash.—The obtaining of a representative sample presents perhaps more difficulties than are usually the case, for the charges as drawn from the furnace are hard and very non-homogeneous, so that great care must be exercised in selecting the sample to get it as representative as possible, for even at best it is imperfect. After the sample has been carefully selected, it is rapidly crushed and mixed so that 50 grams of an average of the sample can be weighed out. These 50 grams are rapidly but thoroughly ground in a mortar and then brought into a 500-cubic-centimeter flask, the mortar rinsed down with water, which has been boiled to expel carbon dioxide, and then cooled to about 35° C. The rinsings of the mortar are poured into the flask and the flask filled nearly to the 500-cubic-centimeter mark with the same warm water. During the pouring of the rinsings and water on the black ash, it must be thoroughly shaken to prevent its caking together on the bottom of the flask. The flask is then allowed to stand about 2 hours with frequent shaking. A preferable arrangement, and one that saves much work, is to use one of the many stirrers that run by a turbine or an electric motor. They may be obtained from any dealer in chemical apparatus. After standing 2 hours the flask is filled to the mark and the solution is ready for use.

1. *Free Lime.*—Thoroughly mix the contents of the flask and pipette out 25 cubic centimeters of its contents into a porcelain dish. The outside of the pipette should be rinsed off before running out its contents and then the inside should be rinsed into the porcelain dish. Add an excess of a 10-per-cent. barium-chloride solution and titrate with normal hydrochloric acid, using phenol phthalein as indicator. Each cubic centimeter of acid solution equals 1.12 per cent. of CaO .

2. *Total Lime.*—Pipette out, as above, 25 cubic centimeters from the supply flask into a small flask, make acid with concentrated hydrochloric acid, and boil to expel all

the carbon dioxide. Add a few drops of methyl orange and then sodium carbonate to exactly neutralize. Add 40 cubic centimeters of a normal sodium-carbonate solution and boil to precipitate all the calcium (together with magnesium, etc., which, however, can be neglected) as the granular carbonate. Make up to 250 cubic centimeters and filter through a dry filter. Take 125 cubic centimeters and titrate back to neutral with normal hydrochloric acid, using methyl orange as indicator. Each cubic centimeter of the sodium carbonate used in excess of the acid required to titrate back is equal to 2.24 per cent. of CaO . Neither of the above methods is very exact, but they answer for factory control. The supply flask is now tightly stoppered and allowed to stand until the liquor has become completely clear.

3. *Total alkali* comprises all the sodium present as carbonate, sulphide, and hydrate. Pipette out 20 cubic centimeters of the clear liquid from above and titrate, as usual, with normal hydrochloric acid, using methyl orange as indicator. Each cubic centimeter of acid corresponds to 1.55 per cent. of Na_2O .

4. *Sodium Sulphide*.—Pipette out 10 cubic centimeters of the clear liquor from the supply flask, dilute to about 200 cubic centimeters, acidify with acetic acid, and titrate with $\frac{1}{10}$ normal iodine solution, using starch paste as indicator. Each cubic centimeter of iodine solution used equals .39 per cent. of sodium sulphide, and is equivalent to .1 cubic centimeter of normal acid.

5. *Caustic Soda*.—Pipette out 40 cubic centimeters of the clear liquid from the supply flask into a 100-cubic-centimeter measuring flask, add 20 cubic centimeters of a 10-per-cent. barium-chloride solution, and fill to the mark with water. Thoroughly shake and allow to settle. Pipette out 50 cubic centimeters and titrate with normal hydrochloric acid, using methyl orange as indicator. This titration gives both sodium hydrate and sodium sulphide. To determine the hydrate alone, multiply the number of cubic centimeters of iodine solution used above by 20 and

subtract the product from the number of cubic centimeters of normal acid used here. The remainder gives the number of cubic centimeters of normal acid used for the caustic soda, and each cubic centimeter equals 2 per cent. of *NaOH*.

6. *Sodium Carbonate*.—Subtract the total amount of hydrochloric acid used for the sodium hydrate and the sodium sulphide above from the amount used for the total alkali, and the difference gives the number of cubic centimeters of normal acid used for the sodium carbonate. Each cubic centimeter of normal acid equals 2.65 per cent. of sodium carbonate.

7. *Salt*.—Pipette out 10 cubic centimeters of the clear liquid from the supply flask and titrate according to Volhard's method for chlorine. All the chlorine is calculated as salt, and each cubic centimeter of the $\frac{1}{10}$ normal silver nitrate solution used equals .58 per cent. of salt.

8. *Sodium Sulphate*.—Pipette out 20 cubic centimeters of the clear liquid from the supply flask and add hydrochloric acid in slight excess. Boil to expel carbon dioxide and precipitate hot, as usual, with barium chloride. The weight of barium sulphate multiplied by .3047 gives the percentage of sodium sulphate.

24. Lye From Extraction of Black Ash.—The following determinations are made :

1. *Specific Gravity*.—Determine the specific gravity of the warm lye by means of the Baumé hydrometer.

2. *Total Alkali*.—Determine the total alkali in 2 cubic centimeters of the lye, as under Art. 23.

3. *Sodium Sulphide*.—Determine the sodium sulphide in 2 cubic centimeters of the lye, as under Art. 23.

4. *Caustic Soda*.—Determine the caustic soda in 2 cubic centimeters of the lye, as under Art. 23.

5. *Sodium Carbonate*.—Determine the sodium carbonate, as under Art. 23.

6. *Salt*.—Determine the salt in 2 cubic centimeters by Volhard's method, described in *Quantitative Analysis*.

7. *Sodium Sulphate*.—Determine the sodium sulphate in 5 cubic centimeters, as under Art. 23.

8. *Total Sulphur*.—Treat 5 cubic centimeters of the lye with an excess of bleaching powder and hydrochloric acid (the chlorine must smell strongly). Boil off the chlorine, filter from insoluble matter, and precipitate with barium chloride, as usual.

9. *Sodium Ferrocyanide*.—Acidify 30 cubic centimeters of the lye with hydrochloric acid and add, with constant stirring, a strong solution of bleaching powder from a burette, until a drop taken out shows no blue color with a ferric-chloride solution. The ferric chloride must be free from ferrous salts, and the end point must be quite accurately reached, although a drop or two in excess does no harm. This oxidizes the sodium ferrocyanide completely to sodium ferricyanide. Add to the oxidized solution $\frac{1}{10}$ normal copper sulphate from a burette, until a drop of the solution no longer gives a blue color with ferrous sulphate, but shows a red color. This indicates that no more sodium ferricyanide is present in the solution, and that the ferrous sulphate is reducing the yellowish copper ferricyanide to the reddish copper ferrocyanide. The first decided red color must be taken as the end point, even if it disappears after a time.

The copper-sulphate solution is made by dissolving 12.457 grams of crystallized copper sulphate in 1,000 cubic centimeters of water and standardizing it against pure non-effloresced potassium ferrocyanide.

10. *Silica, Ferric Oxide, and Alumina*.—Acidify 100 cubic centimeters of the lye with hydrochloric acid, heat to boiling, add about 1 gram of ammonium chloride, and precipitate with ammonia. Heat until the ammonia odor is very faint, filter, ignite, and weigh as usual.

25. *Carbonated Lye*.—The determinations are made as above, but in addition the sodium bicarbonate is determined.

Sodium Bicarbonate.—The method given in Art. 13 cannot be satisfactorily used here, for the sulphide that may be present will interfere with the test. The following method, however, gives good results when carefully carried out. A standard solution of caustic soda free from carbon dioxide is required and is best prepared by dissolving 50 grams of the best caustic soda in 1 liter of water and adding barium chloride to precipitate all the carbon dioxide. The solution is then standardized by acid as usual, made to normal, and preserved as under Art. 13. For the analysis, take 50 cubic centimeters of the carbonated lye and add 30 cubic centimeters of the caustic-soda solution, then an excess of a 10-per-cent. barium-chloride solution, and finally titrate with normal hydrochloric acid, using phenol-phthalein solution as indicator. The difference between the amount of caustic-soda solution taken and the normal acid required gives the number of cubic centimeters of normal caustic soda required for the bicarbonate present, and each cubic centimeter equals .084 gram of sodium bicarbonate.

For example, if 25 cubic centimeters of normal acid is required to titrate back, then $30 - 25 = 5$ cubic centimeters of caustic soda required for the bicarbonate present. Therefore, $.084 \times 5 = .42$, and $.42 \times 20 = 8.4$ grams of sodium bicarbonate per liter of lye.

26. Red Liquors.—The red liquor may be analyzed the same as the crude lye, except that in the case of crude lye all the oxidizable sulphur compounds are assumed to be sulphides. In the case of a red liquor, however, through oxidation and other changes the sulphite and thiosulphate become prominent and must be determined, especially when the red liquor is used for the manufacture of caustic soda.

1. *Sodium Sulphide, Sulphite, Thiosulphate, and Sulphate.*

(a) Determine the total alkalinity by titrating 25 cubic centimeters of the liquor with normal acid, using methyl orange as indicator. This gives sodium carbonate, sodium hydrate, sodium sulphide, and one-half of the sodium sulphite (Na_2SO_3 is alkaline to methyl orange, while $HNaSO_3$ is neutral).

(b) Acidify 25 cubic centimeters of the liquor with dilute acetic acid and titrate with $\frac{1}{10}$ normal iodine solution. This gives sodium sulphide, sodium sulphite, and sodium thiosulphate.

(c) Take 50 cubic centimeters of the liquor and precipitate it with an alkaline-zinc solution, make to 200 cubic centimeters, and take 100 cubic centimeters. Acidify this with dilute acetic acid and titrate with $\frac{1}{10}$ normal iodine solution. This gives sodium sulphite and sodium thiosulphate.

(d) Take 100 cubic centimeters of the liquor and add an excess of a 10-per-cent. barium-chloride solution to precipitate the sulphite, make up to 200 cubic centimeters, cork tight, and allow to settle clear (or filter); then take 50-cubic-centimeter portions of the clear liquid for titration.

(1) Titrate a 50-cubic-centimeter portion with normal hydrochloric acid, using methyl orange as indicator. This gives sodium hydrate and sodium sulphide. (2) Acidify a second 50-cubic-centimeter portion with dilute acetic acid and titrate with $\frac{1}{10}$ normal iodine solution. This gives sodium sulphide and sodium thiosulphate.

2. *The Calculation.*— $b - d(2) = A$ cubic centimeters $\frac{1}{10}$ normal iodine solution corresponding to sodium sulphite.

$b - c = B$ cubic centimeters $\frac{1}{10}$ normal iodine solution corresponding to sodium sulphide.

$d(2) - B = C$ cubic centimeters $\frac{1}{10}$ normal iodine solution corresponding to sodium thiosulphate.

$d(1) - \frac{1}{10} B = D$ cubic centimeters normal acid solution corresponding to sodium hydrate.

$1 - [d(1) + \frac{1}{20} A] = E$ cubic centimeters normal acid solution corresponding to sodium carbonate.

Each cubic centimeter of $\frac{1}{10}$ normal iodine solution equals .0039 gram of Na_2S , .0063 gram of Na_2SO_3 , or .0158 gram of $Na_2S_2O_3$.

Each cubic centimeter of normal acid equals .04 gram of $NaOH$, or .053 gram of Na_2CO_3 .

27. Tank Waste.—Samples are collected in wide-mouth glass-stoppered bottles and kept closed until analyzed. The

determinations are made on the moist substance, as any attempt to dry it inevitably leads to oxidation, and so to a change of composition.

1. *Alkaline Sodium Compounds.*—Stir 20 grams of tank waste thoroughly together with about 175 cubic centimeters of warm water, let stand 1 hour to thoroughly settle, and pour off the clear liquid. Pass carbon dioxide for 5 minutes, and boil to about one-half of the original volume, to decompose calcium bicarbonate and precipitate calcium carbonate. Filter and titrate the filtrate with normal acid, using methyl orange as indicator. Each cubic centimeter of normal acid equals .031 gram of Na_2O .

2. *Total Sodium Compounds.*—Heat 17.7 grams of the waste in a porcelain dish with sulphuric acid of 50° Baumé until the waste is completely decomposed, heat to drive off all the free acid, add hot water, and bring into a 250-cubic-centimeter measuring flask. Add milk of lime (made by slaking lime, shaking up with water, pouring off one portion to remove alkalies and then shaking up with water and filtering) to remove any free acid and magnesia, fill to the mark, let settle, and pipette off 50 cubic centimeters. To this 50 cubic centimeters add 10 cubic centimeters of a saturated barium-hydrate solution and filter through a dry filter. Take 50 cubic centimeters of the filtrate and precipitate all the barium by carbon dioxide and boiling. Filter and titrate the filtrate with normal hydrochloric acid, using methyl orange as indicator. When the above amount of substance is taken and allowance is made for the precipitates in the volumes, each cubic centimeter of normal acid used equals 1 per cent. of Na_2O .

FINISHED PRODUCTS

28. *Soda Ash.*—The determination of silica, sodium sulphate, sodium chloride, ferric oxide and alumina, calcium carbonate, and magnesium carbonate is carried out as under Art. 17. In addition to these substances, it is necessary to

determine in Le Blanc soda, total alkali, sodium carbonate, caustic soda, sodium sulphide, and sodium sulphite.

1. *Total Alkali*.—Dissolve 3.1 grams of the soda ash in about 150 cubic centimeters of distilled water and titrate with normal sulphuric acid, using methyl orange as indicator. Each cubic centimeter of the acid used equals 1 per cent. of Na_2O .

2. *Sodium Carbonate*.—Calculate from determinations 3 and 4 (below) the equivalent percentages of Na_2O and deduct the sum of these results from the percentage of Na_2O found in 1. The remainder is the alkali equivalent of the sodium carbonate, and this remainder multiplied by 1.71 gives the percentage of sodium carbonate in the soda ash. For example, if 58 cubic centimeters of normal acid is used in 1, 10 cubic centimeters of $\frac{1}{10}$ normal acid in 3, and 5 cubic centimeters of silver nitrate in 4; according to 1, we have 58 per cent. of Na_2O , according to 3, .31 per cent. of Na_2O as $NaOH$, and according to 4, .39 per cent. of Na_2O as Na_2S ; or $.31 + .39 = .7$ per cent. of Na_2O in the substance in other forms than sodium carbonate and $58 - .7 = 57.3$ per cent. of Na_2O as sodium carbonate. Then $57.3 \times 1.71 = 97.98$ per cent. of sodium carbonate in the soda ash.

3. *Caustic Soda*.—Dissolve 10 grams of the soda ash in about 75 cubic centimeters of water, add an excess of a 10-per-cent. barium-chloride solution, and titrate with $\frac{1}{10}$ normal hydrochloric acid, using phenol phthalein as indicator. Each cubic centimeter of acid used equals .04 per cent. of $NaOH$ and is equivalent to .031 per cent. of Na_2O .

4. *Sodium Sulphide*.—Dissolve 5 grams of the soda ash in about 100 cubic centimeters of water, heat nearly to boiling, and make strongly alkaline with ammonia. Titrate with an ammoniacal silver-nitrate solution until no more silver sulphide forms. Near the end it is advisable to filter off a little and test to make sure of the end point.

To make the standard silver solution, dissolve 13.845 grams pure silver in pure nitric acid, add 250 cubic centimeters of strong ammonia water, and dilute to 1 liter. Each cubic

centimeter of the silver solution equals .1 per cent. of sodium sulphide, and is equivalent to .0795 per cent. of Na_2O .

5. *Sodium Sulphite*.—Dissolve 5 grams of the soda ash in about 50 cubic centimeters of water, acidify with acetic acid, and titrate with $\frac{1}{10}$ normal iodine solution. Each cubic centimeter of iodine solution equals .126 per cent. of sodium sulphite.

29. **Crystal Soda**.—This substance is analyzed in the same manner as the above, except that on account of the large amount of water of crystallization, about double the amount must be taken for analysis.

CHANCE-CLAUS SULPHUR RECOVERY

30. **Available Sulphur in Tank Waste**.—In this determination the sulphide sulphur is set free by hydrochloric acid, collected in sodium-hydrate solution, and after acidifying, titrated with iodine solution. The details of the process are as follows: Weigh out in a 500-cubic-centimeter flask 2 grams of the tank waste, insert a two-holed rubber stopper through one hole of which is passed a funnel tube with a stop-cock, and through the other a tube bent to connect by means of a tight rubber tube, a suitable absorption apparatus. The apparatus described for the determination of sulphur in iron by evolution, in *Quantitative Analysis*, is suitable for this purpose. Two of the absorption tubes should be partially filled with sodium-hydrate solution and connected to the evolution flask. Slowly run hydrochloric acid (1 part of acid to 1 part of water) through the funnel tube on to the waste until the decomposition is completed. Boil the flask, to drive out all the hydrogen sulphide, and when the first absorption tube has become warm on account of the steam condensed in it, open the stop-cock of the funnel tube and allow the apparatus to cool. Empty the absorption tubes into a 500-cubic-centimeter measuring flask, fill to the mark with well-boiled water, and take 50 cubic centimeters for titration. Dilute this to

200 cubic centimeters with well-boiled water, acidify with acetic acid, and titrate with $\frac{1}{10}$ normal iodine solution. Each cubic centimeter of the iodine solution equals .0017 gram H_2S or .0016 gram S.

31. Lime-Kiln Gases.—Determine carbon dioxide, oxygen, and carbon monoxide as under Art. 8.

32. Gas From the Gasometer.—Determine hydrogen sulphide and carbon dioxide together by absorbing them in caustic-potash solution in the same manner as carbon dioxide is determined in Art. 8.

Determine hydrogen sulphide alone by fitting a flask of exactly known content (about 500 cubic centimeters) with a two-holed rubber stopper, through one hole of which passes a funnel tube with a glass stop-cock; the stem of the funnel tube should end just below the stopper. Through the other hole in the stopper passes a tube, which leads to the bottom of the flask and is fitted with a stop-cock. For making the determination, allow gas from the gasometer to pass through the apparatus until the air is completely displaced, close both stop-cocks, disconnect from the gasometer, and empty the gas from the tubes outside of the stop-cocks. Run in through the funnel tube about 25 cubic centimeters of a normal sodium-hydrate solution and shake thoroughly until all the gas is absorbed. Wash out into a 250-cubic-centimeter flask with air-free water and make to the mark on the flask. Take 50 cubic centimeters, dilute to about 250 cubic centimeters with air-free water, acidify with acetic acid, and titrate with standard iodine solution. The standard iodine solution should contain 11.43 grams of iodine per liter, when each cubic centimeter equals 1 cubic centimeter of hydrogen-sulphide gas at 0° C. and 760 millimeters of mercury pressure.

To reduce the gas employed to normal conditions use the formula given for this purpose in *Quantitative Analysis*.

If necessary to calibrate the flask, it can be done with sufficient accuracy by weighing it empty, then filling with water to the stop-cocks, and weighing again. The difference

between the two weights gives the weight of water in the flask, and, therefore, the volume in cubic centimeters. If greater accuracy is desired, the temperature of the water may be taken and the expansion of the water above 4° C. allowed for. Furthermore, the volume of air in the flask at its first weighing is approximately given by the weight of water; the weight of the air can be deducted from the weight of the flask plus air, thus giving the weight of the empty flask. For example, the flask plus air weighs 300 grams, the flask plus water at 18° C. weighs 795 grams; then $795 - 300 = 495$ grams of water at 18° C., which equals, approximately, 495 cubic centimeters as the capacity of the flask.

Correcting, 1 liter of air under standard conditions weighs 1.293 grams; and if the barometer stands at 750 millimeters of mercury pressure, the weight of 495 cubic centimeters of air can be calculated (see *Quantitative Analysis*). For

$$v = \frac{750 \times 495 \times 273}{760 \times 291} = 458 \text{ cubic centimeters at standard}$$

conditions = .458 liter. Therefore, $1.293 \times .458 = .6$ gram, the weight of air in the flask. The real weight of the flask is, therefore, less by this amount than the apparent weight and the weight of water becomes 495.6 grams. But 1 gram of water at 18° C. equals 1.001373 cubic centimeters, and therefore the corrected volume of the flask is 496.3 cubic centimeters.

33. Waste Gas From Claus Kiln.—The important substances to determine in this gas are sulphur dioxide and hydrogen sulphide. These are best determined by conducting 5 liters of the gas through a suitable absorption apparatus containing caustic-soda solution. The gases are absorbed, giving sodium sulphide and sodium sulphite. The caustic solution is then made to 250 cubic centimeters with air-free water and 50 cubic centimeters taken, acidified with acetic acid, and titrated with $\frac{1}{10}$ normal iodine. This gives both the hydrogen sulphide and sulphur dioxide. 100 cubic centimeters of the original solution is then taken.

the sulphide precipitated with an alkaline-zinc solution, one-half filtered off, acidified with acetic acid, and titrated with $\frac{1}{10}$ normal iodine solution; this gives the sulphur dioxide. 1 cubic centimeter of $\frac{1}{10}$ normal iodine solution equals .0017 gram of H_2S or .0032 gram of SO_2 , and equals 1.12 cubic centimeters of either gas at 0° C. and 760 millimeters of mercury pressure.

SODIUM BICARBONATE

34. The crude materials for sodium bicarbonate manufacture are the soda crystals from Le Blanc soda or the ammonia-soda ash, and lime-kiln gas. For the analysis of these substances, see Arts. **8**, **17**, and **29**.

FINISHED PRODUCT

35. Sodium Bicarbonate.—Analyze the same as soda ash, Art. **17**. The daily tests consist in the determination of total alkali, sodium carbonate, sodium bicarbonate, and sodium chloride.

CAUSTIC SODA

CRUDE MATERIALS

36. The crude materials for the manufacture of caustic soda differ, depending on whether the substance is made at a Le Blanc or at an ammonia-soda works. The methods for all of them, however, will be described, and the student can select those that apply to the work that he is doing.

1. *Red Liquor.*—Analyze as under Art. **26**.
2. *Soda Ash.*—Analyze as under Art. **17** or **28**.
3. *Milk of Lime.*—Analyze as under Art. **15**.

INTERMEDIATE PRODUCTS

37. While some of the following may be very properly considered as finished products, or otherwise classified, for the sake of simplicity they are given under this head.

38. Caustic Liquor.—The following determinations are made:

1. *Specific Gravity.*—The specific gravity is taken of the liquor at different stages of the evaporation, and although other substances affect the results, a fair idea of the run of the liquor can be obtained by this determination alone. Table III gives the percentage of caustic soda corresponding to the different specific gravities at 15° C.

TABLE III

Specific Gravity	Grams of NaOH Per Liter	Specific Gravity	Grams of NaOH Per Liter	Specific Gravity	Grams of NaOH Per Liter
1.007	6	1.142	144	1.320	381
1.014	12	1.152	156	1.332	399
1.022	21	1.162	167	1.345	420
1.029	28	1.171	177	1.357	441
1.036	35	1.180	188	1.370	462
1.045	42	1.190	200	1.383	483
1.052	49	1.200	212	1.397	506
1.060	56	1.210	225	1.410	528
1.067	63	1.220	239	1.424	553
1.075	70	1.231	253	1.438	575
1.083	79	1.241	266	1.453	602
1.091	87	1.252	283	1.468	629
1.100	74	1.263	299	1.483	658
1.108	104	1.274	316	1.498	691
1.116	112	1.285	332	1.514	721
1.125	123	1.297	348	1.530	750
1.134	134	1.308	364		

2. *Total Alkali and Sodium Carbonate.*—These two values are determined according to Art. **23**.

3. *Salt.*—In caustic from ammonia soda, it is frequently necessary to determine the amount of salt. Proceed according to Volhard's method, described in *Quantitative Analysis*.

4. It is only necessary to determine *sulphur compounds* when the caustic is made from red liquor or crude Le Blanc soda. Sodium sulphate is sometimes determined in liquor from ammonia soda. Make the determinations according to Art. **26**.

39. Fished Salts.—For analysis dissolve 25 grams of the salts in 500 cubic centimeters of water.

1. *Total Alkali.*—Titrate 25 cubic centimeters, as usual, with normal acid, using methyl orange as indicator.

2. *Salt.*—Titrate 25 cubic centimeters with silver nitrate by Volhard's method, described in *Quantitative Analysis*.

3. *Sodium Sulphate.*—Determine in 25 cubic centimeters, by acidifying with hydrochloric acid and precipitating hot with barium chloride, as usual.

4. *Oxidizable Sulphur Compounds.*—Treat 25 cubic centimeters of the solution with bromine water until it is colored, acidify with hydrochloric acid, boil off the excess of bromine, and precipitate as sulphate with barium chloride as usual. The difference between the amount of sulphate found here and that found above gives the oxidizable sulphur. This determination is, of course, unnecessary when the caustic is made from ammonia soda.

40. Caustic Bottoms.—This sample sometimes comes to the laboratory in fairly large lumps in a stoppered bottle that has the stopper covered with sealing wax. This wax should not be broken until the sample is wanted for analysis. Then several pieces are taken, wrapped quickly in several thicknesses of heavy brown paper, and crushed on an anvil by means of a hammer; 20 grams are then weighed off and dissolved in water. It is necessary to work quickly

until the caustic is weighed, to prevent its absorbing water from the air.

1. *Insoluble*.—When the above 20 grams are dissolved, filter, and wash thoroughly. Collect the filtrate and washings in a 500-cubic-centimeter measuring flask, make to the mark, and save. The filter and contents are ignited and weighed.

2. *Total Alkali*.—Take 50 cubic centimeters of the above filtrate, add a little lacmoid for an indicator, and add normal acid to more than neutralize. Heat to boiling, to expel the carbon dioxide, and titrate back with normal alkali. The difference between the acid and alkali used gives the acid required for neutralizing the total alkali. Each cubic centimeter of normal acid equals .031 gram of Na_2O .

3. *Sodium carbonate* is determined according to Art. 23.

4. *Salt* is determined according to Art. 23.

41. Caustic Mud.—The determinations are as follows:

1. *Total Alkali*.—Extract 25 grams of the sample by shaking it with several small portions of hot water, finally filter, wash, and unite the filtrates and washings, pass carbon dioxide for 10 minutes, boil to decompose bicarbonates, refilter, if necessary, and titrate with normal acid, using methyl orange as indicator. Each cubic centimeter equals .031 gram of Na_2O .

2. *Caustic Lime*.—Shake about 25 grams of the waste with a little water and titrate with normal acid and phenol phthalein. The sodium above was present as hydrate and carbonate, but a fair average will be reached if we deduct one-half of the number of cubic centimeters of acid required for total alkali, from the amount taken above, and call the remainder of the acid used by the waste, caustic lime. Each cubic centimeter of acid equals .037 gram of $Ca(OH)_2$.

3. *Calcium Carbonate*.—Titrate 1 gram of the sample with normal hydrochloric acid, using methyl orange as indicator, and deduct the acid required for caustic lime. Each cubic centimeter of acid equals .05 gram of $CaCO_3$.

FINISHED PRODUCTS

42. Caustic Soda.—The method for preparing the sample for analysis given under Art. **40** can be used to advantage here. For analysis weigh out 50 grams, dissolve in water, and make to 1,000 cubic centimeters.

1. *Total Alkali.*—Titrate as usual, using normal hydrochloric acid and methyl orange.
2. *Caustic soda* is determined as under Art. **23**.
3. *Sodium carbonate* is determined as under Art. **23**.
4. *Salt* is determined as under Art. **23**.
5. *Sodium sulphate* is determined as under Art. **39**.
6. *Other constituents* are determined as under Art. **17**.

HYDROCHLORIC ACID

RAW MATERIALS AND INTERMEDIATE PRODUCTS

43. Hydrochloric acid is almost without exception obtained from salt by the action of sulphuric acid. For its crude materials and intermediate products, see under the heading "Salt Cake."

The absorption of the gas in the bombonnes and towers is watched by means of specific-gravity tests. These are best made by arranging a cylinder and hydrometer in such a way that a portion of the acid is being continuously collected in the cylinder in which the hydrometer floats. By this means it is possible to see the specific gravity at a glance, and the delay and trouble of collecting the sample is avoided.

Table IV gives the specific gravity and composition of solutions of hydrochloric acid at 15° C.

44. Waste Gases.—The gas that escapes from the absorption towers must not contain much hydrochloric acid, for it is injurious to vegetation. The sample is taken by

inserting a glass tube to the center of the chimney through which the gas passes to the outside air. To the outer end of the tube is attached a double-acting rubber suction bulb, and this, in turn, is connected to an absorption apparatus

TABLE IV

Specific Gravity	Per Cent. <i>HCl</i>	Grams <i>HCl</i> per Liter	Specific Gravity	Per Cent. <i>HCl</i>	Grams <i>HCl</i> per Liter
1.000	.16	1.6	1.1150	22.86	255
1.005	1.15	12.0	1.1200	23.82	267
1.010	2.14	22.0	1.1250	24.78	278
1.015	3.12	32.0	1.1300	25.75	291
1.020	4.13	42.0	1.1350	26.70	303
1.025	5.15	53.0	1.1400	27.66	315
1.030	6.15	64.0	1.1425	28.14	322
1.035	7.15	74.0	1.1450	28.81	328
1.040	8.16	85.0	1.1500	29.57	340
1.045	9.16	96.0	1.1520	29.95	345
1.050	10.17	107.0	1.1550	30.55	353
1.055	11.18	118.0	1.1600	31.52	366
1.060	12.19	129.0	1.1630	32.10	373
1.065	13.19	141.0	1.1650	32.49	379
1.070	14.17	152.0	1.1700	33.46	392
1.075	15.16	163.0	1.1710	33.65	394
1.080	16.15	174.0	1.1750	34.42	404
1.085	17.13	186.0	1.1800	35.39	418
1.090	18.11	197.0	1.1850	36.31	430
1.095	19.06	209.0	1.1900	37.23	443
1.100	20.01	220.0	1.1950	38.16	456
1.105	20.97	232.0	1.2000	39.11	469
1.110	21.92	243.0			

similar to that mentioned in Art. 30. The absorption apparatus is fitted with large test tubes, or small flasks, so that two pieces will hold 150 or 200 cubic centimeters of water. It is then filled with water and is connected in

position. The bulb is then compressed a sufficient number of times to force the desired amount of chimney gas through the absorption apparatus. By careful work the amount of gas used can be quite accurately estimated by this method; if greater accuracy is wished, the gas after passing through the absorbing apparatus may be run into a gasometer and measured. The liquid from the absorption apparatus is washed into a flask and titrated by Volhard's method, which is described in *Quantitative Analysis*.



FIG. 3

Another very simple and very effective form of absorption apparatus that can be used has been recommended by the English alkali inspectors; it is shown in Fig. 3. The gas enters at *a*, passes out through the holes at the lower end of the tube, and passes up through a number of thin ends cut from a small rubber tube, which breaks the gas into fine bubbles, then out through the holes, in the direction of the arrows, into the bottle, and finally escapes through the tube *b*. This tube is filled below with pieces of rubber tube and above with glass wool.

By moistening the contents of *b* with water and adding a little indicator, as methyl orange, any failure on the part of the apparatus to absorb the acid is shown in *b* by the change in the indicator.

FINISHED PRODUCT

45. Hydrochloric Acid.—The analysis of hydrochloric acid varies according to the purpose for which the acid is to be used. For many purposes a simple determination of the specific gravity is sufficient, while for other purposes a more

extended examination is necessary. In the following, the methods of analysis are given for all cases, except the so-called chemically pure acid, the examination of which is practically never required in the ordinary chemical works.

1. *Sulphuric Acid*.—Take 50 cubic centimeters of the acid to be tested, almost neutralize with pure sodium carbonate, heat to boiling, and precipitate with barium chloride, as usual. Each gram of barium sulphate found corresponds to .34335 gram of SO_3 .

Another method, which gives quite accurate results and, on account of its rapidity, is very suitable where several determinations must be made each day, is as follows: Prepare a glass tube 6 millimeters broad and 250 millimeters long closed at the lower end, while the upper end expands into a tube 15 millimeters broad. Provide a rubber stopper for the broad tube. By mixing acids of known composition make a series of acids containing from .2 or .6 up to 3 per cent. of sulphuric acid. Take 10 cubic centimeters of the first of these acids, heat to boiling, pour into the above tube, nearly neutralize with ammonia, and precipitate with 5 cubic centimeters of a boiling hot, saturated, barium-chloride solution. Insert the rubber stopper, place in a centrifugal machine, and whirl for 5 minutes. Mark the height of the precipitate, empty, and repeat with the next stronger sample. In this way graduate the tube and use it for the determination in the same way, using 10 cubic centimeters of the sample, instead of the known solution, and reading off the percentage of sulphuric acid on the tube.

2. *Sulphurous Acid*.—Add bromine to 50 cubic centimeters of the acid to color it and boil until color disappears. Proceed as for sulphuric acid. For rapid work, use 10 cubic centimeters of the sample and use the rapid method given above. In either case, deduct the barium sulphate found above from the total and each gram of barium sulphate in excess corresponds to .27468 gram of SO_2 .

3. *Arsenic*.—The detection and determination of arsenic in hydrochloric acid that is to be used in the preparation of

foodstuffs is very important. A very large number of methods for both its qualitative and quantitative determination have been proposed and are in use. The following, however, seem to be the most convenient and exact.

(a) *Qualitative Tests.*—Take 10 cubic centimeters of the sample in a test tube, dilute with 10 cubic centimeters of distilled water, carefully pour on the top of the acid 5 cubic centimeters of a freshly prepared hydrogen-sulphide solution, and allow to stand for 1 hour. Prepare a second tube in exactly the same manner and allow to stand for 1 hour in a water bath at from 70° to 80° C. If no precipitate, or yellow ring, appears between the two layers in either case, arsenic is absent. By this method the presence of $\frac{1}{10}$ milligram of arsenic in the 10 cubic centimeters of acid can be detected.

For the most accurate detection of arsenic take 5 liters of the acid, add about $\frac{1}{4}$ gram of potassium chlorate, to prevent the arsenic volatilizing as $AsCl_3$ during evaporation, and dilute with water until the specific gravity does not exceed 1.1. Evaporate to dryness in a well-enameled porcelain evaporator, take up the residue in a little water, and test the solution in a Marsh apparatus, which is described in *Qualitative Analysis*.

(b) *Quantitative Determination.*—When very small amounts of arsenic are to be determined, take 5 liters of the acid, and concentrate to small bulk as above, using potassium chlorate to prevent loss of arsenic by volatilization, then proceed as follows: If fairly large amounts are known to be present or are shown by the qualitative test, take 50 cubic centimeters, partly neutralize with sodium carbonate, dilute to 150 cubic centimeters, and precipitate as sulphide, following the directions given in *Quantitative Analysis*. Remember here that the arsenic may be present as arsenic acid and that, under those circumstances, heat and considerable time (from 12 to 20 hours) are necessary to completely precipitate all the arsenic.

4. *Selenium.*—Test with stannous chloride as described in *Qualitative Analysis*.

§ 31 ALKALIES AND HYDROCHLORIC ACID 41

5. *Hydrochloric Acid.*—Take 10 cubic centimeters of the sample in an accurate pipette, dilute to 250 cubic centimeters, and take 25 cubic centimeters for titration. Titrate with normal caustic-soda solution, using methyl orange as indicator. Deduct the amount of caustic corresponding to the SO_2 already found from the total and the rest corresponds to HCl . Each cubic centimeter of alkali equals .0365 gram of HCl .

For example, if 10 cubic centimeters of normal alkali is required for 1 cubic centimeter of the sample and .004 gram of SO_2 has been found in the previous determination, then .1 cubic centimeter of the alkali was used by the sulphuric acid, and the amount used by the hydrochloric acid is 9.9 cubic centimeters, which equals .36135 gram of HCl in 1 cubic centimeter of the sample, or 361.35 grams per liter.

It is customary to report results of this kind in grams per liter; but if the percentage is wanted, determine the specific gravity and divide the grams per liter by 10 times the specific gravity, the result will be the percentage of HCl .

When the amount of hydrochloric acid alone is to be determined in a sample, it is simpler to titrate 10 cubic centimeters of the diluted sample with $\frac{1}{10}$ normal silver nitrate, using Volhard's method, which is described in *Quantitative Analysis*. Each cubic centimeter of the silver-nitrate solution equals .00365 gram of HCl .

CHLORINE, BLEACHING COMPOUNDS, CHLORATES

CRUDE MATERIALS

46. Manganese Ore.—The ordinary determinations are as follows:

1. *Moisture.*—Spread 2 grams of the finely powdered ore thinly on a watch glass and dry at 100° or 110° C. until the weight remains constant.

2. *Available Oxygen*.—For this determination are needed a $\frac{1}{2}$ normal potassium-permanganate solution and a ferrous-

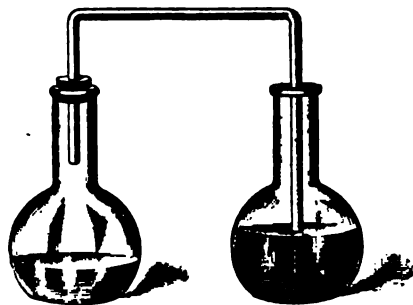

FIG. 4

sulphate solution made by dissolving 100 grams of ferrous sulphate and 100 grams of sulphuric acid in 1 liter of water. For the determination, weigh out 1.0875 grams of the dried ore (preferably that used for the moisture determination) into a 200-cubic-centi-

meter flask provided with a tube leading to the bottom of a second flask containing sodium-bicarbonate solution. The arrangement of the flasks is shown in Fig. 4. Measure exactly 75 cubic centimeters of the ferrous sulphate into the flask with the manganese ore, insert the stopper with the tube leading into the sodium-bicarbonate solution, and heat until a dark-colored residue is no more apparent. Allow the solution to cool, wash into a 500-cubic-centimeter beaker, dilute to about 200 cubic centimeters, and titrate with $\frac{1}{2}$ normal potassium-permanganate solution until the color stays permanent for about $\frac{1}{2}$ minute.

The ferrous-sulphate solution must be standardized each day by measuring out 75 cubic centimeters, using the same pipette as above, and titrating it with the $\frac{1}{2}$ normal potassium-permanganate solution.

The difference between the amount of potassium-permanganate solution used to titrate the ferrous-sulphate solution and that used with the ore gives the available oxygen, or rather the manganese present in the ore as MnO_2 . If the above amount of ore is weighed out, each cubic centimeter of $\frac{1}{2}$ normal potassium-permanganate solution corresponds to 2 per cent. of MnO_2 .

Another very exact and rapid method that can be used direct, or as a check on the above method, is given in *Quantitative Analysis*, under the description of the nitrometer.

3. *Carbon Dioxide*.—Determine according to the absorption method given in *Quantitative Analysis*.

4. *Acid Necessary to Decompose Ore*.—Bring 1 gram of the ore into a flask containing 10 cubic centimeters of the hydrochloric acid being used in the chlorine manufacture and whose titration strength has been previously determined. Insert a stopper, with a return condenser, in the flask and heat until the ore is dissolved. Allow to cool and titrate with normal caustic-soda solution until the brown flakes of iron hydrate no longer dissolve by shaking. The difference between the caustic soda used here and that required for the titration of 10 cubic centimeters of the original acid gives the acid used in decomposing the ore.

47. Limestone.—Analyze according to Art. 3.

48. Quicklime.—Analyze according to Art. 4.

49. Slaked Lime.—Water, carbon dioxide, and calcium hydrate are usually determined.

1. *Water*. — Weigh out from a well-closed weighing tube 1 gram of the sample into a weighed platinum crucible and heat, at first gradually and then to the strongest temperature of the blast lamp; cool; and weigh. The loss of weight equals carbon dioxide and water.

2. *Carbon Dioxide*.—Determine according to the absorption method given in *Quantitative Analysis* and deduct the result from the carbon dioxide and water previously determined.

3. *Milk of Lime*.—See Art. 15.

INTERMEDIATE PRODUCTS

50. Free Acid in Still Liquor.—Titrate 25 cubic centimeters of the still liquor with normal sodium-hydrate solution until the brown flakes of ferric hydrate no longer dissolve by thorough shaking. Each cubic centimeter of caustic-soda solution used equals .0365 gram of free hydrochloric acid.

51. Calcium Chloride in Clear Liquor.—Acidify 25 cubic centimeters of the clear liquor with acetic acid, add ammonium oxalate in excess, allow to stand 3 hours to insure complete precipitation of the calcium oxalate, and filter on an asbestos filter, using a Gooch crucible. Bring the crucible containing the precipitate of calcium oxalate into a 300-cubic-centimeter beaker, add 100 cubic centimeters of distilled water and 10 cubic centimeters of concentrated sulphuric acid. (Use care in adding the acid, that the contents of the beaker do not spatter out.) Now titrate the oxalic acid obtained from the above operations with $\frac{1}{10}$ normal potassium-permanganate solution. Each cubic centimeter of the $\frac{1}{10}$ normal potassium-permanganate solution is equal to .0028 gram of calcium oxide, or .00555 gram of calcium chloride.

52. Weldon Mud.—The following determinations are required:

1. *Manganese Dioxide.*—See Art. 46.

2. *Total Manganese.*—Weigh out 10 grams of the mud, acidify with concentrated hydrochloric acid, boil to drive off all the chlorine, and then neutralize the excess of acid with precipitated chalk. Acidify with acetic acid, add bromine, heat, and continue the addition until the solution retains the odor of bromine. Add alcohol slowly until the red color disappears and filter on a Gooch filter. Test the filtrate, to see if it turns brown, with the addition of a drop of bromine water; if so, precipitate the rest of the manganese and add it to the precipitate already obtained. All the manganese is now on the filter as manganese dioxide. Introduce filter and all into a flask and proceed to determine the manganese dioxide according to Art. 46.

3. *Total Base.*—This indicates the base present that neutralizes the hydrochloric acid without producing chlorine. Dilute 25 cubic centimeters of normal oxalic-acid solution to about 100 cubic centimeters, warm to 75° C., and add 10 grams of the mud. Shake until the precipitate is pure white, dilute to 202 cubic centimeters, filter through a

dry filter, take 100 cubic centimeters of the filtrate and titrate back with normal caustic-soda solution. (The extra 2 cubic centimeters is to allow for the precipitate.) If we call the caustic-soda solution used x , the oxalic acid used is $25 - 2x$. Of this, part is used to neutralize the base, and part to reduce the manganese dioxide to manganese monoxide and then neutralize that. We have just found the amount of manganese dioxide in 10 grams of the mud and can calculate its equivalent in oxalic acid from the equation



Calling this amount of oxalic acid expressed in cubic centimeters of normal solution y , then the amount of normal acid used by the base is $25 - (2x + y) = z$. Since the base consists of a mixture of lime, magnesia, manganese hydrate, and iron hydrate, it is customary to report the result here in cubic centimeters of oxalic acid used.

53. Gas From Sulphate Pan.—The hydrochloric-acid gas from the "pan" must be mixed with the proper amount of air as it goes to the "decomposer," and this mixture is controlled by analysis. The analysis is carried out by sucking the gas, by means of an aspirator, through a standard solution of caustic soda containing methyl orange. The instant the color changes, the flow of the gas is stopped and the volume of gas in the aspirator is determined by measuring the amount of



FIG. 5

water that has run out of the aspirator. A suitable piece of apparatus for this determination is shown in Fig. 5. The lower end of the tube leading into the absorption bottle is blown out and arranged with a number of small holes to

break up the gas into small bubbles and so assist the absorption.

By using the same amount of normal alkali each time, the amount of hydrochloric acid absorbed is constant; and by measuring the air carried through, the composition of the mixed gas can be easily calculated. As, for example, if we use 100 cubic centimeters of normal alkali that is equal to 3.65 grams hydrochloric acid, which is equal to 2.24 liters of hydrochloric-acid gas under 0° C., and 760 millimeters of mercury pressure. If the gas collected measures 3 liters after correcting for temperature and pressure, then the total gas used is 5.24 liters, of which 57.3 volume per cent. is air and the remainder hydrochloric acid.

54. Gas From Decomposer.— Arrange three absorption bottles, similar to that shown in Fig. 5, in a series as close to the decomposer as possible, and divide 250 cubic centimeters of caustic soda of 1.075 sp. gr. between the three bottles. The aspirator is so regulated that it continues during the working off of a pan charge. Five liters of the gas are sucked through the absorption bottles, then the contents of all three flasks are united and diluted to exactly 500 cubic centimeters.

(a) Pipette off 100 cubic centimeters of the above solution, add 25 cubic centimeters of standard ferrous-sulphate solution, and proceed as for available oxygen in Art. 46, titrating at the end with $\frac{1}{2}$ normal potassium-permanganate solution. Deducting the amount of potassium permanganate required here from the amount required for 25 cubic centimeters of the ferrous-sulphate solution gives the amount of the permanganate equivalent to the chlorine in 1 liter of the gas. The number of cubic centimeters of $\frac{1}{2}$ normal potassium permanganate times .01775 equals the number of grams of chlorine per liter of gas.

(b) Pipette off 25 cubic centimeters of the original solution and add somewhat of an excess of sodium-sulphite solution (approximately the amount of sodium sulphite needed can be estimated from the preceding determination).

Add sulphuric acid until the solution is acid, when it should smell strongly of sulphur dioxide, thus showing that more sulphur dioxide is present than is needed to reduce the sodium hypochlorite to sodium chloride. Heat to boiling, cool, and, if necessary, add potassium-permanganate solution until the color fades out very slowly. Titrate with $\frac{1}{10}$ normal silver-nitrate solution, using the Volhard method.

If the number of cubic centimeters of $\frac{1}{2}$ normal potassium-permanganate solution required for the chlorine under (*a*) is called *x*, and the number of cubic centimeters of $\frac{1}{10}$ normal silver-nitrate solution, *y*, $\frac{2x}{y}$ equals the percentage decomposition of the hydrochloric acid.

55. Bleaching-Powder Chambers.—Whenever it is necessary to open the chamber in which bleaching powder is being made, the gas in the chamber must be tested in some way, in order that too much chlorine will not be allowed to escape into the surrounding atmosphere. A very simple apparatus, and the one in most common use for this purpose, is shown in Fig. 6. The cylinder *d* contains 25 cubic centimeters of a solution made as follows: .495 gram of arsenic trioxide is dissolved in sodium-carbonate solution and neutralized by sulphuric acid; then 25 grams of potassium iodide, 5 grams of precipitated chalk, and from 8 to 10 drops of ammonium-hydrate solution are added, and the whole made up to 1 liter with distilled water. A little starch paste is added to each 25 cubic centimeters just before it is used. The cylinder *d* is fitted with a two-holed rubber stopper *c*; through one hole passes the tube *e*, which is drawn out at the lower end to a hole about the size of a knitting needle; through the other hole passes

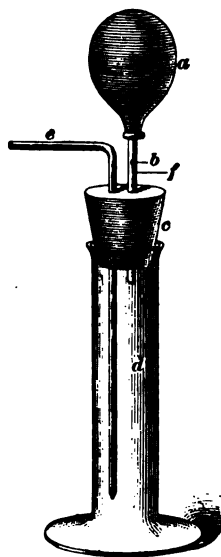

FIG. 6

a glass tube *f*, the lower end of which projects a short distance into the cylinder, while to the upper end is attached the rubber bulb *a* of about 100 cubic centimeters capacity.

The tube *f* is also provided with the small hole *b*. To test the gas in a bleach chamber, the tube *c* is inserted through an opening in the chamber about 2 feet above the floor. The bulb *a* is then compressed, *b* is closed by the finger, and *a* allowed to expand. By doing this the gas from the chamber is drawn through the test solution in *d*. By counting the number of bulbs full of the gas necessary to color the test solution by separated iodine, the chlorine in the gas can be calculated; for 25 cubic centimeters of the above solution is equivalent to 9.135 milligrams of chlorine. That is, if it takes 10 bulbs full to bring a color, then the gas contains 9.135 milligrams of chlorine per liter of the gas.

56. Bleach Liquors.—When liquid bleach is made direct from the base, or carbonate, and chlorine, the manufacture requires a careful attention to the course of the absorption.

1. *Available chlorine* is determined in 5 cubic centimeters of the liquid by Penot's method, which is described in *Quantitative Analysis*, under "Bleaching Powder."

2. *Chlorides.*—Take the solution from the determination of available chlorine and which now contains arsenates, nearly neutralize with nitric acid, but still leave a slight excess of alkali, and titrate with $\frac{1}{10}$ normal silver-nitrate solution. The formation of the red silver arsenate when the chlorine is all precipitated shows the end point.

3. *Chlorates.*—Bring 5 cubic centimeters of the bleach solution into a flask arranged as shown in Fig. 4; add 50 cubic centimeters of the solution of ferrous sulphate described in Art. 46, and the strength of which against $\frac{1}{2}$ normal potassium-permanganate solution is known, boil the mixed solution, and after allowing to cool, titrate back with potassium-permanganate solution. If the number of cubic centimeters of $\frac{1}{2}$ normal potassium-permanganate

solution used for 50 cubic centimeters of the original ferrous-sulphate solution is called a , and the number of cubic centimeters of $\frac{1}{10}$ normal potassium-permanganate solution used by 50 cubic centimeters of the ferrous-sulphate solution after oxidation with the bleach liquor b , then $a - b$ gives oxidizing equivalent of the bleach liquors in terms of $\frac{1}{10}$ normal potassium-permanganate solution. The oxidizing action is due to the available chlorine and the chlorates. The available chlorine has been determined, and 5 cubic centimeters of the $\frac{1}{10}$ normal arsenite solution is equivalent to 1 cubic centimeter of the $\frac{1}{10}$ normal potassium-permanganate solution. If the number of cubic centimeters of $\frac{1}{10}$ arsenite solution used for available chlorine is called c , then $(a - b) - \frac{c}{5}$

equals the number of cubic centimeters of $\frac{1}{10}$ normal potassium-permanganate solution equivalent to the chlorate in the solution. Each cubic centimeter of $\frac{1}{10}$ normal potassium-permanganate solution is equivalent to .01021 gram potassium chlorate, .00888 gram of sodium chlorate, or .00862 gram of calcium chlorate. This gives the amount of the chlorate in 5 cubic centimeters of the solution, which result multiplied by 200 gives the number of grams per liter.

4. *Caustic Alkali*.—Take 10 cubic centimeters of bleach liquor and dilute with 150 cubic centimeters of distilled water, add a few drops of a phenol-phthalein solution, and titrate with a normal acid solution until the red color disappears. Add a few more drops of the indicator, and if the color again disappears after about 5 seconds shaking, the result is taken as equivalent to the caustic alkali present.

5. *Carbonates*.—Take 10 cubic centimeters of the bleach liquor and add ammonia (in a well-covered beaker to avoid loss by the gas evolved) until the evolution of nitrogen ceases and the liquid smells of ammonia. Then heat until the ammonia odor disappears, dilute to 150 cubic centimeters, and titrate with normal acid, using methyl orange as indicator. The difference between this result and that for the caustic gives the carbonate in the solution.

57. Chlorates.—The methods of control here are practically the same as those described for bleach liquors under Art. 56. The usual determinations made are chlorates, chlorides, and sometimes available chlorine (chlorine and hypochlorites). The chlorate is reported as potassium chlorate, and for calculating the amount of potassium chloride necessary to convert the calcium chlorate into potassium chlorate, we can multiply the number of cubic centimeters of $\frac{1}{2}$ normal potassium permanganate used by 3.105. That is, in Art. 56 $\left[(a - b) - \frac{c}{5} \right] \times 3.105 =$ number of grams of potassium chloride required per liter of the chlorate liquor to convert the calcium chlorate into potassium chlorate.

FINISHED PRODUCTS

58. Bleaching Powder.—The only determination that it is necessary to make with bleaching powder is the determination of the available chlorine. A large number of methods have been proposed for this determination, but the only one of importance for this country is the Penot method, which is described in *Quantitative Analysis*. A somewhat similar method, using a hydrochloric-acid solution of arsenic trioxide, was introduced into France in 1835 by Gay-Lussac and is still largely used in that country. It is far inferior, however, to the Penot method.

59. Bleach Liquors.—Analyze as given under the methods for factory control, in Art. 56.

60. Potassium Chlorate.—Potassium chlorate as a finished product is so nearly chemically pure that seldom more than a qualitative analysis is necessary, or at most a quantitative determination of the chloride present.

1. *Potassium Chloride.*—Dissolve 50 grams of the sample in as little distilled water as possible, precipitate the chlorine with silver nitrate, shake to collect the precipitate together; filter on a Gooch filter, wash thoroughly, dry at 125° C., and

weigh. Each gram of silver chloride is equivalent to .5192 gram of potassium chloride, or $\frac{\text{weight of AgCl} \times .5192 \times 100}{50}$ = percentage of *KCl* in substance.

2. *Qualitative Tests.*—The solution should be water white, free from sediment, and should not color or precipitate by the addition of ammonium sulphide or carbonate.

61. Electrolysis.—The analyses required in the control of electrolytic processes for the preparation of alkali, chlorine, and potassium chlorate are so similar to those already treated that no more than a reference to them is required.

1. *Brine.*—Analyze according to Art. 1.

2. *Caustic liquor* may contain sodium chloride, sodium hypochlorite (possibly sodium chlorate), sodium hydrate, and more or less sodium carbonate. Analyze according to Art. 56.

3. *Bleaching Powder Chambers.*—See Art. 55.

4. *Bleach Liquor.*—See Art. 56.

5. *Potassium-chlorate liquor* may contain potassium chloride, potassium hypochlorite, potassium chlorate, and hypochlorous acid. Analyze according to Art. 56.



...

MANUFACTURE OF IRON

INTRODUCTORY

1. Iron is very widely distributed in nature and its compounds are abundant. Probably no portion of the earth's crust is free from it, yet it occurs native only in very small quantities, and the iron thus found is probably of meteoric origin and is always alloyed to a greater or less extent with other metals, as nickel, cobalt, copper, etc. The strong affinity of iron for the non-metals explains its infrequent occurrence in the native condition; and the dissimilarity between the metal and its ores may explain why iron was among the later useful metals to be discovered, if, as is generally believed, such is the case. It may be mentioned, however, that some writers think iron was known and used at a much earlier period in the world's history than is generally believed, but that the tendency of this metal to corrode has destroyed all traces of its use in ancient times, while instruments of brass and bronze remain.

Chemically pure iron is valuable only for experimental purposes and as a curiosity, as it has no use in the arts except, perhaps, in medicine. It may be obtained on a small scale in several ways, among which may be mentioned the reduction of pure ferric oxide by heating it in a current of hydrogen, and the electrical decomposition of a solution of pure ferrous sulphate or chloride.

While pure iron is devoid of value, when it contains small quantities of other elements, it is the most useful and widely

used of all the metals. In fact, it is almost impossible to overestimate its importance in the arts.

It is not known who first discovered iron, nor is much known of the early development of its manufacture; and it is not the object of the present subject to treat of the history of the process, but to deal with conditions as we find them today.

The manufacture of iron from its ores depends on chemical principles with which we are already familiar. As iron does not occur native, it is necessary to reduce its compounds, and this is done in such a manner that the resulting metal shall contain the elements necessary to give it the properties that have made it so valuable. The method almost universally employed at present is to charge in the ore, together with the fuel—which at present is nearly always either coke, coal, or charcoal—at the top of a tall furnace, and as the ore always contains extraneous matter, a flux is also added in the proper amount to form a fusible slag with these impurities. Hot air is blown into the furnace near the bottom, and coming in contact with the highly heated fuel in excess, forms carbon monoxide, which passes up through the descending charge of ore, fuel, and flux. At the temperature of the furnace, both the carbon of the fuel and the carbon monoxide thus formed act as reducing agents on the ore, removing the oxygen and leaving metallic iron, which, at the intense heat near the bottom of the furnace, melts and drops to the bottom, taking up some carbon from the fuel, and silicon, sulphur, phosphorus, and manganese from the ore, fuel, and flux. At the same time, the silica, alumina, lime, and magnesia of the ore, fuel, and flux unite, forming a fluid slag, which, being lighter than iron, floats on the molten metal in the bottom. The iron and slag thus formed are drawn out at proper intervals through openings provided for them in the bottom of the furnace.

When the ascending gas reaches the top of the furnace, it contains considerable carbon monoxide, which, as we already know, is very combustible. It passes through an opening near the top of the furnace and is led through the “down-comer” to a feedpipe. Part of it is conducted to the

so-called stoves and burned in them to heat them up. The stoves are then used to heat the blast of air blown in near the bottom of the furnace by means of blowing engines. The part of the gas not used in the stoves is burned under the boilers that produce steam to run the blowing engines.

Having given a brief outline of the process, we will now proceed to consider it more in detail.

IRON ORES

CLASSIFICATION OF IRON ORES

2. Definition of Ore.—In its generally accepted sense, an ore is a naturally occurring substance containing a metal in such quantity and condition that it may be profitably worked for that metal. The metal may be either in the native condition mixed with other substances or may be a compound of the metal. As iron does not occur native, its ores are compounds, and as only a few of these compounds can be profitably worked for iron, the ores of iron are few in number.

3. The oxides and carbonate of iron are about the only compounds of this metal that are ores according to our definition. There are several of these, if we include combinations of these oxides with other substances forming minerals that are sometimes used as ores. It should be remembered that no ore ever occurs pure, but always contains foreign matter in varying quantities. The impurities most frequently found in iron ores are silica, alumina, lime, magnesia, manganese, phosphorus, and sulphur.

All ores contain some of these substances, and nearly all contain all of them in varying proportions. Besides these substances, which are nearly always present, a number of others are found associated with certain ores. The following are the principal ores of iron:

4. Magnetite.—Magnetite is an anhydrous oxide having the formula Fe_3O_4 , and, consequently, if pure, would contain 72.42 per cent. of iron, thus making it the richest of the iron ores. It usually contains deleterious substances, however, especially titanium, and frequently a high percentage of sulphur, and is not easily reduced, so it is not usually considered as valuable as hematite, even though the percentage of iron in this ore is lower. Magnetite is not generally considered as a distinct oxide, but rather as a mixture of ferrous and ferric oxide Fe_2O_3, FeO . It is black, brittle, and magnetic, and gives a black streak when drawn across unglazed porcelain. It sometimes occurs in crystals and sometimes in a granular condition, like sand, but generally in the massive form.

5. Red Hematite.—This is an anhydrous oxide having the formula Fe_2O_3 . It occurs in earthy and compact forms, and a number of varieties are found, that is, crystalline, columnar, fibrous, and amorphous. Special names have been given to the various forms. Thus, the brilliant crystalline variety is known as specular iron ore; the scaly, foliated variety is known as micaceous iron ore, and the earthy varieties are often known as red ocher.

This ore varies in color from a deep red to a steel gray, but all varieties give a red streak when drawn across unglazed porcelain.

Theoretically, it contains 70 per cent. of iron, and on account of its abundance, its comparative freedom from injurious constituents, and the character of the iron it yields, it is the most important of the ores of iron.

6. Brown Hematite.—Brown hematite, or limonite, is hydrated ferric oxide, and is generally represented by the formula $2Fe_2O_3, 3H_2O$. Hence, it theoretically contains 59.89 per cent. of iron. It occurs in both compact and earthy varieties. Pipe, or stalactitic, ore and bog ore are brown hematite. Its color varies from brownish black to yellowish brown, but it always leaves a yellowish-brown streak on unglazed porcelain.

7. Ferrous Carbonate.—This ore has the formula $FeCO_3$, and thus, theoretically, contains 48.28 per cent. of iron. It occurs in several varieties, known as spathic ore, clay ironstone, and black band. Spathic ore, when quite pure, has a pearly luster and varies in color from yellow to brown. The crystallized variety is known as siderite. When exposed to the action of air and water, the veins of ore are decomposed to considerable depth and a layer of brown hematite is formed. This ore frequently contains considerable manganese, and in some places is used for the production of spiegeleisen, which may be considered as iron containing a high percentage (usually from 8 to 25 per cent.) of manganese. Clay ironstone is a variety of ferrous carbonate that occurs in detached nodules or in layers of nodules usually in the coal measures. It varies in color from light yellow to brown, but the light-colored ore rapidly becomes brown when exposed to air. Like spathic ore, it usually contains considerable manganese. Black band is a clay ironstone containing considerable carbonaceous matter, which gives it so dark a color that it frequently resembles coal. The carbonates are not largely used as ores in this country.

8. Pyrite.—According to our definition of ore, pyrite is not an ore, in this country at least; but after extracting the sulphur in the manufacture of sulphuric acid, the residue of iron oxide, known as "blue billy," is sometimes mixed in small quantity with ores for the production of iron.

DISTRIBUTION OF IRON ORES IN THE UNITED STATES

9. Magnetite.—This ore is found principally in a belt running along the Eastern coast, from Lake Champlain to South Carolina. There is considerable of it in New Jersey and Eastern Pennsylvania, but the largest deposits are found in Virginia and North Carolina. It is also found in Missouri and in Northern Michigan, and is mined in Eastern Canada.

The mineral *franklinite* is closely allied to this ore, and is sometimes considered as a mixture of magnetite with the oxides of manganese and zinc. It is generally considered as a mixture of ferric and manganic oxides with ferrous, manganous, and zinc oxides. In appearance it closely resembles magnetite, but is less magnetic. In New Jersey, where it occurs quite abundantly, it is treated for the extraction of zinc, and the residue thus obtained is used for the manufacture of spiegeleisen.

10. Red Hematite.—Until the discovery of the deposits of this ore in the Lake Superior district, it was chiefly obtained from a belt extending along the eastern coast of the United States, just west of the magnetite deposits, and ending in Alabama. Some of this ore is found in New York, but there is not a great deal of it north of Danville, Pennsylvania. At present, the greater part of the red hematite used in this country comes from the Lake Superior district. Ore of almost any desired composition may be obtained in this district; and the enormous quantity of ore, its purity, the comparatively small cost of mining, and the shipping facilities have made this the great ore-producing section of the United States.

11. Brown Hematite, or Limonite.—This ore is found in a belt lying west of the red hematite in the eastern part of the United States. Considerable of it was formerly mined in Central Pennsylvania and there is much of it in Alabama. It is also mined in the New England States and in the Lake Superior district.

12. Carbonate.—This ore is important in Europe, especially in England, but there is not much of it in this country. It usually occurs with bituminous coal or in the coal measures. It is mined to a certain extent in Western Pennsylvania and Ohio.

Iron ore is found in several of the Western States, but as these discoveries are comparatively recent, and as the mines have not been developed to any great extent, it is impossible to give much reliable information in regard to the ore in this section at present.

VALUATION OF IRON ORE

13. In deciding the value of an iron ore, several things must be considered. Other things being equal, the value of the ore will depend on the amount of iron it contains, and ore is usually sold for a certain price per unit of iron. The freedom of the ore from injurious constituents must also be considered, and if considerable quantities of such substances are present, the ore rapidly declines in value. The physical properties of the ore and its proximity to market are also important factors. As magnetite contains the highest percentage of iron of any of the ores, it would be the most valuable of any, if the amount of iron alone were considered, but as it usually contains considerable quantities of injurious substances—especially titanium and sulphur—and as it is difficult to reduce, it is not as valuable as hematite. On the other hand, the ore of the Mesabi Range, in the Lake Superior district, is very rich and free from impurities, is soft and easily reduced, and as it is a surface ore lying in a horizontal layer, is mined very cheaply by means of steam shovels. But it is not usually considered very valuable, for it is very fine, and when charged into an ordinary furnace running, as is usual, with other ores, much of it is blown out with the escaping gases and it fouls the stoves and clogs the boiler flues. The part that stays in the furnace tends to hang to the walls for a time and then to slip, cooling the furnace and producing poor iron.

PREPARATION OF ORES

14. In this country, most of the ores are used just as they come from the mine, but in some cases a preliminary treatment is an advantage and sometimes a necessity. The preliminary treatment is very simple, however, and is usually confined to three operations—viz., washing, crushing, and roasting.

15. Washing.—The rich ores, generally used at the present time, require no treatment, but it is sometimes more

economical, on account of location or for some other cause, to use poorer ores that may be improved by washing or other treatment. For instance, the limonite ores that occur in detached nodules mixed with clay are washed to remove the clay, leaving the ore. This is usually accomplished by first passing water over it in an ordinary trough, when much of the finer material is carried off. The ore and the remaining dirt are then carried to a revolving screen, known as a trommel, and the remaining clay, etc. is washed out by means of a spray of water. The arrangement of the screen and the method of delivering the water are frequently varied. Sometimes a pipe carries water in the middle of the trommel, and sometimes a flat screen is used. In the latter case, the screen is placed in an inclined position and given a motion sidewise, the ore is run on to the upper end of it, together with a stream of water, which washes the clay through the screen, while the motion causes the ore to pass on to the lower end of it.

16. Crushing.—At the present time, most ores are used just as they come from the mines, but some of the hard, refractory ores that are mined in large lumps are broken up before charging into the furnace. Probably the form of apparatus most frequently employed for this purpose is that of Blake's rock crusher, in which the ore is crushed between a hard, moving jaw and a hard, fixed face. Sometimes the ores are broken by hand, and stamps, rolls, and centrifugal machines are used for this purpose. The stamps used for this purpose are shoes of iron or steel having an up-and-down motion, and acting on a steel plate. They are usually worked in sets, each set consisting of several stamps. The rolls are iron or steel cylinders, and are usually worked in opposite directions. The centrifugal machines are hollow cylinders containing large iron balls. For uniformity in smelting, it is undoubtedly an advantage, when refractory ores are used, to have the large lumps broken up. The size to which the lumps should be reduced will depend largely on the size and shape of the furnace

and the character of the ore. Large lumps allow the gases to pass through more freely, while small lumps or fine ore pack more closely together and offer greater resistance to the blast, thus increasing the pressure in the furnace, but a larger surface is exposed to the action of the reducing gases.

17. Roasting.—Some ores are roasted to accomplish one or more of several purposes. These are to desulphurize the ore, either entirely or partially, to expel water, to expel carbon dioxide, and to expel other volatile matter. Two other objects that are not directly aimed at in roasting are frequently accomplished. The ore is usually made more porous, thus exposing a larger surface to the reducing gases, and the lumps of some ores break up to a greater or less extent. In the case of magnetite, roasting converts the ferrous oxide into ferric oxide, and thus lessens the liability of the iron to pass into the slag.

Roasting or calcination is accomplished in open heaps, in stalls, or in kilns. Where fuel is cheap and space is abundant, ores are frequently roasted in open heaps. When this method is adopted, a layer of coal a few inches thick is spread on the ground, and a layer of ore is spread over it; coal and ore are then added in alternate layers until the pile is from 4 to 9 feet in height, the proportion of ore to fuel increasing from the bottom towards the top. The coal at the base of the pile is ignited and the combustion extends throughout the pile. If at any time during the operation any part of the surface indicates that the combustion is proceeding too rapidly at that point, it is damped down by the addition of fine ore. The operation is allowed to proceed until all the coal in the heap is burned.

Black band ore frequently contains enough carbonaceous matter to accomplish the roasting without the addition of fuel, except one layer of coal, which is placed on the ground to start the combustion.

In some districts, calcination is accomplished in stalls, which are rectangular spaces enclosed on three sides by walls from 6 to 12 feet in height. These walls are perforated

by two rows of air holes, each about 4 inches in diameter. The lower row is near the bottom and the second row about 3 feet above the first. The floor of the stall usually slopes slightly towards the open side. The operation of roasting is conducted the same as in open heaps, but less fuel is used, the draft is more under control, and a more perfect calcination is accomplished.

The calcination of ores in kilns is more economical, as regards fuel and labor, than either of the foregoing processes, and, in addition to economy, the process is more under control and a more uniform product results. There are a number of forms of kilns. Among the best known are the Gjers, Grittinger, and Davis-Colby.

In Fig. 1 is shown a vertical section of the Gjers calcining kiln. This is a circular kiln built of iron plates and lined with about 14 inches of firebrick. A common size for kilns of this kind is 14 feet in diameter at the bottom, 20 feet at the widest part, and 18 feet at the top. The height of such a kiln would be about 30 feet and its capacity 6,000 cubic feet, but they are also constructed of more than twice this capacity. The kiln rests on a cast-iron ring supported on cast-iron columns about 30 inches in height, leaving a clear space for the removal of the roasted

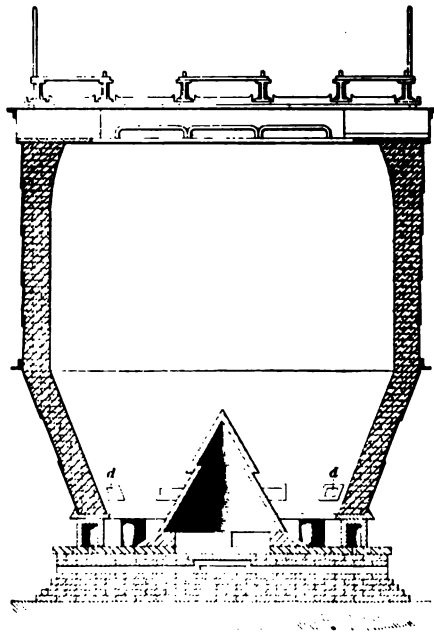

FIG. 1

ore. A cast-iron cone with its apex upwards rests on the ground in the center of the kiln. This directs the descending

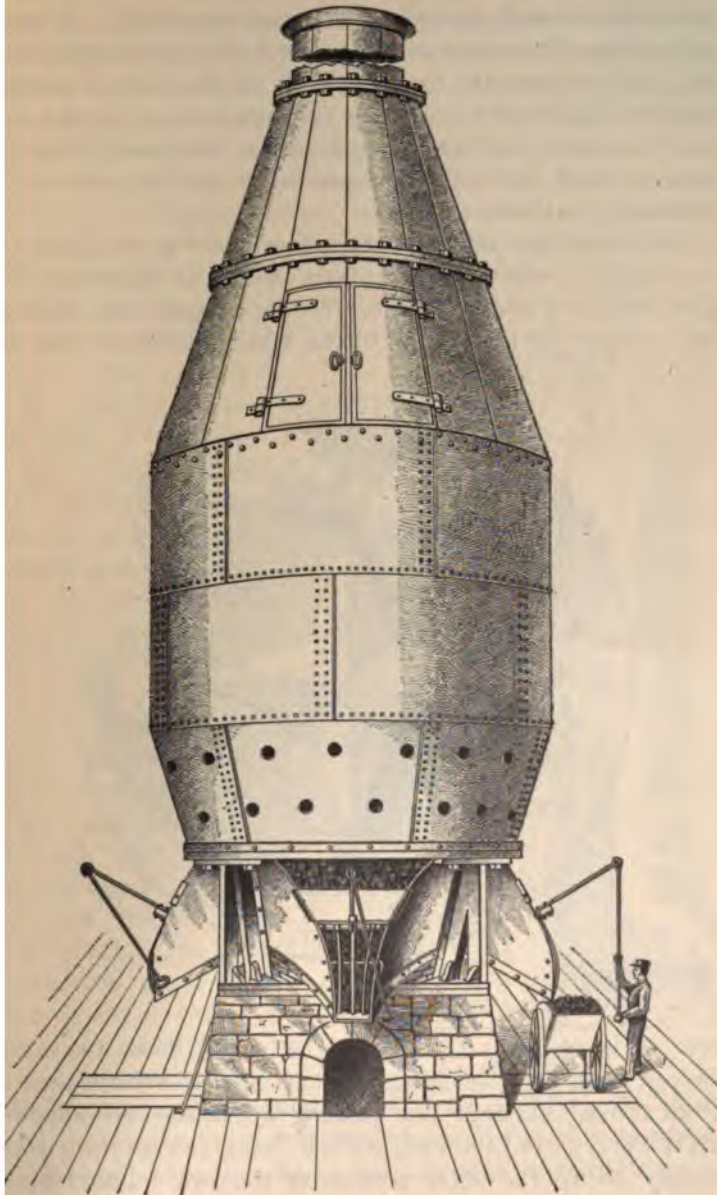

FIG. 2

ore outwards and renders its removal more easy. A series of openings *d* supplied with doors extends around the kiln near the bottom, for the admission of air; and the supply may be regulated by opening or closing doors as the case may demand. As the roasted ore is removed from the bottom, fresh ore and fuel are added at the top; hence, the process is continuous.

The Grittinger ore roaster is shown in Fig. 2. Like the Gjers kiln, it is built of iron plates lined with firebrick. The kiln rests on a masonry base. A star-shaped cone rests on the masonry in the bottom of the kiln, and this directs the

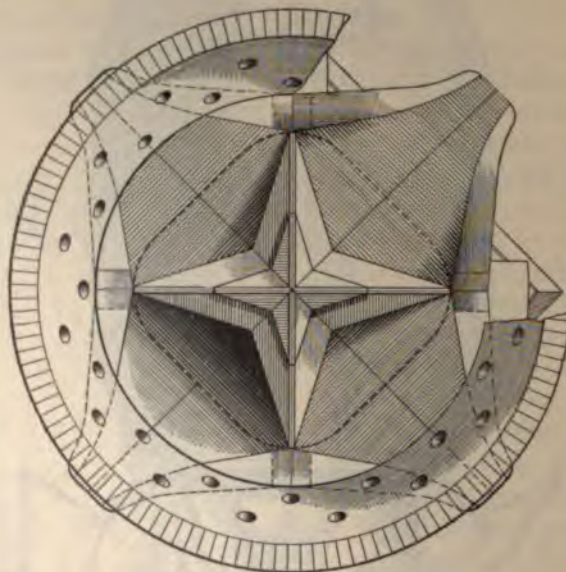

FIG. 3

ore outwards into the chutes. Fig. 3 shows the star-shaped cone and the chutes as they appear when looked at from above. A large flue passing up in the cone supplies air to the center of the kiln, and the openings near the bottom supply air to the outer portion of the ore. The roaster shown in Fig. 2 is supplied with a cast-iron hood and

chimney. These are not essential parts of the roaster, but are advantageous when ores containing much sulphur are roasted, as they carry off the fumes of sulphur dioxide. The raw ore and fuel are charged at the top, as in the Gjers kiln, and the roasted ore is discharged from the chutes.

The Davis-Colby ore roaster, shown in Fig. 4, uses gas as the fuel. It consists of two concentric shafts of brickwork having between them a space e , about 18 inches at the top and 24 inches at the bottom, to contain the ore under treatment. The outer shaft contains the gas flues x , the fire arches b , the air flues and poking holes z , and the chutes c , for removing the roasted ore. The inner shaft f contains the openings d through which the products of combustion enter the shaft. These waste gases are carried down and escape through the underground flue f' , which connects with the draft stack. The ore is dumped upon the cone l , which covers the inner shaft, and this distributes it.

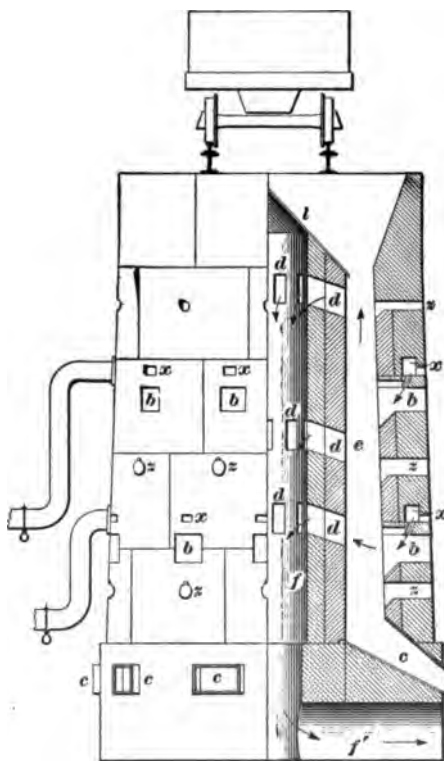

FIG. 4

This roaster is sometimes modified by building the draft stack on the shaft f and leading the products of combustion up through this, but when this is done the difficulty of charging the ore is increased.

18. Rules for Desulphurizing Ores.—The following conclusions are drawn from the experiments conducted by Mr. Valentine at Lebanon, Pennsylvania.

1. Heat alone, without access of air, can remove at best only one-half of the sulphur present.
2. Atmospheric oxygen is absolutely necessary for a proper desulphurization.
3. Even at a low heat, ore is properly desulphurized if air can gain access freely to the FeS_2 in it.
4. Sulphate of iron can be decomposed by heat equally well with or without air.
5. In order that the residuum of sulphur in roasted ores may consist, so far as possible, of sulphates, the roasting must be done under free access of air.
6. Fusion or sintering of ore is likely to prevent any further desulphurization.
7. Sintering does not allow much of the remaining sulphur to be in the form of sulphate.
8. Fusion, hence, should never occur in roasting, except after continued heating in air at a lower temperature.
9. Ores cannot be properly desulphurized in the upper part of the blast furnace.
10. An efficient roaster must allow easy control of heat, abundant access of air to the hot ore, and rapid removal of the products of combustion.

FUEL

19. Quite a variety of fuels may be used in the blast furnace, provided the furnace is modified to suit the particular case. With proper modifications, it has been found that raw non-caking coal, turf, and wood are available, but in this country at the present time the only fuels used to any considerable extent are coke, charcoal, and anthracite coal. Coke is, on the whole, the most satisfactory fuel for the blast furnace, and is much more largely used than either of the

others. Charcoal is used to a certain extent on account of its freedom from impurities and because it is generally believed that charcoal iron is better for some purposes than the iron made in a coke furnace. Anthracite is used principally in Eastern Pennsylvania, as the proximity of the mines makes it the cheapest fuel available. In some cases a mixture of coke and anthracite is used.

20. Coke.—Coke is the combustible residue left when the volatile constituents of bituminous coal are expelled by heat. Much of the sulphur of the coal is expelled with volatile hydrocarbons, so that the coke usually contains considerably less sulphur than the coal from which it is made. Coke made from different coals and by different methods varies both in composition and properties. In determining the value of coke as a blast-furnace fuel, both the chemical composition and the physical structure must be taken into account. A good coke for furnace use should contain a low percentage of ash, sulphur, and phosphorus and a high percentage of fixed carbon.

It should be strong and hard, for the softer coke softens still more when heated in the upper part of the furnace and will not bear the weight on it well. In addition to this, it burns more readily than the hard coke, and much of its power is gone before it reaches the bottom of the furnace, where it should burn in order to work economically. At all events, the coke should be uniform in composition and properties, as it is impossible to produce good results without a uniform fuel.

21. Charcoal.—Charcoal is the carbonaceous residue that remains when wood is partially burned with a limited supply of air, or heated out of contact with air. It is generally obtained by making a pile of wood closely packed together, covering it with earth to allow but little air to come in contact with it, and igniting the wood. Part of the wood is thus consumed in charring the remainder. Considerable charcoal is also obtained as a by-product in the manufacture of wood alcohol and other manufacturing processes.

Charcoal is more expensive than coke, and as it is not as strong, it will not bear up the burden as well; hence, it is only used in comparatively small furnaces. On account of its freedom from impurities, it is thought to produce a superior grade of iron, and is consequently used to a certain extent.

22. Anthracite.—Anthracite is a strong hard coal and bears up the burden well while at a comparatively low temperature, but as it is very dense it burns slowly, and when it comes to the hotter portion of the furnace it decrepitates, falling into small pieces that cause the charge to descend slowly and hinder the ascent of the gases. Hence, a higher blast pressure is generally used in furnaces using anthracite than in those using coke. The anthracite furnace should also have a larger diameter in proportion to its height than a coke furnace.

FLUXES

23. As nearly all iron ores contain an excess of silica, a basic substance that will unite with the silica, forming a fusible slag, is required as a flux. For this purpose, limestone is almost universally employed, though dolomite is used to some extent. The value of a limestone as a flux depends on its freedom from impurities, especially silicon and sulphur. The presence of silica in the stone rapidly reduces its efficiency as a flux, and as the lime unites with the sulphur of the stock, thus removing it from the furnace in the slag, it is important that the stone should be free from sulphur to start with. A small amount of magnesia in the stone appears to be an advantage, but a high percentage is detrimental, except in the production of spiegeleisen, ferromanganese, etc., in which cases a difficultly fusible slag is desired. For the production of Bessemer iron, it is also important that the stone should be free from phosphorus, for practically all the phosphorus in the stone, as well as that in the fuel and ore, go into the iron. A small amount of magnesia in the flux appears to make the slag more fusible, but a larger quantity decreases its fusibility; and, consequently, a stone containing but little of it is preferred.

The carbon dioxide is driven off by the heat before the stone begins to act as a flux, and an attempt was made to economize fuel by burning the stone to lime, using a cheap fuel for this purpose, before charging it into the furnace. This was not successful, however, for the lime appears to absorb carbon dioxide from the escaping gases in the top of the furnace, and is changed back to carbonate. The carbon dioxide must then be driven off again in the hotter part of the furnace before fluxing begins.

A few ores contain an excess of basic material, and in such cases an acid material must be added to form a slag. This is frequently done by mixing with a silicious ore in the proper proportion.

24. The Efficiency of Limestone.—The usual method of calculating the efficiency of a limestone is as follows: Multiply the percentage of lime by .54; multiply the percentage of alumina by .87; multiply the percentage of magnesia by .75. Add the results, subtract the percentage of silica, and the result will be the amount of silica that the stone will flux. For example, take a stone having the composition

$$\begin{aligned} SiO_2 &= 5.00\% \\ Al_2O_3 &= .80\% \\ CaO &= 50.64\% \\ MgO &= 1.27\% \end{aligned}$$

$$\begin{array}{r} \text{Then,} \\ .80 \times .87 = .70 \\ 50.64 \times .54 = 27.35 \\ 1.27 \times .75 = \underline{.95} \\ \hline 29.00 \end{array}$$

This gives the amount of silica that will be fluxed by the basic material in the stone. Then, subtracting the silica in the stone, we have $29 - 5 = 24$, the efficiency of the stone in terms of silica, or, in other words, 100 pounds of the stone will flux 24 pounds of silica contained in the ore and fuel. This method of calculation of the efficiency of a stone is useful in many cases, but it is based on theoretical calculations, and in practice yields a slag that is too acid for ordinary purposes.

BLOWING ENGINES

25. The details of the blowing engines belong to the province of the mechanical engineer rather than to that of the chemist or metallurgist, but as these engines are of vital importance in running a furnace, a brief description will be



FIG. 5

given. The blowing engines at most of the furnaces at the present time are of the vertical type, similar to that shown in Fig. 5. There are a number of these engines that have proved themselves very good, each having some advantage over the others.

In these engines the blowing cylinder, or "blowing tub," as it is usually called, is at the top. It is fitted with valves, so that when the piston passes up the air is forced out at the top to the blast main, and at the same time air is drawn in at the bottom of the cylinder. When the piston passes down, air is forced out of the bottom of the cylinder to the blast main, while air is drawn in at the top to fill the cylinder. A good arrangement is to have at least three blowing engines, any two of which will easily produce all the blast ever required. Then, by always having one engine idle and alternating, all necessary repairs may be made without interfering with the blast, which is so important for the successful working of the furnace.

STOVES

26. Formerly a cold blast was used in furnaces, but considerable extra fuel was required to heat the large amount of air blown into the furnace, and at present a hot blast is used almost exclusively. The blast is heated in so-called stoves by means of the waste gases of the furnace. These stoves are of two kinds, viz., iron *pipe stoves* and *regenerative stoves*.

PIPE STOVES

27. When the hot blast was first introduced, cast-iron pipe stoves were employed to heat it. One of the earliest forms of stoves is shown in Fig. 6. It consists of an oblong chamber of firebrick, along each long side of which circular mains *a* and *b* pass near the bottom of the chamber. These mains are fitted with sockets that receive the ends of inverted U-shaped cast-iron pipes, which form an arch and connect the two mains. Each stove usually contains from eight to twelve of these U-shaped pipes. The gas from the furnace is burned in the chamber between the mains, and the flame passes up between and around the pipes, thus

heating them. There are generally partitions in the mains between the sockets, so that the cold air forced in *a* passes through the first pipe to *b*, then back through the second

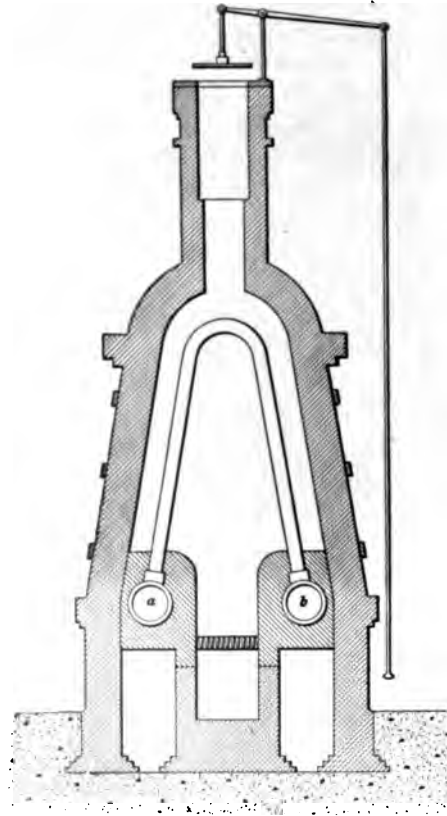

FIG. 6

pipe to *a*, and so on until it has passed through all the pipes and has become heated, when it leaves the stove by the hot-air main.

This stove has been modified in many ways until at present there are a number of forms of pipe stoves in use, but all depend on the same principle and may be considered as modifications of the stove just described. These stoves are much cheaper than the regenerative stoves, and produce a comparatively even temperature, which is favorable for the production of a good quality of foundry iron, and conse-

quently are well liked by many furnacemen at small furnaces making foundry iron. The principal objections to them are that they will not heat the blast to a temperature exceeding 1,000° F. without rapidly burning out the pipes, and if an even temperature is not continually maintained the pipes crack from the expansion and contraction caused by changes in temperature, and the expense of keeping the stoves in repair

is relatively large. In addition to these objections, the back pressure in pipe stoves is always considerable and there is always more or less leakage, thus throwing extra work on the blowing engines.

REGENERATIVE STOVES

28. On account of the objections just enumerated and the relatively high temperature of blast now employed, the pipe stoves have been quite generally superseded by stoves built on the regenerative principle of Sir W. Siemens. The adoption of these stoves has been attended with considerable saving in fuel and an increased output, and the cost of repairs has been greatly reduced. There are four types of regenerative stoves, viz., the Cowper, the Whitwell, the Massick and Crooks, and the Kennedy stoves. These are all good and are all largely used.

29. The Cowper Stove.—This stove is round in form and consists of a wrought-iron casing lined with firebrick. It is covered with a dome-shaped roof, also lined with firebrick. Most of the interior of the stove is filled in with a checkerwork of firebrick, but at one side of the stove a circular flame flue, or combustion chamber *f*, is left clear. Fig. 7 is a vertical section showing the flame flue *f* and Fig. 8 is a cross-section showing a general plan of the stove. The furnace gas enters the stove through the valve *g*, mingles with the air that enters through the valve *a*, and burns in the combustion chamber *f*. The divisions in the combustion chamber, shown in Fig. 8, are to secure a more thorough mixture of gas and air. The flame and heated products of combustion pass up under the dome and then down through the numerous passages in the checkerwork of firebrick, which is supported by the pillars *p*. In their downward passage, the gases give up much of their heat to the checkerwork of brick and finally pass out of the stove at *s*, into the draft stack. After burning the gas in the stove for a time, the brickwork becomes highly heated, especially

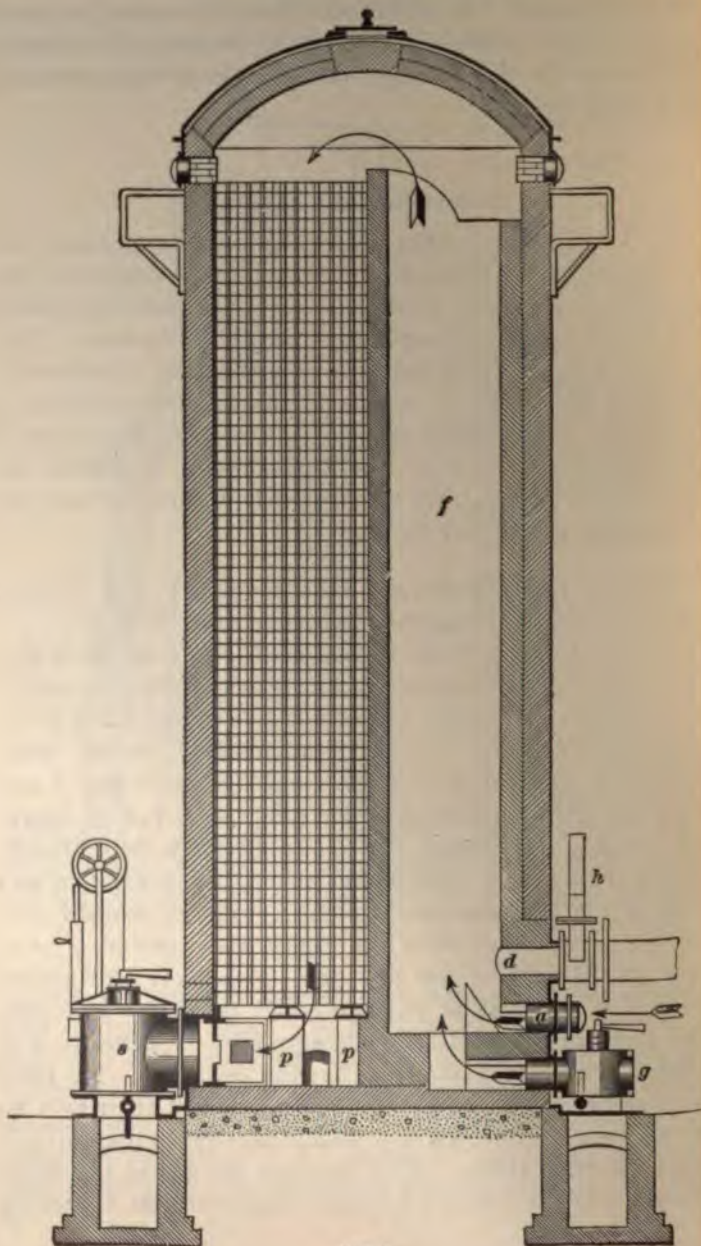

FIG. 7

near the top of the stove. The valves *a*, *g*, and *s* are now closed, and the cold-air valve *c* near the bottom of the checkerwork and the hot-air valve near the bottom of the combustion chamber are opened. The cold air from

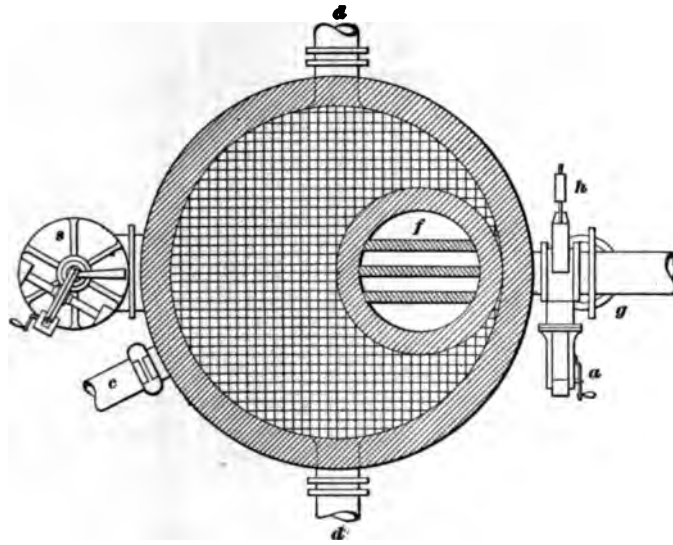

FIG. 8

the engines enters near the bottom and, passing up through the checkerwork of hot brick, becomes heated. It then passes down through the combustion chamber and out at the valve *h* to the hot-blast main leading to the furnace. At the sides of the stove are the cleaning doors *d*.

30. The Whitwell Stove.—This, like the Cowper stove, is a tall, round stove consisting of a casing of wrought iron lined with firebrick. It differs from the Cowper stove principally in the arrangement of the inner brickwork and in the method of admitting the air to burn the gas. Fig. 9 shows a vertical section of this stove. The furnace gas passes into the stove through the valve *g*, where it meets a limited supply of air, introduced through *a*, and partly burns

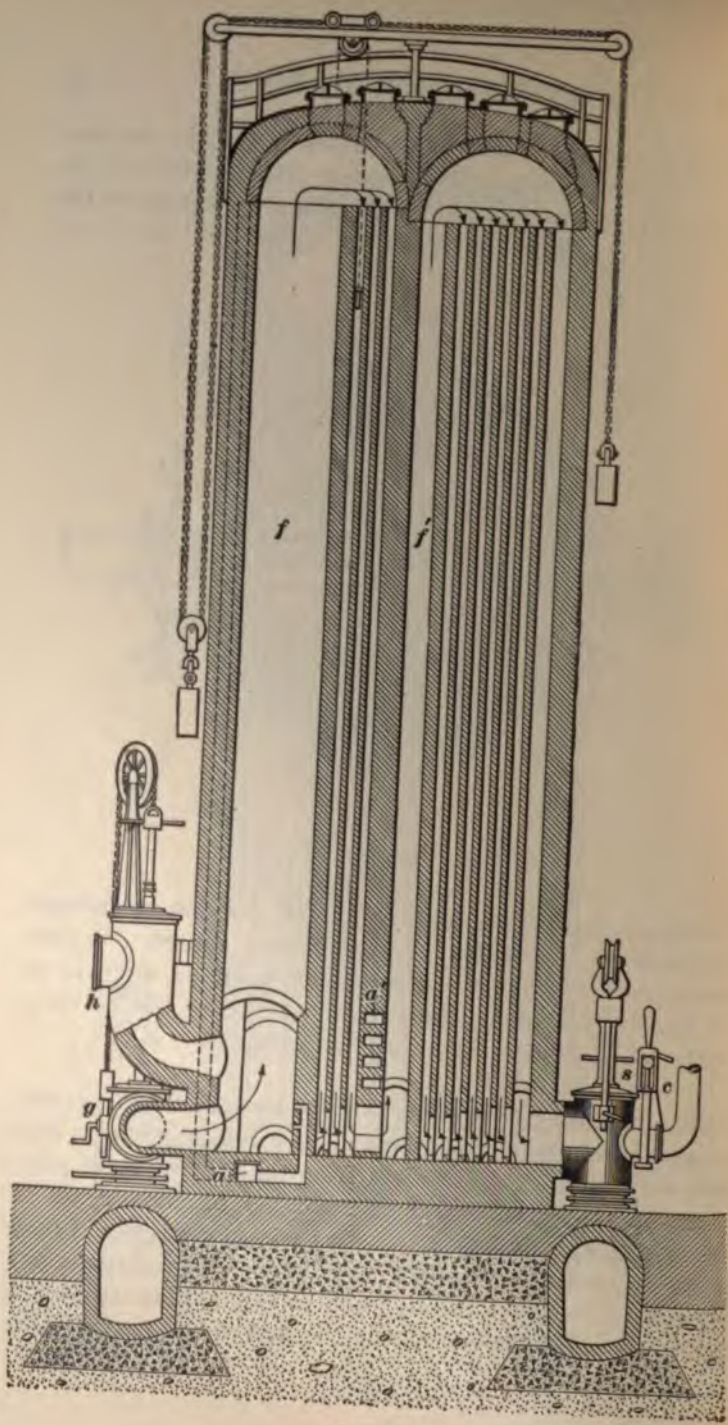

FIG. 9

as it passes up through the flame flue, or combustion chamber *f*. The unconsumed gas and the products of combustion pass down through the narrow chambers, as indicated by the arrows. At the bottom of the stove, the gas meets a fresh supply of air, introduced through *a'*, and the combustion is completed in *f'*. The hot products of combustion pass down through the narrow chambers, as indicated by the arrows, and escape through the valve *s* to the draft stack. When the brickwork is thoroughly heated, the valves *a*, *g*, and *s* are closed, and the cold-blast valve *c* and hot-blast valve *h* are opened. The blast passes through the stove in the reverse of the course taken by the furnace gases and passes out by the valve *h* to the hot-blast main.

As we have seen in the Cowper stove, the gas and the air pass out of the stove after passing up and down through the stove once, while in the Whitwell the gases and the air each pass up and down twice before leaving the stove; hence, the Cowper stove is called a two-pass stove and the Whitwell a four-pass stove.

31. The Massick and Crook's Stove.—This stove has the combustion chamber, or flame flue, in the center. The hot products of combustion pass down through chambers just outside of the combustion chamber, and pass up through chambers next to the walls of the stove, escaping through a chimney built on top of the stove. It is therefore a three-pass stove.

32. The Kennedy Stove.—The Kennedy stove is built much like the Whitwell, but differs from it in the arrangement for burning the gas and the passage of air. In all the stoves mentioned thus far, the combustion chamber is heated very highly, while the portions of the stove traversed by the products of combustion just before their escape to the chimney are relatively cool. Mr. Kennedy sought to equalize the temperature by admitting gas and air at the bottom of the four chambers, thus burning the gas as it passes up through these chambers and allowing the products

of combustion to escape directly by a chimney on the top of the stove, thus having a direct natural draft. When the stove is heated, the valves are changed, and the blast passes through all four chambers, thus making the stove one-pass for gas and four-pass for the blast.

33. General Remarks on Stoves.—All these stoves have been modified to a greater or less extent, to suit the conditions at different furnaces. In many places, instead of admitting gas and air by separate valves, the gas is introduced into the stove through a jet pipe carried on a horizontal slide covering the opening in the gas main. From this it is blown into a circular opening in the stove, which is larger than the jet pipe. The gas thus forced in under pressure draws in the air necessary for its combustion. At each furnace, there should be three or four stoves of sufficient size to heat the blast. If there are four stoves, the blast will be passing through two of them while two are being heated, and by alternating at frequent intervals an even temperature may be maintained.

THE FURNACE

34. There have been great changes in the size and form of furnaces in the last half century, and as changes are continually being made in the style of building, it is impossible to give the most favorable dimensions, for this is a matter that has not been determined. Indeed, if furnaces of several types were run side by side for some time, this would not establish the most favorable form for use under all conditions, for the form of furnace that will produce the best results with one kind of stock will not work well with another kind. For instance, a tall furnace, relatively small in diameter, is now generally considered the best for coke practice; but if charcoal were used in such a furnace, it would be crushed by the great weight of stock. Anthracite, though strong, decrepitates when strongly heated in the furnace, and fine particles mixing with the

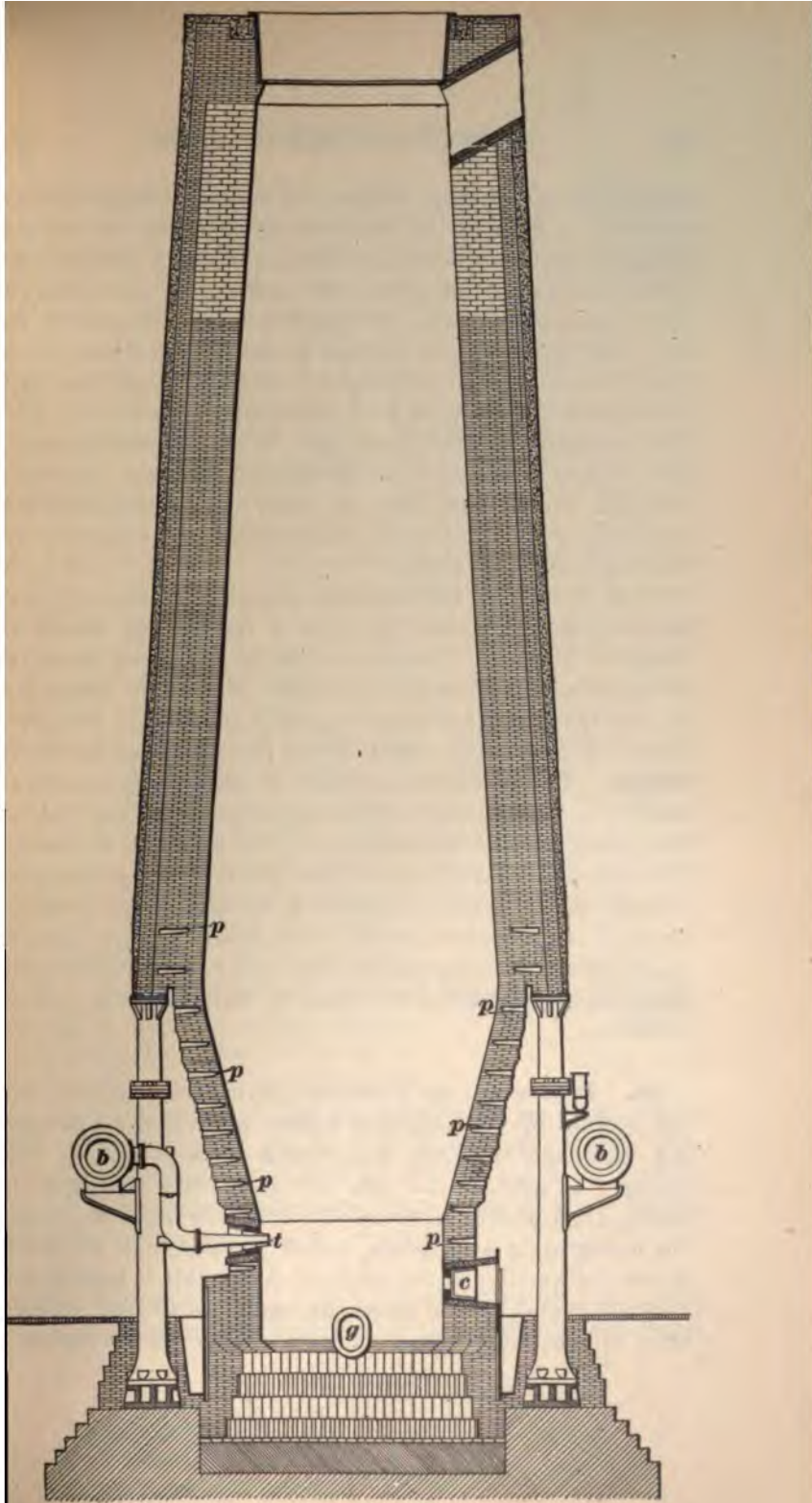

slag as it is forming produce a compact mass through which it is difficult for the blast to penetrate for any considerable distance; hence, a furnace in which anthracite is to be used as the fuel should be rather low and relatively large in diameter. Fig. 10 shows a form and size of furnace that appears to be popular at the present time for coke practice, as several furnaces of almost exactly the same dimensions are being built in this country, or have recently been completed. The lower part of the furnace, known as the hearth, or crucible, is 13 feet in diameter and 9 feet 6 inches deep. The walls are built of the most refractory firebrick, to withstand the intense heat of the molten iron and slag that collect here.

From this point the diameter steadily increases up to the mantel, 15 feet above the top of the hearth, where the diameter is 21 feet. The part of the furnace from the hearth to the mantel is known as the bosh or boshes. From here up the diameter decreases regularly until it is 14 feet at the stock line. The throat is 70 feet 6 inches above the mantel. The stack, as the part of the furnace above the mantel is called, rests on strong columns of iron that are set firmly on the foundation. The stack is encased in wrought-iron plates, which are firmly riveted together. Though the tendency at present is to build large furnaces, most of the furnaces in this country are smaller than the one shown in the illustration, but those recently constructed resemble the furnace shown more or less closely in general form.

35. Protection to Furnace Linings.—The heat near the bottom of the furnace is intense and the stock descending, combined with the heat, tends to wear on the brick lining. In addition to this, the slag tends to attack the lining, thus wearing it away still more rapidly. To protect the lining so far as possible, hollow plates *p*, Fig. 10, are set in the brickwork and a current of cold water is kept flowing through them. These plates are made of cast iron, wrought iron, bronze, and copper, but the copper plates appear to

wear better than the others. The cold water coming close to the inside of the lining cools the bricks and causes a thin layer of slag to solidify on them, which protects them from the further action of the slag. A number of rows of these are set in the lining, completely surrounding the furnace. As a rule these coolers have been set in up as far as the mantel, and in furnaces thus protected it has been noticed that after running some time the hearth and boshes were in very good condition, but that the brickwork just above the upper row of plates was worn back for some distance, forming an offset in the lining. To remedy this, two or three rows of plates have been set in above the mantel in some of the new furnaces. The furnace shown in Fig. 9 has two rows of these plates. The plates above the mantel are generally set back about 1 foot from the inside surface of the lining, to allow the furnace to assume the most favorable working lines. The lining near the stock line—the point near the throat to which the stock extends when the furnace is working—is usually worn quite rapidly by the coarse stock falling or rolling against it. To prevent this, brick-shaped cast-iron plates were set in the lining of some furnaces at this point. They protected the lining at this point, but were very heavy. More recently a casting having the shape shown in Fig. 11 has been used in some furnaces, and answers the purpose remarkably well. The advantage of this form over a brick-shaped casting is that the lining receives equal protection, while the weight is greatly decreased. The furnace is usually surrounded by a wall with suitable openings, and a roof is built around the furnace above the mantel, thus forming a kind of rude house to protect the men working around it from the weather and from pieces of stock falling from the top of the furnace.



FIG. 11

36. Tuyeres.—The hot blast as it leaves the stoves passes through a large pipe lined with firebrick to the bustle

pipe *b*, Fig. 10, which is also a large pipe lined with firebrick running around the furnace and generally supported by brackets on the columns that support the stack. From this the blast is carried to the tuyeres *t*, Fig. 10, by means of pipes. The tuyeres are set in the wall of the hearth and extend through, as shown in the figure. They are thus subjected to extremely destructive influences, for besides the blast heated from 800° to 1,400° F. passing through them, the inner ends come in contact with molten metal and slag, and the heat of this part of the furnace is intense. The tuyeres are made of cast iron, wrought iron, bronze, or copper, and are always cooled by water. The method of cooling varies somewhat; one of the older forms was a hollow, truncated cone, through which a constant current of water was kept

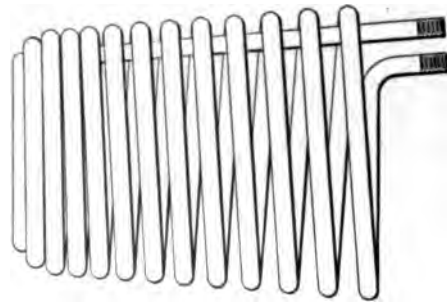

(a)

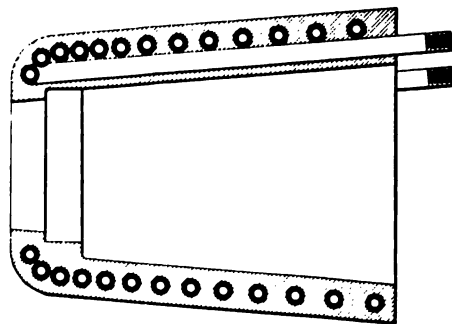

(b)

FIG. 12

flowing between the opening for the blast and the outside by means of supply and exit pipes. A form that is more common at present is shown in Fig. 12. A spiral pipe runs through the part of this tuyere that was left hollow in the older forms, and a current of water is maintained through the spiral. Copper tuyeres last better than those of iron, for besides standing the high temperature better, they are not attacked by the partially fused masses of iron that frequently adhere to iron tuyeres

when the furnace is working badly. The number and size of tuyeres vary with the size of the furnace.

In the furnace shown in Fig. 10 there are ten, which is a common number in the larger furnaces. As many as sixteen are sometimes used. The tuyeres are usually placed in a horizontal plane. If they dip downwards, it is said there is danger of the blast playing on the surface of the molten metal in the crucible, thus decarburizing it and producing white iron. It is said that sometimes in making gray iron there is an advantage in directing the nozzles slightly upwards, but this can scarcely be said to be proved.

A row of blank tuyere openings are usually built into the furnace wall above the tuyeres ordinarily used. In case the hearth partly fills up when the furnace is working badly, these may be broken through and tuyeres inserted. They are usually called monkey tuyeres.

37. Iron and Cinder Notches.—The iron notch, or tap hole *g*, Fig. 10, is generally an oblong opening, near the bottom of the hearth, lined with cast iron. It is properly cooled by water that is generally led through a spiral pipe. The opening through the iron is closed with clay, or if the clay at hand is too silicious, with a mixture of clay and coke dust. At proper intervals a hole is drilled in this clay for the iron accumulated in the hearth to pass out. The hole is drilled downwards, entering the furnace near the bottom of the hearth and practically all the iron is forced out by the blast. When the hearth is empty, the blast is turned off and the hole is closed with clay. This is hardened almost immediately by the heat, and the blast can be turned on as soon as the hole is closed. The number of casts made in a day will depend on the size of the hearth, the rate of driving, etc. When the furnace is working regularly, there is usually a set time for each cast and five or six casts are usually made in 24 hours.

Considering the part of the furnace from which the iron is tapped as the front, the cinder notch *c*, Fig. 10, is usually situated at the side, that is, one-fourth of the distance around

the furnace from the iron notch. It is situated on a level between the tap hole and tuyeres. In modern furnaces, the cinder notch resembles a tuyere and is cooled by water in the same manner. When the slag has run out, the opening is closed by a piece of metal—usually bronze—on the end of an iron bar. This chills the slag, which solidifies, effectually closing the hole in a few moments, and the bar may be withdrawn. When it is desired to remove the slag, that chilled in the inner part of the hole is easily broken through with a bar. The slag is usually conducted through a trough to a slag car or ladle, in which it is hauled to a slag dump, or cinder dump, as it is usually called. The slag is withdrawn more frequently than the iron, the frequency depending somewhat on the working of the furnace. As a rule, from three to five flushes are made between each cast and the succeeding one.

38. Bell and Hopper.—Before the blast-furnace gases were utilized as fuel, the throat of the furnace was left open, and a chimney was usually built to carry off the gases. At present, furnaces are closed and the gas is collected. The device by which the throat is closed is known as the bell and hopper, and is illustrated in Fig. 13. This differs in details in different places, but consists essentially of an inverted truncated cone, known as the hopper, set in the throat of the furnace. Beneath this is suspended a cast-iron cone known as the bell. The bell may be raised or lowered; but when raised, the joint between it and the hopper must be tight. When lowered, an opening is left between it and the hopper, through which the stock passes into the furnace.

39. The Downcomer.—Just below the hopper an opening is left in the wall of the furnace, through which the gas passes to the downcomer. This is a pipe leading down almost to the ground. At the lower end it is enlarged, forming what is known as the *dust catcher*. This, as its name indicates, is designed to collect the fine stock, etc.

carried out of the top of the furnace by the gas. It is open at the bottom, and is fitted with a small bell similar in form to the bell at the top of the furnace.

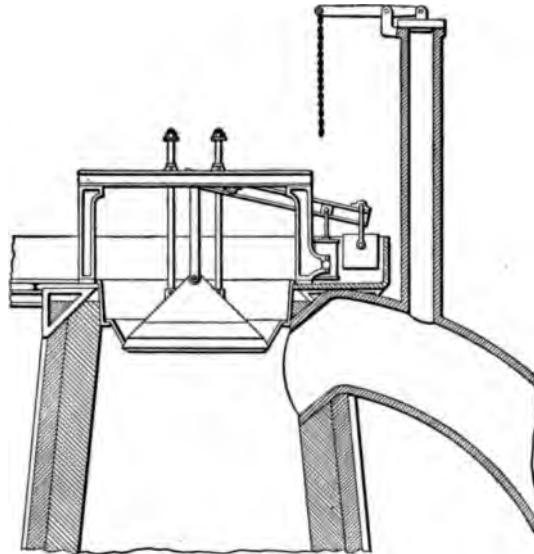

FIG. 13

When the blast is stopped after each cast, while the tap hole is being closed, the bell is lowered and the dirt that has accumulated is allowed to drop out. An opening in the top of the dust catcher connects with the gas main, which runs past the stoves and to the boilers. Enough of the gas is burned in the stoves to heat them, and the rest is burned under the boilers that produce the steam to run the blowing engines, pumps, etc. If there is gas enough, no solid fuel need be used under the boilers while the furnace is running properly, but, as a rule, it is necessary to burn coal under the boilers in connection with the gas.

40. Explosion Doors.—The stock in a certain part of the furnace sometimes stops in its descent, or hangs, as it is called, until that beneath it has passed down some distance, and then slips down. This frequently causes a more or less

violent explosion in the furnace, which in extreme cases would wreck the top of the furnace if no means were provided to relieve the sudden pressure. To provide for such

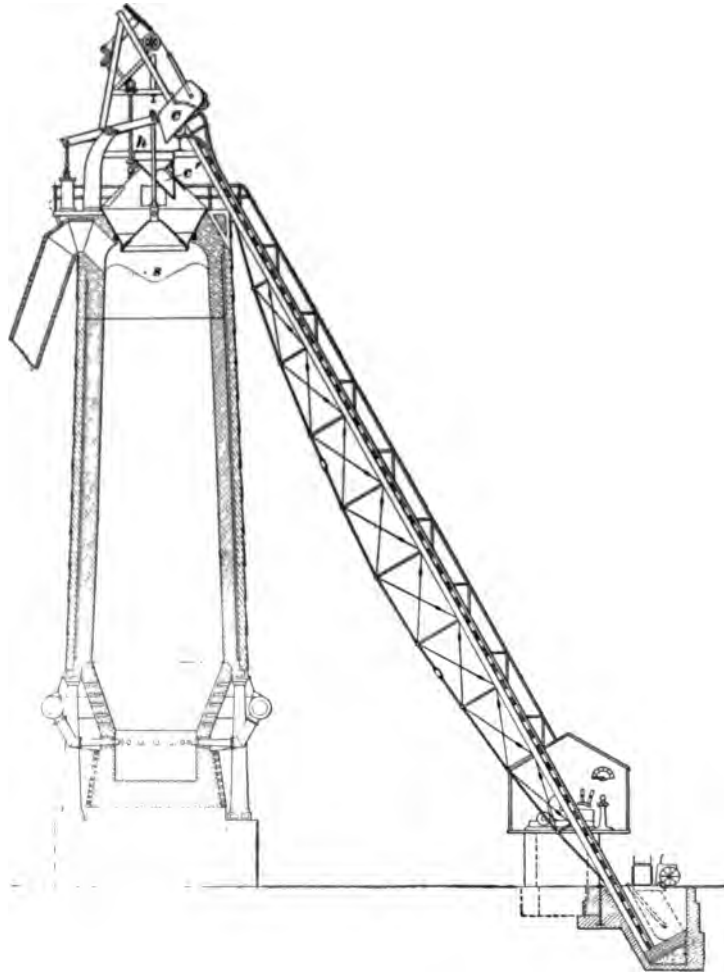

FIG. 14

cases, openings are made at the top of the furnace, and these are closed with doors held in place firmly enough to resist the pressure of the blast, but will be forced open and

relieve the pressure in case of an explosion. Such a door is frequently placed at the top of the downcomer, and one on the opposite side of the furnace, though this arrangement is by no means universal.

41. Charging.—At most of the furnaces erected some time ago, and at many recently built, the stock is raised to the top of the furnace in hand barrows by means of vertical hoists. The barrows are then dumped in the hopper by hand, and an even distribution of ore, coke, and limestone is thus easily obtained. Later, at some furnaces, sloping hoists were built, and small cars were run to the top of the furnace on rails and dumped by mechanical means. The earlier forms of this hoist were not very satisfactory, as the stock was not evenly distributed by them, and the furnace was thus caused to work unevenly. Quite recently, however, a number of furnaces have been equipped with improved mechanical charging devices that have given general satisfaction. One of these devices is shown in Fig. 14. The stock is dumped from the hoisting car *c* into the small hopper *h*, from which it passes through the chute *c'* to the regular hopper beneath. As the car goes down and comes up again, this small hopper makes part of a revolution, so that each succeeding car of stock is dumped in a different part of the hopper. It is so arranged that it may be set to dump any desired number of times in making the circuit of the top of the furnace, and an even distribution of stock is thus made possible. At proper intervals the bell is lowered to allow the stock in the hopper to fall into the furnace, where the surface of the stock takes the form of the line *s*.

BLOWING IN THE FURNACE

42. Formerly much time was spent in blowing in a furnace and getting it to running regularly, but at present this is accomplished much more rapidly. The method adopted varies at different furnaces. Some wood is nearly always used in blowing in, but the amount varies, and in

most places less wood is now used than was formerly customary, as its use is in some ways objectionable. It contains but little matter that can be fluxed off, and in some cases some of it has charred and formed lumps on the wall that remained there when the furnace was blown out for repairs. The same objection holds with respect to charcoal. In some cases wood is placed in the hearth, while in others a scaffold is built up about to the tuyeres and the wood is placed on this. In some cases, one or two rows of cord wood are stood up around the walls of the furnace above the wood to protect the lining. At present, slag is frequently added with several of the first charges put in the furnace, the amount gradually diminishing with the succeeding charges. When the furnace is lighted, this slag melts and runs down into the hearth before the ore farther up in the furnace is reduced, thus heating the hearth and preparing it for the iron. It is a good plan in blowing in to so proportion the limestone that the first slag will be slightly acid, for a basic slag attacks the lining much more rapidly than an acid slag, until a coating of slag and graphitic material has formed on the lining. A very acid slag should be avoided, however, as this wears the lining quite rapidly.

A method of blowing in that has proved very satisfactory is to place coke in the crucible up to within a couple of feet of the first row of coolers. On this is piled wood—generally cord wood and dry pine broken up rather fine. The wood in front of the tuyeres is saturated with oil. One or two tiers of cord wood are now frequently built up around the walls to protect the lining. About 20 tons of coke are next added and then sufficient limestone to flux the ash of the coke, and an equal weight of slag. Generally, about 1 ton each of limestone and slag will be the proper amount. If the furnace is small, a little ore may be added with the next fuel; but if large, this charge should be repeated. Above this, several charges are added, each containing about one-fourth as much ore, by weight, as coke and sufficient limestone to flux the silica of the ore and coke, together with a weight of slag equal to that of the limestone. The weight of

slag added now decreases with each charge, and after a few more charges is discontinued. The weight of ore and limestone, on the other hand, is steadily increased, until the proportion at the stock line is about one of coke to one and one-fourth of ore, and sufficient limestone to flux the silica of the ore and fuel. The furnace is now lighted at each of the tuyeres. This may be done in several ways. A good method is to run a red-hot bar through each tuyere, thus igniting the oil. Waste saturated with oil is sometimes placed in front of each tuyere for this purpose. When ignited, a gentle blast heated to about 500° F. is turned on; this is gradually increased until in a short time about one-fourth the blast generally used is being employed. The blast is heated by passing it through stoves that have previously been heated by burning coal, wood, or coke in their combustion chambers and using a gentle draft.

As soon as the wood burns out and the coke settles down in front of the tuyeres, carbon monoxide is formed. The bell should be left open until this burns steadily at the top of the furnace. The bell is then raised and the gas is usually led to the boilers first. After burning here for a short time, it is used in the stoves in the usual manner. The furnace is kept full by adding fresh stock as fast as that charged in before lighting settles. Soon after the coke commences to burn, the slag charged in will begin to melt and trickle down to the bottom of the hearth, and slag will be formed by the union of the limestone and ash of the coke. The hot slag collecting in the hearth heats it up, and the temperature of the hearth is further raised by the coke added below the wood burning here. When considerable slag has collected in the hearth, it is withdrawn through the iron notch. This is repeated several times until the iron begins to collect, and then the cinder notch is used whenever it is necessary to withdraw the slag. Any iron that may have collected and passed out with the slag is separated from it and returned to the furnace. The slag that collects in the hearth at first and is withdrawn through the iron notch heats up the hearth and clears it out, thus

preparing it for the reception of the iron, which soon begins to collect. After the blast has been turned on for a few hours it is increased, from time to time, until in a few more hours, if everything goes right, the blowing engines will be running at the ordinary rate. The experienced furnaceman can readily tell from the condition of the furnace how rapidly it is safe to increase the blast. The burden is also increased as rapidly as conditions will warrant, until the ore, fuel, and limestone are being added in the usual proportions. With careful handling, the furnace should be running as usual in a few days after blowing in.

BLOWING OUT

43. After the furnace is blown in, it is run continuously—unless it is necessary to stop a short time for repairs—until it is necessary to suspend operations, in order to reline the furnace, or for some other reason. The work may be stopped for a few days by first adding enough extra fuel to make up for the loss of heat during the stop and then closing the furnace, so that no air can get in; but if a prolonged stop is necessary, the contents of the furnace must be removed. This is known as blowing out. The blowing out of a furnace, like the blowing in, is accomplished in several different ways. A method that is being employed quite largely at present, because it protects the top of the furnace, is as follows:

When the furnace is running normally stop the addition of ore and continue to charge fuel with just enough limestone to flux the ash for 8 or 10 hours; then add fuel alone, keeping the furnace filled to within 10 or 15 feet of the top. When the ore is all reduced and the coke and limestone begin to enter the hearth, an excess of gas will be produced. Some of this is allowed to escape and burn at the top of the furnace by opening the bleeder. Later, it will probably be necessary to open the explosion doors also. Continue to run as usual for from 3 to 5 hours for any difficultly fusible material in the hearth to melt and then gradually reduce

the blast. Finally drill a hole through the iron notch as low in the hearth as possible and blow out the last of the molten material. Now shut off the blast and close the tuyeres with clay. After standing for 24 or 36 hours, remove two or three of the tuyeres and rake the coke out through these openings. A stream of water is directed on the coke as it falls to the ground in front of the tuyere openings, to cool it. It is then taken to the stock pile to be used again. When the coke is raked down level with the tuyeres, the remainder is cooled with water, and when sufficiently cool, workmen are sent in to finish cleaning out the hearth. By keeping the furnace pretty well filled with coke in this way, while the last of the ore is being reduced, the top is protected from the intense heat of the hearth.

CASTING

44. When considerable iron has collected in the hearth, a hole is drilled nearly through the clay that closes the iron notch and a bar is driven through the remaining portion. The weight of the iron causes much of it to run out, and the pressure of the blast causes it to run faster and forces out the last portion remaining in the hearth, together with the slag that has accumulated, forming a layer on the iron. The iron runs along a trough made in the sand, known as the *runner*, which gradually slopes from the front of the furnace to the farther end of the cast house. The runner passes down the middle of the cast house, and from the runner the sand gradually slopes towards each side of the house. A skimmer is arranged a short distance in front of the furnace. This is formed by leaving an opening at the bottom of the runner, but closing it over above, so that the iron can pass through, but the slag floating on the iron is held back. When considerable slag has accumulated, the sand at one side is broken through near the top and the slag is allowed to run off through a trough provided for the purpose.

On one side of the runner, a series of parallel troughs pass from the runner to the side of the cast house, and, connecting with these troughs, a series of molds are made in the sand. The sand is broken through, allowing the iron to run into the troughs, and from these it passes into the molds, where it is allowed to cool. The iron that cools in the molds is known as *pigs* and that which cools in the troughs is known as *sows*. After the iron has cooled sufficiently, so that sudden cooling will not hurt it, water is sprinkled over it. The pigs are then broken loose from the sows, the sows are broken into suitable lengths, and the whole is loaded on cars. The sand is then worked over and molds made on the opposite side of the house to receive the next cast.

REACTIONS IN THE FURNACE

45. There are many reactions in the blast furnace; a number of these are known to occur regularly, but we will probably never be able to learn positively all that take place under different circumstances. It is not our purpose here to point out all possible reactions, but merely to give the most important of those known to occur. Just how some of the important reactions take place is not definitely known, but the exact method is of greater theoretical interest than practical importance. As there are two currents in a blast furnace—a gaseous current passing up and a solid current passing down—the reactions may be viewed from two stand-points. We will look at the matter in both ways.

46. Changes In the Gaseous Current.—As the blast of hot air enters the furnace at the tuyeres, it comes in contact with the fuel of the charge, heated to incandescence at this point, and the oxygen of the blast unites with the carbon of the fuel, forming carbon monoxide. Whether carbon monoxide or carbon dioxide is formed first is a disputed point, but this is a matter of little moment, for if carbon dioxide is formed first, it is immediately changed to carbon

monoxide on coming in contact with more fuel, according to the equation

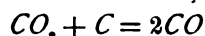

It seems most probable, however, that carbon monoxide is the first product. This is the principal reducing agent of the blast furnace. In passing upwards, it meets the highly heated ore, which has been rendered porous by the heat of the upper part of the furnace, and unites with the oxygen of the ore, according to the equation

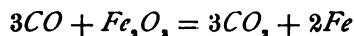

thus accomplishing the reduction of the ore with the production of metallic iron. The carbon dioxide formed when the ore is reduced immediately comes in contact with more incandescent fuel, and carbon monoxide is again formed. This acts on a second portion of ore, and these reactions continue until a point in the furnace is reached at which the temperature is too low to induce these reactions. The gases then pass up and out through the downcomer without further change. While the reaction just given is usually mentioned as the principal reducing reaction, it is by no means the only reaction, for carbon monoxide never completely reduces iron, and at high temperatures, if the iron is in the spongy form, it acts as an oxidizing agent to a certain extent, and carbon dioxide oxidizes it quite energetically.

The carbon monoxide also reduces the ore according to two other equations, viz.:

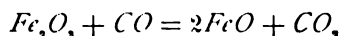

and

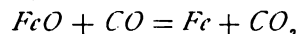

It acts as an oxidizing agent according to the equations

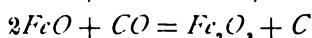
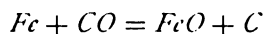

and

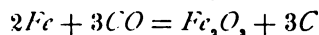

The carbon dioxide acts on the hot, spongy iron and partially reduced ore according to the equations



and

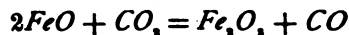

We thus see that oxidation and reduction are taking place side by side, the reactions depending on the temperature and the proportions of the elements entering into the reactions at different points in the furnace; but as the reducing tendencies are greatly in the majority, the iron is finally completely reduced, though not by carbon monoxide alone, as we shall presently see.

The gases that pass out through the downcomer are composed of carbon monoxide and carbon dioxide (from the oxygen of the air and ore, and the carbon of the fuel and carbon dioxide from the limestone), nitrogen from the air, moisture from the stock, and small quantities of volatile matter from the fuel, hydrogen, and other constituents not frequently determined. Though the nitrogen takes no active part in the reduction, it serves a useful purpose. It is hot when it enters the furnace and becomes intensely heated in the vicinity of the tuyeres; then as it passes up through the stock, it gives up much of its heat, driving off moisture and preparing the ore for reduction.

47. Reduction of the Ore.—In studying the action of the gases, we have seen that carbon monoxide reduces the ore and sets free metallic iron, and this is the most economical method of reduction; but the ore is never completely reduced in this way, and reduction is always taking place in two other ways at the same time. In both of these cases, the reduction is accomplished directly by the carbon of the fuel. In the one case, each atom of carbon unites directly with 2 atoms of oxygen of the ore and escapes as carbon dioxide. In the other, each atom of carbon takes 1 atom of oxygen from the ore and escapes as carbon monoxide. A little study will show that the reduction by carbon monoxide is the most economical, while the last method mentioned is the most expensive.

One pound of iron in the form of hematite ore is combined with $\frac{1}{2}$ pound of oxygen, and the heat absorbed in reducing this is 1,886 calories, no matter how the reduction is accomplished. One pound of carbon burning to carbon monoxide develops 2,481 calories, and $\frac{2}{3}$ pound of carbon will be required to reduce the pound of iron; hence, in reducing by means of carbon monoxide, $\frac{2}{3} \times 2,481 = 797$ calories are developed when the carbon is oxidized to carbon monoxide and $\frac{1}{3} \times 5,599 = 1,799$, or a total of $1,799 + 797 = 2,596$, calories are developed by burning the carbon, while 1,886 calories are absorbed in reducing the ore, leaving a surplus of $2,596 - 1,886 = 710$ calories to heat the furnace.

When the ore is reduced by 1 atom of carbon taking 2 atoms of oxygen, forming carbon dioxide directly, only one-half as much carbon is required for the reduction, or $\frac{1}{2}$ pound will reduce 1 pound of iron. In this case, we have $\frac{1}{2} \times 8,080 = 1,298$ calories developed, but only half the carbon is consumed. The other half will burn to carbon monoxide, developing $\frac{1}{2} \times 2,481 = 399$ calories. Adding this to the heat developed in reducing the ore, we have $1,298 + 399 = 1,697$ calories developed; but 1,886 calories are used in reducing the ore; hence, by this method we have a deficit of 189 calories, which must be made up by additional fuel before any of the fuel can be used to heat the furnace. When the ore is reduced by carbon with the formation of carbon monoxide, we have $\frac{2}{3} \times 2,481 = 797$ calories developed and 1,886 calories consumed; hence, there is a deficit of 1,089 calories in this case to be made up by extra fuel.

Of course the reduction is never accomplished by any one of these methods alone, but all are going on side by side. The carbon dioxide formed when reduction takes place by the second method will be reduced to carbon monoxide, and this will reduce a further quantity of ore if the conditions are favorable; and the carbon monoxide formed during the reduction by the third method may reduce a second quantity of ore, if it comes in contact with it under proper conditions. When the furnace is working badly, the

gases may escape after the first reaction, and then, of course, there is a loss. The ratio of CO to CO_2 in the escaping gases will give an idea of how the furnace is working.

48. Other Reactions.—When the iron is reduced, it forms a spongy mass that, in contact with the incandescent fuel, absorbs carbon. It is now thought that much of the carbon taken up by the iron is the finely divided carbon deposited when carbon monoxide is decomposed by the spongy iron.

The carbon absorbed makes the iron more fusible, and it melts and trickles down to the hearth. At the same time, silicon, phosphorus, and manganese are reduced and unite with the iron. Practically all the phosphorus in the stock goes into the iron. The amount of silicon and carbon depends largely on the temperature. With a hot furnace, the amount of combined carbon will usually be low, but the iron will contain much graphite. A hot furnace also tends to produce an iron containing a large amount of silicon, but this will depend on the burden. If an excess of lime is present, the silicon will mostly unite with this and leave the iron rather low in this element. Under ordinary conditions, most of the manganese passes into the iron, though some goes into the slag. As a rule, the hotter the furnace in which the iron is made, the less sulphur the iron will contain, but this also depends on other conditions. If an excess of lime is present, much of the sulphur will unite with this, even though the furnace may not be very hot, while if silica largely predominates in the burden, considerable sulphur will pass into the iron, even though the furnace be very hot. While these changes are taking place, the basic material of the limestone, ore, and coke ash, consisting principally of alumina, lime, and magnesia, unites with the silica of the ore and fuel, forming a fusible slag, which melts and trickles down to the hearth, where, on account of its lighter specific gravity, it forms a layer above the molten iron in the hearth.

SLAGS

49. Composition of Slag.—Slag, or cinder, as it is frequently called around the furnace, is usually considered as a double silicate of lime and alumina, but part of the lime is usually replaced by magnesia. All of the constituents vary with the kind of stock used, and when running with the same kind of stock, the proportions of fuel, flux, and ore will be varied from time to time, thus changing the composition of the slag in order to produce certain results.

The slag from a furnace using charcoal as fuel will usually contain less alumina than that from a coke furnace, for charcoal contains little or no alumina, and slags from charcoal furnaces are usually quite silicious.

The slags from coke furnaces are less silicious and usually contain more alumina, as the ash of the coke contains considerable alumina. Lime and magnesia may replace each other through quite a wide range without materially affecting the character of the slag, and alumina may apparently replace either to a limited extent. Alumina is a weak base, and in some cases may even act as an acid to a certain extent, thus rendering the slag more acid than the analysis would indicate. It is thought that this is most likely to occur when the slag contains considerable alumina and magnesia. Some of the magnesia may then unite with alumina, forming magnesium aluminate (spinel), and neither the alumina nor the magnesia thus combined takes any part in fluxing silica. It should be stated that some metallurgists think that alumina always plays the part of an acid in a furnace slag. It seems more probable that it ordinarily acts as a weak base, but is known to act as an acid sometimes.

A rule frequently given for the slag of a coke furnace is that the sum of the silica and alumina should amount to about 49 per cent. of the slag, and in blowing in a furnace, the burden is frequently calculated so that the slag shall contain 50 per cent. of silica and alumina. The following is the analysis of an ordinary slag produced at a coke furnace, and as a rule a slag having very nearly this composition is

sought at coke furnaces. It should be remembered, however, that the lime and magnesia may replace each other.

$$\begin{aligned} SiO_2 &= 34.26 \\ Al_2O_3 &= 14.34 \\ FeO &= .32 \\ CaO &= 43.57 \\ MgO &= 4.23 \\ CaS &= 3.28 \end{aligned}$$

As a rule, the determination of silica and alumina is all that is required as a guide to the practical running of the furnace. If the slag is very acid, more of the iron enters the slag as ferrous oxide, forming a fusible, scouring slag that rapidly attacks the lining.

Some of the phosphorus passes into the slag with the iron, but much of the sulphur passes into the iron and white iron usually results. On the other hand, if the slag is basic, nearly all the sulphur passes into the slag; but if very basic, the slag is very difficult to fuse and there is likely to be trouble in removing it from the furnace. If the furnace is kept hot enough to fuse the slag readily, an extravagant fuel consumption is necessary, and the iron is so overheated that it is likely to be of poor quality, and, as most of the silica passes into the slag, the iron will be low in silicon. From what has been said, it will be apparent that the composition of the slag must be governed by the desired composition and quality of the iron produced.

50. Fusibility of Slags.—Ordinary furnace slag, as we have seen, is composed of silica, alumina, lime, and magnesia; hence, each of the constituents, when alone, is infusible at the highest temperature obtained in the blast furnace, and any one of the bases combined with silica would give a slag that would be very difficult to fuse; but when all three bases are present in the proper proportion, a slag is formed that fuses at a comparatively moderate temperature. An acid slag containing considerable iron and manganese fuses readily and is very liquid when fused. A strongly basic slag is difficult to fuse and is thick and sluggish. A small

amount of magnesia is thought to increase the fusibility of slag, but a large amount is thought to raise its fusing point. There is much conflicting evidence in regard to the fusibility of slags, and the most that can be stated positively may be summed up in the three rules for the fusibility of silicates.

1. Silicates of fusible bases, such as the alkalies, are more fusible the more base they contain.

2. Infusible bases form silicates that obtain their maximum fusibility for a certain proportion, while any other proportion diminishes their fusibility.

3. In the case of the less fusible silicates, a multiple silicate is more fusible than a simple one.

51. Practical Handling of Slags.—When the slag is to be flushed off, the solid slag that has chilled at the inner part of the cinder notch is broken through, and the molten slag, which is forced out by the blast, runs down a trough to the cinder car, which stands on a track low enough for the slag to run into it. The slag is hauled in this car to the cinder dump, where it is emptied. As the slag is running down the trough, portions of it are dipped out by means of a ladle and poured into a cast-iron mold, where it is allowed to solidify. This will take but a moment, and as soon as solid may be placed on a stone or the ground to cool, while the mold is used to receive a second portion of slag. When cold, these test pieces are broken and examined, and to the experienced eye they show a great deal in regard to the condition of the furnace. If the slag is basic, the interior of the piece will be gray or white, and when strongly basic, the white or gray may extend to the surface. A normal slag is usually gray in the center and dark towards the surface. If the slag is black and glassy when broken, and thin pieces that break off are transparent or translucent, it indicates that the slag is acid in character. If the slag is brownish and dull in color, it indicates that the furnace is working cold. From these test pieces, a sample is selected and taken to the laboratory for analysis.

Various attempts have been made to utilize slag, but without much success up to the present. Some of it is used as railway ballast, and some as a road-making material. Sometimes the slag is led into a tank of water, and a jet of water is caused to impinge upon it as it flows in. This causes it to swell up, forming a brittle, spongy mass, much of which floats on the water and may be raked off. When removed it crumbles up like coarse sand, in which form it is used somewhat as a building material and in making foot-paths. A jet of steam is sometimes blown into the running slag, thus blowing it out like spun glass. In this form, it is known as slag wool, and is used to a certain extent as a non-conducting covering for steam pipes. Its use in this form, however, is very limited. A method of utilization that seems to have met with considerable success in some places is to mix the granulated slag with lime, making cement of it.

CALCULATION OF BURDENS

52. When using a new mixture of stock, it is necessary to calculate the proportions of the constituents necessary to produce the desired slag, or to refer to one of the tables prepared for this purpose. If a table is used, it should be remembered that these results are obtained by making calculations with stock having a certain composition, and are therefore only approximations with stock of different composition, and should always be verified. Having once started, the charge of fuel is fixed, and this remains the same, while the ore and limestone are varied as circumstances may require. What burden a furnace will carry with a given weight of fuel depends on the fuel itself and on the ore to be smelted. Methods have been given for the calculation of the weight of ore to be charged with a given weight of fuel, from the analysis of the ore and fuel, but as so much depends on the physical structure of the fuel, the only way to determine this accurately is by an actual trial in the furnace. After having fixed the weights of fuel and ore to be used, the weight of limestone to be added may be

found by referring to a table or by calculation, and then the correctness of this weight may be checked by the method of verification to be given; or, we may assume a weight of stone and verify it, and if the result is not what we wish, we can change the weight of stone as the result of the calculation indicates to be necessary. We prefer to calculate the weight of stone and then to verify this as follows:

Let us assume that the coke in the charge is fixed at 8,425 pounds. We must allow for 5 per cent. loss due to moisture, dust, etc.; hence, this would give us 8,000 pounds as a basis of calculation. Then, let us assume that this charge will carry 14,500 pounds of ore, and that the analyses of the ore, coke, and limestone are as follows:

ORE	COKE ASH
Iron = 55.0%	SiO_2 = 5.83%
SiO_2 = 10.3%	Al_2O_3 = 3.08%
Al_2O_3 = 2.6%	CaO = .28%
CaO = 2.8%	MgO = .11%
MgO = 1.9%	

LIMESTONE

SiO_2 = 3%
Al_2O_3 = 1%
CaO = 50%
MgO = 2%

Now let us assume that we wish to produce an iron containing 2 per cent. of silicon and a slag containing about 34 per cent. of silica.

In discussing slag, it was stated that some metallurgists regard the alumina in a slag as an acid, and that it was sometimes given as a rule that a slag should contain 49 or 50 per cent. of silica and alumina. For the purpose of calculation, let us assume that the alumina acts as an acid, and that we wish to produce a slag in which the sum of the silica and alumina will amount to 50 per cent. Then, arranging the constituents according to their acid or basic character, we have

ORE

<i>Basic</i>	<i>Acid</i>
$CaO = 2.8\%$	$SiO_2 = 10.3\%$
$MgO = 1.9\%$	$Al_2O_3 = 2.6\%$
Total, 4.7%	12.9%

COKE

<i>Basic</i>	<i>Acid</i>
$CaO = .28\%$	$SiO_2 = 5.83\%$
$MgO = .11\%$	$Al_2O_3 = 3.08\%$
Total, .39%	8.91%

LIMESTONE

<i>Basic</i>	<i>Acid</i>
$CaO = 50\%$	$SiO_2 = 3\%$
$MgO = 2\%$	$Al_2O_3 = 1\%$
Total, 52%	4%

$14,500 \times 4.70\% = 681.5$ pounds basic material in ore.

$14,500 \times 12.90\% = 1,870.5$ pounds acid material in ore.

$8,000 \times .39\% = 31.2$ pounds basic material in coke.

$8,000 \times 8.91\% = 712.8$ pounds acid material in coke.

Arranging these, we have

	<i>Basic</i>	<i>Acid</i>
Ore.....	681.5 lb.	1,870.5 lb.
Coke.....	31.2 lb.	712.8 lb.
Total.....	712.7 lb.	2,583.3 lb.

Thus, we find that in one charge of ore and coke we have 712.7 pounds of basic material and 2,583.3 pounds of acid matter; but we want 2 per cent. of silicon in the iron, and the ore contains 55 per cent. of iron; hence, there will be $14,500 \times 55\% = 7,975$ pounds of iron made from each charge. As silica is nearly one-half silicon, it takes about 4 per cent. of silica to yield 2 per cent. of silicon; hence, we have $7,975 \times 4\% = 319$ pounds of silica to supply silicon to the iron. This must, of course, be subtracted from the total acid

material, leaving $2,583.3 - 319 = 2,264.3$ pounds of acid matter to go into the slag. There are also 712.7 pounds of basic matter present, which will unite with an equal weight of acid matter to form a slag containing 50 per cent. of acid matter, leaving $2,264.3 - 712.7 = 1,551.6$ pounds of acid material to unite with the basic material of the limestone. The 4 per cent. of acid matter in the limestone will unite with an equal amount of basic matter, leaving $52 - 4 = 48$ per cent. of basic matter available for fluxing the acid matter of the ore and coke. As there are 1,551.6 pounds of acid matter to be fluxed by the stone, 1,551.6 pounds of basic matter of the stone will be required; and as the stone only contains 48 per cent. of available basic material, we will need $1,551.6 \div .48 = 3,233$ pounds of limestone.

This is, of course, only the amount of limestone necessary to produce a slag containing 50 per cent. of silica and alumina. We have not calculated the amount of silica alone, but with ordinary stock, when the silica and alumina compose 50 per cent. of the slag, the percentage of silica will be about right. This, however, should be verified as follows:

Considering the alumina as a base, from the analyses of the constituents already given, we have

ORE	
<i>Basic</i>	<i>Acid</i>
$Al_2O_3 = 2.6\%$	$SiO_2 = 10.3\%$
$CaO = 2.8\%$	
$MgO = 1.9\%$	
Total, <u>7.3%</u>	<u>10.3%</u>

COKE	
<i>Basic</i>	<i>Acid</i>
$Al_2O_3 = 3.08\%$	$SiO_2 = 5.83\%$
$CaO = .28\%$	
$MgO = .11\%$	
Total, <u>3.47%</u>	<u>5.83%</u>

LIMESTONE

<i>Basic</i>	<i>Acid</i>
$Al_2O_3 = 1\%$	$SiO_2 = 3\%$
$CaO = 50\%$	
$MgO = 2\%$	
Total, 53%	3%

Arranging these, we have

$$14,500 \times 7.30\% = 1,058.50 \text{ pounds basic material in ore.}$$

$$14,500 \times 10.30\% = 1,493.50 \text{ pounds silica in ore.}$$

$$8,000 \times 3.47\% = 277.60 \text{ pounds basic material in coke.}$$

$$8,000 \times 5.83\% = 466.40 \text{ pounds silica in coke.}$$

$$3,233 \times 53.00\% = 1713.49 \text{ pounds basic material in limestone.}$$

$$3,233 \times 3.00\% = 96.99 \text{ pounds silica in limestone.}$$

	<i>Basic</i>	<i>Acid</i>
Ore.....	1,058.50 lb.	1,493.50 lb.
Coke.....	277.60 lb.	466.40 lb.
Limestone....	1,713.49 lb.	96.99 lb.
Total.....	3,049.59 lb.	2,056.89 lb.

Thus, we have 2,056.89 pounds of silica in each charge. Subtracting the 319 pounds of silica that goes into the iron as silicon, we have $2,056.89 - 319 = 1,737.89$ pounds of silica to go into the slag, together with 3,049.59 pounds of basic material. Then, dividing the weight of silica by the total weight of slag-forming material, we have $1,737.89 \div 4,787.48 = 36.51$ per cent. silica.

This slag would be all right in blowing in a furnace, but would be rather acid for ordinary running, so we will need to add more limestone. From the analysis of the stock, we would judge that it would require between 600 and 700 pounds of limestone to bring the slag down to 34 per cent. of silica, so we will try 3,900 pounds of limestone next. Then, we would have

$$3,900 \times 53.00\% = 2,067 \text{ pounds basic material in limestone.}$$

$$3,900 \times 3.00\% = 117 \text{ pounds silica in limestone.}$$

Taking the figures previously obtained for ore and coke, we have

	<i>Basic</i>	<i>Acid</i>
Ore.....	1,058.5 lb.	1,493.5 lb.
Coke.....	277.6 lb.	466.4 lb.
Limestone.....	2,067.0 lb.	117.0 lb.
Total	3,403.1 lb.	2,076.9 lb.

Subtracting the 319 pounds of silica that goes into the iron, we have $2,076.9 - 319 = 1,757.9$ pounds of silica that goes into the slag, and dividing this by the total slag-forming material, we have $1,757.9 \div 5,161 = 34.06$ per cent. of silica in the slag.

CLASSIFICATION OF IRON

53. Iron is usually classified as Bessemer, basic, mill, malleable, charcoal, and foundry iron, depending on the purpose for which it is to be used; and the purpose for which it is to be used will govern its composition.

Bessemer iron is for use in the manufacture of Bessemer steel, and as practically all the phosphorus and sulphur in the iron remain in the steel, the percentage of these elements must be low. By Bessemer iron is usually meant an iron containing less than .1 per cent. of phosphorus and less than .05 per cent. of sulphur.

Basic iron is to be used in the basic process of steel manufacture. The iron should contain as little silicon as possible, as this will attack the basic linings. For the same reason the surface of the iron should be free from sand. By this process, the phosphorus is largely removed, and, consequently, basic iron may contain considerably more phosphorus than would be permissible in Bessemer iron.

Mill iron is for use in the puddling mill, for the manufacture of wrought iron. It should contain a low percentage of silicon, and the iron made when the furnace is working badly on foundry iron is sometimes used for this purpose.

Malleable iron is used for making malleable castings. It usually contains more phosphorus than Bessemer iron and less than foundry iron, and the percentages of silicon and graphitic carbon are low.

Charcoal iron is simply iron made in a furnace using charcoal as fuel. It is generally used as a foundry iron for special purposes.

Foundry iron is used in making castings, by melting it and pouring it into molds; hence, for this purpose, an iron that will readily fill the mold and will not shrink on cooling is desired. The other properties of the iron will depend on the character of the castings to be made.

54. Grading by Fracture.—When foundry iron is taken from the pig bed, it is loaded on cars, and these are placed on a trestle beside which triangular or wedge-shaped blocks of cast iron are fastened on top of strong supports. The iron is then thrown from the cars on to these blocks, breaking each pig in half, and the broken iron is piled according to the appearance of the broken surface.

No. 1 iron is dark gray in color and the grain is large and even. The iron that is a little lighter in color or having smaller grain, or in which the size of the grain is not quite so even, is called No. 2 x. If the grain is a little too small or uneven, or the iron is a little too light colored for 2 x, it is graded as No. 2 plain. No. 3 iron is close-grained, and is usually lighter colored than the other grades. This holds with iron containing less than 3 per cent. of silicon. If the iron contains over 3 per cent. of silicon, the portion of it having a fracture that would be graded as 1, 2 x, and 2 plain is graded as Scotch iron, and that having a close grain is sold as high silicon 3.

55. Grading by Analysis.—The fracture of the iron indicates, to a certain extent, the kind of castings for which it is adapted, and formerly foundrymen depended on the fracture entirely, but at present a chemist is employed at most of the large foundries, and the composition of the iron is taken into account. Recently, it has been suggested that

the fracture be disregarded and that the foundry mixtures be made to depend on the composition of the iron entirely. Those who have tried this plan report excellent results. While there has as yet been no general agreement as to what shall constitute the several grades, at least one large concern has printed specifications to govern its purchases. These specifications will probably be modified in time, but they serve well as a starting point. They are as follows:

FOUNDRY No. 1

Silicon must not be less than.....	2.50%
Sulphur must not exceed.....	.03%
Phosphorus should not exceed.....	.60%
Manganese should not exceed.....	.50%

FOUNDRY No. 2

Silicon must not be less than.....	1.95%
Sulphur must not exceed.....	.04%
Phosphorus should not exceed.....	.70%
Manganese should not exceed.....	.70%

FOUNDRY No. 3

Silicon must not be less than.....	1.35%
Sulphur must not exceed.....	.05%
Phosphorus should not exceed.....	.80%
Manganese should not exceed.....	.90%

If this method of grading should be generally adopted, both upper and lower limits will probably be adopted by general consent. At present, most foundry iron is purchased by a combination of the two methods. The purchaser orders a certain grade of iron (graded by fracture) having a certain composition.

ELEMENTS CONTAINED IN IRON

56. Carbon.—Carbon occurs in iron in at least two conditions—graphitic and combined carbon. Its affinity for iron varies with the temperature and the percentage of other elements in the iron. In ordinary pig iron, the percentage of

carbon will seldom exceed 4.5 per cent., but high manganese iron and chrome iron may contain as much as 7 per cent., and, it is claimed, even more than this.

Carbon has a remarkable power of distributing itself through iron, tending to become uniformly distributed not only through one piece, but through several pieces in contact when hot. When the iron is in the molten condition in the furnace, all the carbon is thought to be in the combined state or dissolved in the iron, but as the iron cools graphite separates throughout the iron. The formation of graphite in iron is favored by high percentages of total carbon and silicon, and is opposed by the presence of sulphur and manganese. It is generally said that graphite has little direct influence on the character of iron beyond lowering its tensile strength, but it appears to be the general experience of furnacemen that an iron containing a high percentage of graphite is darker in color and softer than one containing less of this form of carbon. Combined carbon increases the tensile strength and hardness of iron, but diminishes its ductility.

To obtain an iron with a large amount of graphite, it is necessary to have a high temperature in the hearth of the furnace and a strongly reducing atmosphere, in order that much carbon may be taken up by the iron. To obtain these conditions, the temperature of the blast should be high and the burden should be light; that is, the proportion of fuel to ore should be large. These conditions favor a high percentage of total carbon and also a high percentage of silicon, which causes much of the carbon to take the graphitic form on cooling. It is generally stated that a basic slag, on account of its refractory character, promotes the formation of graphite; but as a basic slag reduces the percentage of silicon, this statement can scarcely be considered as an established fact. An aluminous slag is probably advantageous.

To obtain an iron high in combined carbon, we may run the furnace with a heavy burden and an acid slag. This will keep the hearth at a lower temperature, so that little

silicon is reduced and the acid slag allows considerable sulphur to enter the iron, and sulphur tends to increase the percentage of combined carbon, as does also manganese.

57. Silicon.—Silicon readily unites with iron, forming iron silicide, which dissolves in the iron. Iron containing as much as 20 per cent. of silicon can be made in the blast furnace, but when more than about 6 per cent. of silicon is present, the product is known as ferrosilicon. Unlike carbon, silicon seldom occurs in iron in the uncombined state. It cannot be reduced from its combinations by either carbon or iron alone, but is reduced by the combined action of the two. Silicon diminishes the power of iron to combine with carbon, so that in the presence of a very high percentage of silicon the total carbon will be lower than if less were present, but, as we have seen, it increases the graphite by lowering the percentage of combined carbon. This property of changing combined to graphitic carbon is probably its most valuable one in relation to iron, for in this way it makes the iron softer and tends to lessen the shrinkage of castings, though the silicon itself would tend to increase this shrinkage. It tends to prevent the formation of blowholes in iron, by increasing the solubility of the enclosed gases, and makes the iron more fusible.

To produce an iron high in silicon, a high temperature in the hearth is necessary, hence, a light burden and strongly heated blast are generally employed. A slightly acid slag containing considerable alumina to make it refractory are advantageous. We should not attempt to reduce more than 25 or 30 per cent. of the silica of the stock, for extravagant fuel consumption is necessary to accomplish this, and it is better to use more silicious ores, if we wish to produce iron containing more silicon than will be furnished to the iron by this percentage.

58. Phosphorus.—Phosphorus combines with iron in all proportions up to 26 per cent. It is found in iron as phosphide of iron, or possibly as the phosphides of iron and

manganese, dissolved in the iron. It tends to prevent blow-holes, makes the metal more fluid, and is thought to prevent shrinkage on cooling, so that the metal fills the mold more perfectly; hence, a moderate amount of it is desirable in foundry iron. On the other hand, it makes the iron brittle, giving it a tendency to break under suddenly applied loads. Iron containing much of this element is treacherous, as it will sometimes bear a heavy load, and again may be broken easily. It is said to lower the point of saturation of iron for carbon. Phosphides of iron and manganese are the only compounds of this element formed in the furnace, and as both of these are soluble in iron, practically all the phosphorus in the stock goes into the iron and only a very small portion enters the slag. Consequently, if we know how much phosphorus our stock contains, we can tell almost exactly how much the iron will contain, and if a lower percentage is desired, we must use stock containing less of it.

59. Manganese.—Manganese alloys with iron in all proportions. It increases the tensile strength and fluidity of iron and makes it harder and less fusible. It has a stronger affinity for carbon, sulphur, and oxygen than has iron, and, consequently, it will remove oxygen and sulphur from iron and produce an iron with a high percentage of carbon. It prevents the formation of blowholes, by preventing boiling while cooling, and by reducing and removing oxide and silicate of iron. It unites with sulphur, forming a compound insoluble in iron, and thus, to a large extent, removes this element from iron. It is also thought to counteract the effect of other impurities in the iron, tending to prevent red shortness, but does not prevent cold shortness due to phosphorus. It tends to make sound castings, by preventing blowholes and removing oxides and silicates.

It raises the saturation point of iron for carbon and prevents the separation of this element as graphite on cooling; hence, it tends to produce an iron high in combined carbon. Iron containing much manganese is usually low in graphite and high in combined carbon. On this account,

much manganese is thought to hinder the production of high-grade foundry iron. Distinct names are given to the alloys of iron with considerable manganese. Alloys containing from about 10 to 25 per cent. of manganese are known as *spiegeleisen*, and those containing from 25 to 90 per cent. of manganese are known as *ferromanganese*. These alloys usually contain but little graphite and silicon and much combined carbon. Manganese is very difficult to reduce; hence, in making these alloys, a very hot blast and light burden are necessary. Dolomite is generally used as flux, as the magnesia makes a more difficultly fusible slag than does lime, and the slag should be basic. The fact that the slag is basic would account for the low percentage of silicon in the product; but in addition to this, manganese probably has a tendency to lower the percentage of silicon. Even though a light burden and hot blast be used and a basic slag with a high percentage of magnesia be employed, the manganese will not all be reduced, especially if the ore contains much silica, but some of it will pass into the slag, giving it a green color, and making it fluid and corrosive.

60. Sulphur.—Sulphur combines with iron in all proportions up to 53 per cent. It forms a number of sulphides of iron, but in pig iron it usually occurs as FeS dissolved in the metal.

Much sulphur makes the iron hard and brittle and prevents the separation of carbon as graphite; hence, iron containing a high percentage of sulphur also, as a rule, contains much combined carbon. A high percentage of sulphur causes blowholes, but makes the iron more fusible. An iron containing much sulphur is usually low in silicon and vice versa. This may be due to the fact that high sulphur iron is usually made when the furnace is not hot enough to produce iron high in silicon, but these two elements appear to be antagonistic in iron. Sulphur may be expelled from iron in the furnace by a number of agents, as basic slags, manganese, and calcium. The effect of magnesium in eliminating this element is a matter of dispute. Some authors say

that a magnesian slag will remove sulphur equally as well as a calcareous one, while others say sulphur will not unite with magnesium at all in the furnace. Manganese is very efficient in removing it. So strong is its affinity for sulphur, that if ferrous sulphide and manganese are fused together, the manganese will take the sulphur from the iron, uniting with it to form a slag. The sulphur in the ore is more easily removed when it exists in the form of sulphate than in sulphide, and that in the fuel is more easily expelled than that in the ore. When a very low percentage of sulphur is desired, a basic slag should be used, and if this does not give a sufficiently low percentage, poorer ore should be used in the mixture and more limestone should be added to produce a larger volume of slag.

61. Arsenic.—Arsenic will probably combine with iron in nearly all proportions, but is not one of the usual constituents of iron. Coke and limestone are usually free from this element, and few ores contain it. It is contained in some ores, however, and when present, some of it volatilizes in the furnace and some passes into the iron, where it seems to act much like sulphur. It appears to lower the saturation point of iron for carbon, to give it a white fracture, to make it red short and brittle at high temperatures, and if much is present, it makes the iron cold short.

62. Titanium.—Titanium is not one of the usual constituents of iron, but small quantities of it are always likely to be found in iron smelted from magnetite. Its effect on iron is not known, but it does not appear to be injurious. Magnetite ores are always likely to contain this element and should be examined for it. Ores containing it may be used to a limited extent, but the slag formed is much more refractory than with ordinary ores, and they are always likely to cause trouble in the furnace.

63. Copper.—Copper occasionally occurs in iron ores, and small quantities of it are sometimes found in iron,

especially in iron containing considerable manganese. A small quantity of it is not objectionable in foundry iron, but its presence should be avoided in iron to be used in the manufacture of steel, as it is said to make steel red short.

PRACTICAL SUGGESTIONS

64. Blast.—A certain amount of air is needed to burn the fuel of the furnace, and as a hot blast is almost universally used, it carries heat into the furnace, and consequently, up to a certain point, the more blast that is used, the hotter will the furnace become. But as the temperature of the hearth is approximately 3,000° F. and the temperature of the entering blast is from 900° to 1,500° F., after we pass this point the blast has a cooling effect, and necessitates the use of more fuel to keep up the temperature.

At the present time the amount of blast used exceeds that necessary to produce the maximum temperature, thus securing a larger output at the expense of increased fuel consumption. Taking all things into consideration, it is more economical to drive in this way, and the rate of driving gives us the most convenient and immediate method of regulating the temperature of the furnace.

If the furnace becomes too cold, we may heat it up by reducing the number of revolutions made by the blowing engines in a minute. This will tend to raise the temperature of the furnace at once, but at the same time the stoves should be changed at frequent intervals, in order to maintain a uniform high temperature of blast. If this does not heat the furnace sufficiently, or if it becomes cold again on returning to the previous rate of driving, it indicates that too heavy a burden is being carried, and the burden should be reduced. When this new burden reaches the hearth, the old rate of driving may be resumed.

If the furnace is too hot, it may be cooled by increasing the number of revolutions of the blowing engines, and if

this does not cool it sufficiently, a little cold air may be passed in with the blast, thus reducing the temperature of the blast. If the furnace becomes too hot again when the normal rate of driving is resumed, it indicates that too light a burden is being carried, and the burden should be increased.

As we have seen, it requires a high temperature to reduce silicon; hence, the amount of silicon in the iron can be largely controlled by the blast. If the furnace is running cold, the percentage of silicon in the iron will be low. By increasing the temperature of the blast and reducing the rate of driving, the furnace will be heated so that more silicon will be reduced, and the slower rate of driving will leave the stock longer in the heated portion of the furnace, so that there is more time for the reduction of this element and consequently the next iron made will contain more of it. The same result may be obtained by using a lighter burden, but in this case no change in the percentage of silicon can be obtained until the stock charged in the new proportion has had time to reach the hearth. The rate of driving may be decreased and the burden reduced at the same time, and when the new burden reaches the hearth the old rate of driving may be resumed. On the other hand, if the iron is too silicious, this may be corrected at once by harder driving and, if needs be, by using cold air to reduce the temperature of the blast. At the same time, a heavier burden may be put on, and when this reaches the hearth, the original rate of driving may be resumed. There are many things that affect the temperature in the furnace, and as changing the rate of driving is the quickest and handiest way of regulating the temperature, the blowing engines are seldom run at the same rate for 24 consecutive hours.

65. To Detect Leaking Tuyeres.—The tuyeres are subjected to very destructive influences, and sooner or later will wear out and leak. The water passing into the hearth of the furnace chills it and injures the quality of the iron. There are several methods of detecting leaks. When a tuyere is leaking, the blast will frequently force the water

along its surface to the outside and the joint of the wall will become damp. A larger volume of gas than usual and its peculiar appearance and odor are good indications that water is entering the furnace. If in doubt about a tuyere leaking, the water may be slackened for a moment so that it has less pressure than the blast. If upon turning it on again it discharges white, it shows that the blast has entered it, and, consequently, that there must be a leak. If one end of a stick is held between the teeth and the other end placed against the tuyere pipe and the ears stopped, any flow of water into the furnace can be detected. If a cold steel bar is run into the furnace through the tuyere while the blast is off, it will show moisture when withdrawn, if the tuyere is leaking. A brass or copper tube filled with water is better than a steel bar for this purpose. It should be kept in a cool place.

66. Tuyeres Taking Blast Irregularly.—Blast may be prevented from entering tuyeres by obstructions, and more blast consequently enters the open tuyeres. This makes the furnace work faster on the side of the open tuyeres, causing slipping of the stock and an intense local heat. When the tuyeres are taking the blast irregularly, so that some are dark and others bright, we would ordinarily think that the bright tuyeres were taking blast freely while the dark ones were closed, but this may not be the case. If a large volume of blast is entering a tuyere when the heat is low, it may chill cinder on the nozzle, giving a dark tuyere, while the opposite tuyere, which is taking less blast, is bright. If the blowpipe is now tested, the dark tuyere will show its blowpipe much hotter than that of the bright tuyere, which is not receiving enough blast to chill the cinder, but merely to cause an intense local heat. This tuyere requires picking with a rod, to get an opening well into the hearth that the blast may enter. A dark tuyere and hot blowpipe show that the tuyere is taking blast freely. A bright tuyere and hot blowpipe indicate the same. A bright tuyere and cold blowpipe show but little blast and poor penetration.

A dark tuyere and cold blowpipe shows that the tuyere is closed. This may be caused by a piece of scaffold. A rod should be used to make an opening through to fresh coke, that the blast may enter. If this fails, a cartridge may be used.

Neglect of tuyeres causes increase of pressure, uneven settling of stock, scaffolding, poor iron, and the burning out of tuyeres. Large hearths require more attention to the tuyeres than do small ones, in order to secure even distribution of blast.

67. Scaffolds.—If on account of slow driving or from any other cause the stock above the fusion limit is highly heated, it becomes pasty and in passing down the boshes it is pressed against the walls and adheres to them. This hard ring on the walls holds up the stock above it, forming what is called a scaffold, while the stock passes down the center of the furnace. This causes irregular working and a small output of poor iron. The heat gradually works up through the stock above the ring on the boshes, and sometimes reduces much of the iron and forms a pasty mass of fuel and limestone, which is partially cemented together with slag. Consequently, the longer a scaffold remains in a furnace, the worse it is likely to become. When scaffolds are first formed, they may frequently be removed by charging blanks of fuel and scrap iron. If this fails, they may often be removed by charging fuel and then drawing back the tuyeres, cutting them away with a large volume of blast, allowing the ring or scaffold to come down in front of the tuyeres. If there is now sufficient fuel below the scaffold from the blanks previously charged, it will be melted, and the furnace will work regularly in a short time. If there were not sufficient fuel at the tuyeres, the scaffold coming down would chill the furnace.

When the tuyeres are taking blast irregularly and sometimes from other causes, a lump will form on one side of the furnace, holding up the stock above it, while the other side remains clear. This is known as a side scaffold. It

causes the stock to settle faster on one side than on the other, and thus may be detected by watching the way the stock settles at the top. It also frequently makes one side of the furnace shell hot. These scaffolds may frequently be removed by charging scrap on the side of the scaffold, and some material, like fine ore or anthracite, which does not take the blast freely on the other side. The quickest way to get rid of a side scaffold is to have holes in the side and bosh walls, where they are likely to occur, and as soon as they form to crack them loose with giant powder. The precaution must be taken, however, to have extra fuel in the hearth at the time, to melt them up and prevent chilling the furnace.

68. Hanging and Slipping.— Sometimes, especially when much fine ore is being used, the stock in the upper part of the furnace sticks to the walls, while that below continues to settle, leaving a space between the two portions of stock. This is known as hanging. If we continue to drive as usual, this stock may hang for some time and then suddenly slip down, causing a violent disturbance in the furnace, known as a slip or explosion. As soon as it is found that the stock is hanging, an attempt should be made to cause it to settle, so that it will not have so far to slip when it does come down. This is best accomplished by turning off the blast, which, of course, has a tendency to hold the stock up, for a few moments at intervals of about 10 minutes, until the stock comes down. If there is much iron in the hearth when the stock is caused to come down by throwing off the blast, there is always danger of its being forced up around the tuyeres and destroying them. There is also danger of slag being forced up in the same way; hence, the slag should be tapped off before throwing off the blast, and if anywhere near casting time, the iron should also be tapped off.

69. Trouble With Iron Notch.— Carelessness in closing the iron notch after casting may often cause trouble. The clay should not be forced into the tapping hole as soon as the

blast is turned off, but all the iron should be cleaned out of the hole and a little sand or loam thrown in. Then force the clay back in the hole as far as possible. If the iron is not cleaned out of the hole, the clay will chill it, and it will be necessary to drill through it before casting again. If the clay is not forced well back in the hole, the iron accumulating in the hearth will fill the part of the hole not filled by clay. The portion of molten iron that comes in contact with the cold clay at some distance from the main body of iron becomes chilled, and the next time we cast, it will be necessary to drill through this solid iron. All this can be avoided by forcing the clay well back, so that no iron can get into the back of the hole. The iron may also be chilled in this way by a leak in the cooling device. In this case, repairs are necessary to keep out the water. A solid lump sometimes forms in the hearth by difficultly fusible iron chilling on coming in contact with the clay forced in the tapping hole. When this is the case, it is best to run the furnace on to No. 3 iron, which is a good cutting iron, and thus melt out the lump.

70. Miscellaneous Matters.—From what has been said, it is evident that it is a matter of importance that we should always have sufficient power to produce any amount of blast that we may need. For this purpose, it is necessary that we have boilers enough to produce the steam necessary to run the blowing engines as fast as they may ever be required to run, and that the blowing engines themselves have sufficient capacity to produce all the blast that will ever be needed. In making calculations for the blowing engines, it should be remembered that it is estimated that in a new, well-constructed plant 20 per cent. of the blast is lost between the engines and the furnace when the blast pressure is 10 pounds per square inch, and that this leakage increases with age, and at the same time the hearth of the furnace is becoming larger, thus requiring a larger volume of blast. As the grade of iron made depends largely on even running, it is important that we should always have sufficient blowing

power to keep the furnace running evenly. Many furnaces appear to make the best iron when the hearth is being cooled down slightly from a rather high temperature, so in many places it is customary to drive a little more slowly after each cast, and if the first flush of slag shows that the hearth is hot, the number of revolutions made by the blowing engines in a minute is slightly increased, so that the hearth is cooled down gradually until time for the next cast.

One of the most important matters in making foundry iron is to have an even ore mixture and to have the stock evenly distributed in the furnace. In silicious ores, the lumps and fine ore seldom have the same composition, and the coarse and fine ore is seldom evenly mixed in the stock pile. With such ores, it is next to impossible to produce a large percentage of high-grade iron. As a rule, the best ore is cheapest in the end.



MANUFACTURE OF STEEL

(PART 1)

INTRODUCTORY

1. Definition of Steel.—While at first thought it seems to be a simple matter to define steel properly, the more familiar one becomes with the subject, the more perplexing is it to write a concise definition that will apply to the wide range of steels produced, or even to the greater part of them. Before the introduction of the modern methods of manufacture, the distinction between steel and wrought iron was sharp and well marked, and steel could then be defined as “any alloy of iron with carbon that would take a temper on quenching.” Wrought iron does not sensibly harden on sudden cooling in water from a red heat. Modern methods of manufacture, however, have produced a metal that largely partakes of the nature of wrought iron, yet is made by the same processes, that give a metal that hardens on quenching. For this reason such a classification as the above would now throw out the greater amount, or at least a very large tonnage, of the material classed and accepted by the metallurgical and commercial world as steel. The Bessemer converter and open-hearth furnace early showed an adaptability to produce a soft metal having great strength, elasticity, and ductility, capable of displacing wrought iron, and, for most purposes, far superior to it. Anything that follows is not offered as a thoroughly comprehensive definition of steel, as none can be offered that is not easily assailable and its inapplicability shown from some standpoint.

§ 33

For notice of copyright, see page immediately following the title page.

Steel may be defined as a metal produced by the complete fusion of materials in a bath, the necessary properties being given, after conversion, by additions of carbon or carbon alloys. Wrought iron may be defined as a metal produced by the partial fusion, or bringing to a pasty condition, of materials on a hearth.

"Blister," or "cementation," steel, made by soaking bars of iron, at or above a red heat, in charcoal or carbon, would seem to be a notable exception; but as this is mainly an intermediate product for remelting in crucibles, and its production being of little importance, it will be disregarded in this treatment of the subject.

2. The question of the proper classification of steels is one to which much attention has been given in the past, an international committee at one time having been selected from the metallurgical and technical societies of the principal steel-producing countries to adopt a universal classification. While much good came of their work, and strenuous efforts were made to adopt their classification, neither metallurgically nor commercially was it ever generally used.

Many theories have been advanced as to what steel is. One that is held by many practical metallurgists is that the ideal steel is an alloy of pure iron and carbon only, all other elements being regarded as impurities. From this point of view, all grades of steel can be produced by simply varying the amount of carbon; but as impurities are necessarily present, all steels contain varying, and usually very small, amounts of sulphur, phosphorus, silicon, metallic oxides, and gases, which require other additions for their neutralization or elimination. Again, special alloys are required for giving steels characteristic qualities for particular purposes: such are the nickel, tungsten, chrome, manganese, and molybdenum steel.

3. **History.**—Steel was probably first made in Asia or Northern Africa by the Chaldeans, Egyptians, or other early civilizations, by methods probably more like the crucible process than any we have record of today. In fact, a

very limited amount of steel, but of most excellent quality, is still made in India (called *Indian* or *Woots steel*) by reducing very pure ores, mixed with chopped wood, in clay crucibles heated by a charcoal fire blown by goatskin bellows. From this steel, the celebrated Indian sword blades were made, than which no finer tool steel has ever been produced.

Our interest in present methods of manufacture dates from the invention of the crucible process, in 1740, by Benjamin Huntsman, of Sheffield, England, a clockmaker dissatisfied with the quality of cementation steel in clock springs. This remained practically the only method of production for over a century, when in 1855 the Bessemer process was invented by Henry Bessemer and the regenerative open-hearth furnace by the Siemens, Messrs. Charles William and Frederick, in 1861. Not until these processes, especially the Bessemer, had produced large quantities of steel much cheaper than the crucible, did steel begin to supplant wrought iron to any great extent and thereby inaugurate the "age of steel." It is this vast tonnage of cheap steel that has rendered possible the wonderful industrial development of the world in railroad and ship building, the varied lines of engineering and construction affecting every nation of the world and the condition of each individual.

4. Processes of Manufacture.—There are only three processes for the manufacture of steel: The *crucible*, the oldest of present methods; the *Bessemer*; and the *open-hearth*. The last two were developed almost simultaneously. The Bessemer was first perfected, and for the first 35 years, or up to about 1890, led the open-hearth, both as to tonnage produced and in the perfection of methods and appliances—both metallurgical and mechanical. While the Bessemer process still produces the greater tonnage, this is the only direction in which it can claim superiority over the open-hearth. In the order of their metallurgical and commercial importance today the processes rank: first, the

open-hearth; second, the Bessemer; and third, the crucible. They will be treated in this order.

While the crucible process is of the least consequence, it holds the most distinctive field metallurgically, and one from which the others seem unlikely to crowd it. Given the same composition, it is well established that crucible steel is superior to either of the others, but owing to the much higher cost of production, its use is now restricted mainly to the making of high-grade tools, certain mining drills, parts of intricate machines, and, in general, where the first cost of the steel can be ignored.

The open-hearth process has a larger field it can claim as its own than the Bessemer. Open-hearth steel is now used for the better grades of plate steel, forgings, car axles, and structural steel. The basic open-hearth process is used where an extra soft, pure steel is required, as in plates, sheets, rods, wires, etc. Bessemer steel is used for rails, nails, tin plate, light axles, in fact, for those articles where cheapness is desired. It is, however, being rapidly replaced by steel produced by the basic open-hearth process. The basic process, by cheaper production than was possible in the acid open-hearth, makes this a formidable rival of the Bessemer and seems practically assured to largely supplant it in the next few years. Owing to lower cost of production, the Bessemer process held undisputed sway for years in all lines using a large tonnage of steel. The open-hearth gradually demonstrated its superior fitness for special lines. While both the crucible and open-hearth processes have distinctive fields, held from the cheaper metal by the superior quality of their product, the Bessemer has no field the open-hearth cannot fill, and only by lower cost does it still produce the greater tonnage. Practically all rails are as yet made of Bessemer metal, also most of the "billets and slabs" for merchant bar, tin plate, sheets, nails, and light axles; some ship and tank plate, etc.

Some of the reasons for the cheaper production by the one or the other process, for their special fields and uses, will be treated under their respective heads.

THE OPEN-HEARTH PROCESS

5. Historical.—Steel was first made by the open-hearth process in England, in 1862, in the regenerative furnace of the Siemens brothers, which was patented in 1861, but which was developed and perfected by Charles William Siemens, who is better known by his title, Sir William. This was not the first attempt to make steel on an open hearth, however, many previous experiments having been made, notably those by Josiah Marshall Heath, in 1845. But it was only with the Siemens apparatus, which gives the high temperature necessary, together with an almost perfect control of heat conditions, that success was possible. Siemens efforts were originally directed to producing steel by the reduction of iron ore in a bath of pig iron without the use of scrap; the ore, by its reduction, furnished the oxygen for oxidizing the carbon, silicon, and manganese of the pig metal.

About 1864, the Messrs. Martin, French steel makers, made steel by melting pig iron and scrap in the Siemens furnace, and patented the process. In France and some parts of Europe it is still known as the *Martin-Siemens*, or *Martin process*, but in Great Britain and America as the *Siemens-Martin*, or more generally in recent years merely as the open-hearth process. The above terms are frequently indiscriminately used, but it should be clearly understood that the Martins never laid claim to the regenerative furnace, but only to the *pig-and-scrap process* worked in the Siemens furnace, for which entire credit is due them, while the furnace is wholly a Siemens production. It is correct to speak of the Siemens-Martin process (pig and scrap), but only of the Siemens furnace.

The *pig-and-ore* (sometimes incorrectly called the *direct*) and the pig-and-scrap processes, have for years been used in combination. In the past few years, owing to the rapid expansion of the open-hearth industry, also in improvements in rolling-mill methods, the amount of available scrap has been so reduced that metallurgists have been

forced to use the pig-and-ore process, the two most successful methods of which will be considered in detail.

6. Open-Hearth Furnace.—The open-hearth furnace consists of a rectangular hearth approximately twice as long as it is wide; the term *open* simply signifies that the hearth is to be so constructed at both ends. This form is one of the oldest of metallurgical furnaces, but the regenerative principle of the Messrs. Siemens constitutes its originality and value. By *regeneration* is meant the giving up of the waste heat of the escaping gases and the temporary storing of it in such a way that the air for combustion is always preheated, or regenerated; producer gas is always preheated, but natural gas is not. By this means a very much higher temperature is obtained than is otherwise possible, as well as great fuel economy. The hearth is connected by means of the ports and vertical flues with chambers, called *regenerators*, placed at a lower level either directly under the hearth, or, preferably, set back so as to be less readily choked up by the fine dust, soot, etc. carried over by the current of escaping gases and by slag and metal, which sometimes cut through the bottom or sides of the hearth.

Four chambers—two at each end, one for gas and one for air—are built to each furnace. Each chamber is connected at the bottom with suitable flues, which have valves controlling the gas and air supply, so arranged that the currents of gas and air can be reversed at regular intervals, usually of 15 minutes; the incoming supply travels through the regenerators, through which the waste gases escaped during the previous interval. This constant reversal of the direction of gas and air, and of the ends at which they are introduced into the furnace, is kept up during the melting. Theoretically, the only limit to the temperature attainable in a regenerative furnace is the point of dissociation of hydrogen and oxygen, about 2,500° C. (4,532° F.). This point, however, can never even be approximated practically, owing to the limit set by the inability of the refractory materials to

withstand such a temperature and the rapid loss of heat by radiation at high temperatures.

7. Construction of the Open-Hearth Furnace.—Two types of furnaces are in general use: The fixed, or stationary, furnace and the tilting, or rolling, furnace. In both types the furnace proper, or melting chamber, is the same—rectangular in section and connected with regenerators, as has been explained. It is covered with an arched roof of 9 or 12 inches of the best grade of silica brick; the side walls are also made of the same material, usually 9 inches thick. Silica bricks expand, about $\frac{1}{4}$ inch to the foot in heating to a working temperature, and to partially allow for this, they are never laid close. Further allowance for this expansion is made in the construction by a system of tie-rods having turnbuckles, or nuts, so that they can be lengthened as the furnace heats and the bricks expand.

The hearth is built in a pan of heavy riveted plate steel carried on beams supported on a solid block of concrete and brick, or on heavy foundation walls, or piers, so that the weight of the furnace and charge is not carried on the regenerator arches, if these are under the furnace. Other beams are set perpendicularly along the sides and ends, their ends connected beneath and above the furnace by tie-rods. Steel rails were formerly used for this purpose, but they have been supplanted by **I** beams. These rails or **I** beams, called *buck-stays*, are connected by means of tie-rods at top and bottom and serve to keep the furnace sufficiently rigid. Without these the structure would not stand the strains due to the weight of the charge and the expansion and contraction as the temperature changes.

8. Roof.—For many years the roof of the furnace was thrown from the side walls; that is, the weight of the roof was carried by the walls, just as the weight of any arch is carried on the walls from which it springs. This construction was objectionable for many reasons, and caused serious trouble when the side walls of the furnace “cut out,” as

frequently happens, while the rest of it is good. In such cases it was practically impossible to repair the walls, and the weight of the roof soon caused them to fall. The side thrust on the walls also caused their distortion, and as they wore down this became more serious. The present method of construction obviates these objections by carrying the roof on heavy channels, in which the *skew back* (the beveled brick on which the arch starts) is placed so that almost the entire weight of the roof is carried by the two channels, thus relieving the walls. In this way, when the side walls fall in or are partially burned out, they may readily be renewed or patched (which is frequently done) without disturbing the roof. Or at the end of a run, if the roof is in good condition, other repairs necessary may be made and the old roof used for the next run. This is not general practice, as it is customary at most plants to put on a new roof for each run of a furnace.

While the construction of open-hearth furnaces varies greatly, a 40-ton stationary furnace is shown in Figs. 1 and 2. Fig. 1 is a longitudinal section of the right-hand half through the center and a side elevation of the left-hand half. Fig. 2 (*a*) is a cross-section on the line *AB* of Fig. 1. These figures illustrate a common form and show the principle of all open-hearth construction.

9. Siemens Regenerator.—The air and gas chambers are built of the same length and height and extend at right angles to the furnace hearth. The air chambers are about one and one-third times the width of the gas chambers, a greater volume of air being required than of gas. Both chambers contain checkerwork of brick, usually the best quality firebrick or silica brick, so laid as to expose a large surface to the gases. Sometimes the construction is such as to give a number of small horizontal flues in each chamber, but more generally the brick are staggered in or baffled, alternate courses being placed over the parallel passage below, in both horizontal and transverse courses. This is done to distribute the current of waste gases and



bring them more intimately in contact with the brick surfaces of the checkers, assuring a better absorption of heat and,

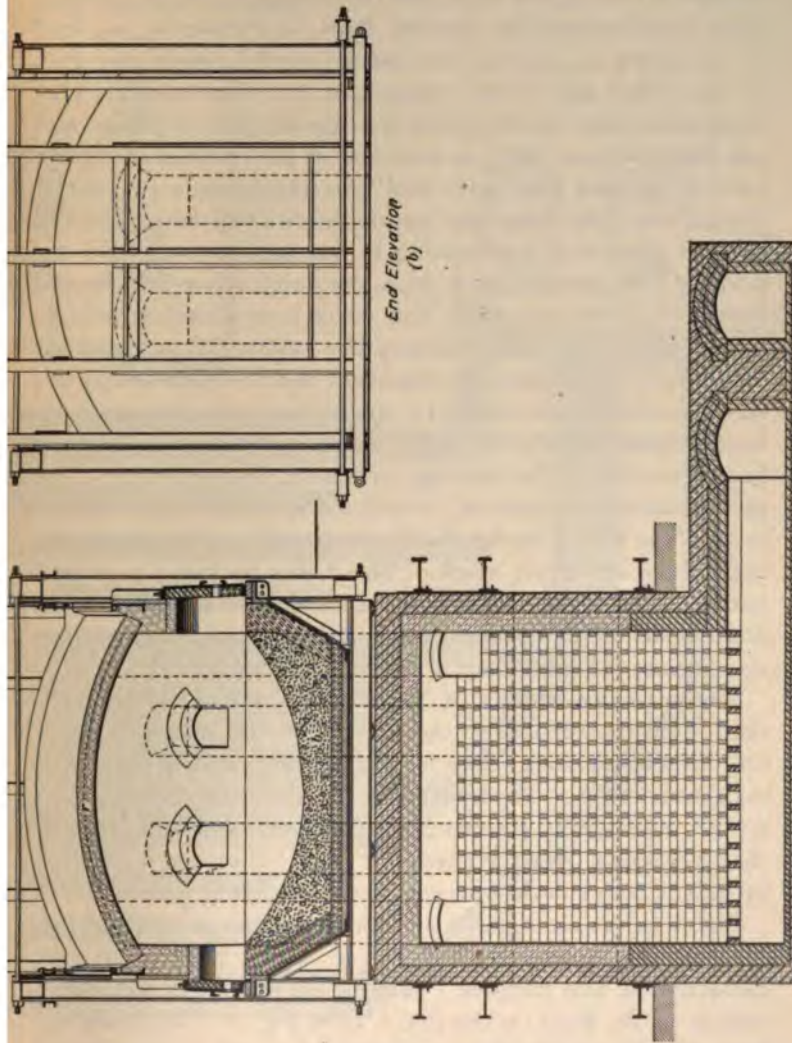

FIG. 2
Section on Line A-B
(a)

in turn, a more thorough reabsorption of this stored heat by the incoming gas and air when the currents are reversed.

In Fig. 1, *a* and *g* show, respectively, the air and gas chambers on one end containing the brick checkerwork (the opposite end is exactly the same, but the chambers are not shown); from the chambers the vertical flues, or uptakes *u_a*, *u_g*, lead to the ports *p_a*, *p_g*, the air being carried above the gas; on the other side of the furnace, at the same end, are corresponding flues leading from the opposite end of the air and gas chambers, so that on each end of the furnace there are two air uptakes and ports and two gas uptakes and ports. Frequently, one large gas uptake leads from the middle of the gas chamber, terminating in one port between the air ports. The simplest way to understand the relations and functions of the chambers and ports is to consider them as parts of one huge gas burner; the supply of gas and air comes from the respective chambers and is conducted by the tubes (uptakes and ports) to where they can mix and combustion take place, i. e., in the melting chamber, where the heat is wanted. The bottom, or hearth, is shown at *b*. The roof is made of 9-inch or 12-inch silica brick, 9-inch in this case. The flues *f* under the checkerwork connect them with the valves and draft stack. The "slag pockets" *s* extend under a part or all of the furnace; they are a continuation downwards of the uptakes, their purpose being to catch any slag, brick, etc. and keep it out of the chambers.

The left-hand section of Fig. 1 shows the elevation from the top of the furnace to the bottom of the chambers; also the beams, tie-rods, etc. for supporting and strengthening the structure. The hydraulic, or pneumatic, cylinders *c*, *c* are for raising and lowering the furnace doors by means of chains passing over the sheaves *s'*, *s'*, *s'*; they are controlled by valves conveniently placed on the charging floor.

Fig. 2 (*a*) is a cross-section through the hearth of the furnace on the line *AB* of Fig. 1. Fig. 2 (*b*) is an end elevation of the furnace. Fig. 3 (*a*) shows a horizontal section of the flues on the line *CD* of Fig. 1. It shows the flues *a* and *g* with their connections *a'* and *g'* to the air and gas valves *v_a* and *v_g*, for one end of the furnace and to the stack. The dampers in the chamber and stack flues are

shown at *d*. Fig. 3 (*b*) is a section on the line *GH*, showing the air and gas reversing valves v_a and v_g , and the regulating valves *v* for each.

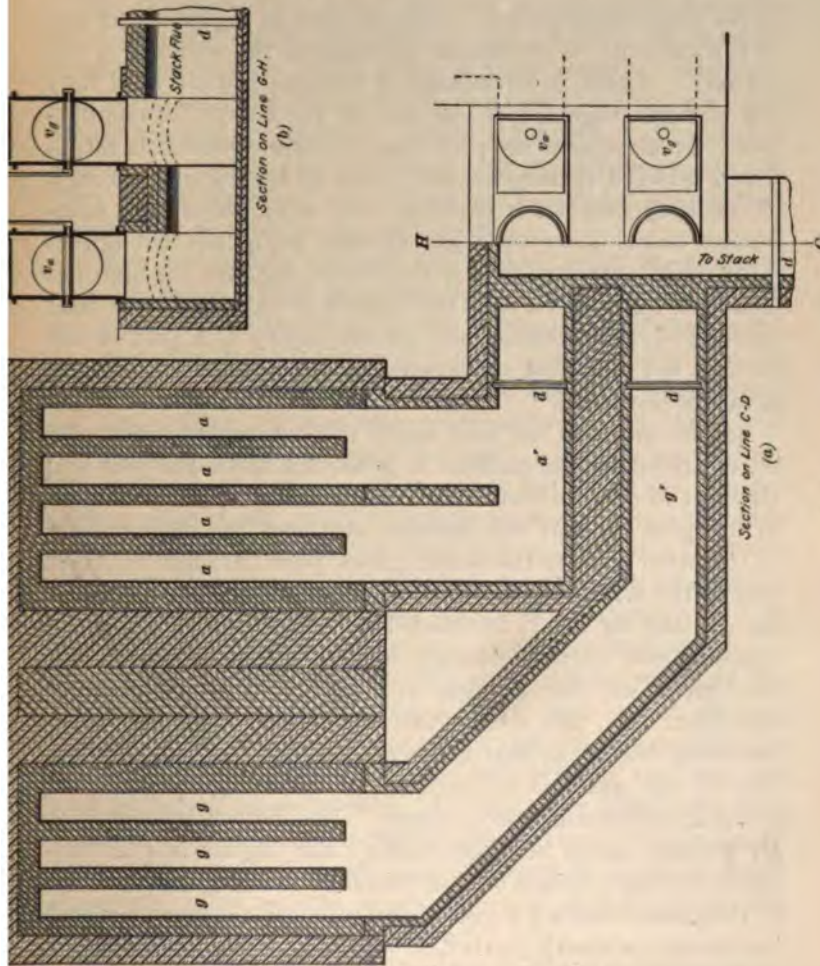

FIG. 3

Tracing the course of the gas and air, we have the gas and air entering through the valves, thence through the flues to the chambers shown in Figs. 2 and 3; the uptakes and ports

now conduct it to the melting chamber for combustion; the waste gases passing out at the opposite end through the chambers and flues to the stack. At the end of 15 minutes the reversing valves are thrown and the gas and air pass in the opposite direction. This reversal at regular intervals of the currents is continued throughout the working of the furnace. There is no mixing of the gas and air until they are brought together at one end of the hearth for combustion. It sometimes happens that a communication is established between them previous to this by the cutting through or wearing away of a division wall, when premature combustion takes place—the gas always being hot enough to burn readily after passing a very short distance through the chamber. In such a case the hearth is robbed of just that amount of heat besides the serious injury to a part of the furnace not designed or capable of withstanding the temperature produced.

As the gas and air first enter the hot regenerators, the latter are cooled, as no heat is produced until the gas and air meet in combustion in the furnace beyond. The flame here begins to heat the furnace and also the regenerators at the other end, as the waste gases pass through on their way to the stack. When the chambers, on the end at which the gas and air enter, are cooled somewhat and those on the opposite end correspondingly heated, the reversing valves are thrown so that the gas and air travel in the opposite direction. By this means the regenerators are constantly becoming hotter, so that the heat produced by the combustion of the gases is a continually increasing quantity—a thermal arithmetical progression. The hotter the gas and air (within limits here attainable), the higher is the temperature they produce on combustion. The regular reversal of the gases, which by going through the regenerators and becoming constantly hotter, produces a constant increment of temperature in the melting chamber. This is so great that without the careful regulation of gas and air a furnace would “melt itself down” in a short time. This is especially true in an empty furnace, or towards the end of a heat when

the stock is all melted and the metal hot. Such a condition can scarcely come about during the melting-down stage, as the bath is then rapidly absorbing heat.

10. Ports.—The ports are the openings or passages through which the gas and air are led into the furnace hearth, combustion taking place at their mouths. They are connected with the regenerative chambers by what are commonly termed the *uptakes*. There is no part of the furnace requiring greater care in design and construction, for on their size, proportion, and arrangement, proper combustion depends more than on any other point.

There are usually two gas and two air ports at each end of the furnace. This is varied by two gas and three air or one gas and two air, the air in any arrangement always being on the outside and above the gas, because the air is the heavier, and by having it on top of the gas as the two spread out and mix at the port ends, combustion takes place, and the flame is thrown towards the bath. By this means not only is the heat kept on the stock or bath, but the cutting action, aside from, or in connection with, the temperature produced, has much to do with the melting down of the stock. An important point is to keep the flame away from the roof, as the latter may cut out or be melted down with improper port design. Another reason for having the air on top is to avoid the oxidation that would be produced by a layer of hot air striking the stock or bath. The air and gas should meet about 2 feet above the metal, according to some authorities 5 feet, but this will bring it too near the roof in the ordinary furnace. If they meet much less than two feet above the metal, combustion can hardly begin freely before it is checked by striking the stock or bath; if much more, the most intense temperature is so high above the bath that the roof and sides suffer.

The pitch that the ports are given is an important matter; if too flat, the flame is not brought down sufficiently on the metal and combustion is too high up in the melting chamber. The tendency in such a case is for the brickwork to receive

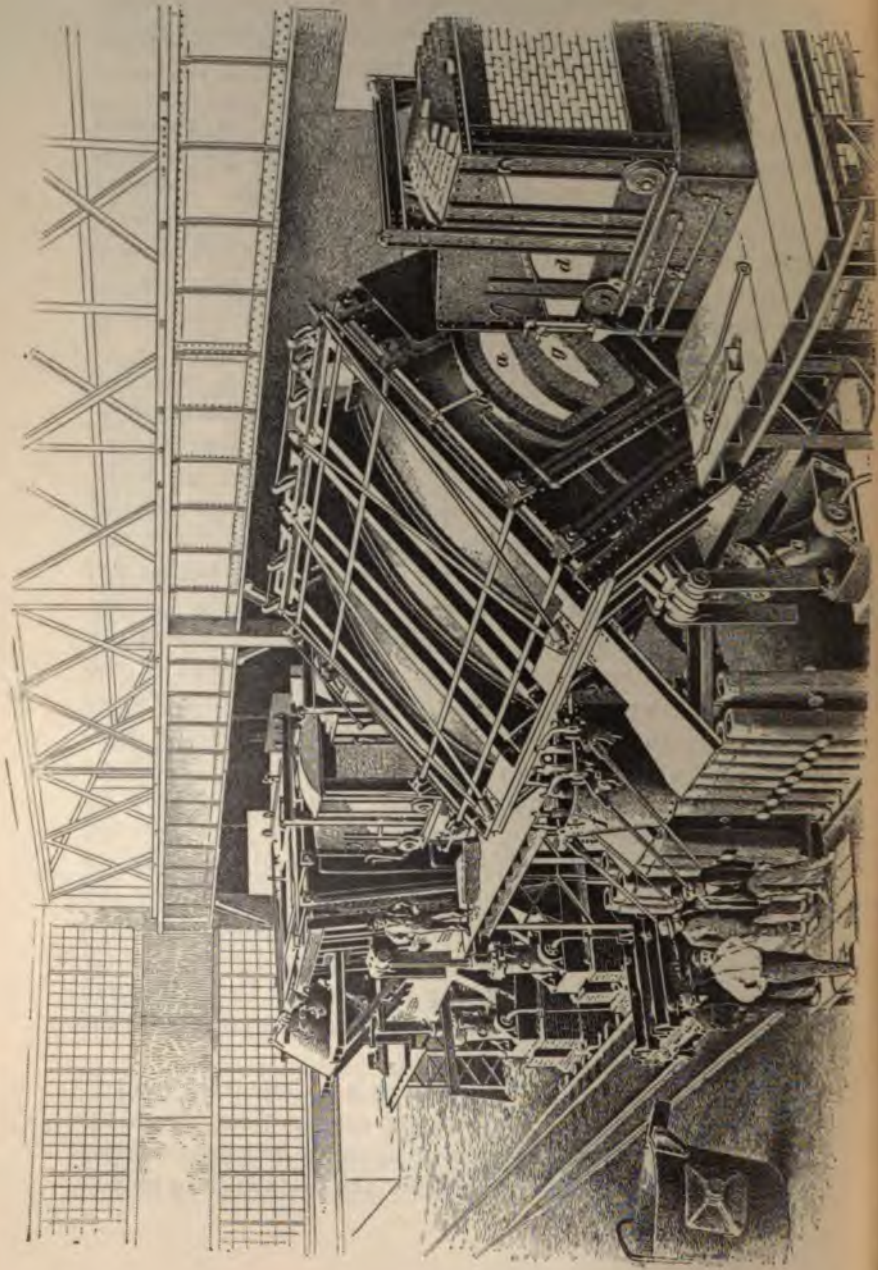

the maximum temperature rather than the normal, the steep, the flame is brought down upon the surface, and combustion is completed when the full heat value of the gas is not developed; besides, there is a tendency for the heat to concentrate in one place and not be properly distributed over the hearth.

11. Wellman Rolling Furnace.—Fig. 11 shows the Wellman rolling, or tilting, furnace—used in the position of melting position, the other in position for pouring. The furnace consists of a strongly framed body, being approximately rectangular in section, inside which the lining is built up. On the under side are fitted two sets of rollers that roll and are supported by strong cast-iron wheels. When tilting to pour off, the furnace moves forward on these rockers. The movement is accomplished by means of two cylinders *c*, placed underneath and the other ends of the piston rods attached to the piston rods. The water in the furnace, water is admitted to the top end of the cylinder, and the piston is pulled down. In case of an increase in weight of the water pressure, the furnace returns by its own weight to the level position.

The sides and ends of the furnace are built up of steel plates, work tied together and stiffened with girders, angles and tie-rods across the top of the furnace body, as shown. Each end of the furnace has openings at *g* for the passage of the gas and at *a* for air, around which is fitted a cast-iron water-cooled ring *b*, which fits into a corresponding ring in the part when the furnace is upright. The parts differ from those of the ordinary furnace in that they are built inside a strongly framed steel structure *d* and are separate from the body of the furnace, being carried on four flanged wheels. The uptakes from the regenerators are carried to about the level of the furnace bottom, and across the top of each is laid a short track on which the wheels of the port structure rest. Two cast-iron water troughs *e* extend around the upper part of the uptakes, and on the under side of the port openings are rings that project into the water troughs, thus

forming a water-sealed joint between the movable port and fixed uptake, preventing the leakage of gas and air in passing in or out of the furnace. As mentioned above, the joint between the furnace body and ports is made by water-cooled rings in each, so that both the vertical and horizontal joints of the ports allow practically no leakage.

When about to pour, each port is drawn back to avoid the friction between them and the furnace ends. The channels across the top of the port structures act as bails by which they can be picked up from their track by an overhead crane, set aside, and a fresh pair placed in position.

The regenerative chambers are arranged in the same general way as in the ordinary furnace, but are always placed back of the furnace under the charging platform. The valves for reversing and controlling the gas and air are similar to those of the fixed furnace. The lining in acid furnaces is silica brick, both on the sides and on the roof; in basic rolling furnaces, the magnesite bricks are carried in the back wall so as to be above the slag when the furnace is being poured, as the basic slag would flux with any silica brick. The tapping hole is so arranged as to be always above the level of the bath when melting; it is fitted with a heavy flanged-steel casting riveted to the furnace body; holes in the outer flange serve to readily attach either the forehearth or pouring spout, if a ladle is used for casting.

12. Forehearth. — This part of the furnace may be described as a special ladle attached to the front of the tapping hole, and is a special feature of the Wellman rolling furnace, and was developed by Mr. S. T. Wellman. It allows the steel to be poured directly into the molds without the use of a ladle. It is a box-shaped casting shown at *f*, with a flanged opening on one side corresponding to the tapping hole to which it is bolted. It is brick-lined and is provided with two pouring holes and stoppers. When the furnace is tilted, the metal flows into the forehearth and is thence tapped into the ingot molds, on cars, which are pushed along under the forehearth to be filled. Each car,

or *bogie*, usually carries two molds, which are placed the same distance apart as the pouring holes, so that two molds can be filled at once, thus facilitating the casting operation. The forehearth, while performing the function of the casting ladle to a certain extent, differs from it in that it does not become a reservoir for any considerable amount of metal, but acts more as a passage for the metal from the furnace to the ladle. A pouring spout may be readily substituted for it and the steel run into the ladle as in the ordinary practice.

13. Advantages of the Rolling Furnace.—Rolling furnaces have come into extended use in the past few years, and their future seems to be assured. Some of the reasons for this are the following:

No trouble results, nor is time lost in taking care of the tapping hole, as this is always above the level of the bath, and must be stopped simply to exclude air, hence no time is lost tapping out.

It permits the ready removal of slag. This becomes of greater consequence as impure irons, producing large amounts of slag in the basic process, are used.

The partially reduced metal is easily transferred from one furnace to another, and the slag is got rid of at the same time.

In pouring, as the joints with the ports are broken, the gas must be shut off; this at first seems a disadvantage, but is the reverse, as the cold air admitted at the ends chills the surface of the slag without affecting the temperature of the metal appreciably, and prevents boiling and violent action while pouring.

Holes form in the bottoms of all furnaces even with the most careful attention. In this event, fixed furnaces must be bailed out with rabbles, and this can frequently be only partially done, so that metal is left to be absorbed by the bottom, which becomes more or less soaked with it and oxide of iron, thus very greatly reducing its power to withstand the action of slag and metal. In the tilting furnace,

all the metal and slag can be removed after each heat, leaving the bottom dry; a considerable saving of metal results from this, as well as better preservation of the bottom.

It offers special advantages for the Talbot and Bertrand-Thiel processes, which are described later.

14. Capacity of Open-Hearth Furnaces.—The early furnaces had a capacity of from 3 to 5 tons, but they were gradually increased with the development of the process, construction, and means for readily handling the large amounts of stock and product. So far as the successful working of the furnace is concerned, there is practically no limit to the size of the furnace, but in taking care of the product, obstacles are met. The largest furnaces that have yet been constructed, in which the entire melt is withdrawn at once, take a charge of 120,000 pounds and yield about 50 gross tons of ingots. These furnaces have a melting chamber about 33 feet long and 14 feet wide. This will probably remain the standard size for large furnaces for some time. There are a number of reasons for this, not metallurgical and engineering alone, but economical as well. The prompt handling of a mass of 50 tons of molten steel within the allowable time and under the conditions of pouring is an engineering feat of such magnitude that it has been accomplished only within the last few years.

Present conditions demand that all the heat possible be saved, and for this reason steel from the furnaces must be put through the rolling mills as soon as possible, in order to take the least amount of reheating. With much larger heats than the above coming at one time, some of it will take a large amount of reheating before it can be put through the mills.

Another objection is the time required for pouring or casting (sometimes called *teeming*). Molten steel is really a delicate fluid and the limits of temperature within which it can be handled to produce good steel, or to avoid spoiling good steel, are not very wide. It is here that the skill and training of the steel maker count, in particular that of the

melter or blower, as the case may be. If so large a heat is made that it cannot be poured rapidly, it must either be too hot at the beginning to make good steel, in order to get all of it out of the ladle and avoid a "skull" or "chilled heat," or of the proper temperature at the beginning, with the result that it will be too cold at the end.

15. Gas and Air Valves.—These have been briefly spoken of, but a fuller description is demanded by their importance in furnace operations. The admission of gas and air is regulated by a simple form of throttle valve. Besides, there are reversing valves for changing the direction of gas and air. Both sets of valves are controlled from the melting floor by levers or by a hand wheel and screw, connected by suitable rods or chains. Many forms have been patented, but the ideal valve has not yet been invented, as all give more or less trouble in furnace operations. Among these troubles are the cracking or warping of the seat or the box due to the uneven temperature to which they are subjected. A deposit of soot and tar in the gas valve requires cleaning, or leaks ensue from failure of the valve to close tight. Only two of the many types will be described.

In any type of reversing valve there is a box, or outer casing, made of cast iron or steel plate within which the reversing valve proper works. Attached to the top of this box, or casing, is the regulating valve that controls the gas or air; in the former case, it is connected to the gas main, and in the latter, it opens to the air for its supply. The valve box sits over three openings; the one in the center connecting with the flue that goes to the stack; the ones on either end with flues going to the regenerators on corresponding ends of the furnace. The opening to the stack flue and chamber on one end are always connected, the position of the valve directing the gas or air through the flue on the opposite end to the corresponding regenerator, passing on up to the hearth, where combustion takes place. The waste gases are led through the regenerators on opposite ends and

back to the valves, the position of the latter directing the waste gases (admitted into the valve box from the flue beneath), downwards into the flue that is connected to the draft stack.

16. Siemens Valve.—The Siemens, or butterfly, valve is the oldest form of reversing valve and is still largely used. It is the simplest and, in many respects, the best type yet devised. Fig. 5 shows this valve in section. It consists of the outer casing, or box *a*, described above, and the elliptical tongue, or butterfly *b*, which is the valve

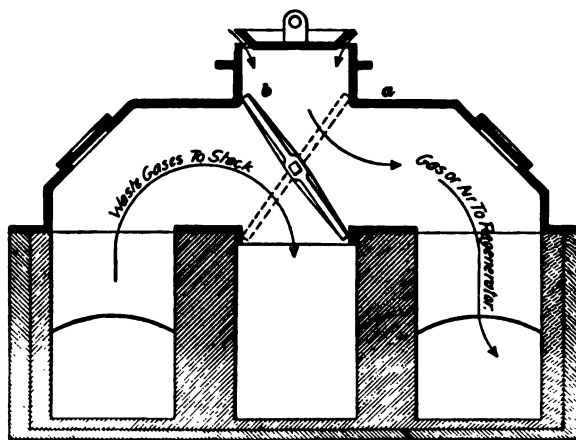

FIG. 5

proper. This is suspended by arms through its center resting in the sides of the box, one end protruding and connecting with a lever for reversing. The elliptical ends of the butterfly fit in corresponding sections of the valve box so as to make, as nearly as possible, gas-tight and air-tight joints. The objections to this type of valve are: (1) The warping and cracking of the cast-iron tongue and box so that gas leaks through to the stack, as the pull to the latter is stronger than the pressure of the gas to the furnace. (2) It is exposed to the hot producer gas on one side and the waste gases on the other, so that cracking and warping frequently

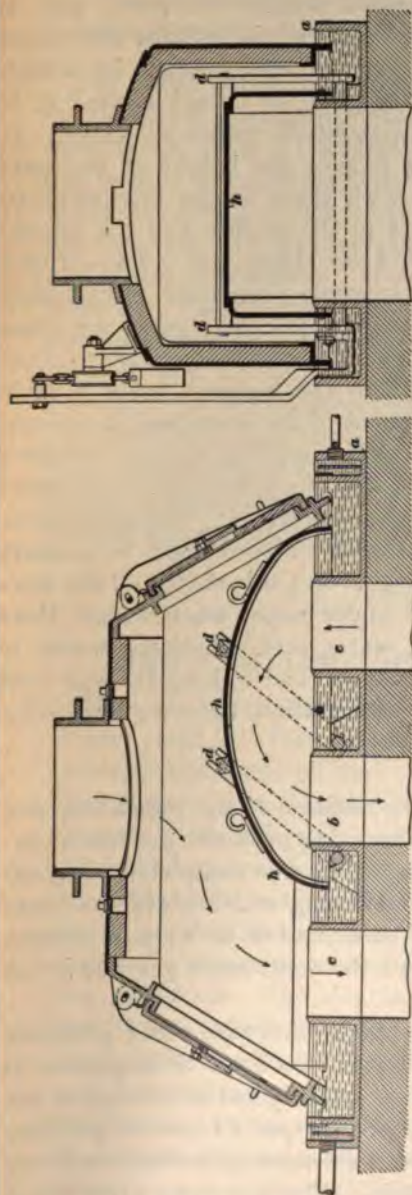

FIG. 6

occur, causing delays in changing and increasing the cost of repairs. (3) A deposit of soot and tar around the joints prevents the valve closing tightly and allows gas to leak.

While the waste gases pass to the stack for the most part at 600° to 800° F., they occasionally escape at red heat, when the valve suffers. Water cooling of both valve and box has been tried, but with little success. The advantages of this valve are simplicity and cheapness, so that even if requiring frequent repairs, they can be made quickly and at a comparatively small cost.

17. Forter Valve.

The troubles with the Siemens valve have led to an almost endless number of valves being designed to avoid its defects. Water cooling of the parts in contact with

the hot gases is the essential feature of most, and a water seal of many. The "Forster" is perhaps the most perfect of this type, the general arrangement of which is shown in Fig. 6. The base plate, or trough casting *a*, is made of cast iron and holds about $2\frac{1}{4}$ inches of water. It has three openings having flanges the height of the outside flange, corresponding with those in the brickwork to connect with the stack flue *b* in the middle and the regenerator flues *c* to the furnace on either end. Two of the openings are covered by a movable plate-steel or cast-iron hood *h*, connecting one or the other of the regenerator flues with the stack flue. This hood performs the office and corresponds to the "butterfly" in the Siemens valve. It is carried on arms *d* that lift it out of the water seal in reversing, describing an arc of a circle, moving so as to connect the opposite regenerator flue and stack flue and is dropped into the water seal in its changed position. This movement is accomplished by an outside lever connected to a shaft controlling the inside lifting arms; this shaft and the bottom edges of the hood are under water when seated, thus making a gas- or air-tight water seal. Running water is supplied to the base plate at one end to keep the seal cold and replenish the loss by evaporation, the overflow being carried off at the other end.

18. Cut-Off Valves.—In addition to the regulating and reversing valves, each furnace using producer gas has a cut-off valve so placed that the gas can be completely shut off from any furnace without interfering with any other, in case of removal or repair of the other valves or when a furnace between others connected to the same main gas flue is out for repairs.

The preceding description is of a furnace using producer gas; with natural gas as a fuel, the valve arrangement is much simplified, for, as was previously stated, this gas is not regenerated, but fed directly to the ports from the gas line. The gas valve then becomes an air valve also, both chambers being used as air regenerators. The gas valve gives much

less trouble than the air valve, as the air comes in hot, while the gas serves to cool the valve and preserve its life.

19. Dampers.—The flow of the waste gases to the stack is controlled by a damper in the stack flue, usually at the base of the stack. Dampers should also be placed in each flue leading from the reversing valves to the regenerators, for while frequently omitted, the volume of waste gases passing through the chamber determines the temperature of the gas and air for combustion. It often happens during the run of a furnace that one chamber becomes partially clogged up, lessening the draft there, so that to effect an even distribution of heat to the chambers, one or the other must be throttled; it is also sometimes advantageous to work one chamber hotter than the other. As no tight seal is necessary here, these dampers are merely rectangular steel or cast-iron plates loosely fitting in the flues, controlled by a chain and counterweight, from the charging floor.

ACID AND BASIC OPEN-HEARTH SYSTEMS

20. General Remarks.—The open-hearth process divides itself into the *acid* and *basic* systems. In the former the hearth is made of acid material—silica in the form of silica sand or silica brick; in the latter, the hearth and such portions of the side walls as the slag is likely to come in contact with are made of basic material—magnesite or dolomite—that a basic slag may be carried. The hearth is inert, taking no part in the reactions of the process, but must be made of a material to correspond to the character of the slag produced. The slag is the active agent in effecting purification, when this takes place, as in the basic process. The acid is the original open-hearth method and was practically the only one worked on any important scale until 1890; the basic is now the more important process and is becoming of even greater importance each year. The construction of the furnace, with the exception of the hearth, as noted above,

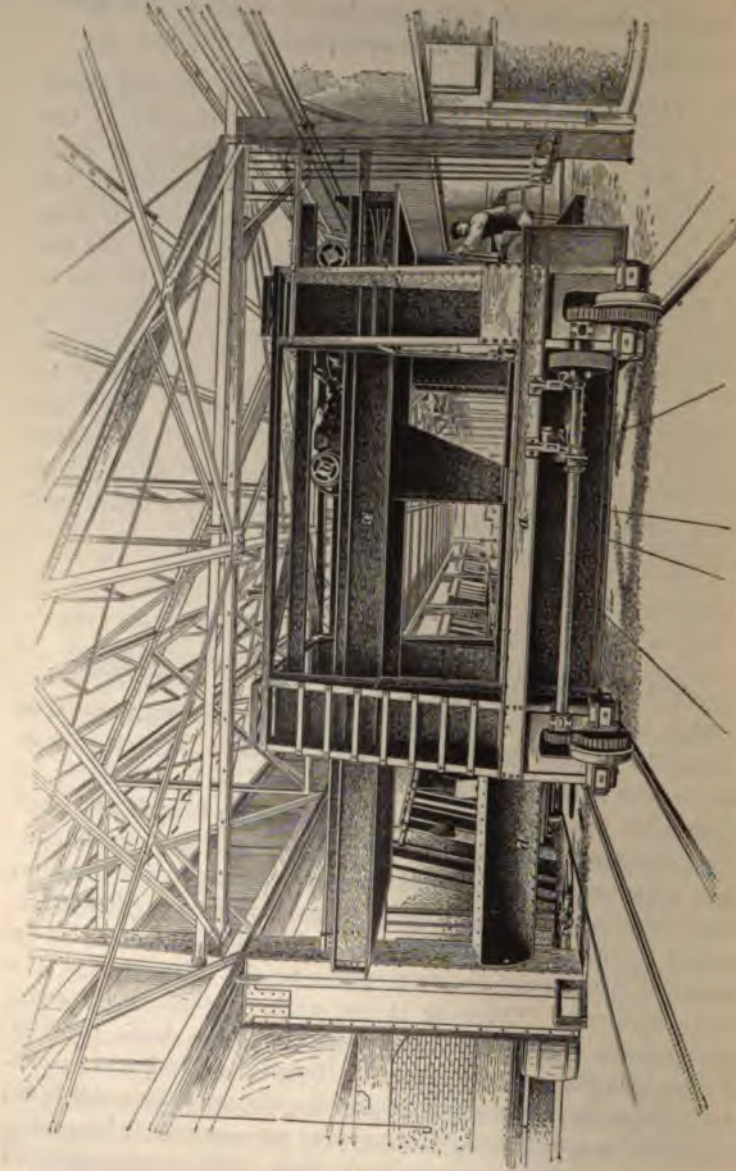

FIG. 7

is identical for either acid or basic work, the melting chamber, ports, and regenerators being the same; hence, a furnace can be changed from one to the other by substituting the one or the other lining.

21. Acid and Basic Linings.—The terms *acid* and *basic* refer to the character of the lining, or more exactly to the slag carried in the melting operation. The lining, however, determines the slag that can be carried, as there will be a reaction between the two, if of opposite character, until an approximately neutral slag is reached; in other words, the character of the slag will be changed and the lining rapidly destroyed. Hearths of neutral material—bauxite or chromite—have been unsuccessfully tried, the idea being that a basic or acid slag could then be worked. The terms acid and basic applied to open-hearth slags are not absolutely strict, but relative, as an acid slag is frequently basic enough to react with a sand bottom, while a basic slag is often acid enough to react with a magnesite bottom.

22. Wellman Charging Machine.—Formerly all the stock was charged in the furnace by hand. The pig and heavy pieces of scrap were placed on a peel and guided to the part of the hearth desired; small and light pieces were thrown directly in by hand, shovel, etc. This has been entirely superseded by the Wellman charging machine, shown in Fig. 7. It is the invention of Mr. S. T. Wellman, who has done more mechanically for the open-hearth process than any one else connected with it. The first machines were operated by hydraulic or steam power, but are now operated entirely by electricity. The machine consists of a steel frame *a* carried on four wheels on tracks on the charging floor. A movable carriage *b* is suspended on beams *c* at the top of the machine, the beams projecting beyond the main body of the machine, and over the track next to the furnaces on which stand the cars with the charging boxes *d*. To the front of the carriage are hung supports to which is attached

the peel, or ram (not shown in the figure), with a rectangular head for inserting into the casting on the end of the charging box containing the pig iron, scrap, etc. Electric motors are provided for the different motions on the track in front of the furnaces, such as moving the carriage back and forth to introduce the charge, and revolving the peel on its axis to drop the stock from the box into the furnace. The operator is carried on the movable carriage so that he has a close view of the movements of the machine and can readily control them by suitable levers conveniently placed. In operation the machine picks up the box filled with stock, is moved in front of one of the furnace doors, which is raised, the carriage advanced inserting the box in the furnace, and the ram revolved, dumping the stock. The operations are now reversed and the box replaced on the narrow-gauge car.

The charging boxes are special, rectangular, steel-plate boxes from 4 to 8 feet long and 16 to 20 inches in section, with sides slightly flaring so that the stock will readily drop out when overturned. The ends are of cast iron or steel, the end next the machine is always of cast steel, as it carries the weight of the box. The boxes are filled in the stock yard, usually on narrow-gauge cars carrying three or four boxes, or they are placed there by traveling cranes and elevated or shifted to similar tracks on the charging floor, so placed that the ends just clear the furnace buckstays. The boxes hold from a few hundred pounds of light bulky scrap to 4,000 pounds of pig iron, or heavy scrap. The charging machine has done more to reduce the cost of making steel by the open-hearth process than any single invention or appliance; at the same time, it has taken the hardest and hottest part of the furnace work from the men. In a large plant, one machine charges five or six furnaces, displacing three or four men per furnace. It is economical even in small plants of one or two furnaces.

23. Cranes.—The electric traveling crane is the standard appliance for handling the metal and slag after tapping, and for doing the *pit work*, such as placing the molds for

the steel, handling ingots, getting up stock, etc. The hydraulic swing crane was formerly used and has some advantages, such as simplicity and cheapness to install and operate and small likelihood of getting out of order, with the consequent delays and accidents. With this equipment one crane was arranged to serve two furnaces by being placed between them in a semicircular pit in front of them. In this case the steel could only be poured into molds placed in the pit. With the electric traveler the ladle of steel can be picked up and carried to any part of the casting shop for pouring or *teeming*. Where only *top-cast ingots* are made, the traveling crane offers the further advantage of pouring in molds placed on cars at any convenient place within the space covered by the crane. These can then be shifted directly to the rolling mill, avoiding the expense and delay of rehandling from the pit.

24. Ladle.—The steel is tapped from the furnace into a ladle made of heavy, riveted plate steel, lined with from 4 to 6 inches of firebrick, usually two courses, the one next to the steel shell being of a low-grade firebrick laid flat, $2\frac{1}{4}$ inches thick, the inner one of a good-grade firebrick, either laid flat or on edge, $4\frac{1}{2}$ inches thick. Sometimes only the one course is used, but this is not a safe practice for heats of from 30 to 60 tons. The steel is always poured from the bottom of the ladle, so as to keep the slag out of the metal and at the same time give better control over the casting operation. In the bottom of the ladle, near its circumference, is placed the nozzle of graphite or hard-burned firebrick. This has a cup-shaped top, tapering to a hole from 1 to 2 inches in diameter. The stream of metal is controlled by a stopper rod, which is protected by jointed firebrick sleeves and carries on its lower end a graphite plug called the *stopper head*. When pouring, the upper end of the rod is connected to a slide, on the upper outside edge of the ladle, provided with a suitable lever for opening up and shutting off the stream of metal. Fig. 8 shows the casting side of an open-hearth plant with a 60-ton traveling

ladle crane and a 40-ton ladle in position for pouring the heat.

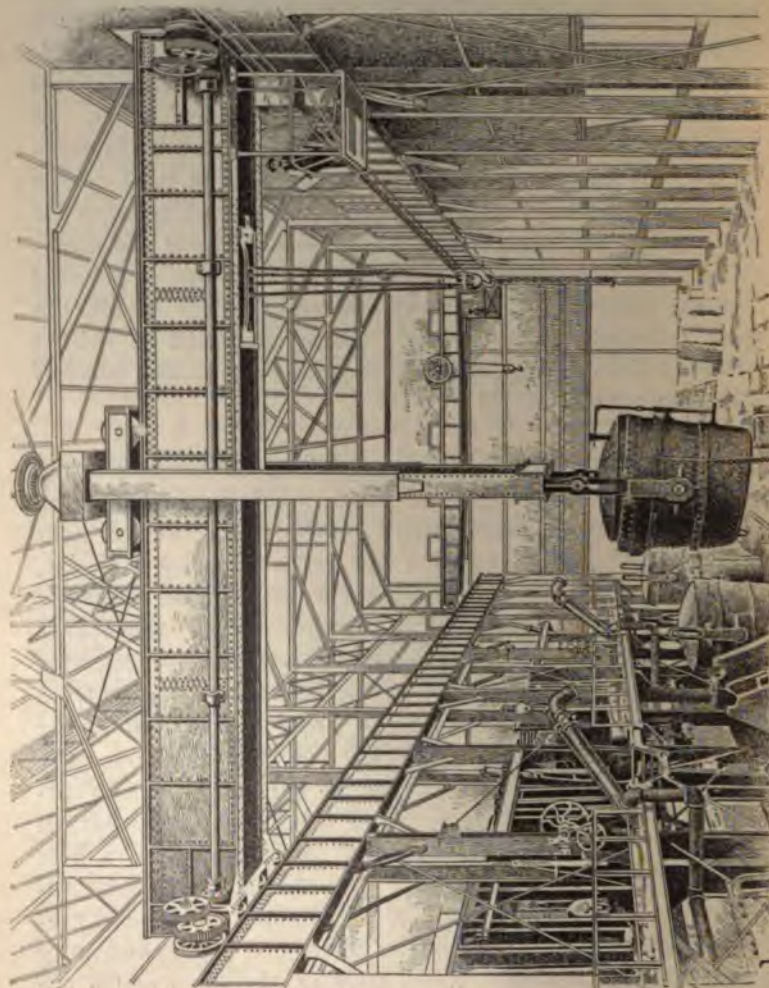

FIG. 8

Fig. 9 shows a section through an open-hearth plant. In the figure, *a* is the charging machine of the low type; *b*, the open-hearth furnace; *i*, the producer-gas main; *j*, a gas

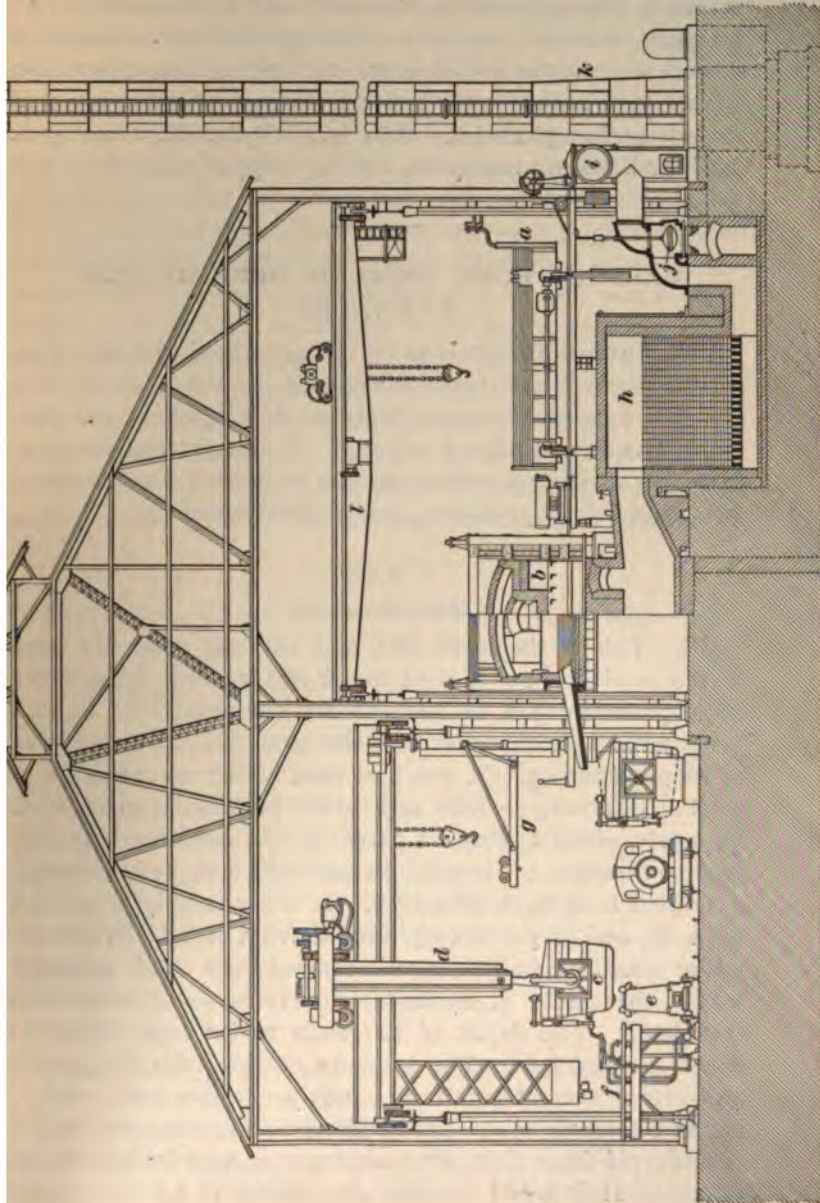

FIG. 9

valve; *h*, the regenerator chamber; and *k*, the stack. The traveling crane *l* over the charging floor is for handling stock, etc. At the left is shown the casting house, in which *d* is the ladle crane; *e*, the ladle; *c*, the molds on the car; and *f*, the pouring platform. The small hydraulic crane *g* is used for handling the spout, setting stopper, etc.

GASEOUS FUEL USED IN OPEN-HEARTH FURNACES

25. Introductory.—As previously stated, the operation of the regenerative furnace depends on the gaseous fuel, and not until the Siemens brothers developed the gas producer was this furnace a success. A regenerative furnace, for either melting or reheating, can be operated with natural gas, artificial, or producer, gas, or petroleum.

NATURAL GAS

26. This is the ideal fuel, and the one generally used where available, but it is of much less general importance than producer gas because of its comparatively limited geographical distribution and the probable uncertainty as to its permanency. It was first used in the manufacture of steel at Pittsburg in 1879, and is used principally in Western Pennsylvania and adjacent parts of Ohio and West Virginia. No one theory as to its origin is generally accepted, although a number have been advanced. It is commonly associated with oil, and is probably produced from it by distillation, under certain conditions of temperature and pressure within the earth, or by distillation from coal, or the two combined. The depth of the wells varies from 1,000 to 3,000 or 4,000 feet. The pressure at the wells frequently amounts to several hundred pounds per square inch, rendering it uncontrollable. In the lines, as furnished for use, a pressure of from 6 to 10 ounces per square inch is maintained. It is piped considerable distances to the works,

occasionally as much as 200 miles. To keep up the pressure and supply a sufficient volume of gas, special pumping engines are used. So valuable and advantageous is its use that a vast amount of capital is represented in developing territory, sinking wells, and conveying the gas by means of pipe lines to the works. While the supply is not nearly so abundant as a few years ago, yet with the more economical methods of handling and using it conservative experts claim that it will last indefinitely. As fully 50 per cent. of the open-hearth steel produced in America in 1901 was melted with it, and perhaps one-fourth of the first reheating of the total rolling-mill tonnage done with it, its importance in the manufacture of steel justifies a brief account of it.

The chief advantages in its use are: (1) Higher calorific value, with consequent increase of output; (2) greater purity, thus producing purer steel or allowing the use of poorer stock; (3) convenience and cleanliness in use.

TABLE I

Constituent	Sample			
	No. 1. Per Cent.	No. 2. Per Cent.	No. 3. Per Cent.	No. 4. Per Cent.
Carbon dioxide CO_2 ..	.80	.60		
Carbon monoxide CO	1.00	.80	.58	1.00
Oxygen O	1.10	.80	.78	2.10
Ethylene C_2H_470	.98	.98	.80
Ethane C_2H_6	3.60	5.50	7.92	5.20
Methane CH_4	72.18	65.26	60.70	57.85
Hydrogen H	20.62	26.12	29.03	9.64
Nitrogen N				23.41

27. Composition of Natural Gas.—Natural gas is essentially marsh gas, or methane CH_4 , with varying admixtures of other members of this series of hydrocarbon

gases, together with hydrogen. It usually contains from 60 to 70 per cent. of methane and 20 to 30 per cent. of hydrogen. Table I shows the analyses of four samples, giving an idea of its composition.

The high percentage of nitrogen in No. 4 is probably due to air, as natural gas seldom shows any considerable percentage of it. The average heating value of Pennsylvania and Ohio natural gas is 1,007 B. T. U. (British thermal units) per cubic foot.

28. Introduction of Natural Gas Into the Furnace. Natural gas is not regenerated (preheated), but is introduced directly from the supply main into the ports of the furnace. Regeneration was tried when the gas was first used, but the heat of the chambers decomposed the rich hydrocarbons and caused a deposition of carbon in the chambers in the form of a hard, glassy coke; it also reduced the gas to hydrogen or lower hydrocarbons, having less heating value than the original gas, besides losing the value of the deposited carbon, which would be burned on a reversal of the furnace, the products of this combustion escaping directly to the stack instead of being utilized in the furnace or chambers.

ARTIFICIAL GAS

29. Under the name artificial gas, many forms and kinds of gas have been made and used at various times, but the only one that need be given any extended consideration in connection with the manufacture of steel is *producer gas*. Other artificial gases which are made by various processes are coal gas, water gas, and oil gas, or a gas produced by a combination of any or all these processes. It is technically possible to use all these in making steel, but it is not commercially possible at this time, owing to the higher cost for producing a given calorific effect.

30. Producer Gas.—The apparatus in which what is termed the producer gas is made, is a cylindrical riveted shell of boiler steel, lined with firebrick. The early producers were made rectangular in section, but the circular section was adopted as offering many advantages, and is now wholly used. As before stated, the success of the open-hearth furnace, or of the regenerative furnace to whatever purpose applied, depends on the use of a gaseous fuel. The producer may, therefore, be properly considered a part of the furnace and its development has been simultaneous. Producer gas may be regarded as the general fuel of regenerative furnaces; natural gas, while superior in every way, can be considered only as a special fuel.

31. Siemens Producer.—Fig. 10 shows the original Siemens producer. It is a rectangular firebrick chamber

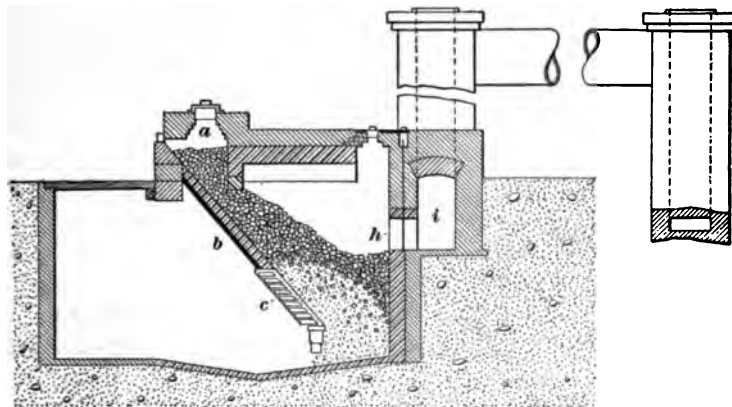
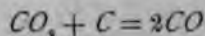

FIG. 10

having one side *b* inclined at an angle of 45° to 60° , provided with a grate *c* at the bottom. The coal is fed into the opening *a* at the top, making a thick bed as it falls to the grate, through which air is admitted to the ignited fuel, and converts a part of the carbon to carbon dioxide CO_2 , which,

in passing up through the partially incandescent mass with an insufficient air supply, is reduced to carbon monoxide CO , by taking up an additional atom of carbon



This carbon monoxide is diluted by the inert nitrogen of the air and by some of the carbon dioxide escaping reduction, and is mixed with the hydrocarbon gases and vapors distilled from the coal during its descent to the grate. The gas passes through the flue *h* to the main gas flue *i*. The gas is enriched by the decomposition of the water, which is always present, or of the steam blown in, forming carbon monoxide and hydrogen (this mixture is called *water gas*).

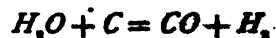

Originally, air was drawn into the producer through the grate by natural draft, later by steam being blown in with it. It was soon discovered that a more economical way was to introduce the air and steam by means of a steam jet, so arranged that the discharge of the steam draws air into the producer. A simple form of steam jet commonly used consists of an annular opening that can be enlarged or reduced by raising or lowering a plunger controlling the opening. Only a limited amount of steam can be used continuously, as the reaction forming water gas is so strongly endothermic (absorbing heat), that the temperature in the producer is lowered below the point of reduction of carbon dioxide to carbon monoxide, the decomposition of the steam thereby impoverishing the gas by carbon dioxide, and also by steam passing through the producer to the main. The chief function of the steam in the ordinary producer (not considering the manufacture of water gas proper) is to introduce the air, and at one time blowers were frequently substituted, but later abandoned for the steam jet. Some recent experiments, however, indicate that the superiority of the latter over the blower has been much overrated. It is fairly well established that a large part of the hydrogen in producer

gas comes from the decomposition of the rich hydrocarbons, and there is usually enough moisture in the air introduced to furnish the desired amount of this element.

32. Water-Seal Producers.—The principal improvement in producers since the original Siemens producer was made has been the adoption of a closed bottom. To accomplish this, the producer proper rests in a water pan, through which the ashes or clinkers are raked out. This water acts as a seal, preventing the escape of gas and the introduction of air, which occurred in the old producers while the fires were being cleaned, contributing much to their irregular working and the poor quality of gas. Instead of being flat, the grate is conical, underneath which the pipe conveying the air and steam terminates, introducing these in the center of the producer, thus insuring a more even and regular circulation within the chamber than when they are drawn in at the side. The air naturally seeks the passage of least resistance and a serious defect of older producers, where the air and steam came in at the side, was the tendency to creep up the walls of the producer without the CO_2 first formed being reduced or the steam decomposed. This also produced excessive heat, causing the ash to clinker and scaffolds to form on the side walls. The same conditions may exist to some extent in any producer improperly managed, but they are much less liable to occur if reasonable care is used.

33. Forter Water-Seal Producer.—Fig. 11 shows one of the most successful and a general type of the water-seal producer. It is the usual brick-lined shell of steel a . There are usually but two steam jets s on opposite sides to introduce the air and steam into the wind box w and under the grate. In this one, a third steam jet s' forces them into the center of the producer by means of a pipe beneath the ash-pan, with the vertical part of it terminating below the grate, as shown at b , and protected from ashes by a cone-shaped hood. The wind box has a number of air-tight doors,

through which sections of the grate can be removed to bar out any large clinkers accumulating on the bottom. The ashes slide down into water in the ash-pan *c* as the coal is burned, and are removed from time to time without interfering with the working of the producer.

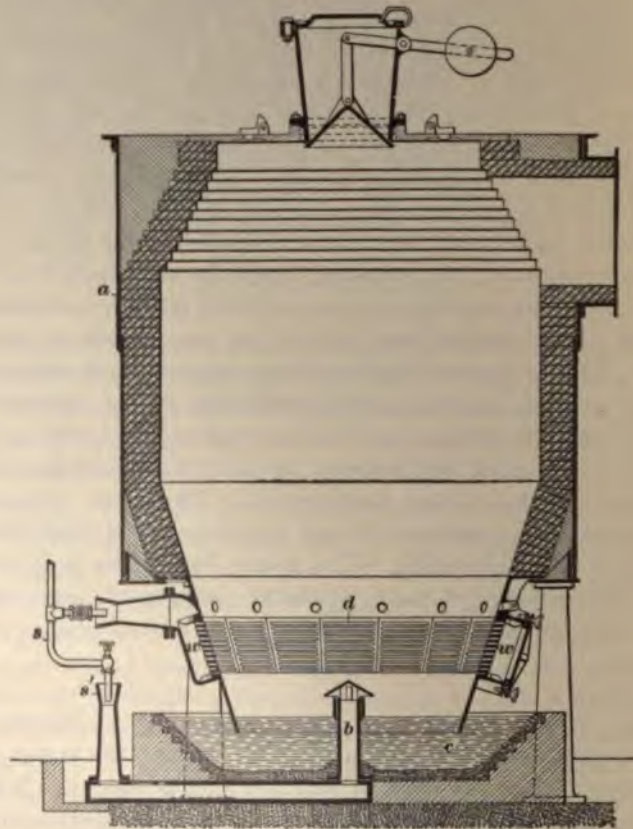

FIG. 11

34. Fraser-Talbot Mechanical Producer.—Recently a producer has been patented, called, from its inventors, the Fraser-Talbot mechanical gas producer, in which the poking or stirring is done by mechanical means. This

producer, shown in Fig. 12, is essentially the same as the ordinary water-seal type. A hollow shaft *a* passes vertically through the producer, and to this radial arms *b* are attached. This shaft has both a rotary and vertical motion; the former revolves the arms through the mass of coal, and the latter constantly changes the plane of rotation so that the horizontal arms are made to keep the whole mass thoroughly broken up for the passage of air. The shell of the producer is riveted to I beam columns *c*, which extend above the shell and form a framework, to which is attached the rotating and lifting mechanism, which is driven by an electric motor.

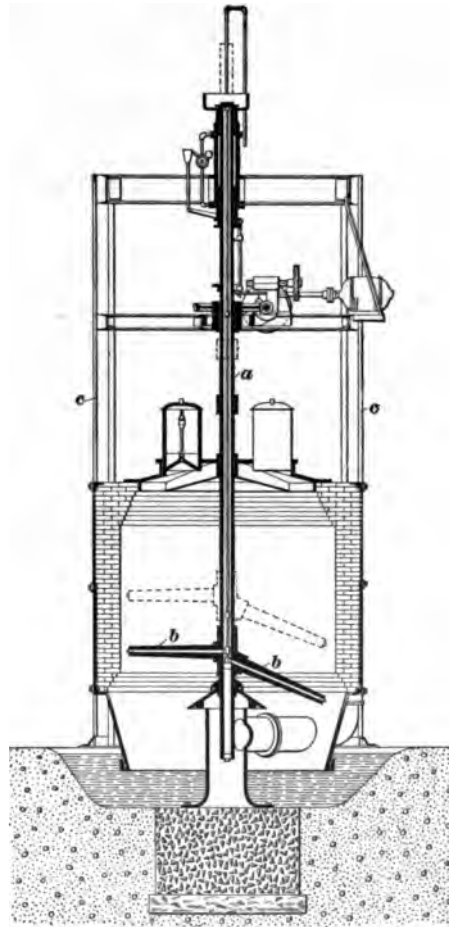

FIG. 12

The central shaft and radial arms are water cooled, as they are likely to reach a low-red heat and bend from the resistance of the bed of fuel. The advantages are in the quality and quantity of gas made per unit and the lower cost of labor. The fire is kept much more uniform than by the

best hand poking, so that the carbon dioxide formed is more certain to be brought in contact with the carbon and reduced to carbon monoxide. Holes in which the CO_2 can escape reduction cannot form in the fuel bed from insufficient poking.

TABLE II

PROXIMATE ANALYSIS OF COAL

Number of Sample	Volatile Matter. Per Cent.	Fixed Carbon. Per Cent.	Ash. Per Cent.	Sulphur. Per Cent.
1	36.20	58.20	5.60	.85
2	34.70	58.45	6.85	1.00
3	32.80	58.10	9.10	.92
4	33.75	55.00	11.25	1.02

ULTIMATE ANALYSIS OF COAL

Number of Sample	Total Carbon. Per Cent.	Hydrogen. Per Cent.	Oxygen and Nitrogen. Per Cent.	Ash. Per Cent.	Sulphur. Per Cent.
1	75.63	4.30	13.62	5.60	.85
2	76.63	4.57	10.95	6.85	1.00
3	73.92	4.73	11.53	9.10	.92
4	72.87	4.76	10.10	11.25	1.02

35. Fuel Employed for Making Producer Gas.—The fuel to make producer gas is bituminous or anthracite coal, coke, charcoal, peat, or even wood. We will consider only the first, as the others are of so little importance that they can be ignored, being used to a small extent only in steel works and under special or isolated circumstances. The coal used should be a good quality of gas coal, quite free from sulphur, having a low or moderate percentage of ash,

and of such a character as not to clinker on the grate. While practically all bituminous coals (if not too high in sulphur) may be used, there is a decided difference in their value. Proximate and ultimate analyses of four samples of good average coal for producer gas are given in Table II. The former (with the sulphur) is all that is necessary for the ordinary valuation of a coal for this purpose.

Ordinarily, the higher the coal is in volatile matter, the richer is the gas produced, as it contains more hydrocarbons. Sulphur should not exceed 1 per cent., but this depends on its condition in the coal—if it is in such a combination that it is mostly oxidized, remaining with the ash as sulphate, it may be much higher; if principally volatilized, even this amount may allow the steel to absorb too much of it from the gas.

36. Producer Reactions.—The reactions taking place in making producer gas are:

1. Carbon burned to carbon dioxide,

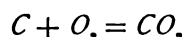

2. Reduction of the CO_2 by the hot coal to carbon monoxide,

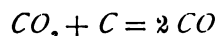

3. Incandescent carbon decomposing water vapor,

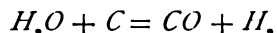

On the grate in the bottom of the producer are the ashes which serve to heat the steam and air; and, in connection with the water seal, prevent the escape of gas in cleaning the fires. Next above this is the bed of incandescent fuel, where the air and steam combine with the carbon in the above reactions. On top of this is the section where distillation occurs. The temperature is constantly lowered by the addition of fresh coal, but the heat of the bed beneath keeps up the distillation of the volatile products of the fuel. While the ash bed is sharply separated from the one above, the two upper ones overlap and their reactions occur to a considerable extent in the same region.

The reactions are not all as simple as expressed in the above equations, as a series of more or less complicated processes of dissociation and synthesis occur. Under certain conditions, part of the distillation may take place lower down in the hotter section, when the original hydrocarbons will be partly broken up and new ones formed. According to Siemens, some of the carbon deposited in the regenerators will at that temperature be taken up by the carbon dioxide and water vapor. This absorbs a large amount of heat, which is given back on combustion in the furnace, so that the calorific power of the gas is increased beyond the increment due to the elevation of the temperature of the gas alone. The production of gas is regulated nearly automatically, as the amount of gas withdrawn determines the supply of air to the grate—assuming, of course, that the producer is otherwise properly managed. One volume of carbon monoxide produced requires $2\frac{1}{2}$ volumes of air containing 2 volumes of nitrogen to pass through the grate, 1 volume of water vapor on decomposition gives 1 volume of hydrogen and 1 volume of carbon monoxide.

37. Operation of the Producer.—From the preceding description, the operation of the producer will be readily understood. The fuel is fed in through a bell and hopper, by shoveling or by chutes from overhead storage bins. As the coal becomes hot, it partially disintegrates and cakes, forming layers, through which the air is forced with difficulty, or channels are made through the coal so that a large part of the carbon dioxide first formed will not be brought in contact with carbon and reduced to carbon monoxide. To avoid this, "poke holes" are placed in the top of the producer, through which the incandescent mass is at intervals of a few minutes broken and stirred with long pokers. Ashes and clinkers are removed about every other day, depending on the quality of the fuel and the rate at which the producer is driven. Other conditions being right, the hotter and deeper the fire, the better the reactions take place. The usual depth of fire is about 6 feet, varying with

the ashes on the grate and the rate of feeding the fuel. If the contents of the fire gets much deeper than this, it is impossible to keep the bottom of it broken up, however well it is poked; if much shallower, the carbon dioxide and water vapor are not decomposed.

38. Composition of Producer Gas.—Under the conditions outlined above, the limits of composition of producer gas will usually be about as given in Table III.

TABLE III

Constituents	Minimum. Per Cent.	Maximum. Per Cent.	Good Average. Per Cent.
Carbon dioxide.....	3.0	8.0	5.5
Oxygen.....	.0	.5	.0
Ethylene.....	.0	.5	.0
Carbon monoxide...	18.0	25.0	23.0
Hydrogen.....	6.0	12.0	8.0
Methane.....	1.0	4.0	3.0
Nitrogen.....	58.0	65.0	60.5

The first two columns are not to be understood as showing analyses of individual samples, but as the usual extremes of the component gases. Such extreme samples might rarely be obtained except in the nitrogen, but even this is exceptional, as the percentage of nitrogen remains quite constant at 60 to 62 per cent., the variation occurring mainly with the other gases. Steam is always present in the gas from some of that introduced with the blast, escaping decomposition, from the moisture, and from the combined water of the coal; the amount from the first source depends on the condition of the fire. Tar is always present in the gas, varying with different coals. It furnishes considerable heat value, which is usually estimated at from 6 to 12 per cent. of the total calorific value of the gas, not all of which, however, becomes available in the furnace, as

part of the tar is precipitated in the gas main, valves, and flues. The hydrogen comes from the breaking up of the hydrocarbons and decomposition of the steam. More or less of the richer hydrocarbons are always decomposed in the gas tube, producing large quantities of soot, as follows:

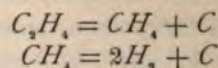

This deposition would occur in the hot chambers if not in the tube; hence, it is an unavoidable loss, and in the case of very hot gas fires it becomes excessive. The soot and tar partially close the gas tube and valves, which must be cleaned by burning out and scraping at the end of each week, and frequently require a partial cleaning during the week.

39. Calorific Value of Producer Gas.—The gas leaves the producer at a temperature of about 550° C. (1,022° F.) and is cooled to 100° to 150° C. in the tube. To avoid this loss of heat, the gas producer has been attached directly to the furnace, the gas passing from the producer directly to the ports being hot enough to burn without regeneration. This seems logical, and is correct from a theoretical standpoint, but the practical difficulties in the way of its operation have rendered it ineffectual. From the composition of the gas given in Table III, the calorific power may be calculated, but this is of no practical value to the steel metallurgist in the comparison of different gases, as conditions can seldom be sufficiently uniform in practice. For practical purposes, a ton of bituminous coal is taken as yielding 140,000 cubic feet of gas; this amount, of course, varies with the coal, the type of producer, and its working. Ordinary producer gas gives an average of 120 B. T. U. (British thermal units) per cubic foot, or 1,068 calories per cubic meter. The calculation of the calorific value from the composition does not show all the heating value in a gas from bituminous coal. Gas may be made from anthracite coal having the same composition, but the heating value will be much less, owing to the absence of solid hydrocarbons in the flame imparting

luminosity to it. The question of luminosity of the flame has much to do, in high-temperature work, with the effect produced. Between a luminous and non-luminous flame in the furnace, although the actual flame temperature resulting from the combustion of the gas may be nearly the same, there is the difference of rapid melting and entire inability to reach a steel-melting temperature. This is why anthracite coal will not produce a gas for steel making. At low temperatures there is little difference between the heating value of a luminous and non-luminous gas. The incandescent carbon or hydrocarbons cause a large amount of heat to be given out by radiation. The importance of heating by radiation in open-hearth steel melting was not recognized for a long time, and the furnace roof was built low, to confine the flame to the stock. It is now made high, and the radiative power of the luminous flame is utilized to give a large amount of the heating effect.

40. Arrangement of Producers.—Generally the producers for an entire plant are connected to one main gas flue, from which branches, controlled by suitable valves, so that any one furnace can be cut out without interfering with the others, go to each furnace. Objections to this arrangement are: (1) The furnaces nearest the producers and those on the end of the line seldom have the same gas pressure; (2) the deposit of soot and tar chokes up the tube nearest the producers, necessitating more frequent cleaning or a deficient supply; (3) it is more difficult to maintain a steady supply than if each furnace has its own producers.

The furnaces at a moderate distance from the producers receive the best gas; if too close, the gas is apt to be so hot that more of the hydrocarbons are decomposed in the regenerators, lessening the heating power and increasing the liability of the regenerators being choked with soot. On the other hand, if the gas must travel too far, it is cooled so much that carbon and tar deposit in the cooler part of the tube, producing practically the same effect as with too hot a gas.

To obviate these and other objections, some recent works have returned to an earlier plan of making each furnace independent by building separate producers. A more regular supply is assured in this way, a furnace not being affected by the varying demands of its neighbors. The claim is also made of some economy in labor and fuel, as the gas supply can be more closely adjusted to the demands of the melting house.

THE ACID OPEN-HEARTH PROCESS

41. General Remarks.—In the acid process, only stock containing relatively small amounts of phosphorus and sulphur can be used, as with an acid slag these impurities are not eliminated, or at least only to a very small extent. For this reason, the field of the acid process is limited.

42. Hearth.—The acid- or silicious-lined furnace takes its name from the silica sand or brick used for making the bottom or hearth. In almost all cases, a natural sand is used containing from 95 to 99.5 per cent. of silica, with 2.5 to 3 per cent. of alumina; the remainder consists of combined water, small amounts of lime, magnesia, and oxide of iron. All silica sands are not suitable for this purpose, a high degree of purity alone not being sufficient, much depending on the physical character of the sintered mass produced. Oxide of iron is the most objectionable impurity, as well as the commonest, in sands of the above percentage of silica.

In "making bottom," the furnace is gradually heated to nearly a working temperature, when sand is thrown on the bottom to a depth of several inches. This is allowed to sinter when more sand is thrown on in thin layers, sufficient time being allowed between each addition for perfect setting. The sides and ends are gradually thickened until the hearth assumes a saucer-like shape. The hearth finally has a thickness of from 16 to 24 inches on the bottom and sides; the latter are carried about a foot above what is to be the level of

the metal bath. Sometimes two sands of different fusing points are mixed together, the one so refractory that it will not soften at the full working temperature of the furnace, the other softening at a lower heat. By varying the percentages, a mixture may be obtained sintering or setting through a considerable range of temperature. The bottom becomes so hard that it is not eroded by the stock at the melting temperature and will resound if struck with a tool. On this quality largely depends the success of the melting.

43. Charge.—The charge will vary considerably at different plants or under varying conditions at the same plant. It may be all pig iron in the pig-and-ore process, or as low as 15 per cent. pig iron and the rest scrap. Less pig iron than this is sometimes melted when coke to furnish carbon is charged with the stock; this is exceptional practice, and is not so sure of producing good steel; it is therefore resorted to only where scrap is much more abundant and cheaper than pig iron. In the pig-and-scrap acid process, the charge is approximately one-third pig metal and two-thirds scrap. In general, the charge is so adjusted that when melted the bath contains from .3 to .6 per cent. of carbon above the point designed to tap out on. If too little pig iron is used, the bath has all the carbon, silicon, and manganese oxidized before the metal is ready to tap, when it becomes pasty and oxide of iron is rapidly formed, thus wasting the metal, by increasing the melting loss. The ferrous oxide forms ferrous silicate, which scorifies the bottom if the slag is not acid enough to absorb this additional basic compound. A further and even more serious injury is the introduction of oxides into the bath that are difficult to remove and injure the steel, making it "wild" to handle in the furnace and ladle.

The remedy for too little pig or a heat melting "low" or "soft" is simply to add pig iron to the bath—*pig up*—to give sufficient carbon and silicon to bring the bath to a boil and get the necessary temperature to tap the heat. If too much pig iron has been charged, no harm is done to the quality of

the steel, as there is then a bath high in carbon and possibly containing some silicon and manganese. These can be boiled out by the action of the flame alone, or almost universally by the addition of ore, which hastens the oxidation of the impurities. The objections to pigging up are (1) time is lost, as the addition of fresh pig lowers the temperature, the operation being held back while recovering this heat; (2) more pig is required than if the requisite amount had been added with the initial charge.

In steel works the pig iron is commonly designated as "hard" and the steel or wrought-iron scrap as "soft" stock—the terms indicating the relative amounts of carbon.

44. Method of Charging.—Generally in an acid furnace the pig iron is charged on the bottom and the scrap on top. Sometimes the pig is allowed to heat up, or partially melt, before the scrap is added. In plants where hand charging is used, the stock is gradually added, and in the judgment of many open-hearth managers, the wait between the pig and the scrap charges gives the men a rest without delaying the operation. With a charging machine, it is more common to add all the stock at once—i. e., continuously until all is in. The usual time of hand charging a furnace of 25 to 50 tons is from 2 to 4 hours; this may be considered practically a thing of the past, especially with large furnaces. With a machine, if continuous, from $\frac{1}{2}$ to $1\frac{1}{2}$ hours is required, though the time may be extended as long as for hand charging. The advantages claimed for slow charging are (1) that the stock has time to heat up as added, and melting goes on faster; (2) that the furnace is not chilled by charging the whole amount of cold stock in a short interval, thereby cooling the waste gases and the regenerators so that the gas and air are not sufficiently preheated for rapid melting. Against this view, it is maintained that in slow charging the furnace doors are up so long a time that a large amount of heat is lost by the admission of so much cold air to the melting chamber, and melting is thereby delayed; the loss from oxidation is also increased and more

gas is used. In a properly designed and working furnace, with ample regenerative capacity, there should be no serious delay from too rapid charging, there being a sufficient reserve of heat in the checkers to keep up the temperature.

On an acid bottom the pig metal is charged first, a layer of it being distributed on the bottom and banks so that the scrap is kept from contact with the hearth. All of the scrap is then charged on top of the metal. If the scrap is charged on the bottom, the waste from the formation of ferrous silicate is excessive. This basic slag takes up silica from the hearth until satisfied—i. e., becomes neutral or even acid—when it ceases to scorify the bottom. This cutting, or scorification, may be a serious matter, as a hole may be started that will cut entirely through the sand bottom. The sand will also become impregnated with iron, so that its refractory power and ability to withstand the action of metal and slag is lessened. The covering of sand on the pig iron, and the presence of silicon, carbon, and manganese, by their oxidation, prevent the pig metal from scorifying the acid bottom, as would the scrap.

45. Calculation of the Charge.—I. While the calculation and adjustment of the charge is an important matter, no fixed rule can be given that can be rigidly adhered to, as there are so many changing conditions. Chief of these is the variation in the working of the furnace, causing a greater or less loss of the elements in melting down. In a charge for an acid furnace, the composition of the pig is usually within the following limits :

Silicon.....	1.25 to 2.00%
Total carbon.....	3.00 to 4.00%
Manganese.....	.40 to .80%
Phosphorus, not over.....	.10%
Sulphur, not over.....	.05%

The phosphorus and sulphur depend on the percentage allowed in the finished steel and the scrap used. Assuming the phosphorus and sulphur in the stock to be within the

limits allowed in the steel, the calculation is based on the carbon, silicon, and manganese. The value of the latter elements depends on the oxygen consumed in their oxidation, as shown by the following simple equations:

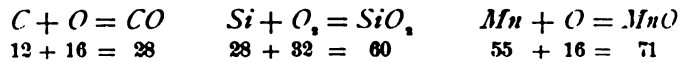

Expressed in oxygen equivalents for unit parts of the elements:

- (1) 1 part of carbon requires 1.333 parts of oxygen;
- (2) 1 part of silicon requires 1.143 parts of oxygen;
- (3) 1 part of manganese requires .291 part of oxygen.

Expressed in unit parts of oxygen:

- (4) 1 part of oxygen oxidizes .750 part of carbon;
- (5) 1 part of oxygen oxidizes .875 part of silicon;
- (6) 1 part of oxygen oxidizes 3.438 parts of manganese.

Expressing the other two elements in terms of carbon:

- (7) 1 part of silicon is equivalent to .857 part of carbon (eq. 2 ÷ eq. 1).
- (8) 1 part of manganese is equivalent to .218 part of carbon (eq. 3 ÷ eq. 1).

The carbon escapes as a gaseous product, being oxidized first to carbon monoxide and then to carbon dioxide. The silicon or silica from the stock forms with the manganese and iron from the bath a double silicate of iron and manganese, the slag. It may be assumed that in melting down the stock, from 35 to 45 per cent. of the total carbon in the charge (silicon and manganese being figured in terms of carbon) is oxidized. This, of course, can only be approximated, being affected by furnace conditions, character of stock, flame, etc. Assuming a loss in melting of 40 per cent. of the carbon in the charge, the heat to be tapped at .2 per cent. carbon, it is desired to have it melt at .8 per cent. carbon, how much pig and scrap of the following analysis must be charged?

Elements	Pig Iron. Per Cent.	Steel Scrap. Per Cent.
Carbon.....	3.75	.20
Silicon.....	1.50	.01
Manganese.....	.60	.50

Converting to terms of carbon (by equivalents 7 and 8), we have in the pig iron

1.5 per cent. of silicon $\times .857 = 1.285$ per cent. of carbon
 .6 per cent. of manganese $\times .218 = .131$ per cent. of carbon
 The pig contains..... 3.750 per cent. of carbon
 Total..... 5.166 per cent. of carbon

There is in the scrap, disregarding the silicon,

.5 per cent. of manganese $\times .218 = .109$ per cent. of carbon
 The scrap contains..... .200 per cent. of carbon
 Total..... .309 per cent. of carbon

II. The simplest way to treat this matter now is as follows: As was assumed above, the heat is to melt at .8 per cent. of carbon with a loss of .4 per cent. of the carbon in melting; then .8 per cent. is $(100 - 40)$ or 60 per cent. of the carbon required in the charge, then $\frac{.8}{.6} = 1.333$ per cent. of carbon required in the charge. The question now is how much pig iron with the equivalent of 5.166 per cent. of carbon and scrap steel with the equivalent of .309 per cent. of carbon is required to give a charge with 1.33 per cent. of carbon?

Subtracting the mean (1.333 per cent.) from the percentage of carbon equivalent in the pig iron gives the number of parts of scrap required.

$$5.166 - 1.333 = 3.833 \text{ parts of scrap.}$$

Subtracting the percentage of carbon equivalent in the scrap from the mean gives the number of parts of pig iron required.

$$1.333 - .309 = 1.024 \text{ parts of pig iron.}$$

Hence, 3,833 pounds of scrap must be charged with 1,024 pounds of pig.

$$3,833 + 1,024 = 4,857, \text{ or the total charge.}$$

The pig equals $\frac{1,024}{4,857}$ of the total charge and the scrap equals $\frac{3,833}{4,857}$ of the total charge. The calculation may be completed by proportion or expressed by percentages.

If we have a charge of 75,000 pounds, then by proportion, letting x = weight of pig required,

$$4,857 : 1,024 = 75,000 : x;$$

$$x = 15,800 \text{ pounds.}$$

Letting y = weight of scrap required,

$$4,857 : 3,833 = 75,000 : y;$$

$$y = 59,200 \text{ pounds.}$$

Solving by percentages, we have

What per cent. of 4,857 is 1,024?

$$(1,024 \times 100) \div 4,857 = 21 \text{ per cent. of pig.}$$

What per cent. of 4,857 is 3,833?

$$(3,833 \times 100) \div 4,857 = 79 \text{ per cent. of scrap.}$$

This latter method is to be preferred, as the charge is usually figured to a percentage basis.

III. For another charge, where a high-carbon steel is wanted; the heat to tap at .8 per cent. carbon and to melt 40 points (40 per cent.) above this, or at 1.2 per cent. carbon. Allowing a loss of .35 per cent. in melting down (with the higher carbon in the charge the percentage of loss will be less, though the amount of carbon lost may be as high or higher), we have 1.2 per cent. carbon \div .65 (1.00 per cent. — .35 per cent.) = 1.846 per cent. of carbon to be in the charge (silicon and manganese are figured in equivalent of carbon). How much of the same metal and scrap used in the previous heat will be required? According to the first method, we have

$$5.166 - 1.846 = 3.320 \text{ parts of scrap;}$$

$$1.846 - .309 = 1.537 \text{ parts of pig iron.}$$

Removing decimal points, $3,320 + 1,537 = 4,857$ parts represent the total charge, of which the scrap is 3,320 parts, or $(3,320 \times 100) \div 4,857 = 68$ per cent.; the pig is 1,537 parts, or $(1,537 \times 100) \div 4,857 = 32$ per cent.

IV. For another charge, suppose different stock must be used.

Elements	Pig Iron	Carbon Equivalent. Per Cent.	Rail-Steel Scrap	Carbon Equivalent. Per Cent.
Carbon....	$3.40\% \times 1.000$	3.400	$.45\% \times 1.000$.45
Silicon....	$3.15\% \times .857$	2.700	$.15\% \times .857$.13
Manganese	$.40\% \times .218$.087	$.90\% \times .218$.20
Total ...		6.187		.78

Assuming a loss of 45 per cent. of the metalloids in melting, the heat to melt at .9 per cent. carbon, then $.9 \div .55 (1.00 - .45) = 1.64$ per cent. of carbon in the charge, we have

$$6.187 - 1.64 = 5.097 \text{ parts of scrap;} \\ 1.64 - .78 = .86 \text{ part of pig.}$$

Proceeding as above, we have

$$(5.097 \times 100) \div 5,957 = 85.5 \text{ per cent. of scrap;} \\ (860 \times 100) \div 5,957 = 14.5 \text{ per cent. of pig.}$$

In the preceding calculations the sulphur and phosphorus were assumed to be such as to produce a steel within the limits called for. Both are beyond control in the acid process, the entire amount in the stock going into the finished steel, and hence are readily calculated from the stock and the steel specifications. The lower the sulphur and phosphorus in the stock, the higher is its cost, making it economical to use the least amount of the purer stock required to finish the steel within the required specifications. This will always apply to materials purchased, but in the case of a works

using scrap from another department, it will not generally be a consideration.

46. Methods of Heating.—Heating in general is accomplished by two methods: (1) By direct contact of fuel and substance, as a piece of iron in a smith's forge or the coke and ascending gases in a blast furnace in direct contact with the rest of the stock; (2) by radiation, as the heating of a room by a grate or stove or heating in a muffle furnace. In the open-hearth furnace melting is accomplished by both direct contact and radiation. In the early open-hearth construction it was the practice to build the roof very low, or even depressed, so as to keep the flame close to the stock and bath. This was later abandoned and the roof made higher, allowing free space for combustion.

47. Melting the Charge.—During the time of charging, heating up, and melting the charge, it is usual to carry a "smoky" flame, or a comparatively reducing one, less air being admitted than is necessary for complete combustion. By this means the charge, especially the scrap, is kept from oxidizing, the pig being largely protected by its impurities. This smoky flame is partially self-regulating as, coming in contact with the cold stock, the temperature is lowered sufficiently to precipitate out part of the carbon before combustion takes place. As already stated, the port construction should be such as to admit the air above the gas. So far as melting is concerned, this is mainly to keep next the metal a stratum of gas, instead of air which would increase the oxidation. This also keeps the flame from the roof and a relatively cooler stratum next to it. Irregularities on the slopes of the ports, from neglect on the part of the furnace helpers in leaving holes or allowing pieces of brick, etc. to accumulate, may deflect currents of gas or air either vertically or horizontally, so that the flame is streaked, and sections of it may be either strongly oxidizing or reducing, or part of the flame may be directed against the roof or sides of the furnace; even small tongues of flame may

start cutting of the roof which soon becomes serious if neglected.

The melting is, in the main, an oxidizing action, though more or less of the oxide of iron formed may later be reduced by coming in contact with carbon, or silicon, and manganese, if the two latter are in the bath. The metalloids are removed to some extent simultaneously, but silicon and manganese are first oxidized during the melting-down stage, or immediately thereafter. Generally, only about one-third of the carbon is oxidized in melting, owing to its smaller affinity for oxygen under the conditions. In case a charge was made up of stock very low in silicon and manganese stock, more of the carbon would be attacked while melting; or if very high, more of the two former elements would be left after melting. A certain percentage of silicon is necessary in the charge that the proper slag may be formed and to produce heat by its oxidation.

48. The function of the slag is to form a blanket or covering for the bath, protecting it from oxidation and transmitting the heat, together with the oxygen, for the removal of silicon, manganese, and carbon. No definite rule can be given for the amount of slag that should be allowed, but it should be thick enough to protect the metal and not so heavy as to offer too much resistance for the heat and oxygen to reach the bath. An acid slag will usually represent from 6 to 10 per cent. of the weight of the charge. This varies with the percentage of silicon and manganese in the charge and the conditions of melting and working of the furnace. The slag is nearly self-adjusting, or is so within quite narrow limits; that is, a charge too low in silicon (or silica) will have this deficiency supplied by the basic slag formed taking up silica from the hearth. If it contains too much silica, this will be corrected by the absorption of iron from the bath. Both are objectionable, as the first scorifies the hearth and may start a cutting of the bottom that will result in holes, and even at times in cutting entirely through. Heats have been lost in this way.

The second correction causes excessive oxidation of the bath and a consequent high melting loss. Typical acid slags have the composition shown by the analyses given in Table IV.

TABLE IV

Analyses	SiO_2 Per Cent.	MnO Per Cent.	FeO Per Cent.	$MnO + FeO$ Per Cent.
1.....	49.5	16.5	30.0	46.5
2.....	47.6	12.1	36.3	48.4
3.....	52.2	23.4	22.5	45.9
4.....	46.2	20.6	28.7	49.3

From the above table it will be noticed that the sum of MnO and FeO is quite constant. The silica does not vary over wide limits, and the necessary bases are governed by the character of the stock. If a charge is low in manganese, the required bases in the slag will be made up by a larger percentage of ferrous oxide, or vice versa. Analysis 2 shows a slag from a heat with low manganese in the stock. Analysis 3 is a slag in which a high manganese stock was melted.

49. Removal of the Metalloids, Etc.—In Art. 45, the oxygen-consuming power of the metalloids is given. This also approximately shows their affinity for oxygen, and the order in which they are oxidized, which is as follows: First, manganese; second, silicon; third, carbon. The manganese and silicon are first oxidized simultaneously during the melting-down stage, though traces of both may remain to the last of the carbon. With an excess of silicon in the charge and the temperature very high, this order of oxidation may be partly changed. At very high temperatures, carbon is oxidized in preference to silicon, the latter remaining in the bath. This cannot happen in the open-hearth furnace to the extent possible in the Bessemer converter, as the same high temperature is not reached during the oxidation of the silicon,

as this takes place much slower in the former. If the amount of silicon and manganese in the charge is more than is required by the oxygen that can be taken up during melting, then the excess of both elements remains in the bath. If ore is added, they will be oxidized before the carbon is acted on; but if boiled out by the action of the flame, the carbon will be removed along with, or partially before, the silicon. Table V shows the reduction in carbon, silicon, and manganese in two heats.

TABLE V

Number of Test	First Heat			Second Heat		
	Carbon	Silicon	Manganese	Carbon	Silicon	Manganese
1	1.00	1.28	.30	1.34	1.600	.40
2	1.00	1.12	.18	1.34	.910	.20
3	1.00	.51	.09	1.34	.260	.06
4	1.00	.33	.04	1.34	.140	trace
5	1.00	.33	trace	1.34	.080	
6	1.00	.05		1.34	.020	
7	.90	.02		1.34	.015	
8	.80	trace		1.28		
9	.55			1.10		
10	.44			1.00		
11	.25			.90		
12	.18			.68		

50. Addition of Ore.—When stock that is too high in carbon is melted, ore is added to hasten the oxidation of the metalloids. In ordinary practice this means only the oxidation of carbon, as both silicon and manganese will have been removed before the bath is ready for *oring*. However, if the latter remain at this stage, they are first attacked before the carbon is appreciably acted on, if at all.

The ore used is a red or specular hematite as free as possible from all impurities. An analysis of an ore used is as follows: Iron, 65.6; silica, 2.4; phosphorus, .03; manganese, .3.

Ore may vary somewhat from this analysis and be suitable, but as the oxide of iron is the effective agent, the higher the ore is in this, the greater is the amount of work that will be accomplished by a given weight of ore. It is essential that it be in lumps and of sufficient specific gravity to sink through the slag and the bath of metal, so as to reach the point where its work—the oxidation of the metalloids—is to be done. If in a fine condition or of a low specific gravity, part or all of it may remain in the slag with little benefit to the bath, while it will at the same time increase the amount of slag.

The following reactions take place during ore additions:

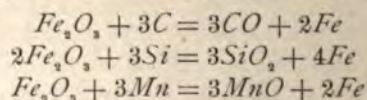

Quantitatively, in the relation of oxygen and metalloids, these reactions correspond to those given in Art. 45. In addition to its oxidizing action, each molecule of Fe_2O_3 liberates 2 atoms of iron; or 160 parts, by weight, gives 112 parts of iron. This is added to the bath, thereby increasing the yield of metal by that amount. By some authorities, it is held that the iron reduced from the ore is only partially added to the bath, the most of it going to the slag. This is purely a theoretical point and of little moment, for, as a matter of fact, if the slag requires oxide of iron, it will take it either from the bath or as it is released from the ore, possibly preferring the latter; but if ore is not added, the necessary oxide of iron will be taken from the bath, consequently the metallic iron reduced from the ore may be assumed as a net gain.

51. From the reactions given, the weight of ore required to oxidize a given percentage or weight of carbon, manganese, or silicon can be readily calculated:

160 parts, by weight, of Fe_2O_3 , oxidize 36 parts of carbon;
160 parts, by weight, of Fe_2O_3 , oxidize 42 parts of silicon;
160 parts, by weight, of Fe_2O_3 , oxidize 156 parts of manganese.

In practice this is not done even approximately, as conditions in the melting vary to such an extent that any calculation is likely to be worse than useless. If the bath is hot, the ore is acted on rapidly so that the flame has little chance to contribute its share of the oxygen; if the bath is cold, the ore must be added in small quantities, as it lowers the temperature very considerably; under this last condition the oxygen from the flame will effect the greater part of the oxidation. Besides, the action of all heats is not the same; variations in stock, gas, slag, etc. introduce conditions that make even approximate calculations of little value. However, it may be broadly stated that 2,500 pounds of ore will oxidize the carbon in a 75,000-pound charge from 1 to .1 per cent.; or 250 pounds of ore will oxidize the carbon .1 per cent. in such a charge. This is only an approximation, and about as close a one as can be given. Any silicon or manganese present has the "right of way" over the carbon and must be first satisfied by the ore. In case of a bath high in carbon, the ore first added is much less efficient in oxidizing it than at a later period. This may partly be due to the last traces of silicon and manganese, and partly to the condition of the slag, as its viscosity with high carbon retards the action of the ore.

In Table VI, which is taken from Campbell's "Open-Hearth Process," in the Transactions of the American Institute of Mining Engineers, August, 1893, the average amount of ore used in boiling down a series of heats and the oxidation of silicon, manganese, and carbon in oreing are given.

From a study of this table it will be noticed that the amount of ore is not governed wholly by the percentage of carbon in the bath after melting. Other conditions that affect it are the temperature and the way the heat takes the ore, as the physical conditions of the bath and the slag influence

the reduction effected by a given amount of ore. The judgment of the melter determines when ore should be fed, and this may not be done at the proper time, so that a series of tests, however accurate, may be affected by a number of circumstances other than the quantitative work done by the ore. In Table VI is shown one heat melting at .36 per cent. carbon, requiring no ore to bring it to .08 per

TABLE VI

Elements or Metalloids in the Heat	Pounds of Ore Used						
	1 000	850	None	500	1,000	1,500	2,000
Per Cent. } After melting.....	.54	.64	.36	.18	.32	.61	.57
Carbon { Before tapping.....	.08	.08	.08	.08	.08	.08	.08
Per Cent. } After melting.....	.02	.05	.03	.01	.04	.07	.09
Silicon { Before tapping.....	.02	.01	.02	.01	.03	.02	.02
Per Cent. } After melting.....	.09	.06	.06	.03	.05	.15	.15
Manganese { Before tapping.....	.04	.02	.04	.02	.02	.05	.03

cent. carbon, and another heat melting at .18 per cent. carbon requiring 500 pounds of ore to bring it to .08 per cent. carbon. This is explained in the one case by the temperature being too low to work the ore, the flame affecting the oxidation; and in the other by the bath being so hot that the ore is rapidly reduced. The last two heats show considerable silicon and manganese when melted, which will account for part of the ore.

52. Finishing the Heat.—In Table VI the analyses show the steel to contain .08 per cent. of carbon in all cases before tapping. If soft steel is wanted, it is necessary to boil down to this point, or nearly so. In the harder grades of steel (those higher in carbon), if other conditions are right, the bath may have the carbon but slightly reduced below the amount desired in the steel. In making the soft and medium grades of steel, those below .4 per cent. carbon, for example, the bath is either boiled down to about that shown in Table VI, or is stopped when just below the

steel specification, or, as it is called, *caught coming down*. In the first case, any additional carbon that may be required is furnished by the recarburizer or recarbonizer. There are certain advantages in both methods, and the subject will be treated under the heading "Recarbonization." At whatever percentage of carbon the heat is to be tapped, it is essential that the temperature be right at the same time. The tapping point might be represented by a given point, and the temperature and carbon content as lines, or forces, approaching it from different directions, the object being to have the two strike this point at the same time. The melter controls both within very close limits by an adjustment of the flame and the feeding of the ore. With a hot bath and relatively high carbon, ore would be fed rapidly; with the same percentage of carbon and a relatively cold bath, ore would be fed slowly or not at all, depending on the conditions.

53. The most essential requirement in a skilful melter is his ability to read temperatures accurately. No apparatus is used for determining this, the eye alone, with the aid of ordinary blue glasses to cut off the intense heat and light rays, shows it within very close limits. The *relative* and *not the actual* temperature is determined, as for all practical purposes this answers fully as well. It is necessary to estimate the temperature of both the melting chamber and the bath. The former is shown by the flame, slag, and, mainly, by the appearance of the side walls and roof. The temperature of the metal can be ascertained only by reaching it direct, and other indications are frequently misleading. The more common method is to try the heat by inserting an iron rod into the bath and stirring it back and forth, noting the rate at which the rod melts; or stir it for a given time, usually $\frac{1}{2}$ or 1 minute, withdrawing it, and observing the way the metal has cut the rod: a clean, sharp end melted to a point indicates a hot bath, while a colder bath will melt the rod much less, but more regularly, rounding it off, for the rod will be built up by the mushy, thick metal. The rod must be thrust quickly through the slag, or the latter will

coat and protect it from the action of the bath, so that the indications given by the test will be misleading. In the hands of an experienced melter, the "feel" of the metal as the rod is stirred back and forth gives an idea of the temperature, as it is more limpid and of less viscosity when hot. The surface of the bath will sometimes be as hot as desired, while portions of the bottom will be pasty from partially melted stock.

Another way is to take out a sample of the metal in a small test ladle and pour it into a mold or into a cake on the floor. The character and temperature is shown by the way it pours; its fluidity, or viscosity; the sparks given off; the skull remaining in the ladle; the contraction of the test on cooling; and general indications that are easily learned in practice, but which cannot readily be described. This test piece is also used to determine the amount of carbon, either by fracture or from drillings taken from it for a rapid-color carbon test (see *Quantitative Analysis*).

If the tests are carefully taken and uniform conditions observed in cooling, an experienced eye can usually read the carbon, as shown by the fracture, within 2 or 3 hundredths of a per cent. in samples under .2 per cent. carbon. Above this, as the carbon increases, the error in judging by fracture also increases. These tests are taken at intervals until the proper percentages of carbon and temperature are reached, when the tapping hole is opened and the metal run into the ladle. The proper recarbonizers having been added in the furnace or in the ladle, the metal is poured into molds in a pit or on cars. *

THE BASIC OPEN-HEARTH PROCESS

54. Introductory.—The basic process, either the open-hearth or the Bessemer, differs from the acid process in that stock higher in phosphorus and sulphur is treated and basic materials, usually lime, are added, to give a slag that will effect purification. As previously explained, the only

difference in the apparatus used is that the hearth is made of a basic instead of a silicious material. The idea should be clearly grasped that the hearth performs no office in effecting the purification—the dephosphorization and desulphurization—the basic slag alone being accountable for this work. It is necessary to have the hearth either of a basic or neutral material, so that the slag will not react with it.

55. Advantages of the Basic Process.—The advantages of the basic process are that a wider range of stock is made available for steel making, that purer steel may be produced, and cheaper stock used. These two statements might seem to be conflicting, as a better or purer material would not be expected from inferior stock. This view retarded the growth of the basic process to a great extent, as many users of steel refused to believe that steel made from impure materials was as good as that made with purer stock. This view, however, is now held by scarcely any one either among the producers or users. Rarely does an engineer specify acid steel to the exclusion of basic for important uses; one or two notable exceptions have recently come up where acid steel only was allowed in important engineering work, and this must be taken as the judgment of an individual engineer rather than the accepted or proved practice. The only objection that can now be raised to basic steel is the impure stock used, but the process effecting purification does not leave this a valid one. This was not always so, as defects in the process and manipulation caused the steel to be defective, and much of the earlier prejudice against basic steel was founded on fact. The present methods of manufacture, however, both from a metallurgical and engineering standpoint, make basic steel equally as well adapted as acid steel for practically every purpose. The furnace, except the hearth, and all accessories are identical with the acid process, and the steel is made from pig and ore or pig and scrap, with a lime addition, with or without ore, as in the acid.

HEARTH MATERIALS

56. Neutral Materials.—It is immaterial whether the hearth is of neutral or basic material, but in present practice it is altogether the latter, and this is all that need be considered. The neutral materials that have been used in hearths are carbon in bricks or mixed with refractory materials; bauxite; and chromite. None has been entirely successful.

Carbon is unsuitable mainly because of the affinity of the metal for it. It is readily absorbed—the hearth thus being gradually destroyed. It would be an ideal material to resist the action of the slag, but the above objection renders its use out of the question.

Bauxite is one of the most refractory substances known, but its excessive shrinkage at high temperatures causes it to crack and thus unfits it for this purpose. It is practically neutral under all conditions. It thus has two most essential points. It has been thoroughly burned and shrunk before being used, but this, by causing loss of combined water, destroyed its plasticity, which is important.

Chromite is highly infusible and withstands basic conditions in a high degree. In fact, the chief point against it is its infusibility, as it is difficult to sinter or set a bottom with it, so that erosion takes place, owing not to lack of refractoriness, but to the mechanical condition in which a hearth is left.

57. Basic Materials.—The strictly basic materials for the hearth are lime, dolomite, and magnesite.

Lime is the cheapest and most widely distributed material; it occurs in the form of limestone, or calcium carbonate $CaCO_3$. Theoretically, burned lime, or calcium oxide CaO , is well suited for hearths, but practically it does not answer, as it slakes so rapidly on exposure to the air that it cannot be kept in stock. A bottom made of it when heated would partially crumble into dust, owing to the driving out of the water and gas, and would be rapidly worn away by the metal.

Dolomite, or magnesian limestone $CaMg(CO_3)_2$, was originally much used owing to the high price of magnesite. It is abundant in many and relatively cheap in all localities, and when thoroughly burned does not absorb enough moisture to slake for some time. It has been used with tar, rosin, or other material to bind it until set by the heat. The tar is generally discarded now and the material thrown in without any binding agent. It has been made into bricks and the bottom built up with them. Bottoms have also been made by ramming in loose layers. The best method, however, is the same as making up a sand bottom, by sintering in thin layers, allowing time for each stratum to be thoroughly set.

Magnesite, or magnesium carbonate $MgCO_3$, when calcined to MgO , is the ideal material for basic hearths so far as our present knowledge of refractories goes. Practically all hearths now put in are made of it, although many dolomite hearths are still in use. Its high cost barred and retarded its use for a number of years in the basic process, but discoveries of large deposits in Austria and Greece have lessened the cost greatly. The Grecian magnesite is much the purer, and is generally considered to make the better brick, but it is not adapted for making bottoms, as it is too refractory when used alone. To lower its fusing point by the addition of silica, clay, or oxide of iron is too uncertain in results and does not give a bottom having as good physical qualities to resist wear and erosion as the calcined natural Austrian magnesite. Bottoms are wholly made of the latter and the patching done with it. The bottom is made the same as one of dolomite or silica, by setting successive layers and generally using a little basic slag to make it flux; clay may be used in place of slag, but the latter is preferable.

On the bottom of the basic hearth generally two courses of magnesite brick are laid or one of magnesite and one of chromite brick. This is done to offer greater resistance to the metal or slag should the bottom be cut through. The side walls also are built of magnesite brick until near the top of the lining, sometimes only to the foreplate, or two or

three courses above. Silica brick are used above the magnesite in the side walls and for the roof. Formerly it was considered necessary to have a neutral or passive joint between the two, as it was held that the silica and magnesite would flux. Any of the neutral or passive substances above mentioned answer, but chromite is best adapted. The idea that they will flux in the side walls has been proved erroneous, and silica brick are laid directly on the magnesite brick with no neutral body between. It is only essential that the silica walls be protected from the basic slag, and this is provided for by the bottom of magnesite being carried on the sides and ends above the slag level when the charge is melted.

58. Charge.—In regard to the metal, the charge differs from an acid charge only in that more pig iron can be, and usually is, melted. This is owing to the fact that the carbon dioxide CO_2 from the limestone acts as an oxidizing agent on the elements in the bath and also that there is less objection to mixing ore with the original charge, so that more oxidation is effected during the melting-down stage. Limestone, or burned lime, is added with the charge to form the basic slag. Technically, there is no difference which is used, so far as forming a basic slag and removing phosphorus is concerned, but the furnace is the cheapest place to burn the stone; hence, the raw limestone is almost universally used. The pig iron should be as low in silicon as possible, a maximum of 1 per cent. is the highest allowed in good practice and usually it does not exceed .75 per cent. As each pound of silicon in the pig iron requires, roughly, 15 pounds of limestone, the importance of having the silicon at the lowest possible point is apparent. The above ratio is only an approximation, as silica may come from other sources, and the percentages of phosphorus and sulphur largely determine the amount of lime to be charged. A large lime charge is objectionable from its increased cost; but especially as it means an increased amount of slag, so that the time of melting is lengthened, cutting down the output of the furnace;

extra fuel is used to form the slag and afterwards to get the heat through the heavy covering; it is harder on the furnace, as the fine dust is carried against the silica roof and over into the checkers—cutting the one and clogging the other.

59. There is somewhat greater variation in the method of charging than in the acid process. In the best practice all the limestone is charged on the bottom, the pig iron is placed on this, and then the scrap. Some prefer to charge part of the scrap on the bottom, then all or a part of the limestone, the pig iron, and the remainder of the scrap last. Others charge only a part of the stone, and as slag begins to form from the oxidation of silicon and manganese, add burned lime as needed to keep the slag sufficiently basic. The chief advantage with the lime on the bottom is the better protection it affords the latter; also, as the stone is decomposed, the CO_2 and CaO coming through the pasty mass help mechanically to bring action to the bath. The only objection to placing all the stone on the bottom is that it sometimes sticks to the basic lining, partially filling up the melting space. With proper attention from the furnace men, there should be no serious trouble from this source. A rod is used to loosen the lime as it begins to “come off the bottom.”

In recent practice, molten pig metal taken directly from the blast furnace or from a “mixer” has been used with entire success and the practice is being adopted wherever blast furnaces are operated in connection with basic open-hearth furnaces. The use of *hot metal*, as it is called, is not adapted to the acid open-hearth, as the silica hearth of the latter is rapidly scorified by charging either the molten iron, or steel scrap, directly on the bottom. In the basic process the bottom is protected by the limestone and then by whatever steel scrap is used. The molten pig iron is poured in from a ladle, carried by an overhead traveling crane, on top of the rest of the charge. The advantage of hot metal is that heats are made in much less time, as the melting time is

greatly lessened, thus increasing the output per furnace. The scrap is usually heated until it begins to "drip," or the metal may be poured in soon after the scrap is charged.

60. Calculation of the Charge.—The weights of pig, scrap, stone, and ore vary with local conditions, the character of the stock, and of the steel to be made. Whether pig or steel scrap is the more abundant or cheaper determines the percentages of these within quite wide limits—from a minimum of 30 to a maximum of 70 per cent. of the one, or the other may be used in ordinary practice. The more pig used, other conditions being the same, the more limestone is required to keep the slag basic from the silicon to be oxidized; or the higher in silicon, the more stone. Phosphorus and sulphur also require lime for their absorption; the purity of the limestone largely determines the amount needed. If high-carbon steel is wanted, more carbon must be charged, which in this case is pig iron. The ore is determined by the metalloids to be oxidized; a high pig charge means increased ore, and a minimum of pig, no ore.

Besides the above relations being considered independently, allowance must be made for their relation to each other; i. e., a large amount of stone and ore cannot be charged together, owing to the excessive foaming produced. The percentage of manganese present influences the amount of CaO required.

The following is a charge for a basic open-hearth furnace of 90,000 pounds capacity:

45 per cent. of pig iron will equal 40,500 pounds.

ANALYSIS OF THE PIG IRON

Silicon.....	.75%
Sulphur.....	.05%
Carbon.....	4.00%
Phosphorus.....	.60%
Manganese.....	.75%

55 per cent. of steel scrap will equal 49,500 pounds.

ANALYSIS OF THE SCRAP

Silicon.....	trace
Sulphur.....	.06%
Carbon.....	.12%
Phosphorus.....	.10%
Manganese.....	.50%

8 per cent. of limestone will equal 7,200 pounds.

ANALYSIS OF LIMESTONE

Silica.....	1.000%
Calcium carbonate.....	95.700%
(Calcium oxide).....	(53.600)%
Ferric oxide and alumina.....	.800%
Magnesium carbonate.....	2.400%
(Magnesium oxide).....	(1.150)%
Phosphorus.....	.006%
Sulphur.....	trace

2 per cent. of iron ore will equal 1,800 pounds.

ANALYSIS OF THE IRON ORE

Silica.....	2.500%
Iron.....	67.500%
Alumina.....	.950%
Phosphorus.....	.042%
Sulphur.....	trace
Calcium and magnesium oxides.....	.300%

The total charge usually includes only the pig iron and scrap, but sometimes the iron content of the ore used is figured in. A portion of the pig iron is usually replaced with cast-iron scrap, owing to the lower cost of the latter.

Owing to the great variability of conditions, no exact rule can be given for calculating the charge. It seldom happens that all the stock is sufficiently uniform to get more than an average analysis of it. This is generally the case with scrap, but also to some extent with the pig iron, limestone, etc. In the charge just given, in order to

show the calculation, it is assumed that the materials are uniform.

In the slags given in Table VIII, the proportion of calcium and magnesium oxides to silica is very variable. Such wide divergences are due to the other elements in the slag and to the conditions of melting. But, fortunately, even with the rest of the composition the same, the ratio of calcium and magnesium oxides to silica may vary greatly, so that no exact calculation is necessary, or even possible. The basis of the calculation is the silica, calcium oxide, and phosphorus. The phosphorus becomes calcium phosphate $Ca_3(PO_4)_2$ and ferrous phosphate $Fe_2(PO_4)_2$ in the slag, but sufficient calcium oxide is allowed for all the phosphorus. Assuming that this is done, we have $3CaO$ to $2P$, or 168 parts, by weight, of calcium oxide to 62 parts, by weight, of phosphorus; or 2.7 pounds of calcium oxide to 1 pound of phosphorus, this being merely the theoretical amount required for the reaction. In practice, about 3 pounds of calcium oxide is allowed for 1 pound of phosphorus. Somewhat more calcium oxide is allowed for the silica, about 4 pounds to 1 pound of silica. Applying this to the actual working charge just given, we have the following calculations:

CALCULATION FOR PHOSPHORUS

40,500 lb. pig iron at .6% phosphorus = 243.0 lb. phosphorus
 49,500 lb. scrap at .1% phosphorus = 49.5 lb. phosphorus
 Total charge contains 292.5 lb. phosphorus

(The small amount of phosphorus in the ore would be disregarded.)

292.5×3 (the ratio of CaO to P) = 877.5 pounds of calcium oxide required for the phosphorus.

CALCULATION FOR SILICON

40,500 pounds of pig iron at .75 per cent. of silicon = 303.75 pounds of silicon. $Si : SiO_2 = 28 : 60$, or the weight of silicon $\times 2\frac{1}{4}$ = weight of silica.

303.75 lb. silicon in pig iron	$\times 2\frac{1}{4}$	= 650.9 lb. silica
7,200.00 lb. limestone at 1% SiO_2		= 72.0 lb. silica
1,800.00 lb. ore at 2.5% SiO_2		= 45.0 lb. silica
Total charge contains		767.9 lb. silica

767.9×4 (the ratio of CaO to SiO_2) = 3,071.6 pounds of calcium oxide required for the silica.

Calcium oxide required for the phosphorus	= 877.5 lb.
Calcium oxide required for the silica	= <u>3,071.6 lb.</u>

Total calcium oxide required for silica and phosphorus = 3,949.1 lb.

To find the amount of limestone required, MgO is figured as CaO ; therefore, the stone is considered as containing $53.6 + 1.15 = 54.75$ per cent. of available CaO . Then, $3,949.1$ pounds $\div .5475 = 7,213$ pounds of limestone required; or, in practice, 7,200 or 7,225 pounds would be taken.

In the first experiments, trouble was encountered in keeping up the bottom, but the preceding method of charging was adopted and little or no difficulty results. From two to four heats extra per week can be made by using hot metal, which results in an increase of from 15 to 25 per cent. in the output.

61. Lime Addition.—The function of the lime, as already explained, is to form the basic slag by which the dephosphorization and desulphurization are effected. The amount of lime required depends primarily on the amount of silicon or silica in the charge; and after satisfying the SiO_2 , with an excess of lime, a further basicity is required to remove phosphorus and sulphur, depending on the percentages of the latter elements present. From 90 to 98 per cent. of the phosphorus in the charge is removed. Sulphur is more difficult and uncertain to control; frequently over half is readily removed, while, again, when conditions appear almost the same, a reduction of 10 per cent. will be hard to obtain.

It might seem that a basic slag is all that is required, and if made so from iron, this should effect purification. This would be objectionable from an economic point, but technically because a slag high in ferrous silicate, i. e., rich in FeO , has its iron readily reduced when in contact with a bath high in carbon, so that a slag sufficiently basic to keep from scorifying the bottom could not be maintained. This principle of the ready reducibility of ferruginous slags is availed of in the Talbot and Monnell open-hearth processes, the former especially making a beautiful application of this reaction. It is therefore necessary to have bases that will not be reduced, as lime or magnesia. The latter has been used, but is not so effective, as a slag high in magnesia is less fusible, more viscid, and refractory (which means more fuel), and is harder on the furnace. Lime, either as limestone $CaCO_3$, or as burned lime CaO , is the essential basic addition. Economy determines in which form this limestone is added, but it is almost always used as the raw stone. The use of the latter affects the process by the carbon dioxide liberated by the decomposition of the carbonate. This carbon dioxide acts as an oxidizing agent on the metalloids of the bath, thus allowing a larger percentage of pig iron to be used, which is an advantage when this is cheaper stock than steel scrap. The following reactions show the relation of the carbon dioxide as an oxidizer:

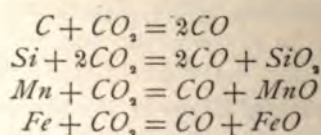

By some, the carbon monoxide working through the partly melted mass is said to cause *foaming*, a frothy action of the slag due to gases passing through it. Foaming is not only caused by carbon monoxide, but also by other gases, and by silicon under certain conditions of temperature and working. There is then danger that the metal and slag may be carried over into the ports, boil out the doors, or that the slag may come in contact with the silica side walls

of the furnace, cutting these and introducing silica into the slag. About the only remedy for foaming is by checking the action of the bath—if from carbon, shutting off the gas until the action lessens; if from silicon, making the slag more basic by the introduction of burned lime.

62. Use of Ore.—Ore is used in the basic just as in the acid process, both by charging with the stock and by feeding after melting, to oxidize the carbon, etc. The amount charged depends on the percentage and character of the pig iron used and how low the carbon is to be boiled down. The reactions of the ore are as follows:

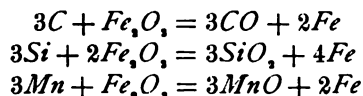

The reactions do not take place immediately, as there are a number of intermediate steps, but the ultimate results are the same. As has been stated, the carbon monoxide causes foaming and limits the amount of limestone and ore that can be charged. Both the carbon dioxide from the stone and the ore Fe_2O_3 are reduced by the carbon of the bath, the other metalloids being first oxidized (Art. 50). The ore, however, produces less carbon monoxide than does the limestone, for the same amount of carbon oxidized.

(1) Limestone,

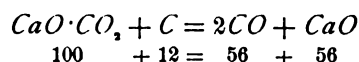

(2) Ore,

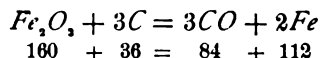

From the above equations it is seen that for every atom of carbon oxidized by the limestone, or more strictly by the carbon dioxide, 2 molecules of carbon monoxide are produced; while in the case of ore 3 atoms of carbon produce only 3 molecules of carbon monoxide. Or in the first case, each carbon atom gives 2 volumes of carbon monoxide; in

the second, each carbon atom shows only 1 volume of carbon monoxide produced. So that for a given amount of carbon monoxide produced, twice as much carbon is taken from the bath with ore as with stone. Nearly as much difference is shown in their oxidizing effects, as 100 parts of limestone take 12 of carbon, while 160 parts of ore take out 36 parts of carbon [see equations (1) and (2) above]; $53\frac{1}{2}$ parts, by weight, of ore accomplishes the work of 100 parts of limestone, or the ore is $1\frac{1}{2}$ times as efficient an oxidizer of carbon.

63. There is a great difference, also, in thermal conditions, resulting from the reactions shown by the above equations. The first, reducing carbon dioxide to carbon monoxide, is endothermic (absorbing heat); the second is in two phases, endo- and exothermic (liberating heat); the first phase consists in reducing the Fe_2O_3 ; and in the second phase heat is developed when the oxygen reduced from the ore combines with the 3 atoms of carbon. The second phase produces more heat than the first phase absorbs, so that the net result is a gain in heat.

Limestone has been termed a *refrigerating agent*, owing both to the distillation of its carbon dioxide and the action of this on the metalloids to form carbon monoxide. The terms *refrigerating agent* and *calorific agent* as applied, respectively, to limestone and ore must not be taken too literally, for in practice these effects do not stand out so prominently as the above might indicate. That the facts are as stated can be proved by calculations of the heat absorbed and developed by the reactions given. In practice, this may be modified or obscured by other factors, but the net results are as given.

64. Melting, Etc.—Melting on the basic hearth is an oxidizing action in the main with the same forces at work as on the acid. In addition, there are several relations changed or modified, and the essential difference of a basic slag carried, to effect the removal of phosphorus and sulphur. Art 45, I, gives the oxygen-consuming power of the

metalloids. In basic practice, phosphorus is added to the list according to the reaction

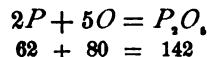

One part, by weight, of phosphorus unites with 1.290 parts of oxygen; or 1 part of oxygen with .775 part of phosphorus. The oxygen-absorbing power is only slightly less than that of carbon (1.333), or 1 part phosphorus is equivalent to .968 part of carbon, Art. 45, I. This relation of phosphorus also accounts for the larger percentage of pig iron that can be melted in basic practice.

In general, the most easily oxidized elements are first burned. In acid practice it was shown that the formation of oxide of iron was necessary to combine with the silica to form the slag. In basic practice we have the lime to combine with the oxidized silicon, and silica originally in the stock, so that there is not the same call for iron to be oxidized, but iron oxide is always present in basic slag. Just why the necessary conditions cannot be fulfilled by the other bases is not so apparent. In general, slags seek to absorb or combine with whatever increases fluidity and fusibility, and this may explain why ferrous oxide is taken up, its presence giving greater fusibility. With an increase of lime in the slag, the percentage of iron decreases, as a rule, but there are a number of conditions modifying this. The amount of manganous oxide MnO and phosphorus pentoxide P_2O_5 , greatly affect the fluidity of the slag and lessen the necessity for ferrous oxide.

65. The matter of viscosity of the slag is of the utmost importance in basic open-hearth work, and is a function of the composition and temperature. A too viscid slag will not readily transmit the heat and oxygen of the gases to the bath, so that the oxidation of the metalloids is delayed, while a too fluid slag will cut the basic hearth, even if the excessive fluidity is not due to silica, although the latter is usually the cause. The remedy for such a slag is to render

it basic, and this must be done promptly, for at the high temperature it rapidly attacks the hearth. Burned lime or dolomite may be used, but the former is much better and is almost always employed, as magnesia renders the slag viscid and requires greater heat for the same fluidity. Frequently the lime comes up and remains on the surface without dissolving. This condition, of course, is due to a deficiency of silica, for the lime to readily combine with; it is generally an advantage rather than otherwise—i. e., within the limits of sufficient silica in the charge to form a slag with the bases. To cut up the lime in such a case, or to render a too basic slag more fusible, fluorspar, calcium fluoride CaF_2 , is employed by throwing a few shovelful (from 25 to 200 pounds) on the slag or lime.

Silica or a silicate will, of course, thin the slag very quickly, but it is a remedy that may cut both ways and attack the lining or lower the basicity of the slag, so that dephosphorization will not take place completely or allow some of the phosphorus to return to the bath. Fluorspar is much more efficient, and gives fluidity without lessening the basicity of the slag. The reaction is rather obscure, but the most probable explanation is the formation of a double fluosilicate. Manganese ore is sometimes used for the same purpose and is very efficient; it has the additional advantage that the manganese oxide in the slag acts as a desulphurizing agent also. The increased fluidity from manganese is not due to any reaction with the silica or lime, except that a more fusible compound is introduced into the slag. This latter may also partially explain the action of calcium fluoride.

66. Basic Open-Hearth Slag.—Chemically, the slag is a silicate of calcium, iron, and manganese. Magnesia is always present both from the limestone, and the dolomite or magnesite of the hearth and that used for patching; the amount furnished from the limestone is almost always much less than that from the other sources. Alumina is also present in amounts usually varying from 2 to 6 per cent., its source

is the same as magnesia; these two compounds are not to be considered essential, but rather incidentally present from the nature of the case.

No fixed limits can be given for the composition; as previously stated, the two essentials are *fluidity* and *basicity*. The former first, that it may flow freely from the furnace with, or immediately after, the metal, so as not to fill up the hearth; second, that the reactions may take place without too much resistance from the slag, so that the "boil" will not be checked when the metalloids are oxidizing. Basicity is necessary, first, to remove the phosphorus and sulphur of the charge; second, to preserve the basic lining of the hearth.

The ordinary limits of composition of a good slag are given in Table VII.

TABLE VII

Limit	SiO_2	$CaO + MgO$	FeO	MnO	P_2O_5
Minimum...	10	45	10	5	5
Maximum...	20	55	25	15	15

If the silica runs much below 10 per cent. the slag is too viscid to properly perform its function, unless sufficient fluidity is furnished by liquefying elements, especially manganese and phosphorus. If above 20 per cent., there is always danger of cutting the bottom and a failure to purify the bath, but in case of very low phosphorus in the charge the silica may exceed the maximum given without harm. High ferrous oxide generally goes with low silica, and vice versa, but there are many exceptions to this. The calcium and magnesium oxides will depend on the other bases and on the phosphorus pentoxide, though primarily on the percentage of silica. The MnO and phosphorus pentoxide result from the manganese and phosphorus in the charge. By a consideration of the conditions existing, it will be seen that ferrous oxide is the only compound that the slag has

any choice as to whether or not it will take it; the others are forced on it, as it were—they are in the charge and must be gotten rid of by way of the slag, while the ferrous oxide is the poise by which the slag is adjusted. This relation cannot always be shown from a given slag, as conditions, besides that of composition, enter into and make the matter somewhat involved.

67. It is held by some authorities that an increase of calcium oxide means a decrease of ferrous oxide. This is explained by the increased basicity given by the calcium oxide, the slag not requiring so much ferrous oxide, which being feebly held, is readily reduced by the bath carbon. This view is doubtless correct for slags containing enough manganous oxide and phosphorus pentoxide to impart the necessary fluidity without absorbing more ferrous oxide for this purpose, but in the case of slags where the manganese and phosphorus are low, an increase of calcium oxide means more ferrous oxide in the slag to give the necessary fluidity, probably due to the formation of a ferrate of calcium. This latter condition may be taken as the usual one, and, as a general proposition, an increase in calcium oxide calls for more ferrous oxide in the slag. In a slag low in calcium and magnesium oxides, the ferrous oxide will be higher to make up the basicity, so that either a high or low percentage of calcium oxide in the slag may require more ferrous oxide. These relations are not conflicting, although at first they may appear so. In a normal basic slag, fluidity and basicity are not antagonistic; fluorspar and manganese ore, both of which are basic, are also used to give fusibility to the slag. Excessive fusibility may come from silica, but such a slag would not be a normal basic one.

68. As the charge begins to melt, the slag first formed is short of bases and takes up ferrous oxide, in greater proportion than is held later, to give the necessary basicity; this excess of ferrous oxide is reduced by the bath carbon as the lime combines with the slag. With the limestone

charged on the bottom, there is more or less tendency for it to stick to the hearth. As the charge becomes semifluid and pasty, rods are used to poke the stone loose, otherwise it may accumulate and build up the bottom to such an extent that the hearth will not hold the regular charge.

In ordinary practice, all of the slag is held in the furnace until the heat is tapped, when it runs out after most of the metal and forms a covering for it in the ladle, protecting it in a great measure from loss of heat. Sometimes only a part of the slag remains in the ladle, the remainder running off into a slag hole under the tap hole. When the steel is poured, the ladle is dumped by means of a chain hooked to its bottom and operated by an auxiliary trolley on the bridge of the ladle crane.

Tapping a part of the slag immediately after melting has been followed to some extent, but this is not usually an advantage. One practice was to melt with insufficient lime and tap off the slag before it had time to scorify the hearth, the object being to get rid of a large part of the silica without satisfying it with lime. As such a slag is quite acid, there is always danger of scorifying the hearth excessively, besides losing steel in running it off, and more time is lost in repairs than the procedure justifies. Another practice is to run a very limy slag and tap this off after melting, when it contains most of the silica and phosphorus of the charge. This is less objectionable than the first, but has some of its drawbacks and is not ordinarily good practice, except when very silicious and phosphoric stock is melted and a large amount of lime must be carried, thus giving an abnormal quantity of slag.

The tilting furnace is best adapted for a preliminary removal of slag, and this is one of its chief advantages. With it the slag is decanted off to whatever extent is desired, although it is not possible to pour it all off, as some steel would come with it.

The average composition and ordinary variations of basic slags are shown in Table VIII.

TABLE VIII

Number of Slag	SiO_2	CaO	FeO	MnO	P_2O_5	MgO	Al_2O_3
1	18.30	50.25	14.91	4.85	3.43	6.00	1.96
2	14.60	50.04	10.20	7.15	6.50	8.07	2.62
3	19.20	45.62	9.04	9.60	2.98	10.28	3.28
4	29.43	39.07	14.61	8.00	5.28	5.20	
5	8.70	51.90	23.45	7.25	11.00	3.70	
6	12.20	41.20	18.30	5.30	12.60	6.40	
7	14.25	39.97	13.18	10.84	9.51	8.49	
8	9.85	43.46	14.81	8.26	15.38	4.23	
9	8.50	45.30	18.25	8.00	12.40	4.50	
10	10.90	42.70	12.09	10.26	13.70	5.58	

The above are all representative slags except No. 4, which is exceptional from the high percentage of silica. It is given because such slags are occasionally met with, but imperfect purification of the metal or excessive scorification of the hearth generally results. The sulphur exists in the slag as sulphide, principally as CaS , the percentage usually being from $\frac{1}{4}$ to 1 per cent. CaS .

69. In conclusion, it may be said that the essentials of the slag are silica, calcium oxide, and ferrous oxide in proportions to give a fluid, basic slag. The presence of manganese oxide is highly desirable to give fusibility and to desulphurize, but it is not an essential; it is, however, always a constituent, depending on its percentage in the stock. The phosphorus pentoxide is present as a result of the oxidizing action and the basicity of the slag; this is the fundamental principle of the basic process.

Even under the best conditions of working, the slag always scorifies the hearth somewhat. The slag line, or *shelf*, requires patching after each heat, burned dolomite or magnesite being used, generally the former, as it is cheaper, also as it sets more quickly and is thus more permanent.

Holes frequently are left in the bottom after the heat is tapped; the metal and slag must be bailed or splashed out of these with rabblers (heavy iron hoes) and the holes filled with magnesite, a little slag usually being added to increase the fusibility, so that it will set quicker.

The amount of slag produced in basic work is necessarily much greater than in acid, and usually ranges from 8 to 20 per cent. of the weight of the charge. This depends on the amount of slag-forming elements in the stock, the amount and quality of limestone used, and the melting practice.

70. Dephosphorization.—The removal of phosphorus takes place partially during the oxidation of the other metalloids, as a rule, or may be complete before the carbon is all burned, but the greater part of the manganese and all of the silicon is oxidized before dephosphorization can be finished. It is probable, under certain conditions, that the phosphorus is simultaneously oxidized with the silicon. Owing to the conditions of melting, it is practically impossible to obtain data that will accurately set limits within which dephosphorization occurs. The essential thing, of course, is to have sufficient lime present to form not only a basic slag, but to leave enough in excess to absorb the phosphorus pentoxide formed. The phosphorus in the slag exists as a phosphate of iron or calcium. The purpose and exact office of ferrous oxide, with respect to phosphorus, is not understood, but a certain amount seems to be required.

71. In melting stock low in phosphorus, the elimination may be essentially complete during the melting period, while with high phosphorus the percentage of removal will be much less, though the actual amount may be greater. There is no relation between the amount eliminated during melting and that present in the charge; with apparently uniform conditions as to stock, conditions of melting, etc., wide variations are shown in practice. Some of the practical obstacles in determining the dephosphorizing conditions referred to above are the uncertainty as to whether all lime has come off the bottom when the heat is melted; the

kind and arrangement of the stock; the character of the flame; changes in the slag due to irregular stock and varying percentages of ferrous oxide. Table IX shows the phosphorus removed during melting, together with partial analyses of the accompanying slags. These are given as examples met with in practice and not intended that any general deductions should be drawn as to dephosphorization,

TABLE IX

ANALYSES SHOWING ELIMINATION OF PHOSPHORUS DURING MELTING

No. of Sample	Initial Phosphorus in Charge	Per Cent. of Phosphorus After Melting	Amount of Phosphorus Removed	Per Cent. of Phosphorus Eliminated in Melting	Accompanying Slags			
					SiO_2	FeO	P_2O_5	CaO
1	3.00	.755	2.245	75.00	10.41	17.37		48.56
2	2.18	.629	1.551	71.00	12.79	4.41	23.50	43.07
3	2.29	.849	1.441	63.00	12.68	4.05	21.83	42.18
4	1.42	.563	.857	60.00	11.10		16.05	
5	.55	.282	.268	49.00	30.26	10.08	5.99	45.26
6	.55	.297	.253	46.00	31.30	10.98	3.72	41.45
7	.55	.378	.172	31.00	34.05	18.45	3.08	35.09
8	.55	.464	.086	16.00	34.37	6.57		
9	.19	.009	.181	95.00	13.02	24.21		
10	.19	.032	.158	83.00	14.09	27.09		
11	.19	.072	.118	62.00	22.93	11.16		
12	.19	.105	.085	45.00	25.34	6.66		

as many conditions affecting this cannot be shown. The first four given show unusually high phosphorus in the charge; in this case the elimination was increased by a large amount of ore charged with the heat. The second four show a much lower elimination with a smaller percentage of phosphorus in the charge; in this case a deficiency of lime, as shown by the high silica in the slags, will mainly account for this.

The last four show a low phosphorus charge for basic practice with elimination nearly complete in one case; these also show the removal greater with lower silica in the slag.

72. When the heat is melted, a test is taken and broken to show the melter where the carbon is and if the phosphorus is low. The latter can be told by the fracture, the same as the carbon, but with much less certainty, so that this is generally determined by analysis. After the lime is all up, the melter adjusts the slag (entirely by the eye); if too acid, burned lime is added to bring it to the proper consistency; if too basic, it is thinned with fluorspar or manganese ore. With the proper slag, if much phosphorus remains in the bath after melting and the carbon is not too low, it will generally be oxidized by the time the carbon is boiled down to the desired point. In case the phosphorus should not be removed when the carbon is practically all out, it is usually necessary to add pig iron, which lowers the temperature and brings action on the bath by introducing metalloids to be oxidized. This procedure is mainly required, however, because the slag covering a carbonless bath rapidly takes up ferrous oxide, but the presence of carbon neutralizes this action or reduces the *Fe* from any ferrous oxide formed.

73. The thermal conditions accompanying oxidation of phosphorus favor its removal during melting, as it enters the slag at a comparatively low temperature. This does not mean it is not removed at a high heat also.

In good basic practice, the phosphorus is reduced to less than .04 per cent. in the finished steel, and not infrequently in the regular practice the steel shows but .01 to .02 per cent. of phosphorus. Depending on whether high or low phosphorus stock is melted, this shows an elimination of 90 to 99 per cent. Table X shows the percentage of phosphorus in six samples of finished steel, that in the charge and in the slags, and represents current practice.

74. Desulphurization.—Throughout the manufacture of iron and steel, sulphur is the most difficult element with

MANUFACTURE OF STEEL

and arrangement of the stock; the changes in the slag due to irregular percentages of ferrous oxide. Tables show phosphorus removed during melting, together with analyses of the accompanying slags. The examples met with in practice and not general deductions should be drawn as to

TABLE IX

ANALYSES SHOWING ELIMINATION OF PHOSPHORUS DURING MELTING

No. of Sample	Initial Phosphorus in Charge	Per Cent. of Phosphorus After Melting	Amount of Phosphorus Removed	Per Cent. of Phosphorus Eliminated in Melting	Acc	
					SiO_2	
1	3.00	.755	2.245	75.00	10.41	
2	2.18	.629	1.551	71.00	12.79	
3	2.29	.849	1.441	63.00	12.68	
4	1.42	.563	.857	60.00	11.10	
5	.55	.282	.268	49.00	30.26	1
6	.55	.297	.253	46.00	31.30	1
7	.55	.378	.172	31.00	34.05	1
8	.55	.464	.086	16.00	34.37	
9	.19	.009	.181	95.00	13.02	2
10	.19	.032	.158	83.00	14.09	2
11	.19	.072	.118	62.00	22.93	1
12	.19	.105	.085	45.00	25.34	

as many conditions affecting this cannot be stated. The first four given show unusually high phosphorus in the charge; in this case the elimination was in proportion to the amount of ore charged with the heat. The last four show a much lower elimination with increasing phosphorus in the charge; in this case, as shown by the high silica in the slag, account for this.

which the metallurgist has to contend. One by one the others have been controlled and a way found for their elimination, generally by surrounding them with such conditions that they are made to do useful work. The reactions involved in their removal furnish a large amount of heat in all the processes, and in some, all of the heat used in converting the liquid pig iron to steel. In the acid Bessemer process the oxidation of the silicon, carbon, and manganese gives all the heat required; in fact, it may furnish too much for proper working. In the basic Bessemer, the oxidation

TABLE X

ANALYSES SHOWING PHOSPHORUS IN FINISHED STEEL,
ELIMINATION, ETC.

No. of Sample	Initial Phosphorus in Charge, Per Cent.	Phosphorus in Ingot, Per Cent.	Phosphorus Eliminated, Per Cent.	Accompanying Slags				
				Per Cent. of SiO_2	Per Cent. of FeO	Per Cent. of P_2O_5	Per Cent. of MnO	Per Cent. of $CaO + MgO$
1	3.000	.036	98.8	13.98	4.68	16.62		52.73
2	1.350	.040	97.0	8.28	13.47	11.37	6.98	55.77
3	.190	.012	94.0	15.04	21.02			
4	.100	.005	95.0	18.30	15.30	3.43	4.85	56.25
5	1.000	.015	98.5	12.20		4.80		
6	.820	.020	97.6	10.60				

of phosphorus is the chief source of heat. In both the acid and the basic open-hearth processes the oxidation of the impurities furnishes a large amount of the heat. Sulphur is the only one of the ordinary impurities in pig iron that has not been fully utilized in some process. Both basic methods remove a part of it, but cannot be said to control it, as results are irregular and any large reduction cannot be counted on with certainty.

75. Manganese and lime are the only agents, chemically, that are used; temperature is a potent factor in eliminating

it, and there seems to be no limit, except what the furnace will stand, at which a high heat is not an advantage.

The action of manganese and lime is as follows:

(a) Manganese effects reduction (1) by that which is present in the stock, carrying out sulphur with it as oxidized; (2) by the use of manganese ore, which, as reduced, adds manganese to the bath, acting as in (1), or, if incorporated directly in the slag, is reduced from the latter during decarburization and dephosphorization; (3) by the addition of ferromanganese or spiegeleisen to the bath, which act as in (1), but are more effective for the same amount of manganese.

(b) A limy slag absorbs sulphur, the only conditions being extreme basicity and high temperature. In connection with lime, calcium chloride has been used; its use is covered by a patent, the process being called the *Saniter process*, from its developer. At the time of its introduction (1892) great claims were made for its efficiency and much was expected from it. It did not reach any general application, and is not used today in America, and by only a few works in England, where it originated. In using calcium chloride, an unusually limy slag is carried, the function of the chloride apparently being to furnish fluidity, the extra basicity of the slag likely taking care of the sulphur without any direct help from the calcium chloride. Any other agent that increases the fusibility without lowering basicity, thus allowing a more limy slag to be carried, is as efficient.

Fluorspar assists in desulphurizing in the same way. It is improbable that it has any direct action, but by giving the necessary physical condition to an otherwise too viscid slag it may be classed as an indirect desulphurizer.

76. With high sulphur in the charge more is removed, under otherwise similar conditions, than with low sulphur stock. This is apparently due to the greater tenacity with which smaller percentages of all the elements remain in the bath. The non-uniformity of removal is mentioned above. As a general statement, it may be said that one-third of the sulphur in the charge is eliminated in good basic practice.

This is without any special effort or losing time for adjusting the slag by any of the additions given above. By the latter course, a removal of from 50 to 75 per cent. can be effected regularly; and this is frequently reached in regular working, without particular pains, except as noted, but cannot be relied on. Whether it is an economy to get a high elimination of sulphur depends on the cost of the purer stock, as the more sulphurous, the more time is consumed, thereby reducing the output. The extra basic additions are harder on the furnace, on account of dust carried over to the ports and checkers and the higher working temperature generally employed. The cost of the extra additions is of some moment, but usually less than the two preceding points.

77. Manganese effects removal of sulphur by metallic manganese, whether added as such or reduced from ore by the action of silicon and carbon, taking the sulphur from its combination with iron, or solution in the bath, forming sulphide of manganese, this mostly being absorbed by the slag. It may also occur that part of the manganese sulphide is decomposed by the oxidizing action of the slag and exposure to the flame, the sulphur burning to SO_2 and the manganese returning to the bath to again take up sulphur, or it may form manganous oxide at once. Lime may combine with sulphur directly in the presence of carbon or by reacting with the manganese sulphide.

The reactions of lime and manganese with sulphur are as follows :

1. $Mn + FeS = MnS + Fe$ (absorption by metallic manganese).
2. $MnS + O_2 = SO_2 + Mn$ (loss of sulphur in waste gases).
3. $S + CaO + C = CaS + CO$ (direct combination of sulphur with CaO).
4. $MnS + CaO = CaS + MnO$.

That part of the sulphur is oxidized and lost in the waste gases (it seems most probable as shown by reaction 2) is

indicated by the fact that the sulphur in the slag and the finished steel does not always account for all in the initial charge. If using producer gas, from .005 to .015 per cent. of sulphur will be absorbed from this source. Natural gas does not increase the sulphur.

Considerable sulphur is generally lost during melting, but no regularity attends this. In endeavoring to get accurate data as to sulphur, more obstacles are in the way than with any other element. Some of these are: The sulphur absorbed from the gas; that lost by volatilization; the difficulty of obtaining the exact amount in the charge, as it will vary more than any other element, and unless elaborate sampling of the stock is done, there is greater discrepancy; most important and exerting the greatest influence, are changes and influences that are not fully understood, and from the nature of the case seem impossible to control. Among the latter are variations in the slag, character and arrangement of the stock, temperature, some of the melting conditions, etc.

TABLE XI

Calculated Sulphur in Charge. Per Cent.	Sulphur After Melting. Per Cent.	Sulphur in Ingot. Per Cent.	Per Cent. Eliminated
.085	.070	.050	41.2
.120	.100	.045	62.5
.070	.050	.020	71.4
.280	.220	.086	69.3
.060	.040	.030	50.0
.050	.030	.025	50.0
.040	.030	.025	37.5
.045	.035	.030	33.3
.035	.030	.030	14.3

Table XI gives results from regular basic practice of sulphur elimination without any attempt to analyze the various causes in individual cases.

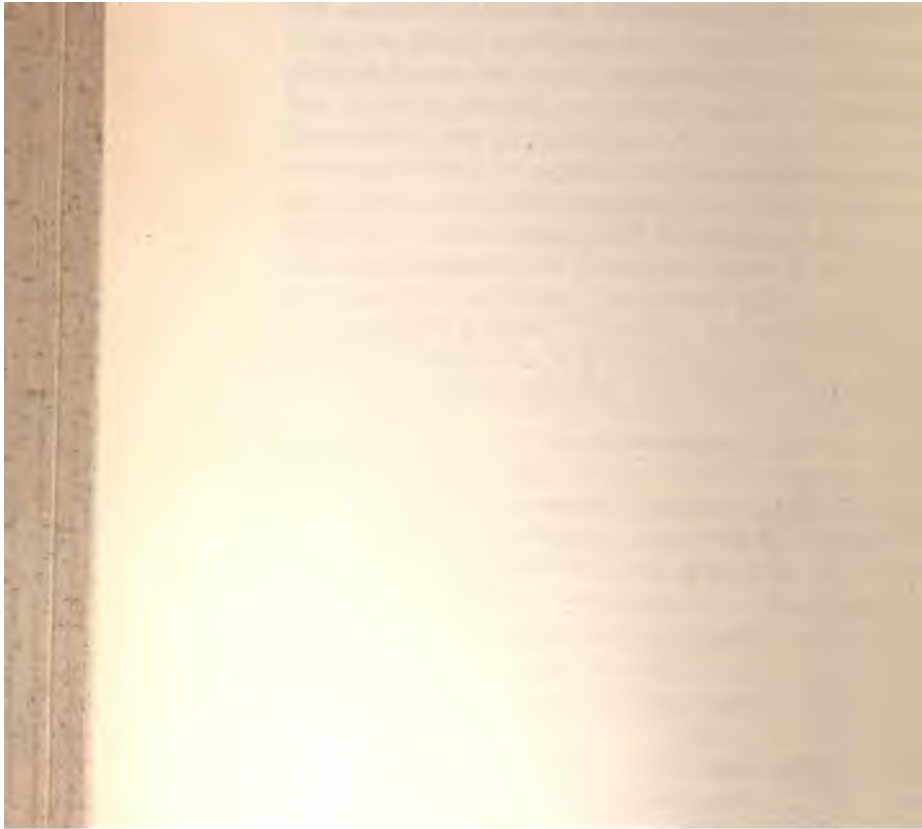

MANUFACTURE OF STEEL

(PART 2)

THE BESSEMER PROCESS

1. Introductory.—The Bessemer process for the manufacture of steel was invented by Henry Bessemer, and patented in England in 1855. In recognition of his services to metallurgy and for the far-reaching effects of his invention, he was afterwards knighted and is generally spoken of as Sir Henry Bessemer. It is doubtful if any single invention or discovery has had such a wonderful effect on industry and manufacturing in general. While it became the basis of the modern steel industry, in itself of great magnitude, it is in the development of other industries, made possible by the cheapening of steel, that we see its full importance. The railroads in particular, in their present development, could become a reality only when it was possible to produce the steel necessary for the rails and other parts of the equipment. Steamships and engineering and manufacturing establishments of all kinds are made of it or depend on it for success. In fact, our whole industrial and commercial life may be said to be more dependent on steel than on anything else; but until the invention of the Bessemer process it was impossible to produce steel in sufficient quantities or at a suitable cost to permit its general use. While the Bessemer process has a great future, especially in the United States, where vast quantities of suitable ores are available, it is being superseded to a great extent by the basic open-hearth process; and whenever the cost of production by the latter

§ 34

For notice of copyright, see page immediately following the title page.

becomes equal to or lower than the Bessemer it will supplant it still further.

Bessemer experimented several years before taking out his first patents, which covered the principle of blowing air through or over molten iron. Many other metallurgists had worked on the line of introducing a blast of air to effect the refining of pig iron, but only one other, so far as known, used a vessel or converter and blew the air from the bottom through the liquid iron. While the priority of Bessemer's invention has been questioned, there is no doubt that his work was prosecuted independently and that he was the first to completely realize the full success of the principle. The other inventor who used this principle was William Kelly, an American, who experimented about the same time as Bessemer, and applied for a patent in 1857; while Bessemer had secured American patents nearly a year before this, the patent office allowed Kelly's claim on the ground of priority of discovery. For several years following this, two companies, representing the Bessemer English and the Kelly American patents, attempted to introduce the process into the United States. Litigation resulted and a compromise was finally effected by the former company taking 70 per cent. and the latter 30 per cent. of the United States royalties. This was only partially in recognition of the Kelly patent, as the latter company had acquired the United States rights to the patents of the Mushet recarbonizing process by the use of spiegeleisen or ferromanganese. This is the only recognition either Kelly or Mushet received for their work on the pneumatic process of making steel, although, unfortunately, the financial rewards of the above compromise did not reach either. Bessemer's apparatus, from a mechanical point of view, was much superior to Kelly's, and it was largely owing to this fact that it superseded it.

Bessemer's experiments covered almost every conceivable method of applying the pneumatic principle—blowing from the top and sides on to the metal or through it; in various kinds and types of fixed and movable vessels, etc. He

finally adopted the tipping vessel or converter with the air blown through the metal from the bottom. This type of apparatus, as Bessemer developed it, remains the standard today. Many mechanical improvements tending to increase the speed and convenience of working have, of course, been made, a large number being developed by Alexander L. Holley, when the process was first applied.

Bessemer's original idea was to produce wrought iron, but owing to the large amount of gases left in the metal and the lack of a fibrous structure, the blown metal was worthless, as in iron. At this point his experiments rested for some time and seemed almost a failure. Mushet had previously added and patented the use of manganese in the form of dioxide, under reducing conditions, and later as an iron and manganese alloy called spiegel, or spiegeleisen, for the production of steel. It was when Bessemer availed himself of this method that steel was first made by the Bessemer process.

The first plant built on a commercial scale was at Sheffield, England, the home of the crucible-steel industry. While the chief technical difficulties had been so far overcome as to produce merchantable steel, there still remained the commercial ones of introducing it and overcoming the prejudice of users to a new metal, and setbacks from failures from putting it to uses for which it was not intended, as sometimes, to replace soft iron or harder steel. Its first use was in certain tools, machine parts, etc., and later, in ship building, railroad construction, and the varied kinds of merchant-steel shapes, bars, etc. The great consumption of Bessemer product has been and yet is steel rails. As the process grew in England, it extended to the Continent and the United States.

2. Apparatus Used.—The essential appliance and the one representing the Bessemer or pneumatic principle, is the converter or vessel in which the molten pig iron is transformed from cast iron into steel, or more correctly into blown metal—the recarbonizing being necessary to give the

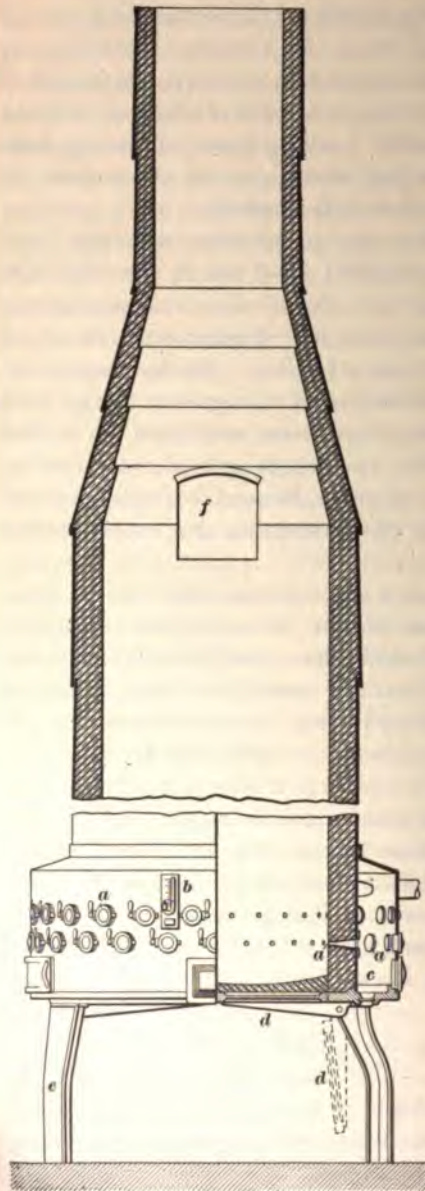

FIG. 1

final product, steel. As necessary adjuncts, are *cupolas* for remelting, or some means for taking the pig iron direct from the blast furnace; and the necessary *cranes, ladles, molds*, etc. for handling the iron used and the steel produced. The movements of the cranes, converter, etc. are controlled by hydraulic power, an accumulator keeping up the pressure, which is usually maintained at from 500 to 700 pounds per square inch.

3. Cupolas.—The cupola furnace used is shown in Fig. 1. It is the same as the ordinary foundry cupola except that it is larger and is usually placed at a higher level, owing to a different method of handling the iron. The number and size vary with the iron to be melted, but the usual Bessemer plant has from three to six. The height from the bottom to the top of

the stack is approximately from 40 to 60 feet. The diameter of the shell (of about $\frac{1}{2}$ -inch riveted steel plate) is from 10 to 15 feet and is lined with firebrick, giving a melting space of from 8 to 12 feet in diameter in freshly lined cupolas; they may rest on solid foundations or on iron pillars *e*. All cupolas are arranged with drop bottoms *d*, and are, therefore, always set up some distance above their foundations to allow the doors of the drop bottom to swing down. These are necessary to facilitate the cleaning out of the cupolas at the end of each week, or oftener; they run without repairs from 3 to 6 days, when they become partially filled up and scaffold across, so that the space in the shaft is too small for proper melting. About 25 feet above the bottom of the cupola is the charging floor, where the stock is elevated to be charged into the charging door *f*. As the metal melts, it drops to the bottom, whence it is tapped at intervals into the ladle. As in all melting furnaces, slag forms; this is removed through a slag hole at a higher level than the iron notch, or tap hole; the space, or well, between the two holes allows the accumulation of melted iron, so that quite large weights are available at one time.

4. Tuyeres.—These are the openings (shown at *a*) in the shell and lining, through which air is supplied for the combustion of the fuel effecting the melting. They are either separately connected to the blast pipe or open from a common wind box *c* extending around the cupola. They are about 4 inches in diameter on their outer ends and taper to about 2 inches on the inside. They may vary from this size, but if less than 2 inches in diameter, they are too easily clogged up by slag and iron. Their number varies also, but an ordinary 10-foot cupola (inside) will usually have from 12 to 20 but sometimes as many as 48 tuyeres. The blast is furnished by a blower, or fan, usually placed in the engine room, and has a pressure of 8 to 14 ounces per square inch, as shown on a gauge *b*; the tuyeres or main blast pipe are provided with slides or valves for regulating the volume

and pressure of blast to suit the various melting conditions, such as the working of the cupola or the amount of iron wanted. The amount of air used is a variable quantity, but is approximately 30,000 cubic feet per ton of iron melted.

5. Lining.—The cupola lining consists of the best grade of firebrick and varies from a thickness of 18 to 24 inches at the bottom, where the greatest wear and pressure come, to 12 inches in the upper part. The abrasive action of the descending charge of pig iron, etc. requires a brick of special quality. The brick are laid up with a thin grout of ganister and clay; patching is done with ball stuff of the same. The lining is built up straight or drawn in towards the top, as this construction lessens the disposition to hang or scaffold.

6. Fuel.—This consists almost universally of coke, but anthracite coal is used as a partial substitute where it is cheaper; coke, however, owing to its more open structure, which permits the ready passage of the blast and keeps the shaft open, is much superior. The coke should be hard-burned, with strong, firm structure to bear up the burden and **not crush. In composition, sulphur is the most injurious element and should be as low as possible; ash is objectionable merely as an adulterant, lowering the melting value and requiring more flux; phosphorus is of less consequence than in blast-furnace practice, as the ratio of coke to metal is so much less and it is doubtful if much or any of the phosphorus in the coke enters the iron in melting. The range in analysis of a good cupola coke is given in Table I.**

TABLE I

	Ash. Per Cent.	Fixed Carbon. Per Cent.	Volatile Matter. Per Cent.	Sulphur. Per Cent.	Phos- phorus. Per Cent.
Minimum...	8.00	87.00	.50	.75	.005
Maximum..	12.00	91.00	1.00	1.00	.015

In starting the cupola, coke for a *bed* is charged on the bottom, with enough wood to readily light it, a little distance above the wind box, or the lower tuyeres; when this is thoroughly ignited, with the blast turned on, the regular charging of pig iron and the necessary coke follows. The fuel and iron ratios range from 1 pound of coke to 8 pounds of iron up to 1 pound of coke to 15 pounds of iron, good practice being about 12 pounds of iron melted with 1 pound of coke.

7. Flux.—The flux used to form a slag with the sand on the pigs, the coke ash, and wear of lining, is limestone. The slag contains varying amounts of iron, usually from 10 to 12 per cent., and is mainly a silicate of iron and calcium. The usual range of composition of stone and slag is given in Table II.

TABLE II

	Silica. Per Cent.	Lime. Per Cent.	Oxides of Iron and Alumina. Per Cent.	MgO. Per Cent.	Iron. Per Cent.
Limestone..	1 to 5	48 to 53	.5 to 2.5	1 to 5	
Cupola slag.	45 to 55	15 to 20	15.0 to 20.0	1 to 4	8 to 15

8. Cupola Mix.—This is the proportion in which the different irons are charged to give the required composition, together with the fuel and flux. The silicon and sulphur are the only two elements usually figured on, as all the iron for the Bessemer process is very close to the same percentage in phosphorus and does not vary widely in manganese. The usual range of composition of Bessemer pig iron is given in Table III.

Carbon is not considered in the calculation. With the phosphorus below the Bessemer limit of .1 per cent., the sulphur not exceeding .05 per cent., and manganese about .6 per cent., silicon is the chief element controlling the

mix, though the sulphur and phosphorus are not less important; in fact, even more so, as the process has no control over these, while the silicon may vary within considerable limits without serious disadvantage to the product. The silicon is the principal fuel in the process and is necessary for this reason. Formerly 2 to 2.5 per cent. was considered necessary in the pig iron for successful working, but in present practice about half of this is used. This is due to more rapid working and to using less steel scrap in the cupola and vessel.

TABLE III

	Silicon. Per Cent.	Sulphur. Per Cent.	Phos- phorus. Per Cent.	Man- ganese. Per Cent.	Carbon. Per Cent.
Minimum..	.75	.02	.08	.4	3.75
Maximum..	2.00	.06	.10	.8	4.25

In melting, there is a gain of sulphur, by absorption from that in the coke, so that the metal tapped out contains from .01 to .03 per cent. more sulphur than did the initial pig iron; the increase depends mainly on the amount in the coke, but somewhat on melting conditions and on the lime charged. There is a loss of silicon in the cupola, as some is oxidized and enters the slag, the amount depending somewhat on the initial silicon in the pig and the melting conditions—the blast and rapidity of melting. Under similar conditions, the loss of silicon is greater the higher the silicon is in the pig; it is usually taken as .2 to .3 per cent. No fixed rule is adhered to in calculating the charge, as it seldom happens that different grades of iron are available in amounts necessary for an accurate calculation. The condition is more common that certain amounts of one or two irons must be used and the mix adjusted with other irons, so that the calculation becomes an approximation and can be made essentially accurate. Assume a loss of .25 per cent.

of silicon in melting and that the metal should go to the vessels to be blown, with 1.25 per cent. of silicon, or the cupola charge averages 1.5 per cent. of silicon; that the stock available requires the use of 75 per cent. of a 1.2-per-cent. silicon iron or .9 per cent. of silicon from this source; that the highest silicon iron at the metallurgist's disposal is 2 per cent., so that using the remaining 25 per cent. of this iron gives .5 per cent. of silicon, or 1.4 per cent. in the mix. A plus or minus error of .1 per cent. from the desired amount is permitted. The stock in buggies is raised to the charging floor by an elevator or lift, hydraulic power being generally used, and dumped in the charging doors, the coke distributed between metal charges, and the stone thrown on the coke barrows at the scales below; from 40 to 60 pounds of limestone is added per ton of pig iron.

9. Mixer.—Fig. 2 shows a section through the mixer. This is a reservoir for storing the molten metal from blast furnaces, and has come into general use only within the past 3 or 4 years, but has been used at a few works for a number of years. The construction is simple, it being merely a strongly framed structure of steel plates lined with firebrick. Two or four hydraulic cylinders *c* are placed at each corner, or one side, for tipping it to pour out the metal. It is provided with a hopper, or funnel *a*, at the back, as shown, or in the center of the roof. The pig iron is run into ladles at the blast furnace and transferred by a locomotive to the mixer; or if the blast furnaces and steel plant are close together, a traveling crane is generally provided for transporting the ladle and pouring into the mixer. In the former arrangement the ladle is run up an elevated track, raised by a hydraulic lift or a crane to a sufficient height above the mixer to pour in readily.

The advantages in using the mixer are that remelting the pig in cupolas is avoided, thus saving the expense of fuel and handling, and that the loss is less. Molten metal has been taken direct from the blast furnaces to the converters, but the results have not been satisfactory, owing

mainly to the frequently varying composition from one cast to another and also to the fact that the metal was not available just as wanted, or came in too large quantities when

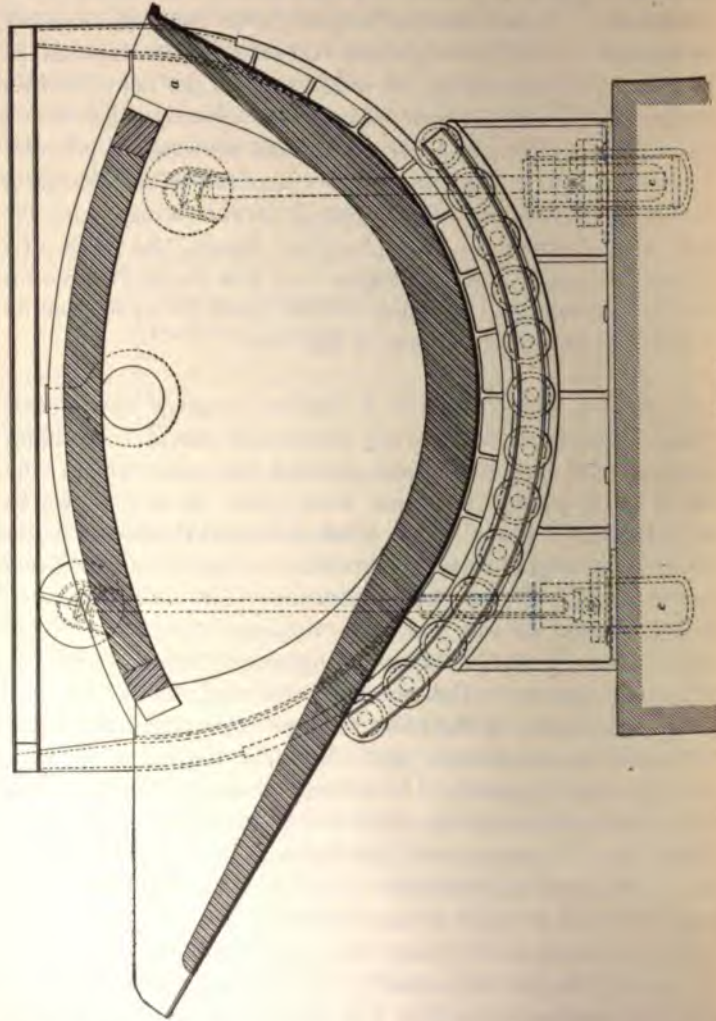

entire casts came at once. The mixer furnishes the metal exactly as it is wanted; and what is even more important,

it supplies a more uniform metal from the mixing of a number of casts. These mixers are made to hold from 150 to 250 tons and are of service where blast-furnace and Bessemer plants are operated together and there is a large output from both; generally the metal is transported only short distances, but it has been successfully taken in ladles from 2 to 3 miles.

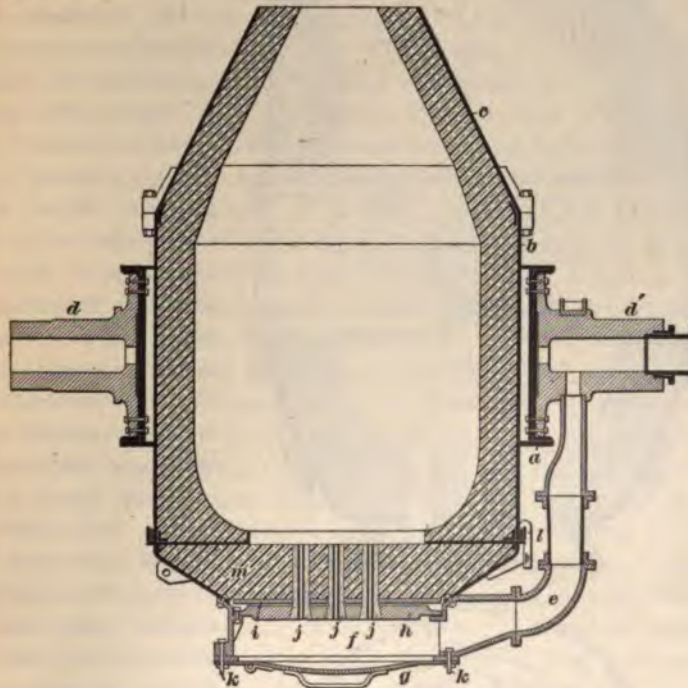

FIG. 3

Cupolas are usually operated in connection with the mixers to supply part of the metal for blowing when the blast-furnace output is below the converting capacity. In transferring from the mixer to the converter, a ladle on a car is run under the pouring spout, the mixer tipped over by the hydraulic cylinders, and the required weight poured out, as shown by track scales on which the ladle car rests;

the mixer is righted and the ladle moved by electric or other haulage system, so that the iron crane can pick it up and pour into the converters.

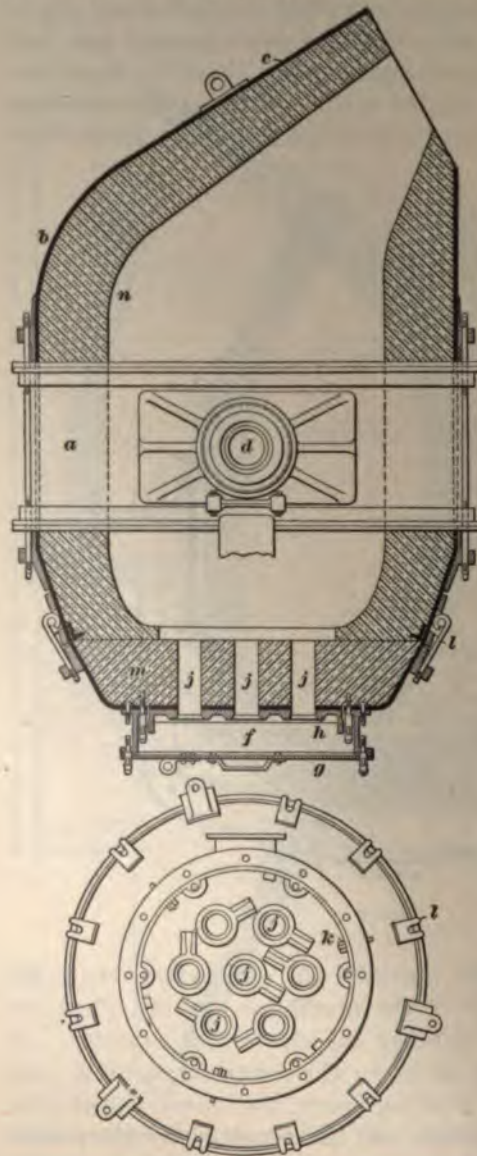

FIG. 4

10. Converter.

This is the essential apparatus of the process and the one in which the pneumatic principle is applied. It is an oval vessel with a symmetrical nose, as shown in section in Fig. 3, or an eccentric nose, as in Fig. 4. The former is more generally used now, although at one time the latter was used almost exclusively. It is made of heavy riveted plate steel and is lined with refractory material—ganister for the acid, and dolomite or magnesite for the basic process, as in the open-hearth. It is suspended about the middle on trunnions, shown at *d* and *d'*, Fig. 3,

one of which, *d'*, is hollow, and through which the blast passes from the blast pipe by way of the gooseneck *c* to the vessel's bottom and thence through the tuyeres to the metal. The vessel is rotated by hydraulic power applied through a rack and pinion. The construction is such that it can be made to revolve completely and empty out any slag after pouring the steel. Referring to Fig. 3, it will be seen that the vessel consists of three principal sections keyed together to form the complete converter. The middle, or main section *b*, around which the trunnion ring *a* extends, holds the body of metal while it is being blown. The bottom *m* is detachable and is held to the body of the vessel by keys and links *l*. Originally, the bottom was not movable, but the latter construction (an invention of Holley's) did much to facilitate repairs and speed of working. Beneath the bottom proper is the tuyere box *f*; its cover is keyed on at *k* and is airtight; the nose of the converter *c* is also keyed on to the main part, permitting its removal for repairs, etc. The straight- or concentric-nosed vessels are generally held to slop less than the eccentric-nosed ones; i. e., less metal is thrown out of the converters by the violence of the reaction. They are made in sizes of from 1 to 20 tons capacity, but blow about 5 tons in small plants and from 10 to 20 tons in the large plants; less than 5 tons is usually for steel-casting plants where the output is limited. The metal fills only a small part of the space, as the reaction is so violent that abundant room must be allowed for it. When the vessel is turned down, the metal lies in the belly, shown at *n*, Fig. 4, so as to be clear of the tuyeres and not run out the nose.

THE ACID BESSEMER PROCESS

11. Introductory.—The acid and basic Bessemer processes bear the same relation to each other as to the acid and basic open-hearth processes. The lining for the converter in the acid process being of acid material, dephosphorization and desulphurization do not take place, owing to

the acid slag necessary; hence the process is limited to comparatively fine pig irons, as in the acid open-hearth process.

12. Bottom and Tuyeres of Converter.—The bottom for the acid process is made up of ganister rammed in or pieces of the ganister rock set over it and ball stuff of the same and some clay rammed in between these. Its thickness is 26 to 30 inches. The tuyeres *j* are spaced over the bottom and supported from below by the tuyere plate *h*, Figs. 3 and 4; they are placed in position before the bottom is built up and the ganister built up around them. Their length corresponds to the thickness of the bottom (26 to 30 inches), so that their inner face comes flush with the latter. They are cylindrical in shape, about 6 inches in diameter, and contain from 6 to 10 holes $\frac{3}{8}$ to $\frac{1}{2}$ inch in diameter; their number varies from 7 to 12 and the total tuyere area (i. e., area of the holes) varies from $2\frac{1}{2}$ to 4 square inches per ton of metal blown. After being made up, the bottoms are run into drying ovens and thoroughly burned. Their life varies from a single heat occasionally, to 50 or 60 rarely; 30 to 35 heats for a single bottom may be taken as good average practice. The tuyeres are made of hard-burned and very refractory fireclay; in blowing, it frequently happens that a tuyere will be cut through by the metal—when the vessel is turned down, the lid *g* of the tuyere box removed, and a circular plate inserted over the tuyere or blanked; the heat can be blown with a number of the tuyeres blanked, but the blowing time is increased. Bottoms are changed in some works by turning the vessel into a vertical position with the nose down, and after unkeying, a crane lifts it off and places a fresh one in position. In others, the vessel is turned with the bottom down and a car is run under it, on which the bottom is dropped, a hydraulic lift raising the car against the bottom; a fresh bottom on another car is raised against the vessel and keyed on. The latter is the more rapid method, but little time is lost by either.

13. Lining and Repairing.—The lining is about 12 inches thick, and is made up of ganister or silica brick,

usually the former, ground with about a fifth part of refractory clay. The vessel's lining lasts much longer than the bottom, as the latter is supporting the charge most of the time and the cutting action is more intense on it. From 3 to 5 months is an average life for lining, or 5,000 to

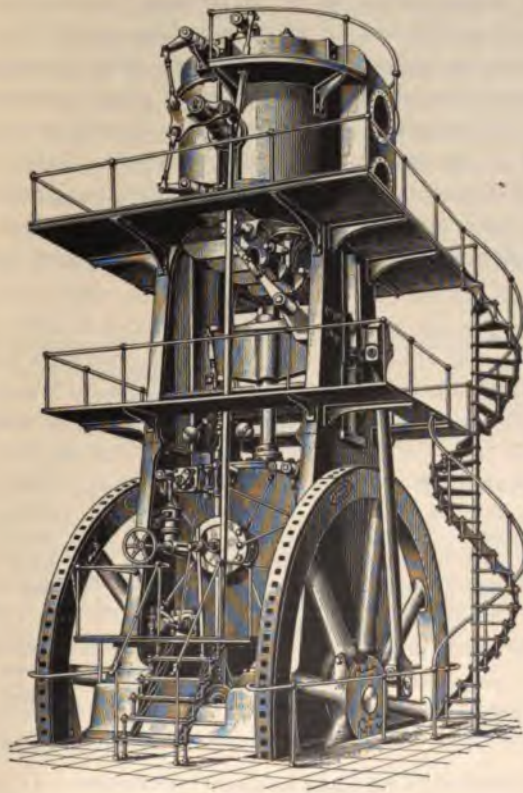

FIG. 5

10,000 heats; sometimes it may be cut through after a few heats. Repairs are required constantly, especially around the nose, which is injured by pouring the steel. Repairs are made with the regular lining, usually of ganister. After a vessel has been lined up or patched for the beginning of

a week, it is thoroughly dried out and made hot before metal can be poured in.

14. Blast.—This is furnished by vertical or horizontal blowing engines, generally the former, as they are more compact. Fig. 5 shows a common type of blowing engine. The blast is carried in an 8- or 10-inch pipe to the vessel; control of it is effected by suitable valves controlled by the blower from the pulpit. A pressure of 20 to 30 pounds per square inch is maintained in the blast pipe, as shown by a gauge on the pulpit. The pressure is varied according to the metal to be blown and the conditions of the vessel—depending on the bottom, number of tuyeres blanked, etc. The blow lasts from 7 to 12 minutes, but with very large heats or a deficient blowing capacity it may exceed the latter.

TABLE IV

Element	Initial Pig Iron	Time After Beginning to Blow				
		2 Minutes	3 Min. 20 Sec.	6 Min. 3 Sec.	8 Min. 8 Sec.	10 Min. 10 Sec.
Carbon....	2.98%	2.940%	2.710%	1.720%	.530%	.040%
Silicon.....	.94%	.630%	.330%	.030%	.030%	.020%
Manganese..	.43%	.090%	.040%	.030%	.010%	.010%
Phosphorus.	.10%	.104%	.106%	.106%	.107%	.108%
Sulphur....	.06%	.060%	.060%	.060%	.060%	.060%
Character of Flame From Converter		Silicon Flame	Brightening. (Carbon Starting)	Moderate Carbon Flame	Full Carbon Flame	Flame Drops

15. Chemical Changes in the Converter.—In general, the elements are oxidized in the same order as in the open-hearth process. In the acid Bessemer process silicon is first burned to SiO_2 , then manganese to MnO , and, simultaneously with this, some iron is oxidized, forming the slag with the SiO_2 and MnO . The silicon and manganese go largely together, the silicon first under ordinary conditions. The carbon is next oxidized with ordinary pig iron; the silicon

and manganese will be reduced to little more than traces before much carbon is burned, but with excessively high manganese the carbon will be largely burned before the manganese is gone.

Table IV shows the progressive removal of the elements in blowing.

A study of the table shows that the carbon burns very little until the silicon and manganese are practically gone. The beginning of the carbon to burn is called the *breaking through* of the flame, and when it is all burned, *the drop of the flame*. The latter point is sharp and marked so that an inexperienced eye can soon catch the point where the flame drops. While a slight increase in phosphorus is shown, it amounts only to the gain from concentration, i. e., the actual weight of phosphorus is the same in the blown metal as in the pig iron, whereas the weight of the latter is considerably less (about 8 per cent.) than that of the pig iron; this applies to sulphur also and there is usually a gain of both phosphorus and sulphur corresponding to the loss in blowing. This loss will depend mainly on the percentages of carbon, silicon, and manganese in the iron; the loss is not only the actual amounts of these, but iron is always oxidized; an increase of silicon calls for an increased amount of iron in the slag, as the silicon in forming the double silicate of iron and manganese takes up more iron, unless an unusual amount of manganese is present, as ferrous oxide FeO and manganous oxide MnO can replace each other to a large extent. The combined percentages of these two oxides in the slag amount to 30 or 35 per cent. in most cases, together with from 60 to 65 per cent. of SiO_2 .

16. . Temperature in the Converter.—Silicon is the great heat producer in the acid Bessemer process. The oxidation of carbon and manganese produce considerable heat—large quantities, in fact—but not enough for the reaction, as is clearly shown by the fact that a decided decrease in the percentage of silicon causes the metal to work cold. Formerly 2 and even 3 per cent. of silicon was considered

necessary to furnish the requisite heat, but this amount has been reduced so that the average metal going into the converter to be blown contains .9 to 1 per cent. This decrease has been due mainly to discontinuing the use of scrap and to more rapid work throughout the process. It leads to a great economy, as the loss is decreased not only by the lessened silicon, but by more than an equal amount of iron taken up by the slag. In the case of cold heats, *side blowing* is resorted to—the vessel is turned down to or approaching a horizontal position, until some of the tuyeres are exposed above the surface of the bath, and as the air is blown over its surface iron is oxidized, its burning producing heat. It is an expensive way to get temperature, but occasionally the only way to get out, as heats are sometimes unavoidably too low in silicon or blow cold from other causes, such as low temperature of the metal from mixer or cupola, cold converter, etc.

In using the higher silicon metal of former practice, the vessels were always scrapped; i. e., steel scrap from the rolling mill was thrown in during the progress of the blow. The amount was determined by the blower, who signaled a workman whose duty it was to throw in the weight required to cool the metal sufficiently. It acted simply by absorbing heat in melting, also by diluting the heat-forming elements in the bath. The present practice is to turn steam in with the blast. This method lessens the labor for handling scrap; and further, in the development of the open-hearth process it is more economical to use the scrap there. A lower silicon mixture can also be run more safely.

17. Recarbonizing.—Recarbonizing is done in the ladle; for low-carbon steels by the addition of heated ferromanganese, and for high-carbon and manganese steels by using melted spiegeleisen or pig iron; or, in the latter case, the recarbonizer is frequently poured into the vessel. The amounts necessary to furnish given percentages in the steel are given, together with the loss, etc., under the heading "Recarbonization."

18. Steel Ladle and Crane.—The ladle is of the ordinary shape of riveted plate steel and is poured from the bottom, as in the open-hearth. They are not usually bricked up, but are lined up with 3 or 4 inches of ball stuff consisting of ganister and clay. Patching is done with the same, or, more commonly, with loam. Electric traveling cranes have been installed for handling the iron to the vessels, and the steel for casting, but are not considered so well adapted as the older swinging hydraulic cranes. Generally, one crane pours the pig iron into the converter and another handles the steel ladle and pours the steel.

19. Casting, Etc.—This operation is common to both the Bessemer and open-hearth processes, and is accomplished in about the same manner. The older practice, and one that was universal until within the past few years, was to have a circular or a semicircular pit, with the steel crane in the center and the molds placed around its circumference, so that the crane could reach any part. The molds and heats were made to correspond, so that a heat would give an even number of ingots and avoid butts, which are either inconvenient to handle or must be remelted as scrap. Just as in the open-hearth process, or more correctly it was first done in the Bessemer process, practically all plants cast the ingots in molds carried on cars, two or three to each car. This method avoids a pit, always a dirty part of the plant; but economy is the controlling motive in such matters. The molds are pushed to the stripper, usually in a separate building, and removed from the molds, either the ingots being left standing on the cars and the molds removed and placed on other cars, or the mold and the ingot are both removed and the ingot pushed out on cars to be taken to the heating furnaces—the *soaking pit* or *pit furnace*.

20. General Arrangement of Plant.—Fig. 6 shows a common general arrangement of a Bessemer plant. Details of arrangement vary greatly with the judgment of the engineer designing the plant or limitations imposed by surroundings. In the plan shown, the four cupolas *a* are placed

at one side, and at right angles to them the two converters *b*. Opposite the latter is the pulpit *c*, from which the blower directs the blowing operations and controls the

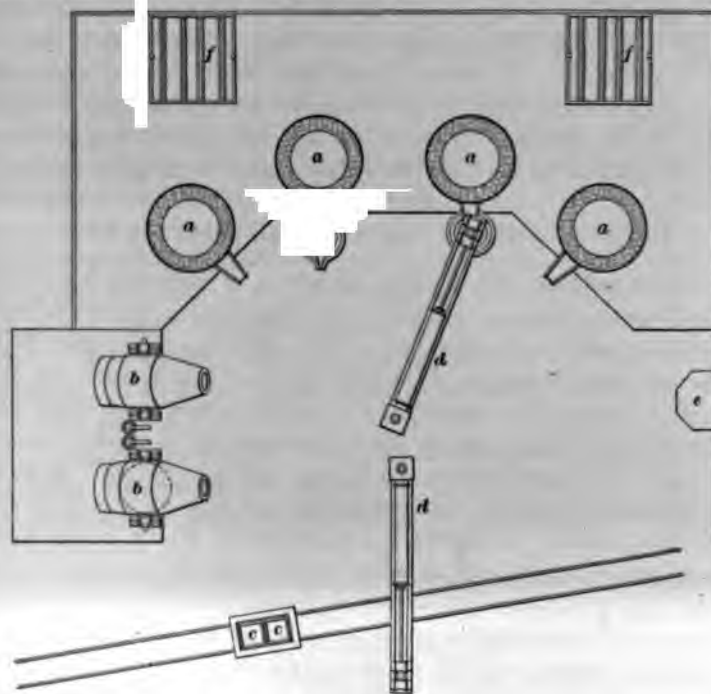

FIG. 6

cranes *d* for the iron and steel. Behind the cupolas are shown two lifts, or elevators *f*, for raising the stock to the cupola charging platform, and two molds *c* on a car, to be served by the steel crane *d*, are shown.

THE BASIC BESSEMER PROCESS

21. Introductory.—The basic Bessemer process bears the same relation to the acid Bessemer process as the basic open-hearth process does to the acid open-hearth. Conversion is accomplished in the same way as in the acid Bessemer process—by blowing air through the molten iron—with the

essential difference that purification is effected by introducing a lime charge; the basic slag resulting requires the use of a basic-lined vessel. It renders available for steel making irons entirely too high in phosphorus for the acid Bessemer process and also too high for economical use in the ordinary basic open-hearth process.

The presence of phosphorus in the pig iron in the early work of Bessemer seemed likely to render the pneumatic process a failure, and Bessemer gave considerable time to the removal of it. But on finding iron within the allowable limits of phosphorus required to produce steel, and that much suitable pig iron was available, he abandoned his experiments. As the process extended, low-phosphorus irons became relatively scarce and dear in England and on the Continent, so that many of the leading German and English metallurgists gave their efforts to dephosphorizing, but without success. While several accomplished it experimentally, no practical results were reached until Sidney Gilchrist Thomas, a young English metallurgist, achieved success in 1877-1878. Associated with him was his cousin, Percy C. Gilchrist, a steel-works chemist; and it was for a time known entirely as the *Thomas-Gilchrist process*, but later and at present as the *basic process*. It is an accepted fact that in 1872 George J. Snelus, one of the leading English steel metallurgists, discovered the means of dephosphorization by using lime in a converter. He did not, however, carry his experiments to final success, and the work of Thomas was carried on independent of this, so that he is entitled to full credit for originality. The principle of the basic process was first applied to the Bessemer and afterwards to the open-hearth process, the latter being now much the more important of the two basic processes. Germany has made the greatest development of the basic Bessemer process, mainly owing to available pig irons better adapted to it than to the basic open-hearth process. But two plants have been started in America, and neither is now in operation.

Thomas worked at intervals for 7 years on the problem of dephosphorization. He collected all the analytical and

On the subject, and soon came to the conclusion to eliminate phosphorus a strong base should be added to the charge, so as to retain the phosphorus and carry it off in the slag; also, that this demands either a basic-lined apparatus or one lined by the basic slag formed. After experiments in crucibles and later with small converters lined with the possible basic refractory material and using a variety of alkaline and alkaline-earth salts, Thomas finally settled on dolomite for the lining and lime for the basic flux. To successfully make this lining required a long trial with various admixtures and methods of treating the dolomite. After thorough calcination of the dolomite at a very high temperature, it is mixed with tar, molded into bricks, and these again burned at a heat that will sinter them.

22. Pig Iron Used.—The essentials in the pig iron are a low-silicon and high-phosphorus content. It was at first thought that moderate percentages of the latter (under 1 per cent.) could be used to advantage, but later practice demonstrated the necessity for 2 or 3 per cent. of phosphorus for the best results, as the oxidation of this element furnishes the bulk of the heat, instead of the silicon, as in the acid Bessemer process. Silicon could be almost, if not entirely, dispensed with, but it is impossible to make pig iron otherwise suitable (low enough in sulphur) without considerable silicon. It should be below .5 per cent. and should in no case exceed 1 per cent., the latter being too high for an average mixture. The chief reason why low silicon is imperative is on account of the lime used and the basic slag required, so that the smallest amount of silicon possible must be in the charge if a sufficiently basic slag is to be produced without an excessive use of lime. Manganese ranges in the practice of different works from .75 to 3 per cent.; from 1 to 2 per cent. may be taken as the usual limits. The higher manganese is required to furnish some of the heat required at the beginning of the blow—the low silicon

not giving enough heat at this stage, the manganese, being oxidized immediately after the silicon, supplies the deficiency. A further advantage is the desulphurizing tendency of manganese, as basic Bessemer pig is apt to be high in sulphur, owing to the low silicon required. Sulphur is removed to a slightly greater extent than in the basic open-hearth process, and may therefore be somewhat higher in the pig metal to produce the same sulphur content in the steel. It should not exceed .05 per cent. to make very low sulphur steel, nor .1 per cent. in any case. Carbon is somewhat lower than in ordinary pig iron, usually 3 to 3.5 per cent. Owing to the low silicon, high manganese, and phosphorus (all of which promote this tendency), the carbon is mostly combined, giving the pig a white or silvery-gray fracture. The pig iron is either melted in cupolas or taken directly from the blast furnaces, the same as in the acid Bessemer process. Table V gives the usual limits of analysis of pig irons.

TABLE V

ANALYSES OF BASIC BESSEMER PIG IRONS

Works	Silicon. Per Cent.	Manganese Per Cent.	Phosphorus. Per Cent.	Sulphur. Per Cent.
Middlesbrough, England.	1.0 to 1.3	.6 to 1.0	1.5 to 2.75	.050 to .12
Kladno, Austria.....	1.2 to 1.3	.3 to .5	1.5	.105
Witkowitz, Austria.....	.4 to .8	1.0 to 1.4	.9 to 3.40	.080 to .13
Hörde, Germany.....	.2 to 1.2	.5 to 3.0	1.2 to 2.60	.050 to .10
Creusot, France.....	1.3	1.5 to 2.0	2.5 to 3.00	.200
Pottstown, Pennsylvania	below .5	.8	2.5 to 3.00	.020 to .05

23. Basic Converter—Lining, Bottom, Tuyeres.—

The converter is constructed, the same as the acid vessel, of heavy plate steel mounted on trunnions so as to be rotated. Owing to the large amount of slag and the lime charge, it is from 50 to 60 per cent. larger than the acid converter for the same iron charge. The usual capacity is from 5 to

15 tons of metal. As the converter requires much more repairs than in the acid process, to run as continuously, three vessels are generally installed so that two may be available for use while the third is being relined. Another method, originally proposed by Holley, is to have the entire vessel removable, so that it may be taken away either by an overhead crane or on a car and a freshly lined vessel, relined and dried in a separate shop, substituted.

The lining is built up of basic bricks, made of lime, dolomite, or magnesia, using a mortar of the same, mixed with tar. More often, the lining is rammed in of the same basic materials mixed with a little clay and about 10 per cent. of anhydrous tar to give plasticity and act as a binder for the dead-burned material. The usual thickness of the lining is from 12 to 24 inches at the bottom and from 8 to 16 inches at the nose. Constant repairs are required between heats, using the lining material for this purpose.

A converter averages about 100 (75 to 125) heats on a lining, but occasionally gives out on the first heat or two. The slag destroys the lining, especially at the nose, by building up on it when pouring at the end of the blow, and on removing this, part of the lining is apt to come with it, or the slag, by not being sufficiently basic, rapidly attacks the lining.

The greatest difficulty in the early history of the basic Bessemer process was experienced in making the bottom. It is rammed up, similar to an acid bottom, of the same material as the lining—either the basic ball stuff with tar, or the basic brick and this together. It is rammed in layers until a thickness of 20 to 26 inches is obtained.

The tuyeres are the ordinary clay ones used in the acid process. Originally it was considered essential to use tuyeres of basic material, as it was held that clay would flux with the basic bottom; but the clay tuyeres have proved to be better and are much more economical. They are distributed over the bottom and the material is rammed around them, as in the acid-process furnace. Instead of using clay tuyeres, the bottom is sometimes rammed up around iron

er, and on withdrawing them, the
 yeres. The number and size corre-
 acid Bessemer process furnace. When
 as are dried and thoroughly burned before
 the converter.

Ing.—The first part of the operation, or the
 corresponds to the acid Bessemer process, when the
 manganese, and carbon are removed. The phos-
 is removed at a distinct stage and later termed the
blow. The blast is furnished from blowing engines,
 at a higher pressure (from 25 to 35 pounds per square
 inch) is required than in the acid process for the same
 size heat, depending on the size of heats, the shape of the
 vessel, etc. The burned lime is first introduced on the
 bottom, generally previously heated, or coke or coal charged
 with it and the blast slightly turned on to burn the latter
 and heat the lime charge. The latter varies from 10 to
 18 per cent. of the weight of metal and depends on the
 amount of silicon and phosphorus in the metal, as well as on
 the purity of the lime. The foreblow lasts from 10 to
 12 minutes, and the afterblow about 5, or the entire time of
 blowing averages from 15 to 18 minutes, although occasional
 blows last much longer, owing to variations in the charge,
 conditions of tuyeres, or other causes. If the metal is too
 hot, scrap is added during the blow, the same as in the acid
 process, to reduce the temperature. The metal should be
 as hot as possible during the first part of the blow, as this
 prevents *stopping* of the charge from the converter, but the
 temperature should be reduced before pouring the steel so
 as to give a sufficiently viscid slag to avoid rephosphoriza-
 tion in the ladle. Too fluid or too hot a slag will allow
 reactions to start in the ladle and some of the phosphorus to
 be reduced from the slag and returned to the metal.

The loss in blowing depends mainly on the character of the
 metal, and averages about 14 per cent. of the pig iron
 charged, but may vary from 11 to 19 per cent. In addition
 to the oxidation of the metalloids, iron is oxidized to form

the slag, the same as in the basic open-hearth process, the amount depending on the percentage of silicon and manganese in the pig—higher silicon requires more iron Fe , as well as calcium oxide, and higher manganese, less iron. In general, the slags correspond to basic open-hearth slags, but are higher in phosphorus, owing to the initial charge being so much higher in phosphorus.

25. In blowing, the conditions are judged from the character of the flame, as in the acid Bessemer process, for the foreblow, and regulated accordingly, by varying the blast or by addition of scrap. The afterblow, during which the phosphorus is oxidized, is determined entirely by the volume of air blown through the metal, and no attention is paid to the flame or other indications, for turning down the vessel. When the change comes, i. e., when the carbon flame drops (carbon being practically all oxidized), the revolutions of the blowing engines are shown by revolution counters placed in the pulpit, showing the blower the volume of air delivered. This is determined by experiment for different percentages of phosphorus, but is approximately one-half the length of the foreblow. In starting with a new mixture, when the blower judges the phosphorus to be removed, the vessel is turned down and a sample taken out with a test spoon or ladle and poured into a small mold. This is rapidly hammered out under a steam hammer, cooled quickly, and broken, a record is made of the number of blows required to break it, together with the character of the fracture indicating the degree of dephosphorization: if brittle and weak, the metal is *cold short* (high in phosphorus); a crystalline fracture light in color and having a general appearance soon recognized, but not easily described, shows to the experienced eye whether phosphorus is low enough, with almost the certainty of an analysis. This test having been made, the blow is continued or the steel poured as the result may indicate. After a number of blows the preliminary test is discontinued and the volume of air alone relied on for the dephosphorization, the analysis of previous

heats, reported before the succeeding heat is "turned down," being closely followed at the same time to check any variations in the charge or blowing. As phosphorus is the main heat producer, its percentage is regulated as the charge blows hot or cold from a variation of the other constituents—low initial temperature of the metal as it is poured into the converter, the rapidity of working, the condition of the bottom and the tuyeres, or other cause.

26. Oxidation of the Elements.—As previously indicated, the foreblow corresponds closely to the acid blow, the elements being oxidized in the same order. Silicon is the most readily oxidized and the first to burn, forming SiO_2 ,—which combines with iron and manganese to form ferrous and manganous silicates. The other elements cannot be oxidized to any great extent so long as any appreciable amount of silicon exists in the bath, as the oxides of iron, manganese, carbon, and phosphorus are all reduced by silicon. In the acid Bessemer process the only exception to the preceding (phosphorus not being affected) is that in the case of a very hot working charge. Carbon may be oxidized before all the silicon is, the affinity of the two for oxygen being reversed at very high temperatures. This, however, will rarely, if ever, occur in ordinary acid practice, and only with very high initial silicon; in basic practice it is much less likely, if not impossible, to occur, owing to the basic conditions existing.

Manganese is the next most easily oxidized element, and begins to burn before all the silicon is gone, but there must be silica present to form manganous silicate or the silicon will reduce any oxides of manganese as formed. Manganese is not oxidized as rapidly as in the acid Bessemer process, as the lime present, by keeping the slag basic, makes less demand for manganese. With low or moderate percentages of manganese (say under 1 per cent.), the most of it will be burned by the time the full carbon flame starts; with 2 or 3 per cent. of manganese, more will be burned with the carbon; in any case, the last tenth or two-tenths per cent.

remains nearly until the drop of the flame. Carbon is oxidized to carbon monoxide CO , and carbon dioxide CO_2 , after the silicon and part of the manganese are gone. Immediately after removal of the silicon, the carbon is oxidized mostly to carbon monoxide; and as the carbon in the charge decreases, the percentage of carbon monoxide in the escaping converter gases decreases; or the less carbon that there is in the bath, the more carbon dioxide is formed. Although the combustion of the carbon produces a large amount of heat, the bath gains a much smaller percentage of the heat thus produced than from the combustion of the elements yielding solid products, as the silicon, manganese, iron, and phosphorus. This is owing to the carbon combustion products escaping as gases (CO and CO_2) and carrying out the greater part of the heat produced by its combustion; this is especially true of the carbon burned to carbon monoxide, the bath retaining but little of this heat. This applies equally to the acid or basic Bessemer processes.

Phosphorus is oxidized to phosphorus pentoxide P_2O_5 and combined as calcium phosphate $Ca_3(PO_4)_2$, or ferrous phosphate $Fe_3(PO_4)_2$, but almost wholly as the former, though some authorities believe the latter is present to a considerable extent. The phosphorus cannot be oxidized until the other elements are completely removed. It exists in the iron as phosphide and is converted (during the afterblow) to phosphate; the latter would be reduced by silicide of iron or the carbides of iron or manganese to phosphide and returned to the metal if silicon and carbon were present. The fact that it cannot be oxidized while the other elements remain, although a basic slag exists, also indicates that it forms calcium phosphate entirely. Sulphur is removed to a considerable extent in regular basic Bessemer practice, and if the initial charge contains high manganese or if manganese is added at the close of the afterblow, much more is removed. It is further effected by an overblow, i. e., continuing the blow after the phosphorus is oxidized and at the expense of oxidizing iron, the slag, rich in ferrous oxide (and, better, manganous oxide), acting on the sulphur. In the acid

TABLE VI

After Beginning of Blow	Extent of Conversion	Silicon. Per Cent.	Manganese. Per Cent.	Carbon. Per Cent.	Phosphorus. Per Cent.	Sulphur. Per Cent.
Initial charge....		1.220	1.03	3.21	2.180	.080
2 min. 46 sec..	Desiliconizing or re- refining.....	.720	.71	3.30	2.150	.047
5 min. 21 sec..		.150	.50	3.12	2.220	.051
8 min. 5 sec..	Carbon flame starting.	.007	.18	2.47	2.160	.049
10 min. 45 sec..	Carbon flame full.....	.012	.16	1.49	2.100	.051
13 min. 28 sec..	Carbon flame drops....	.005	.14	.75	2.050	.051
15 min. 13 sec..	Afterblow.....	.008	.01	.05	1.910	.055
19 min. 14 sec..		.005	.01	.02	.230	.060
19 min. 31 sec..		.005		.02	.139	.055
19 min. 49 sec..		.004			.087	.056

process the overblow is the blow after the removal of the carbon; in either case an excessive oxidation of iron occurs; it may be done in addition to the above, either to give some heat or remove the last traces of carbon.

Table VI, which is taken from Wedding's "Basic Bessemer Process," shows the successive removal of the elements in blowing.

27. Action of the Basic Fluxes.—The functions of the basic lining—dolomite or lime—and the lime charge have already been given, the latter to effect the dephosphorization and the former that the necessary basic slag may be carried so as not to destroy the vessel's lining. The lime, of course, neutralizes the silica from the oxidation of the silicon in the pig. The percentage of silicon mainly determines the amount of lime to be used, but the phosphorus also must be taken care of by the lime charge; in practice, a considerable excess

TABLE VII

Number	SiO_2 , Per Cent.	P_2O_5 , Per Cent.	CaO , Per Cent.	MgO , Per Cent.	MnO , Per Cent.	FeO , Per Cent.	Fe_2O_3 , Per Cent.	CaS , Per Cent.
1	12.07	11.74	55.94	5.37	2.48	6.08	1.91	2.88
2	12.77	16.92	47.87	6.75	4.80	5.94	2.87	.09
3	7.35	16.79	50.66	7.13	4.71	7.85	3.98	1.06
4	7.20	19.20	49.00	3.75	4.26	9.00	4.83	.92

of lime is used so as to be on the safe side, as a deficiency will cause injury to or destruction of the lining as well as a failure to effect dephosphorization. It is held that the calcium phosphate can form only when the slag is saturated with bases to a lower silicate and an excess of lime is present. While phosphate of iron may be formed at first, it is gradually changed to calcium phosphate before the afterblow is completed—the iron being displaced by the stronger base. While there may be some question as to just how the different compounds exist in the slag, it is reasonably safe to

assume that iron and manganese combine as ferrous and manganous silicates, together with a part of the lime, to form an extremely basic silicate; another portion of the lime combines with the phosphorus; and the balance remains free to give additional basicity to the slag; a small amount forms calcium sulphide with part of the sulphur present.

Table VII, which is taken from Wedding's "Basic Bessemer Process," gives analyses of typical basic Bessemer slags.

28. Owing to the large percentage of phosphoric acid in the slag, it becomes a valuable by-product for fertilizing purposes; it is largely used for this purpose in Europe, where large quantities of it are produced. Many methods have been proposed for preparing the slag, but it is now ground in a ball mill to extreme fineness and applied in this form. As the phosphate is insoluble, only a part of it is available as plant food, and for this reason it is less valuable than soluble phosphates. In cases where the pig iron is not high enough in phosphorus, the slags are returned to the blast furnace and smelted over. The high percentage of lime and magnesia, usually from 55 to 60 per cent., make it of value as a flux, besides recovering the iron and manganese contained. If limestone is expensive and the pig iron is not made too high in phosphorus by using the slag in the blast furnace, this is frequently the most economical means for its disposal. This is governed by local conditions as to cost of flux and its value as a fertilizer.

29. Tropenas Process.—This process is adapted to making steel castings and is carried out in a special Bessemer vessel in which the blast of air is blown on top of the metal instead of through it. From very early in its history, top-blown or side-blown converters have been used at different times in the development of the Bessemer process. The Robert or Walrand converter is practically the same as, and an earlier one than, the Tropenas. The latter

is shown in Fig. 7 (a) in vertical section, while Fig. 7 (b) is a horizontal section through the lower wind box *e*. It has an upper and lower wind box *e* and *f* on one side of the vessel, from each of which horizontal tuyeres extend

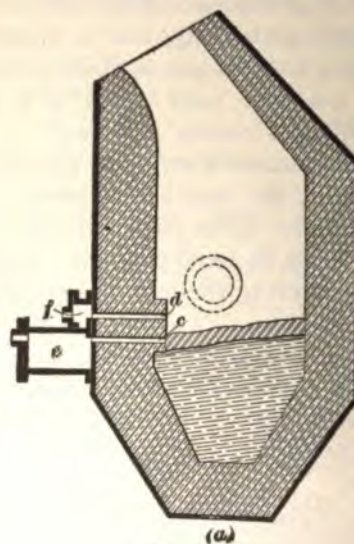
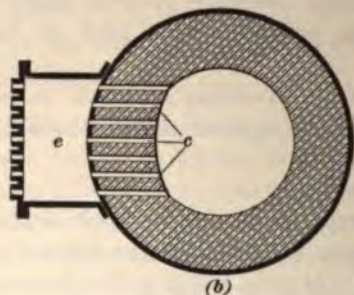

FIG. 7

through the side of the vessel. They are of large diameter, from $1\frac{1}{4}$ to 2 inches, and so placed that the ends are always above the bath. The upper row of tuyeres *d* are placed from 4 to 7 inches above the lower *c* and are not used until the metal is desiliconized by the lower row and the carbon flame starts, when air is admitted to the upper wind box to burn the carbon monoxide formed from the oxidation of the carbon. The purpose of this is to utilize the heat of the carbon monoxide, which is largely added to the bath by radiation. The blowing is stopped, as in the ordinary converter, when the carbon flame disappears; the recarbonization is made in the converter and the metal poured into a ladle for casting. It is claimed that a much

hotter metal is obtained than by the usual practice, that more delicate and intricate shapes can be cast from it, and that the quality of the metal is improved. The vessels are small—of 1 or 2 tons capacity. The advantages are the cheaper installation than an open-hearth, as the

converter may be placed in any foundry with a cupola to melt the pig iron. The pig metal used is from 2.5 to 3 per cent. silicon, .04 to .1 per cent. phosphorus, .03 to .06 per cent. sulphur, .5 to 1.25 per cent. manganese, and 3.5 to 4.25 per cent. carbon; it is the high silicon that gives the excessive temperature which permits pouring of difficult castings. Owing to the high silicon, the loss in blowing is excessive, reaching from 10 to 12.5 per cent. The metal is recarbonized to the same composition as ordinary castings. A low-blast pressure (3 or 4 pounds per square inch) is used. For making light castings the process is in use in many places in Europe and in ten or twelve works in America with some twenty converters.

RECARBONIZATION

30. General Remarks.—The term *recarbonization*, or *recarburization*, is used to cover more than the mere adding of carbon to the metal; all the ordinary additions, as of manganese and silicon in different alloys, are included. Perhaps a more exact term than recarbonizer would be *additions*, but the former has the sanction of usage. Its purpose is to give the metal the required properties as to strength and quality, and also that it may be handled in the subsequent operations of casting, rolling, forging, etc. The metal in the furnace or Bessemer converter after blowing in the condition of almost pure iron (generally containing but a few hundredths of a per cent. of impurities), is worthless for practical purposes and requires the various additions, depending on the use to which the steel is to be put. The recarbonizer is not only for the purpose of leaving certain amounts of carbon, manganese, or silicon in the metal, but also for removing objectionable compounds from it. These are gases and oxides of iron or other elements. Hydrogen, nitrogen, and carbon monoxide are commonly present in steel, rendering it *wild*, i. e., causing violent ebullition of the metal in the furnace, ladle, or molds. No theory as to their introduction or elimination is fully accepted, their

effect being neutralized or their removal accomplished by the additions. Oxygen, either as the free gas or in the form of oxides—metallic or gaseous—is the chief cause of wild steel, and the recarbonizer, acting as a deoxidizer, reduces these. Silicon and aluminum act in the same way (but their presence is not usually desired in the steel except in steel castings or in special steels), and are mostly removed by the action of the oxides in the bath.

31. The two general methods of recarbonization are, in the furnace or converter and in the ladle. In the Bessemer process, it is nearly always done in the ladle; the recarbonizer is thrown in as the metal is poured, so as to insure a better mixture. In the case of high-carbon or manganese steel, or where molten pig iron is used to furnish the carbon, it is frequently poured into the converter and a low blast turned on long enough (a few seconds) to thoroughly mix it with the metal, but not enough to cause any loss by the blast.

In the open-hearth process, a part or all of the recarbonizer is added in the furnace; if in part, the balance is added in the ladle. In the case of large heats, the addition is not heated whether thrown into the furnace or ladle, but with small heats it sometimes is. In Bessemer practice, it is either heated to redness for soft steel, or melted for rail or other steel high in carbon and manganese, where more is required. In general, when the recarbonizer is added to a large bath it is not necessary to preheat it; whereas with a relatively small bath, as in the Bessemer or small open-hearth furnaces, it must be heated or melted, according to the amount to be used, so as not to appreciably lower the temperature of the metal.

32. Recarbonizers.—The usual recarbonizers are: (1) *Ferromanganese*, an alloy of manganese, iron, and carbon; (2) *spiegeleisen*, the same as the preceding, except the amount of manganese is much less; (3) *ferrosilicon*, a very high-silicon pig iron; (4) *silicospiegel*, a very high-silicon

spiegeleisen, or a very high manganese ferrosilicon; (5) *carbide of silicon* (carborundum), an alloy of carbon and silicon produced in the electric furnace.

The first four are made in a regular iron blast furnace from properly selected ores and with special manipulation of the furnace and special burden. The fuel consumption is excessively high—usually two to three times that required for pig iron—and the output greatly reduced, which, with the higher cost of the ores, explains their high price—from three to five times the cost of pig iron.

Table VIII gives analyses showing the usual range of composition of recarbonizing alloys.

TABLE VIII

Alloy	Carbon. Per Cent.	Man- ganese. Per Cent.	Silicon. Per Cent.	Phos- phorus. Per Cent.	Sulphur. Per Cent.	Iron. Per Cent.
Ferromanganese..	6.5 to 7.0	78 to 82	.3 to 2	.20 to .3	.01	10.0 to 15
Spiegeleisen.....	4.0 to 5.0	12 to 20	.3 to 3	.15 to .3	.01	72.0 to 80
Ferrosilicon.....	1.5 to 2.5	1 to 4	10.0 to 20	.10 to .3	.01	75.0 to 85
Silicospiegel.....	2.0 to 4.0	15 to 20	10.0 to 15	.15 to .3	.01	65.0 to 75
Silicon carbide:...	62.0	trace	35.0	none	none	1.5

Alloys above 20 per cent. of manganese are usually classed as ferromanganese; below this, spiegeleisen. The standard ferromanganese is 80 per cent. manganese, and little else is used until we come to spiegeleisen, 20 per cent. In ferromanganese, between 20 and 80 per cent. of manganese is sometimes met with, but seldom at the present time. Owing to the conditions of manufacture, sulphur is never beyond a few thousandths of a per cent. Phosphorus is governed by the ores, but should not exceed .3 per cent., and this gives from .002 to .003 per cent. of phosphorus in the steel.

Carbide of silicon has only been used a few years, and finds considerable application as a source of carbon and silicon, especially in the manufacture of steel castings. It is always added in the ladle, and produces a violent reaction

if any considerable quantity is used. Its advantages are that a smaller amount is required for the same increase in silicon or carbon, and that the temperature of the steel is somewhat increased instead of lowered, as in the case of the metallic alloys. This increase is due to the heat developed by the combustion of silicon and carbon, but mainly to the fact that the decomposition of the compound releases a large amount of heat. Owing to the very high temperature at which the carbide is formed (6,500° F.), a large amount of energy is stored up as latent heat.

33. Recarbonization in the Furnace.—This method has certain advantages and drawbacks, as compared with making the addition in the ladle. With the heat ready to tap, the recarbonizer is thrown into the furnace and is allowed a few minutes to melt and mix with the bath. It is claimed for this practice that the manganese is more thoroughly mixed, the bath is more thoroughly deoxidized, the temperature of the metal is not lowered, and the metal is quieter and less likely to irregularities in casting. Against this claim there is said to be a greater loss of manganese, silicon, etc., than when the recarbonizer is added to the ladle. The loss will depend on conditions of the bath and time in the furnace before tapping. A bath containing a large amount of oxygen will oxidize more manganese or silicon than one nearly free from solid or gaseous oxides. A higher temperature, with other conditions constant, will also cause a greater loss. In making high-manganese steel, the actual weight lost is more, but the percentage of loss remains fairly constant, but increases somewhat for different amounts in the finished steel, i. e., when other conditions affecting the loss of manganese remain the same. In the acid open-hearth practice, the manganese is generally about all burned out of the bath, while in basic practice it will seldom be reduced below .1 per cent. and may be as high as .25 per cent., depending on the amount in the melting stock—mainly the pig iron. The recarbonizing loss in the acid is somewhat greater than in basic work, but for both it

may be taken at 30 or 40 per cent. of the manganese added. No hard-and-fast rule can be given for the amount of ferromanganese to be added for a given percentage in the steel, as the conditions stated above affect the loss, and the melter is guided by the conditions of the bath, the time in furnace, and the results from previous heats. The following examples from actual practice show the amount used:

1. A 32,000-pound charge in an acid-process furnace was taken, and from .36 to .4 per cent. of manganese was wanted in the steel. To effect this, 250 pounds of 80-per-cent. ferromanganese (which equals 200 pounds of metallic manganese) was added to the charge in the furnace. Assuming a loss of 40 per cent. of manganese, we have $.60 \times 200$, or 120 pounds of metallic manganese to be absorbed by the bath; $120 \div 32,000 = .00375$, or .375 per cent. of manganese in steel by calculation, allowing a loss of 40 per cent.; the analyses showed from .36 to .4 per cent. of manganese on a large number of heats, showing that the allowance of 40 per cent. loss was correct in this case.

2. With the same charge, from .28 to .3 per cent. of manganese was wanted. 175 pounds of 80-per-cent. ferromanganese, equal to 140 pounds of metallic manganese, was used. Taking the loss at 40 per cent., leaves 60 per cent., or $140 \times .60 = 84$ pounds of manganese to be absorbed. $84 \div 32,000 = .0026$, or .26 per cent. of manganese (calculated percentage); the steel analyzed from .28 to .3 per cent. manganese. Taking .29 per cent. as an average, then $32,000 \text{ pounds} \times .0029 = 93$ pounds of manganese in the steel. 140 pounds (the total manganese added) less 93 pounds (the amount actually in the steel) leaves 47 pounds, or 34 per cent. of manganese lost.

As stated, the loss of manganese in basic practice is less than in acid; the following heats illustrate this:

3. The heat is 75,000 pounds; .38 to .42 per cent. of manganese is wanted in the steel; 400 pounds of 80-per-cent. ferromanganese, equivalent to 320 pounds of metallic manganese, was added. In this case allowance must be made for

.1 per cent. of residual manganese in the bath, so that there is required from the ferromanganese 75,000 pounds \times .003, or 225 pounds of manganese. 320 pounds of manganese added less 225 pounds absorbed leaves 95 pounds, or 30 per cent. of manganese lost.

4. This heat also is 75,000 pounds, but from .58 to .62 per cent. of manganese is wanted. 650 pounds of 80-per-cent. ferromanganese, equivalent to 520 pounds of metallic manganese, was added. In this case the bath contained .15 per cent. of residual manganese; .60 per cent. less .15 per cent. equals .45 per cent. of manganese required from the ferromanganese, or 338 pounds. 520 pounds added less 338 pounds in the steel, leaves 182 pounds, or 35 per cent. of manganese lost.

Table IX shows the manganese additions and losses for the four heats just given.

TABLE IX

Heat	Process Used	Weight of Charge. Pounds	Pounds of Manganese Added	Equivalent in Percentage of Heat	Manganese in the Steel		Manganese Lost	
					Per Cent.	Per Cent. From Ferroman- gane	Per Cent. of Heat	Per Cent. of Amount of Amount Added
1	acid	32,000	140	.44	.29	.29	.16	34
2	acid	32,000	200	.63	.38	.38	.25	40
3	basic	75,000	320	.43	.40	.30	.13	30
4	basic	75,000	520	.69	.60	.45	.24	35

Numbers 3 and 4 had, respectively, .1 and .15 per cent. of manganese left in the bath; figures are given to the second place, or the nearest whole number. The larger the amount of manganese added, the greater is the loss when other conditions remain uniform. This is shown in the table, as well as the greater loss for acid heats. It would be useless to attempt a definite statement on these points or as to the amount of manganese to be used for a given percentage in

the steel. To go further, it may be stated that the ordinary loss of manganese when added in the furnace is from 30 to 40 per cent., which may be increased or decreased by variations in the practice, melting conditions, etc.

34. Recarbonization in the Ladle.—In the Bessemer process the recarbonization is done in the ladle entirely for soft steel and almost entirely for high-carbon steel. In the acid or the basic open-hearth practice, many steel makers prefer to make all the addition in the furnace, while many others add a part of the ferromanganese in the furnace and a part in the ladle, generally about half in each; the latter, while not universal, is the more general practice; a few add the entire amount in the ladle.

35. Loss of Manganese.—With manganese, the only advantage of recarbonizing in the ladle is the economy, as the loss is less and may be taken at from 15 to 30 per cent., or from 10 to 15 per cent. less than in the furnace. The ferromanganese is not exposed to the action of the flame and much less to the slag, and the action of the metal must be less vigorous in the ladle than in the furnace; all of which

TABLE X

Heat	Process Used	Weight of Charge, Pounds	Pounds of Manganese Added	Equivalent in Percentage of Heat	Manganese in the Steel		Manganese Lost	
					Per Cent.	Per Cent. From Ferroman- gane	Per Cent. of Heat.	Per Cent. of Amount Added
1	acid	60,000	260	.43	.35	.35	.08	19
2	acid	60,000	325	.54	.42	.42	.12	26
3	basic	80,000	304	.38	.36	.28	.10	26
4	basic	80,000	375	.47	.48	.36	.11	24

go to explain the smaller loss. For medium- and large-size open-hearth heats the recarbonizer is not usually heated, but thrown into the ladle, so as to mix with the stream of metal. Occasionally it will be heated to redness, or always

so when the amount is excessive in the case of high-manganese or silicon steel. Table X shows a record of heats recarbonized in the ladle.

Heats 3 and 4 retained, respectively, .08 and .12 per cent. of manganese in the bath.

36. Loss of Silicon.—In steel castings, or other steel requiring an addition of silicon, it may be added in the furnace or ladle in the form of any of the silicon alloys mentioned under "Recarbonizers." In the Bessemer process it is usually added in the ladle, but may be thrown into the converter with a gentle blast on for a few seconds, as it is oxidized very quickly. This is sometimes done with cold heats or casting heats wanted excessively hot. The loss of silicon in the vessel or furnace depends mainly on the time in the bath, and is subject to wider variations than is manganese, as silicon is more readily attacked than manganese. It may be taken approximately at 50 per cent. of the amount added, and working under uniform conditions, is readily controlled, but variations in the practice of different plants give different results. In the basic process the loss is higher than in the acid, owing to the slag having a greater affinity for SiO_2 . If it is added in the ladle, the loss is much less (from 25 to 40 per cent.). In using carbide of silicon, the loss is from 50 to 60 per cent. of the silicon.

37. Control of Carbon.—So far no account has been taken of carbon. A certain amount is added with the ferromanganese, the use of an 80-per-cent. ferromanganese raising the manganese about 12 to 15 times as much as the carbon; while spiegeleisen will give 3 or 4 times, owing to the lower ratio of manganese to carbon. While 80-per-cent. ferromanganese may be used in recarbonizing all grades of steel, its distinctive use is for soft steel, where the desired manganese content can be given without raising the carbon appreciably. To get the carbon wanted, when above very soft steel, molten pig metal was formerly poured into the converter, and in the open-hearth the heat was caught coming

down, i. e., at about the desired carbon, or pig iron added to the bath. In Bessemer practice, this method is largely followed yet for rails and other high-carbon steel. The steel is blown down soft, i. e., practically all the carbon burned out (down to .05 or .08 per cent. of carbon), and the necessary amount of melted spiegeleisen and pig iron poured in and the converter turned over to mix the addition, or the latter may be poured into the ladle at the same time as the blown metal and the mixing accomplished there.

38. An alternate method is the adding of solid carbon in the form of crushed coke or anthracite. This is the **Darby method** of recarbonizing, but the name of the inventor is seldom mentioned in connection with it, although it was only developed in 1888. The coke or coal is weighed into ordinary paper sacks of a weight that each sackful will give .01 or .02 per cent. of carbon to the steel; these are then thrown into the ladle as the steel is poured. About one-half the carbon is absorbed by the steel, this depending somewhat on the temperature—a very hot heat taking up more than a cold one. In the open-hearth the practice varies between (1) tapping when the carbon has been boiled down a few points (hundredths of a per cent.) below that wanted in the finished steel, and (2) boiling the heat down to about .1 per cent. of carbon and recarbonizing back in the ladle with coke or anthracite. In making high-carbon steel in the open-hearth, say from .5 to 1 per cent. of carbon, the second method is not practicable for all the carbon, and the heat is always caught coming down and only a part or none added, as required. Usually, it is not attempted to make steel over .40 per cent. carbon by adding all the carbon in the ladle when the heat has been blown (in the Bessemer) or boiled down (in the open-hearth) soft, i. e., to about .1 per cent. carbon, which means recarbonizing about .3 per cent. The heat may be tapped, of course, between that wanted in the steel and .1 per cent. carbon, and whatever coke or anthracite is needed is added in the ladle. Table XI shows the additions in the ladle for carbon, loss, etc.

TABLE XI

No. of Test	Process Used	Weight of Charge. Pounds	Carbon in Bath. Per Cent.	Carbon Required in Steel. Per Cent.	Coke or Anthracite Added. Pounds	Carbon Absorbed. Per Cent.
1	open-hearth	60,000	.10	.20	100	56
2	open-hearth	60,000	.15	.24	90	47
3	open-hearth	110,000	.10	.18	150	52
4	open-hearth	110,000	.75	.90	325	52
5	Bessemer	22,000	.08	.35	140	46
6	Bessemer	22,000	.08	.22	60	52

The amount added will be governed somewhat by the percentage of manganese in the steel and whether furnished by ferromanganese or spiegeleisen, the latter adding more carbon for the same amount of manganese than ferromanganese. In the above table, .02 per cent. carbon is allowed for the ferromanganese used. The coal or coke contained 85 per cent. of carbon.

TABLE XII

Weight of Heat. Pounds	Wanted in Steel		Amount Added to Heat	
	Carbon. Per Cent.	Manganese. Per Cent.	Spiegeleisen. Pounds	Pig Iron. Pounds
10,000	.30	.65	400	150
16,000	.45	.70	650	900
22,000	.40	.75	1,000	800
22,000	.50	.90	1,200	1,150
32,000	.45	.80	1,500	1,500
32,000	.50	1.00	1,800	1,400

39. Table XII shows the amount of liquid pig iron or spiegeleisen used to recarbonize—generally used in Bessemer plants making rails or other high-carbon steel regularly.

In this case spiegeleisen is preferred as a source of manganese, owing to the higher carbon per unit of manganese. About 90 per cent. of the carbon is absorbed, as it is already in solution and only has to mix with the larger body of blown metal and no chemical action or absorption has to take place; the loss of manganese is less than if added cold or only heated to redness. The carbon is taken at about .08 per cent. in blown metal; spiegeleisen, 5 per cent. carbon, 20 per cent. manganese; pig iron, 3.5 per cent. carbon.

It should be remembered that the weights of the recarbonizing additions are subject to change, as results obtained are higher or lower than wanted, and working conditions—temperature, pig iron, blowing, and manner in which additions are made—affect loss of carbon and manganese.

40. Use of Aluminum.—Metallic aluminum is very generally used for quieting basic steel and, to some extent, acid steel also. It acts as a deoxidizer and belongs under recarbonizers in the general use of the term. 100 parts of oxygen combines with 87.5 parts of silicon; 100 parts of oxygen combines with 112 parts of aluminum; 100 parts of oxygen combines with 344 parts of manganese. While a given amount of silicon will combine with more oxygen than the same amount of aluminum, the latter has a much greater affinity for oxygen under the conditions and is therefore the more powerful deoxidizer; but it is the least apt to remain in the steel if oxides or free oxygen are present. It is always added in the ladle or molds, from 2 to 5 ounces per ton being used. If much above this is added, it causes too rapid solidification and defects from piping and cracking. In addition to removing gases and making the steel quiet, it has the property of rapidly permeating the entire mass of the steel, which causes other elements to alloy more uniformly, preventing or lessening segregation; it gives sounder ingot tops, thus lessening the loss as scrap; and it also slightly increases the strength of the steel.

THE CRUCIBLE PROCESS

41. General Remarks.—The crucible process is the oldest and simplest of the three principal ones, both in apparatus employed and in manipulation. It consists essentially in melting the stock in a crucible set in a bed of coke or anthracite on the bottom of a vertical or shaft furnace. It may be broadly defined as melting an iron either high in carbon, requiring no recarbonizer, or melting one low in carbon, demanding recarbonization. A number of melting holes are constructed together and connected by flues to a stack, thus forming the furnace. At present, it may be said that practically all crucible-steel melting furnaces are of the Siemens regenerative gas type.

42. Crucible Furnace.—The furnace contains from two to twenty holes, taking four or six crucibles each. Each hole has its own gas and air regenerators, so that it is practically a separate furnace, but all the holes of a furnace have a common stack and main flues. Sometimes separate valves for controlling the gas and air to each set of checkers are provided, but more commonly the one set, *c* for gas and *d* for air, as shown in Fig. 8, are put in for the entire furnace. The dampers *f* are placed in the air and gas flues to the stack. Fig. 8 (*a*) shows a cross-section of the furnace and pair of regenerators, *a'* for air and *g'* for gas on each side of a melting hole; *p* and *p'* are gas and air ports, respectively; *i* are flues under checkers leading to the stack. Fig. 8 (*b*) is a longitudinal section on the line *AB*, showing four melting holes, the gas and air valves *a* and *g*, respectively, and stack *s*. Each hole *o* has two or three (the latter number in the figure) movable arched coverings, or *bungs* *j*, of firebrick held by clamps, which are lifted by hooks suspended on a trolley for charging and drawing the crucibles. Six or eight inches of coke dust is placed on the bottom of each melting hole, in the center of which is a hole *h*, so that if a crucible breaks, the steel runs into the vault *v* running the length of the furnace; this is cleaned out at the

end of each week. The melting holes are separated by cross walls *k*.

43. Crucibles.—These are of clay and graphite. Clay crucibles are quite commonly used in England and in Europe

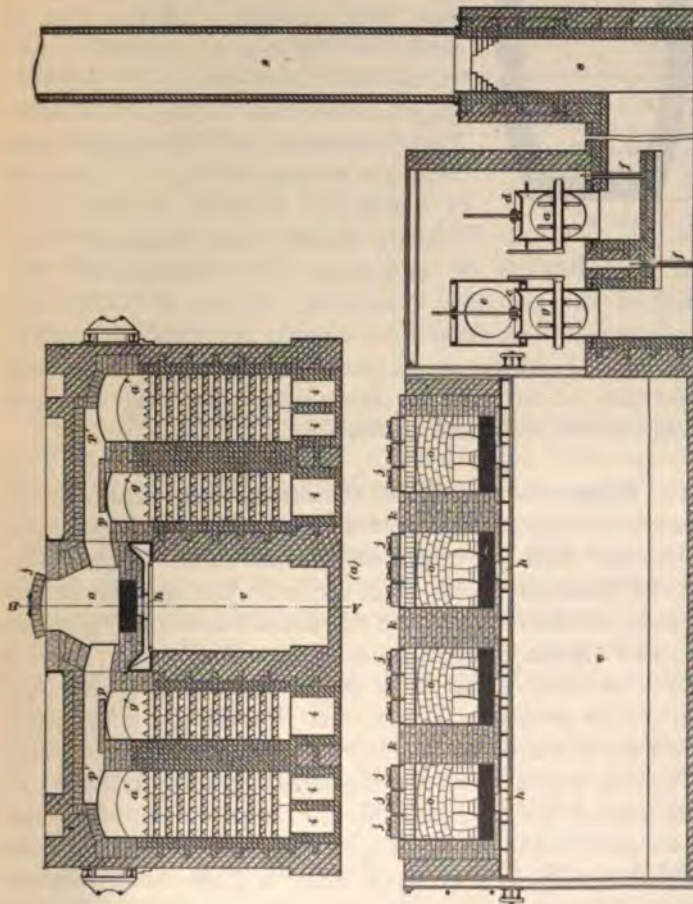

FIG. 8

generally. In America, graphite crucibles are exclusively used. They cost more than clay, but last longer and are stronger, thus allowing larger ones to be used. The clay crucible is held to be tougher at a steel-melting heat,

but is very weak when cold, the walls not standing the sudden contraction as well as the graphite, and if used



FIG. 9

over, must be returned to the furnace as soon as the charge is poured. They are more apt to break in the furnace also, causing a greater loss of steel from this source. Crucibles ordinarily hold from 80 to 125 pounds; the walls are from 1 to 1½ inches thick. The dimensions of a 100-pound crucible are shown in Fig. 9. The life of a graphite crucible is from 3 to 8 heats usually, and frequently only

one. This depends on a number of circumstances: the quality of the crucible, depending on the materials and manufacture; the kind of steel melted; they having a longer life with high-carbon steel; whether plunged into a very hot furnace or brought up more gradually; and the care and skill of the *puller out* in drawing.

44. Materials of Which Crucibles Are Made.—Crucibles are made from a mixture of about 50 per cent. graphite, 35 to 40 per cent. clay, and the balance sand. This varies with the practice of the manufacturer, the quality of the materials, and somewhat with the results desired. Graphite is the well-known mineral quite widely distributed. It is a form of carbon. The best is the Ceylon graphite, but much native graphite is used. It is found in many parts of the United States, especially in Wisconsin and New York. The Ceylon product is the most valuable, not only owing to higher purity, but the laminated, or elastic, fibrous structure serves to bind the matrix of clay more firmly than the amorphous graphite, which is held to give much inferior results. It should be ground rather fine, as if left too coarse the crucible may become porous; if too fine, the walls are too dense and it does not expand or contract so quickly when exposed to sudden heating or cooling, and cracking results; heat is conducted more slowly also.

Table XIII gives the analyses of several samples of graphite. The more impure graphite is concentrated by dressing, consisting in air floating or treating by wet methods. The impurities accompanying it are generally iron pyrites, gneiss, or limestone.

TABLE XIII

Source	Carbon. Per Cent.	Ash. Per Cent.	Volatile Matter. Per Cent.
Ceylon.....	99.68	.21	.11
Canada.....	97.63	1.78	.59
German (raw).....	53.80		
German (dressed).....	89.20		

Up to the present time most of the clay used in crucible making has been imported from Europe, although some New Jersey, but more particularly Missouri and Colorado, clays have had a limited use. There appears no good reason from composition and properties why many of our native clays should not be used. As in many other industrial enterprises, the manufacturer is influenced by prejudice and tradition. Kaolin is used to give the proper fusibility to the mixture. Good crucible clay must be strong and plastic as well as refractory. It is a silicate of aluminum with small percentages of other bases and a large amount of combined water, which gives the plasticity. The objectionable constituents are oxide of iron, alkalies, and alkaline earths, as they all reduce the refractory qualities.

Table XIV gives analyses of standard clays and kaolins used in crucible making.

Of these samples, number 1 was the famous Crown brand from Kluengenbergl, Germany; 2 and 3, the Rhenish clay, Germany; 4, the Meisner clay, Germany; 5, kaolin from Staten Island; and 6, kaolin from Brandywine, Pennsylvania.

The sand used is the ordinary fire, or silica, sand having from 95 to 99 per cent. of silica with small amounts of alumina, alkaline earths, or combined water. Oxide of iron and alkalis are the most detrimental constituents, as they lower the fusing point, if present beyond a small amount.

TABLE XIV

Number of Sample	SiO_2 , Per Cent.	Al_2O_3 , Per Cent.	FeO or Fe_2O_3 , Per Cent.	Al_2O_3 + Fe_2O_3 , Per Cent.	CaO , Per Cent.	MgO , Per Cent.	Comb. H_2O and Organic Mat., Per Cent.	Moisture at $100^\circ C$, Per Cent.	TiO_2 , Per Cent.	Alkalies, Per Cent.
1	59.20	25.40	1.71		.52	.42	8.34	4.14		
2	46.99	30.04	2.14		.59	.55	11.69	4.18	3.00	.81
3	45.53			36.15	.25	.50	10.48	5.82		1.75
4	54.51	31.42	.68		.04	.43	12.37			.55
5	85.24			11.20	.72	.27		.45		1.26
6	65.80	22.09	1.58		.27	.32	7.09	.19		2.35

45. Manufacture of Crucibles.—This includes the four processes of mixing, molding, drying, and burning. The ingredients are mixed by paste mixers and clay-working machinery to a thoroughly homogeneous mass, water being added to temper it properly; the batch when ready for molding contains about 22 per cent. of water.

Molding was formerly a hand operation, but at the present time is mostly done by various machines, jigs, presses, etc. The shapes, being quite simple, are readily formed by molds and shapers with the machines.

The drying of the green crucibles must be done very carefully, as the shrinkage is so great it may so distort the crucible as to render it useless or crack it. The average shrinkage is about 5 per cent. from the water used in mixing, but mostly from the combined water of the clay.

The burning requires the same care as the drying, and may be considered the final stage of the latter. It is done in some of the types of pottery kilns, the fuel being wood, gas, or coal; if the last, the sulphur must not be excessive, or

the crucibles may be injuriously affected by its absorption. They are usually in the kiln 5 or 6 days—being fired at a gradually increasing heat for about 3, and the kiln or oven allowed to cool slowly for 2 or 3 days. The temperature reaches about 750° or 800° C. (say 1,400° or 1,500° F.), and is only required to take the entire shrinkage out of the clay. Coming from the kiln, the crucibles have a color ranging from a gray to a dark drab, depending partly on the temperature, but much more on the character of the flame maintained—if oxidizing to any extent the graphite will be burned from the surface, giving the light color of the clay body; if a reducing flame was kept during the firing, the crucibles will be darker colored, depending on the amount of graphite oxidized. Kilns are constructed to admit as little air as possible in excess of that required to effect combustion of the fuel, so as to reduce the oxidizing effect on the crucibles.

46. Crucible Charge.—The materials for making crucible steel are chiefly puddled iron and wrought iron and steel scrap, together with the necessary amount of carbon, usually charcoal; manganese, as ferromanganese or oxide of manganese; or other additions. Blister steel, made by the cementation process of soaking iron bars with carbon in a converting furnace at a red heat, was originally used, and is even yet to a small extent in America, and quite largely in the original home of crucible-steel making, Sheffield, England. It is also held that the very highest grade of crucible steel can only be produced from blister steel made from the purest Swedish irons, even though other iron or soft steel may be produced of the same composition. It is impossible to give any satisfactory reason for this, and it has been attributed to prejudice and usage handed down through many years. As those best competent to judge, and to whose interest it would be to use other stock, insist that the higher priced Swedish irons give better tool steel, the fact can only be accepted, with the statement that our methods of examination are not perfect enough—whether

chemical, physical, or microscopical—to show us the distinctions or combinations that give this superiority. Comparatively little of the latter stock is used in this country in crucible melting, but the fact is of sufficient importance to be brought out prominently. The materials are usually very low in sulphur and phosphorus, as none is removed; it is an acid process, although basic crucibles have been used together with a basic slag to effect purification, but this has scarcely been more than an experiment, and has no promise of commercial value or technical importance.

The crucible is carefully filled with the stock while cold and then inserted into the melting hole. The practice in England is to first place the crucible in the furnace, and when it has been heated somewhat, to introduce the charge by means of a sheet-iron funnel. As clay crucibles are generally used there, this allows a preliminary test before charging and defective ones may be thrown out.

Packing the cold crucible outside the furnace allows the stock to be more carefully placed, the larger pieces and the charcoal for carbonizing and any oxide of manganese or ferromanganese used on the bottom; the smaller and closer fitting pieces are packed on top and likely serve to keep any gases from penetrating into the metal; also oxygen from the charcoal, lessening the loss of the latter. The crucible is then set in the melting hole by means of tongs. In the regenerative furnace they are set directly on the coke-breeze covering the bottom, or in a shaft furnace they are partially embedded in the glowing anthracite or coke.

47. Melting.—This is generally divided into the subdivisions of *melting* and *killing*, or *dead-melting*. With the crucible in the melting hole, a cover is put on it to keep out the gases. The temperature of the furnace is gradually brought up, if a gas furnace, by adjusting the gas and air supply, and draft, if necessary, to give the proper melting conditions. In the case of a coke hole, the solid fuel is piled up around the crucible to its top; if coke, it must be replenished two or three times during melting; anthracite, owing

to its compact structure, does not have to be renewed for one melting. When the melter judges the charge about melted, the covers are removed and the contents of the crucibles examined to see their condition. The trained eye of the melter at once recognizes the condition of the steel, whether completely melted or if the temperature is too high or too low, and adjusts the furnace conditions accordingly. Sometimes the eye alone is depended on for temperature, or a light iron rod is introduced and stirred around in the metal, as in the open-hearth process. If the metal is very hot, little or no steel adheres to the rod or it may be melted off sharply at the end; if cold, the metal is sluggish and pasty, building up on the rod and adhering to it when withdrawn.

48. Killing, or Dead-Melting.—This is simply holding the steel at a melting temperature until a change occurs that gives sound ingots or castings. The change is doubtless the simple one of the gases being boiled out of solution in the metal. This action is probably assisted by the absorption of silicon reduced by carbon from the SiO_2 of the crucible walls. The effect of killing is also held to be that the silicon absorbed increases the power of the metal to hold gas in solution, enabling it to retain while solidifying any gas in the molten steel. This last explanation, while given by high authority, cannot be held to be proved or better grounded than the simpler one of boiling out any gas in solution. The latter is commonly accepted by practical steel metallurgists.

The melting time is usually from $2\frac{1}{4}$ to 3 hours. This depends on a number of conditions, but principally (1) whether hard or soft steel is being made—soft (low-carbon) steel may require $\frac{3}{4}$ hour longer for melting than hard (high-carbon) steel, as the wrought-iron or other very low-carbon stock of the former melts at a much higher temperature than high-carbon stock; (2) the presence of manganese as oxide or in the metallic state shortens the time; (3) the furnace and its manipulation; (4) to a less extent than the preceding, the character of the stock aside

from its composition, size of pieces, packing, etc.; the crucible—thickness of walls, their composition, etc.

There is no absolute line between the melting proper and the killing, as this is interpreted by the judgment of the melter, and the two periods overlap to some extent. Killing usually takes from $\frac{1}{2}$ to 1 hour—it may be longer or shorter, depending on conditions. Other conditions being the same, the hotter the furnace, the shorter is the time required for the killing; the purer the steel, the longer is the time required, doubtless owing to the higher temperature necessary to bring the desired condition, which may be merely the question of an ebullition to get the gases out; the lower the charge is in phosphorus, sulphur, silicon, manganese, or carbon, the more heat is required to give the same degree of boil. The entire time in the furnace from charging to drawing is generally from $2\frac{1}{2}$ to $3\frac{1}{2}$ hours, so that three charges are usually melted each 12-hour shift, or turn, some little time being required between drawing and a subsequent charging for teeming and some fixing of the coke bottom in most cases.

49. Teeming, or Pouring.—This operation is accomplished by lifting the crucibles out of the melting holes by suitable tongs, picking them up with another pair, and pouring into the molds for ingots or castings. It is done almost universally by manual labor and is some of the hardest and hottest work of steel manufacture, as the “pullerout” must straddle the melting hole while withdrawing the crucible. Cranes with special tongs have been used to some extent for charging and drawing; their use is not yet common, however, but will undoubtedly become so. The molds are of a size to hold the contents of one or several crucibles, in the case of larger ingots, or a number of crucibles poured into one casting. Crucible-steel ingots of 90 tons have been made at the Krupp Works, Germany, requiring some 2,000 hundred-pound crucibles. In such a case, the most careful selection of the stock is essential to insure uniformity of the ingot; and perfect organization and discipline of the

large number of men, so as to have the teeming done with sufficient promptness. Such ingots are made only there, and are used for armor plate. Many others of large size are made for high-grade forgings, such as engine shafts, propeller shafts, and other marine forgings, also guns and gun forgings. In America, such materials requiring large masses of steel are always made of open-hearth steel. In the ordinary crucible shop, making tool steel mainly, the ingots are about 3 or $4\frac{1}{2}$ inches square and the weight of one or more crucibles full. The molds are split lengthwise and held together by rings keyed on. Before teeming and while separated they are smoked by burning rosin, coal tar, or a smoky gas flame; this acts as a mold wash and gives a better surfaced ingot.

50. The loss in melting is very low—the least of any steel process—usually being from 1 to 3 per cent. of the weight of metal charged. The cost of melting is the highest of any process, approximately from \$5 to \$6 per ton, or from three to five times the labor cost in the Bessemer or open-hearth process. The fuel consumption is high compared with the latter, about 1 pound of coal as producer gas per pound of steel, or about 15,000 cubic feet of natural gas per ton of steel melted; approximately, three times the amount required for open-hearth melting. The above factors, together with the limited output and the higher priced melting stock that must be used, explains the comparatively limited field of crucible steel, which is restricted to purposes where the first cost of the steel can be ignored—mainly tools, fine springs, saws, files, fine machinery parts, etc.

51. Superiority of Crucible Steel.—While no fully satisfactory reason has been given for the superiority of crucible over other grades of steel of like composition, the causes generally given are: (1) The purer stock melted; (2) as the crucible is covered during the melting, the gases from the fire have very little chance to be absorbed by the metal.

It seems safe to say that to the conditions of melting are principally due the finer quality of crucible steel. In regard to the purer stock, there can be no direct comparison with Bessemer or open-hearth steel, as it is impossible to make either from the usual crucible stock without the use of other materials. But in the crucible process the melting receptacle is closed and all gases are largely kept from the steel, whereas in the Bessemer process the air is blown through the molten metal, exposing it to the oxygen and nitrogen of the blast, the solid and gaseous products of combustion, some of which are undoubtedly absorbed, affecting the properties of the steel. In the open-hearth process much the same conditions may be found, except that the gas for oxidation plays over the surface of the bath.

52. The widest ranges of composition are possible, and obtained regularly by varying the mixture. Carbon may be from .1 to 2.25 per cent., but as practically all crucible steel is used for tools or purposes requiring similar grades, we may restrict the carbon between .4 and 1.5 per cent. as covering the bulk of the product. Manganese varies between .1 and .75 per cent., but most grades are below .6 per cent; silicon, between a few hundredths of a per cent. and .2 per cent., although considerable is made above this, not including silicon steel. Sulphur and phosphorus are each kept below .02 per cent. as a rule, but for less exacting purposes this is frequently exceeded, but seldom above .05 per cent. of either element is allowed. In the highest grades, where the purest Swedish melting stock is used, sulphur and phosphorus may not exceed .01 per cent. The effects of impurities are decidedly more marked in high-carbon steel than in low; the metal seems to be more sensitive, and the same amount of sulphur, phosphorus, or silicon influences the properties more.

53. Crucible steel is divided into different grades, according to temper or carbon content, one temper generally meaning .1 per cent. carbon. In determining the grades of the steel, the ingots are broken, or topped, and graded by the

fracture. Sometimes color carbon tests are made, but most crucible shops use the fracture for grading purposes, and an experienced eye seldom misses the carbon more than .05 per cent. While no sharp subdivisions exist as to the uses to which different grades of crucible steel are put, the following shows them in a general way:

Steel of from .5 to .75 per cent. carbon is used for battering tools, hot work, dull-edge cutting tools, etc.

That from .75 to 1 per cent. carbon is used for dies, axes, knives, drills, and similar purposes.

That from 1 to 1.5 per cent. carbon is used for razors, lathe tools, gravers' tools, little drills, etc.

The best all-around tool steel is between .9 and 1.1 per cent. carbon, and is capable of being adapted to a wider range of uses than any other grade. Between .9 and 1 per cent. carbon iron is saturated with carbon, giving the best results in tools and highest strength.

Table XV shows the analyses of various crucible steels and purpose used for.

TABLE XV

Use	Carbon. Per Cent.	Manganese. Per Cent.	Silicon. Per Cent.	Sulphur. Per Cent.	Phosphorus. Per Cent.	Tungsten. Per Cent.	Nickel. Per Cent.	Chromium. Per Cent.
Sledges, battering tools, etc.....	.50	.21	.210	.022	.020			
Hot work shear knives, etc.....	.65	.20	.180	.020	.015			
Drills, reamers, dies, etc.....	.85	.18	.210	.015	.014			
Chisels, knives, lathe tools, etc.....	1.00	.26	.200	.010	.010			
Razor steel.....	1.30	.22	.200	.006	.009			
Dies, graving tools, etc.....	1.30	.16	.140	.014	.012			
Cutting tools, etc. (self-hardening)...	.94	1.50	.160	.015	.012	3.40		
Krupp armor.....	.28	.32	.055	.016	.015		3.60	1.75

While the above are analyses of samples for the uses indicated, the composition of steel for the same purpose will vary within considerable limits, depending on the practice of the steel maker, but more especially on that of the user, as to tempering and the exact use to which it is put, speed of machine, if a cutting tool or machine part, and character of work to be done by drills, tools, etc. Different manufacturers will produce the same quality of steel or give the same properties, by varying the percentages of carbon, silicon, or manganese. In general, manganese, silicon, sulphur, and phosphorus fluctuate but little, carbon being the variable element that gives the desired temper. In Table XV only low manganese is given among carbon steels. Occasionally crucible steel is made with manganese from .3 to 1 per cent. (not considering alloy steels), but practically all of it contains .2 to .3 per cent. of manganese. Sulphur and phosphorus sometimes exceed the amount shown in the commoner grades, and in extra-special grades both are regularly kept at from .005 to .008 per cent.

ALLOY STEELS

54. General Remarks.—By alloy steels are meant steels that owe their special properties to the presence of other elements than carbon. The carbon, however, generally plays an important part in these special or alloy steels, while in the ordinary or carbon tool steels their properties are due almost wholly to the carbon present.

55. Tungsten Steel.—In some respects the most important of these is self-hardening steel, sometimes known as *mushet steel*. It is a steel that hardens without quenching in water or other liquid, when previously heated to the right temperature, in this case to about a medium orange color. It owes this property to tungsten and is sometimes called *tungsten* or *air-quenched steel*. It is sometimes quenched in a blast of air, to give greater hardness than if allowed to cool in quiet air. It may be made much harder still by

quenching in oil or water, but the strains set up within it are sufficient to overbalance its cohesive power and cracking results, or it is so brittle as to crumble when used. It is so hard when air quenched that it cannot be machined or touched by the hardest carbon steel. By annealing it at about a bright-orange heat for from 24 to 36 hours, and cooling very slowly by covering it in the furnace with hot sand or ashes it will be annealed so that it can be machined quite readily. It becomes brittle at the full steel-working temperature or below an orange color. It can be worked readily between an orange and bright-orange heat. As its use is restricted to cutting and machine tools, they are forged as nearly to the desired shape and size as possible and are then ground to the exact dimensions. It is not as strong as good high-carbon steel; while it can be made *hard* enough by water quenching to cut chilled cast iron, the cutting tool will not stand up to the work, the edge crumbling down. Its chief advantage is that its temper is retained at relatively high temperatures almost to a visible red, where a plain carbon steel would have its temper lowered so as to be useless until retempered; this enables it to do more work at high speeds, allowing lathes, planers, boring mills, etc. to be run much faster or heavier cuts to be taken, which means great economy in the machine shop.

56. Tungsten itself is not believed to be directly the hardener, but indirectly through its action on the carbon and manganese. Steel has been made low in carbon and manganese, with 3 per cent. of tungsten that would not temper even when quenched in water; raising the carbon but leaving the manganese low, it would harden like ordinary carbon steel, but not in air; the addition of $2\frac{1}{2}$ or 3 per cent. of manganese gave the usual self-hardening steel, showing that manganese and carbon are essential for the tungsten to perform its part in air quenching, or that it acts indirectly by its effect on carbon and manganese.

In regard to the hardness being retained at quite high temperatures, the tungsten has been called "the mordant

that holds the carbon in solution"; with plain carbon steel, working at a high speed or severe duty, and the tool getting hot, the carbon in effect comes *out of solution* and the temper is lost; whereas, with the tungsten holding the carbon *in solution* the temper is retained.

The percentage of tungsten may vary from .1 to 10 per cent., the latter being very unusual and difficult to obtain. It is usually from 3 to 5 per cent. It may be introduced in the crucible in the form of ferrotungsten (an iron-tungsten-manganese alloy), or as the mineral wolframite, tungstic oxide WO_4 , associated with more or less iron and manganese. This is readily reduced by the carbon of the charcoal or the crucible walls: $WO_4 + 4C = W + 4CO$. Both methods are used in practice. The carbon is governed by the temper desired; manganese is always over 1 per cent. and may exceed 3, usually 1.5 or 2.5 per cent.; silicon, sulphur, and phosphorus are the same as in carbon steel.

57. Manganese Steel.—Steel containing much above 1.25 per cent. of manganese is nearly as brittle and unworkable as spiegeleisen until it reaches from 5.5 to 6.5 per cent. of manganese, when it improves so that a tough product is obtained—between 6.5 and 20 per cent. of manganese. From 7 to 14 per cent. of manganese gives the best results. This is perhaps the most unique alloy met with in steel, possessing both hardness and toughness beyond that of any other. It is so hard that no steel tool will touch it, yet so tough that castings, forgings, etc. made of it may be bent and hammered like the softest of mild steel. These two qualities are directly antagonistic when either is present to an extreme degree in all iron alloys known up to this time. The maximum strength is obtained at about 13 or 14 per cent. of manganese, and the composition of the greater part made is from 12 to 14 per cent. The steel is necessarily high in carbon from the fact that the ferromanganese used is high in carbon. The carbon is about one-twelfth of the manganese; the latter may vary, however, from 10 to 15 times the

percentage of carbon depending on the grade of ferromanganese used.

58. The steel is water quenched to secure the extreme hardness and toughness; it is sometimes so in its natural condition, i. e., as cast, but quenching always improves it. This is another peculiarity of the metal, as in all other steel an increase in hardness means an increase in brittleness—a decrease of ductility and elasticity. Its hardness is not so much added to by quenching as its ductility. The steel is practically non-magnetic under the strongest influences. Its use is necessarily restricted to parts not requiring machining—castings and forgings, mainly, that do not require finishing to extremely exact sizes. It works readily at a red heat. Its principal uses are for the jaws or working parts of crushing and grinding machinery; cheeks and plates of rock crushers, edge mills, etc.; car wheels, axles, and tires to a limited extent; in general, where strength with great hardness or ductility, or both, are required. One of the more recent uses is in the manufacture of safes and vaults, a purpose to which it seems especially suited when the construction difficulties are overcome. It may be made in the crucible, but as quite large masses are produced, the open-hearth is the more suitable apparatus, and therefore is always used. Owing to the large amount of manganese, solid castings are readily produced; the metal is extremely fluid, allowing small and light castings to be made. Its shrinkage is excessive, about $\frac{3}{8}$ inch to the foot, thus adding to casting difficulties. It was originated by R. A. Hadfield, of Sheffield, England, and is commonly known as *Hadfield's manganese steel*.

59. Nickel Steel.—This steel is used chiefly for armor plate, but has a large use besides in forgings and castings. It raises the strength about 50 per cent. over that of ordinary steel of the same carbon content; it also increases the elasticity and ductility. The amount present is usually from 3 to 4 per cent. It has been used to some extent for

car axles and boiler steel for very high pressures, but cannot be said to be fully accepted for either purpose. Engine and propeller shafts are largely made of it or other forgings or castings requiring a particularly strong and ductile steel. It is made almost entirely by the open-hearth process, but may be made by either the Bessemer or crucible processes. The nickel is added in the form of metallic nickel or ferronickel, which is charged with the rest of the stock, practically no loss occurring in melting. The steel works readily hot or cold, forges easily, and machines harder than carbon steel.

60. Chrome Steel.—Chrome steel is used somewhat for tools, but mainly for giving very hard surfaces and to resist severe shocks. Its chief use is for armor plate and projectiles; also very hard dies, mortars for crushing very hard materials, etc. For tools, it is manufactured in the crucible; but for armor plate in the open-hearth furnace (except possibly Krupp uses the crucible). The chromium is added as ferrochrome; if in the open-hearth, after the desired carbon has been reached, as chromium oxidizes easily and the loss is heavy. The amount present is usually from 1.5 to 2 per cent.

61. Silicon Steel.—Silicon steel has been made containing 1 or 2 per cent. of silicon, but it has no extended use. It gives a very hard steel, but workable hot with difficulty—hot short. It is made by the crucible process.

62. Molybdenum Steel.—This steel is made to some extent for special uses and possesses properties somewhat similar to tungsten steel, but is tougher. It is used for some high-grade saws and a very few other purposes. It is alloyed in amounts ranging from a few tenths of a per cent. up to about 3 per cent.

63. Other Alloy Steels.—Aluminum, copper, and titanium steels have been made experimentally, but are of no use as yet.

MANUFACTURE OF STEEL

(PART 3)

STEEL CASTINGS

1. General Remarks.—The manufacture of steel castings is an important branch of the industry, both technically and commercially. Casting steels are produced by exactly the same methods and apparatus as other grades of steel, similar stock being used, in either the acid or basic open-hearth, Bessemer, or crucible processes. As a matter of fact, the bulk of steel castings are made by the open-hearth process, although both the other processes contribute some. With the advance in engineering construction of all kinds, ordinary iron castings cannot be given the strength required; consequently, steel is being used for purposes where high duty is required. It is largely used for gear-wheels of all kinds, engine frames and parts, locomotive driving-wheel centers, in electric and ship construction to some extent, where forgings were formerly used, rolling-mill and other heavy machinery, and, in fact, steel castings may be substituted for iron castings of any description where strength is an important factor. The cost of the steel castings is necessarily greater, or it would supplant gray iron even further than it has. In addition to increased strength, parts may be made much lighter than from iron for the same strength, thus making the weight of a finished machine or structure much less, which is in many cases a consideration of scarcely less importance than strength.

§ 35

For notice of copyright, see page immediately following the title page.

The basic open-hearth steel is used to some and an increasing extent, but the acid open-hearth steel is the most used. This is due to earlier troubles with the former process, and makers have not had the confidence to use it, especially when the spoiling of the steel means the further loss of the foundry labor of molding, etc. The regular Bessemer steel is not used in any shop on steel castings exclusively, but some plants making ingots make occasional casting heats. Several modified Bessemer processes have been used in regular casting practice, one, the Tropenas, which has met with much success, has already been described.

2. Solidity.—In making castings, it is essential that the steel lies comparatively dead in the molds, with little action, otherwise the product will be more or less honeycombed with blowholes, caused by the escaping gases. To overcome this, the special knowledge and art of the maker of steel castings are necessary. It is accomplished by the use of deoxidants, or deoxidizers, which remove the gases while the steel is molten, or increase the power of the metal for holding them in solution.

Solidity is further due to a riser or sink head made on top of the runner, or gate, so that it is above the casting, and as the latter cools and contracts metal flows in from the sink head and fills up the shrinkage cavity. The weight of the sink head depends on the size and character of the casting. It may amount to 50 per cent. of the weight of the latter, but is usually from 15 to 30 per cent. As its function is to supply molten metal to the contracting casting, it must be large enough to remain open until the casting sets, and also have enough liquid steel to supply the demands due to shrinkage of the latter. The deoxidizers, silicon, aluminum, and manganese, remove the gases or increase the solvent power of the steel for them. While their action is not absolutely understood, they produce solidity by either or both these actions. All steel in the melted state has in solution gases, and its power to hold them so is largely dependent on the temperature. Killing in the crucible

removes them (possibly with the aid of silicon), and solid ingots or castings are produced. This effect is reached in open-hearth or Bessemer castings by the use of silicon or manganese in the form of some of the recarbonizing alloys or additions given under "Recarbonizers"; or by adding metallic aluminum, all of which come under the general head of recarbonizers or deoxidizers. An excessive amount of these cannot be used, or the metal will be made brittle from the overdose or possibly from retaining too much of the gases; yet it will be perfectly solid and free from blowholes. The latter may not lessen the strength and toughness of castings to the extent their presence would indicate, but in parts to be machined or to have finished surfaces, their presence is entirely unallowable. Carbide of silicon is used in some steel foundries as the sole source of silicon and part of the carbon; in others, silicospiegel for silicon and manganese, or ferrosilicon for the silicon, and spiegeleisen or ferromanganese for the manganese.

3. Composition of Casting Steel.—The composition of the steel depends, as in other grades, on the use to which the same is to be put. For very soft castings, where great toughness and ductility are required, but not high tensile strength, the carbon may be as low as .12 per cent.; where stiffness and great strength are wanted and ductility is of less importance, carbon may be as high as .8 per cent. For ordinary purposes and covering castings for most uses, the carbon is from .2 to .5 per cent. The amount of silicon will vary with the carbon, as a rule, from .1 to .4 per cent.—the low-carbon steel having the less, and the harder (high-carbon) the more, silicon. The usual range is from .2 to .3 per cent.

The amount of manganese present is usually .5 to .8 per cent., but it may be outside these limits. Some castings are made with from 1 to 1.25 per cent. of manganese, and are air quenched to toughen them; i. e., heated to a cherry red and allowed to cool in the air. The amount of phosphorus may reach the usual Bessemer steel limit of .1 per

cent., but the best castings should not exceed .04 per cent., which is readily attained in basic practice, but in the acid requires the use of higher-priced stock. Phosphorus is held to produce brittleness under shock, and is therefore especially objectionable in castings subject to sudden strain or shock.

Sulphur is of less importance in castings than in most other grades of steel, as its influence is felt mainly in working at a red heat, and does not greatly affect the cold steel when present in moderate amounts. Its usual range is from .025 to .05 per cent., and should not exceed the latter very much. Aluminum is added frequently as a solidifier (deoxidizer), equivalent to from .02 to .03 per cent. (from 4 to 10 ounces to the ton of steel), but this is mainly oxidized to Al_2O_3 in the slag, and the small amount in the steel cannot be accurately determined. As in all ordinary steels, carbon is the principal strengthener, manganese, silicon, and sometimes aluminum give solidity and freedom from blowholes.

Nickel-steel castings are made to a limited extent where greater strength and toughness is wanted than is given by plain carbon castings. It is used for pinions on heavy rolling mills or for parts subject to sudden and severe shock. The nickel is usually from 3 to 4 per cent. in such steel.

Table I gives the analyses of some steel castings.

TABLE I

Kind of Casting	Carbon. Per Cent.	Manga- nese. Per Cent.	Silicon Per Cent.	Sulphur. Per Cent.	Phos- phorus. Per Cent.
Machinery castings...	.18	.30	.28	.032	.082
Machinery castings...	.24	.60	.30	.040	.045
Rolls.....	.48	.45	.31	.036	.032
Rolls.....	.75	.80	.28	.040	.050
Pinions.....	.26	.45	.27	.056	.060
Pinions.....	.44	.74	.33	.045	.092

DEFECTS IN STEEL

4. Segregation.—Unfortunately for the metallurgist and user, large masses of steel are never absolutely homogeneous, and frequently wide variations are shown between different parts of the same ingot. This difference in the composition, or the tendency of certain elements to separate out, is known as *segregation*. Occasionally it is so serious as to render a part of the ingot unfit for use, but generally, when proper care has been exercised in making and handling the steel, its effects are not dangerous. With other conditions the same, the larger the ingot, the greater is the segregation. With very heavy ingots for armor plate, forgings, or where great homogeneity and reliability are required, a portion of the top is cut off for scrap or to be used for inferior purposes.

The causes of segregation are fairly well understood; it is due mainly to the lower melting points of the iron carbides, phosphides, and sulphides. As the metal freezes, these, by remaining fluid at lower temperatures, are squeezed out and collect in the part of the ingot last to solidify, which is usually the upper central part, approximately the upper fourth or fifth of the ingot. It occurs without any regularity and the laws governing it are not understood. In general, the greater the percentage of metalloids, the greater is the liability to segregation and the more serious it will be. If the steel in the ingot could be instantly solidified, without otherwise injuring its properties, segregation would be avoided; so that slow cooling favors the separation of the impurities; and as their specific gravity is less, they have a tendency when once formed to rise through the body of metal.

5. The term segregation should be confined to those irregularities occurring after pouring into ingots or castings, as distinguished from irregularities in the furnace or ladle. The latter may be due to careless melting, or addition of recarbonizers in such a way as not to be uniformly distributed throughout the metal; while evils of this kind have

been charged to segregation, it is well established that a thoroughly uniform metal is generally gotten in the ladle and there is little excuse for variation there. The same cannot be said of the steel after it has been poured, as the conditions under which segregation takes place are only partially under the control of the metallurgist. The condition favoring homogeneity is that the steel remains molten the least possible time permissible. If made to solidify too quickly, as bad or worse consequences follow—cracking, the formation of excessive blowholes, and piping. Casting at excessively high temperatures or in very large masses are the principal causes of segregation, and keeping both within reasonable limits is the chief remedy for it. Both act by keeping the steel longer in the liquid state, allowing more favorable opportunities for the compounds of lower melting points to separate out, i. e., mainly the carbides, phosphides, and sulphides; manganese and silicon segregating to a less extent. There is no rule or law yet known that controls the order or extent to which the different elements segregate; but in most cases it occurs as follows: Carbon, phosphorus, sulphur, silicon, and manganese—both as to liability of its taking place and the extent of it. There are many exceptions, but generally it takes place as above. When excessive segregation of one element is found, others are to be looked for with it, but this does not always occur. The use of aluminum, by lessening the time the steel remains fluid in the molds and causing it to solidify more evenly, diminishes the evil.

6. In Tables II, III, and IV, examples are given of some extreme cases. It must not be assumed that all steel segregates seriously because no examples of uniformity are given. While all masses of large size vary somewhat and absolute homogeneity is never expected, yet for practical purposes steel may be assumed as being uniform, the many exceptions either proving the rule or are to be explained by special circumstances in the manufacture, chiefly casting temperature and mass.

TABLE II
EXAMPLES OF SEGREGATION

Description	Carbon. Per Cent.	Phosphorus. Per Cent.	Sulphur. Per Cent.	Silicon. Per Cent.	Manganese. Per Cent.
Bessemer ingot, weighing 4,500 pounds	top.....	.10	.145	.110	.47
	middle.....	.08	.110	.085	.46
	bottom.....	.08	.105	.075	.45
Bessemer ingot, weighing 4,500 pounds	top.....	.20	.085	.072	.46
	middle.....	.18	.082	.065	.45
	bottom.....	.18	.075	.066	.46
Acid open-hearth ingot, weighing 2,000 pounds	top.....	.55	.060	.048	.54
	middle.....	.38	.060	.042	.48
	bottom.....	.37	.058	.042	.45
Acid open-hearth ingot, weighing 2,000 pounds	top.....	.26	.114	.067	.37
	middle.....	.14	.060	.027	.33
	bottom.....	.13	.049	.025	.34
Basic open-hearth ingot, weighing 3,000 pounds	top.....	.45	.020	.030	.37
	middle.....	.25	.020	.025	.38
	bottom.....	.20	.015	.023	.36
Basic open-hearth ingot, weighing 6,000 pounds	top.....	.26	.040	.054	.44
	middle.....	.18	.024	.035	.39
	bottom.....	.18	.024	.030	.39

Table II shows sections through the ingot at the points indicated, the top being about one-fifth of the distance from the upper end of the ingot, or usual point of the greatest segregation. Drillings were taken from the center of each section.

TABLE III

EXAMPLES OF CARBON SEGREGATION

Number of Ingots	Top of Ingot		Bottom of Ingot	
	Outside. Per Cent. Carbon	Center. Per Cent. Carbon	Outside. Per Cent. Carbon	Center. Per Cent. Carbon
1	.37	.55	.50	.51
2	.50	.60	.50	.55
3	.55	.60	.50	.50
4	.55	.63	.45	.60
5	.50	.56	.42	.62
6	.45	.62	.40	.60
7	.50	.52	.55	.55
8	.55	.55	.55	.55
Average	.50	.58	.48	.56

7. The variation is not entirely from top to bottom, but also from outside to center—a shell chilling next the iron mold first and the interior of the ingot remaining fluid, the carbides, phosphides, etc., owing to their lower melting points, are pushed out of the solidifying mass and enmeshed in the gradually freezing steel. Table III illustrates this for carbon, and when other elements segregate, their variation corresponds to carbon as a rule, but is usually less in amount. The eight ingots in this table were from the same heat, the regular ladle analysis showing .56 per cent. of carbon.

TABLE IV

SEGREGATION OF STEEL CASTINGS

Description	Carbon. Per Cent.	Phos- phorus. Per Cent.	Sulphur. Per Cent.	Man- ganese. Per Cent.	Silicon. Per Cent.
Broken steel roll, center	1.25	.048	.060	.58	.15
Broken steel roll, outside90	.030	.048	.55	.13
Broken steel roll, end opp. break44	.035	.042	.52	.14
Broken steel roll, center65	.331	.165	.85	.33
Broken steel roll, outside44	.070	.046	.54	.27
Broken steel roll, end19	.063	.036	.52	.24
Steel pinions, center17	.060	.056	.45	.27
Steel pinions, outside26	.050	.050	.44	.27

The foregoing castings weighed from 4,000 to 6,000 pounds and afforded opportunities for segregation similar to large ingots. In steel castings of medium and small size, segregation is practically absent, as the mass is liquid a much shorter time. It is generally less in castings, as the metal is partially killed with silicon or aluminum, so that the freezing interval is less.

8. Blowholes.—*Blowholes* are small cavities, usually spherical in shape, formed in the ingot as the steel solidifies, and are caused by bubbles of gas unable to escape through the frozen mass. They may be due to some extent to air drawn down mechanically by the stream of metal while pouring, but are generally accepted as coming from gases either formed or escaping from the solution as the metal sets in the mold. The principal gases are nitrogen and hydrogen, but carbon monoxide is considered by some authorities as playing an important part. Blowholes in low-carbon steel cannot be prevented and do not cause injury to the steel, as the inner surfaces of the cavities cannot oxidize and are readily welded together by subsequent rolling or forging. The purer the steel, other things being the same, the more blowholes will be formed; high carbon, silicon, or

manganese usually causes the steel to lie quiet and be free from blowholes. Dead-melting decreases the number of blowholes, crucible steel being almost free from them; any addition causing the steel to lie quiet (kill or deaden it) will decrease them. Blowholes are not to be regarded as altogether objectionable, but rather as a necessary condition, especially in the soft and medium grades of steel, and their removal or prevention may be harmful. If a steel ingot be broken, there will be found a solid skin, usually from $\frac{1}{4}$ to 1 inch thick around the outside, depending mainly on temperature of casting; with excessively hot steel it will be very thin, and thicker with steel at normal casting temperature. Next to this skin are the blowholes, or *honeycomb*, extending around the ingot; they may spread well into the middle, depending on the kind of steel and temperature in pouring. As stated above, their volume will be greater with soft steel. If brought too near the surface by very hot steel, the skin is so thin that in reheating and rolling this is removed or rolled into the honeycomb or blowholes, exposing these on the surfaces of plates, a serious defect in the latter, known as *pitting* from the small holes, or pits.

9. Pipes.—Pipes are shrinkage cavities in the upper central part of ingots, formed after the outside has solidified. The exact relation between blowholes and pipes cannot be explained, but in general steel that does not form blowholes, pipes more or less, and vice versa. As examples of this, crucible steel is free from blowholes, but pipes more or less deeply; high-carbon or silicon steel exhibits the same tendency; also, conditions in the same steel that lessen the tendency to form blowholes generally increase the liability to pipe; e. g., the addition of silicon or aluminum for quieting steel lessens the former, but induces piping, and this may be quite marked even in soft steel, if an excessive amount of silicon or aluminum is added. As a rule, the fewer and smaller the blowholes, the greater the piping. Extremes of casting temperature—either too hot or too cold—increase both blowholes and piping.

10. Prevention of the Formation of Pipes and Blow-holes.—The precautions mentioned above—regulation of the temperature mainly and certain additions—are the only ones observed to control or prevent these two conditions in ordinary practice. Many means have been tried, but the only one used to any extent is the Whitworth system of liquid compression, in which the steel is cast in strongly reinforced molds or cylinders and while still fluid subjected to a pressure reaching 1,500 pounds per square inch from a powerful hydraulic press. This prevents both blowholes and piping by producing perfectly solid ingots, at the same time giving more uniform composition. Its use is limited, and mainly, if not wholly, restricted to very large ingots for heavy forgings, such as marine shafts, large guns, etc.

EFFECTS OF THE USUAL ELEMENTS PRESENT IN STEEL

11. General Remarks.—Only those elements commonly found in ordinary commercial steels will be considered here, all reference to special or alloy steels being omitted. The constituents affecting the properties, and those usually present in ordinary carbon steel, are carbon, manganese, sulphur, phosphorus, silicon, and oxide of iron; copper and nickel, being present in considerable steel, will be included. While each element has its own distinctive effect, it is frequently difficult or impossible to determine just what this is in given steels, as the effect will be so modified by the amount of one or more of the others present or the almost endless combinations of different percentages of the elements. Conditions in the making and subsequent treatment in rolling, hammering, cooling, etc. mask or exaggerate the influence of given amounts. There are, however, certain well-defined effects for the different elements, and these will be given as generally accepted by metallurgists.

12. Carbon.—This is by far the most important of the elements in steel. It combines in all proportions up to about 2 per cent., but seldom exceeds 1 per cent., except in tool or special steels (ferromanganese may contain 7, or pure iron combine with 4.5 per cent.). It is readily absorbed at or above a red heat and the metal does not have to be liquid; manganese increases the affinity of iron for carbon. In common steel the carbon is present as combined carbon, though small amounts of graphite may occasionally be present. Carbon increases the strength and hardness, but decreases the ductility. Strength is increased up to .9 or 1 per cent. carbon; above this it diminishes; the melting point of steel is lowered by carbon; the nearer we approach pure iron, the higher is the melting point. An increase of strength and a loss of ductility and elasticity go together with carbon steel.

13. Manganese.—Manganese increases the strength and ductility of steel, but its chief function is the effect it has on other elements, mainly oxygen or oxides and sulphur, acting as an antidote for *red shortness*—brittleness at a red heat. Manganese alloys are used to recarbonize and remove oxygen from the bath, although some of the latter always remains, and the residual manganese neutralizes its effect and that of sulphur. Sulphur and phosphorus tend to produce coarse crystallization, and manganese seems to prevent this, giving a fine-grained fracture. It increases the rolling qualities or hot working of any kind, i. e., gives *hot ductility*; it also allows steel to be heated hotter without injury. Steel with very low manganese will crack in rolling or forging along the edges, whereas the same metal with higher manganese will usually work satisfactorily. While manganese is not a panacea for bad steel, nor will it cover up the effects of improper working or too high impurities, it is the most essential addition in correcting necessary evils—e. g., the presence of sulphur and oxygen or oxides. In soft steel, manganese ranges from .3 to .6 per cent.; in hard and medium steels, rails, forgings, etc., from .4 to 1 per

cent. While no definite rule exists as to sulphur and manganese, approximately 8 to 10 times as much manganese as sulphur is allowed.

14. Sulphur.—The effect of sulphur is felt when working at a red heat, for with it the metal cracks and tears and welds much less readily. The remedy was given in discussing the effects of manganese on steel, or rather a corrective, as this is notably a case where “prevention is better than cure.” The percentage allowable will depend on the steel and the purpose for which it is to be used. In a great deal of ordinary steel it may reach .08 per cent. without serious injury, but should always be kept as low as possible; in other steel, for plates, etc., it frequently must be kept below .03 per cent. The cold properties of steel are practically not affected; the strength is increased slightly. Steel high in sulphur will seldom get through the rolling mill. That the sulphur is exceedingly injurious for very many purposes is seen from the fact that red shortness will throw it out in the mill from cracking, etc. For wood screws and generally where the product must be threaded, rather high sulphur is an advantage, say up to .1 per cent. This appears to be due to the fact that the steel is less tenacious and does not gall or tear as does tougher steel; it also takes a better polish. Manganese also helps in the latter process.

15. Phosphorus.—In some respects phosphorus is the most objectionable impurity in steel. Its most marked effect is in producing a cold-short metal or one brittle at ordinary temperatures. It does not affect the hot working unless present in excessive amounts—.2 per cent., or higher. It is objectionable here, as it gives a coarse grain to the steel and lowers the point to which it can be safely heated. Up to .12 or .13 per cent., phosphorus increases the strength but lowers the ductility. The greatest objection is that high-phosphorus steel is treacherous and is liable to break under even small loads if suddenly applied. The behavior of high-phosphorus steel is uncertain and whimsical throughout, and for this reason its use is always perilous. The

ordinary limit in Bessemer steel is .1 per cent., but some Bessemer is made as low as .075 per cent. phosphorus; by the basic process it is usually made below .03 per cent. Phosphorus is not known to be a benefit to steel under any circumstances.

16. Silicon.—Silicon is generally absent in soft steels, while in rail steel and castings it is present from .1 to .4 per cent. In castings, it is added more to produce solidity than for any effect on the physical properties. Soft and medium steels, for plates, structural steel, etc., seldom contain over .05 per cent. of silicon and less than half of this usually. There is some uncertainty and difference of opinion as to the exact effect of silicon, but generally it does not affect strength or toughness in amounts usually present. It increases the stiffness, and is used in some heavy springs requiring this feature. It also hardens the steel, and this is commonly accepted as the beneficial effect in steel rails, causing them to wear longer. Any considerable percentage of silicon interferes with working at redness, welding, etc., and it is usually a cause of red shortness, although some high-silicon steels forge well. All the alloy steels having much silicon must be worked at low heats.

17. Oxides or Oxygen.—These produce somewhat the effect of sulphur, as cracking, and the effects of red shortness. Manganese removes them partially or nearly completely, depending on conditions in recarbonizing, and neutralizes their effect in the steel. Their presence is greater in soft steels or ones low in manganese, as they have the oxidizable elements to seize in harder steels and thus be removed as gases or solid compounds to go to the slag.

18. Copper, Nickel, and Aluminum.—Copper has been supposed to produce red shortness in particular, but later investigations disprove this, unless it is accompanied by high sulphur, say .075 to .1 per cent. In amounts up to .5 or .75 per cent. it has no effect on the cold properties, unless adding slightly to its ductility, and only affects hot working when sulphur or other red shortener is high.

Nickel steel finds its greatest use in armor plate, though it has many other uses also, especially in high-grade forgings. Nickel has the property of giving a greater elastic limit and ductility for the same tensile strength. Generally from 3 to 3.5 per cent. of nickel is present; it is added in the form of metallic nickel or ferronickel, in the melting furnace.

Aluminum is seldom found even in traces in the amounts added as a deoxidizer. Added in larger amounts, it increases strength somewhat and lowers ductility. Aluminum finds no use except as a quieter in the proportion of from 2 to 5 ounces per ton of steel; and this unites with the oxygen of the bath and passes into the slag.

EXAMINATION OF THE FINISHED PRODUCT.

19. Chemical Examination.—After the steel is finished, it is subjected to examination to ascertain if the desired qualities in chemical composition and physical properties have been reached. Throughout the manufacture of steel the chemical laboratory plays an important part: First, in the selection of proper materials; second, as a guide and check in controlling operations; and finally, in the analysis of the finished product. Methods of analysis are fully given in *Quantitative Analysis*, and represent the latest accepted methods and those used in practical steel laboratories. Many of the determinations must be completed in a very short time to be of any value to the steel maker.

20. Microscopical Examination.—In addition to the chemical examination, the finished steel is tested physically. The microscope has been used largely in examining steel, and has shed much light on its structure and constitution. It has not been used, however, as a regular means of testing, mainly owing to the time required to prepare sections for examination. It has been of practical value in detecting improper heat treatment or in determining the proper heat treatment for certain steels. It has been chiefly used with high-carbon

steels, and this seems to be its most favorable field, as the carbon in such steels is most sensitive to heat treatment. The microscope has revealed previously unexplained or wrongly interpreted phenomena in the tempering of steel.

21. Physical Testing.—The steel is subject to various mechanical tests for properties, such as bending, twisting, quenching at redness and bending, tests of forgeability, etc. Rails and axles are subject to *drop tests*, i. e., the full-sized member (a section of rail) is supported near the ends on solid blocks or foundations, and a weight, or *tup*, dropped midway between the supports. The height of drop and weight of tup vary with the section of the member tested and the specifications of the purchaser. Testing of this kind may be regarded as *qualitative*, so far as measuring the exact force applied and expressing it in exact quantities. It is not to be considered of less value or importance for this reason, but that it is better adapted to show what the material will do in service. All physical testing is, or should be, made to approximate as closely as possible the actual conditions under which the material is used.

22. Testing Machine.—This may be defined as a machine or apparatus for breaking samples of material and measuring the stress required. The simplest conception is to consider it as a weighing machine arranged to register the force required to break or to produce certain effects in the test specimen. It is used to pull test specimens from plates, structural material, merchant shapes (rounds, squares, etc.), or cast-steel test bars, etc. Fig. 1 shows one of the standard types of machine of 100,000 pounds capacity. They are made in all sizes up to 3,000,000 pounds capacity, but above 200,000 pounds are mainly for experimental purposes or special work; the 100,000-pound machine is the size commonly used in testing laboratories. The machine is driven by a direct-connected motor or from shafting. Hydraulic testing machines were formerly much used, but now hydraulic power is used only in the case of extremely large machines.

23. The screw machine, Fig. 1, is the one used for testing ordinary sections; in it the strain is applied to the piece through vertical screws, one of which is shown at *a*. One

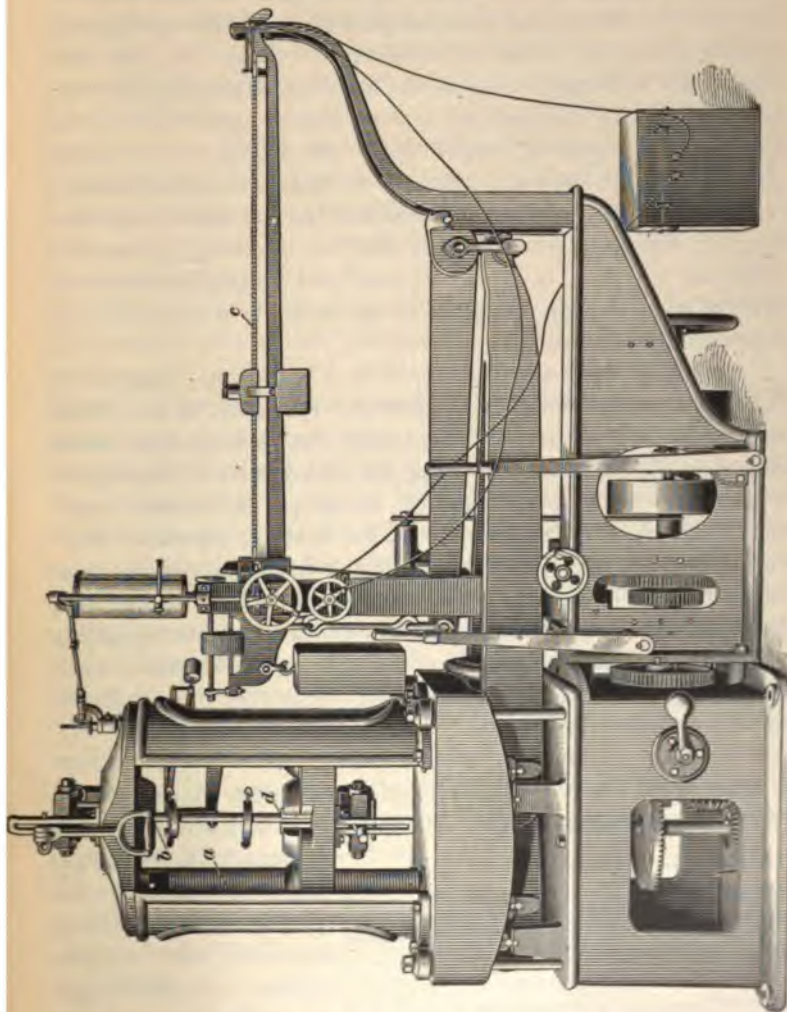

FIG. 1

end of the test piece is held in the top, or fixed head *b*, of cast steel, supported on cast-iron columns resting on the

heavy iron base or weighing table, which, in turn, rests on hardened-steel knife edges in a series of levers that transmit the strain, as applied by the screws, to the weighing apparatus; the strain is registered by the poise on the beam *c*. The lower end of the test piece is held in the movable or pulling head *d*, which is lowered or raised by the two screws *a*, reaching nearly to the fixed head, passing through two brass nuts fastened in it; the screws pass down to the base of the machine, where they are keyed to the main gears by which they are revolved in either direction, raising or lowering the pulling head as desired. Gears controlled by the levers shown are provided for operating at several different speeds. In both the fixed and pulling heads, holes are cut with sloping sides in which wedges, or *grips*, fit for holding the test piece.

In making a tensile test, the lower, or pulling, head is run up to the proper height to adjust the specimen in the grips, when the screws are reversed and the pulling head starts down on the screws, stretching the piece until it breaks, the upper end being firmly held by the grips of the fixed head. The machine is principally used for making tensile or pulling tests, but may also be used for compression or transverse tests, when the grip lever and hanger on the pulling head are removed, and the specimen placed on the weighing table and the movable head run down on the specimen until crushed or broken, the strain being registered on the beam as in a tensile test.

24. Test Piece.—The standard test piece for most purposes has a gauged length of 8 inches, in which the stretch

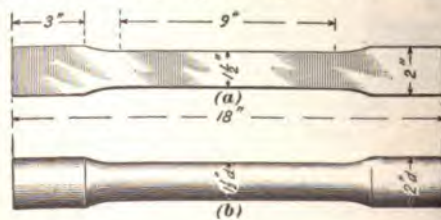

FIG. 2

is measured. Fig. 2 (*a*) shows the specimen for plates and structural material for bridges; ships, or buildings; and (*b*), the shape for cylindrical bars. The former is cut from the

finished plate, beam, etc., the edges being reduced as shown; the two opposite sides are the rolled surfaces. In the case of rounds, squares, rods, etc., tests are made whenever possible on full-sized sections as rolled and in a length of 8 inches. For steel castings, forgings, and axles, the test specimen is cut from the product and turned to a diameter of $\frac{1}{2}$ inch by from 2 to 4 inches gauged length. It was formerly quite common to forge or roll a small ingot and make the physical tests on this; this is objectionable as heat treatment or work received may be different and give varying results in tests; test specimens are universally taken from the finished material and tested in as near the natural condition, i. e., as produced, as possible.

In test pieces that are machined, the opposite sides must be parallel throughout the length of the test section, i. e., the length, or a little more, in which measurements are made. Bars, rods, etc., tested in the shape they leave the rolls, without any machining, usually vary but slightly in a length of 8 inches and are calipered in several places and the average taken. It is important that there should be very little variation throughout the length, as it affects the area on which the calculations are based. Measurements of thickness, width, or diameter are made with a micrometer gauge accurate to the one-thousandth of an inch, and from these measurements the area of the cross-section is calculated—which in rectangular sections is merely multiplying the two dimensions together; or in round sections, finding the area of a circle with the diameter given. The elastic limit and tensile strength, as shown on the beam of the machine, are calculated from the area to pounds per square inch, and always so reported.

25. Properties Determined in Testing.—The properties usually determined in testing are (*a*) elastic limit, (*b*) tensile strength, (*c*) elongation, (*d*) reduction of area.

The *elastic limit* is that point at which the metal under strain takes the first appreciable set; or the point at which the steel under strain will not return to its original form

and dimensions when the strain is removed. This is by far the most important property, as well as the one observed first in testing. Steel strained beyond its elastic limit is liable to give way under very light loads or much below its original elastic limit; continued strains near the elastic limit may produce the same result. It is determined in testing by "the drop of the beam" in all steel-works' laboratories; automatic devices governed by electrical contact are in use to a very limited extent. As the load on the test piece increases, the poise is moved out along the beam to just balance this; the instant the elastic limit is reached there is a momentary and sudden elongation of the piece and the load on the machine is released to such an extent that the beam drops quickly in its surrounding guard. It remains stationary a number of seconds, but the interval is decided and lasts until the movement of the pulling head catches up with the flow of metal in the test piece. In other words, the metal of the test piece, at the point of elastic limit, travels faster than the pulling head; hence, the drop of the beam corresponds to the elastic limit. The weight shown on the graduated beam is the elastic limit in pounds.

The term *tensile strength* is self-explanatory, and in determining it the stress is applied until the specimen parts. The tensile strength is important in determining the fitness of the steel for given purposes—but less so than the elastic limit.

Elongation is measured for most specimens in a length of 8 inches (2 or 4 inches in castings and forgings). It is determined by placing punch marks the proper distance apart on the surface of the test piece before placing it in the machine; after breaking, the fractured ends are pushed together and the increased distance the punch marks are now apart over the original distance equals the elongation, e. g., punch marks measure 10 inches apart after the fracture of an 8-inch test piece, a stretch of 2 inches in 8 inches, or an elongation of 25 per cent.; it is measured to the closest hundredth of an inch.

As the piece stretches, its cross-section is reduced and the point where fracture occurs is drawn down, approaching

a conical point more or less. The area of this reduced section, measured at the fracture, compared with the area of the original section, is the *reduction of area* expressed in per cent. of the original area. The elongation and reduction of area are valuable expressions of the elasticity and ductility of the steel. An increase of elastic limit and tensile strength accompanies less elongation and reduction, or the harder steels are stronger, but stretch and reduce less.

26. Effects of Work and Heat on Steel.—The physical properties of steel are greatly affected by the amount of work done upon it, and the temperature at which the work is done. In general, the more work steel receives, or the greater the reduction from a given section, the higher is the elastic limit and tensile strength, with less stretch; but the ductility (expressed in reduction of area) is not so much affected unless there are great variations in heat at the same time. In plates, with other conditions uniform, the thicker the plate, the lower is the strength, and the less is the stretch. Between a $\frac{1}{4}$ -inch and a $\frac{3}{4}$ -inch plate rolled from the same steel, there may be a difference of 3,000 to 6,000 pounds per square inch in the tensile strength. This difference may be further increased by working at a lower heat, or lessened by rolling hotter. We have, then, increased working adding to the strength, and, in fact, to the good qualities of the steel, if it is done at the proper temperature. Cold working increases the strength, but at the expense of ductility. Either extreme is objectionable, as not developing the desired qualities in the steel.

27. The slabbing mill affords an advantage in making slabs for plates over rolling large ingots directly on the plate mill, as the latter method is apt to finish them too cold, with its attendant disadvantages. With the slabbing mill, large ingots are rolled into slabs adapted to the size of plate to be made. This allows different sized plates to be finished nearer the same temperature, gaining the advantages of increased rolling and avoiding the evils of cold rolling.

The latter is not always a disadvantage, but is in the class of material considered. In certain finishing mills, sheets or other products are regularly cold rolled where a sacrifice of ductility is of less consequence than the strength gained; it also produces a denser, stiffer, and harder product. Rails have lately been cooled somewhat before being put through the finishing passes, the result being a denser and harder metal, particularly in the head, which is expected and claimed to increase their wearing power. This is especially shown in the very heavy rails where there is a larger mass of metal.

28. Relation of Chemical Composition to Strength.

Much work has been done by various investigators to establish the relation between the chemical composition and the strength of steel, and various formulas for calculating the strength from the composition have been proposed. Mr. W. R. Webster has conducted the most exhaustive experiments in this direction, and his results in many cases quite closely approach those obtained from the testing machine. With all conditions uniform—the same steel, equal size ingots or slabs, heated to a like temperature, and the amount of reduction in rolling, etc.—the chemical analysis will give the strength very closely. But, owing to variations in mill practice (principally finishing temperature and different amounts of work), some of which cannot always be kept within the close limits desirable, the estimation of strength from analysis may be said to be only an approximation. However, this approaches so nearly the results of tests that it is of great value as a preliminary estimation of the ultimate strength.

Table V is based on Webster's results, and from it the approximate ultimate strength can be found. It is worked out for the elements, carbon (up to .25 per cent.), phosphorus, manganese, and sulphur (in amounts usually present), with corrections for different widths and thicknesses. A brief study of the table will show the manner of applying it. The example given herewith illustrates it:

IN NEW YORK
PUBLIC LIBRARY

TABLE VI

Number of Test	Chemical Analysis				Physical Qualities			
	Carbon. Per Cent.	Manganese. Per Cent.	Phosphorus. Per Cent.	Sulphur. Per Cent.	Elastic Limit. Pounds.	Ultimate Strength. Pounds.	Elongation in 8 Inches. Per Cent.	Reduction of Area. Per Cent.
1	.13	.19	.045	.029	28,500	52,000	34.30	
2	.20	.40	.010	.028	34,500	60,240	26.00	56.90
3	.16	.38	.008	.031	30,400	57,400	29.00	59.60
4	.25	.41	.018	.024	35,600	62,880	23.00	43.20
5	.40	.12	.032	.006	50,743	71,300	21.67	
6	.64	.05	.007	.005	50,000	94,500	2.75	
7	.50	.33	.016	.010	63,560	84,200	25.00	29.91
8	.96	.24	.008	.015	65,000	124,800	3.75	
9	.10	.48	.100	.056	36,200	67,800	21.50	52.00
10	.10	.42	.095	.062	35,600	62,400	20.25	44.60

TABLE VII

Number of Test	Chemical Analysis			Measurements and Physical Results													
	C Per Cent.	Mn Per Cent.	S Per Cent.	P Per Cent.	Original Dimensions			Elastic Limit		Tensile Strength		Elongation		Dimensions After Fracture			Reduction of Area, Per Cent.
					Breadth, Inches	Thickness, Inches	Area, Square Inches	Pounds	Square Inch	Pounds per Square Inch	In 8 Inches	Per Cent.	Breadth, Inches	Thickness, Inches	Area, Square Inches		
1	.20	.38	.032	.009	1.005	.630	.6332	21,900	34,590	31,300	49,440	2.44	30.50	.665	.370	.2460	61.1
2	.23	.42	.030	.023	1.285	.377	.4844	18,000	37,160	32,100	66,260	2.20	27.50	.960	.220	.2112	55.0
3	.21	.39	.024	.025	1.295	.380	.4921	18,600	37,800	31,800	64,640	2.10	26.25	.950	.210	.1995	59.5
4	.15	.41	.022	.012	1.010	.728	.7353	26,600	36,180	45,700	62,150	2.00	25.00	.730	.540	.3042	46.4
5	.19	.39	.022	.016	1.010	.506	.5110	18,900	36,980	28,400	55,580	2.48	31.00	.660	.270	.1782	65.1
6	.19	.38	.019	.021	1.345	.370	.4977	19,000	38,180	34,400	69,120	1.64	20.50	1.120	.280	.3136	37.1
7	.10	.48	.055	.100	1.150	.162	.1863	6,780	36,400	11,500	61,720	1.40	17.50				56.0
	AA		.060	.096	1.150 Dia.	.162	.1863	6,670	35,800	11,300	60,660	1.56	19.50				
					.498		.1948	7,210	37,010	13,900	71,360	.31	15.50	.429		.1445	25.8
					.798		.5001	17,100	34,190	34,700	69,380	.36	18.00	.667		.3494	30.1

EXAMPLE.—A given specimen analyzes: carbon .21 per cent., phosphorus .035 per cent., sulphur .032 per cent., manganese .36 per cent. The plate is 80 inches wide and $\frac{1}{4}$ inch thick. Finding the carbon in the upper horizontal line of Table V, and going down this column until opposite per cent. phosphorus (left-hand vertical column), we find 56,800 pounds per square inch as the strength for .21 per cent. carbon and .035 per cent. phosphorus. The addition for .032 per cent. sulphur is 1,600 pounds; for .36 per cent. manganese, 7,960 pounds; an 80-inch plate $\frac{1}{4}$ inch thick calls for a deduction of 250 pounds. We now have $[56,800 (C + P) + 1,600 S + 7,960 Mn] - 250$, or 66,110 pounds, as the ultimate strength per square inch. In using the table, the differences in strength due to the varying temperature and the rolling must not be forgotten, and as these cannot be allowed for, the results from calculation are always liable to differ from those obtained by pulling specimens in the testing machine.

29. Results in Physical Testing.—Table VI gives the composition, together with the results obtained in testing a number of steels of varying carbon percentages.

Table VII shows a record of physical tests, with the measurements, results, etc.

Numbers 9 and 10 of the table are steel castings, pulled in a length of 2 inches, and turned to the diameter shown.

RECENT PROGRESS IN STEEL MAKING

SPECIAL METHODS

30. General Remarks.—While many radical improvements and modifications have taken place in the Bessemer and open-hearth processes, no fundamental principle involving an entire change of method and apparatus has been developed since their introduction. The most distinct as well as the most promising attainment is *the Talbot continuous open-hearth process*, developed and patented in 1899 by Benjamin Talbot, of Pencoyd, Pennsylvania.

31. Talbot Continuous Open-Hearth Process.—This consists in maintaining a constant reservoir of metal, part of which is withdrawn when completely refined, and the same

amount of liquid pig metal added from the cupola or the blast furnace—the latter preferably, as it avoids the cost and labor of remelting. The process is carried on in a slightly modified rolling or tilting open-hearth furnace. The original one is of 75 tons capacity, 20 tons of steel being poured off for each heat and then 20 tons of melted pig iron added to the 55 tons of steel in the furnace; scale, cinder, ore, and limestone, to form a slag, are added between each withdrawal and addition. Furnaces of 150 and 200 tons capacity are under construction in America and England; one being in as successful operation in England as the original smaller one. It was at first feared that the bottom could not be kept in proper condition, owing to the large body of metal and the fact that the bottom could not be reached until the furnace was emptied at the end of each week. This has been proved erroneous, and what some metallurgists believed, that it was not the metal but the slag that injured the basic bottom, was proved. The bottom does not suffer except by scorification at the slag line, as in the ordinary practice. It is repaired as usual. In fact, the scorification is somewhat less, as part of the slag is decanted before the steel is poured out. It is essentially a pig, or pig-and-oxide, process, as little or no scrap is used, and this point makes it advantageous or otherwise, according as pig iron or scrap is the cheaper and more abundant stock.

32. About the only difference in the furnace from the usual tilting one is that it is made with a slag spout at the back and to tip both ways, so that the slag may be decanted off from the side opposite that where the metal is tapped, into a slag ladle or car beneath. The construction is necessarily stronger to correspond to the increased weight of metal, etc. The initial or filling heat (at the beginning of each week's run) is prepared in the usual way from scrap and pig metal—the latter preferably added molten on top of the scrap and limestone—worked down to steel, feeding ore if necessary, as in common practice; when thoroughly refined and in proper condition to tap, about 20 tons (from

one-third to one-fourth of the bath) is poured off, recarbonized in the ladle, and cast into ingots. Before adding more metal, oxide of iron in rather fine condition is added to the slag, and as soon as melted a part of the 20 tons of metal is added; when the violent reaction from this ceases somewhat, a second addition of oxide of iron is made, together with limestone; then more metal, and a third addition of oxide with stone, and finally the third and last metal addition. From this point the heat is handled as in ordinary practice until the entire contents of the furnace—not merely a part of it—is reduced to good steel minus the recarbonizer. Twenty tons are again poured off, iron oxide, limestone, and metal added as above; this round of operations being kept up during the week and the furnace emptied on Saturday.

The details of operation vary somewhat. As the entire amount of oxide and stone may be added before the metal, and this added in two or three pourings, as the violence of the reaction permits, the time between additions may vary, etc. As a rule, the first two metal additions are about equal, and from 80 to 90 per cent. of the total pig metal; the third addition (about 15 per cent.) is usually added from 10 to 20 minutes before tapping, depending on the amount of carbon wanted in the steel and the rapidity of the reactions; an interval of from 2 to 2½ hours generally elapses between the second and third metal additions, although this is not an essential and all the metal may be transferred to the bath within an hour. Forty-two heats per week have been made; between taps there is an interval of about 4 hours against about 8 or 10 hours in the ordinary practice.

Approximately the same tonnage per week has been made as in the largest type (50 tons) of ordinary furnace, when the entire bath is tapped, and using pig and scrap with some ore. A much larger output is counted on with the 150-ton to 200-ton furnaces; this and the fact that the process can be worked with pig and oxides or ore are its chief advantages; minor, but important, ones are that the yield is greater and that a wider range of pig iron can be used (higher in silicon

and phosphorus). The last is due to the conditions under which oxidation occurs and that the excess of slag can be removed as formed. The increased yield of steel comes from the iron reduced from the oxides, entering the bath. The usual basic conditions of a minimum of SiO_2 in the stock must be observed, but this is of less importance than when the slag cannot be removed.

The iron oxides used are roll scale, mill cinder (basic low SiO_2), and iron ore; ordinary limestone, if low SiO_2 . The composition of the oxides is shown in Table VIII.

TABLE VIII

Material	Iron. Per Cent.	Silica. Per Cent.	Phosphorus. Per Cent.
Roll scale.....	70 to 74	.5 to 3	.05 to .2
Basic mill cinder...	64 to 68	3.0 to 8	.05 to .5
Iron ore.....	60 to 65	3.0 to 8	.05 to 1.0

33. The process is based on the powerful oxidizing action of a slag rich in iron oxides; or stated the other way, the prompt reducibility of slags, rich in iron oxides, by the metalloids in the bath. In the usual process, much of the oxidation is done by the oxygen of the air, whereas here the slag (or the oxygen in it) performs this work. The reactions are as follows:

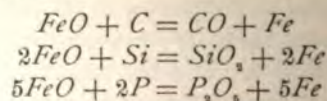

This is one of the most active and rapid reactions met with in iron and steel metallurgy; in fact, it is only paralleled, if equaled, by the rapid purification in the Bessemer converter. This is shown by the following example from the records of operation.

EXAMPLE.—Into a bath of 104,000 pounds of metal ready to pour and covered with a slag containing 22.4 per cent. of metallic iron,

9,300 pounds of liquid pig metal was poured, taking 4 minutes; 2 minutes afterwards the metal was hot enough to tap and was thoroughly purified—or in 6 minutes 9,300 pounds of pig metal was converted into steel. At the same time the iron in the slag was reduced to 12.4 per cent., nearly one-half the oxygen in the FeO, Fe_2O_3 , being given up to oxidize the metalloids. During the reaction the furnace doors were opened and the movable ports pushed back to allow the escape of the gases formed by the reaction. All the gas was also shut off the furnace until the action quieted down. This reaction had all the characteristics of the Bessemer blow. While carbon was being burned, a large volume of carbon monoxide was given off,

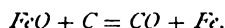

which ignited and burned with an intense heat, a part being absorbed by the bath and a part raising the temperature of the regenerators.

The process yields about 105 per cent.; i. e., for every 100 tons of pig metal charged, about 105 tons of steel is poured out, the increase coming from the iron reduced by the metalloids from the oxides in the slag.

34. Monell Process.—This process was developed a little later than the Talbot and may be briefly and to some extent described as the latter worked in the ordinary stationary furnace, all the metal being tapped out at once. It was worked out at the Carnegie Steel Company's works and is used to a considerable extent by them. It involves no new principle; in fact, the same method was tried in the early history of the basic open-hearth process, but Mr. Monell has achieved much greater success than ever before reached by the method. As worked at the Homestead plant, limestone and iron oxides (ore, scale, or low-silica cinder) are charged on a basic hearth, heated to partial fusion, and liquid pig iron poured in, when the action becomes violent and the metalloids are rapidly oxidized. This action is the same as in the Talbot process—except much less intense—and is due to the slag, containing the excessive amount of iron oxides. The slag may be tapped off through a tap hole placed above the level of the metal, but this is not within the easy control obtained by decanting from a tilting furnace, and is one of the objections to the process. Another is, the slag, rich in

oxides, corrodes the bottom, if it comes in contact with it, and this cannot be entirely avoided. About the same or a slightly increased output per week is obtained over the same furnace using pig and scrap. The yield from metal charged is less than in the Talbot, about 102 to 103 per cent. The same stock is available as in the ordinary open-hearth process or the Talbot, but the latter process allows a wider range of silicon and phosphorus to be used.

35. Bertrand-Thiel Process.—In this process two open-hearth furnaces are operated as a unit and the metal transferred from the first, or melting, furnace, called the *primary*, or *refiner*, into a *secondary*, or *finisher*, furnace. It is the invention of Messrs. Bertrand and Thiel, Kladno, Austria, and has been in successful operation there since 1894. While only one other plant (in England) has been constructed to operate on this system, several others are shortly to be built in Europe, and probably one or two in America. It may be worked on either the acid or basic hearth, but so far has only been worked on the latter, and is not likely to be used for acid practice.

One of the chief advantages of the process is its flexibility, as it may be worked exclusively as a pig-and-ore process or pig-and-scrap with equal advantage and in whatever proportions available. As in the former process, the refiner is charged with liquid pig iron and enough lime or limestone to furnish a basic slag and ore to oxidize part of the metalloids; the amount of the latter (mainly silicon and phosphorus) in the metal determines the amount of lime and ore to be used. In this furnace all of the silicon is oxidized, approximately 90 per cent. of the phosphorus and manganese, and about 40 per cent. of the carbon. As stated elsewhere, both silicon and phosphorus are oxidized at comparatively low temperatures; this accounts for the removal of these elements in the first furnace. The metal is then transferred to the finisher, into which has previously been charged about half the quantity of lime or limestone, and ore used in the refiner, so as to be heated nearly to the fusing point. The

hot metal, with from 2 to 2½ per cent. of carbon, no silicon, little manganese, and a small percentage of phosphorus, coming in contact with the highly oxidizing slag has the carbon and remaining phosphorus quickly removed. It will be seen that the oxidation of the metalloids in the Talbot, Monell, and Bertrand-Thiel processes depends on the same principle—the oxidizing power of a basic slag rich in oxides of iron—though applied somewhat differently in each case. In coming from the first to the second, or finishing, furnace, the slag is skimmed off and very little allowed to enter the latter. As originally worked, the refiner furnace stood on a higher level than the finisher—both being stationary—and the metal run down a trough. This is not an essential feature of the process, and either stationary or tilting furnaces on the same level may be used, the metal being transferred from one to the other by ladle and crane. The tilting furnace, on the same or a higher level, offers the advantage that the slag may be conveniently handled by decantation.

In case scrap is used, a small amount is charged into the refiner, and the greater part into the finisher, with the stone and ore, and allowed to heat and oxidize somewhat before the refined metal is added. This oxidation of the scrap is not a loss, as it takes the place of some ore, and the carbon and phosphorus reduce it to metallic iron, which is added to the bath.

36. About the same yield as in the Monell practice is obtained—102 or 103 per cent. of the metal charged. An output of 45 heats per week from the two furnaces has been obtained, a greater number than from two furnaces using similar stock worked on the usual system; the tonnage has been much less than from two large furnaces, as only small ones (20 tons) have been used so far; but there is every reason to believe that nearly as many heats can be made by using large furnaces—when the tonnage will be greater than that obtained from two of equal capacity—and the operation finished in one furnace. The charge is in the first furnace 2 or 3 hours, and in the second from 2 to 2½. This can be adjusted, however, by the point to which the refining is

carried in the former. In the finisher, the heat is boiled down as in ordinary practice, using ore, if necessary; when the proper temperature is reached, the heat is tapped into the ladle, recarbonized as usual, or this may be done previously in the furnace and cast into ingots.

37. Duplex Process.—This process takes its name from the fact that both the Bessemer and the open-hearth apparatus are used to produce the steel. It was originally and is still used at Witkowitz, Austria, but has been installed in other parts of Europe, particularly in the Middlesbrough District, England, and experimentally in America, but its application has been limited. Its field is in converting pig iron too high in phosphorus for the acid process and not high enough for basic Bessemer practice, or too high in silicon for the latter or the basic open-hearth. In using it, pig metal is melted in the cupola, or taken direct from the blast furnace, and is blown in an acid Bessemer converter to remove practically all of the silicon, part of the manganese, and a little of the carbon, the phosphorus not being affected. The desiliconized metal is poured into a ladle and transferred to a basic open-hearth furnace, where dephosphorization and decarbonization take place, as usual. The process was advanced by many metallurgists as the proper one to convert into steel the rather high-silicon and phosphorous pig irons of the South (Alabama, etc.), but better blast-furnace practice, giving low silicon, has made the metal suitable for the basic open-hearth process, which is now used.

TREATMENT OF THE INGOT

MILLS, ETC.

38. General Remarks.—As this is a distinct subject and more especially a mechanical one, merely an outline of it can be given. Only the mills that receive the ingots from the steel-making departments, or plants, and work them

down for the great number and variety of finishing mills, or a few finished lines, as rails and plates, will be mentioned. The ingots, after having been poured into iron molds placed in a casting pit or on cars, are taken to the heating furnaces to be reheated for rolling. Casting on cars is the later practice, and is followed at most up-to-date works, as it saves the labor and expense of pit casting, besides being a more expeditious method of handling the steel. A pit is required where ingots are cast in groups, the molds being filled from the bottom through a center runner with connections to each mold; such bottom-cast ingots are necessary where they are rolled direct from the ingot into plates, as the ordinary top-cast ingots will not give as good a surface when rolled at one operation into plates. When cast on cars, these are shifted to the *stripper*, an hydraulic or electric mechanism for removing the molds from the ingots. This is done as soon as the ingots solidify, so as to get them into the furnace promptly, and thus to require the least reheating to bring them to the proper rolling temperature.

39. Reheating Furnaces.—Reheating furnaces are either horizontal or vertical, the latter being used almost universally for heavy ingots, and the former for lighter sections, slabs, blooms, etc., for rerolling. Both types are equipped with Siemens regenerators, the necessary flues, reversing and controlling valves, etc., the same as is the open-hearth furnace. The vertical furnace is commonly called a *soaking pit*, but more correctly a pit furnace. It is identical in construction with the crucible melting furnace, Fig. 8 (*a*) and (*b*), Part 2. It is divided into holes in the same way for 4 or 6 ingots placed on end—corresponding to the crucibles in the melting furnace. A furnace is usually built with from 4 to 10 holes and is designated by the number of holes—as an 8-hole pit furnace. In all late construction each hole has its own separate air and gas flues controlled by independent valves (or two holes may be connected). This permits adjusting the temperature in



different sections of the furnace, as required by the steel. There is only the one set of air and gas reversing valves for the furnace, so that the currents of gas and air are reversed at the same time for all the holes.

40. Mills.—In general from their construction, mills are designated as *2-high*, *3-high*, *reversing*, *non-reversing*, or *universal*. The first two indicate the number of rolls in the same vertical plane; the second two as to whether the rolls are driven in the same direction all the time or reversed at intervals; a universal mill has the regular horizontal rolls and, in addition, vertical ones, so that the piece is rolled on its four sides. Two-high mills (of this class) are always reversing; and 3-high (of any class), non-reversing; universal mills may be 2-high reversing or 3-high non-reversing. From the purpose for which they are used, mills are known as *blooming mills*, *plate mills*, *slabbing mills*; in Great Britain, the latter are known as cogging mills. It will be remembered this does not touch the field of finishing mills, but only mills rolling ingots into finished or intermediate products.

41. Blooming Mill.—This mill breaks the ingot down to blooms, billets, or slabs.

A **bloom** is a section of the reduced ingot to be finished on a succeeding mill; they are generally square, but may have the shape roughed out into which they are to be finished. Their size and weight vary with the purpose for which they are used. They are usually for rails, structural shapes, or forgings.

A **billet** is a smaller section of the ingot—or a small bloom. They are used for merchant shapes—rounds, squares, etc.—and rods for wire, bolts, rivets, etc. Their size varies, but the standard section is 4 inches square and of different weights.

A **slab** is a flat shape of varying dimensions that is to be rolled into plates or sheets.

Blooming mills are built 2-high reversing or 3-high non-reversing, generally the former; these are driven by powerful reversing engines through pinions, the ends of these

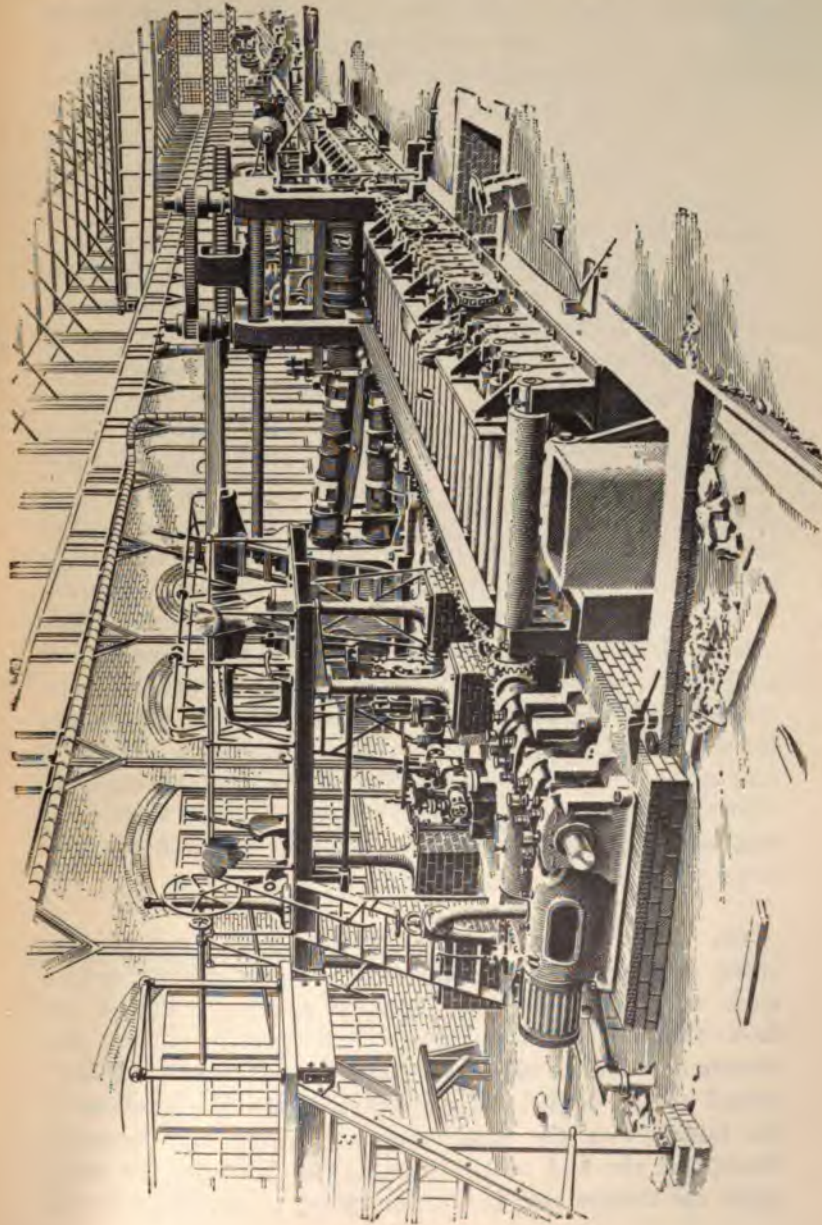
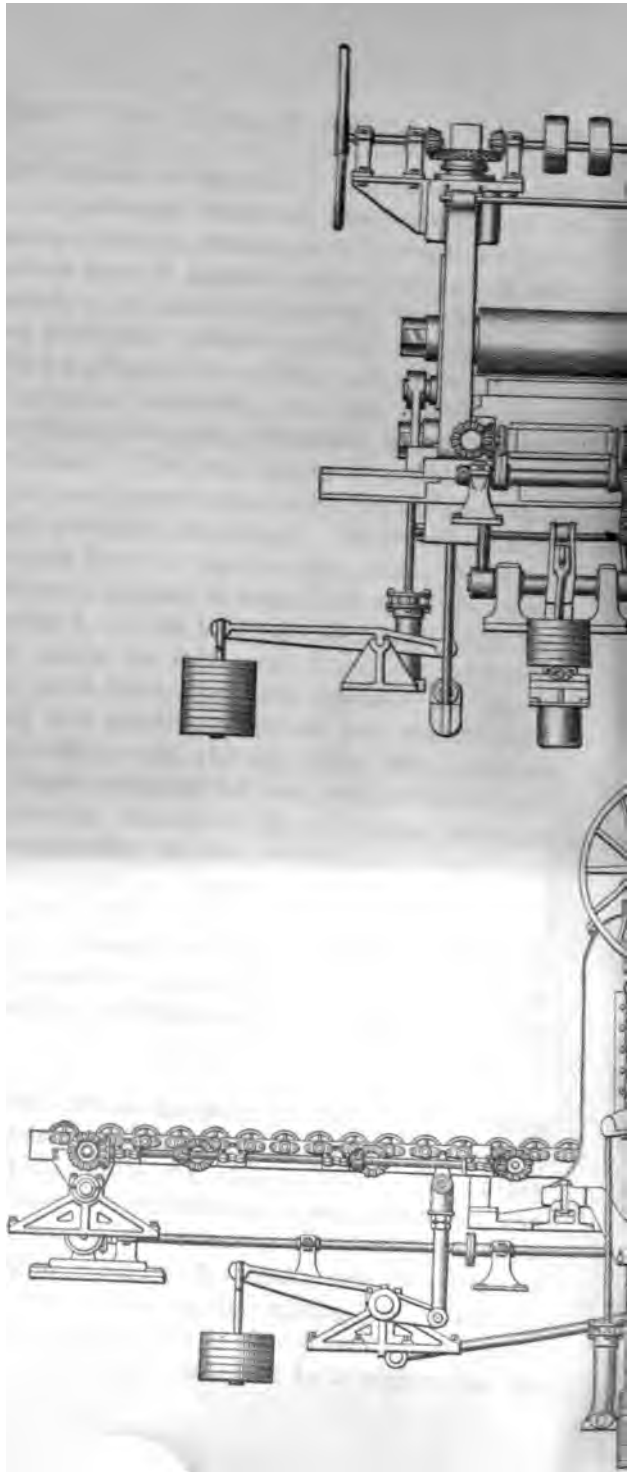
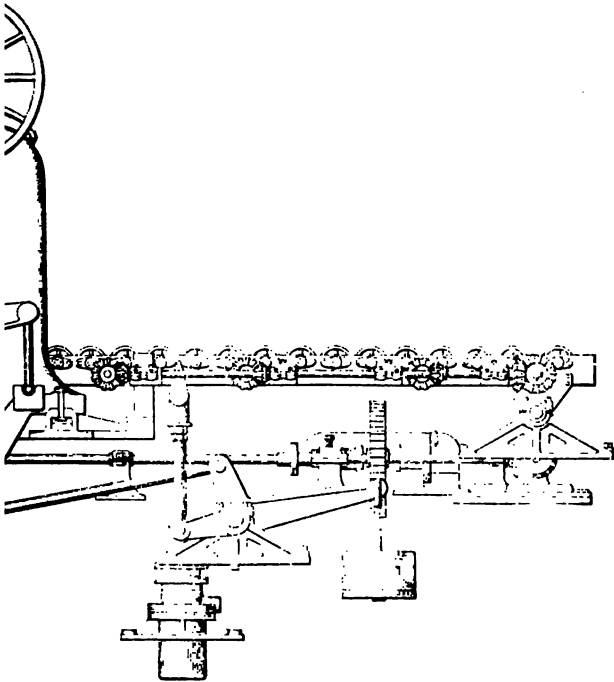
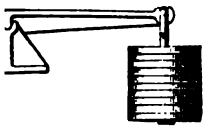
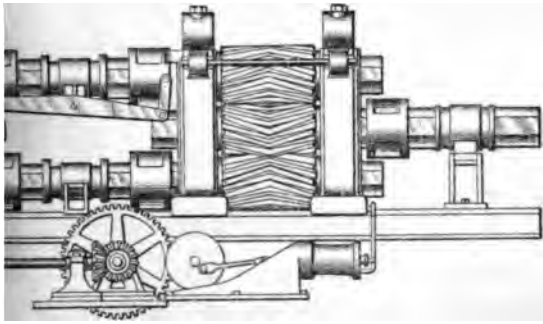

FIG. 3

connected with the ends of the rolls. The rolls are carried in heavy iron or cast-steel housings, the bottom one on stationary bearings, the top one balanced by counterweights underneath, which keep it against vertical screws in each housing by which it is raised or lowered; the screws are operated by an hydraulic cylinder applied through a rack and pinion. In 3-high mills the middle and upper rolls are usually both movable vertically, and the bottom fixed. Fig. 3 shows a 2-high, reversing, blooming mill *a*, together with the roll tables *b*. The mill engine is not shown; the small one *a* at the end operates the tables, which are always driven separately from the mill proper. Hydraulic manipulators from beneath turn the ingot on the tables; the operation of the mill and engines is controlled from the raised platform, or pulpit *c*, on the left. In all 3-high mills, the roll tables are made to raise and lower by hydraulic mechanism, so as to bring the piece opposite the passes between the top and middle or bottom and middle rolls, as required. In rolling rails, the ingots are bloomed down to the size rail bloom required for one, two, or three rails; after a short reheating, these go to the rail trains, which are 3-high non-reversing mills, the first, or roughing, train forms the rail, and the second, or finishing, train (or rolls) completes the operation. The trains are generally arranged tandem, so that the passage from one mill to the other is continuous. Structural shapes are rolled in the same general way, with various modifications in the type and arrangement of mills.

42. Plate Mill.—These are mostly 3-high non-reversing mills, but are made 2-high reversing for lighter work; most universal plate mills are also so built. Fig. 4 (*a*) shows the mill proper and connections from the pinions, the bottom or middle one of the latter in this case being connected to the engine. Fig. 4 (*b*) shows a side elevation of the tables, with the mechanism for raising and lowering these, and the end of the rolls in the housing. In plate mills, the middle roll is not connected to a pinion, but is







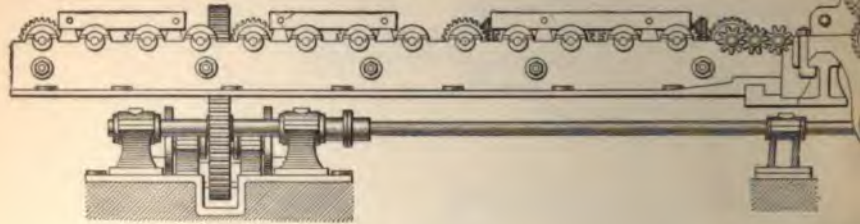

(b)

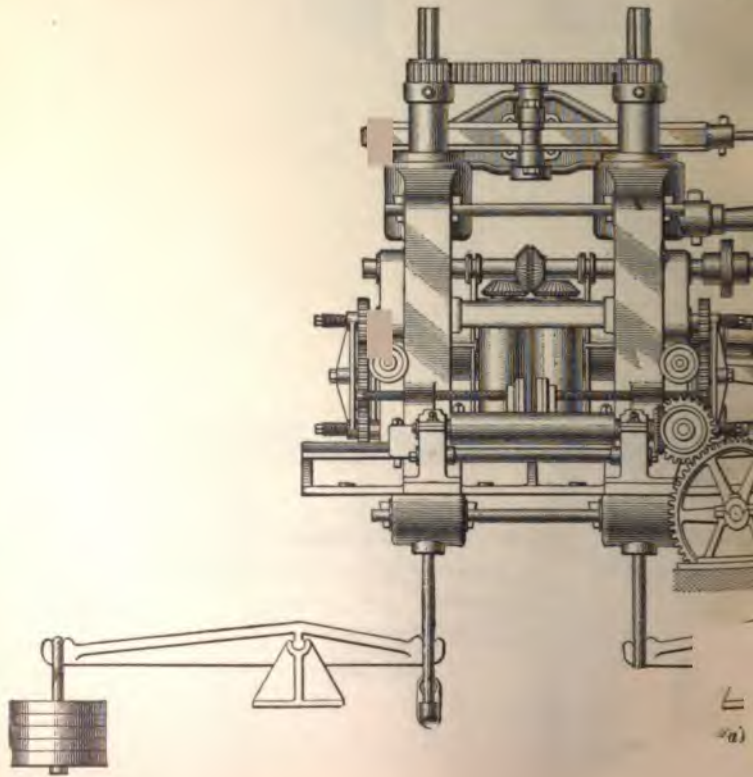

(a)

The drawing of the figure shows the mechanism of the
 machine which is used for cutting the teeth of the
 gears. The mechanism consists of a long bar which
 is supported by two pillars. The bar is provided with
 a series of gears which are in contact with a
 rack and pinion mechanism. The rack and pinion
 mechanism is used to convert the rotary motion of
 the pinion into the linear motion of the rack.

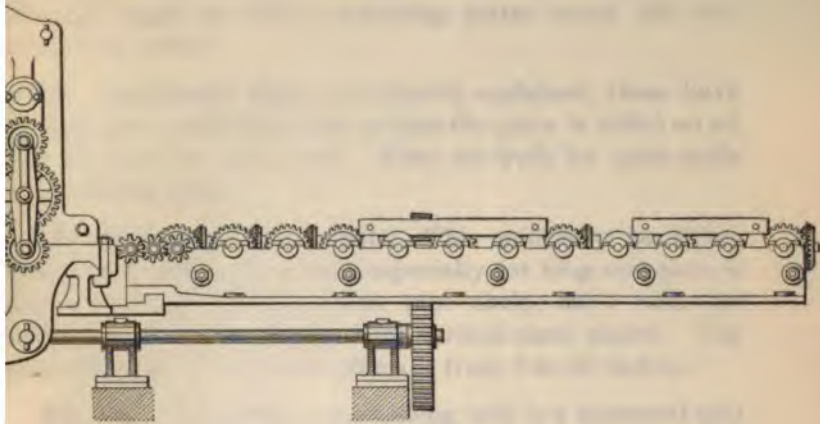

The drawing of the figure shows the mechanism of the
 machine which is used for cutting the teeth of the
 gears. The mechanism consists of a long bar which
 is supported by two pillars. The bar is provided with
 a series of gears which are in contact with a
 rack and pinion mechanism. The rack and pinion
 mechanism is used to convert the rotary motion of
 the pinion into the linear motion of the rack.

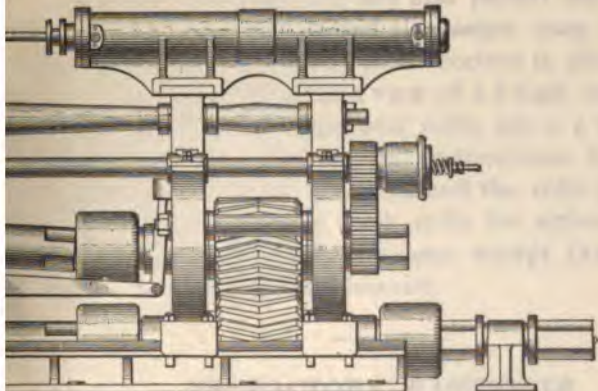

The drawing of the figure shows the mechanism of the
 machine which is used for cutting the teeth of the
 gears. The mechanism consists of a long bar which
 is supported by two pillars. The bar is provided with
 a series of gears which are in contact with a
 rack and pinion mechanism. The rack and pinion
 mechanism is used to convert the rotary motion of
 the pinion into the linear motion of the rack.

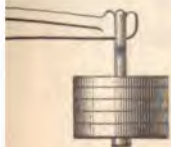



driven by the friction of the top or the bottom roll. Three-high plate mills are built in all sizes up to 132 inches for finished length of rolls, permitting plates about $10\frac{1}{2}$ feet wide to be rolled.

43. Universal Mill.—As already explained, these have vertical and horizontal rolls, so that the piece is rolled on all four sides at the same time. They are built for plate mills and slabbing mills.

44. Universal Plate Mill.—This mill may be either 2-high or 3-high, and is used especially for long and narrow plates, such as bridge plates, pipe skelp, etc.; rolls are adjustable in both directions for various-sized plates. The general width of universal plates is from 6 to 48 inches.

45. Slabbing Mill.—A slabbing mill is a universal mill for rolling down heavy ingots into slabs for plate mills, thus relieving the latter of the work of breaking down ingots for large plates, increasing the tonnage, and reducing the scrap made. The advantage of the slabbing mill is to increase the output of the plate mill and also permit the making of top-cast ingots for plates, and also larger ones, at the steel plant. The extra work the steel receives is also an advantage. Fig. 5 (*a*) and (*b*) is a view of a 2-high universal mill showing vertical and horizontal rolls; (*a*) is a front elevation showing rolls, pinions, and connections, while (*b*) is a side elevation showing the table and the rolls in the housing. The construction of such mills for either a plate or slabbing mill is practically the same, except that the latter is built much stronger and heavier.

REFRACTORY MATERIALS

46. General Remarks.—The success of steel-making operations, among many other factors, depends on the ability of the apparatus to withstand the heat conditions, and not a little of it is due to the refractory materials. The metallurgist needs to be no less familiar with their

properties than with the reactions and manipulations of the processes themselves. Though there is quite a range of materials used for lining for furnaces, vessels, ladles, etc., they may, according to their chemical nature, be divided as follows:

Refractories	{	Acid materials. . .	{ Clays Silicious materials
		Basic materials. . .	{ Magnesite Dolomite Limestone
		Neutral materials	{ Chromite Carbon Bauxite

These materials may be used either in mass, shaped to the purpose as applied, or as brick; both forms are essential and extensively used.

ACID REFRACTORIES

47. Clays.—The most important of the first class is clay. Clay is a hydrated silicate of alumina, always containing varying amounts of free silica, oxide of iron, lime, magnesia, generally alkalis, and frequently titanium. A true clay has the composition SiO_2 , 46.4 per cent.; Al_2O_3 , 39.7 per cent.; H_2O , 13.9 per cent.; this corresponds to the formula $Al_2Si_2O_7 \cdot 2H_2O$, or $Al_2O_3 \cdot 2SiO_2 \cdot 2H_2O$. Pure kaolin (china clay) represents this composition, but owing to its cost, it finds no use in steel refractories, except to a small extent in the manufacture of crucibles. A few clays approach this composition closely, and it is the ideal one, as it represents the least fusibility when free from injurious impurities, the SiO_2 and Al_2O_3 being present in almost exactly the proportions to give greatest infusibility attainable in a clay. Clays free enough from impurities to stand a high fire test are used for making brick and for ball stuff, and are known as fireclays. It is only these with which we are concerned.

Clay results from the atmospheric decomposition of various rocks, mainly feldspar, orthoclase $K_2C, Al_2O_3, 6SiO_2$; this is broken down by the action of air, moisture, and CO_2 , to a soft mass that absorbs water, the potash and part of the silica is leached out and carried away in solution or mechanically. Pure kaolin would result from the decomposition of the above, but the silicates generally contain other minerals with Fe, CaO, MgO , etc.; so we find these in the clay. They belong to all geological periods. The more recent are softer and more plastic, having all their combined water, while older ones appear solid and dry from having lost their hygroscopic water; still older ones, that have possibly been subject to great heat and pressure, have also lost their combined water, and with it the property of becoming plastic by the addition of water.

48. Most clays used for refractory purposes occur in the coal measures, frequently under or between the coal veins. This does not mean as good refractory clays are not found elsewhere, but is a matter of geographical location, as the situation of iron and steel industries is generally determined by their closeness to fuel; hence, suitable clays that are nearest are used. Nearly all fireclays contain more silica than the formula for a pure clay (as represented by kaolin) calls for; they might be called acid or silica clays; but such a distinction is not observed. This excess of silica is not especially objectionable in most cases, although it lowers the refractoriness, but must not be present in sufficient quantity to lessen the plasticity very much. The two chief points in a fireclay are *refractoriness* and *plasticity*. The necessity of the first is apparent and requires no comment. Plasticity is essential, that it may be molded into the desired form and retain this while drying and burning—as brick or ball stuff for lining, patching, etc. The plasticity of clay is due to the combined water contained. If air dried, or dried at a temperature of $100^\circ C.$ ($212^\circ F.$), it appears hard and thoroughly dry, but still contains its water of combination. On heating to redness, this is lost, and it becomes a hard mass—

TABLE IX

Number of Sample	Name or Source of Clay	Combined Water. Per Cent.	SiO_2 Per Cent.	Al_2O_3 Per Cent.	Fe_2O_3 Per Cent.	CaO Per Cent.	MgO Per Cent.	Alkalies. Per Cent.	TiO_2 Per Cent.
1	Benezet, Central Pa. (raw)....	13.77	47.23	38.41	.39	.10	.09	trace	
2	Benezet, Central Pa. (calcined)		54.32	45.05	.48	.09	.09	trace	
3	Savage, Maryland.....	14.10	54.65	30.74	.08	.19	.13	.11	
4	Renovo, Pennsylvania.....	13.74	42.33	37.01	.95	.47	.16	.29	3.83
5	Renovo, Pennsylvania.....	5.80	32.60	53.89	1.09	1.35	.10	.59	4.62
6	Lock Haven, Pennsylvania...	8.54	50.80	34.28	1.77	.05	.47	2.56	1.25
7	Connellsville, Pennsylvania...	13.14	55.38	30.42	trace	.52	.32	not det.	
8	Plastic clay, Illinois.....	10.84	55.56	31.40	.68	.65	.65	not det.	
9	Fairmount, West Virginia....	9.35	61.55	28.85	.25	.20	.60	not det.	
10	Vanport, Pennsylvania.....	9.25	60.80	27.50	2.30	.25	.08	not det.	
11	Fireclay, Illinois.....	7.66	63.93	22.69	1.80	1.41	1.95	not det.	
12	Loam, Pennsylvania.....	3.24	78.86	11.70	3.84	1.24	.96	not det.	

biscuit—which is very porous and will absorb considerable water, but cannot be made plastic again. When air dried, or dried at 100° C., plasticity is lost, but is restored by mixing with water.

Table IX shows the analyses of typical and well-known clays.

The most objectionable elements in fireclays are alkalis, iron oxide, lime, and magnesia, and their bad effect is in about this order for the amounts usually present. The alkalis (K_2O and Na_2O or salts) are the worst and act by forming readily fusible alkaline silicates. Traces are probably present in all fireclays; the amount is usually under 1 per cent. Oxide of iron can do no good, but its presence in moderate amounts does not seem to greatly lower the fusibility. If present in the clay as FeO , it is more harmful than if as Fe_2O_3 , as the latter does not combine with SiO_2 , while the former does as ferrous silicate; if brick are burned or used in a highly reducing atmosphere, the Fe_2O_3 may be reduced and the silicate formed. Iron gives a reddish or brown color to the brick or clay on burning. Lime and magnesia are usually present in varying percentages; they are less objectionable than iron or alkalis, but add somewhat to the fusibility. Titanic acid TiO_2 is present in some excellent clays; its effect is not well understood, but under certain conditions it adds to the refractoriness.

49. Silicious Materials.—In these silica predominates, being about 90 to 99 per cent., as a rule. Silica rock furnishes most of the material under the heads of silica brick, ganister, and silica sand. For the manufacture of silica brick the rock contains 98 or 99 per cent. SiO_2 , the remainder being Fe_2O_3 , Al_2O_3 , CaO , MgO , and sometimes combined water. For brickmaking, purity of the rock is not the only requisite; in fact, some rocks of nearly pure SiO_2 are unfit for the purpose—mainly owing to the brick expanding irregularly and excessively when exposed to a temperature above that of burning. All silica brick at high temperatures expand about $\frac{1}{4}$ inch to the foot, but it must be

uniform and take place gradually. As the ground rock has practically no plasticity, binding material must be added to fit the particles together in burning; from 1 to 2 per cent. of lime or a refractory clay is generally used. The bricks are carefully dried and then fired at a high heat for about a week and allowed to cool in the kiln for about the same time. The temperature of kilns burning high-grade refractory brick of any kind is commonly controlled by the use of *Seeger cones*.

Ganister is a silicious rock generally containing some Al_2O_3 and combined water. Its principal use is for converter linings in the acid Bessemer process, and mixing with clay for ladle linings, etc. It may be regarded as silica with enough clay material to bind it, giving a strong material when burned. Quartz has been used for the same purposes.

Silica sand is nearly pure SiO_2 , used mainly for bottoms or hearths in the acid open-hearth process; also for bottoms of heating furnaces.

Table X shows the composition of silicious materials.

TABLE X

Number of Sample	Material	SiO_2 Per Cent.	Al_2O_3 Per Cent.	Fe_2O_3 Per Cent.	CaO Per Cent.	MgO Per Cent.	Com- bined Water. Per Cent.
1	Silica rock.....	99.11	.21	.64	.04		
2	Silica rock.....	96.90	2.00	.50	.06		.65
3	Ganister.....	98.72	.59	.20	.16	trace	.24
4	Ganister.....	84.60	11.80	.68	trace	trace	2.80
5	Silica brick....	96.52	1.40	.60	1.48	.06	
6	Silica brick....	94.82	.86	.50	3.82	trace	
7	Silica sand.....	98.30	1.02	.58	trace	trace	.25
8	Quartz.....	94.20	2.10	1.60	.40	.60	.90

BASIC REFRACTORIES

50. Magnesia is the most important of this class. It is used principally for the hearths of basic open-hearth furnaces, lining for basic Bessemer converters, and for making brick

for similar uses. It occurs naturally as the carbonate (magnesite), Greece and Austria furnishing practically the supply for the world. That from Greece is the purer, but is not as well adapted for basic linings as the Austrian, but makes a superior brick. It is always used as the oxide and requires an extreme heat to drive off the last of the CO_2 . One objection to the Grecian is its freedom from other bases that lower the fusing point, it being too refractory for many purposes. The natural Austrian (the best known is that of Karl Spaeter) seems to have the impurities blended in about the correct proportions for the best results and is sufficiently refractory to set well and give a hard bottom that does not wear readily.

Dolomite, or **magnesian limestone**, is scarcely less important than magnesite. They are used to a large extent interchangeably. Formerly, basic Bessemer converters and basic open-hearth furnaces were universally lined with dolomite, but magnesite has now taken its place, being superior to it. Dolomite is used where a somewhat less refractory material is wanted, usually for patching vessels and hearths; here it has an advantage over magnesite, as it sets quicker, shortening delays for repairing, and lasts nearly as well. It is burned in cupolas or kilns to expel the CO_2 , and absorbs moisture if exposed to the air for a considerable time; but under ordinary conditions may be kept 1 to 2 weeks.

Limestone is the cheapest and most abundant basic material and is extremely refractory, never having been fused or even softened, but it cannot be used, as it is next to impossible to get it to bind, and it cannot be kept, as it absorbs water so rapidly; hearths or linings made of it, if left standing, soon disintegrate from the slaking of the lime. It is the principal flux in basic-steel making.

NEUTRAL REFRACTORIES

51. At one time neutral substances were looked to as linings, so that either an acid or basic process could be worked in the same apparatus. It has not been successfully accomplished, nor is it likely to be. Later, it was

considered essential to have a neutral band between the basic hearth and the silica side walls. This was found to be unnecessary, and the silica brick, in the basic open-hearth furnace, are now laid directly on the magnesite, the latter being carried above the slag line.

Chromite is the most valuable of the class of neutral materials, and is used mostly for patching thin walls of basic furnaces where silica would be likely to get to the bottom; chrome bricks are used to a certain extent as a layer under the magnesite brick in the basic hearth; and to some extent in reheating furnaces where the fluid cinder—ferrous silicate, principally—cuts other brick. A serious objection to using much of it in melting furnaces is that some of the chromium is reduced and absorbed by the metal, producing hardness, especially hard spots. Chromite is a double oxide of iron and chromium, Cr_2O_3, FeO , with varying amounts of silica and other bases. The supply comes principally from Canada and Turkey.

TABLE XI

Material	Cr_2O_3 Per Cent.	FeO Per Cent.	Al_2O_3 Per Cent.	SiO_2 Per Cent.	CaO Per Cent.	MgO Per Cent.	TiO_2 Per Cent.
Chromite....	51.23	36.63	3.17	1.87	5.10	3.79	
Chromite....	62.20	28.10	2.60	2.60	3.07	1.10	
Bauxite.....		1.00	90.00	2.00	1.75	trace	5.00

Material	Carbon. Per Cent.	Volatile. Per Cent.	Ash. Per Cent.
Graphite.....	99.79	.16	.05
Graphite.....	66.40	.70	32.90
Graphite.....	79.40	5.10	15.50

Bauxite was at one time much experimented with for a neutral lining, but it has practically no use at this time in steel making. The excessive shrinkage and difficulty in

making linings caused it to be given up. It is a hydrated oxide of alumina, but seldom occurs without the admixture of more or less oxide of iron. Bricks for other uses are made of it to a limited extent.

Graphite, in the strictest sense, is the only neutral refractory, as the other two can be made unite with other elements under the right chemical and heat conditions. It is used in making crucibles and rarely mixed with ball stuff. Bricks have been made of it for the hearth of blast furnaces, but they are not suitable for open-hearth furnaces owing to the oxidizing conditions destroying them and the metal readily absorbing the carbon.

Table XI shows analyses of neutral refractories.

52. Refractory Mixtures.—Almost every steel works has its own particular mixtures for different purposes, but in general the following are standard practice for the uses shown. The proportions of all will be varied according to results obtained and quality of materials used.

1. *Bottom stuff*, for making bottoms of acid Bessemer converters: Ganister (or quartz), 15 per cent.; fine sand (high SiO_2), 25 per cent.; clay, 25 per cent.; coke dust (aids drying), 15 per cent.; ground clay bricks, 20 per cent. (mostly bats).

2. *Cupola stuff*, for patching cupolas, iron troughs, etc.: Ganister (or quartz), 50 per cent.; sand, 25 per cent.; clay, 25 per cent.

3. *Vessel patching*, for putting on bottom and patching nose of acid converter: Ganister (or quartz), 68 per cent.; sand, 16 per cent.; clay, 16 per cent.

4. *Ladle lining and patching*: Either loam or vessel patching.

53. Other works use one mixture for most of the above purposes—one of about half ganister and half clay is commonly used for everything except ladles, loam being almost always used for patching these. Large ladles are always

bricked up, while smaller ones (for Bessemer and small open-hearth furnaces) are lined with ball stuff of clay and ganister. It must be remembered that, just as in the furnace or vessel, the lining must correspond to the slag, although greater variations between them are allowable in the ladle, etc., as the slag is exposed to the air and partially chills, so that the reaction is much less vigorous. It would not do to use ganister to line a ladle for the basic, or a clay or loam with much free lime for the acid process; most loam and clay are, however, sufficiently neutral to be used for either.



