

THE VASSAR  
SEMI-CENTENNIAL  
SERIES

GIFT OF

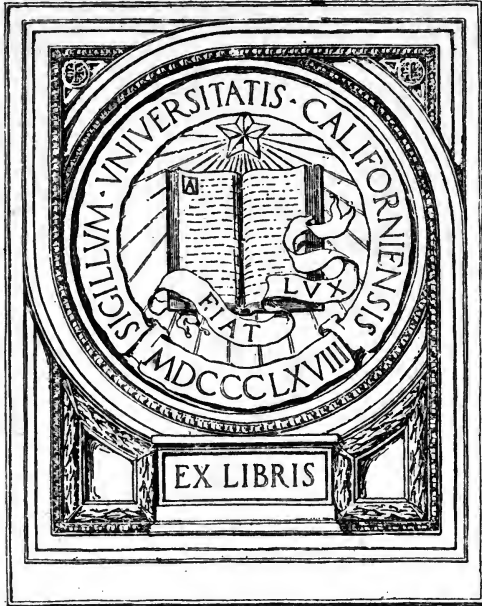

EX LIBRIS

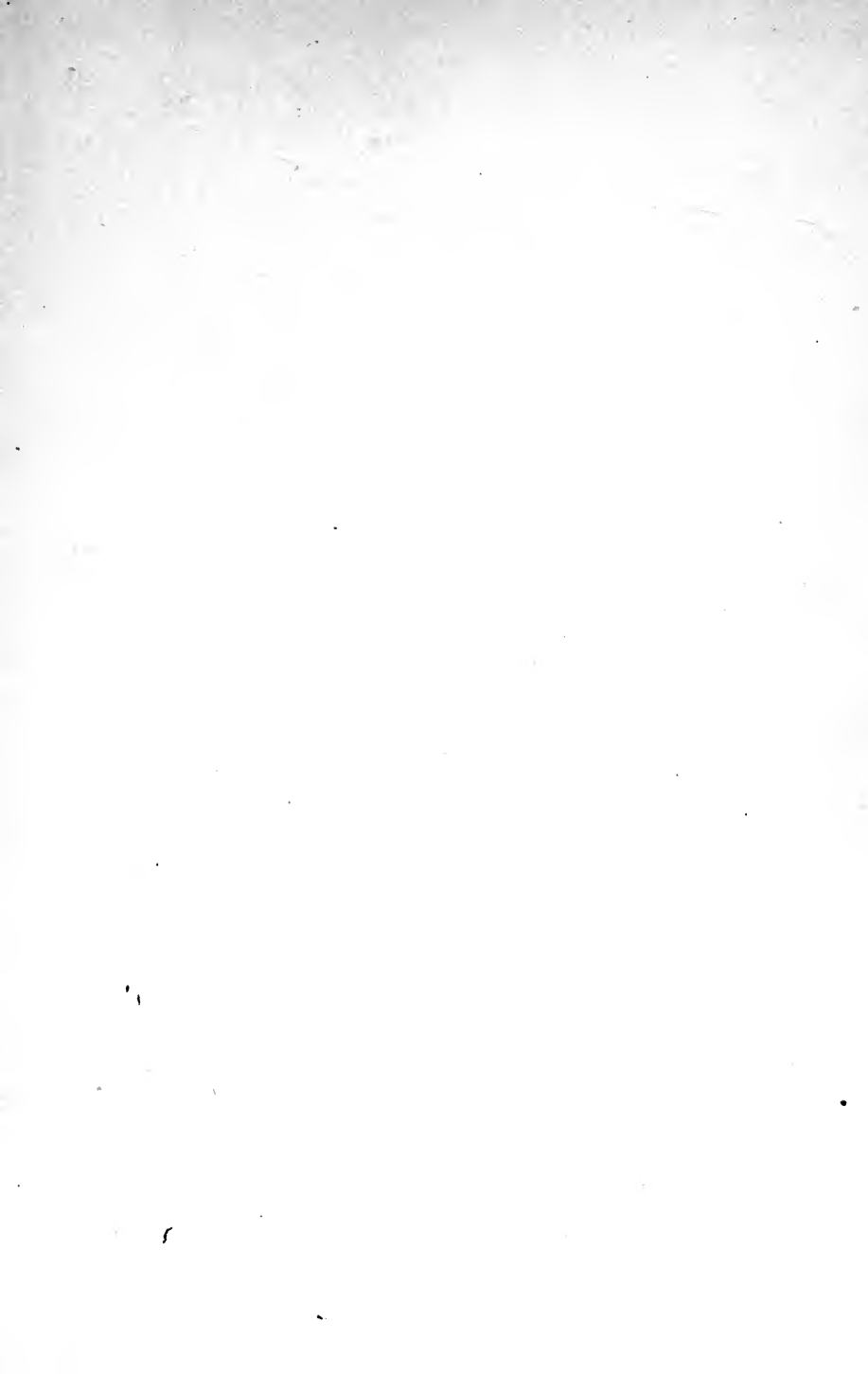

198





## Vassar Semi-Centennial Series

ELIZABETHAN TRANSLATIONS FROM THE ITALIAN. By MARY AUGUSTA SCOTT, Ph.D. (A.B. Vassar, 1876), Professor of English Literature in Smith College.

SOCIAL STUDIES IN ENGLISH LITERATURE. By LAURA J. WYLIE, Ph.D. (A.B. Vassar, 1877), Professor of English in Vassar College.

THE LEARNED LADY IN THE EIGHTEENTH CENTURY. By MYRA REYNOLDS, Ph.D. (A.B. Vassar, 1880), Professor of English Literature in Chicago University. [*In preparation.*]

THE CUSTOM OF DRAMATIC ENTERTAINMENT IN SHAKESPEARE'S PLAYS. By ORIB J. HATCHER, Ph.D. (A.B. Vassar, 1888), Formerly Associate Professor of Comparative Literature in Bryn Mawr College. [*In preparation.*]

INTRODUCTION TO THE STUDY OF VARIABLE STARS. By CAROLINE E. FURNESS, Ph.D. (A.B. Vassar, 1891), Professor of Astronomy in Vassar College.

MOVEMENT AND MENTAL IMAGERY. By MARGARET FLOY WASHBURN, Ph.D. (A.B. Vassar, 1891), Professor of Psychology in Vassar College. [*In preparation.*]

BRISSET DE WARVILLE: A STUDY IN THE HISTORY OF THE FRENCH REVOLUTION. By ELOISE ELLERY, Ph.D. (A.B. Vassar, 1897), Associate Professor of History in Vassar College.

HOUGHTON MIFFLIN COMPANY  
BOSTON AND NEW YORK

**AN INTRODUCTION TO THE STUDY  
OF VARIABLE STARS**



THE  
CALIFORNIA

THE  
ATLAS

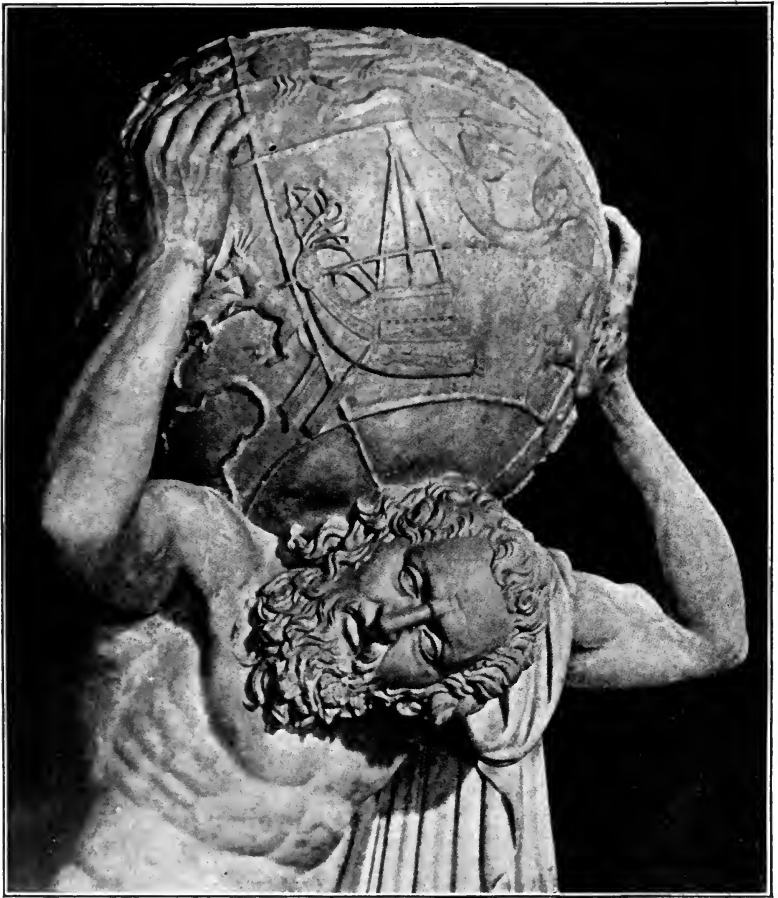

Plate I

ATLAS WITH THE GLOBE. NAPLES MUSEUM

Vassar Semi-Centennial Series

---

AN INTRODUCTION TO  
THE STUDY  
OF VARIABLE STARS

BY

CAROLINE E. FURNESS, PH.D.

*Director of the Vassar College Observatory*

*With Illustrations*



17 C

BOSTON AND NEW YORK  
HOUGHTON MIFFLIN COMPANY

*The Riverside Press Cambridge*

1915

UNIV OF  
CALIFORNIA

QB835  
F8

**COPYRIGHT, 1915, BY CAROLINE E. FURNESS**

**ALL RIGHTS RESERVED**

*Published October 1915*

GIFT

NO. 1111  
COPYRIGHT



PUBLISHED IN HONOR OF THE  
FIFTIETH ANNIVERSARY  
OF THE  
FOUNDING OF VASSAR COLLEGE  
1865-1915



DEDICATED TO  
MARY W. WHITNEY

IN MEMORY OF MANY HAPPY HOURS  
SPENT TOGETHER IN THE PURSUIT OF  
OUR LOVED SCIENCE



## PREFACE

DURING the past few years the subject of variable stars has become increasingly interesting to the amateur who is the owner of a telescope, as well as to the average college student who has some knowledge of astronomy, while to the research worker it offers many lines of investigation which are full of promise. However, so complex is the subject, and so diverse the principles involved in a complete understanding of it, that extensive reading in several different directions is required as a foundation.

It is with the purpose of supplying this need as well as of making an important and attractive branch of astronomy accessible to the student that the present volume has been prepared. It is the outcome of several years of teaching the subject in Vassar College, for which the material was primarily collected. This material is scattered throughout various periodicals in the form either of research papers or quite popular articles, intended to give directions for observation to owners of small telescopes. A large amount of historical matter is also included, which is taken from sources not within easy reach of the general reader. Mention may be made of some of the subjects treated, which are introductory to the study of stellar variation, such as the study of the *Durchmusterung* charts, photometry in all its branches, spectroscopy, and star color. The purpose of the present volume is to consider all of these points, and in particular to give in as simple and clear a form as possible a full presentation of the physical principles upon which many of the instruments and methods of investigation are based, principles such as those of polarized light, spectrum analysis, the formation of the photographic image, and photo-electricity. Textbooks on astronomy rarely include

such preliminary matters, even though they are not subjects which the student is necessarily expected to know.

Thus far no general book on variable stars has been presented to the public in English. In German a comprehensive treatise is being prepared by Father Hagen, and issued a section at a time. Two parts have already appeared, and in the introduction to the first, which is called the historical technical part, Hagen states that it is primarily a collection of sources, and that brief handbooks in different languages can easily be formed from the material included. The author, in a personal interview with this distinguished astronomer at Rome, in 1914, received encouragement from him to proceed with her project, and permission to use any of the material in his treatise. The present volume, however, is an introduction rather than a handbook, and as such devotes more space to explanatory material than to an extensive treatment of the results of research. Much of the material had already been collected before 1914, but frequent reference to Hagen's work will be found in the footnotes.

The writer wishes now to express her indebtedness to her many friends who have assisted her at various points in this undertaking; first to her astronomical colleagues, who looked over the outline and made valuable suggestions as to the points which should be included in it; to Professors Schlesinger and Jordan, of the Allegheny Observatory; to Professors Frost and Parkhurst, of Yerkes; and to Professor Pickering, of the Harvard Observatory. It is owing to suggestions from these astronomers that the chapter on photo-electric cells was included, and that so much space was given to photographic photometry and star colors. They also freely offered the use of any material from their publications which might be desired.

Whatever clearness of presentation there may be in the discussion of the photo-electric cell the writer owes to her colleague at Vassar, Professor Saunders, of the Physics Department, who gave generously of his time to the discussion of that difficult and unfamiliar subject, as well as of several other

technical points. Miss Ernestine Fuller, of the Astronomical Department, assisted by looking up references at several points and criticized the presentation of some of the physical principles. Professor Treadwell has given useful suggestions in regard to the drawings.

At the suggestion of Miss Helen Swartz several items were included which were thought to be useful to the non-professional observer. She also read a large part of the manuscript and made valuable criticisms of the form.

The writer wishes to express her thanks also to her students in the course on variable stars during the present year, Miss Vera Ringwood and Miss Evelyn Wickham, with whom she has held many discussions as to the form of presentation, and who, by their interest and candid criticism, have aided greatly in maintaining the standard of clearness which she has striven to reach.

Mr. Olcott, secretary of the American Variable Star Section, made suggestions as to what points the amateur observer would be especially interested in, and sent several items which have been incorporated in the chapter on "Hints to Observers." Mr. David Blencoe, also a member of the Association, has kindly sent his work on a statistical study of variable stars, which had been prepared for private circulation.

The author's greatest debt, however, is to Miss Helen Van Kleeck, who at several times in the past has assisted in preparing the publications of Vassar College for the press. To her faithful and intelligent work in transcription the writer owes the completion of the volume in the required time, and to her careful criticism is due much of the clearness of style. Miss Van Kleeck also prepared the drawings for the illustrations, which are provided for by the publication fund of the Observatory.

The observation of variable stars was introduced into the program of the Vassar Observatory by Professor Mary W. Whitney in 1901, and when later the subject was made a regular course of study in the astronomical department, the writer

co-operated with her for the first few years in giving the instruction. The writer cannot adequately express her constant indebtedness to Professor Whitney for the opportunity and encouragement afforded her during all her years of work at Vassar.

CAROLINE E. FURNESS.

VASSAR COLLEGE OBSERVATORY,  
*March 26, 1915.*



# CONTENTS

## I. INTRODUCTORY

General description of stellar variation. Elements of variation. Julian Day. Classification of variables. Principles of spectrum analysis. Classification of stellar spectra. Connection between spectral type and type of variation . . . . . 3

## II. STAR CHARTS FOR GENERAL USE

Argelander, *Uranometria Nova*. Heis, *Atlas Coelestis*. Schurig, *Himmels Atlas*. Upton, Klein, etc. Argelander, *Bonner Durchmusterung*, detailed account, with suggestions for its use. Palisa and Wolf, photographic maps. Ecliptic charts. Charts of *Carte du Ciel*. Precession . . . 38

## III. STAR CHARTS FOR VARIABLES

Hagen, *Atlas Stellarum Variabilium*, very detailed account, with directions for its use. Parkhurst, enlargements. Harvard photographic maps. Miscellaneous . . . 52

## IV. CATALOGUES OF VARIABLES

Naming of variables. Harvard, Hartwig, Chandler. Methods of discovery; visual, photographic, spectroscopic. Illustrations. Systematic search . . . . 68

## V. STELLAR MAGNITUDE

Early history. Ptolemy, Bayer, and others, before the invention of the telescope. Herschel. Argelander, magnitudes in the *Durchmusterung*. Gould. Pogson's rule. Fechner . . . . . 81

## VI. VISUAL PHOTOMETRY

Methods of observing variable stars visually. Argelander's step method. Harvard method of relative brightness. Use of direct magnitude. Precautions in observing.

Purkinje phenomenon. Dove's phenomenon. Polarized light. Zöllner photometer. Harvard meridian photometer. Pickering's wedge photometer . . . . .	103
<b>VII. PHOTOGRAPHIC PHOTOMETRY</b>	
The formation of star images. Chromatic aberration and color curve. Visual and photographic telescopes. Effect of color on size of image. Formulas for deriving magnitudes from measurements of photographic images. Stained plates. Connection with spectral type. Extra-focal images: Comparisons by Argelander's method. Work at Harvard . . . . .	130
<b>VIII. PHOTO-ELECTRIC PHOTOMETRY</b>	
Work of Stebbins with selenium cell. Principles of photo-electric action. Electrometer. Work at Berlin-Babelsberg. Description of instrument and the results. General conclusions . . . . .	154
<b>IX. FORMATION OF LIGHT SCALE</b>	
Combination of observations made by the Argelander method. Formation of light scale for comparison stars without weights. Light scale for variables. Light step converted into magnitude. Plotting of light curve by light step or magnitude. Determination of maximum or minimum from single light curve. Use of weights in forming scale . . . . .	170
<b>X. MEAN LIGHT CURVE</b>	
Use of Heis's observations of $\delta$ Cephei. Determination of period and epoch from light curve. Correction of approximate elements by later observations. Mean light curve. Use of mean light curve in determining minimum of Algol type. Harvard method for long period variables. . . . .	186
<b>XI. PREDICTION OF MAXIMA AND MINIMA FROM THE ELEMENTS</b>	
Explanation of Julian Day. Simple formula. Addition of periodic term. Secular term. Reduction to sun for short period variables . . . . .	204

# CONTENTS

xv

## XII. ECLIPSING BINARIES

Doppler's principle. Spectrographic apparatus. Application to variable stars. Explanation of Algol type. Evidence from light curve. Spectroscopic evidence. General relations.  $\beta$  Lyrae type. Cepheid variable type. Cluster type . . . . . 216

## XIII. LONG PERIOD VARIABLES

Irregular variables. Temporary stars. Collections of observations: Argelander, Schönfeld, Heis, Krueger, Schmidt, Pogson, Knott, Goodricke and Pigott, Gould, Chandler . . . . . 248

## XIV. STATISTICAL STUDY

Correlation of number, length of period, color, range of brightness, and spectral type for long and short period variables. Galactic distribution. Miscellaneous facts . 273

## XV. HINTS FOR OBSERVERS

Circulars issued by Harvard College Observatory inviting co-operation. American Association of Variable Star Observers. British Association. Hints for observers: (1) Use of telescope; (2) Time; (3) Identification of variable; (4) Methods of recording; (5) Precautions. Stars suitable for observers with telescopes of different aperture, mounted or unmounted. Brief bibliography. . 289

## APPENDIX

Table I. Julian Days . . . . . 311

Table II. Fractions of a day . . . . . 312

Explanation of Tables . . . . . 313

/ Description of plates of stellar spectra . . . . . 315

INDEX . . . . . 319

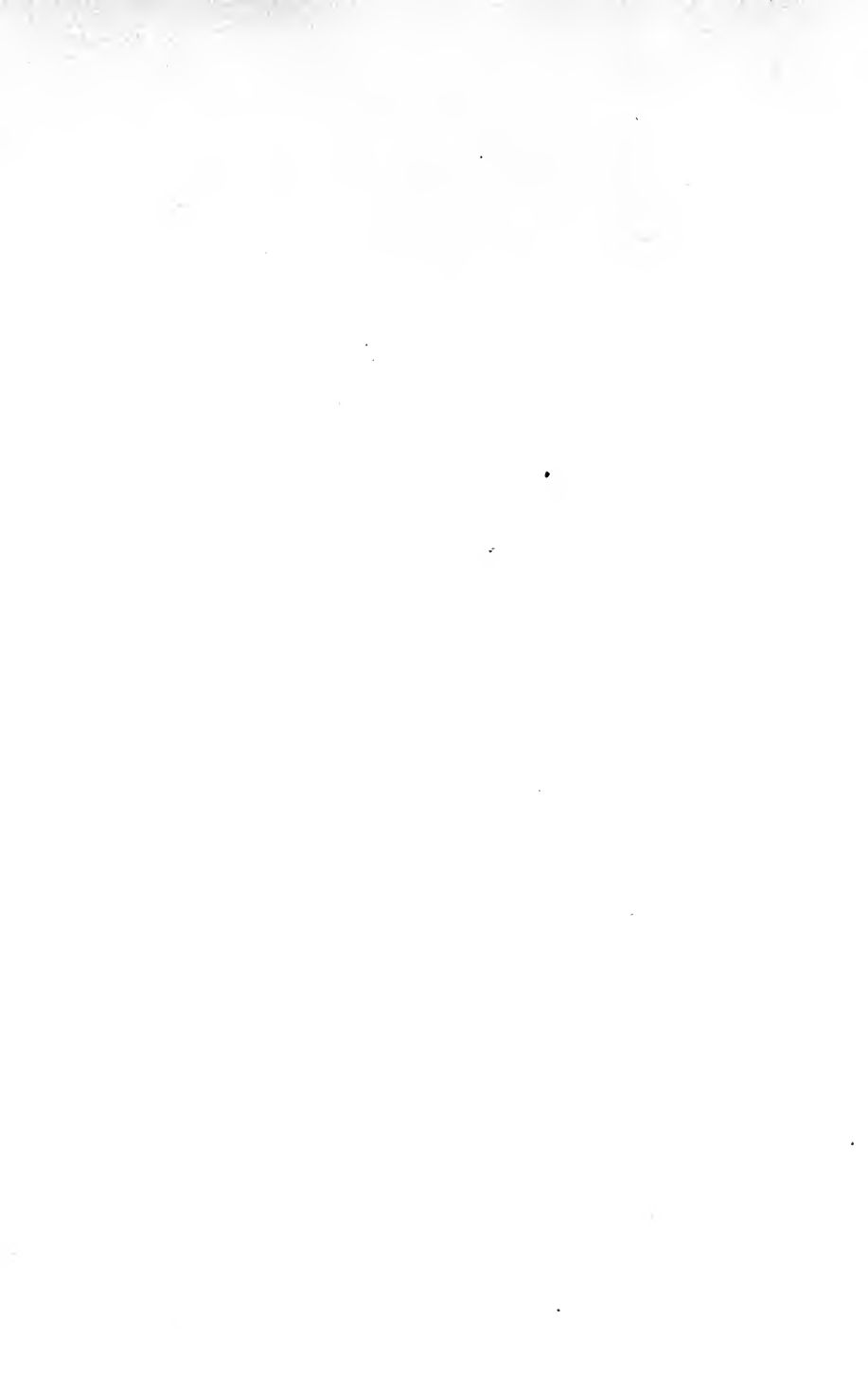

## PLATES

I. Atlas with the Globe. Naples Museum . . . . .	<i>Frontispiece</i>
II. Typical Stellar Spectra . . . . .	33
III. Frontispiece from Bayer's <i>Uranometria</i> , 1639 . . . . .	83
IV. The Constellation Gemini from Bayer's <i>Uranometria</i> . . . . .	85
V. Double-slide plate-carrier on the 40-inch Telescope. Yerkes Observatory . . . . .	139
VI. The two-foot Reflector. Yerkes Observatory . . . . .	141
VII. The Bruce Photographic Telescope. Yerkes Observatory . . . . .	145
VIII. The Bruce Spectrograph of the Yerkes Observatory, at- tached to the Telescope . . . . .	219
IX. The Bruce Spectrograph of the Yerkes Observatory, in- terior structure . . . . .	223
X. Spectra of $\zeta$ Ursae Majoris, showing lines single and double . . . . .	235
XI. Spectra of $\mu$ Orionis, showing different amounts of radial velocity . . . . .	237
XII. Spectra of Sun and Type A . . . . .	318
XIII. Typical Spectra . . . . .	318
XIV. Peculiar Spectra . . . . .	318



## FIGURES IN THE TEXT

1. Single Light Curve of S Ursae Majoris . . . . .	4
2. Light Curve of Nova Persei . . . . .	7
3. Mean Light Curve of T Cassiopeiae . . . . .	8
4. Mean Light Curve of R Ursae Majoris . . . . .	9
5. Light Changes of SS Cygni . . . . .	10
6. Mean Light Curve of $\delta$ Cephei . . . . .	11
7. Mean Light Curve of S Arae . . . . .	12
8. Mean Light Curve of $\beta$ Lyrae . . . . .	13
9. Light Curve of $\zeta$ Geminorum . . . . .	14
10. Light Curve of Algol . . . . .	15
11. Mean Light Curve of U Cephei . . . . .	16
12. Prism Spectroscope . . . . .	18
13. Diagram of a Complete Wave . . . . .	20
14. The Solar Spectrum . . . . .	28
15. Square from <i>Durchmusterung</i> Chart . . . . .	47
16. Magnitude Curve for RV Hydrae . . . . .	59
17. The Nicol's Prism . . . . .	115
18. The Zöllner Photometer . . . . .	117
19. Pickering's Meridian Photometer . . . . .	123
20. Wedge Photometer, Yerkes Observatory . . . . .	127
21. Color Curve of the 40-inch Objective, Yerkes Observatory .	143
22. Spectral Type and Color Intensity . . . . .	150
23. Diagram of the Photo-Electric Apparatus, Berlin-Babels- berg . . . . .	161
24. Single Light Curves of $\delta$ Cephei . . . . .	175
25. Light Curve of $\circ$ Ceti . . . . .	178
26. Magnitude Curve for $\circ$ Ceti . . . . .	180

27. Mean Light Curve of $\delta$ Cephei . . . . .	199
28. Diagram for obtaining the Reduction to the Sun . . . . .	214
29. Diagram I. The Light Curve of an Eclipsing Binary . . . . .	231
30. Diagram II. The Relative Orbit . . . . .	232
31. Diagram III. The Real Orbits . . . . .	233
32. Diagram IV. Spectroscopic Evidence . . . . .	234
33. Diagram V. The Velocity Curve . . . . .	234
34. The System of $\beta$ Lyrae . . . . .	242
35. Theoretical System of $\delta$ Cephei . . . . .	247
36. Relation between Color and decreasing Brightness . . . . .	277



**AN INTRODUCTION TO THE STUDY  
OF VARIABLE STARS**

## ABBREVIATIONS

Annals, H.C.O.,	Annals of the Harvard College Observatory.
A. G.,	Astronomische Gesellschaft.
A. N.,	Astronomische Nachrichten.
Ast. Jour.,	Astronomical Journal.
Ap. J.,	Astrophysical Journal.
H.C.O. Circ.,	Harvard College Observatory Circulars.
L.O.B.,	Lick Observatory Bulletins.
Mem. R.A.S.,	Memoirs of the Royal Astronomical Society.
Phil. Trans.,	Philosophical Transactions of the Royal Society, London.
Physik. Zeits.,	Physikalische Zeitschrift.
Pop. Ast.,	Popular Astronomy.
Potsdam Phot. DM.,	Potsdam Photometric Durchmusterung.
Rad. Obs.,	Radcliffe Observatory Publications.
Uran. Arg.,	Uranometria Argentina.
Ver. St.,	Veränderliche Sterne, by Hagen.
V.J.S.,	Vierteljahrsschrift der Astronomischen Gesellschaft.

# AN INTRODUCTION TO THE STUDY OF VARIABLE STARS

## CHAPTER I

### INTRODUCTORY

WE shall take it for granted that the reader is already acquainted with the main facts of Astronomy, but since this does not necessarily include a knowledge of the points which bear directly upon the study of variable stars, a brief résumé of them will be given in this introductory chapter. However, the statements made here are to be considered as preliminary only, and each will be more fully discussed in some later chapter. The topics presented will be a general description of stellar variation, the elements of variation, classes of variables, the general principles underlying spectrum analysis, the classification of stellar spectra, and the connection between the spectral type and the type of variation.

#### GENERAL DESCRIPTION OF STELLAR VARIATION

A variable star is one that undergoes a change in brightness. With some stars the change is as great as four or even six magnitudes, while with others it may be only one magnitude, and in some cases as small as half a magnitude. This change in brightness is observed by comparing the light of the variable with the light of some standard star which is assumed to be constant in brightness, the comparison being made either directly, or through the medium of some sort of artificial star. The different methods of making the comparisons will be discussed at length in the chapters on photometry. It is sufficient here to state that the result of the observations is to furnish the magnitudes of the variables at certain recorded instants

## THE STUDY OF VARIABLE STARS

of time. In order to represent the variation to the eye, the data are plotted on co-ordinate paper, using the time as the horizontal co-ordinate, or abscissa, and the observed magnitude as the vertical co-ordinate or ordinate. A smooth curve is then drawn through the points which is called the *single light curve* of the variable. This is illustrated in the following diagram.

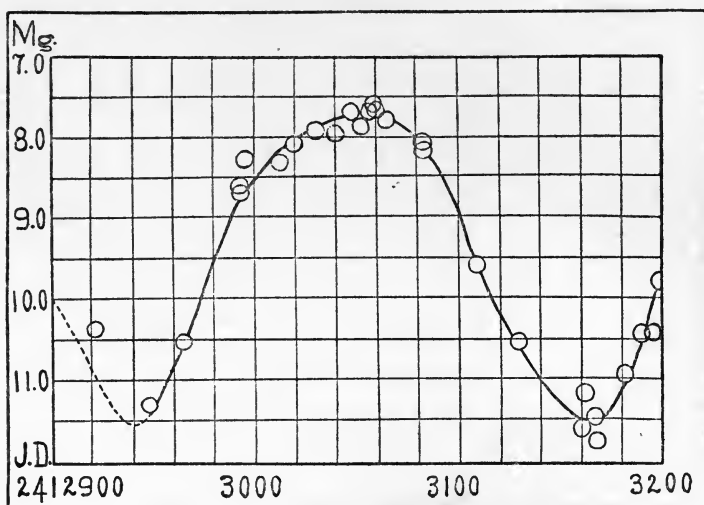

Figure 1

### SINGLE LIGHT CURVE OF S URSAE MAJORIS

#### ELEMENTS OF VARIATION

When a long series of observations has been made and the results plotted as just described, a study of the curves will show that the same form recurs with more or less regularity, and that certain quantities can be determined which will describe it. They are the magnitude at maximum, the magnitude at minimum, and the length of the period, *i.e.*, the time from one maximum or minimum to the one next following. These are known as elements of variation and to them is added the

epoch, that is, the date of some very well-determined maximum or minimum, its selection depending upon the nature of the curve. This date is usually changed from the calendar date into the corresponding day of the Julian period, and is known as Julian Day. The Julian period, as the name implies, is a continuation of that introduced at the time of Julius Cæsar, according to which the days are numbered consecutively, beginning at 4713 B.C. It has been adopted into variable star work, in order to facilitate the combination of observations scattered over a long period of time. The Julian Day for January 1, 1915, is 2,420,499. For a fuller explanation see Chapter XI.

The observations as described above are finally combined into one curve called the *mean light curve*, which represents the average course of variation of the star, smoothing out the small irregularities. It is upon the study of the mean light curves of great numbers of variables that the classification is based. The method of forming it will be treated in Chapter X.

#### CLASSES OF VARIABLES

From the study of their curves, it has been found that variable stars may be divided into distinct groups, each one having its own particular light curve. Several different groupings have been made by different astronomers. The one which is best known and most widely used is due to Professor E. C. Pickering, of the Harvard College Observatory. It was first proposed by him in 1880 in the *Proceedings of the American Academy of Arts and Sciences*, vol. xvi, pp. 17, 257. It is later repeated in the *Provisional Catalogue of Variable Stars*, which forms No. III of vol. 48 of the *Annals* of the Harvard College Observatory, from which source the present statement is taken.

Class I represents new or temporary stars; Class II, variables of long period; Class III, variables of small range, or irregular variation according to laws as yet unknown; Class IV, variables of short period; and Class V, variables of the

Algol type. Class II may be subdivided into Class IIa, which contains the ordinary variables of long period, and Class IIb, to which U Geminorum and SS Cygni belong. The latter are usually faint and of nearly uniform brightness, with occasional sudden and irregular outbursts of light which diminish gradually. Class IV can similarly be divided into Class IVa, which contains ordinary variable stars of short period, and Class IVb, of which  $\beta$  Lyrae is the typical star.

CLASS I. *New or Temporary Stars.* A new star is one which grows bright very suddenly, often in a few hours, and then fades away, more or less gradually, becoming either a faint star, or a planetary nebula. An excellent discussion of these stars may be found in Miss Clerke's interesting and valuable volumes, *The System of the Stars* and *Problems in Astrophysics*. The two brightest novae of recent years were discovered by Thomas Anderson of Edinburgh. They are Nova Aurigae and Nova Persei. A portion of the curve of the latter star is given below. Though it appears for a time to have somewhat regular fluctuations, it is in reality a variable having but one maximum, which is followed by a prolonged minimum.

One might inquire whether it is possible to obtain any information regarding the history of a new star before the time of the first observation, and also whether any such stars have been observed before their maximum brightness was attained. The answer to both questions is an affirmative one. By means of the great store of photographic plates at the Harvard Observatory and elsewhere, it is always possible to trace back the history of each new star, until we reach a time when it is fainter than any star recorded on the photograph. Just what magnitude is thus represented depends upon the length of the photographic exposure, being sometimes the eleventh magnitude, and sometimes even fainter.

For example, Nova Aurigae, when discovered by Anderson, was a yellowish star of the fifth magnitude. From October 21 to December 1, 1891, photographs of the same region had been taken at the Harvard Observatory, thirteen in number, from

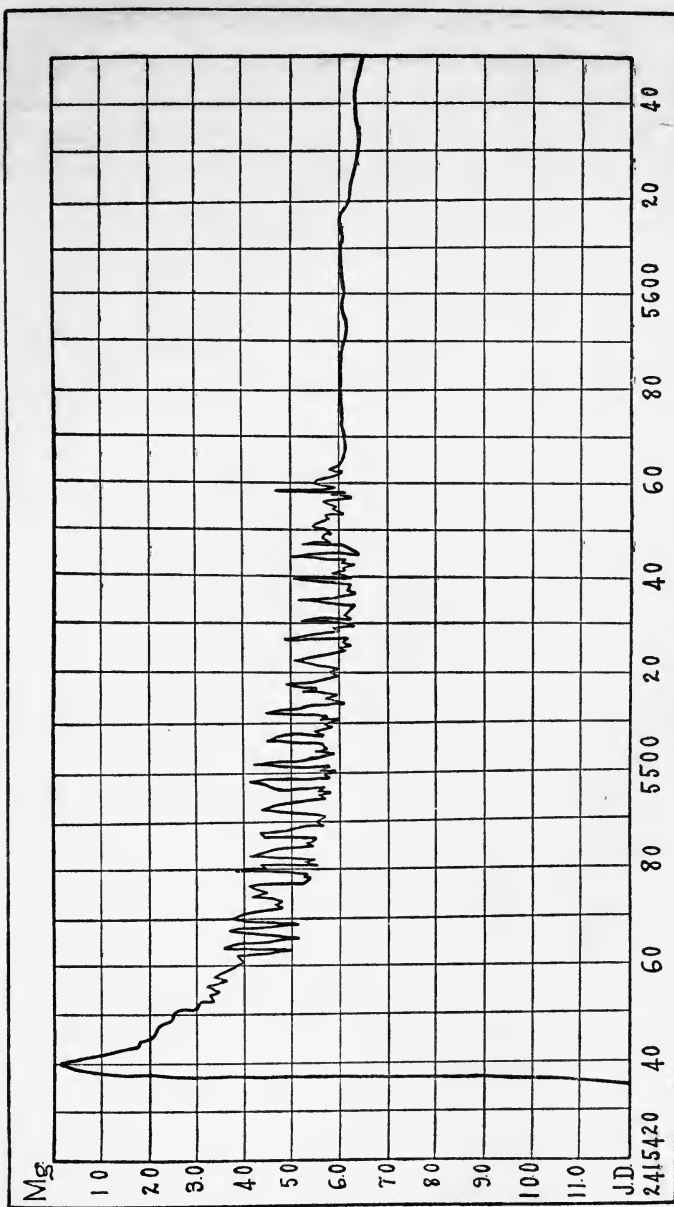

FIG. 2. LIGHT CURVE OF NOVA PERSEI

all of which it was absent. On December 8 it is also lacking on a photograph taken by Wolf, of Heidelberg, which shows stars of the ninth magnitude. On December 10, a plate taken at Harvard shows it to be of the 5.4 magnitude, and following photographs at the same Observatory show that it reached a maximum of 4.4 on December 20, hence it was already on the downward slope of its light curve when discovered. Its sudden increase in brightness from below the ninth magnitude to 5.4 must have taken place in about twenty-four hours. The case of Nova Persei is equally striking. When discovered on February 22, 1901, it was brighter than the second magnitude and had not then attained its greatest brightness. On a plate taken twenty-eight hours previously, containing stars of the twelfth magnitude, it did not appear, hence it must have increased ten magnitudes during that time.

A very extensive series of observations covering the recent history of some of these stars has been made by Professor Barnard at the Yerkes Observatory, and published in the

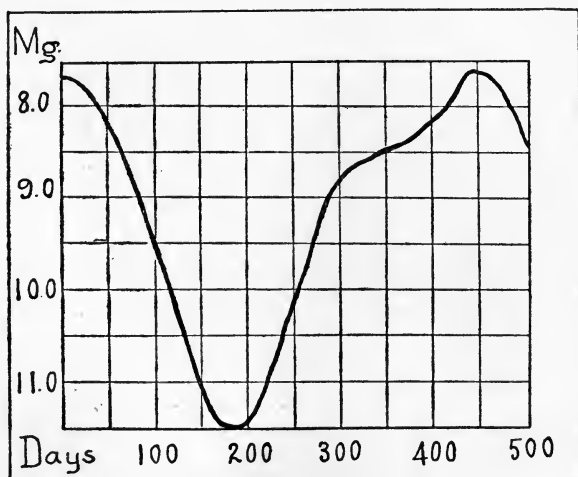

Figure 3

MEAN LIGHT CURVE OF T CASSIOPEIAE



*Astronomische Nachrichten*, No. 4655. They include eleven stars and cover a period of twenty years. Briefly stated the result is that some of the novae are now merely ordinary faint stars, while others, from their hazy, ill-defined appearance, are regarded as probably nebulous stars. Some are no longer visible.

CLASS II. *Variable Stars of Long Period*. As the name implies, the variation of these stars is periodic in character, that is, it is repeated in practically the same kind of curve at intervals more or less regular; or in other words, the stars increase to a maximum brightness, diminish to a minimum, and repeat the process in the same manner periodically. There are certain irregularities in the repetitions, for the brightness at maximum or minimum is not uniform, neither is the interval of time between two successive maxima always the same; nevertheless, the variation is distinctly periodic. The greater number of variables belong to this class. The periods range in length

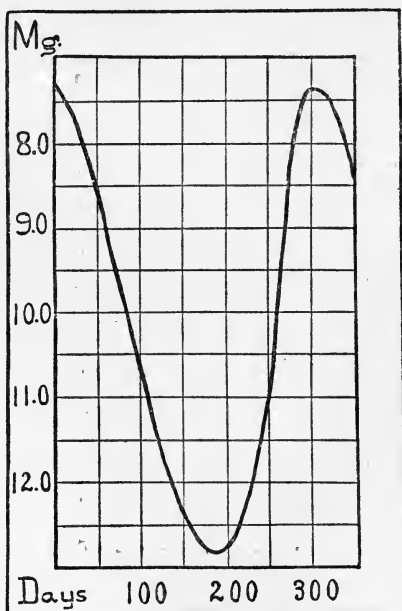

Figure 4

MEAN LIGHT CURVE OF R URSAE  
MAJORIS

from about fifty days to over six hundred days, the greatest number being from two hundred and fifty to three hundred days in length. Figures 3 and 4 show the mean light curves of two long period variables. They were taken from the *Harvard Observatory Annals*, vol. 37, Plate II.

CLASS IIb. *Stars of the U Geminorum Type.* These are characterized by a very rapid rise from a constant minimum to a maximum which does not last for any regular interval of time, being sometimes long and sometimes short, and which in turn is followed by a slow decline to the minimum. This change does not occur with any regularity, but is always unexpected. There are two other stars in this class in addition to the typical one. They are SS Cygni and SS Aurigae. The first of these, being a little brighter and having a shorter period than U Geminorum, as well as being more favorably situated for observation, has been studied more extensively. Below is given its mean light curve, showing the two forms of maximum, derived by Parkhurst (*Astrophysical Journal*, 12, 265).

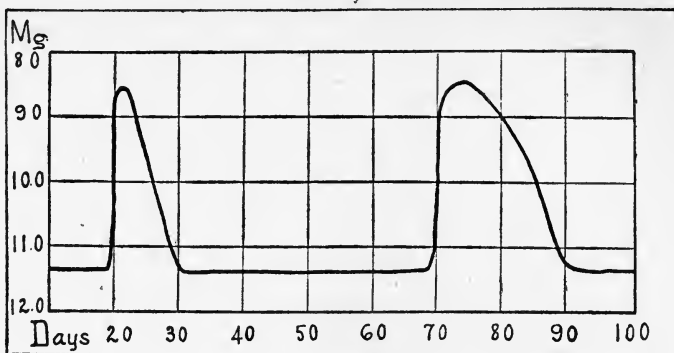

Figure 5

## LIGHT CHANGES OF SS CYGNI

CLASS III. *Irregular Variables.* In this class are placed those stars which give evidence of such irregularities that no period can be assigned to them, for example,  $\alpha$  Orionis and  $\alpha$  Herculis. It has occasionally happened, however, that a star that has been placed in this class has later, through more continuous observation, been found to belong to another group. An example of this is the star  $u$  Herculis, the variability of which was discovered as early as 1869, and which was long

classified with the irregular variables. In 1908, from close observation it was found to have a period of 2.05 days and was placed in Class IV. Many of the truly irregular stars have a reddish color, a fact which is closely connected with their spectra, and will be explained more fully in the section on stellar spectra.

CLASS IV. *Short Period Variables.* The stars of this group have periods extending from several hours to forty-five days, but, as will be seen later, the actual dividing line between long and short period variables does not depend on the length of period alone but upon the spectrum and the character of the light curve. According to Pickering's classification, this group has two subdivisions. Of the first,  $\delta$  Cephei is the typical star. It shows a rapid rise to maximum, which occupies in general one-third of the period. This is followed by a slower decline, in the course of which there may occur a more or less accentuated halt. From the typical star of the group the name "Cepheid" variables has been in frequent use, but quite recently it has been criticized on the ground that it is given also

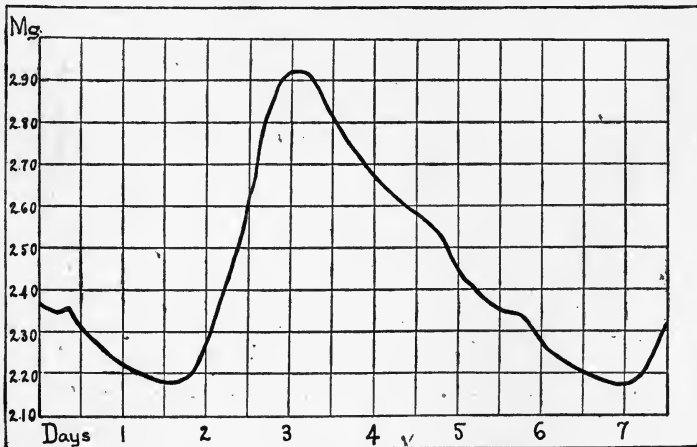

Figure 6

MEAN LIGHT CURVE OF  $\delta$  CEPHEI

to meteoric showers which have their radiant points in the constellation of Cepheus. Hartwig,<sup>1</sup> who makes the criticism in his *Katalog* for 1914, suggests instead the word "Blinkstern," for which there is no good English equivalent. He calls attention to the fact that the light curve of these stars is characterized by a rapid brightening to a maximum of short duration, which is followed by a gradual decline to the minimum, and furthermore, that these phases occur with extraordinary regularity. He likens it to the effect produced by a revolving light in a lighthouse on the sea coast, in which there is the same rapid brightening, leading to a short and brilliant maximum followed by a gradual diminution to the minimum, always performed with absolute regularity. Such a light is called in German "Blinklicht," whence the name "Blinkstern." However, it should be said in defense of the name

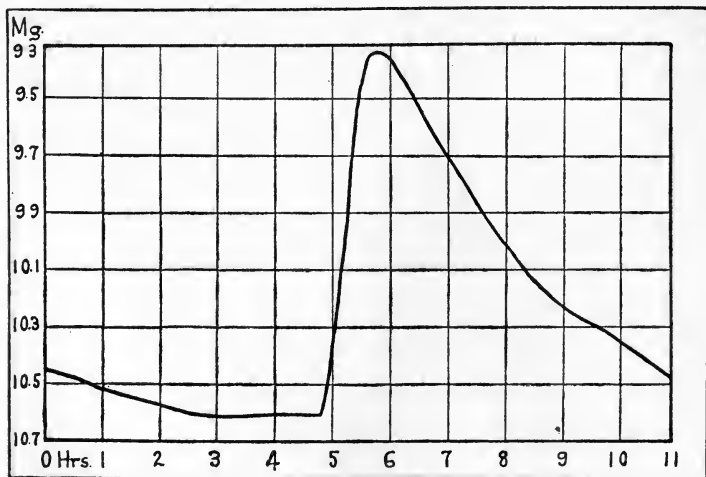

Figure 7

MEAN LIGHT CURVE OF S ARAE

<sup>1</sup> Ernst Hartwig, *Katalog und Ephemeriden veränderlicher Sterne für 1914*, 287.

“Cepheid Variable” that the term has been in use for some years, and there has been no confusion between the variables and the shooting stars. The group is named from the best known star in it, on exactly the principle according to which we refer to the Algol stars and the  $\beta$  Lyrae type. The writer sees no need for the change.

On pages 11 and 12 appear the light curves of two stars in this group, differing somewhat from each other, the second of which has usually been classified with a small group called Ant-*algor* stars because their curves seem to be an inversion of the Algol type, but which have been included by Hartwig under the title “Blinkstern.” They are  $\delta$  Cephei<sup>1</sup> and S Arae.<sup>2</sup>

$\beta$  Lyrae is typical of the second division, and until rather recently was considered to be the only representative of its class, but in 1914 the list published in the *Vierteljahrsschrift* contained eighteen similar to it. The curve shows a rapid rise



Figure 8

MEAN LIGHT CURVE OF  $\beta$  LYRAE

<sup>1</sup> Joel Stebbins, *Ap. J.*, 27, 193.    <sup>2</sup> Alex. W. Roberts, *Ap. J.*, 33, 208.

from minimum to maximum, similar to that of  $\delta$  Cephei, followed by a decline to a secondary minimum, after which there is another rise to a maximum of the same magnitude as before, and again a decline to the primary minimum. That is to say, there are two equal maxima separated by two unequal minima. The star's curve is given on page 13.<sup>1</sup>

There are a few short period variables which show a symmetrical curve, that is, one whose ascending and descending branches are alike.

$\zeta$  Geminorum is the typical star of the group. Its light curve<sup>2</sup> is given below. Hartwig mentions nine which he calls of this type.

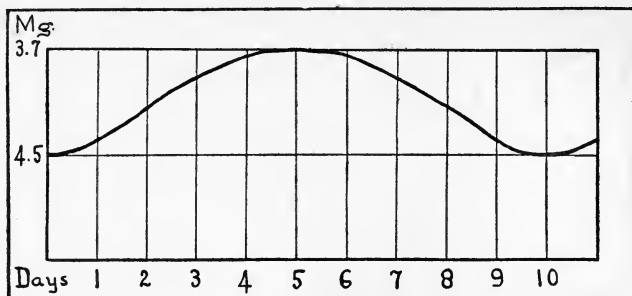

Figure 9

LIGHT CURVE OF  $\zeta$  GEMINORUM

What is known as the cluster type of variable will be discussed in Chapter XII. Typical curves may be found in *Annals*, H.C.O., vol. 38. The one which occurs with greatest frequency is similar to the curve of S Arae shown above.

CLASS V. *Algol Stars*. The stars of this group also have short periods and hence might properly form a subdivision of Class IV, but they are so numerous and have such a distinctive curve that they are grouped together, and take their name from the first representative discovered. The curve is charac-

<sup>1</sup> G. W. Myers, *Ap. J.*, 7, 3.

<sup>2</sup> W. W. Campbell, *Ap. J.*, 13, 92.

terized by a sustained maximum broken by a swift descent to minimum, which is sometimes quite short, and sometimes continues for an hour or so. Following is a rise to maximum very nearly symmetrical with the descending branch. The time spent in the change is called the duration of phase. In some cases a secondary minimum appears. Below are given the light curves of two stars in this group; that of Algol,<sup>1</sup> which has a short minimum and that of U Cephei,<sup>2</sup> which has a long minimum.

The descriptions just given are necessarily brief and lacking

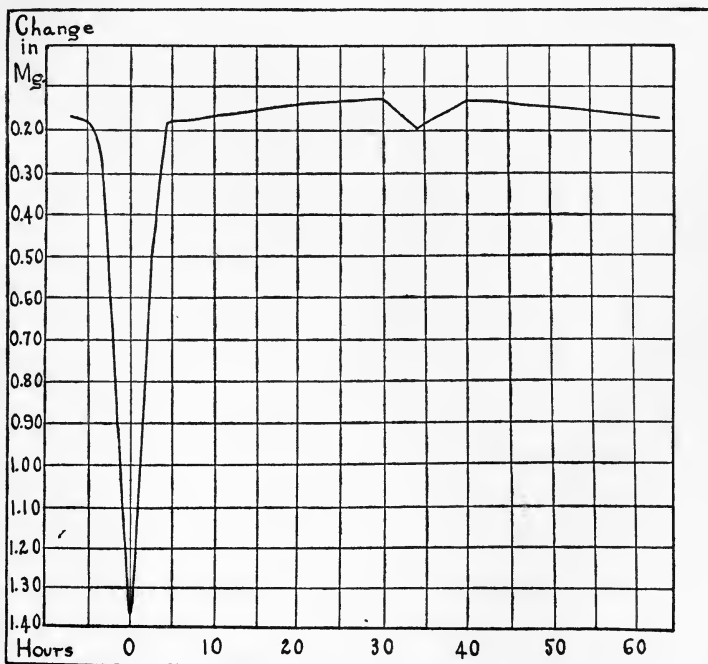

Figure 10

LIGHT CURVE OF ALGOL

<sup>1</sup> Joel Stebbins, *Ap. J.*, 32, 199.

<sup>2</sup> P. S. Yendell, *Pop. Ast.*, 14, 600.

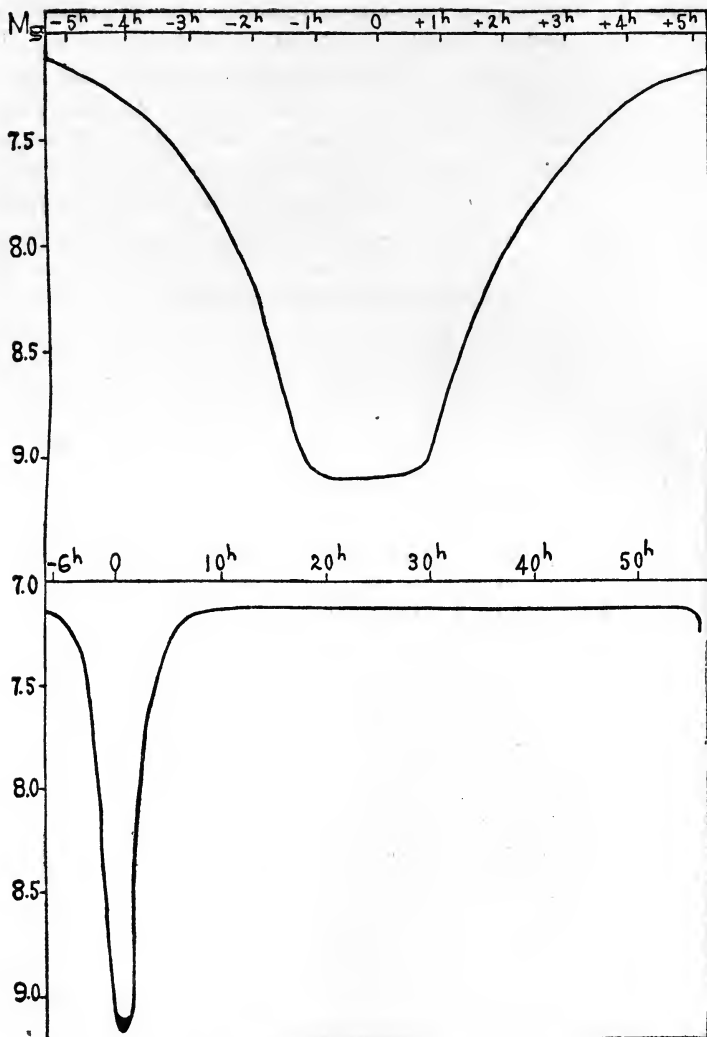

Figure 11

MEAN LIGHT CURVE OF U CEPHEI



in details, but are sufficient for introductory purposes. They should enable the reader to understand the characteristics of the different classes of variables and to recognize their light curves. Many variables are as yet unclassified because sufficient data have not been gathered to enable us to determine the light curves. These are designated as unknown, or in German, "unbekannt." It should finally be stated that recently there has been a tendency to give up the distinctions between some of the different classes of short period variables, and to put the Algol and  $\beta$  Lyrae variables under one heading, since their variation is supposed to be due to the same cause. Certain individual stars also, upon closer examination of their curves, have been transferred from one division to another. The present classification cannot be considered as final.

#### PRINCIPLES OF SPECTRUM ANALYSIS

It has been found from a statistical study of the spectra of variable stars that there is a marked correlation between the character of the spectrum and the type of variation, and also that with certain types of stars there are important changes that take place in the spectrum accompanying the changes in the light. In order to interpret these correctly, it will be necessary to understand the principles which underlie the formation of the spectrum and to be familiar with the classification of stellar spectra.

If we allow a beam of white light such as comes from a candle or an incandescent light to fall upon a prism, we find that when it emerges from the prism, instead of being white it is broken up into a rainbow band of colors arranged in the order: red, orange, yellow, green, blue, indigo, and violet. We find also that the ray of light has changed its direction, that it is bent aside from the path it would pursue if the prism were removed, that the red color is bent the least, and the violet the most. The breaking up of the light into its component colors is called *dispersion*, the bending of the different colors, *refraction*, and the angle through which it takes place is called the

*angle of deviation.* The purest colors in the spectrum are obtained when the light which falls upon the prism is admitted through a narrow slit, and for the best effect the slit should be placed a long distance away from the prism. There are obvious practical difficulties in the way of doing this, and the same result is accomplished by placing the slit in the focus of a telescope which is turned toward the prism. The rays of light then emerge parallel from the lens and according to the well-known laws of optics the effect is produced of removing the slit to a great distance. This is called the collimating telescope. In order to examine the spectrum to the best advantage, another telescope is added called the view telescope, which is equipped with a micrometer and cross wires for making measurements.

The accompanying diagram shows a simple laboratory prism spectroscope. To the parts mentioned above is added a scale

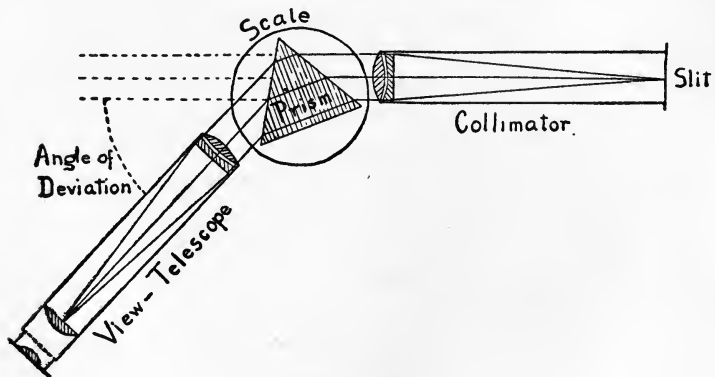

Figure 12

PRISM SPECTROSCOPE

for reading the angle of deviation of any desired part of the spectrum. When the spectrum of a star is to be observed, the spectroscope must be attached to the telescope, and should be especially designed for the purpose to which it is to be put.

In order to understand what causes light to behave in this way and how the spectrum may be used for measurement, it will be necessary to give some explanation of the principles of light. It should be understood, however, at the outset, that the explanation is not exhaustive, but is intended only to give a sketch of the problem, and those who are interested to pursue it further are referred to the various standard authorities on the subject.

We first assume the existence of ether, a transparent elastic medium, filling all space and even the interstices of matter. Light is a wave motion in this ether, and is transmitted through it in straight lines. This is called the rectilinear propagation of light. The wave motion or vibration is a periodic disturbance which is handed on successively from one portion of the medium to another. The particle which is being disturbed has a vibratory motion but does not travel on with the wave. The simplest illustration of this is found in water waves. If a stone is thrown into a quiet pool of water, a series of waves is started which spread in ever widening circles to the edges of the pool. Those nearest the center of disturbance are the most violent, and the depth of the successive waves diminishes as their distance from it increases. The particles of water do not travel outward with the waves, for if a leaf is floating on the pool it will not be driven to the shore, but will rise and fall on the surface of the waves as they pass under it. Its direction of vibration is thus perpendicular to the direction of propagation of the waves.

Ether waves are of the same nature, that is, the vibration of their particles is perpendicular to the direction of propagation. Furthermore, so perfect is the elasticity of the ether that any number of waves can pass through it at the same time in all directions, without interfering with one another.

A wave-length is the distance the disturbance travels while the first particle is executing one vibration. This is generally represented by the symbol  $\lambda$ .

The accompanying diagram shows the different parts of a

complete wave. The arrows attached to the dots represent the direction in which each particle is about to move. In the diagram, *a*, the first particle, has completed one vibration, *b* three fourths of a vibration, *c* one half, and *d* one fourth, while *e* is about to begin its oscillation. The distances of *b* and *d* from the line represent the maximum displacement in the wave, and are called the amplitude of the vibration. The distance *ae* is called the wave-length. The phase of a particle is defined by its position in the wave, that is, by its distance from the original position and its direction of motion. This may be

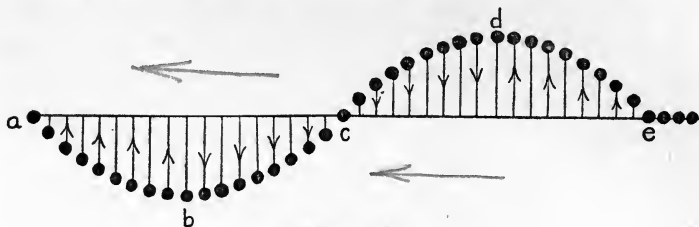

Figure 13

DIAGRAM OF A COMPLETE WAVE

more clearly understood by pointing out when two particles are in the same or in opposite phase. The former occurs when the two particles have the same displacement and the same direction of motion; for example, *a* and *e*, for *a* has completed one vibration, and is ready to start on a second, while *e* is about to begin its first vibration. They are separated by a whole wave-length. On the other hand, *b* and *d* are in opposite phase, for though they have the same displacement in amount, they have opposite directions of motion, since *b* is about to move up toward its original position, while *d* is about to move down. They are separated by an odd number of half wave-lengths.

The length of the light wave which falls upon the retina determines the sense impression of color, and different portions of the spectrum have different wave-lengths. The actual length of a wave of any isolated color may be obtained in the physical laboratory with the use of a spectrometer. The length

of the wave of a red ray at the extreme end of the spectrum is 0.0007600 millimeters, and that of the extreme violet 0.0003900 millimeters. Since these numbers are inconvenient to handle, a small unit has been adopted called the Ångström unit from the name of the Swedish physicist who first used it.

It has a value of  $\frac{1}{10^{10}}$  meter or a tenth meter, and is abbreviated

A.U. Measurements of wave-lengths can be made with extreme accuracy, that of the sodium line D being 5896.616 A.U.

There are other portions of the spectrum beyond the region visible to the eye. That part having a shorter wave-length than 3900 A.U. is called the ultra-violet, and can be extensively studied by photography, as the rays possess strong actinic power. Many stars are strong in this part of the spectrum. The infra-red lies at the other end of the visible spectrum, beyond wave-length 7600. It has strong heat radiation and its character may be studied by means of its thermal effects. The infra-red spectrum of the sun has been thoroughly investigated since its heat emanations are very strong, while this part of stellar spectra is lacking, since only a minute quantity of heat reaches the earth from the stars.

The vibration frequency of an oscillating particle, or the number of vibrations which strike the eye per second, is of importance and may be found as follows:—

Let  $\lambda$  = the wave-length or the distance the disturbance has traveled while the original particle has executed one vibration;

$V$  = the distance traveled by light during one second of time, or 186,330 miles;

$n$  = the number of vibrations performed by a particle during one second;

$$\text{Then } n = \frac{V}{\lambda}.$$

The vibration frequency thus bears an inverse relation to the wave-length. In the red end of the spectrum,

$$n = \frac{186,330 \text{ miles}}{.000760 \text{ mm}} = 395 \text{ 000 000 000 000}.$$

⊗ ten-millionth?  
ten billionth.

For the violet end of the spectrum, it is 760 000 000 000 000.

As has been stated, when white light passes through a prism, it appears as a band of color in which there is no break in the series from the red at one end to the violet at the other. Such light comes from a candle flame or from an incandescent light, and the spectrum that it produces is called a continuous spectrum. If the source of light should happen to be a Bunsen flame in which sodium chloride or common salt is burning, the appearance presented by the spectrum would be quite different. Instead of showing the unbroken band of color, there would be seen two yellow lines very close together and nothing else. Further, when we examine the spectrum of the sun, we see the rainbow band of color, but it is crossed by vertical dark lines arranged in irregular groups, which are invariably the same at all times of observation. It appears, thus, that the character of the spectrum depends upon the nature and condition of the substance or body producing it. From the investigation of these facts, the principles of spectrum analysis have been deduced. Their importance cannot be overestimated, since upon a correct understanding of them depends the interpretation of the many details presented by the spectra of the sun and stars. They may be expressed in the following simple forms, which must be understood as being merely abbreviated statements and not an explanation of the complete laws.

A bright spectrum, whether it be continuous, or whether it consist of separate bright lines, is called an emission spectrum. When the bright spectrum is crossed by dark lines or bands, the lines and bands together form an absorption spectrum. An emission spectrum, then, may be seen by itself, but an absorption spectrum is only seen when superposed upon a bright background, that is, against an emission spectrum. A further investigation of the lines shows the following general principles: —

1. An incandescent solid or liquid or a gas under very high pressure will give a continuous spectrum.

<sup>EMISSION</sup>

2. An incandescent gas will give a discontinuous spectrum, that is, a spectrum consisting of separate bright lines. The lines forming this spectrum invariably occupy the same positions, that is, have the same wave-lengths, so long as the conditions of temperature and pressure affecting the source of light remain the same. For example, under ordinary conditions the spectrum of hydrogen consists of four bright lines, one red, one bluish green, and two violet, called in order  $H\alpha$ ,  $H\beta$ ,  $H\gamma$ ,  $H\delta$ . Each gas, then, has its own particular spectrum, and the wave-lengths of its lines can be measured. No two gases have lines of the same wave-length; that is, there is no line common to two gases. The spectra of almost all of the known elements on the earth's surface have been investigated and mapped, and tables of wave-lengths have been published. It is no easy task to complete this investigation, partly because some of the elements are quite rare, but primarily because the spectrum varies with changing temperature and pressure, as will be described at length later on. It is obvious that the elements represented in a continuous spectrum cannot be distinguished.

3. A gas absorbs from white light passing through it precisely those wave-lengths of which its own spectrum consists. If it is a cool gas, or a luminous one but of a lower temperature than the source of white light behind it, it will produce relatively dark lines in the spectrum. If it is hotter than the source behind it, it will produce bright lines. If of just the same temperature, no effect will be produced. This third principle is known as Kirchhoff's law.

Thus we can determine to some extent from the appearance of the spectrum of a heavenly body what its physical condition is, and of what elements it is composed. If like the sun it has a continuous spectrum crossed by dark lines, we know that it consists of a central core which produces a continuous spectrum; that is, it must be a glowing solid or liquid, or a gas under very great pressure, but we cannot tell which of the three, nor can we tell of what elements it is composed. We

know further, that this central core is surrounded by an atmosphere of cooler gases which we can identify after the wave-lengths have been measured, by their coincidence with the wave-lengths of terrestrial substances, if these are already known.

If, on the other hand, as is the case with some of the stars, the continuous spectrum is crossed by bright lines, this is an indication that the central core is surrounded by an atmosphere which is of a higher temperature than itself; and as before, if we can identify the lines, we can identify the elements of which the atmosphere is composed.

A discontinuous spectrum of bright lines, which is characteristic of certain of the nebulae, shows that the body producing it is a true gas.

The above statements make it evident that before we can decide what elements are present in the atmosphere of the sun or a star, we must have a complete set of the wave-lengths peculiar to all of the elements on the earth's surface.

From the second principle of spectrum analysis it follows that in order to present a spectrum of separate bright lines, the substance must be in the form of an incandescent gas. Some elements, such as hydrogen and oxygen, exist as permanent gases, but others must be subjected to heat in order to become volatilized. The temperature at which this occurs varies with the different elements, and hence quite different methods must be employed in order to render them incandescent.

Furthermore, the second part of this principle states that the lines in the spectrum are the same under the same conditions of temperature and pressure, implying that when the conditions are changed, the appearance of the spectrum changes also.

In view of these facts, it becomes necessary to make the investigation very exhaustive and to vary the conditions of temperature and pressure in every possible way. Researches of this kind have been carried on during many years and the wave-lengths of lines in the emission spectra of the elements are extensively but not completely known, since not all of the



possible variations of temperature and pressure have been applied to them. Neither have all of the effects which we see in stellar spectra been obtained, because we are unable to reproduce even approximately the conditions which exist in the stars with their enormous masses and small densities. The results which have been obtained are so varied and in some cases, so unexpected, that it is not yet possible to state general relations in a definite form. At the same time certain facts are well substantiated and those which bear directly on our subject should be noted.

The several methods of rendering a solid substance luminous may be divided into the following classes, the order representing the relative temperature: the Bunsen flame, the oxy-hydrogen blowpipe flame, the electric furnace, the electric arc, and the electric spark of different intensities. For the gases, still another method is used: they are confined in vacuum tubes, and made luminous by the passage of a spark under low pressure.

The spectra produced by these means are in general of two kinds, banded and lined. The former usually consists of a number of bands, each having one bright edge and gradually diminishing almost to darkness in the direction of the other edge. Under high dispersion each band is resolved into numerous slender lines, very closely packed together, among them being at certain rhythmic intervals, brighter lines, giving the effect of a fluted column brightly illuminated so that the grooves are in shadow. From this appearance is derived the name "channeled" or "fluted" which is often applied to a spectrum. Band spectra are produced by compounds, such as titanium oxide, and also by elements at temperatures below that necessary for the production of lines. Perhaps the most beautiful banded spectrum is that due to carbon, which is produced when the simple arc light is examined with a spectroscope. As this also appears whenever the arc is used in producing the spectrum of any other substance, a knowledge of it is of extreme importance, and hence it has been very extensively

studied. There are several bands in different parts of this spectrum, each one of which consists of several edges, while the background is filled in with multitudes of very fine lines

The line spectrum consists of isolated lines. The variations in it come from differences in temperature and also from the manner in which it is produced. The effect of a change in temperature in passing from the flame spectrum of an element to that of the arc, is to increase the number of lines; but the effect of a spark discharge, especially when of great intensity, is to change the relative intensity of the lines in the spectrum. This important fact was discovered by Lockyer, and may be described as follows. Certain lines in the spectrum of an element as produced by the electric arc are shorter than the others, that is, they do not extend over the entire length of the slit. In passing from the arc to the spark, these lines become greatly strengthened, and as the tension of the spark is increased, these lines become the strongest in the spectrum and the fainter lines tend to disappear, leaving as a result a simpler spectrum, consisting only of the brightest lines. These lines are called by Lockyer "enhanced" lines, and are thought by him to be due to a very high temperature. Hence, whenever they are found in a stellar spectrum, they indicate that it is produced by a star of very high temperature. Other investigators question whether the presence of these lines is due to an enormously hot temperature, and suggest that it may arise from the conditions of stress existing in the spark itself.

The pressure existing in the gas under investigation has an important effect on its spectrum. An increase of pressure will widen the lines, so that with a sufficient amount they will become so wide as to coalesce and form a continuous spectrum. In the spectrum produced by the arc, the lines often appear arrow-shaped, showing that in the lower part of the carbon cup the density of the gas is greater than it is farther up. It has also been found that a very high pressure will shift the lines slightly toward the red end of the spectrum.

The presence of a strong magnetic field about the incandes-

cent substance will cause the lines to be widened and split into component parts, the number and intensity of which depend upon the element, the particular line, and the strength of the current. This is known as the Zeeman effect.

Another change in the appearance of spectral lines is known as reversal. This means the change of a line from dark to bright, or *vice versa*. It occurs when a gas of different temperature from that producing the line is temporarily thrown in front of it. More often a portion of a line will be reversed instead of the entire line. It is observed frequently in the spectrum of the sun, particularly with certain lines. These are ordinarily dark, but under certain circumstances, a bright reversal will appear, indicating that there is a sudden outburst of hotter gas projected in front of the cooler gas which produced the dark line.

A few words may be said about the different methods of producing the spectrum. When the Bunsen flame is used, a salt of the element to be studied is placed in the gas flame. Sometimes the solid substance is used on a platinum wire, and sometimes a solution is fed into the flame a little at a time. With the oxy-hydrogen blowpipe the apparatus is arranged so that the flame plays upon the metallic salt, and later passes out of an opening where it can be examined. With the electric arc, three methods can be used. For the lower carbon, one with a soft core is taken, the core is dug out and some of the metallic salt packed in its place. The substance may also be fed into the arc in small quantities. This, however, is likely to cause sudden changes and disturb the conditions. Sometimes metallic electrodes are used, if the metal is not too easily fusible. This method is especially applicable to iron. With the spark, metallic terminals may be used, or the spark may be made to pass from a platinum terminal to a solution of the salt. The work with the electric furnace, which has been developed comparatively recently, does not give quite so high a temperature as the arc, but it presents several advantages.<sup>1</sup>

<sup>1</sup> A. S. King, *Ap. J.*, 28, 300.

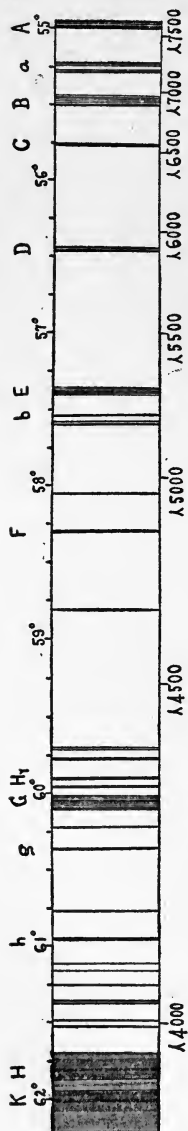

FIG. 14. THE SOLAR SPECTRUM

A long steady column of vapor can be obtained, the temperature can be regulated without altering other conditions, the spectrum gives almost as many lines as the arc, the control of the conditions is greater, so that changes in pressure can be observed, and the effects of absorption may be investigated by using a source of white light behind the vapor in the furnace. The laboratory of the Mt. Wilson Solar Observatory is provided with an elaborate equipment for studying the spectra as produced by the electric furnace, and its connection with the Observatory makes its work bear directly upon the problems presented by solar and stellar spectroscopy.

Another important problem connected with the study of stellar spectra has to do with the shifting of the lines due to motion in the line of sight. This is explained by Doppler's principle, which will be treated fully in the chapter on spectroscopic binaries.

#### CLASSIFICATION OF STELLAR SPECTRA

The next step will be to classify the spectra of the stars, since it has been found that certain types of spectra are characteristic of certain types of variable stars. Preliminary to this, it will be of much assistance to give first a description of the spectrum of the sun, since the lines and groups which are most prominent in it are conspicuous also in the stars. Following the description is a table giving the wavelengths of the single lines, and of the

strongest line in each group. The relative intensities and the sources of the lines are also included.

A, a group of heavy lines in the extreme red.

a, a group of fainter lines following A.

B, a third group of lines in the red.

C, a single line in the red toward the orange.

D<sub>1</sub>, D<sub>2</sub>, a pair of lines close together in the yellow.

E, a group of fine lines in the light green.

b<sub>1</sub>, b<sub>2</sub>, b<sub>3</sub>, a group of three sharp lines farther on in the green.

F, a single line in the bluish green.

H<sub>γ</sub>, a single line in the blue, closely preceding the following group.

G, a strongly marked group of lines in the blue.

g, a single strong line in the violet.

h, a single line also in the violet.

H, K, two very heavy lines in the extreme violet.

These dark lines are known as the Fraunhofer lines, for it was he who first studied them and gave them their names.

<i>Line</i>	<i>Wave-Length</i>	<i>Intensity</i>	<i>Source</i>
A	7594	Group	Atmospheric
a	7164	Group	"
B	6870	14	Atmospheric oxygen
C	6563	40	Hydrogen H <sub>α</sub>
D <sub>1</sub>	5896, D <sub>2</sub> 5890	20, 30	Sodium
E	5270	8	Iron
b <sub>1</sub>	5184, b <sub>2</sub> 5173, b <sub>3</sub> 5167	30, 20, 20	Magnesium
F	4861	30	Hydrogen H <sub>β</sub>
H <sub>γ</sub>	4341	20	Hydrogen H <sub>γ</sub>
G	4308	10	Iron
g	4227	20	Calcium
h	4102	40	Hydrogen H <sub>δ</sub>
H	3969	700	Calcium
K	3934	1000	Calcium

The earliest classification of stellar spectra is due to Father Secchi, an Italian astronomer stationed at the Collegio Romano. It was published in 1849, but he was not the first to perceive that differences existed, for Fraunhofer, in 1823, had already recognized the fact. Secchi's classification, which was made with a small telescope, rests on a study of the visual part of the spectrum, and includes only stars with absorption spectra, *i.e.*, those showing dark lines. It may be briefly described as follows:—

Type I. This is characterized by the presence of four very intense lines identified as belonging to hydrogen. The continuous spectrum is rich in blue and violet light and the stars are therefore white in color. Sirius is the most brilliant example of the type, for which reason it is frequently called the Sirian type. Vega and Regulus also belong to this type.

Type II. This has a spectrum resembling that of the sun, consisting of many fine lines, with the predominating H and K. It is called the solar type, examples among the bright stars being Capella, Pollux, and Arcturus. Since the lines are quite thickly massed in the blue end of the spectrum, the resulting color of the stars is yellowish.

Type III. This type is marked by the presence of bands which are sharply defined on the side toward the violet and shade away toward the red. There is strong general absorption in the violet end, hence the stars in this class are pronouncedly reddish in color. Betelgeuse is the typical star.

Type IV. These stars are also characterized by bands, which however shade toward the blue instead of the red. They are also very red, but are quite faint, the brightest being not more than fifth magnitude. A typical star is 152 Schjellerup.

At a later time Pickering suggested the addition of a fifth type which should include stars having bright lines in their spectra. This is known as Pickering's Type V.

While this classification was generally satisfactory and is still used for quick reference, it depended entirely upon visual observations made with an instrument of small dispersing

power. When the photographic process was employed for recording stellar spectra, the resulting plates showed that in general Secchi's classification held, but that it was susceptible of many fine gradations which could be arranged in such a way as to show an orderly development from one type to another. The principal fact upon which the new classification was based was that certain groups of lines seemed to appear together and to act in common, that is, to grow more intense together or to grow faint at the same time. This does not mean that the lines in a given group all have the same intensity, but that all change in the same fashion. The classification, which has received the general approval of astronomers, was developed at the Harvard Observatory and is based upon the study of a great number of spectrograms. A detailed account of it is given in volume 28 of the *Annals*, and was prepared for publication by Miss Annie J. Cannon, who has had a larger experience in dealing with stellar spectra than any other astronomer. Starting with the spectra of nebulae, which contain bright lines and are supposed to be at the earliest stage of development, and continuing with the bright line stars, the groups, which are denoted by letters, succeed each other in order through the white stars to the yellow and red. It happened that beginning with Secchi's first type, the separate groups were lettered before they were put in the order of their evolution, and the bright line stars were studied last, hence the letters when arranged to show the order of evolution do not follow the alphabetical order. However, this does not cause any particular inconvenience.

Before giving the letters, it is desirable to state on what basis the new grouping was made. Miss Cannon selected several groups of lines which act together as described above and which vary in intensity in passing from one type to another. They are briefly as follows: (1) the hydrogen series, which includes not only the four lines in the visible spectrum but an extension of them into the ultra violet; (2) a secondary hydrogen series, known as the Pickering series, found in the

spectra of certain stars, and not known terrestrially; (3) the Orion lines, which include helium, a few lines each of nitrogen, oxygen, silicon, etc., with some additional strong lines due to unknown substances; (4) the calcium lines H and K, which are so intense in the solar spectrum; (5) solar lines, including lines from many metals; (6) group G; (7) a group of bright bands of unknown origin.

The classification depends entirely upon the presence and varying intensities of these groups of lines and upon the general absorption in the spectrum. It is briefly described below, the classes being arranged in the apparent order of development. There are subdivisions intermediate between the separate letters which are indicated by letters or numbers on the scale of ten. The main divisions in order of evolution are O, B, A, F, G, K, M. The correspondence with Secchi's types is as follows: O, Pickering's fifth type; A, B, Secchi I; F, I-II; G, II; K, II-III; M, III. Secchi's IV is N, but there is no connection between it and type M, hence it does not belong to the series. The detailed description of each class will now be given.

Oa-Oc are bright-line stars. They contain one or both of the bands (7) just mentioned and a few bright lines, principally of the two hydrogen series. Od has the bright bands, and dark lines of both hydrogen series of strong intensity. Oe is similar to this with more dark lines. Following this O group is a subdivision which is plainly intermediate between the O and B groups, as in it the bright bands have disappeared, leaving only dark lines, of which the hydrogen and helium lines have about the same intensity as in class B. This is called Oe5B.

Class B has ten subdivisions designated as B, B1A, B2A, etc., which are often abbreviated as B0, B1, B2, etc. They are marked by the diminishing intensity and early disappearance of the secondary hydrogen spectrum, by the increasing strength of the usual hydrogen series, by the diminution of the helium and other Orion lines, and toward the end of the group





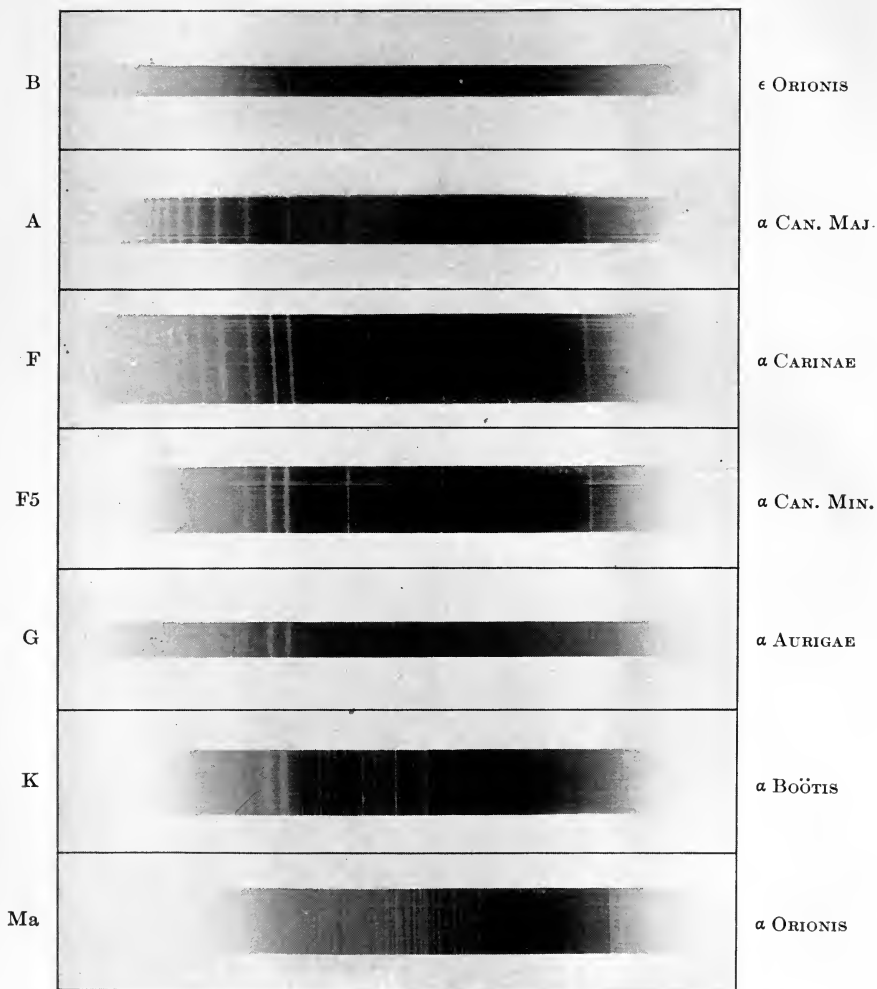

Plate II  
TYPICAL STELLAR SPECTRA

by the entrance of faint solar lines, so that in B8 and B9 solar and Orion lines are intermingled.

Class A has fewer subdivisions than Class B; these are A2F, A3, and A5. The typical star of division A is Sirius, which is marked by very intense hydrogen lines. These extend in some stars as far as H $\sigma$ . The helium lines are entirely gone; the solar lines are present and increase in intensity toward Class F. The calcium line K, which is faint, increases also in intensity, until it surpasses H $\delta$ . The calcium line H is so nearly coincident with H $\epsilon$  that the line observed is a combination of the two. The hydrogen lines decrease in intensity as the class advances.

Class F represents spectra in which the bands of H and K, calcium, are the most conspicuous features, and the hydrogen lines are more intense than any solar lines. The gradations between this class and the next are F2G, F5 and F8. Certain lines in band G appear and increase in intensity, but the band is not well marked.

Class G contains stars with spectra in which the lines H and K of calcium and the band G are the most prominent features, while the hydrogen lines are still as intense as any single solar lines.

Class K represents spectra of the advanced solar type, in which the bands H and K, G and the calcium line 4227 or g are the most conspicuous features, the end of short wave-length is faint, and the distribution of light in the spectrum is not uniform. The hydrogen lines are fainter. Intermediate between G and K is G5K, and between K and M are K2 and K5.

Class M includes the banded type. Its two divisions are Ma and Mb. A third subdivision, Md, includes stars of this type which occasionally have bright hydrogen lines.

In tracing the development of the classes from one to the next, the progressive changes may be described as follows: There first appear broad hazy bright bands (7) which finally disappear. Simultaneous with them are bright hydrogen lines of both series which become narrower and finally give place

to dark hydrogen lines of both series. The principal series increases in intensity, reaching its maximum in type A, after which it diminishes, becoming less and less conspicuous until in class M the lines are fainter than many of the solar lines. The second series of hydrogen lines reaches its maximum intensity in Od and then quickly disappears. As the bright bands (7) disappear, the Orion lines appear, increase in intensity, reaching a maximum in B2 and B3, then diminish and in A are hardly visible. The calcium line K appears in Class A, and increases in intensity until together with H it dominates the spectrum. The other solar lines which appear faintly in type A become more and more strengthened, particularly band G and the calcium line 4227. Finally the spectrum becomes banded.

#### CONNECTION BETWEEN SPECTRAL TYPE AND TYPE OF VARIATION

CLASS I. *Temporary stars* have always the same type of spectrum, which consists of bright and dark bands of hydrogen and helium side by side. In addition are usually seen the D lines of sodium and the H and K lines of calcium. The most striking characteristic of the spectrum is the great displacement of the bands, the dark ones being shifted toward the violet end of the spectrum and the bright bands toward the red. Fine lines may also be detected with very bright novae, and many changes take place in the spectra. However, this subject has been treated so fully elsewhere that we need not repeat the facts here. It is sufficient for the present purpose to state that the spectrum of dark and bright bands, with the displacement described above, always is indicative of a new star, and that whenever such a spectrum has been found on a photographic plate, and the photometric history of the star has been investigated, it has been proved to be a new star.

It should be added, that in two cases a new star has been caught early enough in its history to show a different type of spectrum, for a brief time only, as the typical aspect has devel-

oped very quickly. These stars are Nova Persei, 1901, and Nova Geminorum, No. 2.

CLASS II. *Long period variables.* The spectrum is with striking uniformity that of Secchi's type III or Harvard M, but showing bright hydrogen lines at maximum, whenever it has been photographed at that time. This fact is made use of in the discovery of long period variables, just as the banded spectrum of bright and dark bands is made a test for temporary stars, and when a third type spectrum is found with bright hydrogen lines, the star is marked as a suspected variable and subjected to further investigation. The spectrum is also made use of in separating variables of Class II from those of Class IV, for as stated earlier, the dividing line is not based entirely on length of period. So far, the variable in Class IV having the longest period is SS Geminorum with a period of 45 days, and the variable of Class II having the shortest period is SZ Cassiopeiae with a period of 50 days. If a variable were to be found with a period of 40 days and a spectrum of type III it would be placed in Class II, not in Class IV. A few variables of Class II have continuous spectra or the spectrum of Class N.

CLASS III. *Irregular variables.* With few exceptions these have spectra of Class M or N and hence are supposed to be in a very late stage of evolution. Their irregularity is thought to be due to the fact that the forces which cause the variation are dying out. Hence no star would be placed in this class, which has a spectrum of a much earlier type, but if it appeared to be irregular, it would rather be classed as unknown. One well-known illustration is  $\upsilon$  Herculis, which was mentioned in the section on the classification of variables. This star had for several years been known to vary with a small range, and was called irregular, but later it was found to be of the  $\beta$  Lyrae type, having a period of 2.05 days.

CLASS IV. *Short period variables.* The Cepheid stars of this type have spectra mainly of Class G or F. Stars belonging to the  $\beta$  Lyrae subdivision have spectra of an earlier type,

B or A predominating.  $\beta$  Lyrae itself is one of the most interesting and baffling stars in the sky. Its spectrum is of the B type, but it has bright and dark lines of the same elements, particularly hydrogen and helium.

CLASS V. *Algol type*. The stars in this group also have an early spectral type, A and F predominating.

The data upon which the last section has been founded have been taken largely from the tables in H.C.O., *Annals*, vols. 55 and 56, though some material has been found in the current periodicals.

It has been the purpose in this chapter to give a general survey of the facts necessary for a reasonable understanding of the many technical references that must be made in the succeeding chapters. Many points have been touched upon which will be treated fully at a later time, but a preliminary knowledge of the meaning of stellar variation, of the different classes of curves, of the types of stellar spectra and their relation to the different classes of variables was considered essential by the writer.

[NOTE. — Among the seven sets of lines which Miss Cannon describes in giving the basis of the Harvard classification of stellar spectra, there are two which merit special attention on account of some recent investigations concerning them. These are (2), the Pickering series of hydrogen found in  $\zeta$  Puppis, and (7), the bright bands of unknown origin. Both had been ascribed to hydrogen, but it was thought that they were produced by that element under conditions which could not be duplicated terrestrially. Quite recently, Fowler,<sup>1</sup> at the Solar Physics Laboratory at South Kensington has obtained the bright bands (7) and a few lines of the series (2) by passing a strong condensed discharge through a mixture of hydrogen and helium in a vacuum tube. It is not possible to give here anything further in regard to the experiments except to quote his final words, which are extremely interesting and satisfying to the astronomer. "The production of the new lines gives a further indication of the probability that there are no special kinds of matter in celestial bodies, and that most, if not all, of the celestial spectra are well within range of laboratory experiments."

---

<sup>1</sup> *Mon. Not. R.A.S.*, 73, 62.

Whether the lines belong to hydrogen or helium is still a moot question. Theoretical considerations connected with series of lines in spectra seem to point to helium as being their source. In fact, one of the lines was found in a tube which contained helium<sup>1</sup> but not hydrogen. The matter cannot yet be considered as settled experimentally.]

---

<sup>1</sup> Evans, *Nature*, Sept. 4, 1913, p. 5.

## CHAPTER II

### STAR CHARTS FOR GENERAL USE

STAR charts intended for general use by astronomers may be divided into two classes, those which are suited for identifying the lucid stars and those which are prepared for telescopic work. In the first class may be found the well-known atlases of Heis, Schurig, Klein, and Upton, and in the second the great *Durchmusterung* of Argelander (which deserves to stand in a class by itself), and printed charts covering special regions of the sky such as the Paris *Ecliptic Charts*.

The first modern set of maps prepared for convenient comparison with the sky were from the hand of Argelander, who published in 1843 his atlas which he called the *Uranometria Nova*.<sup>1</sup> As the name implies, its chief purpose was to give the correct magnitudes of the stars, but this was not its only one, as the introductory sentences state: "All of the star charts which we possess up to the present time, are lacking in two important respects;—the magnitudes of the stars depend upon estimations which have been made at the telescope by astronomers while in the process of determining their positions, and are for the most part quite erroneous. There are also lacking quite a number of the brighter stars while many of the fainter ones are included. Both together often change the constellations so completely that one can scarcely follow the charts, particularly in regions which are poor in the brighter stars. It is the purpose of the present charts to supply this want as far as possible, for those in middle Europe who wish to observe stars visible to the naked eye."

These famous charts, which are now out of print and have

<sup>1</sup> Fr. Argelander. *Neue Uranometrie*. Darstellung der in mittleren Europa mit blossen Augen sichtbaren Sterne nach ihren wahren, unmittelbar vom Himmel entnommenen Grössen. Berlin, 1843.



been superseded by other more modern ones, are worth knowing about, because they were the basis of so much later work. In appearance they resemble the maps of Heis, and are accompanied by a book containing an account of the method of forming the charts and a catalogue of the stars found on them. Argelander's method of determining the star magnitudes, which is the most important part of the work, will be described in Chapter V.

The atlas of Heis,<sup>1</sup> which was modeled after the *Nova Uranometria* of Argelander, consists of thirteen plates representing the sky as far south as  $-30^\circ$  declination, and including stars as faint as 6+ magnitude. The Milky Way is very carefully represented on this atlas in five degrees of density. It also contains the figures of the constellations faintly outlined in red, artistically drawn, being copied from the Farnese globe in the Naples Museum, a cut of which appears on the title-page. The magnitudes of the stars are represented by different symbols, as is customary. Accompanying the atlas is a catalogue with a Latin introduction in which the author pays a tribute to the *vir illustrissimus Argelander*, with whom he had been associated in the study of variable stars. The magnitudes were deduced from Heis's own observations, which extended over a period of twenty-seven years. As he had remarkably clear eyesight he was able to include many stars not ordinarily seen, so that on his maps there are 5421 stars, being 2153 more than Argelander represented in his *Uranometria*. The atlas was published in 1872. Unfortunately, it is of a shape which renders it a little unhandy for common use, and its expense reduces the demand for it. Furthermore, the right ascensions and declinations are for the year 1855, the former being expressed in degrees instead of hours, which makes it inconvenient for ready use at the present time.

Schurig's atlas, which is intended for the same purpose, is arranged much more conveniently, is less than a quarter the price, and a second edition published in 1909 contains many

<sup>1</sup> Eduard Heis, *Atlas Coelestis Novus*. Coeln, 1872.

desirable improvements. The principal facts stated in the preface may be summarized as follows. The positions of the stars are for the equinox 1925.0. Their magnitudes are taken from the *Potsdam Photometric Durchmusterung* and in the southern zones from the *Harvard Photometry*. Many nebulae and star clusters are included, also variable stars and doubles. There are symbols for the magnitudes and thirds from 1 to  $6\frac{1}{3}$ , or 17 in all. The Milky Way is represented in several degrees of brightness. The stars are printed in black, their names and the boundary lines of the constellations in red, so that the maps are well adapted for use at night with artificial light. There are eight maps in all, which cover the entire heavens.

While the magnitudes on such maps are not to be considered in any sense as definitive, it is an added convenience to have them assigned with care so that they can be used by a beginner in testing his power to distinguish different degrees of brightness. Their principal use is for the observer with a portable telescope which has no circles for setting. He must be able to connect a prominent star in the sky, through some definite configuration which can be picked out on Schurig's atlas, with the group in the field of his telescope containing the variable. Further discussion of this point will be given in the chapter entitled "Hints for Observers."

Upton's *Star Atlas* is intended to serve the same purpose as the others. It has the advantage of being published in America and hence is more easily obtainable than Heis or Schurig. Only whole magnitudes are represented. There are six maps covering the entire heavens.

The *Bonner Durchmusterung* is the chief member of the second division of maps, and contains 324,000 stars including those as faint as the ninth or tenth magnitude. It is in two distinct parts; — the northern *Durchmusterung*, prepared by Argelander, which extends from the north pole to declination  $-2^\circ$ , and the continuation of it, which was completed by Schönfeld, and extends from  $-2^\circ$  to  $-23^\circ$  declination. Since

the *Bonner Durchmusterung* is one of the most valuable pieces of astronomical work ever executed, it has seemed worth while to the author to give a somewhat detailed account of its conception and formation. It consists of both star catalogues and charts, and is of such great value that when the supply became exhausted many years ago the question of issuing a second edition was seriously agitated. This was finally accomplished and new charts were published in 1899, being dedicated to Argelander on the hundredth anniversary of his birth, which occurred on March 22, 1799. The reprint of the catalogue was published in 1903. The description of the formation of the catalogue and charts is taken from Argelander's introduction to the first edition, the dates of which are 1859 and 1863.

The idea of making an extensive chart of the heavens was first suggested by Bessel in an article in the *Astronomische Nachrichten*<sup>1</sup> for 1822, wherein he calls attention to the *Histoire Celeste* of Lalande, a catalogue containing 50,000 stars down to the eighth magnitude, for the epoch 1800. He adds that this should be extended so that there may be a complete catalogue, with charts, of all stars within certain limits down to the ninth magnitude, the principal purpose being to assist in the discovery of new minor planets. He did not think it necessary that all of the star places should be determined by meridian observations, but suggested that as many as possible be located in this way and that the others be inserted by eye estimates on the charts. Bessel entered upon the execution of this scheme with the assistance of Argelander, then only twenty-two years old, not with the expectation of completing the survey, but for the purpose of trying the plan and seeing how easily it could be carried out. As a result of his experience he came to the conclusion that he would be unable to complete it himself, and asked the co-operation of other astronomers.

In 1825 he again wrote to the *Nachrichten*,<sup>2</sup> this time making quite definite propositions and begging other astronomers to

<sup>1</sup> *A.N.*, 17.

<sup>2</sup> *A.N.*, 88.

join him in the work. His plea was the more urgent since his accomplished assistant, Argelander, had left Königsberg to become the director of the observatory at Åbo, and he himself was engaged in other work. A copy of his preliminary chart accompanied his article.

It was this plan of Bessel's, so Argelander states in the introduction to his charts, that induced him to undertake the *Durchmusterung*. The making of the catalogue necessarily came first. He desired at the outset to have the charts extend as far south as the tropic of Capricorn or  $25^{\circ}$  south declination, but the atmospheric conditions at Bonn did not permit of this. He then limited himself to the northern heavens, but included the zone of  $-0^{\circ}$  to  $-2^{\circ}$  in order to connect with similar maps, which would be made, so he hoped, by observers in the southern hemisphere. He intended the positions to be so accurate that the error would not exceed one minute in either co-ordinate, and that thus each star on the chart would easily be found again with a meridian instrument. All large errors in previous star catalogues should be carefully looked for and eliminated. He preferred not to follow the method previously suggested of plotting the positions of stars from the catalogues already known and inserting other stars by eye estimates. He gives several reasons for this, the chief one being that the method of observation was too exacting on the eye of the observer, owing to the constant changing of the illumination in looking from the lighted chart to the dark field of the telescope. Furthermore, the resulting positions of the stars would not be accurate enough. He determined, then, to obtain the positions of all the stars with a degree of accuracy which should be equal and suited to the purpose before him. After some experimentation he adopted the following method of observation.

A Fraunhofer comet seeker of 34 lines or 3 inches aperture and two feet focal length, furnished with an eyepiece magnifying ten diameters, was installed in the south tower of the observatory. A special eyepiece was constructed for it, in the

focus of which was placed a semi-circular piece of thin glass oriented in such a way that the straight edge or diameter formed an hour circle. In the telescope it appeared as a thin dark line which in the complete absence of artificial light could be seen by the faint illumination due to starlight alone. Perpendicular to it was drawn a radius at the middle point, and parallel to this on either side at intervals of 7' were drawn ten shorter marks, every third one being a little longer, to allow of easy discernment. These were not readily seen in the dark field, and were made visible by being drawn with thick black oil paint, which made them rather broad and hence likely to cause some error, but one which was considered to be less than the error of observation.

The observer, who was called "A," assumed as comfortable an attitude as possible in placing his eye at the telescope, no change in his position being required, as the stars were always observed in narrow zones. There was no artificial light in the room, and the eye was protected against the light from the sky by means of a dark cardboard screen which surrounded the eye end. Under the observing room was another room in which was a sidereal clock before which the assistant "B" was seated. Only a simple board floor separated the two rooms, so that a sound could easily be heard from one to the other. When the work was ready to begin, the telescope was set for the proper declination and right ascension; the observer seated himself, and the assistant withdrew from the room carrying the artificial light with him. On a table close to the observer was placed a pile of papers, each fitted with a rack dividing it into five vertical columns, so that the observer "A" could pick it up in the dark, and write in the columns, running his hand down the forms without taking his eye from the telescope or seeing the paper. Another compartment of the table was reserved to place them in when finished.

In making the observation "A" called out to "B" the magnitude of the star and the instant that it crossed the hour circle. He himself wrote down the declination north or south

of the mid-line of the field, and made any other necessary notes. When a paper was finished, he gave notice of the fact to "B," who drew a line across his own record, and the same was done when anything happened to disturb the observer and make him pause. This kind of observation proved to be so exacting that the observers could work at it for about an hour, or at most an hour and a quarter, when it became necessary to change. When "A" gave the signal for stopping, "B" pulled a bell which rang in another room where two other observers were waiting to take their places. While waiting for them to arrive, "A" read the circles. The first pair then retired to the other work room, went over their two records together, to see that everything was in agreement, and to clear up misunderstandings if possible, while their memories were still fresh from the work.

This brief description of the method pursued by Argelander and his assistants shows how it was possible for him to achieve such an enormous piece of work in so short a time. The first section of the catalogue, containing 110,985 stars between the limits  $-2^{\circ}$  and  $+20^{\circ}$  declination, was published in 1859; the second, containing 105,075 stars, between  $20^{\circ}$  and  $40^{\circ}$ , in 1861; the third, containing 108,129 stars, between  $40^{\circ}$  and  $90^{\circ}$ , in 1862. The epoch is 1855. The charts were finished in 1863. It is of course impossible that in such a piece of work there should be no errors. Argelander himself refers to the probability of their existence, but states that as the papers were arranged in the most complete order, and carefully preserved in the library of the observatory, he hopes that they will be freely used for reference in all doubtful cases.

The astronomer of to-day is fully aware how this wish has been fulfilled, and one frequently sees in the *Astronomische Nachrichten* letters from Professor Küstner, the present director of the observatory at Bonn, written in response to inquiries made by observers whose results may differ from those contained in the *Durchmusterung*, in which he quotes the original records. An example may be found in the *Astronomische*

*Nachrichten* 4383, regarding the magnitudes of a star, and another in the *Astronomische Nachrichten* 4386, in which there was some ambiguity about the positions of two adjacent stars.

Mention should be made of the limiting magnitude set by Argelander in his work. It was his intention to include all the stars down to the ninth magnitude in the region charted, all the brighter stars of the class 9.10, and as many more of this class as the circumstances would permit. That is to say, in a region where the stars were sparsely scattered, more of the fainter ones would be observed, but in richer regions, such as the Milky Way, perhaps not all even of the brighter ones of this magnitude would be included. As a result, the *Durchmusterung* magnitudes below the ninth are not reliable.

The arrangement of the stars in the catalogue may now be explained, and at this juncture the author wishes to state that the *Durchmusterung* is thus fully described not only on account of its universal interest, but because observers of variable stars need to make frequent use of it in preparing their star maps, and hence will find directions for its use very convenient. The description should be used in connection with the catalogue.

The catalogue is divided into zones one degree wide. Each page has five similar columns in which the stars are separated into groups of ten. The current numbers comprised in any one column are printed at the top of it, and hence need not be given for the individual stars, but may readily be found by counting down from the top of the column. The division into groups is to facilitate the identification of a star.

For example, on the first page of the catalogue is given the declination of the zone,  $-1^{\circ}$ , and at the heads of the columns stand the numbers 1-40, 41-80, 81-120, 121-160, 161-200. Number 136 in this zone will be found in the fourth column, in the second group, and will be the sixth star in the group. Stars in this catalogue are usually designated by the declination of the zone followed by the number in the zone, the number being preceded by the letters *BD*; for example, the star just mentioned is *BD*  $-1^{\circ}$  136. The one referred to in *Astronomische Nach-*

*richten* 4383 is *BD* +34° 4598. Under the current numbers stands the hour of right ascension. Each of the five columns of stars on a page has itself four columns of numbers. The first gives the magnitude, the second the minutes and seconds of right ascension, which, contrary to the modern custom, are indicated by the strokes ' and '' instead of the letters m and s. The right ascension is given to tenths and not hundredths of a second. The next column gives the minutes and tenths of declination, the degrees standing at the head of the column. The fourth column gives the references to other star catalogues, each one being represented by its particular abbreviation. At the head of each page in bold type are the degree of the zone and the hour of right ascension. For example the data concerning star *BD* -1° 136 are 9.3 mg., 0h 56m 9.2s, -1° 10'.9. No letter of reference is given, hence the star cannot be found in any other catalogue.

Since the charts also are in very general use, a description of them will probably be of service to the beginner. They are printed on sheets 30 x 21 inches and are in four zones with one circular map for the polar region, numbering forty sheets in all. The first tier covers the region from -2° to +20°, or an extent of 22° in declination; the second 19° to 41°, the third 40° to 61°, the fourth 60° to 80° and the last one 79° to 90°. Each chart is covered with a network of lines which are one degree apart in declination and four minutes of time in right ascension on the first three tiers of charts, and eight minutes on the fourth. On the first tier, the network is square, the side of each square being 20 mm. On the other tiers the hour circles are closer together and converge according to the cosine of the declination. In right ascension they overlap one tier, or four minutes.

A particular use of the charts is for locating a star and giving the configuration of the surrounding region. In order to locate a star we must first find the square in which it occurs. The sides of the square being four minutes apart in right ascension, the star will be included between two hour circles which are multiples of four minutes. After the square has been found, the



star may be located by proportioning for the difference in right ascension and declination, or more easily by counting directly from the preceding side of the square, as will be seen from the following example.

The star  $BD -1^{\circ} 277$ , 8.3 mg.,  $1^{\text{h}} 26^{\text{m}} 10.3\text{s}$ ,  $+1^{\circ} 50'.3$  lies in the square between  $1^{\circ}$  and  $2^{\circ}$  declination and in right ascension  $1^{\text{h}}$ , between  $24^{\text{m}}$  and  $28^{\text{m}}$ . On referring to the catalogue, we find that the first star in this square has declination  $50'.6$ . Follow the stars in the square in order with a pointer in the right hand and the stars in the catalogue with another pointer in the left hand. The second

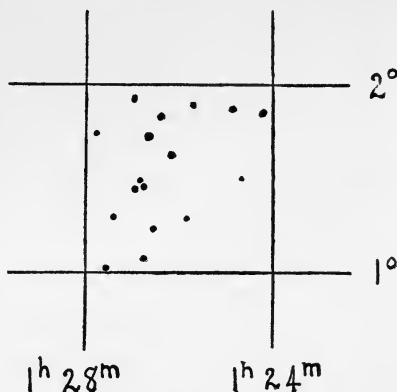

Figure 15

SQUARE FROM DURCHMUSTERUNG  
CHART

star in the square has declination  $20'.2$ , the third  $51'.6$ , the fourth  $52'.8$ , the fifth  $17'.4$ , the sixth  $17'.6$ , and the seventh, which is the one desired,  $50'.3$ .

The size of the dot shows that it has the given magnitude 8.3. After many years of experience in using these charts for many different purposes, the writer has found this to be the quickest way to locate a star and the one least liable to error. If it should happen that only the position of the star is given and the catalogue is not at hand, it would be necessary to use the first method and to locate the star by proportioning.

On the charts the variables which were known at the time of Argelander are marked with the abbreviation *var.* The size of the dot represents the average magnitude at maximum. Double stars are indicated by a line drawn under the star.

The work was begun in 1852, continuing seven years and one month, and during this time 1841 zones were observed on 625

nights, 12 of them by Argelander himself, and the remainder by his assistants. The total number of observations is 1,650,000, which belong to 324,198 stars. On the average each position depends upon  $2\frac{2}{3}$  observations. Argelander pays a remarkable tribute to his collaborators in the work, Schönfeld and Krueger, referring to them as follows: —

These gentlemen have diligently shared the work with me for many years. With the exception of the first period, I have given over to their younger and stronger eyes alone the zone observations and in all the remaining labors I have enjoyed their earnest support. They have won for themselves so much real advantage from the success of the work that I can consider it as one carried out by them and myself in common, and it gives me the greatest pleasure to express my warmest thanks for the judgment, zeal and perseverance with which they have devoted to this work their splendid talents.

As stated before, the second edition of the charts was published as a memorial to Argelander on the one hundredth anniversary of his birth, the work being undertaken at the Bonn Observatory. In the introduction which was prepared by Küstner, the Director of the Observatory, he wrote that unfortunately the stones on which the originals were lithographed had not been preserved, but that it was doubtful, even if they had been kept, whether they could have been used after so long a lapse of time. He found on investigation that modern methods of reproduction would give satisfactory results and the photo-lithographic process was employed at the Imperial Printing Bureau in Berlin. Corrections of all the errors known at the time were made, many of which were contributed by different astronomers who had used the charts and had discovered mistakes, and the entire series was most carefully revised.

The second edition of the catalogue was printed in 1903 under the direction of Professor Küstner. As was the case with the charts, the original was excellently reproduced by a photographic process.

In preparing for the new edition it was possible to make

many necessary corrections. Changes and addenda were drawn in with the lithographic pen but in somewhat larger and more slanting type, in order to be recognized easily. Where star places or letters were to be deleted, this was indicated by having a horizontal stroke drawn through them but in such a way that the original figures could plainly be read. New variable stars were indicated by the syllable *var*, additional stars were added by being placed at the bottom of the columns, an asterisk in column one indicating where each should be inserted in the catalogue. At the bottom of each column is given ten years precession in right ascension and declination, which are to be used in carrying the position from the date of the catalogue to any desired epoch.

The continuation of the *Durchmusterung* to declination  $-23^{\circ}$  was carried out by Schönfeld, who was Argelander's successor at the Observatory at Bonn. The catalogue was published in 1886 and the charts in 1887. They are dedicated to the memory of Argelander, whose original design it was to complete the work himself, a task which he was not able to carry out on account of the low altitude of the stars and the small aperture of the telescope. He did, however, observe 44 zones south of  $-2^{\circ}$ . Schönfeld, also finding that the telescope of Argelander was too small to show the faint stars well, used a six-inch telescope with a higher magnifying power. The field was thus darker and hence he was obliged to use artificial illumination to see the lines in the eyepiece. He extended the catalogue to include stars of magnitude 10.0. In form it is similar to that of Argelander, though the charts are somewhat different in shape since they cover a wider difference in declination. They are also for the epoch 1855.

The description of Argelander's magnitude scale with reference to modern photometric standards will be given later.

The southern survey of the heavens has been extended to declination  $-42^{\circ}$  under the direction of Professor Perrine at the Cordoba Observatory of the Argentine Republic. The charts have been prepared on the same scale as the northern

*DM.* and cover the degrees in declination from  $-22^{\circ}$  to  $-42^{\circ}$ , in a series of twelve maps which have already been distributed to the observatories. It is to be hoped that the survey will be completed by being extended to the South Pole.

A very valuable series of charts which are useful to workers on faint objects are those prepared by Palisa and Wolf. The purpose of these charts and their description can be best understood by reading the statement of Palisa in the *Astrophysical Journal*, vol. 28, p. 86:—

Professor Max Wolf of Heidelberg has much facilitated my task of finding and observing small planets, especially those of the faintest magnitudes, by sending me copies of his photographs; so that now it takes me only about one-fourth the time formerly required to find them. This suggested to me the idea that it would be a great advantage if the photographs of the Heidelberg Astrophysical Institute were made available for every observer in a form suitable for immediate use. As Professor Wolf had intended at a later time to collect his photographs and join them in a map, he kindly offered to furnish positives free of cost. On these positives a réseau is then carefully cut, the curvature of the parallels being determined by the stars themselves. Each plate covers fifty square degrees, the scale being 36 mm. to the degree. Contact prints are then made from the positives on smooth but not glossy bromide paper; and the necessary text, including the numbers for right ascension and declination, is then printed on the sheets, which admit of pencil entries and erasures.

I have not attached a scale of magnitudes to these maps for two reasons. On account of different exposures, disks of equal size do not represent the same magnitude on different plates and even on a single plate the scale is not the same at the center and near the edge.

Nine volumes of this work have been published, each one containing twenty plates, but though they might prove very useful for observers who wish to identify faint stars, their cost is quite high and will interfere with their extensive purchase except by observatories.

There are a few miscellaneous sets of charts containing faint stars, but they are usually quite limited in area and can only be used for special purposes. Among them may be mentioned the Paris *Ecliptic Charts*, prepared by the Chacornac and the

Henry brothers; those made at Litchfield Observatory in Hamilton, New York, by C. H. F. Peters, and those of the *Carte du Ciel*.<sup>1</sup>

The close of this chapter on star charts and their use seems an opportune place in which to refer briefly to precession and give some directions for applying it. The precession of the equinoxes is a slipping westward of the equinox along the ecliptic at a rate of  $50''.2$  per year. It therefore changes the longitudes of all the stars, and consequently their right ascensions and declinations. When a catalogue is formed, the positions of all the stars in it must be referred to the position of the equinox for a certain definite time which is called the epoch of the catalogue; for example, the epoch of the *Durchmusterung* is 1855, while the actual observations extended from 1852 to 1862. In an exact catalogue the annual precession for each star in right ascension and declination is always given, but in some of the older catalogues this has been omitted, as is the case with the *Durchmusterung*. It is for this reason that the precession for ten years is given at the bottom of each column. It may be used for all of the stars in its column, because the positions are only approximate. The sign which is given to it is to be used in carrying the star forward from an early date to a later one, *e.g.*, in taking it from the catalogue date, 1855 to 1900, which is the date of the *Harvard Variable Star Catalogue*. If a new variable were to be discovered in 1915 and its position determined, and we wished to find if it were on Argelander's charts, it would be necessary to apply the precession for sixty years with the opposite sign in order to carry it back to the proper date. It is for this reason that some catalogues of variables give the star positions for 1855 in order to facilitate their location on the *Durchmusterung* charts.

<sup>1</sup> H. H. Turner, *The Great Star Map* (E. P. Dutton & Co., 1912), contains a full account of the formation of these important charts.

## CHAPTER III

### STAR CHARTS FOR VARIABLES

THE present chapter deals with charts which have been published especially for the use of variable star observers. The most important of them was prepared by the Reverend J. G. Hagen, S.J., during the years 1899 to 1908, the work being begun at the Georgetown College Observatory, Washington, and finished at the Vatican Observatory, of which he is now the director. It would be impossible to overestimate their value. The introduction, unfortunately, is in Latin, and many of the important points will ordinarily escape the reader, and hence it seems highly desirable to give a full and rather free rendering of the original text. However, on account of their technical character the following pages, beyond the opening paragraphs, will not be of particular interest to the general reader, being addressed rather to the specialist in variables, who has before him the charts and the accompanying catalogue sheets of this remarkable series.

The title of the work is *Atlas Stellarum Variabilium*, which is abbreviated by Hagen as *ASV*. It is in six series, each of which consists of two portfolios, one containing the charts, and the other the catalogue sheets for the comparison stars. The selection of the stars included in each series depends upon the extent of their light variation. The first three contain stars whose minimum light is below the tenth magnitude. They are further divided into zones according to the declination. Series I, published 1899, contains stars lying between the declinations  $-25^{\circ}$  and  $0^{\circ}$ ; Series II, published 1899,  $0^{\circ}$  to  $+25^{\circ}$ ; Series III, published 1900,  $+25^{\circ}$  to  $+90^{\circ}$ ; Series IV, published 1907, contains those variables the light of which at minimum is visible in instruments of moderate size, and for which both declination and magnitude are within the limits of the *DM*. charts; Series

V, published 1906, contains variables scattered over the entire sky, whose minimum light is greater than seventh magnitude; Series VI, published 1908, is supplementary to Series I, II, and III.

The preface, which is the same for Series I, II, and III, contains the following descriptive statements. The heading of the charts contains all the material which is necessary for observational use at night, and was taken largely from Chandler's *Third Catalogue*, after everything had been verified from observations made at Georgetown. At the top is given the Chandler number; under it the name of the star. The next line contains the right ascension and declination for 1900, with the annual precession. The fourth line contains at the left the color, reckoned on the scale of 10, 0 representing white, and 10 representing red. Following this is a Roman numeral, which indicates the spectral type according to Secchi's classification. At the right are the magnitudes at maximum and minimum. On the lower margin of the chart is arranged a row of small blackened circles, indicating the magnitudes of the stars, and below these is given the number of the series. If the region of the variable is found on other charts, such as the Paris *Ecliptic Charts*, and the *Clinton Charts* of Peters, a statement to this effect is made.

The chart itself, which is beautifully printed on heavy paper, represents a region of the sky  $1^\circ$  square, with the variable at the center, and is divided into two main parts. The central square,  $30'$  on each side, contains nearly all the stars which are easily visible with the Georgetown telescope and whose light is as faint as that of the variable. The outer part contains all the stars in that region which are found in the *DM.* catalogue, and some additional stars, which are inserted where there is danger of misidentification. If a bright star is in the neighborhood, but a little too far away to appear on the chart, an arrow placed at the proper declination indicates its direction in right ascension. Heavy lines separate the inner square from the rest of the chart, and finer lines form a network in which the squares are  $5'$  wide. On the margin are printed numbers which indicate

the distance in right ascension and declination, counted from the center. In the latter co-ordinate they are  $5'$  apart, but in right ascension the difference depends upon the cosine of the declination at the center. For example, at zero degrees they read:  $0^m$ ,  $20^s$ ,  $40^s$ ,  $1^m$ , but at sixty degrees they read:  $0^m40^s$ ,  $1^m20^s$ ,  $2^m$ , etc.

Since the charts are made for use with the telescope, they are inverted in direction; north is at the bottom of the figure, east at the right, south at the top, and west at the left. The eastern part of the field is frequently called the *following edge*, and the western the *preceding edge*, since that is the order in which the stars move by diurnal motion.

The variable is represented on the chart by a dot with a circle around it, the former indicating the magnitude at minimum, and the latter that at maximum.

The catalogue sheets containing the comparison stars are printed on paper of about the same size as the charts. In the upper corner of each sheet is the number of the series. The material in the headings is again taken from Chandler's *Third Catalogue*. It contains the Chandler number, the name of the star, the position for 1855, and the elements, that is, the epoch and the period, the former being expressed both as a Julian Day and as the calendar date. The contents of the columns may be described as follows, being the same for all of the first three series. The first column contains the current numbers of the comparison stars, which are arranged in order of magnitude. The second column, headed "Gradus," contains the grades, or steps; the third column, the magnitudes which are deduced from the grades; and the fourth column, the magnitudes taken from the *BD.*, when the star occurs in that catalogue. The next two columns give the quantities  $\Delta\alpha$  and  $\Delta\delta$ , or the differences in right ascension and declination, counted from the variable itself and referred to the epoch 1900. These differences, when added to the position of the variable for 1855, will give approximately the positions of the comparison stars for the date of the *Durchmusterung*, and hence will aid in the identification of the



stars in the catalogue. The positions given on the Hagen Charts are for 1900.

The brightness of the stars was not observed in such a way that the magnitudes could be immediately assigned to them, but without any photometric assistance the grade, or step, was estimated by which one star differed from another a little brighter or a little fainter. In this way the brighter stars of the three series were compared, with a small instrument of 4.8 inches aperture, between the years 1892 and 1895, and again with a larger instrument between the years 1895 and 1898, at which time the fainter stars were also observed. Thus the grades of the brighter stars were found by four independent determinations, and those of the fainter stars by two. These partial sequences were then put together in one series, and the stars arranged in order of grade from the brightest to the faintest; and they are so placed in the list. The method of converting the grades into magnitudes is of importance, since it is necessary to know upon what standards the magnitudes of the comparison stars are based before observations of the variable can be combined with those made with other comparison stars, Hagen makes it quite clear that he considers his magnitudes only relative, and not absolute, but he still believes that they serve the purpose for which they were intended. At the time when his charts for the first three series were issued, there were no photometric observations of faint stars, and not many for stars of the seventh and eighth magnitudes. The only standard which had any degree of uniformity was found in the magnitudes of the *Durchmusterung*. Therefore, he connected his grades with the magnitudes of the *BD*. stars which were found on his maps, so that the two scales fitted together between the magnitudes 7.0 and 10.0.

He derived by this means a formula which gave expression to the relation. For example, star no. 1, Series I, is S Ceti; his formula for converting the grades into magnitudes is,

$$M = 8.9 + 0.071 (G - 17.8),$$

in which *G* stands for the grade given in the second column,

0.071 is the value of one grade expressed in magnitudes, and 8.9 is the magnitude for a star of grade 17.8. The use of this formula is continued for the very faintest stars. Each chart thus has a formula of its own, and it is only through the common use of the *BD.* magnitudes that a uniformity of scale exists between the different charts. For stars below 10.0 mg., which is the lower limit of the *BD.*, even this is not attained, for as the scale is extended downward, the lower limit of magnitude will not be the same for all the charts, for several reasons. Firstly, the conditions under which it was obtained will not be the same, owing to the difference in altitude and atmospheric conditions, with the result that the lower limit visible with the Georgetown telescope of twelve inches aperture will vary from 11.5 to 13.5 mg. The light ratios, in passing from one magnitude to the next, cannot be assumed constant without the use of a photometer. Furthermore, the *Durchmusterung* scale is probably not uniform all over the sky, and if the reference stars of 9.5 mg. or 10.0 mg. are too bright or too faint, the resulting magnitudes of the fainter stars will be similarly affected. The relative brightness, however, as indicated by the steps, will remain unchanged. The magnitudes were intended primarily for representation on the charts for purposes of identification; the observer need not use them in his observations or computations. He need not even use the step values if he prefers those derived from his own comparisons, but they may be of service at any time when photometric observations of a few comparison stars have been made, in order to find the relation between the photometric scale and the visual scale. They may thus be adapted to any scale. The process of adapting the Hagen grades for the first three charts to the Harvard photometric scale will be found in *Annals*, H.C.O., vol. 37, part II.

The positions of the stars for the charts were determined with the aid of a semicircular glass disk in the eyepiece, so inserted that the diameter served as an hour-circle. On the glass were drawn perpendicular lines, so heavy that they could be perceived by the natural light of the sky. The scale was

divided into ten parts of 3' each. It will be remembered that this method was used by Argelander. The declinations were estimated to the tenth part of an interval, or 0'.3, without haste, while the telescope was being carried by the driving clock, from which method an error of 0'.3 or perhaps 0'.6 can be expected in the declination. The right ascensions were determined by three observations on the chronograph, and probably, except in the case of the fainter stars, do not vary more than a second from the correct value. The amount by which the scale was inclined to the hour-circle was determined for the individual charts from many stars whose positions were taken from different catalogues already published, or from stars in the *A.G.C.*, extracts from which were sent to Hagen before being set up in type, and also from observations made with the meridian instrument at the Georgetown Observatory. The epoch to which the quantities  $\Delta\alpha$  and  $\Delta\delta$  are referred is the year 1900. It is to be noted that the positions of the stars outside the limits of the chart are taken for the most part from the *BD*.

The last column contains the notes, for which little explanation is needed. "Duplices" indicates stars the component parts of which cannot easily be separated. The numbers which are added from the various catalogues of variable stars require no particular explanation. Another sort of note is the abbreviation, either *Sch.* or *Ch.*, by which it is indicated that the stars so designated are near the variable in the catalogue either of Schönfeld or Chandler. Since the brightness of some of the comparison stars exceeds 7.0 mg., the above mentioned method could not be adopted for determining their magnitudes, and hence these are added in the notes, being taken from other sources, which depend upon the declination of the star; *e.g.*, the *Cordoba Durchmusterung (CD.)*, or the *Potsdam Durchmusterung (PD.)*.

In the remaining lines of the Introduction Father Hagen states that he himself was responsible for the observations of the positions and grades of the stars, and that the computations

of the magnitudes of the stars and the inclinations of the scale were made by his associates. He also expresses his thanks to those who had assisted him in collecting the material for the charts.

The fourth series was published in 1907, after the appearance of volume 37 of the *Annals*, above referred to, which contained the discussion of the relation between the Harvard photometric magnitudes and the Hagen grades for many stars of the first three series; and hence Hagen had the opportunity to profit by further co-operation with the Harvard Observatory, as will be described later on, in connection with the magnitudes of the comparison stars. This fourth series was prepared for the observation of those stars whose minimum light could be observed by instruments of small aperture, that is, of from three to six inches. Therefore the limiting magnitude of the stars delineated upon the charts is almost the same as that of the *Durchmusterung* catalogue. The headings of the charts are practically the same as for the first three series, the values, however, being taken from the latest sources. The only difference between the charts of this series and those of the first three is in the scale used; the outside square is now  $2^{\circ}$  wide, and the small ones  $10'$ . A further reference to this fact will be found in Chapter XV. The ratio of star density between the inner and outer regions of the chart is the same as in the earlier series. Not only are all the stars of the *DM.* included, but fainter stars are added wherever they are useful for observing the minimum light of the variable or for making the configuration more certain. In the area surrounding the inner square the lower limit of magnitude is between 8.0 mg. and 9.0 mg. whenever this seems desirable. Those charts which contain the variables in Chandler's *Third Catalogue* were drawn by J. Hisgen at the Georgetown Observatory and later compared with the sky at Valkenburg, Netherlands.

On the catalogue sheets the headings are practically the same as for the first three series, the sources being different in some cases. In the case of the Algol type the periods only are given,

since the times of minimum light can be taken more accurately and quickly from the *Ephemerides*. The material found on the sheets, however, is considerably different. The first column contains the current number, the second and third the *BD.* number and magnitude. The fourth column, which is headed *HP.* (*Harvard Photometry*), contains for several of the stars photometric magnitudes which were communicated to Hagen directly by Pickering from observations made just previously at the Harvard College Observatory. How these were used in determining the magnitudes will be described presently. The column headed "Gradus" contains sometimes two sets of numbers, one of which was derived from observations made by Hagen, and the other from those by Hisgen. Therefore, if the two sets are present, the first are due to Hagen, and the others to Hisgen; if only one, it is the work of Hagen alone.

The magnitudes were obtained by the same general method that was employed in the preceding series, that is, by connecting the observed grades with the magnitudes of the stars which were already known. However, for this series they rest upon

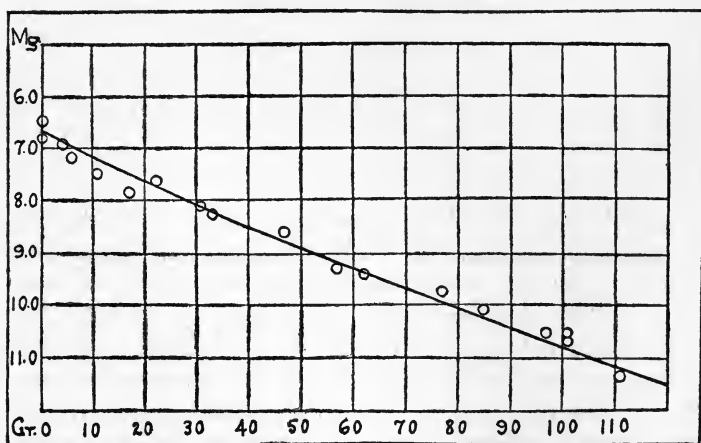

Figure 16

MAGNITUDE CURVE FOR RV HYDRAE

TABLE I

Star No.	H.P.	Gr.	Mag.	Star No.	H.P.	Gr.	Mag.
1	6.82	0	6.7	23	9.37	62	9.4
2	6.48	0	6.7	24		63	9.4
3	6.95	4	6.9	25		66	9.5
4	7.18	6	7.0	26		71	9.8
5	7.52	11	7.2	27		73	9.8
6	7.86	17	7.5	28	9.77	77	10.0
7	7.68	22	7.7	29		78	10.0
8		25	7.9	30		84	10.2
9		27	8.0	31	10.08	85	10.3
10		27	8.0	32		88	10.4
11	8.11	31	8.1	33		90	10.5
12	8.27	33	8.2	34		91	10.5
13		36	8.3	35		93	10.6
14		38	8.4	36	10.57	97	10.7
15		43	8.6	37		97	10.7
16	8.65	47	8.8	38		100	10.8
17		51	8.9	39	10.70	101	10.8
18		55	9.1	40		101	10.8
19		57	9.2	41	10.56	101	10.8
20	9.26	57	9.2	42		103	10.9
21		59	9.2	43		106	11.0
22		60	9.3	44	11.33	111	11.2

a much better foundation, namely, upon the photometric magnitudes communicated by Pickering instead of on the *Durchmusterung* values. The process is described as follows. Points were plotted using the magnitudes as ordinates, and the Hagen grades as abscissas, and curves drawn through them which defined the magnitude for each grade. These curves differed for the different charts, but did not deviate much from the straight line. Where there were two sets of grades the magnitudes were determined from both curves, and the arithmetical mean of the results taken. Their disagreement is for the most

part between the limits  $\pm 0.1$  mg. and  $\pm 0.2$  mg., although when the curve is extended beyond the limits of the stars furnished by Pickering, it occasionally increases to larger values. The magnitudes thus determined appear in column six. Above are given in a table the necessary values for constructing the magnitude curve for RV Hydrae. The points on the curve were plotted by using the Hagen grades as abscissas and the Harvard magnitudes (*HP.*) as ordinates. The magnitudes in the fourth column were read from the curve.

The values for  $\Delta\alpha$  and  $\Delta\delta$  were computed for the year 1900, though the positions of the variables in the headings of the catalogue sheets are for 1855. The positions of the brighter stars were taken from the catalogues of the *A.G.C.* For the fainter stars they were obtained partly from observations made at Georgetown, partly from measurements made at Harvard, on photometric plates, and partly from the *BD.*

In the column "Notae" may be found magnitudes and colors taken from the *Potsdam Durchmusterung*, the letters of Bayer, and the numbers of Flamsteed. The abbreviation "dpl." refers to those stars the components of which cannot be observed separately, and which hence should not be used as comparison stars in measuring the light from the variable. Furthermore, if the "dpl." precedes the name of a catalogue, it indicates that the observation was first made with the telescope at Georgetown or Valkenburg, but if it follows, then it was taken directly from the catalogue; *e.g.*, RT Hydrae, star 23, "dpl. A.G.C. 9.5 prec.," and X Monocerotis, star 17, "A.G.C. dpl. 9.0." The small letters enclosed in parentheses designate the colors as assigned by Hisgen, and signify the same colors as the corresponding capital letters from the *PD.* catalogue; *e.g.*, "(r)" denotes the same color as "R."

The fifth series contains stars which are visible to the naked eye. A few are inserted from the other series also if a large part of the variation is visible to the naked eye or can be observed with hand instruments. These are  $\chi$  Cygni,  $\circ$  Ceti, R Hydrae, R Carinae, and in addition  $\eta$  Carinae. There are other stars,

twenty six in number, not properly belonging to this series, whose minimum light is below seventh magnitude, which are included on the charts because they can be recognized and observed at maximum, being then lucid.

In making the charts Hagen received the assistance of various helpers at the Georgetown Observatory, each chart being carefully compared with the sky. Fainter stars were added when necessary for observing the light at minimum or for avoiding ambiguity. The last four charts, which give the region about the south pole, were drawn by Goetz at Bulawayo, Rhodesia. The charts, while made on the same general plan as those in the earlier series, differ somewhat in scale, each one being suited to the particular variable. The scale of projection and the co-ordinates of the center of each will be found in Table I of the preface. In the region immediately surrounding those variables which are faint at minimum, the stars are denser than in the remaining portion, which does not contain any fainter than the fifth magnitude. The catalogue sheets which accompany the charts are considerably different from those of the previous series. The heading gives the Chandler number, the name of the star, and the character and elements of the variation taken from Chandler's *Third Catalogue*. In the case of stars of the Algol type, variations in the length of the period are only indicated, since it is much easier and more accurate to take the times of minimum directly from ephemerides especially prepared for the purpose than to compute them from the elements. They are now given in full in Hartwig's yearly catalogue.

Not only are the stars named by their constellations (column one), according to the divisions made by Argelander, Heis, and Gould, but also there are added the Bayer letters, the Flamsteed numbers, or those from the *Uranometria Argentina* in the case of far southern stars. If the stars are placed in other constellations by other authorities, it is so stated in the notes. Following these designations in the fifth column are numbers taken from the *BD*. or Cordoba catalogue, or from the cata-



logue in *Annals*, H.C.O., vol. 34, *Southern Meridian Photometry*. The positions of the stars are given in the order of their right ascensions in the different constellations. Most of them have been taken from the best catalogues, such as the *Berliner Jahrbuch*, *A.G.C. Zones*, *Cordoba General Catalogue*, a few from the *BD.* or *CD.*, and all have been reduced to the year 1900.

The magnitudes of the stars have been taken from the *Potsdam Photometric Durchmusterung (PD.)*, the *Harvard Photometry (HP.)*, or the *Uranometria Argentina (UA.)*. In the last four, in the place of *PD.* is given *LM.*, by which is signified the magnitudes determined by Dr. Roberts, Love-dale,<sup>1</sup> South Africa. In the last column, headed "Notae," may be found the variation in brightness of the variable, taken from Chandler's *Third Catalogue* and printed in bold type, differences in the designations of stars, the numbers of clusters and nebulae taken from other catalogues, colors, etc. Regarding color, those numbers which immediately follow the letters Kr. refer to the work of Krueger entitled *Catalogue of Colored Stars*, [e.g., 6<sup>c</sup> Kr. 1282] or if a number be enclosed in parentheses, it is taken from the supplement. If the letters precede, they signify that the colors of the stars were measured by the same authority, but in accordance with the scale of Schmidt, and not that of Chandler, as in the remaining series. As the purpose has been only to call attention to stars which are too highly colored to be used for comparison stars, numbers lower on the scale than 4.0 have not been included, since they represent colors which do not differ much from white. No effort was made toward a critical comparison of this catalogue with others, as *PD.*, or Osthoff. It is enough to state that the scales of Osthoff

<sup>1</sup> Note from Dr. Roberts, explaining his method of estimating magnitudes, taken from a letter. By experiment he had determined three limiting magnitudes to which he referred the other magnitudes by means of grades. He assigned mg. 6.8 to the faintest star which could with difficulty be seen with the naked eye, 9.2 mg. to stars which could with difficulty be seen with a one-inch telescope, and 11.4 mg. to those which were just seen with a three inch. He arranged the stars in sequences of grades between any two of these limiting magnitudes in opposite directions, starting sometimes from the upper limit and sometimes from the lower.

and Krueger (with the general exception of O-K = +1<sup>o</sup>3) agree with Schmidt, and that of the *PD.* very nearly with Chandler's.

In the last four folios are inserted notes from the *UA.* in which the letter "r" indicates red stars, and "c" stands for other colors. Other notes are self-explanatory. At the end of each is added a table giving a list of the comparison stars by number which have specially been used by observers accustomed to work on these variables, from which it may easily be seen which are the most suitable to use. Table II of the preface contains a list of the abbreviations of the authorities.

Special reference was made to an instrument suitable for observing the stars in this series. In fact the division of the stars into five groups had actually been made in order that those in each group might be observed with the same sort of instrument. The first three contain stars suited for larger telescopes; the fourth, since it contains stars within the limits of the *BD.*, is especially adapted to smaller instruments; and the fifth is for observation with the naked eye, or small instruments which may be held in the hand. Hagen then describes the Steinheil binoculars, which have an aperture of 34 mm. The image is enlarged five diameters, and the intensity of its light is increased forty-nine times.

The sixth series of the charts is intended to be supplementary to the first three, and is prepared in exactly the same manner, except that in the catalogue sheets an additional column, the fifth, occurs, which contains the magnitudes according to the scale of the *Harvard Photometry.* These were deduced from certain stars among them, the magnitudes of which were furnished as standards by Professor Pickering. They are indicated in this column by having the magnitudes printed in bold type. In using them their magnitudes were plotted as ordinates with the Hagen grades as abscissas; curves were then drawn through the points from which the magnitudes were read for all the stars, as explained for Series IV.

There were two reasons why the column *HP.* was added; the

first that the relation which existed between the magnitudes of Series I, II, and III and the *HP.* system might appear more clearly, and the second that certain tables in the *Annals*, H.C.O., vol. 37, which were prepared for the purpose of converting the Hagen grades into Harvard magnitudes, might be extended to the charts in Series VI. This column is especially important because it thus exhibits the relation between the magnitudes derived from the two systems. The maximum or minimum light in the separate folios indicated in the headings is taken from the elements contained in the *Third Catalogue* of Chandler and its revision, or from Pickering's second catalogue,<sup>1</sup> or from a new catalogue, the material for which is being prepared for the Committee of the *Astronomische Gesellschaft*, and was communicated in advance by Dr. Müller.

In addition to the introductions for each series which have just been described, there is also a General Index giving the number of each star in its series, the arrangement being according to the order of right ascension. A second table is an Index to the Constellations, in which the stars are arranged according to the constellations. A third table furnishes a key connecting the present system of nomenclature with that formerly in use by the *Bureau des Longitudes*, but now superseded.

We shall now describe the maps which have been especially prepared for the use of variable star observers at the Harvard College Observatory, but in the present chapter only the method of preparing the maps will be described, leaving the method of determining the magnitudes to be given later. The *Durchmusterung* maps have been made practically useful for the observer by selecting a region  $3^{\circ}$  square surrounding the variable and enlarging it photographically. On the negative before printing are written the letters of the comparison stars. These are then printed on heavy paper 8 x 10 inches in size, which can be used with the telescope very conveniently. They are especially suitable for a small instrument and for variables which do not go below 9th or 10th magnitude at minimum.

<sup>1</sup> *Annals*, H.C.O., 55.

The correct magnitudes of the comparison stars accompany the maps. They are obtained from photometric observations made at the Harvard Observatory for this especial purpose. More recently, in preparing these enlargements of the *BD*. charts, instead of attaching the letters to the comparison stars the magnitudes have been used, so that an observer can obtain the magnitude of the variable directly.

The Harvard Observatory has also prepared for its use other photographs taken directly from the sky with exposures of different lengths, the variable occupying the center of the map. Sometimes these are enlargements of negatives already obtained for other purposes. On these charts the comparison stars are marked either with magnitudes or letters. The magnitudes are used for all the brighter stars and frequently for faint stars down to magnitude 13.5. Sometimes, however, the numbers extend only to magnitude 13.0 and letters are attached to the fainter stars. The Director of the Harvard Observatory, Professor E. C. Pickering, whose long-continued interest in variable stars is well known to the astronomical world, has at different times invited the co-operation of astronomers and amateur observers in the study of variable stars, and has offered to provide photographic maps for any one who wishes to make use of them. The lists of the comparison stars for many of the variables which he recommends for study have already been published in *Annals, H.C.O.*, vols. 37 and 57, and others will appear later. There is some difference of opinion in regard to the systems of magnitudes employed, especially in the case of the faint stars, but the observer who is using the Harvard maps is recommended to adopt those given on the maps, since they will then be on a uniform scale. If at some later time it is thought desirable to adopt another system, the change can easily be made.

For observers who are working with faint stars the photographs of Parkhurst will be of very great use. They were taken at the Yerkes Observatory with a twenty-four-inch reflector, at Father Hagen's request, and include all of his charts in

Series I, II, III, and VI, in which the variable reaches the 13th magnitude or fainter at minimum. Of the 193 fields in the four series the variable falls to the 13th magnitude in 140 cases. These 140 fields have been photographed, and negative prints on bromide paper 8 x 10 inches in size can be obtained at the Yerkes Observatory. The scale of the prints is 10'' to one mm. Therefore the field covered will be 0.8 of a degree square. For galactic fields crowded with stars, prints of double this scale can be supplied. The name of the field, the place for 1900, and the orientation are to be marked on the print. The variable itself will be enclosed in a small circle. The Hagen chart can serve as an index to these photographs, the brighter stars be identified on his lists, and with the known scale the positions of the fainter stars relative to the variable can be determined. The plates have been taken with an exposure of one hour and show stars to the 16th magnitude.<sup>1</sup>

Another set of maps containing the faint stars surrounding twelve variables may be found in a volume by Parkhurst entitled *Researches in Stellar Photometry*. This work was carried on largely at the Yerkes Observatory and many of the comparison stars are fainter than the 14th magnitude. The maps and magnitudes will be especially useful to those who are observing these particular stars.

Maps for individual variables are scattered through various numbers of the *Astronomische Nachrichten*, *Astrophysical Journal*, etc., and may also be found in the publications of many observatories.

<sup>1</sup> *Ap. J.*, 28, 87.

## CHAPTER IV

### CATALOGUES OF VARIABLES

THERE are several systems for naming variable stars, but the one described here is that most generally in use. As soon as a variable star is discovered, the fact is communicated to the *Astronomische Nachrichten* for publication. The editor of the journal refers it to a committee of the *Astronomische Gesellschaft* which has the matter in charge, and they assign to the star a provisional number which indicates the year and the order of discovery in the year. This is followed by the name of the constellation; *e.g.*, 89, 1914 Persei, signifies the 89th variable discovered during the year 1914 which is in the constellation of Perseus.

This provisional name is retained until the variation is confirmed and the elements are more or less known. A permanent letter is then assigned to it in accordance with the following rule, which originated with Argelander. The first variable discovered in a constellation is given the letter R, the second S, and so on, the ninth one having the letter Z. The tenth star has the double letter, RR, the next one RS, and so on as far as RZ. They begin again with SS, and continue in this manner until the combination ZZ is reached, allowing thus for fifty-four variables in one constellation. It became evident several years ago that this method would not suffice, and some other device was necessary. The committee appointed by the *Astronomische Gesellschaft* reported that as it would be quite inconvenient to triple the letters, the best plan would be to return to the first letters of the alphabet and beginning with the combination AA, AB, . . . . AZ, BB, . . . . BZ, continue as far as QZ, thus adding 280 more combinations. This was adopted, and the first constellation to which it was applied was Cygnus, which in Hartwig's ephemeris for 1914 has the combi-

nation BB, while Scorpio has AL, and Sagittarius, AR. This report of the *Astronomische Gesellschaft* committee may be found in *Astronomische Nachrichten* 4212. At frequent intervals lists of variables containing the provisional and permanent names are published by the committee, together with other important information and notes, e.g., *Astronomische Nachrichten* 4457.

Another method of designating variables by numbers was devised at the Harvard Observatory and is in general use there. Each number consists of six figures, the first two of which give the hours of right ascension, the second two the minutes, and the last two the degrees of declination; e.g., 123961 is the Harvard number for S Ursae Majoris, and shows that its right ascension is 12 hours and 39 minutes, and its declination is  $61^\circ$ . If the star is south of the equator the number is printed in italics. The advantage of this method of numbering is that it is easy to locate the variable in the sky. At the Harvard Observatory members of the staff who are accustomed to using the numbers can remember them and set without looking at the map. This, however, can be done only with a small telescope, for with one of large aperture it is necessary to set to a tenth of a degree in declination and hence the Harvard number is not sufficient.

Another method of numbering was introduced by S. C. Chandler and the numbers in the system are called Chandler numbers. They are obtained by reducing the right ascension for 1900 to seconds and dividing by ten; e.g., the Chandler number for S Ursae Majoris is 4557, which is obtained from the exact right ascension, which is  $12^{\text{h}} 39^{\text{m}} 34^{\text{s}}$ , or 45,574 seconds. This method, which was extensively used some years ago, is no longer employed.

A fourth method of designation, which was suggested by André in his *Traité d'Astronomie Stellaire*, is very logical but has not been adopted generally, although by it an indefinite number of variables in a constellation can be included. The letter V followed by a number is prefixed to the name of the

constellation, the number indicating the order of discovery in that constellation; e.g., V 8 Draconis would signify the eighth variable discovered in Draco and would be the same star as Y Draconis.

The first method is the one in most general use. It seems to be the one most analogous to the ordinary method of naming stars. It is interesting to note that quite recently Nijland has suggested the adoption of André's nomenclature, on account of the possibility of its unlimited extension.<sup>1</sup>

There are two principal sources of information in general use at the present time regarding variable stars, in which the data are arranged in catalogue form: the *Harvard Catalogue of Variable Stars* found in *Annals*, H.C.O., 55, and the *Katalog und Ephemeriden veränderlichen Sterne*, published yearly by Hartwig in the *Vierteljahrsschrift der Astronomischen Gesellschaft*, and obtainable in a separate pamphlet on request. The Harvard catalogue contains the following information, the stars being arranged in order of right ascension: the Harvard number, the common name of the star, the number in the *Durchmusterung* zone, the right ascension and declination for 1900, the magnitude at maximum and minimum, the length of the period, the epoch expressed in Julian Days, the class of variable, the type of spectrum, the year of discovery with the provisional number, and the name of the discoverer. The table is followed by copious notes. Another table in this important and valuable publication contains many miscellaneous facts, such as the color, the interval of time "maximum minus minimum," and a bibliography of maps on which the variable is to be found. Since the spectrum of a variable is a fact of extreme importance, it may be stated here that a more complete table containing this information regarding a great number of variables is to be found in *Annals*, H.C.O., vol. 56, no. 6.

The *Ephemeriden* published by Hartwig, as the name implies, is intended for practical use in making up observing lists and for the purpose of comparing observed maxima and minima

<sup>1</sup> A.N. 4765.



with the computed times. In describing it the volume for 1914 will be used as a type. The first pages are devoted to an introduction, which contains a statement of the changes which have been made in the elements of the variables already known and the introduction of new ones. This particular number contains a discussion by Hartwig regarding the introduction of the name "Blinkstern" as a substitute for "Cepheid" variable which was mentioned in the first chapter of this book.

The ephemeris proper is divided into four parts. Part I is further divided into two groups, the first containing those variables whose declination is north of  $-23^\circ$  and the second those which are south of it. In respect to their arrangement the two divisions are the same. The reason for the separation is that the *Durchmusterung* maps on which the variables are to be found are prepared for different epochs, that for the northern stars, which is Argelander's, being for the epoch 1855, and that for the southern being for 1875, the date of the catalogue of the Cordoba Observatory. The tables contain the current number, the right ascension and declination for the epoch of the catalogue, with the annual precession, and if the star is of long period, the elements of variation, which include the epoch and the period, with the addition of any terms indicating periodic or secular change in the elements. In the column for the elements are inserted the words "unbekannt" (unknown) and "unregelmässig" (irregular), when necessary. If a star is not a long period variable, it is stated in which of the following divisions of the pamphlet it is to be found; *e.g.*, SY Cass. is placed in *Abt.* II; TV Cass. in *Abt.* III, 2; SX Cass. is *Abt.* IV, 1. On the page facing this are further data regarding the same stars; *viz.*, the magnitude at maximum and minimum, and the date for each, predicted from the elements on the left hand page. Where the data for the predictions are incomplete, blank spaces are left or the word "Unbekannt" is inserted.

Part II contains the following data regarding short period variables: the name of the star; the phase represented, whether maximum or minimum; the epoch in Julian Days, the number of

decimal places in which expresses the accuracy of the determination; the period in days; the quantity  $M-m$  when known, and the type of variation; *i.e.*, whether the star be a "Blinkstern," or of the  $\zeta$  Geminorum type, or belong in some other group. At the end of the section there are placed in one group the stars from this table which have periods less than one day and hence change with great rapidity. For these stars the right ascension, declination, and longitude for 1900 are given, also a quantity which is used in obtaining the *reduction to the sun*, a correction which is usually applied to the observed time of maximum or minimum when the period is very short and regular. A full explanation of the formula and its application will be given in the chapter on prediction.

Part III contains the heliocentric minima of the Algol stars computed for Greenwich Mean Time. The stars are arranged in order of right ascension. For each is given the elements with the name of the authority. When the period is very short, one minimum for each month is given and multiples of the period are tabulated by the application of which the other minima may be found. Following this material is a table which contains the data for the reduction to the sun, and also the duration of phase, that is, the time from maximum through minimum to maximum, or the period of time during which the star is varying. This is marked  $D$ . The column  $d$  contains the length of time during which the star is at minimum. Sometimes this is very short, as in the case of Algol, and sometimes it lasts for an hour or more, as in the case of U Cephei.

In the publications previous to 1914, Table IV contained the necessary data for the ant-*Algol* stars, but in that for 1914 these stars are combined with the other *Blink* stars, and Table IV is reserved for the  $\beta$  Lyrae stars. The arrangement of data is practically the same as for the *Algol* stars. Following this is a table giving a key which will enable one to find the number of the variable in the catalogue from its letter.

The value of this *Ephemeris* cannot be overestimated, and it is quite indispensable to a worker in variable stars.

Several important catalogues which appeared previously to the publication of the *Provisional Catalogue* of the Harvard Observatory were prepared by S. C. Chandler, the first one appearing in the *Astronomical Journal* for September, 1888.<sup>1</sup> According to Chandler's own statement the catalogue was not a mere compilation, but at its publication involved the collection of all the published observations of the known variables since their discovery, including his own unpublished results, which related to nearly the whole list of variables visible in the latitude of Boston. A discussion more or less complete of this material furnished the values of the elements of the light variations in his catalogue. In it he first introduced his method of numbering the variables, described on an earlier page of this chapter. The first catalogue contains the following information: the Chandler number, the number in a former catalogue published by Schönfeld, the position for 1855 with the precession, the name of the discoverer with the date, the redness of the star, the magnitude at maximum and minimum, the Greenwich Mean Time of the epoch either maximum or minimum, the length of the period, remarks, and the position for 1900. The third catalogue, published in 1893, contains important material in the same line, with very few changes, except that the Julian Day of the epoch is added to the calendar date. Periodic inequalities are several times given with elements. This catalogue was considered the standard until the publication, as before stated, of the Harvard catalogue.

Since the data connected with the discovery of variables are included in several catalogues, this seems a suitable place for giving some account of the methods by which they have been discovered, especially of some of the systematic searches which are being made for them.

The methods in which the variability of a star is discovered may be roughly classed as visual, photographic, and spectroscopic. The discovery may be made visually in several different ways, by direct observation either with the naked eye or

<sup>1</sup> *Ast. Jour.*, 8, 81.

with the telescope in the process of making star catalogues, through an investigation of missing *DM.* stars, and as the result of the observation of comparison stars for other variables. These four methods may be easily illustrated. The earliest known variable, Mira Ceti, was discovered because at its maximum brightness it was a reddish star, rather conspicuous, and at its minimum either invisible or else extremely faint. It was first noticed by Fabricius in 1596, and again in 1638 by Holwarda, whose observation of it may be described in the following terms:<sup>1</sup> on the 16th of December, 1638, he was occupied in measuring the altitude of the stars above the horizon through a cloudy sky, for the purpose of observing an eclipse of the moon, when he saw three times something very brilliant and new sparkling in the constellation of Cetus; but as he was preoccupied with the eclipse, he did not disturb himself further in regard to it. However, some days later he was again observing the sky for the purpose of verifying the altitudes previously determined, when his eye fell by accident upon Cetus. He again saw shining something unfamiliar to him. He supposed this apparition to be a temporary meteor, but the following day, according to the advice of the Professor of Mathematics, he undertook the examination of that portion of the sky. The apparition which had so impressed him was still visible, and he began to study it attentively and to determine its position. Both to the naked eye and to the telescope it resembled the other stars. It was brighter than neighboring stars of the third magnitude. Some time later he was no longer able to find this star, and he believed that it had disappeared; but great was his astonishment when on the 7th of November, 1639, he perceived it in the same place which it had occupied at its first appearance, and shining with a brightness sensibly the same. At this epoch the star was considered by astronomers as a new star, but Holwarda took particular pains to show that it had been known for a long time and that Bayer had catalogued it in 1603 as being of the fourth magnitude, under the name of *o* Ceti.

<sup>1</sup> Ch. André, *Traité d'Astronomie Stellaire*, 1, 300.

Its identification led to consequences of the greatest importance, proving its rapid and periodic variability, and this fact seemed so remarkable that Holwarda's contemporaries gave to this star the name *Mira Ceti*, the wonderful.

The star Algol was also one of the earliest variables to be discovered, having been known since 1669. Its remarkable variation won for it its name, which signifies the "Demon Star."

The following extract from a letter written by John Goodricke, June 27, 1785, and printed in the *Philosophical Transactions*<sup>1</sup> for that year, describes his discovery of the variability of  $\beta$  Lyrae:—

The account that has been lately given of the regular variation of Algol's light and the notice astronomers have been pleased to take of it, are well known. It is natural therefore to suppose, that the relation of other similar phaenomena may also meet with the same favorable reception. Of this kind is the following, which I beg the favor of you to present to the Royal Society.

On the 10th of September, 1784, whilst my attention was directed towards that part of the heavens where  $\beta$  Lyrae was situated, I was surprised to find this star much less bright than usual, whereupon I suspected that it might be a variable star: my suspicions were afterwards confirmed by a series of observations, which have been regularly continued since that time, and which will presently follow in their proper place. At first I thought the light of this star subject to a periodical variation of nearly six days and nine hours, though the degree of its diminution did not then appear to be constant; but now upon a more close examination of the observations themselves, I am inclined to think that the extent of its variation is twelve days and nineteen hours, during which time it undergoes the following changes. . . .

A person who is habitually interested in observing the lucid stars acquires a great familiarity with the aspect of the constellations and can quickly discover an object of unusual interest. The two brightest novae of recent years were discovered in this way by the same person, Dr. Thomas Anderson, who was the first to observe Nova Aurigae and Nova Persei. He stated that if he were to see in a constellation an additional star

<sup>1</sup> *Phil. Trans.*, 75, 153.

as bright as the third magnitude, he would recognize it immediately as a new star.

Many variables have been discovered in the course of making star catalogues. An important factor in the identification of the star is its magnitude, hence in preparing the catalogue the observer compares his observation of magnitude with those of previous observers, and thus any decided difference will be detected. Sometimes his individual observations will differ among themselves to such an extent that the star is suspected of variability. Sometimes in using the *BD.* catalogue a star will seem to be lacking. On investigation it may turn out to be a variable, or an error in the original observation may be discovered by referring to the records which were preserved in the library of the Bonn Observatory for this very purpose, according to Argelander's expressed wish. The following illustrations may be of interest.

Here is an account of the discovery by Espin of a variable star, which is announced in the *Astronomische Nachrichten* 3264. While observing a star for his catalogue he found that the magnitudes, as observed on four nights, were 8.6, 9.0, 9.6, 9.8. These showed that the star was a variable, which fact was later confirmed, and it is now known as W Cassiopeiae. In *Astronomische Nachrichten* 3269 de Ball writes that at the Von Kuffner Observatory in Vienna he was not able to see a star *BD-6 5419* in his meridian telescope of 4.5 inches aperture, but found another faint star 9.8 mg. near by. Some days later he observed the same region again and saw both stars, the missing star having reached 9.0 mg. Since he could no longer observe the region with the meridian instrument, he asked Dr. Holetschek to follow it with the equatorial. The latter did so and confirmed the variability of the star, which is now known as Z Aquilae. A communication from Küstner states that the star had been observed twice by Argelander in forming the *Durchmusterung*, with the magnitudes 9.0 and 9.3.

The circumpolar variable U Cephei was observed several times by different astronomers in the process of making star

catalogues. Each time it was seen near its maximum brightness, 6.9 mg., excepting once when it was found by Schward<sup>1</sup> to be 10.0 mg., but this discrepancy was not noticed until the variability of the star had been discovered by the Ceraskis from the examination of photographs. The star TY Aquilae, which is one of the comparison stars for W Aquilae, was discovered to have a small variation by an observer<sup>2</sup> who was following W Aquilae, and the variation was later confirmed by E. C. Pickering.

An interesting case, and one not so satisfactory, is that of *BD 22° 3272*, to which attention is called by Becker in *Astronomische Nachrichten* 3281 as being a suspicious object. While observing with the meridian instrument he found that the above star, which has magnitude 8.9, was not visible in the Berlin transit instrument of seven inches aperture, while another star near by was visible. Neither could the missing star be found in the eighteen-inch refractor of the Strassburg Observatory. On the other hand, a letter from Professor Küstner at Bonn stated that the region had been observed three times in the process of forming the *BD.* catalogue, and the original records showed that undoubtedly the two stars were then visible. The *Harvard Catalogue of Variable Stars*, in its remarks concerning this star, which is called RW Herculis, states that a faint object which had been observed near its position by Kobold had not been found to vary, and that eleven photographs taken between the years 1890 and 1904 showed only a very faint star with no certain variation. Visual estimates of the magnitude made at Harvard showed it to be 12.0 mg., without any sure evidence of change.

An interesting and almost unique instance of the discovery of a variable by the meridian photometer is mentioned by Professor Pickering in the *Harvard Circular*, No. 87. While working with the twelve-inch meridian photometer he observed a bright star having magnitude 9.5, which was not in the *BD.* An examination of the photographs of this region

<sup>1</sup> S. C. Chandler, *Ast. Jour.*, 9, 49.

<sup>2</sup> C. E. Furness, *Ast. Jour.*, 26, 74.

showed that the star was a variable of long period. This is now SV Herculis.

In *Astronomische Nachrichten* 3219 there is an example of the discovery of a variable by the comparison of photographs. Announcement was made from the Cape of Good Hope by Gill that a comparison of two photographic plates showed a marked difference in the images of a star, which was later confirmed by the examination of a number of other plates. This star is S Velorum.

A very interesting and rapid method of discovering variables is by the use of the stereo-comparator. This instrument was used by Wolf<sup>1</sup> at the Heidelberg Observatory for an examination of the region of the nebula of Orion, during the process of which he discovered ten new variables. A brief description of the properties of this instrument will show how easily it can be used for the discovery of variables. It is constructed so that the light from two photographic plates can be thrown into the eyepiece by the means of several totally reflecting prisms. The light from either plate can be shut off at will, so that the observer can use first one, then the other, or both together, by rapidly moving the shutter by which this is accomplished. He can then easily determine whether the star images on both plates are exactly the same. If a star appears on one plate and not on the other, while other stars are alike on both, the supposition is that it may be a variable. The same region was investigated at the Harvard Observatory<sup>2</sup> by the comparison of photographic plates, and several of Wolf's variables were confirmed, while many new ones were discovered. This led Professor Pickering to arrange for a systematic study of the Orion region and similar nebular regions in the sky. His method is as follows: the glass positive of one of the plates is made, upon which are superposed the negatives of the same region. On the positive the star images are white, while on the negative they are dark; thus a dark image is superposed upon a white one, and any disparity in size will be detected. In this way all

<sup>1</sup> *A.N.* 3749.

<sup>2</sup> E. C. Pickering, *H.C.O., Circ.*, 78.



the variables which show striking changes and are comparatively bright are discovered. In *Circular 79* he announced the discovery of 76 new variables, 19 in Orion and Carina, and 57 in the small Magellanic cloud. Later circulars have contained the announcement of the discovery of many other variables found in the same way. The plates which are mentioned were taken with long exposures. It was found later<sup>1</sup> that other plates taken with a small telescope which covered a region of the sky 30° square and show stars of the 11th magnitude and brighter, would furnish a valuable means of discovering the brighter variables. The same method which has just been described was followed, a thin positive being made of each region, upon which the negatives were superposed. The plates covering the heavens were divided into groups and placed in the hands of the observing corps for investigation. The number of variables which have been discovered by this method is now quite large.

It was stated that a number of variable stars had been discovered from an examination of the spectrum. In *Astronomische Nachrichten 3269* is found an announcement by Mrs. Fleming of the discovery of bright hydrogen lines in the spectrum of a star of the third type. Photographs of this star were then examined which showed a variation in brightness, thus proving the star to be a variable. In *Astronomische Nachrichten 3225*, Pickering announces that four new variable stars have been discovered from the presence of bright hydrogen lines in their photographic spectra. They are all long period variables.

Perhaps the most interesting case is the discovery of a new star by means of its spectrum. This was accomplished by Mrs. Fleming from the examination of negatives made at the Arequipa Observatory. The photograph, which was taken with an exposure of an hour, showed the peculiar spectrum, typical of new stars, in which certain of the hydrogen lines were bright and were accompanied by dark lines of slightly shorter wave-length. Another plate of the same region was

<sup>1</sup> E. C. Pickering, H.C.O., *Circ.* 122 and 127.

examined, which showed a change in the spectrum, further confirming the supposition that it was a new star. The examination was next made of all of the photographs of the region containing this star on a series of 62 plates extending from May, 1889, to March, 1895. No trace of the star was visible, although on some of them stars as faint as the 14th magnitude were clearly seen. Beginning with the plates taken on April 8, 1895, the star appeared, and its photometric brightness diminished from that time from the 8th to the 11th magnitude.

It is from the study of photographic plates also that variable stars in cluster have been discovered on a large scale. This work has been done at the Harvard Observatory in connection with the station in Arequipa, Peru, from which many photographs were taken of dense globular clusters in the southern part of the heavens. The process is related at length in volume 38 of the *Annals*, in which Bailey describes the work on the cluster Omega Centauri. In the introductory pages he gives an account of the discoveries which led to a thorough investigation of this cluster and other similar ones. The first of these variables was found by Pickering in 1889, in Messier 3, and in 1890 two other variables were discovered near the cluster Messier 5. Later in the same year the variability of several other stars near the same cluster was detected. In 1893 a variable star was discovered on the photographs of Omega Centauri by Mrs. Fleming, and a few days later another by Pickering. The detection of these variables among the clusters led to a systematic examination at Arequipa of the finest globular clusters for the discovery of new variables. The first objects examined were Messier 5 and Messier 3, both of which gave remarkable results. A table is presented showing the number of stars examined in each cluster, and the number of variables found, making a total of 19,050 stars, among which 509 variables were found. There is no doubt that this method if extended to all of the clusters in the sky will yield important results. The instances described above show how numerous the methods are by which variable stars may be discovered.

## CHAPTER V

### STELLAR MAGNITUDE

THE history of stellar magnitude begins with the catalogue of Ptolemy, which is the oldest that has been handed down to us, and on account of the importance and age of this work we may appropriately give an extended account of it. Ptolemy's catalogue is contained in the seventh and eighth books of his celebrated treatise on Astronomy called the *Μεγάλης Συντάξεως*, to give it the Greek name, or the *Almagest*, if we use the more familiar name, which the Arabian astronomers obtained by prefixing the Arabic article *al* to the Greek word *μέγιστος*. The date of the catalogue is 138 A.D. Several manuscripts have been preserved for us in Greek, Latin, and Arabic, the best and most perfect being the Greek, in the National Library in Paris. The best printed edition is that of M. l'Abbé Halma, published in Paris in 1816, having the Greek text on one page or column and the French translation on the adjacent one. The catalogue contains 1028 stars, which are divided into 49 constellations. As arranged by Ptolemy it consists of four columns; the first containing the name of the star in the constellation; the second its longitude; the third the latitude, and the fourth the magnitude. As is probably well known to the reader, the ancient and mediæval astronomers always designated a star by its position in the figure representing the constellation. Not all of the stars, however, fell in the regions occupied by the figures, hence they were placed by themselves at the end of the group near which they were situated and were called *ἀμόρφωτοι*, or unformed. There are 102 of these.

The stars and figures were habitually drawn on globes by the ancients. On the title-page of the second volume of Halma's edition of Ptolemy is an illustration supposed to represent the

globe of Hipparchus. A very good picture of the globe used by Tycho Brahe is given in the memorial volume *Tycho's Brahe Astronomiae instauratae Mechanica*, prepared by Hasselberg, in 1901, on the three hundredth anniversary of Tycho's death. The longitudes are given in degrees, counted, however, not from  $0^\circ$  to  $360^\circ$ , but according to the sign of the Zodiac in which the star occurs, each sign containing  $30^\circ$ ; e.g., the star Castor has longitude "Gemini  $23\frac{1}{3}^\circ$ " and since Gemini is the third sign, this is equivalent to  $83\frac{1}{3}^\circ$ . Since in Greek, as in Latin, numbers were represented by letters of the alphabet, the magnitudes are called  $\alpha, \beta, \gamma, \delta, \epsilon, \zeta$ . It would appear from this that Ptolemy did not recognize fractional magnitudes, but we find that he was aware of the gradations in brightness between the whole magnitudes, for the words *μείζων* and *ἐλάσσων* were occasionally attached to the letters representing the magnitudes, the former to show that a star was brighter than the average star of its magnitude and the latter that it was fainter, thus in reality giving the magnitudes to thirds. This fact is of great importance in the study of magnitude if we are to consider these earliest estimations of scientific value in determining changes in brightness, and it is necessary to investigate carefully what Ptolemy's divisions stand for according to modern standards. This has been done very thoroughly by Dr. C. S. Peirce and the results published in the *Annals*, H.C.O., 9. He examined first the various manuscripts in order to compare the readings for *μείζων* and *ἐλάσσων*, which may be abbreviated *m* and *e* respectively, and formed a table containing the magnitudes for Ptolemy's groups 1, 1e, 2m, 2e, 2m, etc. Later in *Annals*, 14, another comparison of 757 of these stars was made by Pickering, and the magnitudes obtained according to the *Harvard Photometry*. They are as follows:<sup>1</sup>

Ptolemy:	1	1e	2m	2	2e	3m	3	3e	4m	4	4e	5m	5	6
Harvard:	0.5	1.2	1.2	2.1	2.6	2.7	3.3	3.8	3.8	4.4	4.6	4.7	5.0	5.4

Ptolemy's magnitudes were adopted without revision by astronomers who followed him except in the case of Al Sûfi the

<sup>1</sup> *Annals*, 14, 343.



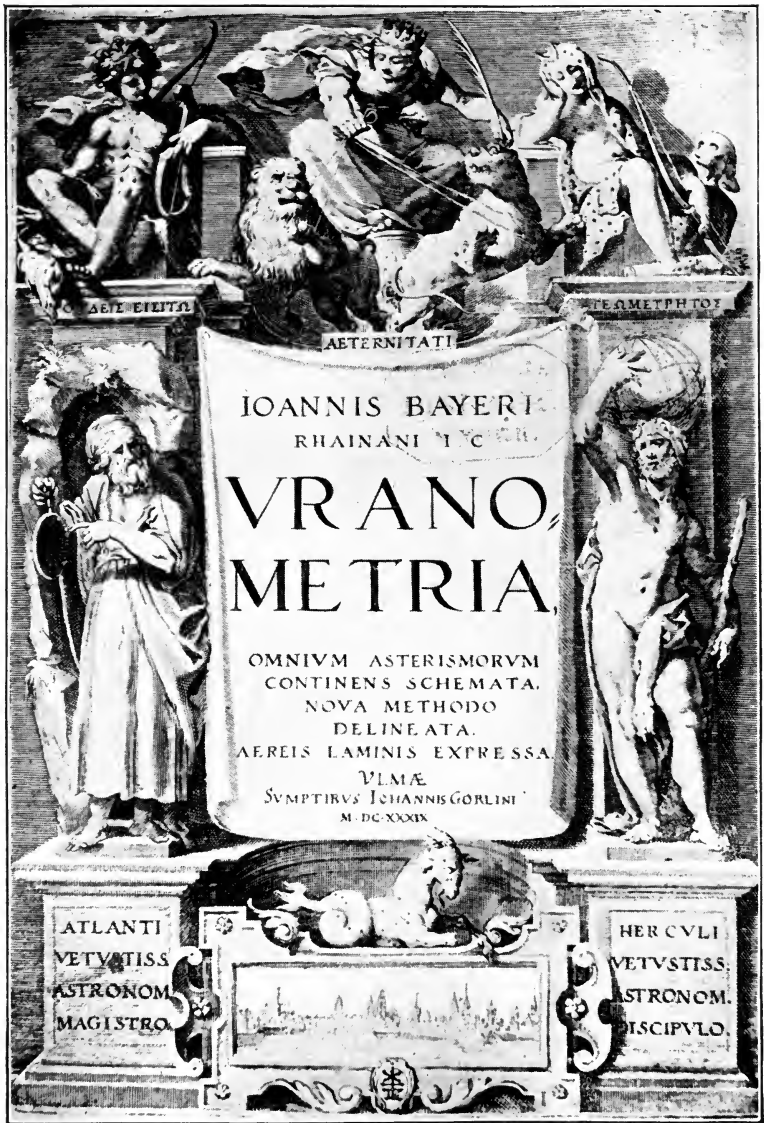

Plate III

(VRANO METRIA) FRONTISPIECE FROM BAYER'S URANOMETRIA, 1639

Persian astronomer, living in the tenth century, who revised them with much care. Ptolemy's magnitudes were used by Ulugh Beigh in a catalogue published about 1437 and by Tycho Brahe, whose catalogue of 777 stars was published in 1602.

The next important advance in the cataloguing or charting of stars is connected with the name of Bayer. It has been stated that the stars were always depicted on solid globes which represented the outside of the celestial sphere, and the maps also were so drawn. Bayer in 1603 conceived the idea of printing the stars on charts which represented the inside of the celestial sphere, thus reversing the directions east and west. This was a great convenience, but he also performed another task which was of even more service; *viz.*, he assigned Greek letters to the stars as names, instead of continuing the clumsy notation of denoting them by describing their positions in the figures of the constellations. He used as a basis Tycho's catalogue of 777 stars, to which he added 500 more, locating the latter not by direct observation, but by estimating their positions from the other stars. It is no surprise to us to learn that the innovation of reversing the direction in his charts of the heavens aroused much unfavorable comment, though its convenience must have been obvious. There is some question as to the method Bayer used in assigning his letters, but the statement is that he gave them to the stars in each of Ptolemy's classes of magnitudes in the order in which they occur in the constellation,<sup>1</sup> somewhat as follows: first to all of the stars in the first or  $\alpha$  magnitude in the order in which they occur in the figure representing the constellation, beginning usually with the head; second to all of the stars in the second or  $\beta$  magnitude, and so on. But he did not arrange the stars in the entire constellation in their order nor assign the names to them on that basis. It is difficult to verify this statement, since early editions of his charts are not easy to find. The question was discussed at length by Argelander in his *De fide Uranometriæ Bayeri*, but

<sup>1</sup> Benjamin A. Gould, *Uran. Arg.*, 51.

the present writer was unable to procure a copy of this work for comparison. The following table is of interest, because it gives the stars in the constellation of Gemini taken from Tycho Brahe's catalogue, with the letters inserted by Baily as given by him in a valuable paper in the *Mem. R.A.S.*, 13. The accompanying plates show the title-page of an edition of Bayer's atlas printed at Ulm in 1619, and one of the constellations, Gemini. It is pleasant to note that the drawing for this lively pair is from the hand of no less an artist than Albrecht Dürer, who drew figures of the constellations in 1515 which were in general use by astronomers and map makers. This one and several others may be seen depicted on the ceiling of the Grand Central Station in New York City. The reader is advised to follow the map of the twins star by star along with the names of Tycho. It will be seen that there is not strict correspondence, which is probably due to the fact that we have not placed together the combinations which Bayer used. The title-page is well worth study merely as a product of the early printer's art. The English of the following list is taken from an old treatise on Astronomy published by Vincent Wing in London, 1651, and entitled *Harmonicon Celeste*.

	Mag.	Bayer.
In the upper head, Castor, Apollo.	2	$\alpha$
In the lower head, Pollux, Hercules.	2	$\beta$
In the left hand of the former twin.	5	$\theta$
In the left shoulder.	4	$\tau$
In the shoulder blade of the same.	4	$\iota$
In the right shoulder.	5	$\nu$
In the left shoulder of the following twin.	4	$\kappa$
In the right side of the former twin.	6	A
The little star in the left elbow of the higher twin.	6	b'
In the northern and upper knee.	3	$\epsilon$
In the left knee of the following twin.	3	$\zeta$
In the belly of the southern twin.	3	$\delta$
In the hamme of the lower twin.	4	$\lambda$
The first in the foot of the former twin.	4	$\eta$
The following star in the same foot, call'd the heel.	3	$\mu$
In the end of the right foot of the former twin.	4	$\nu$
The light star of the foot.	2	$\gamma$





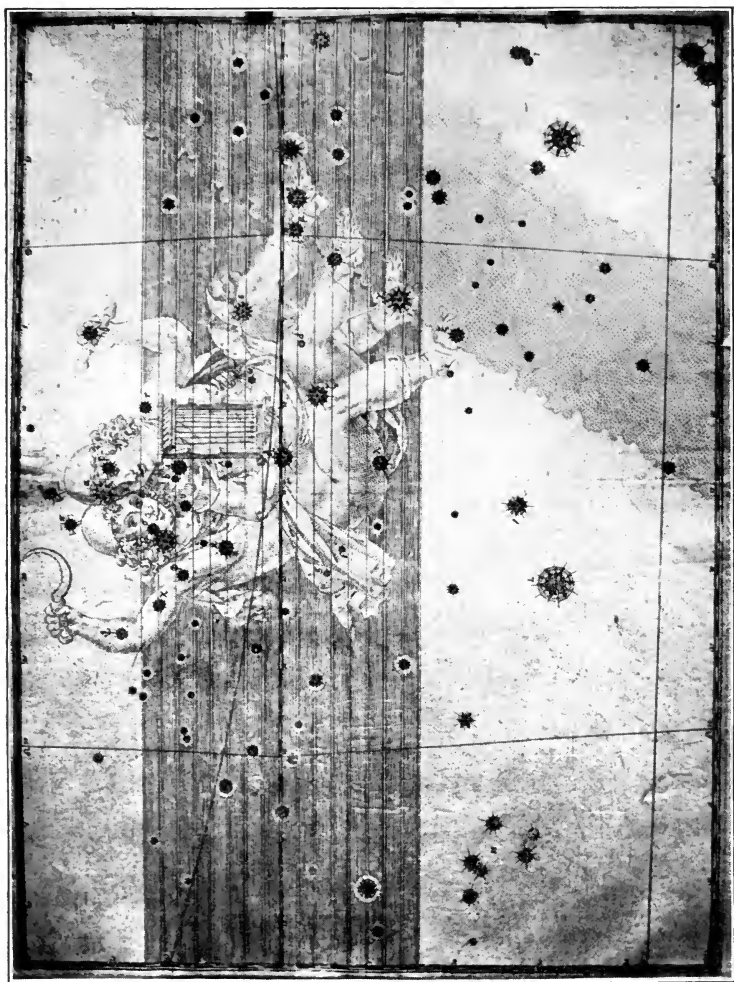

Plate IV

THE CONSTELLATION GEMINI FROM BAYER'S URANOMETRIA, 1639

In the lower foot of the following twin.	4	ξ
In the heel of the same foot.	6	e
Above the knee of the lower twin.	6	d
In the thigh of the higher twin.	6	ω
Beneath the head, lower in the hand.	6	φ
The little star between both heads.	5	σ
About the ear of the higher twin.	5	ρ
The former at the top of the foot.	4	—

It may be noted that Bayer has represented the twins as facing the observer, which is indeed the correct way to place them when they are on the inside of the celestial sphere, since on the globe showing the outside of the sphere they are seen from the back. This latter fact can be verified from the picture of Tycho's globe found in his book of instruments mentioned above.

The first important work of recent times on magnitude was done by William Herschel, that fertile-minded and original genius. In this as in many other of his achievements he suggested the idea without carrying it out to its completion, leaving for others the opportunity to make it of practical and immediate use. His first paper was published in the *Philosophical Transactions*, 76, 1796, from which the following extracts are taken. The title of his paper is "On the Method of observing the Changes that happen to the fixed Stars; with some Remarks on the Stability of the Light of our Sun. To which is added, a Catalogue of comparative Brightness, for ascertaining the Permanency of the Lustre of Stars." He begins by stating that there is great confusion in giving magnitudes to stars, since reference is made to an imaginary standard which is the average magnitude of a class, and the stars are not compared with one another. In examining them he found that a star in one class might be brighter than one in a higher class, or a star of so-called fourth magnitude might be fainter than one of the fifth. So many discrepancies occurred that either there had been many changes in magnitude since the time of Flamsteed, or else the assignment of magnitudes was full of error. At that time intermediate magnitudes between whole numbers were

designated thus: 1.2, between first and second, but nearer first; 2.1, between first and second, but nearer second, making practically a division into thirds. After calling attention to many suspicious cases, he suggests the following improvement in the method of notation. Instead of giving an exact magnitude to a star, he places a few stars in a series based upon their order of brightness. For example, *CDE* signifies that *D* is intermediate in brightness between *C* and *E*, which are neighboring stars not too different from *D* in brightness. By extending the series to six or seven stars, the brightness of any one star becomes even more definitely fixed. He then further developed a plan for representing by arbitrary symbols certain degrees of difference between pairs of stars. The reader who is familiar with Argelander's step method of comparing variables, will recognize this method of Herschel as its prototype.

When two stars are perfectly alike in brightness, so that by looking often and a long while at them, I either cannot tell which is the brightest, or occasionally think one the largest, and sometimes, not long after, give the preference to the other, I put down their numbers together, only separated by a point. . . . However, it can happen but very seldom that the equality in the lustre of two neighboring stars is so perfect as not to leave an inclination to prefer one to the other; therefore I place that first which may probably be the largest, even though I do not particularly judge it to be so. But this preference is never to be understood to extend so far as to make it improper to change the order of the two stars.

Continuing in this manner, he describes his other steps, and finally introduces a table of symbols: —

- ‘ The least perceptible difference less bright.
- . Equality.
- , The least perceptible difference more bright.
- A very small difference more bright.
- , A small difference more bright.
- A considerable difference more bright.
- Any great difference more bright in general.

When two stars differ so much in brightness that one or two other stars might be put between them, and still leave sufficient room for distinction, they become partly unfit for standards by which the lustre of other stars can be ascertained.

There exist symbols indicating other degrees of difference in brightness, but enough has been quoted to show the extent to which Herschel had developed his method. He has also a series of marks which indicate a wavering of star-light and describes quite vividly the occasions on which he used them.

Sometimes, when I was not willing to put down these compound marks, I have cast my eyes upon the ground, and after a few moments lifted them quickly up to the stars *AB*, and instantly decided which of the expressions ought to be used; this being repeated perhaps a dozen or more times, I took that expression for the most proper one which would occur oftener than any other in these transitory glances.

He also calls attention to various subjective errors which must be avoided in making these comparisons.

This introduction is followed by the *First Catalogue of the Comparative Brightness of the Stars*, which contains series of stars in nine constellations. No attempt is made to arrange them all in order, or to form a catalogue of magnitudes, and only the separate series are published, which furnish material for the purpose of forming a catalogue. Four such series were published by Herschel. Two others existed in manuscript form and were given into the hands of Professor Pickering for publication. An investigation of them is given in *Annals, H.C.O., 14*, where the values of the three symbols most frequently used by Herschel are found. These were the period, the comma, and the dash, which have respectively the values .06 mg., .23 mg., .38 mg. The results have been arranged in catalogue form, and are published in *Annals, H.C.O., 23, 188, et seq., Table LIV*. A discussion of his work follows, in which Pickering states that "Herschel furnished observations of nearly three thousand stars, from which their magnitudes a hundred years ago can now be determined with an accuracy approaching that of the best modern catalogues. The average difference from the photometric catalogues is only  $\pm 0.16$  mg., which includes the actual variations of the stars during a century, as well as the errors of both catalogues."

We now come to the great work of Argelander on stellar

magnitude, and the author has difficulty in deciding how much of it to include in the present chapter. However, since it is in the *BD.* catalogue that magnitudes expressed in tenths are first introduced, it may be of considerable value to give an historical account of the development of his method. The material for this account may be found in a letter from Schönfeld to C. S. Peirce<sup>1</sup> written about twenty years after the completion of the work.

It should be stated as a preliminary that earlier astronomers, beginning with Ptolemy, recognized the fact that there are magnitudes intermediate between those represented by whole numbers; that is, that the eye is sensitive to smaller differences in brightness than are indicated by the ordinary divisions. Ptolemy, as stated before, made use of the two words *greater* and *less* to show these differences, thus practically introducing thirds of magnitudes. Later astronomers, among them Flamsteed and Herschel, used the combinations 1.2 and 2.1 as intermediate between 1 and 2, meaning that 1.2 was brighter than the average star of the second magnitude, and less bright than a star of the first, but nearer in brightness to the star of the first magnitude. Similarly, 2.1 meant that the star was intermediate in brightness, but nearer to the standard second magnitude star. Thus again thirds of magnitudes were recognized. The reader is particularly cautioned not to regard the periods in the expressions 1.2 and 2.1 as decimal points.

Some of the star catalogues, for example, that of Lalande, for the epoch 1800, give the brightness in whole and half magnitudes, as 6,  $6\frac{1}{2}$ , 7,  $7\frac{1}{2}$ , etc., and this method was quite customary among astronomers when Argelander began his photometric work. His first research was the *Uranometria Nova*, published in 1843. According to the title-page it is a representation of the stars visible to the naked eye in middle Europe, according to their true magnitudes taken directly from the sky. It consists of a series of seventeen charts and a small book containing a description of the charts and a catalogue of the stars. It

<sup>1</sup> *Annals*, H.C.O., 9, 27-28.

served as a model for the work of Heis. There are 3256 objects delineated, including stars, nebulae, and clusters. There are nineteen degrees of brightness, from the first to the sixth magnitude, including three for each class. While Argelander does not describe in detail his method of determining these magnitudes, he states in his usual vivid style that he began his task in 1838, and worked on it diligently until the time of publication, making repeated comparisons of the stars among themselves. He made use of the ordinary six classes, calling the faintest stars which he could see distinctly of the sixth magnitude, saying modestly, "My eye is of ordinary sharpness; a weaker one will not see the smaller stars of my sixth magnitude, and a stronger one will perceive many which remain invisible to me." He had in mind not only the professional astronomer, but also the amateur, whom he calls "der Liebhaber der Astronomie," and says that he aims to give a true representation of the relative brightnesses of the stars of his own time, in order that his successors might be able to decide whether individual stars had changed their light. Space does not permit of further quotations, but there is a charm and simplicity about Argelander's introductory statements which make them delightful reading. The drawings for his constellation figures were taken from Bayer's *Uranometria*.

We pass now to the account of the work on the *Durchmusterung* magnitudes, contained in Schönfeld's letter to Peirce, mentioned on an earlier page. The zone observations for the great catalogue were made with a small telescope of three inches aperture, as described in an earlier chapter, while the later zones for the purposes of revision were made with larger instruments. The catalogue was published in three sections, and the method of estimating the magnitudes in them changed, as the observers gained in experience, and also as they reached regions of the sky where the stars were fewer in number and did not require such rapid observing. It was originally the plan to estimate the brightness in half magnitudes, and they adopted the scale 1 mg., 1.5 mg., 2 mg., 2.5 mg., etc., but still

used the symbols 1.2 and 2.3 to denote the magnitudes between 1 and 2, 2 and 3, etc., which in this case were the exact half magnitudes 1.5 and 2.5. The work was begun in 1852, and toward the end of the year 1854 Schönfeld and Krueger, Argelander's assistants, who made by far the greater part of the observations, began to take account of a perceptible difference from a half magnitude; for example, if a star belonged to the faintest among those classified as seventh magnitude, that is, was less than the division 7.8 or 7.5 mg., it was distinguished by the addition of the letter *s*, *schwach* (faint), or 7.8*s*, which made it a little fainter than 7.5 mg., or the equivalent of 7.7 mg. Similarly a star which belonged to the brighter half of the class was designated by *gt*, or *gut*, and 7.8*gt* meant a star somewhat brighter than 7.5 mg. or 7.3 mg. Without mentioning further details, it is sufficient to say that the magnitudes at observation were divided into six parts, and the following table shows the correspondence between their designations and the ordinary scale of tenths of magnitudes.

7 <i>m</i>	6.9, 7.0, 7.1 mg.
7 <i>s</i>	7.2
7.8 <i>gt</i>	7.3
7.8	7.4, 7.5, 7.6
7.8 <i>s</i>	7.7
8 <i>gt</i>	7.8
8	7.9, 8.0, 8.1

In explaining why three tenths were included in one group, Schönfeld states that it was not so easy to make the distinction of .1 as of .2 in the midst of observing; *i.e.*, to distinguish 7.3 from 7.5 was easier than from 7.4, and besides, the stars often came so rapidly that the observers had no time to write the necessary notes. Hence it resulted that in the regions where the stars were fewer, more fine differences were noted than with stars in the Milky Way.

In the year 1857, when the observers had reached the more northern declinations, and the stars were on the average less numerous, they became accustomed to distinguish tenths of



magnitudes directly. But it was noticeable that the fractions .1, .6, and .9 occurred less frequently than the others, especially .1 and .6. The magnitudes which were published in the *BD.* are the means of the separate determinations, some of them depending on two observations and some on three. When they rested on two observations, the tenth was chosen so that the star in general was placed fainter than the arithmetical mean, for example, if a star at one observation was called 8.9, which is equivalent to 8.5 mg., and at another 9, the mean, which would be 8.75, was called 8.8 and not 8.7. As a result of this variation in the method of determining the magnitudes of the *BD.*, it appears that they are not homogeneous throughout the entire catalogue. However, in spite of this, they are very much more precise than those found in any of the preceding catalogues.

Several investigations have been made by different astronomers for the purpose of reducing the *BD.* magnitudes to a uniform photometric scale, but there will be no opportunity for presenting them in this volume.

While working on the catalogue, Argelander was on the lookout for possible cases of variability. In the earlier zones there were frequently rather large differences between the estimates of magnitude in the different zones, but later this seldom happened. If any such did occur, the star was at once investigated, and if the divergences persisted, the variability of the star was considered as fairly well established.

The remaining extended investigation of stellar magnitude made without a photometer was that undertaken by Gould at the Cordoba Observatory, and called by him the *Uranometria Argentina*. The introduction contains a very spirited account of his work and the difficulties under which he labored in carrying it out. The last paragraph of his preface shows us how deeply influenced he was by the spirit of Argelander:—

During all the stages of this undertaking, and the not small discouragements which have attended it, I found incentive and support

in looking forward with hopefulness to the approbation of the great master in this department of astronomy. The coveted privilege has not been granted me, to lay at his feet the finished work. But, in justice and in gratitude, I desire to record my obligations to him for counsel and encouragement, direct and indirect. To Argelander, living, I desired to inscribe this work, which but for his *Uranometria Nova* might never have existed. Now I may only dedicate it to his honored memory.

Gould had been summoned by the Argentine Republic to establish a national observatory at Cordoba, several hundred miles inland from the city of Buenos Aires. He arrived there during the year 1870 with four young men who were to act as his assistants, and with no luggage except his personal belongings, the war then raging in Europe having interfered with the shipment of boxes containing astronomical books. No instruments were at hand except opera-glasses, and the transit instrument which was to be the basis of the principal work of the observatory was not put in place for nearly two years. It appeared to him that the energies of his party could not be better employed than in determining the relative magnitudes of the southern stars, for the formation of an Uranometry similar to that of Argelander. By means of a star catalogue which he had with him, he plotted the positions of the brighter stars upon skeleton maps, and inserted the fainter stars from direct estimation in the sky. He desired to base his scale of magnitudes as far as possible on that of Argelander, hence he selected as a standard zone the belt which has for its central line a declination having the same altitude at Cordoba and Bonn. This was  $+ 9^{\circ} 39' 15''$ . He wished to express his own magnitudes in tenths, but as the *Uranometria Nova* gave them only in thirds, he was unable to make more than a general correspondence between the two scales. The stars in this belt which were selected as standards were observed by all of his assistants; only those were utilized upon which all four agreed, and they were observed most elaborately throughout the whole circumference of the heavens. During this process he discov-

ered that the scale of the *Uranometria Nova* was not homogeneous throughout the region observed, nor did Argelander make very precise determinations of the intermediate grades of magnitude. He also found that in the clear air of Cordoba stars could easily be seen which were fainter than those selected as sixth magnitude at Bonn. He finally fixed upon 7.0 mg. as the faintest generally visible. There were 722 standard stars, and the entire catalogue contains 7730 south of declination  $+10^{\circ}$ . Besides the establishment of standard magnitudes Gould found that it was necessary to rectify the boundaries of the southern constellations. During the course of his researches he found many stars which showed signs of variability, and made them special objects of observation. Lack of time, however, prevented him from following them as closely as he would have wished.

Having given in the preceding pages a general survey of the earlier work on magnitudes, previous to the introduction of photometric apparatus and the more exact methods of the last thirty years, there remains to the author the task of showing the connection between the relative brightnesses of the stars and their magnitudes. While it would be interesting historically to give all the steps which led to the formation of the present formula, it is possible to give only a brief resumé, and then to devote some time to examples of its application. The problem may be stated in the form of a question, the necessity of an answer to which will be obvious. The magnitudes assigned to the stars proceed in order as the stars diminish in brightness. Is there a definite relation between the brightness of a star of one magnitude and that of a star of the next succeeding magnitude? The question may be put more specifically. In what ratio does the brightness of the stars change as we pass from the first to the second magnitude or from the second to the third? Is there any definite relation or is it just a matter of chance? Were the stars divided into magnitudes according to some general scientific scheme or was it merely at the convenience of the early observers? The answer to this question, in

whatever form it may be put, is obviously of great importance to the astronomer.

Hipparchus, 127 B.C., was the first to form a star catalogue and assign magnitudes to the stars. His results have been preserved to us by Ptolemy, but we are not aware on what principle he made the division. Obviously he grouped all the brightest stars in the first magnitude; the faintest stars he placed in the sixth, and those intermediate in brightness he distributed in the other classes. Whether it was a matter of accident that he chose six classes, or whether he had a definite idea of a light ratio in making the division we do not know. Ptolemy is silent on the subject, and it seems probable that if there had been a governing principle he would have stated it. In any case, for centuries the magnitude of a star remained only an incidental piece of information to assist in identifying it, and not until the time of Herschel, when variation in stellar light was being closely studied and he was making comparison of the brightness of the stars, did the matter become one of importance. With the growth of photometric work it became necessary to investigate this relation, with the result that we have a very definite formula, known as Pogson's rule, which is as follows:—

Let  $A$  be the brightness of one star,  
 let  $B$  be the brightness of a second and fainter star,  
 let  $\Delta m$  be their difference in magnitude;

$$(1) \quad \text{then } \frac{A}{B} = (2.512)^{\Delta m}.$$

If we place  $\Delta m = 1$  we find that a star of one magnitude is 2.512, or approximately  $2\frac{1}{2}$  times as bright as a star of the next lower magnitude, and that this holds everywhere on the entire scale; that is, there is a constant ratio existing between the brightnesses of stars of successive magnitudes. A few facts in the history of the derivation of this number may now be given.

Sir John Herschel<sup>1</sup> was one of the first to formulate some such numerical relation, deducing it from observations made

<sup>1</sup> *Mem., R.A.S.*, 3, 182.

at the Cape of Good Hope. His results were somewhat tentative, and he concluded that the quantities of light emitted formed a series of inverse squares, such as 1,  $\frac{1}{4}$ ,  $\frac{1}{9}$ ,  $\frac{1}{16}$ ,  $\frac{1}{25}$ , etc.; the light emitted being the inverse square of the magnitudes, 1, 2, 3, 4, 5, etc. At another time he said that he thought it better in the case of stars below the sixth magnitude to halve the light of each magnitude to get that of the next lower, thus introducing a geometrical ratio,  $\frac{1}{2}$ , indicating the relative brightness between two magnitudes, as  $\frac{1}{2}$ ,  $\frac{1}{4}$ ,  $\frac{1}{8}$ ,  $\frac{1}{16}$ , etc. There seemed no desire on the part of astronomers to disturb the general assignment of magnitudes due to Ptolemy, since that would involve too great confusion.

I believe this principle, which assigns a decrease of light in geometrical progression, according to the powers of  $\frac{1}{2}$ , while the order of magnitude increases in arithmetical, is preferable to that which would estimate the light by the reciprocal square of the magnitude. . . . From some experiments I have made with apertures of various sizes I am led to believe that the actual ratio of the light of a star of the first magnitude to one of the sixth is at least 100:1; for I found that Sirius, when viewed with an aperture of three inches, was equal to a large star of the fourth magnitude, with two inches, to a star of the 4.5 magnitude, and with one inch its impression on the eye, in spite of the large planetary disk it exhibited under those circumstances, was fully equal to that of a bright star of the sixth magnitude seen with the full aperture of eighteen inches, which would give 324:1; and admitting Sirius to have three times the light of an average star of the first magnitude, we get the ratio above stated.

Other workers in photometry from the beginning adopted the geometrical ratio as the true relation, the question left to them being to find its value. It is generally known as  $\rho$ , so that the formula given above as Pogson's rule should read in general

$$(2) \quad \frac{A}{B} = \rho^{\Delta m}.$$

Several astronomers and physicists began working on the problem. The method of investigation was to select certain stars the magnitudes of which had previously been determined with considerable accuracy; to find by various photometric means their actual light ratio, and then by using the above

equation to find the value of  $\rho$ . Steinheil, in 1835, working at Munich, found from the observation of thirty stars the value of  $\rho$  to be 2.831. In 1851 Johnson, at Radcliffe, found from the observation of sixty stars ranging from 4.1 mg. to 9.7 mg. the ratio of diminution to be 0.424, its reciprocal being 2.358. He also quotes values obtained by several different observers, using instruments varying from a 3.5-inch to a 15-inch refractor and an 18-inch reflector. "Yet their determinations, notwithstanding many and great individual anomalies, present a general appearance of consistence and agreement which can hardly be accidental."<sup>1</sup>

It may be interesting to note them.

Herschel	.407	Argelander	.431
Struve	.383	Groombridge	.388
Otto Struve	.406	Radcliffe	.424

The mean of these is .412, or  $\rho = 2.427$ .

Before referring to the suggestion of Pogson, which led to the final adoption of  $\rho = 2.512$ , it will be convenient to transform equation (2) so as to find the value of  $\Delta m$ , as follows:

$$(2) \quad \frac{A}{B} = \rho^{\Delta m},$$

$$(3) \quad \log \frac{A}{B} = \Delta m \log \rho,$$

$$(4) \quad \Delta m = \frac{\log A - \log B}{\log \rho}.$$

It will be seen that  $\log \rho$  enters as a divisor in the equation when  $\Delta m$  is the value sought. Let us now introduce a few other determinations of the value for  $\rho$  and also their logarithms.

	$\rho$	$\log \rho$	
Steinheil	2.831	0.4519	26 stars
Johnson	2.427	0.3851	(mean)
Stampfer	2.519	0.4012	132
Pogson	2.4	0.3802	
Mean		0.4036	

<sup>1</sup> *Radcliffe Obs.*, 1851, App. 25.

Since these values of  $\log \rho$  differ considerably among themselves, and the mean value is .4036, Pogson decided arbitrarily to adopt the value of 0.4, on account of its convenience as a divisor, thus making  $\rho$  equal to 2.512. It is a curious coincidence that this determination seems to have been entirely uninfluenced by the suggestion of Herschel previously quoted, *viz.*, that a star of the first magnitude was one hundred times as bright as a star of the sixth, for proceeding according to the hypothesis that the brightness changed by a constant ratio we should have in this case

$$\begin{aligned} \Delta m &= 5 \text{ mg.}, \frac{A}{B} = 100, \\ (5) \quad \log \rho &= \frac{\log A - \log B}{\Delta m}, \\ \log \rho &= \frac{\log 100}{5} = \frac{2}{5} = .4, \end{aligned}$$

which is precisely the same result. On account of its general convenience this value of  $\rho$  as adopted by Pogson has found universal acceptance. A few later investigators have made other determinations of the value of  $\rho$ , and efforts have been made to discover if it really is constant, and expresses a law inherent in our psycho-physical natures, but a discussion of these efforts lies somewhat outside the scope of this volume. It should be remembered, however, that in the end, all of these determinations lead back to Ptolemy's classification, which was handed down at first quite unchanged, and later, when improvements were found necessary, it was altered only by internal adjustments, its outer limits remaining fixed. The brightest stars only are an exception to this, because, in order to conform to the general light ratio, they have been pushed out of the first magnitude, as it were, into zero or negative magnitudes, so that we have <sup>1</sup>

<sup>1</sup> *Rev. HP., Annals, H.C.O., 50, 237, Table VII.*

Sirius	-1.58	$\beta$ Orionis	0.34
Canopus	-0.86	Procyon	0.48
Vega	0.14	$\alpha$ Eridani	0.60
$\alpha$ Aurigae	0.21	$\beta$ Centauri	0.86
Arcturus	0.24	Altair	0.89
$\alpha'$ Centauri	0.33	Betelgeuse	0.92

The statement of Johnson that this agreement of results for the values of  $\rho$  cannot be accidental is true, for all of the observers used the same scale of magnitudes for their determination. Hence if the photometric devices employed were correct, the values should agree fairly well, and their uniformity is a test of the method rather than of the validity of the law.

The subject cannot be left without referring to the psychophysical law of Fechner, with which this problem is intimately connected. Briefly stated, Fechner's law is that as a stimulus increases in geometrical progression its resulting sensation increases in an arithmetical progression, but that there is a slight deviation from the extreme rigor of this relation when the stimulus becomes very intense or when it becomes very slight. The relation may be expressed mathematically by the formula

$$S = C \log R,$$

where  $S$  is the intensity of the sensation,  $R$  the stimulus, and  $C$  a constant. In this particular case  $S$ , which is the sensation, is equivalent to the magnitude of the star, and  $R$ , which is the stimulus, is equivalent to its brightness, but as we have no absolute standard for brightness, and can only measure it relatively, we must compare two brightnesses.

Let  $A$  and  $B$  be the brightnesses of two stars, and  $M_1$  and  $M_2$  be their magnitudes. Then

$$M_1 = C \log A,$$

$$M_2 = C \log B;$$

hence

$$M_1 - M_2 = C (\log A - \log B),$$

or

$$\Delta m = C (\log A - \log B).$$



This may be written also

$$\frac{\Delta m}{C} = \log A - \log B, \quad ;$$

$$e^{\frac{\Delta m}{C}} = \frac{A}{B}.$$

Let  
and we have

$$e^{\frac{1}{C}} = \rho,$$

$$\frac{A}{B} = \rho^{\Delta m},$$

which is identical with equation (2), derived before. The value of  $\rho$  may be found as described above.

It should be stated that the derivation of the preceding formula and the determination of the value of  $\rho$  by Pogson had been published before Fechner promulgated his law, which was not until 1859; and the latter himself states that this very relation did much to suggest to him his law, and he considered it the most important confirmation of it. It has just been stated that Fechner's law is not considered rigorous for the extreme values of the stimulus, and in support of this, evidence has been offered from the study of stellar magnitudes showing that this ratio is not absolutely constant throughout the scale. It seems hardly consistent, however, to the author, to base any such reasoning on the study of stellar magnitudes, since at best they are referred to standards which have been determined empirically, and rest ultimately on the classification of Ptolemy. Furthermore, it is not clear that the magnitude is a sensation of which the brightness is the stimulus, because the use of magnitudes seems to be merely a convenient way of classifying the brightnesses, which in themselves are sensations. This is not the place in which to enter into a psycho-physical discussion, and enough has been said to present the problem. It will be better to proceed to illustrate the application of the formula, which is extremely useful.

*Examples of Pogson's Rule*

1. If star  $A$  is twice as bright as star  $B$ , what is the difference in magnitude? Using eq. (4) we have

$$\Delta m = \frac{\log \frac{A}{B}}{\log \rho} = \frac{\log 2}{0.4} = \frac{0.301}{0.4} = .75.$$

The difference in magnitude is .75.

2. If star  $A$  is one hundred times as bright as star  $B$ , what is the difference in magnitude?

$$\Delta m = \frac{\log \frac{A}{B}}{\log \rho} = \frac{\log 100}{0.4} = \frac{2}{0.4} = 5.$$

The difference in magnitude is 5.

3. The faintest star visible in the Lick telescope is of the 17th magnitude. Polaris is the standard 2nd mg. star. What is their relative brightness? Using eq. (3) we have

$$\log \frac{A}{B} = \Delta m \log \rho,$$

$$\log \frac{A}{B} = 15 \times 0.4 = 6.0,$$

$$\frac{A}{B} = 1,000,000.$$

Polaris is a million times as bright as a 17th mg. star.

4. The magnitude of Sirius is  $-1.43$ . Find its light ratio to Polaris. In this case Sirius is star  $A$  and Polaris star  $B$ , and  $\Delta m$  is 3.43.

$$\log \frac{A}{B} = 3.43 \times 0.4 = 1.372,$$

$$\frac{A}{B} = 23.55.$$

Sirius is 23.55 times as bright as Polaris.

5. The variable star Algol loses 1.1 mg. in going from maximum to minimum. What per cent of its total light is lost?

Let  $A$  = light of Algol at maximum = total light,

$B$  = light of Algol at minimum;

then  $\frac{B}{A}$  = ratio of the brightness at minimum to the total light,

and  $1 - \frac{B}{A}$  = amount of light lost,

$$\Delta m = 1.1.$$

From eq. (3)

$$\log \frac{A}{B} = \Delta m \log \rho = 1.1 \times 0.4 = 0.44,$$

$$\log \frac{B}{A} = 9.56,$$

$$\frac{B}{A} = .36,$$

$$1 - \frac{B}{A} = .64.$$

The amount of light lost is 64 per cent of the total light.

6. If at the time of minimum a star has lost one third of its light, what was the change in magnitude?

$$1 - \frac{B}{A} = \frac{1}{3},$$

$$\frac{B}{A} = \frac{2}{3},$$

$$\frac{A}{B} = 1\frac{1}{2} = \rho^{\Delta m},$$

$$\Delta m = \frac{\log \frac{A}{B}}{\log \rho} = \frac{\log 1.5}{0.4} = \frac{0.176}{0.4} = .44.$$

The change in magnitude is .44 mg.

We have also the following table of relations which are of convenient use in making visual comparisons of stars. For example, if we decide that star  $A$  is twice as bright as star  $B$ ,

102 THE STUDY OF VARIABLE STARS

then the difference in magnitude in the sense  $A - B$  is .44. If  $B$  is one third as bright as  $A$  the difference in the sense  $A - B$  is 1.2 mg. Only a few values such as are most likely to be of frequent use are included. Other desired values may easily be found.

$\frac{A}{B}$	$\Delta m$ $A-B$	$\frac{B}{A}$	$\Delta m$ $A-B$
1.5	.44	.75	.31
2.0	.75	.67	.44
2.5	1.00	.50	.75
3.0	1.19	.33	1.20
4.0	1.50	.25	1.50
5.0	1.75	.10	2.50

## CHAPTER VI

### VISUAL PHOTOMETRY

VISUAL observations of a variable star consist in comparing its brightness with that of another star which is supposed to be constant in brightness. They may be made in two ways, first by direct eye estimates of the comparative brightness, either with or without a telescope, and second with the aid of a photometer attached to a telescope. Both are included under the heading "Visual Photometry," since the eye itself receives the light of the star.

A variable star should be compared in precisely the same manner in which a star of constant brightness would be compared, as illustrated by the work of Sir William Herschel; that is, by placing it in a series with at least two other stars and indicating in some way different degrees of variation in its brightness. The method most commonly used is that of Argelander, which is based directly on that of Herschel, its chief difference consisting in the way in which the steps are indicated. It will be remembered that Herschel introduced a rather complicated system of dots, dashes, and commas, to represent successive degrees of difference in brightness. In place of these Argelander uses ordinary numbers, and the varying degrees of brightness he calls "steps," so that his method, which is now in very general use, is called Argelander's step method. Though the main points of it have been described in the preceding chapter, in connection with the work of Herschel, a repetition of them in this place is desirable in order to make the subject complete. It should be stated that the form in use was of gradual development, and that at times Argelander also used symbols to represent steps. These, however, are not recommended to the ordinary observer, and hence are not included in this descrip-

tion. A full account of them will be found in Hagen's *Die Veränderlichen Sterne*. The method has been frequently described, since it is a simple way of making comparisons when no photometer is at hand. Articles on variable stars and hints for making observations have appeared several times in the *Popular Astronomy*, to which the reader is referred for further descriptions.<sup>1</sup>

In selecting the stars with which to compare a variable, those nearest to it in brightness should be chosen. Two at least are necessary, one a little brighter and one a little fainter. The variable and the one with which it is to be compared should be in the field of the telescope at the same time if possible, or at least should not be so far apart as to require much motion of the telescope to bring them into the field in rapid succession. Some recommend that the observer should fix his eye on one star at a time, looking at it intently before passing to the other. There are such frequent fluctuations in the atmosphere, that it is only by this method that he can obtain a distinct impression of its brightness. Alternate observations of the two stars will give a truer impression than a simultaneous observation of both. In making the comparison, either each star must be brought into the middle of the field by moving the telescope, or else they should be placed symmetrically with reference to the middle of the field. In contrast to the above rule, the writer has often found it very useful when observing faint stars to look at both at the same time, using averted or side vision, for the following reason. It is known to every observer with the telescope, that a faint object at the limit of vision can be seen more easily if we do not look at it directly, but to one side, or above it, or if the eye is passed rapidly over it with a sweeping glance. If this is true for one faint star it is equally necessary when comparing two which are at the limit of vision. In observing a red star it is necessary, on the other hand, to take a

<sup>1</sup> J. A. Parkhurst, *Pop. Ast.*, 1.  
P. S. Yendell, *Pop. Ast.*, 13, 14.  
W. T. Olcott, *Pop. Ast.*, 19.

rather prolonged steady look at it, since the impression of its brightness deepens as one looks.

Having selected the comparison star as directed above, and having given the steady gaze, the observer is ready to make his estimate. Since the stars are always fluctuating in brightness, one glance is not sufficient to enable the observer to make a definite decision, hence he should look several times, each time making an estimate and in the end adopting that one which occurs most frequently. As Herschel suggests, when there is very great difficulty in coming to a decision, one should cast the eyes upon the ground, and when they are refreshed look again upon the stars to be compared. This can be done literally only when observing in the open without the telescope, but the principle is the same, and needs no further elucidation. When the eye is tired and the mind is fatigued with its own indecision, a brief rest will bring a quicker decision in its train.

If as a result of such careful comparison, the two stars, which may be called  $a$  and  $v$ , seem to be of absolutely equal brightness, they should be written down  $a 0 v$ , or simply  $a v$ , or  $a = v$ . Also if they do not seem to be equal, but half the time  $a$  appears to be a very little brighter, and half the time  $v$  is the brighter, still the final result will be  $a 0 v$ . This Herschel represented by the period, “.”, as a symbol.

If it happens, on the other hand, that star  $a$  appears the brighter of the two rather more than half the time, but that there is an element of doubt in the observer's mind as to which is really the brighter, while sometimes  $a$  appears equal to  $v$ , then we can say that  $a$  is one step brighter than  $v$ , or  $a 1 v$ , the brighter star being written first. If one star is certainly brighter than the other and yet only very little brighter, the interval is called two steps and written  $a 2 v$ . Sometimes this difference is expressed by saying that one star, and only one, can be intermediate between them in brightness. Three grades represent a difference about which there is no doubt, but still not a great one. The observer can have no difficulty in defining it for himself. Higher than this it is not advisable to go by the simple

step method, as the uncertainty is too great. There are other devices, however, by means of which larger differences can be estimated with considerable degree of accuracy when necessity arises, as it often does when the variable is bright and comparison stars are not numerous. One of these devices is to decide the relative brightness between the two stars; as for instance,  $a$  may appear to be twice as bright as  $v$ , meaning that if another star as bright as the variable were to be added to it, the result would be as bright as  $a$ . From the table in the preceding chapter, built upon Pogson's rule, this will correspond to a difference in magnitude of .75. Or if it is decided that  $v$  is one third as bright as  $a$ , then  $a$  is 1.1 mg. brighter. When estimates are made in this manner, the greatest care is necessary in writing them down. In the first case it would be quite incorrect to write  $a \ 2 \ v$ , since this signifies a difference of only two steps, which is a very much smaller difference; but the full expression,  $a$  is twice as bright as  $v$ , or  $v$  is one third as bright as  $a$ , should be used. The writer has frequently employed this method with satisfactory results.

In making comparisons for the brightness of a variable, more than one star should be used. The best combination is to take two, one a little brighter and one a little fainter. If convenient a third should be added, so as to have as many independent determinations of the magnitude as possible.

The use of two comparison stars, one brighter and one fainter, makes it possible to employ still another method of comparison which was first recommended by Pickering. The two stars selected should not differ more than a magnitude. Let them be called  $a$  and  $b$ . Estimate the brightness of  $v$  in tenths of the interval from  $a$  to  $b$ . Thus if  $v$  is half way between  $a$  and  $b$  in brightness, call it  $a \ 5 \ v \ 5 \ b$ , or omitting  $v$  write  $a \ 5 \ b$ . If  $a$  is not much brighter than  $v$ , we may write  $a \ 1 \ b$  or  $a \ 2 \ b$ , and if the variable is nearer  $b$  in brightness, we should write  $a \ 8 \ b$  or  $a \ 9 \ b$ . This method, while advantageous when it is necessary to employ stars which differ widely in brightness, is not in general use. The writer has occasionally used a modification of it as



follows: instead of dividing the interval in brightness between  $a$  and  $b$  into ten parts, any convenient unit may be used, for example, if the variable seems to be two fifths of the difference in brightness from  $a$  it could be written  $a\ 2\ v\ 3\ b$ .  $a\ 3\ v\ 4\ b$  would show that  $v$  is three sevenths of the difference fainter than  $a$ . Variations are thus quite permissible, so long as the method of notation is fully understood.

Another method, that of estimating the magnitude directly, also devised by Pickering, is used at present at the Harvard Observatory, and recommended by him to other astronomers. In order to employ it, however, the maps must be specially prepared. This is done by attaching to each comparison star its magnitude, omitting the decimal point to avoid confusion with the faint stars. The magnitudes are taken from the photometric measurements especially carried on for the purpose, the results of which are published in the various H.C.O. *Annals*. These charts may be had by any observer from the Harvard Observatory. This method has been found very successful and expeditious at Cambridge. The chief criticism that can be made is that there is no possibility of discovering a mistake by going back to the original comparison to see if a wrong star has been used. It has also been objected that if there should at some time be a change in the magnitudes assigned to the comparison stars, it would not be possible to correct the observations, since it would not be known which stars had been used. To this Pickering replied that if they were changed, a curve could be drawn which would show the differences between the two systems of magnitudes, and corrections could be applied to the resulting magnitudes of the variable. The writer would venture to say by way of comment, that while the above method is very suitable to observers on the staff in Cambridge, it is not so satisfactory to the ordinary observer, who may wish to find the steps of his comparison stars, or who wishes to have them in his record.

Various modifications of Argelander's step method have been introduced by different observers. A full treatment may be

found in Hagen's *Die Veränderlichen Sterne*, chap. x. It has not been thought necessary to give them here.

Mention may be appropriately made at this point of some of the precautions which must be observed in making these comparisons. Some of these precautions relate to the color of the star, and others have to do with the instrument and atmospheric conditions.

Connected with color we have two well-known phenomena which are called respectively the Purkinje phenomenon and that of Dove. A simple way of stating the former is as follows: if the observer starts with two equal red and green lights and increases them both in brightness in the same degree, the red light will appear brighter than the green one, and if they are diminished, the red will grow faint more rapidly, that is, the red light changes more rapidly, both in increasing and in diminishing. This is easily illustrated by watching articles in a room as it is growing dusk. If there are two books in a case, one bound in red and the other in green, appearing equally conspicuous in ordinary daylight, as the room grows darker the green one will remain visible longer than the red one; and conversely, if at the other end of the day, an observer is minded to watch them in the early light of dawn, the red will be seen to grow bright more rapidly. This fact bears directly upon the observation of long period variables, since many of them are quite reddish in color. As one of these approaches maximum, *i.e.*, grows brighter, it will have a different rate of increase from a white star, and will appear brighter than a white star which increases intrinsically at the same rate and to the same amount. However, there is no way in which this difficulty can be overcome. All that can be done is to select a red comparison star whenever that is possible, and further than this to make comparisons as carefully as possible, taking a long look at the reddish star, as by so doing its brightness becomes more vivid. Care should also be used in combining observations made with different telescopes. If two stars of which one is red are observed together, first with one telescope, and then with one of larger aperture, the Purkinje

phenomenon is exactly reproduced, because we have objects of different colors viewed first with one degree, and afterward with another greater degree, of illumination. The relative difference will be greater in the first case than in the second, therefore in the case of a red star, the same telescope should be used throughout the observations. Attention is called to the fact that while stars are never green, and rarely bluish, the difference between a red star and a white one is of the same order as that between a red and a green one.

Dove discovered that the brilliancy of the background has an important effect upon the relative brightness of different colors. When the background is very bright, the red star is the brighter, and when it is relatively faint or dark, the bluish object appears brighter. This has an astronomical bearing, since observations made during bright moonlight or twilight will present colors against a brilliant background, and hence make a red star the brighter.

Other precautions depend upon the position of the stars in the field of view of the telescope. A star near the edge of the field appears brighter than one in the middle, therefore, when the two to be compared are not far apart, they should be placed at equal distances from the center of the field. When this is not possible, each star should in turn be brought into the center of the field and looked at steadily until a distinct impression of its brightness is obtained.

Another error not so easily avoided arises from what is called the parallactic angle, meaning the angle which the line joining the two stars makes with the vertical to the horizon. A star which is lower in the field usually appears brighter, and some observers, for instance, Yendell, make the difference as great as half a magnitude. The reason is fatigue of the retina, and is explained as follows. The image on the retina is inverted. During the daytime, the light from the sky falling upon the lower part of the retina fatigues it, as does also most artificial light at night, since electric and gas lights are in general suspended from the ceiling. Darker objects such as furnishings, trees, etc.,

form their images on the upper part of the retina and do not fatigue it as much. Hence when the eye is used for observation at night, the light from the star in the lower part of the field falls upon that part of the retina which is least fatigued, and hence appears brighter than a star in the upper part of the field. That the physiological effect varies with the observer is doubtless true, since there is a difference in the native strength of the eye, and also in the daily surroundings depending upon the ordinary occupation, which may tend to obviate this difficulty. At any rate some observers do not find it so marked as others. The best way to surmount it is to turn the head so that the line joining the eyes is parallel to the line joining the stars. The same effect is produced by using a reversing prism which may be adjusted so as to change the position of the line joining the stars.

Other precautions are of a different character. Flying clouds and moonlight are to be avoided, especially the former. Doubtful observations should be rejected at once. The eye should have complete rest in a darkened room for about ten minutes before beginning to observe, at least after having been used in a brightly lighted room for reading. To illuminate the paper for making the record, some recommend the use of a lantern covered with red, which is just bright enough to allow the observer to study the star maps and to see to write.

Other causes of error to be avoided will be mentioned in the chapter entitled "Hints for Observers."

We pass now to the description of several different kinds of photometric apparatus which have been devised to assist the observer in making visual comparisons. In order fully to understand their construction it will be necessary to consider some of the underlying principles of physics upon which they are based. In the introductory chapter there was given a statement of the principle of refraction, on which the construction of the spectroscope is based, and also an account of the wave theory of light. It was there stated that a ray of light, in passing from a medium of one density to that of another, is bent with reference to the

normal at the point of incidence. In passing from a rarer to a denser medium it is bent toward the normal, and in passing from a denser to a rarer medium it is bent from the normal. The law according to which this deviation takes place was discovered in 1621 by Snell, and is expressed by the following formula: —

$$\frac{\sin i}{\sin r} = n,$$

that is, the ratio between the sine of the angle of incidence and the sine of the angle of refraction is constant for any two given media. When air is the rarer medium  $n$  is called the index of refraction. This law was later found to be not quite rigorous, for the index of refraction varies slightly with the temperature, barometric pressure, and wave-length of the incident ray. Hence when the value of  $n$  is given it is understood that standard conditions, *i.e.*, 760 mm. barometric pressure, 0° C. temperature, were employed, and that white light was used. This bending of the ray of light usually has no effect upon the wave motion which causes it. When the incident beam falls upon an ordinary transparent substance its ether particles are vibrating in all directions at right angles to that in which the wave motion is being propagated. After it emerges and the direction of propagation has been altered, the ether vibrations are still perpendicular in all directions to it.

More careful examination shows that there are some substances which do affect the vibrations in the light waves, so that when they emerge they are no longer transverse in all directions, but are confined to two, which are at right angles to each other. One of these substances is a colorless crystal called Iceland spar, which is a natural crystal, bounded by six plane faces, lying parallel, two and two. If a beam falls upon one of its faces at right angles, two beams are seen to emerge from the opposite face, which are equally bright, but each of which has half the brightness of the incident beam. One of these follows the direction of the normal, thus obeying the ordinary law of refraction, while the other is displaced to one side. This phe-

nomenon is known as double refraction, and produces very interesting results when the crystal is rotated. They may be studied by placing the crystal on a table over a piece of white paper on which is a black pencil dot; or better still, by allowing a ray of sunlight, which enters through a small round aperture, to pass through the crystal and fall upon a screen suitably placed. The crystal should then be rotated in the plane in which it is set, *i.e.*, if placed on a table, it should be kept flat during rotation. When this is done, the beam which emerges in the direction of the normal remains unchanged in position, while the other circles about it. Thus the one ray behaves in a perfectly normal manner, while the other is refracted differently, and its displacement seems to be connected with the position of the crystal. If the crystal is inclined to the incident beam the one ray still continues to obey Snell's law in the ordinary manner, and hence is called the *ordinary ray*, while the other is refracted at angles which differ according to the angle of incidence, but do not obey the law. Since this ray behaves in this unusual manner it is called the *extraordinary ray*. The index of refraction of the ordinary ray is found by the usual manner, while that of the extraordinary ray is more complicated, and depends upon the path of the rays with reference to the form of the crystal.

It is not necessary for our purpose to investigate this matter further. We may pass on to the phenomena which take place when the beam of light passes through a second crystal of spar, an experiment which was first performed by Huyghens. He found that each of the two rays emerging from the first crystal, after passing through the second, was divided into two others, making four in all; but that the four were of unequal brilliancy, the relative brightness depending upon the position of the second crystal. Before describing this effect more in detail it is necessary to mention some further facts in regard to the crystal itself. Iceland spar crystallizes in different forms, but can readily be split into small crystals of a certain definite shape, breaking along certain planes which are called planes of cleav-

age. The bounding surfaces are six parallelograms, equal two and two, each one of which has for its face angles two acute and two obtuse angles. There are eight solid angles, two of which are formed by the junction of three obtuse angles. A line which passes through the vertex of one of these angles and is equally inclined to the three adjoining faces is called the axis of the crystal. This axis has special optical properties, which are not altered by the dimensions of the crystal, nor reduced by further cleavage, and may be considered simply as giving a direction in the crystal. We are now ready to study the effect of passing a single beam of light through two crystals of Iceland spar.

Suppose that the beam of light falls perpendicularly upon the first crystal, and that the second crystal is placed so that its axis is parallel to that of the first, in which case the two crystals are said to be parallel. On the screen will appear two spots of light, of equal brightness, and nearly equal to those emerging from the first crystal, the diminution being due only to absorption on passing through the crystals. Now rotate the second crystal ever so slightly. Immediately, two new spots of light which are quite faint appear, while those already present grow less bright. As the rotation is continued the two faint ones grow brighter, and the bright ones fainter, and by the time the rotating crystal has been turned through an angle of about  $45^\circ$  the four images are practically equal. At  $90^\circ$ , when the two crystals are said to be crossed, the images which appeared first have become extinguished, and the new ones have reached their maximum brightness. The four are again equal at  $135^\circ$ ; and at  $180^\circ$  the original ones have reached their maximum brightness, as the crystals are again parallel, and so on. That is, there are four positions in which the images are equal, and four positions in which only two appear, but in the latter case they are in two sets, one pair being identical at  $0^\circ$  and  $180^\circ$ , and the second pair at  $90^\circ$  and  $270^\circ$ . The motions of the four spots of light are also quite complicated, but as they have no particular bearing upon the problem in hand, which is one of measuring the brightness of a star, they require no further description at this

point. The important fact is that a method has been found by which the observer can diminish at will the brightness of a light, until it is equal to another light with which it is compared, or until it is extinguished; in addition, the number of degrees through which the crystal is turned in order to produce the desired effect can be measured exactly and made the basis of further calculations. The practical application of this to photometric apparatus will be described presently, as it is necessary first to give some theoretical explanation of the phenomenon of double refraction.

It is evident that the crystal of Iceland spar has a special effect upon the rays of light passing through it, and when they emerge from it they will not pass through a second crystal freely, but are affected by the relative positions of the two. This is readily explained by a reference to the theory of light waves. The structure of the crystal is such that it will not permit transverse waves to pass through it in all directions, but only in two, which are at right angles to each other. All of the vibrations in the waves forming the ordinary beam are in one direction and all of those in the extraordinary beam are at right angles to it. There is nothing in the appearance of either ray to indicate this, and it is only discovered when they fall upon the second crystal, and are split up into components, parallel to the axis of the second crystal and at right angles to it, resulting in the four images. When light has been altered in this way it is said to be polarized, and the crystal which produces the alteration is called the polarizer, and the second crystal, which is used to find out the fact, is called the analyzer. Many substances besides Iceland spar produce the same effect; even reflection from glass, or from the clouds at a certain angle, will produce polarization. The fact can only be discovered by studying the light with a second crystal to see whether by rotating it the light is diminished in brightness.

It may readily be inferred that this principle can be applied to the study of stellar brightness. If the light from a star can first be polarized, then passed through an analyzer, and the



analyzer rotated, the light from the star will be diminished and finally become extinguished. If it is compared with some standard light, it can be made equal to it under certain conditions which are under the control of the observer and are susceptible of exact measurement. This statement is intended only to indicate how the principle of polarized light may be applied to photometric observations, but the simple crystal cannot be used, with its multiplicity of images, and some device must be introduced which will reduce them. This might possibly be accomplished by the use of a screen to stop out one of the rays from the first crystal, but the angle separating them is not large, and hence the incident beam would have to be of very small diameter, or else the piece of spar very thick. Instead a convenient contrivance is used which is called a "Nicol's prism." It is made by splitting an ordinary crystal by a plane which passes through the axis, or along the line  $AB$ , as is illustrated in the accompanying figure, and is perpendicular to the principal plane for the face  $AC$ .

The two cut faces are then polished smooth and fastened together again in their original position with Canada balsam. This has an index of refraction such that by the well-known principle of total reflection the ordinary ray is turned aside at the joining surfaces and reflected out, so that only the extraordinary ray passes through such a prism, which then acts as a polarizer. If a second Nicol's prism, which also permits only the extraordinary ray to pass through, is placed in the path of this beam and is rotated, the emerging beam will diminish to extinction, then increase to maximum, and so on, being maximum twice and zero twice. The amount of rotation can be

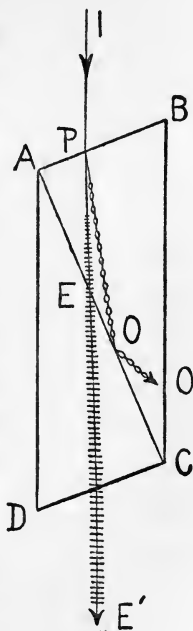

Figure 17  
THE NICOL'S PRISM

measured by a graduated circle and the result used in the determinations of brightness in accordance with the law known as that of Malus. "If a beam of light already polarized falls upon the doubly refracting crystal the intensities of the two emergent beams, the ordinary and extraordinary, are proportional respectively to the cosine<sup>2</sup> and sine<sup>2</sup> of the angle which the plane of polarization of the incident beam makes with the plane of the principal section of the crystal."<sup>1</sup>

If a beam of light passes through two Nicols, and they are so placed that their principal sections are parallel, then the plane of polarization of the extraordinary ray coming from the first Nicol will be perpendicular to the principal section of the second Nicol, and hence the intensity of the emergent beam will be

$$\sin^2 90^\circ = 1;$$

that is, a maximum. If we rotate the Nicols with reference to each other, then the intensity will diminish in proportion to the square of the sine of the angle of rotation. The practical working of this principle will be more readily understood by a description of a photometer which is based upon it. The one best suited to this purpose, and also one which is in very general use in Germany, is known as the Zöllner photometer, which will now be described. While its construction may seem somewhat complicated, it is understood to be quite convenient in use.

The photometer and the telescope may be built as one instrument, in which case the alt-azimuth style of mounting is used; or the photometer is made separately in such a way that it can be attached to an ordinary telescope. Figure 18 shows the form in common use, and is excellent for indicating the positions of the different parts. It illustrates very well the general device that is adopted whenever an artificial star is used for comparison. An arm is attached to the telescope tube at right angles to it, which holds the apparatus for forming the artificial star, as well as that used to diminish its brightness and make it equal to the real star, for obviously the comparison star must

<sup>1</sup> H. Kobold, *Der Bau des Fixsternsystems*, 19.

be the brighter to begin with, since the image of the real star is formed in the usual way by light coming down the tube of the telescope, and cannot be altered. Opposite the opening of

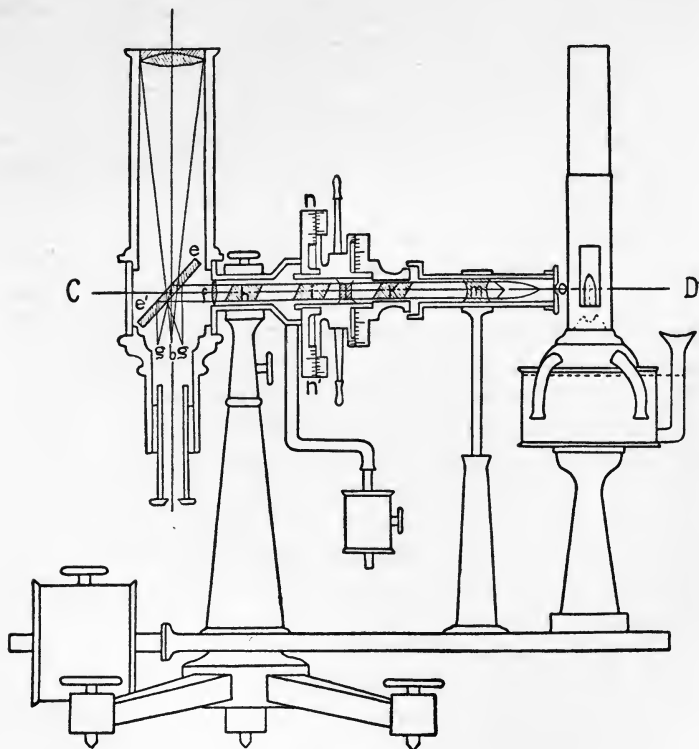

Figure 18

THE ZÖLLNER PHOTOMETER

this side arm is placed a mirror of plane glass which serves to reflect the light from the artificial star down the tube, where an image is formed in the field with that of the real star; the reducing apparatus is then adjusted until the two are equal, and by a proper computation the magnitude may be obtained.

The preceding statement merely outlines the construction of the instrument, of which a full description will now be given. It should be stated also at this point, that this photometer has an additional device by means of which the color of the artificial star can be altered so as to resemble closely that of the real star, a very important object to be attained.

The light which produces the artificial star is from a petroleum lamp tightly enclosed so that no light can escape from it except through a small orifice just opposite the end of the arm *CD*. Emerging from this the light passes through a pinhole diaphragm, *o*, in the end of the side tube. In later forms of the instrument, this diaphragm has several holes of different sizes in order to simulate stars of varying magnitudes. The rays diverge as they come through this opening, and are made to separate still more by passing through a double concave lens, *m*, which has the effect of making the image appear quite small. They then fall upon a Nicol prism, *k*, which polarizes the light, and if passed through a second Nicol, *i*, by rotation can be diminished in brightness until made equal to the real star. But at this point the device is introduced by which the color is altered. It consists of a thin plate of quartz, *l*, cut perpendicular to the axis of the crystal. This is placed next to the Nicol just mentioned, and is closely followed by another Nicol, *i*. The second Nicol and the quartz section are fixed with reference to each other, but the first Nicol can be rotated, and through its rotation, by the principles of interference, the color is changed to agree with that of the real star, and in this position all three pieces can be clamped together. The light as it emerges from the second Nicol is thus polarized and colored. It then passes through a third Nicol, *h*, which acts as an analyzer, and on rotation diminishes it until it is equal in brightness to the real star. In practice, however, this third prism is stationary, and the system which contains the quartz is rotated, the angle being read from the scale *nn'*. The beam of light then passes through a double convex lens, *f*, which serves to collect the rays and throw them upon the plane glass mirror, *ee'*,

which reflects them down the tube of the telescope, forming an image at the focal point side by side with that of the real star, *b*. Since this mirror is thick enough to reflect from both front and back surfaces, there will be two images of the artificial star, *gg*, one on each side of the true one. The order of adjustment of the different parts of the instrument is as follows: the two Nicols *i* and *k* are set parallel, the telescope is pointed so that the star to be observed is in the field, the first Nicol *k* is turned until the light of the artificial star has the same color as the real star, after which the two prisms *k* and *i* and the quartz crystal *l* are clamped together. This part is then turned until the artificial star has become diminished in brightness into equality with the true star, and the circle by which it is turned is read in degrees. The rotation is continued until equality is again secured and another reading taken, there being four positions of the Nicol in which this will occur. From the four readings the brightness of the real star can be determined in comparison with that of the artificial star taken as a standard.

The difference in magnitude can be obtained by combining the results in accordance with the law of Malus and Pogson's rule, as the following example will show.

If *I* is the angle through which the Nicol is turned in order to produce equality of light, then the intensity of the image formed would be measured by  $X \sin^2 I$ , where *X* is the intensity of the incident beam; that is, the real star *A* has a brightness  $X \sin^2 I$ , where *X* is the brightness of the artificial star. The brightness of the standard star, *B*, must be measured in the same way, and will be represented by  $X \sin^2 I'$ , where *I'* is the angle through which the Nicol is turned in order to produce equality of light for the standard star. Hence the ratio in brightness will be

$$\frac{A}{B} = \frac{\sin^2 I}{\sin^2 I'}$$

This may be reduced to a difference in magnitude by Pogson's rule: —

$$\frac{A}{B} = \rho^{\Delta m}, \quad \frac{\sin^2 I}{\sin^2 I'} = \rho^{\Delta m},$$

$$\Delta m = \frac{\log \sin^2 I - \log \sin^2 I'}{0.4}.$$

The following numerical example may be given: —

Let  $I = 22^\circ, \sin I = .37,$   
 $I' = 18^\circ, \sin I' = .31,$

$$\Delta m = \frac{\log .1369 - \log .0961}{0.4} = .38.$$

As stated before, there are four positions in which equality of light is produced, each of which must be read. Therefore the circle is graduated into four quadrants in such a way that the angles can be read from it directly. The image has its maximum brightness when the two Nicols are parallel. This position is then marked  $90^\circ$  on the circle, since  $\sin^2 90^\circ = 1$ . The other positions for equality will be  $180^\circ - I, 180^\circ + I, 360^\circ - I$ .

This photometer, as we have said, has been extensively used abroad. The entire work of the *Potsdam Photometric Durchmusterung of the Northern Heavens* was carried on by Müller and Kempf with instruments of this design. We may therefore appropriately give here some account of this important work. Its purpose is to furnish the photometric magnitudes of all of the stars in the *BD.* down to magnitude 7.5. Each volume contains the stars of a single zone; the first zone extending from  $0^\circ$  to  $20^\circ$  declination, the second from  $20^\circ$  to  $40^\circ$ , the third from  $40^\circ$  to  $60^\circ$ , and the fourth from  $60^\circ$  to  $90^\circ$ . A fifth volume contains the general catalogue of 14,199 stars. It was begun in 1886 and the introduction to the first volume, published in 1894, contains an account of the projected plan. Since the brightnesses of the stars are only relative, and the unit to which they are referred is entirely arbitrary, it seemed desirable to follow the example of the English and American observers and adopt Polaris as the standard.<sup>1</sup> This course however was open to the objection that Polaris would frequently differ very widely

<sup>1</sup> *Potsdam Phot. DM.*, 1, 7.

in altitude from the star under observation, and hence a large correction for atmospheric absorption would be required; it was therefore decided to adopt a large number of fundamental stars suitably distributed, compare them exhaustively with the pole star and among themselves, and then use them in making the actual observations of other stars. They were selected so as to lie in three zones, having declinations  $10^\circ$ ,  $30^\circ$ , and  $60^\circ$ , at intervals of 30 m. in right ascension, to range in magnitude from 5.0 to 6.7, and to include 144 stars,<sup>1</sup> which were combined in 432 pairs in making the inter-comparisons. Corrections were applied for the atmospheric absorption. The colors were also compared, and numbered according to the following scale; white = 1, yellowish white = 2, whitish yellow = 3, yellow = 4, reddish yellow = 5, yellowish red = 6, red = 7.<sup>2</sup> Careful investigations were made to discover if there were any systematic errors between the results of the two observers, Müller and Kempf, depending either upon the extent of the difference in magnitude between any two stars of a pair, or arising from a difference in color. The results showed that while a relation was apparent the errors were too small to injure the results. Hence all of the later determinations depended upon the mean  $\frac{1}{2} (M - K)$ .<sup>3</sup>

The photometer, it should be remembered, gives only differences in magnitude between pairs of stars, and it remained to deduce the final magnitudes from the observed differences. Since there were 432 combinations, this had to be done by a series of approximations, assuming arbitrary initial values for the magnitudes of the individual stars. The values adopted were taken from the *Durchmusterung* of Argelander, first because they were entirely independent of determinations at Potsdam, and secondly because the 432 equations give the differences in brightness only, and the absolute system can be determined arbitrarily. Furthermore, the *BD.* is much the most complete catalogue of star magnitudes and will be for a long time an almost indispensable source for studies in

<sup>1</sup> *Potsdam Phot. DM.*, I, 17.

<sup>2</sup> *Loc. cit.*, 109.

<sup>3</sup> *Loc. cit.*, 111.

stellar brightness; hence it is desirable that new photometric catalogues should so far as possible be connected with its system. An inspection of the table which gives the differences *Potsdam* - *BD*. shows that their greatest values are  $-0.89$  and  $+0.76$ ,<sup>1</sup> but these large deviations may well be due to errors in the *DM*. itself. The mean difference is  $0.27$ . The mean of the star magnitudes for both systems is  $6.02$ , so that at magnitude  $6.0$  the two agree exactly.

The exactness of the Potsdam magnitudes is indicated by the fact that the relative brightnesses of the fundamental stars are correct to  $0.05$  mg. A correction to the whole system may be made at any time if it should seem desirable to change the standard. Therefore the material afforded by the magnitudes of the standard stars is very exact and homogeneous.

The next photometer to be considered will be that designed by Pickering and known as the meridian photometer. It is described at length in *Annals*, H.C.O., vol. **14**, and later modifications are given in volume **23**. In this form of photometer the principle of polarized light is used, but in quite a different form from that utilized in the Zöllner instrument, as the following preliminary statement will show.

In place of using a Nicol prism as a polarizer, which permits only one beam of light to pass through it, another form of double image prism is used which permits two beams of light, polarized in planes at right angles to each other, to pass through the analyzer; as the prism is rotated, one image diminishes while the other increases, and when the point of equality is reached, the circle is read. Instead of an artificial star the pole star or some other close circumpolar is used for comparison, and the difference in magnitude can be determined directly from the circle readings. A description of the instrument is given below. An excellent drawing<sup>2</sup> of it can be found in Young's *General Astronomy*, an adaptation from which is given here.

Two lenses,  $10.5$  cm. in diameter, and of the same focal length,

<sup>1</sup> *Potsdam Phot. DM.*, **1**, 116, Table v.

<sup>2</sup> C. A. Young, *Gen. Ast.*, ed. 1891, 473. Ginn & Company, publishers.



are placed side by side in the same tube, which is set horizontal in an east and west line. In front of each is set a plane mirror at an angle of  $45^\circ$ , adjusted in such a way that it reflects into the tube stars which are on or very near the meridian. The mirror of one is adjusted so as always to send the light of the pole star through one lens, and the other can be rotated about an axis in such a way as to reflect stars on any part of the meridian into the second lens. The latter can also be turned by rods and made to reach a star of any declination a quarter of an hour before or after its meridian passage. The mirror which serves to reflect the pole star is also capable of adjustment and can bring it into any part of the field. The two lenses are some-

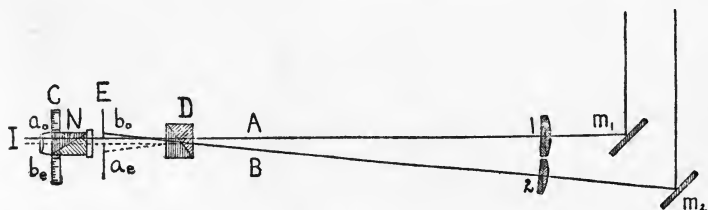

Figure 19

## PICKERING'S MERIDIAN PHOTOMETER

what inclined so that their optical axes are not parallel, but lie at such an angle that their images would be formed at the same point. Just before this point is reached a double image prism, *D*, made of Iceland spar compensated by glass, the object of which is to bring the two pencils of light together, is inserted in the path of the rays. Each of the two beams of light falling upon it is separated into two, which are polarized at right angles to each other. The two outer beams,  $a_o$  and  $b_o$ , *i.e.*,  $a$  extr. and  $b$  ord., are cut off by a diaphragm, and the two inner beams are made to coincide, and pass through a Nicol prism, which may be rotated and the amount of rotation read from a scale, *C*. They then enter the eyepiece, where the observer sees two star images, one coming from Polaris, and one from the star to be compared with it. The images will consist of

light polarized in planes at right angles to each other, and consequently, when the Nicol is rotated, one image will diminish in brightness, while the other increases, and there will be four positions in which they will be equal. Much care is required in adjusting the different parts of the apparatus in order to obtain the desired results, the details of which are fully described in *Annals*, 14, 1-8. The process of observing is as follows. Two persons are required in the work, the observer, "A," and the recorder, "B." A dark curtain cuts off the light of the room from the eyepiece where the observer sits, while the recorder is placed at the side of the table, with a sidereal clock and all necessary papers before him. The observer "A" brings the pole star into the middle of the field by moving the northern prism with adjusting rods. The recorder "B" selects the star to be compared in accordance with a plan previously made, and turns the southern prism so as to bring this star also into the field. "A" then places the image of Polaris near that of the other star, and turns the Nicol until the two images are equally bright. The recorder then reads the circle to tenths of a degree, the observer turns the Nicol still farther until the images are again equal, and the recorder takes the reading. The observer then turns the northern prism, which throws in the image of Polaris so that it appears on the other side of the second star, and makes two more settings. This last change is made in order to eliminate a personal error arising from a right and left comparison, the possibility of which was earlier discovered by Pickering when making similar observations of Iapetus (*Annals*, 9, 222). The time consumed in making each observation is one minute. As the observations are pretty continuous, one star being brought into the field as soon as another has been observed, a series is limited to about an hour.

The method of reduction will be slightly different from that adapted to the Nicol prism and the Zöllner photometer, for here we have the case of two images in which the light is polarized in planes at right angles to each other. Hence the intensity of one will be  $A \cos^2 I$  and  $B \sin^2 I$ , where  $A$  and  $B$  are the in-

tensities of the incident rays, *i.e.*, the brightnesses of the two stars. If  $I$  is the angle counted from the position where the image of Polaris disappears, then  $A$  is its brightness, and  $B$  is the brightness of the other star. Then, since the images are equal, we shall have

$$A \cos^2 I = B \sin^2 I,$$

and

$$\frac{A}{B} = \tan^2 I,$$

whence, by Pogson's rule,

$$\frac{A}{B} = \rho^{\Delta m},$$

and

$$\Delta m = \frac{\log \tan^2 I}{0.4}.$$

Further details of the computation and the construction of tables for facilitating it may be found described in the *Annals*.

The second prism is turned so as to bring the image of Polaris into the field at the beginning, middle, and end of a series, in order to see if the two prisms are in good adjustment. There are three errors to which the star magnitudes are subject; the first may result from a possible difference in the images formed by the two object glasses, the second from atmospheric absorption, and the third from any possible deviation of the magnitude of Polaris, which is assumed to be 2.0. All of these sources of error were investigated, and material collected and prepared for making corrections for them. In view of the recent discovery of the variation of Polaris it is interesting to inquire if it was revealed by this investigation. Pickering states that since all of the observations were reduced by means of the pole star, the residuals of the standard stars would show whether it varied or not. But from a study of them the conclusion was drawn that it did not undergo a variation of long period. After the variability became known and its period was found to be 3.9683 days, the residuals were grouped according to the phase and the means taken. The evidence of variation was unmistakable and the form of the light curve was easily obtained.

With a smaller instrument similar to this the first volume of the *Harvard Photometry* was made, and published in 1884. Its purpose was the observation of stars not fainter than the sixth magnitude lying between the pole and  $30^\circ$  south declination. In preparing the list the various catalogues and charts constructed to include such stars were carefully consulted, namely Argelander's *Uranometria Nova*, Heis's *Atlas Coelestis*, Gould's *Uranometria*, and the *Durchmusterung*, from which all stars not fainter than 6.5 mg. were taken. The final catalogue contains 4260 stars. At a later period a second meridian photometer was constructed, having larger lenses, and intended for determining the magnitudes of fainter stars. For this reason, since Polaris was too bright for purposes of comparison,  $\lambda$  Ursae Minoris was used as the standard star.

The object was to determine the magnitudes of stars, chiefly of the 9th magnitude and brighter, 20,125 in number, in zones  $20'$  wide at intervals of  $5^\circ$ , from  $-20^\circ$  to the north pole. Various other volumes containing observations made with these two instruments have been issued by the Harvard College Observatory. Altogether they form a most valuable contribution to the study of stellar photometry.

There are several other photometers which make use of polarization apparatus, but the two described are the best known and have been most extensively used. A third photometer, designed by Pickering, makes use of an artificial star, the light of which is cut down by a photographic wedge in order to equal that of the real star. The accompanying figure shows its construction, which in general outline is similar to that of the Zöllner photometer.

The tube which is attached to the end of the telescope bears at right angles to it an arm containing the artificial star. The light from an incandescent lamp, *L*, passes through a small aperture in the diaphragm, *D*, then through a condensing lens, *P*, which projects it upon a plate of plane parallel glass, *B*, from both surfaces of which it is reflected, forming images in the focal plane of the objective at *E* and *F*, on either side of the

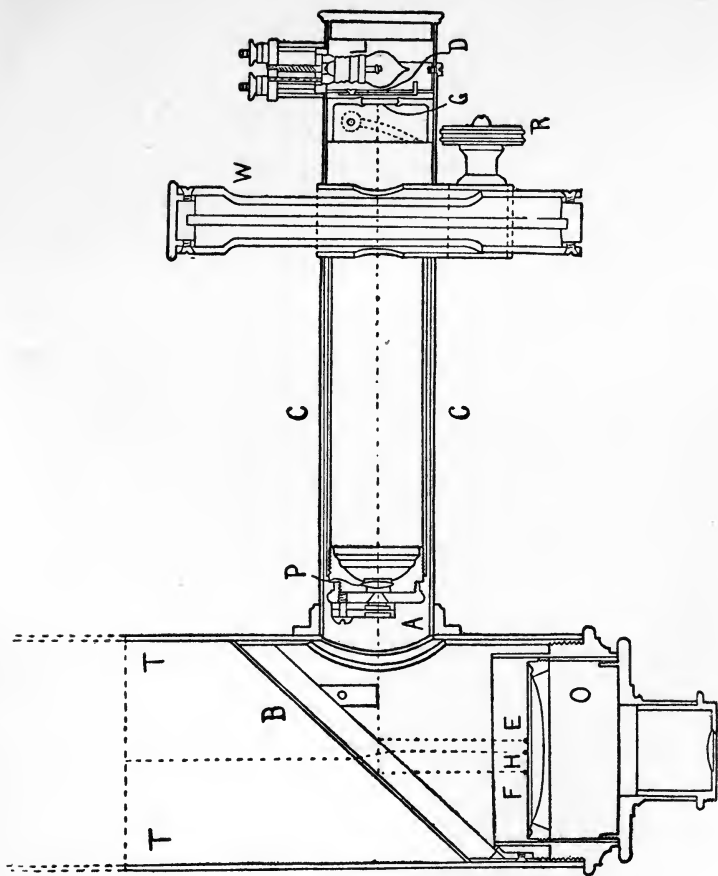

Figure 20

WEDGE PHOTOMETER, YERKES OBSERVATORY

true star, *H*. The reduction of light is effected by the interposition of the wedge, *W*, movable by the rack and pinion *R*, the position of which can be read on the scale. Various devices are introduced for the purpose of making the artificial star resemble as closely as possible the true star in size and sharpness; among them a ground glass, *G*, close to which is a piece of blue glass, to render the artificial star less yellow, and a pair of shade glasses at *A*. The diaphragm *D* is adjustable, and has more than one aperture. The photographic wedge consists of a regular photographic film, prepared in the manner described in Chapter VII at the Harvard Observatory. A thin plate of glass is fastened to it for protection. In making the observation the telescope is moved until the image of the real star lies between the two images of the artificial star. The wedge is then moved until equality is secured, and the reading of the scale is recorded. As before, comparison must be made with a standard star, whose magnitude is already known. The scale reading for its equality with the artificial star is found, and the difference in readings, when multiplied by the value of one division on the scale, will equal the difference in magnitudes. It remains, then, to investigate the value of one division, or as it is termed, the wedge constant. This problem is fully treated by Parkhurst,<sup>1</sup> who gives the results of his researches on an instrument at the Yerkes Observatory, in the course of which he employed several different methods. The one most easily understood is the observation of a series of standard stars whose magnitudes are well known, such as the Pleiades. The wedge should also be calibrated, that is, an investigation should be made to find if the value of a division on the scale is constant throughout the entire length. This form of instrument, attached to a fifteen-inch equatorial, has been used extensively at the Harvard Observatory, particularly for the observations of long period variables, both in finding the magnitudes of the fainter comparison stars and in making observations of the variable. It has been used by Parkhurst at the Yerkes Observatory, with

<sup>1</sup> *Ap. J.*, 13, 249.

both the six-inch and the forty-inch telescopes. It has also been employed elsewhere in this country, and has been found to give satisfactory results.

In the foregoing pages no attempt has been made to discuss fully any of the instruments under consideration or the errors to which each is subject. The purpose has been rather to give the reader the idea of their general construction and use, leaving the original sources to be taken up by the student who is specializing in such work. A fairly full treatment of polarized light has been given, since an understanding of its principles is necessary, and no textbook in Astronomy adequately discusses it.

No mention has been made of the method of extinction by which photometric observations can be made. There are several photometers of this kind, in which the star's light is diminished until it disappears, the point of extinction being read on the scale. In this case, as before, recourse must be had to a standard star, which is observed in the same way. This may be accomplished by cutting down the aperture of the object-glass, or by inserting at the eye end of the telescope a wedge or some kind of polarizing apparatus. This method is not now in general favor, as the observation is supposed to be more fatiguing to the eye of the observer, and the instant of extinction is not clearly defined. However, some astronomers find no difficulty in making the observation, and such instruments are still in use and giving good results. The writer, on a recent visit to the Capodimonte Observatory, in Naples, found that the Director, Professor Bemporad, was using a Toepfer extinction photometer with much success. On being asked if the observation was not difficult and trying to the eyes he replied decidedly in the negative. The results of his work have not yet been published.

## CHAPTER VII

### PHOTOGRAPHIC PHOTOMETRY

THE subject of star color and its effect upon visual photometric measures has been referred to several times in the preceding chapters, but it becomes still more important when the study of photographic photometry is taken up. Hence a discussion of it should precede the consideration of the general subject of this chapter. Mention has been made of Chandler's scale in connection with the colors of variable stars, and of the Potsdam scale in the description of the *Potsdam Photometric Durchmusterung*. These two are not the only scales. Argelander first suggested a chromatic scale, which consisted of four colors, red, orange, yellow, white; but he realized that his own eye was not very sensitive to color impressions, and made very little systematic study of star colors.

In 1872 Schmidt,<sup>1</sup> from the observatory at Athens, wrote to the *Nachrichten* an account of the results of his experiments in the study of color with different telescopes in different localities. He came to the conclusion that within certain limits color can be expressed by a numerical scale. From his series he excludes such colors as green, blue, and purple, which are seen in the components of double stars, and also the greenish shimmer which many isolated stars have, and limits himself to the orange, or colors which, beginning with pure white, pass through all the stages of yellow and finally emerge into red.

In my experience neither a pure white nor a decidedly red star occurs. In all the so-called white stars, such as Sirius and Vega, I find some, though very little, mixture of yellow. In all the red stars, without exception, the fundamental color is an intensive yellow, with a decided, though unequally strong, inclination toward red. This is the case with Antares. A true red, carmine, or blood red, a red such as I know in the protuberances, the red of the Fraunhofer line C, I have

---

<sup>1</sup> A.N. 1897.



never found in the case of a star. Therefore in my scale I make pure white 0, and the true red, without any mixture of yellow, I value 10. Between these two lies the bright yellow at 4, the intense golden yellow at 6, and all my red stars have numbers between 6.5 and 9.

The rest of his paper contains interesting remarks on the color of variable stars, which belong more properly to the chapter on the statistical study.

Other observers adopted scales of the same sort, but assigned different numbers to the different shades of color. They found that the estimations of the color were affected by moonlight, twilight, dust, or cloud, though Schmidt thought only the twinkling on the horizon need be regarded.<sup>1</sup> The instrument also has an effect on the color. One observer found that comparisons made with a reflector and a refractor differed, as the latter has chromatic aberration, while the former has not. Argelander says that a certain star will appear brighter in contrast to a white star the larger the light gathering power of the telescope which is used to observe them. This is explained by the Purkinje phenomenon, which was described in the preceding chapter. Most of the earlier comparisons were merely eye estimates. Chandler<sup>2</sup> makes some interesting general remarks in connection with a paper on the colors of variables, in the introduction of which he says:—

I had long been impressed with the importance of an investigation of the sort in question, but had been deterred from undertaking it by the difficulties, physical and physiological, in devising a rational and practical method, and the establishment of a correct color-scale.

He adopted a scale similar to Schmidt's though not coinciding with it, in which 0 corresponded to white, 2 to yellow, 4 to full orange, and hence up to 10, which is full red, such as we find in stars like S Cephei and R Leporis. His remarks upon its adoption are interesting and illuminating.

It is freely admitted that there is much vagueness in this description, as well as in the mental picture of the imaginary standards to which it was sought to refer the estimates. The difficulty is inherent

---

<sup>1</sup> J. G. Hagen, S.J., *Ver. St.*, 178.

<sup>2</sup> *Ast. Jour.*, 8, 137.

and has been experienced by other observers. Indeed, in the beginning, before confidence had been acquired by practice, I strongly doubted whether the method would yield results to be depended upon; but on further acquaintance I am convinced that the certainty of the process of mental reference of color-impressions to imaginary standards, and the fixedness of the latter, are greater than would be naturally inferred by an observer previous to trial.

In the next part of his article Chandler discusses a plan by which he made use of Argelander's step method in converting difference in color between two stars into difference in brightness by interposing a shade of colored glass, which by selective absorption altered the apparent relative brightness of stars of different colors. Thus a red star which appears exactly equal to a white star when viewed in the ordinary way, appears fainter than the latter when a blue shade glass is applied to the eyepiece, and brighter when a red one is used.

These differences, which can be estimated very precisely by Argelander's method, thus become measures of the difference of color, of course on an entirely arbitrary scale, depending on the amount and character of the selective absorption of the shades employed.

He makes use of his scale for determining the redness of the variables, and comes to practically the same conclusion which Schmidt reached, *viz.*, that the color varies with the length of period.

Osthoff,<sup>1</sup> at Cologne, worked twenty-five years on star colors, and in 1900 published the results of his investigation, including a catalogue of the colors of 1009 stars. The description of his method can best be given in his own words: —

The observing room was always entirely darkened. I covered my head and the eye end of the telescope with a dark cloth. The observations were written down in the dark, and the color was always expressed in one figure. Only under the most pressing circumstances was the lantern opened during the time of observation, and then only to look at the star chart. I always estimated an unknown star with reference to a known star. At the conclusion of the observations, still during the night, or at the latest the next morning, I glanced over my

---

<sup>1</sup> *A.N.* 3657-58.

notes and identified the stars. Before the beginning of each evening's work I looked over the program, but did not take any heed of the observations already made.

When there was bright moonlight, unsteady air, or a too cloudy sky, I made no estimation of the color. I looked long and fixedly at each star until the impression of its color no longer fluctuated. I obtained for the mean duration of a color estimate 2.21 minutes.

He adopted Schmidt's scale, but separated the classes more definitely, and extended the scale on either end to  $-1^{\circ}$  brilliant pure white, and  $12^{\circ}$  dark pure red. He then adds the following remarks, which are most valuable in view of his long experience in this kind of work. They refer to its subjective side:—

Having applied this scale to many stars, through thousands of estimations I have tested its practicability and found that it expresses accurately the relations among the stars as long as they are sufficiently bright. If their light is too faint, white changes into gray, etc., yellow into brown, and orange into reddish brown. The mass of the fainter stars shine in a monotonous gray. The colors blue and green are subjective. They arise when the observer has not protected himself from the influence of outside light, such as the shimmer of the starlit heavens, reflections from the metallic parts of the instrument, or moonlight. These remarks are not to be applied to the vivid blue color of the smaller component of a double star.

Enough has been said to show that such elusive impressions as star colors can be classified accurately when sufficient experience has been acquired. Several other determinations of star color have been made, and catalogues published. In the latter part of his paper Osthoff compares the scales of the different observers, and arrives at an expression of their differences. He also studied his own results from several different points of view, but it is not necessary for our purpose to carry the matter farther in this direction, for recent investigations have so persistently pointed to the connection between color and spectral type that the interest is centering now on the latter factor rather than the former. However, before passing to a consideration of it, it is interesting to note that while different colorimeters, or instruments for determining the color, such as the quartz section in the Zöllner photometer, have been devised

and successfully applied, no catalogues of star colors based upon their use have ever been published. As Hagen<sup>1</sup> says, "Colorimetry has lagged far behind photometry."

That there is a relation between the color of a star and its spectrum is evident theoretically from a consideration of the classification of stellar spectra; and it is also obvious when we consider how the spectrum is formed. The light of the star falling upon a prism is broken up into its component colors. The lines in its spectrum cut out certain portions of these colors, and there is frequently general absorption. Hence we can easily see that the colors which are left, when combined, will not give white light, but the resulting tone will depend upon the mixture. Thus we should hardly expect, as Schmidt evidently did, to find a star which had color like the pure red of the C line. Such a star might occur if that line alone were present or if it were the dominant color in the spectrum. Neither should we look for blue stars, for their existence would require absorption in the red end of the spectrum. But absorption comes in from the other end; hence the blue end is cut off first. The only stars likely to have the blue color predominating in the spectrum are those of the fifth type, which have bright bands at  $\lambda$  4688 and 4633. Their color can be gauged by remembering that they lie about half way between the F line and the G group in the solar spectrum, and hence will be a bright, rather light blue, but a decided blue, with no tinge of another color. Unfortunately these stars are rather faint, and none of them are found in the catalogues of colored stars. The best list of stars of the fifth type was prepared by Mrs. Fleming, and is found in *Annals*, H.C.O., vol. 56, no. VI. Only four stars on this list in the northern heavens are bright enough to be found in the *PD.*, and their colors as given there are W+ or GW. Barnard gives some interesting facts in regard to the focus and color of certain temporary stars. In writing of Nova Lacertae<sup>2</sup> in 1911, he states that it had two distinct foci. At one of them the image had but little color and was surrounded

<sup>1</sup> *Ver. St.*, 291.

<sup>2</sup> *A.N.* 4468.

by a reddish glow. The other image was of a beautiful crimson color, surrounded with a greenish-gray glow, and was in focus 8 mm. farther from the object glass. He explains it as being due to the great brilliance of the  $H\alpha$  line. This star would seem, then, to be an illustration of Schmidt's long sought for type 10, of which he says: "A true red, carmine or blood red, a red such as I know in the protuberances, the red of the Fraunhofer line C, I have never found in the case of a star."

It is a curious and interesting fact that both Schmidt and Osthoff rather avoided the subject of the color of double stars, but seemed to take it for granted that among these at least, stars of a true blue were to be found. While the discussion of this point does not bear especially on the subject before us, it may be admitted perhaps, on account of its very great interest. An investigation of the subject was recently made by Mr. Louis Bell,<sup>1</sup> who approached it from the point of view of physiological optics. He was led to do so because of the great variety and bizarre array of colors assigned to the components of double stars, such as may be found in any of the English books containing lists of these objects. Webb, for example, in his *Celestial Objects for Common Telescopes*, uses such adjectives as lilac, mauve, cool gray-green, ashy yellow, smalt blue, topaz, fawn color, etc., colors never found in isolated stars. An examination of the use of these names shows that they are applied in nearly every case to the smaller component of a pair, which may be indiscriminately an optical or a physical double. This fact was long considered to indicate that the smaller star was not so far advanced in evolution as the brighter component, and hence would show a spectrum of an earlier type; but even such a spectrum would not give a blue color, since stars of the early type are pure white, or a pale yellowish white. Besides, this certainly could not be regarded as a valid explanation when we consider the fact that such colored doubles are not always binary systems, but may be merely optical doubles, in which, while the two stars are in the same line of sight, one is far dis-

<sup>1</sup> *Ap. J.*, 31, 234.

tant from the other, so that there can be no possibility of a physical connection between them.

It has long been known that contrasts in color are in some way related to the difference in magnitude. Struve found an average difference of about 0.5 mg. for doubles of exactly the same color, a difference a little greater than a magnitude for doubles which had slightly different colors, but a difference of over two magnitudes when the colors were decidedly unlike. The study of the spectra of a few doubles, which Bell found on the Harvard records, where the spectra of both components had been photographed, showed that where they were of the same spectral type they did not differ greatly in magnitude or in color. Where the companion was of an earlier type than the principal star, there was a decided contrast in color, and a greater difference in magnitude; such as

$\epsilon$  Boötis; Star A, mg. 2.7, K, very yellow;

Star B, mg. 5.1, A, very blue.

The letter refers to the spectral type. There are a few instances in which the primary has the earlier spectral type, in which case there is again a contrast in the colors; *e.g.*,

$\mu'$  Boötis; Star A, mg. 4.5, F, flushed white or yellow;

Star B, mg. 6.5, K, greenish white, yellowish azure.

The epithet "yellowish azure" applied to a star of type K at once shows that the subjective element in estimating the color is very strong.

The possibility of this was not ignored by the earlier workers in double stars, but it was dismissed from general consideration for two reasons: firstly, the colors must be real, because they persisted even when the primary was hidden by an occulting bar; secondly, if such colors are due to contrast they must be complementary. Bell's paper then continues with an exposition of the various physiological causes which can produce such phenomena, and ends with an account of experiments made with artificial doubles to prove them. These causes are familiar to readers who are proficient in the subject of physiological optics, and can only be mentioned here. They are "simultane-

ous contrast," "fatigue color," the "Purkinje phenomenon," and "dazzle tints."

The preceding pages show the importance of color in making visual observations of stellar brightness. We shall now see that it has an equally important effect upon the photographic image of a star; but before considering this point it will be necessary first to give some account of celestial photography in general, including some practical matters regarding telescopes.

The first astronomer to suggest that the size of the photographic image of a star would vary with its brightness and the duration of the exposure, was Professor G. P. Bond<sup>1</sup> of the Harvard College Observatory. In 1858 he published an article in the *Astronomische Nachrichten* on *Stellar Photography*, in which he made the following introductory statement. The entire passage is quoted because it shows that he saw the problem clearly, but also that certain technical difficulties escaped him.

Photographs of Stars of unequal brightness present marked peculiarities in size and intensity, when their images formed in equal exposures are compared together, at once suggesting the possibility of classifying them according to a scale of photographic or chemical magnitudes, analogous to the common optical scale, but differing from it essentially in the fact of its being based upon actual measurements, in place of the vague and uncertain estimates to which astronomers have hitherto resorted in attempting to express with numbers the relative brightness of different stars.

There are three particulars in which the proposed system will have an unquestionable advantage over that in common use, provided that the chemical action of the starlight is found to be energetic enough to furnish accurate determinations of its amount. It will be less liable to be affected by individual peculiarities of vision. There will be less room for discordance between different observers, or for disagreement between the conclusions of the same observer at different times, as to the qualities or proportions constituting the various grades of magnitude. — Lastly it will meet perfectly the greatest of the many difficulties of the problem — the comparison of stars exhibiting diversity of color.

Though Bond erred in regard to the difficulty presented in

<sup>1</sup> A.N. 1158-59.

the last statement, its existence can hardly be considered a disadvantage, because while diversity of color has added to the complexity of the problem, the efforts to overcome it have greatly added to our knowledge.

Bond concluded his article by saying: —

There seems to remain in the way of obtaining a very high degree of precision by those means, only the difficulty of preserving an equable chemical susceptibility in the surfaces presented to the light of the different stars. It cannot be doubted however that this element can be kept so far under control that the errors introduced will not exceed those produced by atmospheric perturbations or from other disturbing agencies which cannot be counteracted.

That this latter objection has been met is shown by a positive statement made by Hartmann:<sup>1</sup>

We assume here only that every plate has the same sensitiveness over its whole surface, and that the development, and other treatment of the plate, have been precisely the same for all different points. If we should not make these two assumptions, the photometric utilization of photographic plates would be entirely impossible.

The next point to be considered concerns the appearance and formation of the star image. Certain facts in regard to it are obvious to any one who has examined many photographs of the heavens; namely, the fact that the star images are not round over the entire plate, while they may be perfectly so near its center. Farther away, they will be elongated, usually in the direction of the radius. Their density is also irregular away from the center, so that the discs are often anything but uniform. Sometimes they are elongated with the maximum of density at one end of the ellipse, making them quite unsymmetrical and difficult to measure. There are sometimes spurious images on a plate, false stars, which however can usually be distinguished from the real star by their appearance. It is not known whether they occur in the development or preparation of the plate. The appearance of the image is also largely affected by the accuracy of the guiding of the telescope, for

<sup>1</sup> *Ap. J.*, 10, 322.





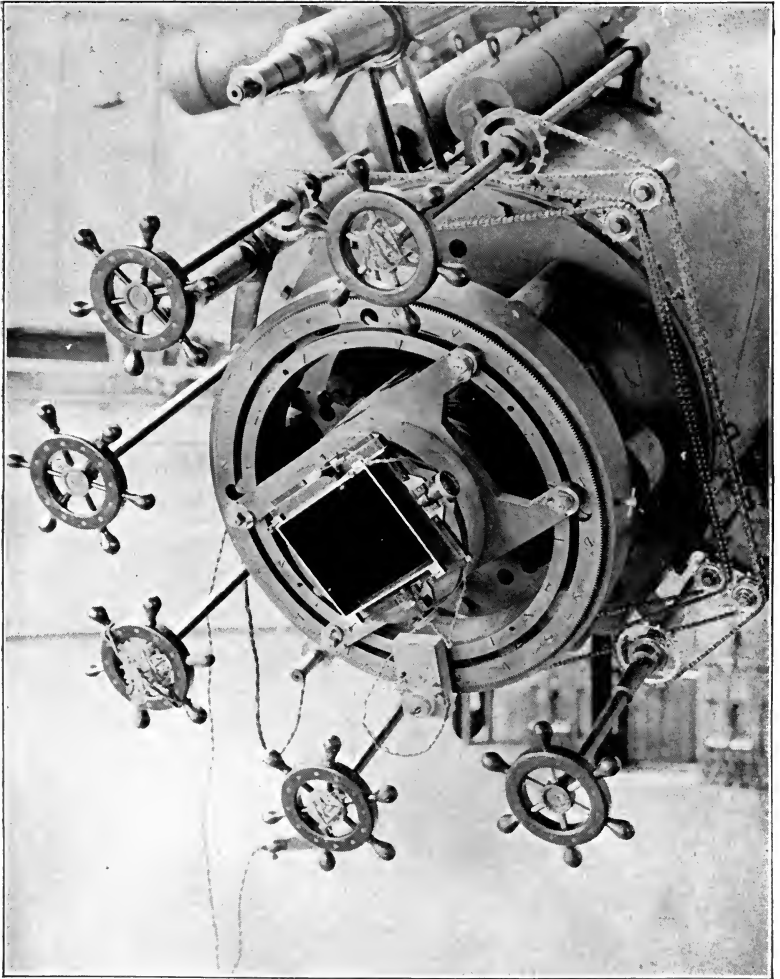

Plate V

DOUBLE-SLIDE PLATE-CARRIER ON THE 40-INCH TELESCOPE  
YERKES OBSERVATORY

which two devices are in general use and may well be described here. In one case a second telescope is mounted parallel to the photographic instrument, at which an observer is placed whose duty is to get the instrument accurately pointed by setting the crosswires on a star, and then to keep it in that position during the entire exposure. With a large, heavy instrument there are usually extra motors, which may be used or not at the will of the observer, and will put the telescope into the correct position again if at any time the clock work should fail to keep it true.

The other device for guiding is an integral part of the plate holder which is attached to the end of the photographic telescope. In the method previously described, this is firmly fastened to the tailpiece, and while it may be removed, it is not movable. In the present case the plate holder, which is called a double slide plate carrier, is movable itself, and slides in two directions at right angles to each other, the motion being easily controlled by two screws. The main telescope is carried by its clock work, which must be accurate, though not sufficiently so for the fine purposes of photographic work. A star on the edge of the field is used as a guiding star, and its light is reflected out to the side and into the eyepiece by means of a totally reflecting prism, situated just within the framework carrying the plate holder. Here the observer places his eye, and as before sets the crosswires on the star selected for the purpose, and keeps his watch, moving the plate holder as the necessity arises. This apparatus has been used very successfully with a large telescope, such as the Yerkes,<sup>1</sup> where the use of a guiding telescope of suitable size to ensure accurate guiding would be impossible. The attachment is illustrated in the accompanying photograph, which shows the end of the forty-inch with the plate carrier attached, the plate holder being removed. On two sides may be seen the screws which control the motion, and in the upper part the guiding eyepiece projects at the side, while the totally reflecting prism is dimly visible just within the edge of the box.

The next point to be considered is the formation of the star

<sup>1</sup> G. W. Ritchey, *Yerkes Obs. Pub.*, 2, 389.

image. A star is a point, and its light impinges upon only the minute spot on the plate which corresponds to the center of the image; how is it then that a disc of regular form results from the chemical action? Charlier<sup>1</sup> answered this question by stating that the light of the star falling upon the plate is scattered either by fluorescence or reflection. A portion is thrown to the side through the gelatine film and by its chemical action produces the star image, while the rest of the light is scattered. The light decomposes the silver salt which is spread over the plate through the medium of the gelatine film; the action of the developer causes the silver particles to be deposited wherever the light has fallen upon the plate, and the fixative washes away the silver salt which has not been affected by the light. The star image consists, then, of an aggregate of silver particles, and hence its character will depend upon the size of the grains and the uniformity of their distribution. The size of the grain depends upon the brand of plate, being largely under the control of the manufacturer. Also some brands contain more silver than others in the salt. An important investigation of this matter was made at the Lick Observatory by Perrine,<sup>2</sup> who examined the images formed on several kinds of plates having different lengths of exposure, and with the use of several kinds of developers. He found that the best results could be obtained by giving the light time to act entirely through the thickness of the gelatine film, and by a full but slow development. Thin films appear to give much more reliable results than thick ones, particularly for fast work, and rapid plates with an increased proportion of silver are found to yield more accordant results than plates with the normal amount of silver. Thus it will be seen that the formation of the star image on a photographic plate depends upon several factors, the general character of the plate and the length of exposure time being the two most prominent.

The appearance of the star image is also affected by the instrument with which it is photographed. On every negative

<sup>1</sup> *A.G.*, xix, 3.

<sup>2</sup> *L.O.B.*, nos. 143, 148.



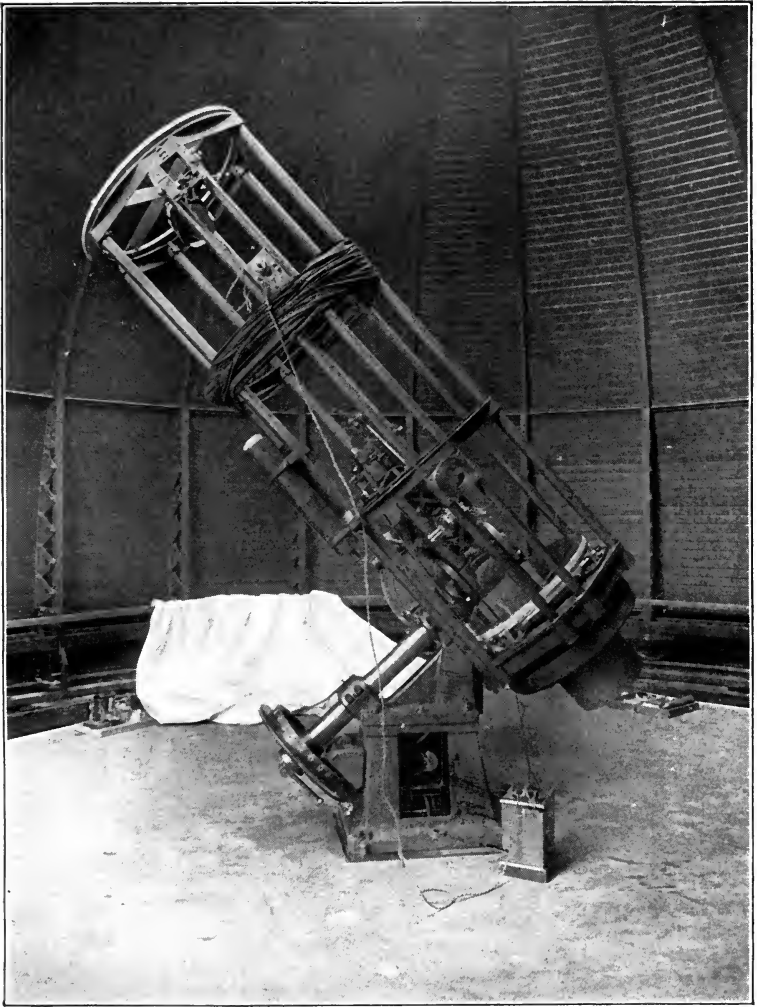

Plate VI

THE TWO-FOOT REFLECTOR, YERKES OBSERVATORY

taken with a reflecting telescope the images of the bright stars will have rays more or less marked extending from them, usually four prominent ones at right angles to each other, and four others not so strong half way between. This is due to diffraction around the supports of the second mirror, which is placed near the opening of the tube in order to reflect the light out to the side where the plate holder or eyepiece is placed. The phenomenon does not occur in photographs taken with a refracting telescope.

Sometimes a very bright star, photographed with a refractor, will be surrounded with a ring or halo of light some little distance from it. The halo is due to the action of an excess of light which has penetrated entirely through the film to the back of the glass plate and is then reflected toward the gelatine, upon which it acts just as the incident light does. This occurs only with a bright star, and cannot be avoided, ordinarily. It comes about necessarily as a result of the effort to make the exposure long enough to get the faint stars, for then the action of the bright stars goes on too long.

Another effect, dependent upon the kind of telescope used, has to do with chromatic aberration, which is quite apparent with the refractor, but is non-existent with the reflector. The object glass of a telescope does not bring all of the colors in a beam of white light falling upon it to a focus at the same distance behind the object glass. It can be ground so as to bring part of the colors together in the same focal plane, the selection of which is largely under the control of the manufacturer, and is made to depend upon the purpose for which the telescope is used. If it is to be used for visual work, then the colors to which the eye is most sensitive, namely, the orange, yellow, green and blue must be brought together. In this case, the focal point of the violet and ultra-violet may be several millimeters farther in, the distance depending upon the aperture of the lens and its focal length. These distances for different wavelengths must be found on a scale which is attached somewhere at the eye end of a telescope, and the investigation of this mat-

ter is one of the earliest pieces of work to be done after a large telescope has been set up. It is carried out by taking photographs of the spectrum at different focal distances. When the values have been found, they are usually plotted, with the wave-length as abscissa and the distance as ordinate, and the resulting curve is called the color curve of the telescope. The following diagram shows the color curve of the Yerkes 40-inch telescope, which was determined by Fox<sup>1</sup> in 1908.

The numbers at the side represent the change in focal distance in mm., the upper part of the figure being toward the objective. The long curve has its flattest part from  $\lambda$  5000 to  $\lambda$  6400, showing that the lens is corrected for visual rays. The small curve shows the effect of introducing the correcting lens, which is used for photographing stellar spectra. It brings the rays from  $\lambda$  4000 to  $\lambda$  5000 to a focus at the same distance behind the object glass, thus covering the region used for the photographs. A further reference to its use will be found in the chapter on spectroscopic binaries.

Since the photographic plate is most sensitive to the action of the light from the blue and violet end of the spectrum, it is evident that the visual telescope will not ordinarily take good photographs, but that an instrument must be specially constructed for the purpose. There are certain devices which can be used to overcome this obstacle, such as using with a visual telescope a yellow color screen,<sup>2</sup> which will cut out the violet rays that are out of focus and allow a sharp image to be formed. Sometimes a specially stained plate, which has been made sensitive to the action of red light, can be used. The latter method, which is of great importance, will be treated at length later on.

The reflecting telescope is entirely free from this defect, and hence all of its light is utilized in forming the star image, while it is obvious that with the refractor part of the light must be lost, whatever the method employed.

The focal length of the telescope has an important bearing on the photographic result. The objective may have a long or

<sup>1</sup> *Ap. J.*, 27, 252.

<sup>2</sup> G. W. Ritchey, *Yerkes Obs. Pub.*, 2, 389.



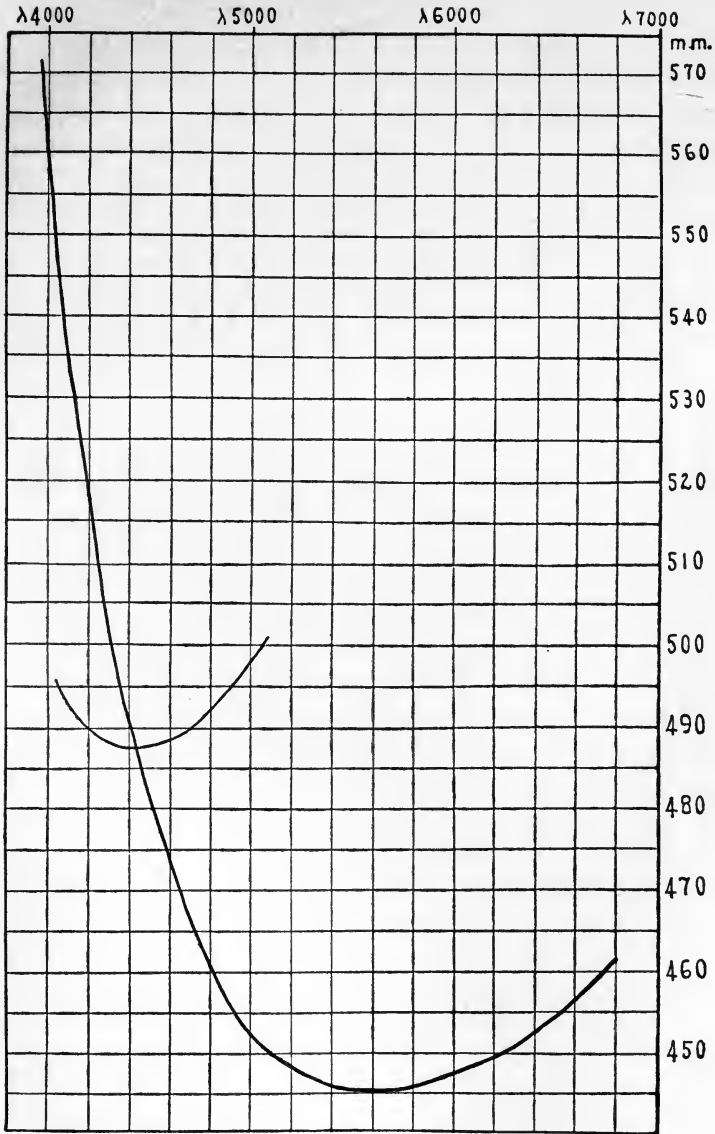

Figure 21

COLOR CURVE OF THE 40-INCH OBJECTIVE, YERKES OBSERVATORY

a short focal length, depending upon the purpose to which it is to be put. A large lens with a short focus will give a very bright image, but a small one; while another of the same aperture, but greater focal length, will give a larger image, but one not so bright. The greater the distance of the focal point from the lens the larger the image, though it continually grows fainter per unit of surface. It is obvious that the total amount of light falling upon the plate will be the same in both cases, but where the telescope has a small focal length this light will be condensed into a small image, which will therefore be brighter than the larger image resulting from the greater focal length. This relation is usually represented numerically by the ratio between the aperture of the objective and its focal length; *e.g.*, the ratio 1:5 would indicate an instrument of short focus, 1:16 is ordinary visual length, and 1:20 or 1:30 would be considered a long focus. The forty-inch Yerkes telescope has a ratio of about 1:19. The two-foot reflector has a ratio of about 1:4. The Bruce photographic telescope, as shown in Plate VII, constructed under the direction of Professor Barnard,<sup>1</sup> has three telescopes in one mounting; two photographic, which have apertures of ten inches and six and one-fourth inches, and focal lengths of 50.3 inches and thirty-one inches, being both in the ratio 1:5; and the third, a visual telescope for guiding, of five inches aperture and focal length apparently the same as the ten-inch photographic of fifty inches, making its ratio 1:10. It will be seen that the short focus lenses have great light-gathering power, which makes them especially suited for the photography of the fainter celestial bodies, while the longer focus instrument with the larger image is better for visual work in which micrometric measurements are to be made.

The preceding remarks bear upon stellar photography in general, but we may now pass to a consideration of some of the points which have to do directly with the relation between visual and photographic magnitudes. In making observations of variable stars we compare the brightnesses of different points

<sup>1</sup> *Ap. J.*, 21, 35.



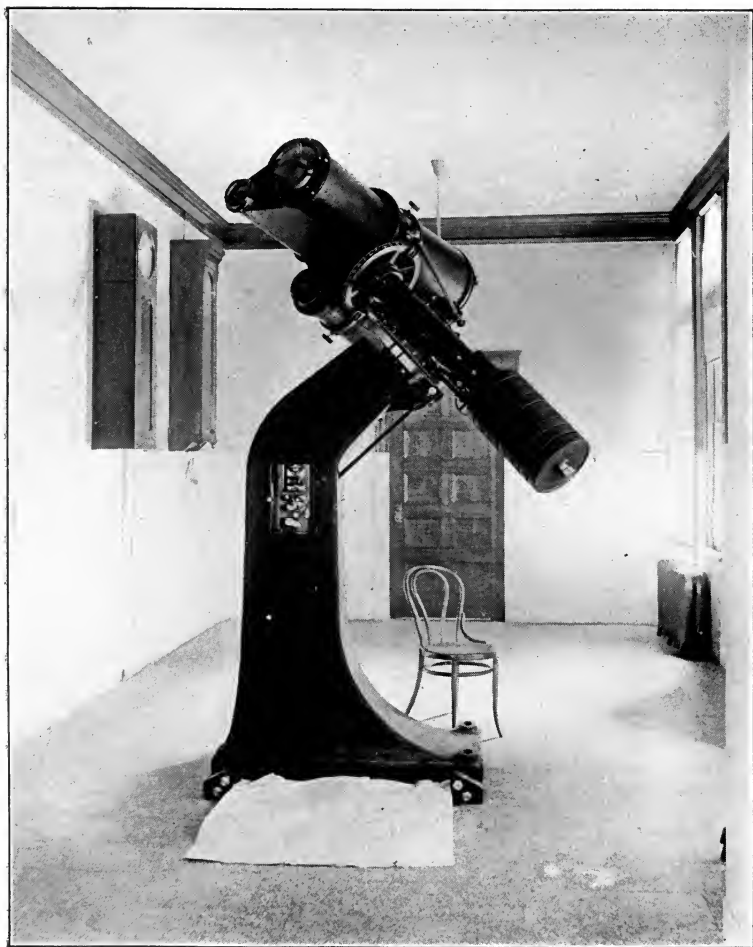

Plate VII

THE BRUCE PHOTOGRAPHIC TELESCOPE, YERKES OBSERVATORY

of light as they affect the retina, while in making photographic observations we must compare the sizes of the images impressed upon the photographic plate. If any of the conditions described above alter in any way the response of the plate to the relative brightness of the stars in the sky, then the deductions made by measuring the sizes of the star images will be erroneous. Evidently color is a most important element to be considered. It has been stated that the blue and violet rays in the spectrum have the strongest actinic power, and hence will make the strongest impression upon the photographic plate. The stars which are strong in this part of the spectrum will therefore make larger images on the plate than stars which are deficient in it, even though of apparently the same brightness to the eye. The difference between the two impressions will depend on the spectral type of the star. According to the classification of stellar spectra, stars of the Sirian type are strong in the violet and ultra-violet and are very white in color. Stars of the solar type have more lines in this part of the spectrum and are yellowish in color, a condition which results from the cutting off of a part of the violet light of the star. Stars of Secchi's types III and IV have large general absorption in the violet end of the spectrum and are decidedly red in color; therefore the redder the star the greater the difference between its visual and photographic magnitude in relation to white stars. While for purposes of photometric work it is necessary to eliminate this difference, its very existence, as hinted before, has led to its being used to determine the spectral type of stars from the difference between their visual and photographic magnitudes. Successful efforts have been made to overcome the difficulty by staining the photographic plate so as to make it more sensitive to the long waves. But before describing them, we must first discuss the method of determining the magnitude of a star from the measurements of its photographic image.

In 1889 Charlier<sup>1</sup> investigated the method of applying stellar photography to the determination of the magnitudes of the

<sup>1</sup> *A.G.*, xix, 1.

stars. He stated the problem thus: "To determine a function which shall represent the relation between the size of the photographic images and the photographic brightness, in which the constants shall be so determined that the resulting photographic brightnesses shall agree on an average with those obtained by photometric observations." The formula already in use was

$$(1) \quad m = a - b \log D,$$

where  $m$  was the magnitude,  $D$  the measured diameter, and  $a$  and  $b$  constants.  $b$  is a number which depends upon the instrument and kind of plate used, while  $a$  depends upon the clearness of the atmosphere and the duration of the exposure.  $a$ , then, will vary with each plate, but  $b$  will be constant so long as the same brand of plate is used with the same instrument. Charlier tested<sup>1</sup> the formula by taking photographs of the Pleiades with four different lengths of exposure, 13 m., 1½ h., 2 h., 3 h. He then selected fifty-two stars, the photometric magnitudes of which had been very well determined by Lindemann, and measured their diameters. Each star afforded an equation of the form (1), there being fifty-two in all, which were then solved by Cauchy's method for  $a$  and  $b$  with the following results:—

$$\begin{aligned} b &= 6.719 \\ &= 6.779 \\ &= 6.683 \\ &= \underline{6.814} \end{aligned}$$

$$\text{Mean} = 6.75,$$

showing  $b$  to be constant and independent of the time of exposure. In order to find  $a$  he transformed equation (1) into

$$a = m + 6.75 \log D,$$

with the resulting values

$$\begin{aligned} a &= 18.77 \\ &= 20.71 \\ &= 20.89 \\ &= 21.02, \end{aligned}$$

<sup>1</sup> *A.G.*, XIX, 9.

the variation depending on the length of the exposure. In order further to test the formula he substituted values for  $a$ ,  $b$ , and  $D$ , in equation (1) for each star, and compared the resulting value of  $m$  with the initial value. The average difference *photom.* — *photog.* was  $\pm .22$  mg. Among the residuals the value 0.6 occurred twice, 0.5 twice, 0.4 four times, 0.3 twelve times, 0.2 twelve times, 0.1 ten times, 0.0 seven times. Many other points were included in the investigation, which was carried out in a thorough manner, and the formula has been in quite general use since. However, other investigators have made use of a somewhat different function of  $D$ . Parkhurst,<sup>1</sup> for example, adopted the form

$$\text{Mag.} = a - b\sqrt{D},$$

where  $a$  is a constant for each plate, depending on the exposure, while  $b$  is a function of the emulsion and conditions of development, which are kept constant in agent, time, and temperature. For example, using a Seed plate on a twenty-four inch reflector, he found on developing it ten minutes in hydro-quinone at  $20^{\circ}$  C. that the value of  $b$  was .94, the unit being .001 mm., and this was constant so long as the above conditions were observed. The value of  $a$  was found for each plate by using visual magnitudes of white stars. At another time Parkhurst<sup>2</sup> found the formula

$$m = a - D^{0.9}$$

to fit the Cramer plates better.

Whichever formula is adopted the net result is the same. From the magnitudes of the known stars on the plate and the measured diameters of their photographic images the constants  $a$  and  $b$  can be determined, and thereafter used in finding the magnitudes of the unknown stars. For a given series of plates  $b$  need be determined but once, for it is constant, while  $a$  depends on the length of exposure, which is different for each plate. In determining both  $a$  and  $b$  white stars should be used. Hence a knowledge of their spectra is essential before the standard stars can be selected.

<sup>1</sup> *Ap. J.*, 27, 171.

<sup>2</sup> *Ap. J.*, 23, 79.

We are now ready to consider some of the applications which have been made of this method of determining photographic images. Obviously it can be used in the study of variable stars, particularly of the short period variables. Sometimes on the same plate at regular intervals of time several exposures are taken, from which the variation in brightness can be determined. So many researches of this sort have been made that it is not possible to mention them all. Some interesting anomalies have appeared as a result, though they still lack absolute confirmation. The light curves, as determined by photometric and photographic observations, do not always agree. Sometimes the form is different and sometimes the time of minimum is not the same.

Reference has been made at several points to the necessity of using white stars as standards. Nevertheless the existence of red stars cannot be ignored, and it is a persistent fact that a red star will not give an image on a photographic plate which will be a measure of its visual brightness; hence some method of correcting for this difference must be found, or else red stars cannot be studied photographically. Experiments were conducted at the Yerkes Observatory to discover if plates could not be stained with some dye which would make them sensitive to the visual maximum of the spectrum, which extends from  $\lambda$  5000 to 5900. Many such dyes had already been investigated elsewhere, but the results did not seem to be entirely satisfactory; hence the need for a further effort. The work was placed in the hands of Wallace,<sup>1</sup> who experimented assiduously with several different kinds of dyes until he found one which gave the desired result, from a combination of pinacyanol + pina-verdol + homocol. The resulting plate he called Pan-iso. Since it was still a little defective, he prepared a compensation filter, and the two together produced the desired effect.

The new stained plates were then used by Parkhurst and Jordan,<sup>2</sup> first to show that visual magnitudes of red stars could be obtained photographically, by taking plates of stars such

<sup>1</sup> *Ap. J.*, 26, 299.

<sup>2</sup> *Ap. J.*, 27, 169.



as U Cygni; and secondly in carrying out a research entitled *The Photographic Determination of Star Colors and their Relation to Spectral Type*. The purpose of this important work cannot be better stated than in the authors' own words: —

It has long been recognized that eye estimates form a very unsatisfactory method of determining star colors, and an urgent need has been felt for some means of accurate measurement. The plan we are following seems to supply that need, and also aids in the solution of two very interesting problems. First it enables us to co-ordinate visual and photographic magnitudes, thus allowing us to use as standards the visual magnitudes of the white stars from the best modern photometric catalogues, and at the same time avoid many of the inherent difficulties and systematic errors of visual measures of colored stars. Second, important data are added for the study of stellar evolution since the relation of color to the stages of stellar development is very close and capable of quite precise determination.

Our method is based on a suggestion first made (as far as we are aware) by Schwartzschild, that the difference between the visual magnitude of a star and that obtained from ordinary photographic plates would give an accurate measure of the star's color. He called this difference "Farbentönung," or color index. Our addition consists in determining the visual magnitudes also by photographic means, and making both determinations practically simultaneous. With this in view, pairs of ordinary and iso-chromatic plates were taken regularly with the 24 inch reflecting telescope of this Observatory, and a method was suggested of deriving the "visual" magnitude from the iso-chromatic plates.

The two kinds of plates used in this work were Seed 27, the "ordinary" brand, and Wallace's Pan-iso plates. 400 color pairs were obtained, and the photometric magnitudes obtained by the formula

$$M = a - b\sqrt{D}.$$

The results were correlated in several different ways: first, the difference in magnitude between Seed and Pan-iso, when formed, was called the color intensity; secondly, the magnitudes of thirty stars, obtained from Pan-iso plates, were compared with the Potsdam magnitudes obtained photometrically, the agreement showing by the small differences that visual magnitudes could actually be obtained from photographic plates;

thirdly, a list of forty-nine stars was arranged in order of color intensity and tabulated, the spectra showing that as the stars advanced in type, the color intensity became greater; *e.g.*, two V type stars at the beginning of the list had color intensity .02 and .03, and two K-M stars at the end had 1.83 and 1.86. The two sets of values in the table were plotted, the spectral types being laid off as ordinates, and the differences in magnitude, *visual* — *photographic*, as abscissas, and the accompanying curve was drawn.

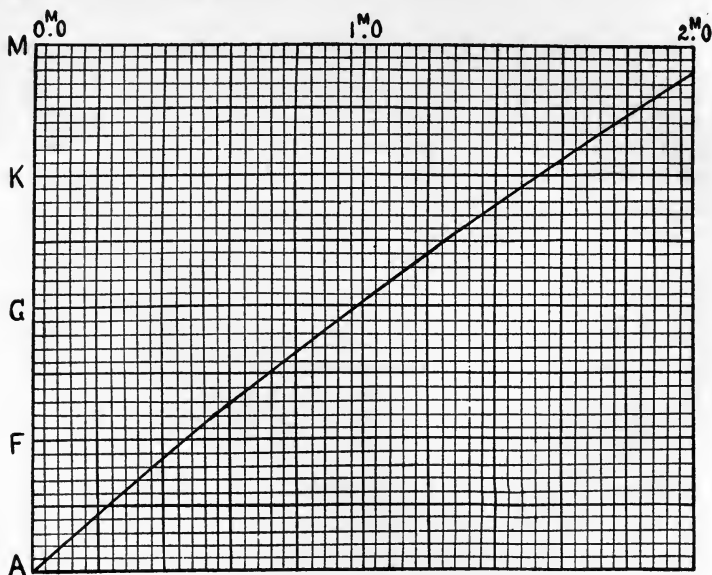

Figure 22

## SPECTRAL TYPE AND COLOR INTENSITY

The same curve can be used to obtain the spectral type for faint stars, since the difference *vis.* — *photog.* magnitude can be obtained by comparing the results from the two sets of plates, and the resulting  $\Delta m$ , or color intensity, when used as an abscissa with the curve, will give for the ordinate the spectral type.

A similar curve was obtained by King,<sup>1</sup> working at Harvard Observatory, in a different manner. He obtained photographic magnitudes of 109 bright stars by measuring the densities of their extra-focal images, in a manner presently to be described, and compared them with photometric measures from the *Revised HP*. The differences were then arranged in order of spectral type, Oe — M. The means of the values of  $\Delta m$  were taken, and the results plotted as abscissas with the spectral type as ordinate, resulting in a curve very similar to that of Parkhurst.

Reference has just been made to the method of obtaining photographic magnitudes by means of measuring the density of extra focal images. As the process is somewhat complicated a rather detailed explanation is necessary. The extra focal images must be compared with a series of standard images, the densities of which have been measured, and correspond to known differences in magnitude. The two sets of images cannot be compared directly, but through the medium of a photographic wedge, which may be prepared in several different ways, the only requisite being that the increase of blackening must be uniform. The method of preparing the wedge at Harvard<sup>2</sup> is to expose a plate to light entering through a triangular-shaped opening bounded by logarithmic curves instead of straight lines. Most of the photographic wedges in this country have come from this Observatory. The wedge and the standard scale are first placed in the measuring machine, and readings taken for the different standard images on it. Then the scale is removed, the star image brought into the field, and the wedge moved until the two densities match and the reading is taken. From these readings the differences in magnitude may be obtained.

At the Harvard Observatory<sup>3</sup> the custom is as follows. Each plate is capable of receiving forty images. The usual order is to

<sup>1</sup> *Annals*, H.C.O., vol. 59, nos. 4, 5.

<sup>2</sup> E. S. King, *Annals*, H.C.O., 41, 237, and 59, 36.

<sup>3</sup> E. S. King, *Annals*, H.C.O., 59, 95.

expose first on Polaris once or twice, and then to take a number of stars, at foci so chosen as to form images of nearly the same density as Polaris. Next some bright star, as  $\alpha$  Lyrae, at each of the different foci is taken, in order to obtain a scale of magnitudes; and finally, Polaris is again taken. As a result the standards and the star to be measured are on the same plate, and are subject to exactly the same conditions of exposure and development.

At Yerkes Parkhurst and Jordan<sup>1</sup> used a set of standard magnitudes, obtained by illuminating squares in a sensitometer box by light passing through holes of different diameters. These magnitudes were investigated and a table formed which gave the value  $\Delta m$  for each degree of blackening compared with that from the first hole taken as a standard. The values of  $\Delta m$  were made the abscissas for the curve of the wedge, and the ordinates were the scale readings corresponding to different thicknesses of the wedge. The measurements were taken with the Hartmann photo-micrometer. This method has been used especially in measurement of light curves of short period variables. At Harvard the method has been employed for determining the magnitudes of bright stars.

Still another method of determining stellar magnitude by means of photographic images has been used successfully at Harvard for many years. A series of photographic images is prepared which represent certain differences of magnitude. The unknown stars are then compared with the scale, the differences being estimated to tenths. The initial point of the scale is then found by referring to the magnitude of some known star on the plate. The scale plate at Harvard<sup>2</sup> was prepared by taking a plate of the Hyades, and giving it successive exposures of 3, 9, 27, 81, 243, 729 seconds, the telescope being moved between each two exposures. Each star image thus received about three times as much light as the one preceding it, in order to make the series represent differences in brightness equivalent to one magnitude. This ratio was adopted rather

<sup>1</sup> *Ap. J.*, 26, 245.

<sup>2</sup> *Annals*, H.C.O., 18, 120.

than 2.5, as experiments showed the latter ratio to be too small. From the photograph thus taken the strip of images of one star was cut out and mounted in a suitable frame. It was protected by cementing a piece of thin cover-glass over it, and a handle served to hold it over the image to be measured in such a way that the comparison was readily made.

This method has been applied to a study of variable stars. Sequences of comparison stars have been selected, and their magnitudes determined by comparing them with the standard plate. The magnitudes of the variables have then been determined by Argelander's method of estimation.

It would be impossible in the brief space allowed to this chapter even to mention all that has been done in photographic photometry, but it is hoped that the main points have been covered. An excellent résumé of the subject is to be found in a brief paper by Pickering, H.C.O., *Annals*, vol. 71, no. 1.

The suggestion has also been made that in order to eliminate any errors arising from imperfections in the eye, which still must be used in making comparisons even with the photomicrometer, it might be possible to introduce some automatic device which would replace the eye, such as a galvanometer, and use it in measuring the density of the star image. In *Harvard Circular*, no. 155, Pickering considers the possibility of such devices, and suggests several, such as the thermal-pile, bolometer, radiometer, or selenium cell. The only duty left for the eye to perform would be to read the deviation of the indicator. These methods have not as yet been applied to the measurement of photographic images, though the selenium cell has been very successfully used by Stebbins in observing with the telescope. A description of his work will form part of the next chapter.

## CHAPTER VIII

### PHOTO-ELECTRIC PHOTOMETRY

Two more types of photometer have been introduced lately which bid fair to supersede the older ones, particularly for stars where the fluctuations in light are small, yet rapid. In both types the light from the star is received on a surface which is electrically sensitive, so that a change in the intensity of the light falling upon it causes a change in the resistance, or potential, which is registered by some electrical apparatus. The two types in use (so far as the writer knows) are the selenium cell, successfully adapted by Stebbins<sup>1</sup> at the University of Illinois for stellar photometry, and the photo-electric cell, which has been studied for some time in physical laboratories, but has only recently been applied to problems of astronomical photometry, among others by Guthnick<sup>2</sup> at the Observatory of Berlin, Meyer and Rosenberg<sup>3</sup> at Tübingen, and Schultz<sup>4</sup> at the University of Illinois. The material in this chapter is taken from papers published by these men.

The great value of these photometers lies in the fact that they are sensitive to extremely small variations in brightness. With both cells the difference in stellar brightness can be measured with an error of  $\pm .006$  for a normal magnitude. The selenium cell will be described first.

The physical principle on which it is based may briefly be stated as follows. The crystalline form of selenium changes its electrical resistance when exposed to light, or under certain circumstances it gives an electro-motive force when illuminated, hence this form, with electrodes attached, was early called a selenium cell. The theory of its application to stellar photom-

<sup>1</sup> *Ap. J.*, 27, 183; 32, 185; 26, 326; 39, 459; 34, 112. *Pop. Ast.*, 19, 1.

<sup>2</sup> *Veröff. der K. Sternwarte zu Berlin-Babelsberg*, Band 1., Heft 1.

<sup>3</sup> *V.J.S.*, 48, 210.

<sup>4</sup> *Ap. J.*, 38, 187.

etry is very simple. The method proposed is to attach the selenium cell, in a closed case, to the end of the telescope, expose its surface to the light of a star, and note the change of resistance by means of a galvanometer. The great objection to its employment is that the resistance of selenium is affected by other agencies than light, and is difficult to handle on that account.

The cell used by Stebbins is made by winding wires in a spiral form about a flat surface, about 50 x 26 mm. in area, and filling the space on one side with selenium which has been made sensitive. The best process of sensitizing it is a commercial secret. The wires pass out at the back of the surface and are connected with the measuring apparatus. After many experiments, it was found that the following precautions in the use of the cell were necessary. First, the selenium should be kept at a uniform low temperature,  $0^{\circ}$  C., or lower. Second, the current should pass continually through the selenium. Third, exposures to light should be short, as ten seconds, with longer intervals for recovery. In consequence of the first requirement the cell is placed in an ice chamber, which is then attached to the twelve-inch telescope. In warm weather the ice is renewed every day, but in winter this is not necessary. A small shutter may be opened in order to expose the cell to starlight. The current is supplied by a few dry cells, giving an E.M.F. of six volts. For best results it must be applied steadily, as it has been found that if a selenium cell of 3,000,000 ohms is used the resistance decreased slowly, until, after half an hour had elapsed, a steady condition is reached. This requires that the current should be started at least half an hour before observations can be begun. Selenium also requires time for recovery from light action. Hence if it has been exposed ten seconds to light from a star, a wait of about a minute is necessary in order to allow it to regain its sensibility.

As arranged for measurement, the selenium cell is made one arm of a Wheatstone bridge. Two of its other arms are constant, and the fourth can be varied to produce a balance with

the cell, the resistance of which may change from night to night. The deflection is read by a d'Arsonval galvanometer, which is at rest when the four arms are in balance. The zero point does not remain stationary during the evening, owing to small temperature changes in the selenium cell. Hence, on beginning a night's work a series of readings is taken, which is repeated once an hour in order to determine its rate of change, and the drift is interpolated for the time when the stars are measured. In practice the galvanometer and Wheatstone bridge are set up in a room some distance away from the dome, and here the observer is stationed. The assistant, who is at the telescope, makes the exposures by moving the shutter. In this case as with all other photometers, comparison stars are necessary. An observation, or "set," consists of opening the shutter of the cell for ten seconds in the order, four times on a comparison star, eight times on the variable, four times on the comparison star again, making sixteen deflections in all. As each exposure takes ten seconds, and the recovery one minute, the entire "set" requires about twenty minutes. In observing Algol from four to six sets were considered sufficient, unless it was near the time of minimum, either that of the principal, or of the expected secondary minimum.

Extra focal images of the stars are used as large as 7 mm. in diameter. "Other experiments have shown that for faint sources the galvanometer deflections are sensibly proportional to the light intensities, and therefore the ratio of the deflections (with Pogson's rule) gives at once the difference of magnitudes of the two stars." The following example will illustrate this. On January 7, 1910, comparisons were made of  $\alpha$  Persei and Algol, with the following results:—

$A = \alpha$  Persei, deflection 7.46 scale divisions,  
 $B = \beta$  Persei, deflection 6.33 " "

then  $\frac{A}{B} = \rho^{\Delta m}$ ,

$$\Delta m = \frac{\log 7.46 - \log 6.33}{0.4} = \frac{0.072}{0.4} = .18 \text{ mg.}$$



The probable error of a normal magnitude near the principal minimum was  $\pm .023$ , and near the secondary minimum,  $\pm .006$ , thus showing a better accordance than any kind of visual or photographic work. Corrections were made for the drift of the galvanometer zero and differential atmospheric absorption. While this method seems extremely simple in theory, in execution it is not so easy, since it requires no small amount of skill in manipulation.

The extreme sensitiveness of the cell has made it of great value, particularly in the observation of short period variables. The first and most striking result obtained by it was the discovery of the secondary minimum of Algol. This star is a well-known eclipsing binary, in which one component is bright, and the other, because of the absence of a secondary minimum, has long been called dark, though known to be of approximately the same size as the primary. From the first it seemed a difficult fact to accept, that in developing from the same primordial nebulous mass, one star should be bright and the other dark, and the eclipse theory was rejected by many astronomers. Later spectroscopic observations, by proving the binary character of the system, seemed to present further proof that the companion was in reality dark, for there was only one set of lines in the spectrum. The greatly increased sensitiveness of the selenium photometer over that of other kinds previously known offered an opportunity for testing the light of Algol at the time of the expected secondary minimum, and evidence of it was indubitable, as the curve in the first chapter shows. The variation in brightness amounted to .06 mg.

Other very interesting results have been published recently by Stebbins, on several spectroscopic binaries, the purpose being to discover if any of them are variables. Of the eleven stars examined, four were proved to show variation in brightness. Unfortunately, work with this photometer, though very accurate, is also slow, because the requirements are extremely exacting. When the comparison star is some distance from the variable, and it is desired to secure results correct to .01 mg., it

is useless to work on any but first class nights. So far Stebbins has not tried it on any stars fainter than third magnitude. In referring to other work he mentions the use of a potassium photo-electric cell by Schultz, and adds that such cells have been successfully used elsewhere.

The study of photo-electric cells is of such recent development that the subject is still one of a research character, and difficult to make clear in a simple way. The author will not attempt to give more than a superficial sketch of the fundamental principles, and then proceed to describe the apparatus in use at Berlin-Babelsberg. The theoretical exposition is taken largely from a recent volume of Allen<sup>1</sup> on *Photo-Electricity*, and only points which bear directly on stellar photometry will be mentioned. Some of the material can best be expressed in Allen's own words:—

The term photo-electricity is used in a general sense to designate any electrical effect due to the influence of light. Thus the change of electrical resistance of selenium when exposed to light is spoken of as a photo-electric action. The term is more particularly used to denote a change in the electrification of a body, due to the action of light. In accordance with modern electrical theory, light is an electro-magnetic disturbance, and any change in the electrification of a body is caused by the addition or removal of negative electrons. Hence, from this standpoint, a photo-electrical change is equivalent to the liberation of negative electrons, under the influence of electro-magnetic waves.

The first experiment showing this phenomenon was made in 1887, by Hertz, who noticed that when ultra-violet light fell upon the spark-gap, the electrical discharge took place more easily than when the gap was not illuminated, and the greater the actinic power of the source of light, the more powerful the effect. In the following year it was shown that the action had its seat at the cathode, or negative terminal of the spark-gap. In 1889 experiments by Elster and Geitel showed that electro-positive bodies, like sodium and potassium, manifested photo-electrical activity when exposed to ordinary light. Freshly polished surfaces of zinc and aluminum exhibit photo-electri-

<sup>1</sup> *Photo-Electricity, the Liberation of Electrons by Light.*

cal effect when exposed to sunlight, but when they are allowed to stand in air their activity rapidly diminishes. This is known as "fatigue." Later Elster and Geitel described a cell in which the sensitive surface is potassium, placed in an atmosphere of argon or helium, to secure permanence. It was designed for the measurement of sunlight: —

Within the last decade great progress has been made by carrying out experiments in a high vacuum, where conditions are much simplified through the absence of a surrounding atmosphere. Two principal methods of experiment may be employed [the second one of which applies particularly in this instance, and is the only one which will be referred to].

The current flowing between the illuminated plate and a parallel plate may be measured by a galvanometer or electrometer when a known difference of potential is maintained between the two plates. . . . The second method measures the number of electrons leaving the illuminated surface, and by varying the potential difference applied it is possible to find how the number depends on the strength of the electric field. . . . If an accelerating field is applied the number leaving the plate will rise to a maximum value, so that for further increases in the potential the current becomes approximately constant.

Experiments in a vacuum in which the intensity of the incident light was varied led to the important conclusions that . . . (2), the number of electrons emitted is directly proportional to the intensity of the light.

The practical application of this principle may best be understood by reference to the photometer of the Neu Babelsberg Observatory, which is depicted in Figure 23. In the diagram *KK* is the cell chamber, and *M* the cell. The potassium film forms the cathode terminal, "Kalium-Kathode," which is connected with the battery cells, which maintain it at a constant potential. The other terminal, the "Platin-Anode," is a wire of platinum, one end of which is bent into an open ring, and placed immediately over the cathode, while the other end passes out of the cell and is connected directly with the electrometer. Thus an electric field is formed in which a constant difference of potential is maintained.

The potassium surface thus corresponds to the illuminated plate, and the "Platin-Anode" to the parallel plate. The light from the star, in the form of an extra-focal image, falls upon the potassium surface and liberates electrons which escape from it, are caught on the platinum ring, and give up their charge, which is conveyed along the wire to the electrometer.

Since in a vacuum the number of electrons emitted is proportional to the intensity of the incident light, it follows that by means of the currents measured by the electrometer we can determine the relative intensities of the light from two stars, and hence find their difference in magnitude.

This brief statement shows theoretically the action taking place in a photo-electric cell. With it as a preface we can more easily understand the principal parts of the apparatus of Guthnick and Prager, which will now be described, as far as possible in their own words. A study of the diagram will greatly aid in the understanding of the instrument, which is attached to a 30 cm. refractor of 5.1 meter focal length.

The apparatus, as used with the telescope, consists of four parts: the cell chamber with the cell, the electrometer, the batteries for supplying the current for the cell and the electrometer, and the part used in setting on the star. The first three are the necessary equipment of any photo-electric cell, and the last is needed only for stellar work. Several accessories are mentioned which are required for testing various parts of the instrument and other purposes.

In the diagram *AA* is the ocular end of the telescope. The focal point is in the plane *BB*, where an iris diaphragm permits the light of the star to pass through, but shuts out all extraneous and disturbing light, such as that from other stars, or from the heavens when brightly lighted by the moon. The cell is about 20 cm. farther out, and hence the light falling on it is from an extra-focal image of the star.

This is in order to diminish the disturbing effects of specks of dust which will collect on the outer walls of the cell and the

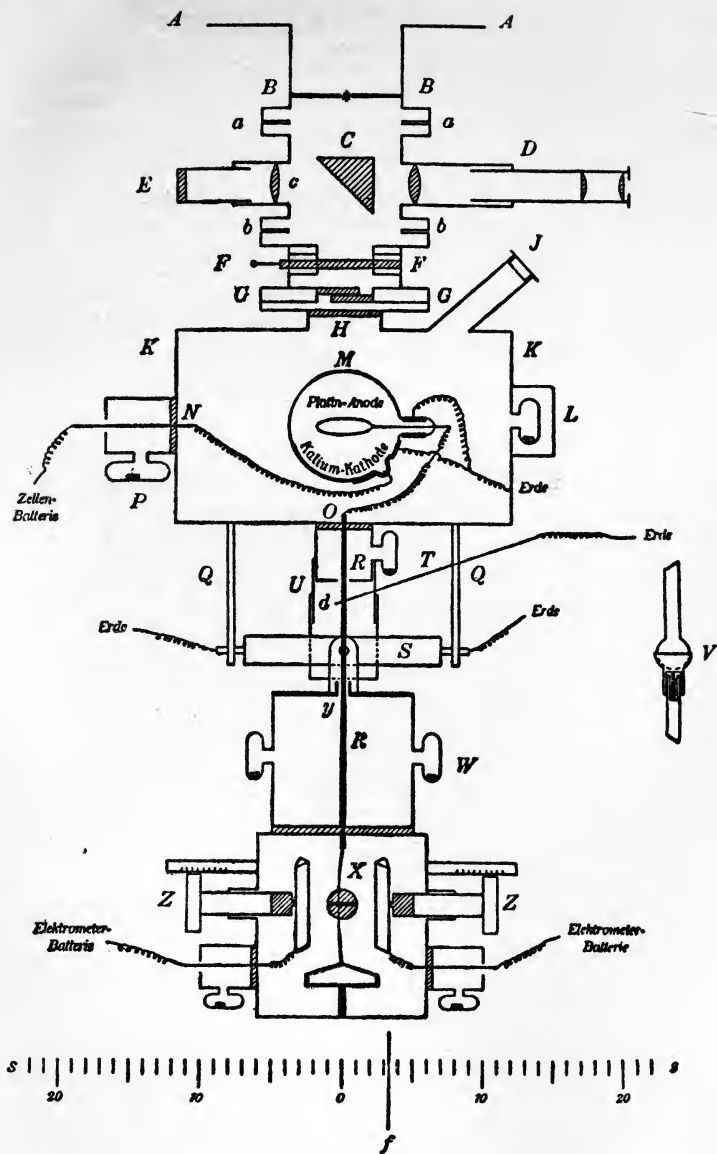

Figure 23

DIAGRAM OF THE PHOTO-ELECTRIC APPARATUS, BERLIN-BABELSBERG

glass window, *H*, of the cell chamber. As far as the measurements are concerned, it is immaterial in which part of the cone of rays the cell is placed, so long as all of the light from the objective reaches it.

The cone of rays falls upon the right-angle prism, *C*, and is reflected out into the small telescope, *D*. Looking into the eyepiece, the observer sees the opening of the iris diaphragm, with the star in its center. The opening ranges from 1' to 2' in diameter, in order to prevent the violet rays from being cut off by its edges. With a reflector, where there is no chromatic aberration, the opening might be made still smaller, thus reducing the brightness of the sky background.

The hypotenuse of the prism is silvered, in order that artificial light entering through *E* may fall upon the cell for purposes of testing it. As soon as the image of the star is properly adjusted, the telescope, *D*, and the prism, are slid out of the way, so that the beam of light will fall upon the cell. *FF* is a metal plate which cuts off all light from the cell when it is not in use. *H* is a glass window, which serves to protect the chamber, *KK*, as far as possible, against the outside air. There are screws for adjusting the floor of the chamber so that the cell, *M*, shall lie in the optical axis of the telescope. *J* is an opening into the chamber, which can be used for examining the cell directly. The interior of the cell is kept dry by sodium, which is placed in the receptacle, *L*. A wire goes from the cathode terminal through the amber plate, *N*, to the battery cells, while the anode passes through a similar plate, *O*, directly to the electrometer.

The electrometer,<sup>1</sup> *W*, is suspended by a special device, which permits it to hang perpendicularly no matter what the inclination of the telescope tube. This device is indicated in the diagram by *S*, and is itself supported on two strong metal bars, *QQ*, with ball bearings to insure easy motion. The anode wire ends at *O* in a metal bar, about 3 mm. in diameter, which is directly connected with the electrometer thread, *X*. There will

<sup>1</sup> Theod. Wulf, *Physik. Zeits.*, 15, 250.

be a joint in this bar, as it passes through the support, *S*, and in order to make a perfect contact, a special connection is introduced, which is illustrated in the side diagram, *V*. The bar ends in a sphere. In contact with it is a hollow hemisphere, fastened to a hollow cylinder, which rests upon the lower part of the bar, *R*, and is pressed against the spherical end of the upper part by means of a spiral spring within, thus insuring perfect contact in every position of the telescope. *R* is protected by a metal tube, *U*. The electrometer is a string electrometer, and its thread is observed with a micrometer of high magnifying power, having an ocular scale in the eyepiece, with a zero-point in the middle of the field. That part of the scale is used which lies on the right, or positive, side of zero, as far as division 30 (see drawing in lower part of the plate). The entire apparatus is protected at various points by wires leading to the earth, which serve to carry away any electrostatic charges which may collect upon it, due to external causes.

Briefly described, the operation of observing a star is as follows. After the star has been brought into the middle of the field, the telescope, *D*, and prism, *C*, are drawn out of the way. The connection between *R* and the earth is broken, and the electrometer thread begins to move.

Four times are registered on the chronograph. (1) Just before breaking the ground connection, the position of the thread while at rest is read, and the first time,  $T_1$ , is recorded. (2) When the thread passes over the third or fifth division farther on, the choice depending on the rate of motion, the second time,  $t_1$ , is recorded. (3) The passage over the fifth or tenth division beyond is recorded for the third time,  $t_2$ . If the zero-point is at division three, as indicated in the diagram, then the transits occur over the sixth and eleventh threads, or the eighth and eighteenth threads, depending upon the rate of charging. The thread is then discharged by an earth connection; it comes to rest, and the time,  $T_2$ , is again noted, making the fourth in the series. Before showing how the reduction is made from these observations it will be necessary to recapitu-

late the principles on which the measurement rests. The authors, Guthnick and Prager, state:—

The number of electrons liberated, that is, the observed photoelectric effect for alkali cells, as Elster and Geitel have proved rigorously, is proportional to the intensity of the illumination. The measured velocities of the electrometer thread are proportional to the brightnesses of the stars. This latter statement can be considered quite exact while the variations remain small.

The derivation of the formula for applying this principle is as follows:—

Let  $H_0$  be the apparent brightness of the observed source of light,

$N_1$  and  $N_2$  be the readings of the zero point at the times  $T_1$  and  $T_2$ ,

$S$  be the number of scale divisions passed over in the interval of time  $t_2 - t_1$ ,

$\Delta N$  be the change in the zero point during this interval;

then  $H_0$  is proportional to  $\frac{S - \Delta N}{t_2 - t_1}$ .

To find  $\Delta N$  we have

$$\frac{N_2 - N_1}{T_2 - T_1} = \text{the rate of change in the zero reading,}$$

$$\Delta N = (t_2 - t_1) \frac{N_2 - N_1}{T_2 - T_1},$$

and 
$$H_0 = \frac{S - (t_2 - t_1) \frac{N_2 - N_1}{T_2 - T_1}}{t_2 - t_1}.$$

There follows the scheme of recording the measurements and their reduction, only a part of which will be given.

1914, May 22, comparison of  $\gamma$  Boötis with  $\delta$  Urs. Maj., Obs. Prager,  $S = 10^d$ , corr. to clock  $- 0.^m3$ .



a. The Measurements

b. The Reduction of the Measurements

Star	$\delta$ Urs. Maj.	$\gamma$ Boötis	$\delta$ Urs. Maj.
Sid. T.	17 <sup>h</sup> 29 <sup>m</sup> .7	17 <sup>h</sup> 35 <sup>m</sup> .7	17 <sup>h</sup> 45 <sup>m</sup> .2
N <sub>2</sub> - N <sub>1</sub>	- 0 <sup>p</sup> .08	- 0 <sup>p</sup> .01	+ 9 <sup>p</sup> .18
T <sub>2</sub> - T <sub>1</sub>	29 <sup>s</sup> .7	24 <sup>s</sup> .1	29 <sup>s</sup> .1
t <sub>2</sub> - t <sub>1</sub>	19 <sup>s</sup> .48	15 <sup>s</sup> .47	18 <sup>s</sup> .98
(t <sub>2</sub> - t <sub>1</sub> ) : (T <sub>2</sub> - T <sub>1</sub> )	0.66	0.64	0.65
$\Delta N$	- 0 <sup>p</sup> .05	- 0 <sup>p</sup> .01	+ 0 <sup>p</sup> .12
log (s - $\Delta N$ )	1.0022	1.0004	0.9948
log (t <sub>2</sub> - t <sub>1</sub> )	1.2896	1.1895	1.2783
log H <sub>0</sub>	9.7126	9.8109	9.7165

[In this the small value of  $\Delta N$  is seen at once. From the values of log H<sub>0</sub>, which are proportional to the brightnesses, the values of  $\Delta m$  can be found by Pogson's rule.

$$\frac{H'}{H_0} = \frac{A}{B} = \rho^{\Delta m}$$

$$\Delta m = \frac{\log A - \log B}{0.4} = \frac{\log H_0 - \log H'_0}{0.4} = \frac{9.8109 - 9.7126}{0.4}$$

$$= \frac{0.0983}{0.4} = .246.$$

If the magnitudes of  $\gamma$  Boötis and  $\delta$  Urs. Maj. are taken from the *Potsdam Durchmusterung*, the value of  $\Delta m$  is found to be

$$3.34 - 3.52 = .18.^1$$

The corrections for loss of light, "extinction," offer much difficulty, since they arise from several different causes. Firstly, varies with the transparency of the atmosphere; thirdly, the loss of light is dependent upon the spectral type; secondly, it transparency of the atmosphere for the violet end of the spectrum is least shortly after the end of twilight, and increases during the night, but not regularly. This is particularly true of

<sup>1</sup> Author's note.

nights which follow hot days. The entire matter requires much further investigation. Some results of the observations with the photo-micrometer will now be given.

Conclusive proof is furnished that certain spectroscopic binaries are variable stars of very small range. For instance,  $\beta$  Cephei, spectral type B 1, is a spectroscopic binary not hitherto suspected of variation. An exhaustive discussion of a long series of comparisons between this star and  $\alpha$  Cephei was made, the details of which cannot be given here. The following table contains the co-ordinates of the final mean light curve. The first column gives the phase, the second the difference in magnitude, ( $\beta - \alpha$ ) Cephei.

<i>Phase</i>	$\beta - \alpha$	<i>Phase</i>	$\beta - \alpha$
d	m	d	m
0.00	+ 0.142	0.09	+ 0.188
0.005	0.139	0.10	0.189
0.01	0.140	0.11	0.189
0.02	0.147	0.12	0.187
0.03	0.159	0.13	0.182
0.04	0.171	0.14	0.176
0.05	0.176	0.15	0.170
0.06	0.180	0.16	0.164
0.07	0.183	0.17	0.157
0.08	0.186	0.18	0.150
0.09	+ 0.188	0.19	+ 0.142

Other stars investigated and found to vary were  $\alpha$  Can. Ven. and  $\gamma$  Boötis. The same facts resulted from a preliminary study of  $\alpha$  Geminorum and  $\sigma$  Persei. A long list of stars which are under observation by Guthnick and Prager follows in the publication. It is composed of many stars which are either known or suspected to vary.

The probable error stated is not considered final, since not all of the systematic errors have been eliminated. The authors give, however, as the result from a series of observations of  $\gamma$  Urs. Min. and  $\zeta$  Dracon., the probable error of a comparison to be  $\pm 0.0060$  mg.

It will be seen that a method has been evolved which will furnish very accurate measurements of the differences in magnitude between two stars, but that the very sensitiveness of the apparatus makes it susceptible to disturbing influences, and that hence the sources of error are large. Such an instrument can be handled only by an expert. In an earlier article Guthnick states:—

The apparently small interest which the new method has aroused among astronomers until quite recently can well be explained by the fact that the physical and technical difficulties which must be overcome are appalling to the non-physicist, or even cause him to question its success.

He himself acknowledges his indebtedness to several physicists who aided him at different points in his work. The present writer has had to face the above-mentioned difficulties, and has depended upon her colleagues who are physicists to assist in making this explanation clear, and therefore begs the indulgence of the reader if the language is untechnical and the presentation not complete.

Before closing this chapter it might be well to bring to the mind of the reader in a brief survey the chief events in the history of the study of stellar magnitude. Beginning with the crude classification of Hipparchus, of the lucid stars into six divisions called magnitudes, we find next that Ptolemy recognized the fact that all of the stars of a certain group were not of the same brightness, and assigned to those which differed perceptibly the letters  $\mu$  and  $\epsilon$ , signifying greater than or less than the average. His estimations were adopted, and maintained until comparatively recent times. Herschel, in 1780-90, felt that the brightness of the stars ought to be more carefully observed, and introduced symbols, which indicated varying

degrees of difference, beginning with the least perceptible. In the early part of the nineteenth century photometers of various kinds began to be introduced into physical laboratories, and were then applied to the study of the light of the stars, but work with them depended in every case on the magnitudes of stars already known. The notation of Ptolemy had given way to such notation as that used by Argelander, where intermediate grades were designated by 6.5 or 5.6. Later, in working on the great *Durchmusterung*, where multitudes of stars passed before the observer's eye, small differences became apparent, with the result that estimations were made directly to tenths of magnitudes.

Photometers were improved from time to time, until the various forms of polarizing instruments reduced the error to a smaller amount than had been known before. Soon after the middle of the nineteenth century photographic photometry began to develop, bringing in its train the study of color and spectral type, and their important effect on the photographic magnitude. This ended in the method of measuring the density of the star image taken out of focus, which was the last and best method of determining difference of magnitude. As a twentieth-century advance we have instruments in which the starlight falls upon electrically sensitive surfaces, such as the selenium cell and the photo-electric cell. With the former the secondary minimum of Algol, of only .06 mg., was discovered, and its accuracy could be measured by the probable error of a normal of  $\pm .006$ . The photo-electric cell will show the variation in light of a spectroscopic binary when the entire range is only .05 of a magnitude, and a single comparison has a probable error of  $\pm .006$ .

Both of these latter methods give results of the very highest degree of accuracy, but the manipulation and care of the instruments is beset with difficulties, so that only an expert can handle them. When they have been thoroughly tested, and their use has become a little more common, we can hope to derive many important results from them. Their sensitiveness

makes them suitable for the study of short period variables of rapid change, and for such important and perplexing stars as  $\beta$  Lyrae.

While the eye cannot measure accurately the relative brightness of two stars of different color, every photometric apparatus suffers from the same disability, and either a correction must be made for the spectral type, or some device introduced for making the colors of the two objects alike. While the eye may be called our natural photometer, it is not sensitive enough to very small differences of brightness, and hence must be replaced by more sensitive surfaces, and itself be relegated to such duties as reading the deflections of a galvanometer or electric thread; so that in place of looking at a field of stars, a beautiful and thrilling sight to the astronomer, he must perforce content himself with reading a scale. As one writer<sup>1</sup> puts it:—

If it should be possible to develop a color absorbing screen which should make the resultant spectral sensibility curve that of an average eye, then it should be possible to tie down to a purely physical instrument the characteristics of that wonderful, but most troublesome, physiological one, — the human eye.

Both of the methods described in this chapter are too refined for the observation of long period variables, and amateur workers may still plod along making their observations by the Argelander step method and feel that their work, if carefully done, will be of scientific value.

<sup>1</sup> Herbert E. Ives, *Ap. J.*, 39, 430.

## CHAPTER IX

### FORMATION OF LIGHT SCALE

THE magnitudes of the comparison stars for a variable may be obtained by means of a photometer, basing the determinations upon a few stars whose magnitudes can be found in some one of the recognized series such as the Harvard or Potsdam photometries. If, on the other hand, the observer has no photometer at his disposal, but must make all of his observations by the Argelander method, there are two possibilities before him. He may confine himself to stars which can be found on the Hagen charts, the Harvard photographs, or some other published map; or he can study the variation of light of some new variable for which no list of comparison stars has been published. In the latter case he can determine the magnitudes of the comparison stars from the observations by making use of the estimations of the variable, and combining with them inter-comparisons among the stars themselves. Since this latter case is of very frequent occurrence, it is important to give a full description of it here, with an example.

The observations in the present illustration are taken from a collection made by Schönfeld<sup>1</sup> at the Mannheim Observatory in 1871, the star being  $\delta$  Cephei. As given below they are not an exact copy of the text. The hour has been expressed as a fraction of a day, the letter  $v$  has been used to indicate the variable, and the order of the comparisons has been changed so that the brightest star is placed first. Schönfeld frequently made use of a quarter of a step, *e.g.*,  $v$  2.5–3  $a$ , which is equivalent to  $v$  2.8  $a$ , but only the final value has been used in the example. Remarks referring to the brightness of the sky as indicated by the presence of the moon are also omitted. The observations as thus re-arranged are as follows:—

<sup>1</sup> Dr. W. Valentiner, *Veröff. d. Grossh. Sternwarte zu Heidelberg*, 1, 43.

TABLE I

No.	Date, 1871	Estimation	Light step	Mean	.052×L	Adopted
	da.				mg.	mg.
1	May 3.5	a 1 v, v 4 ε	4.0, 4.0	4.0	.21	4.02
2	6.5	ι 1.8 v, v 2.8 a	7.7, 7.8	7.8	.41	3.82
3	7.5	ι 3 v, v 1 a	6.5, 6.0	6.2	.32	3.91
4	13.5	a 1.8 v, v 3.5 ε	3.2, 3.5	3.4	.18	4.05
5	14.5	a 3 v, v 2 ε	2.0, 2.0	2.0	.10	4.13
6	16.5	ζ 1 v, v 0.5 ι	9.9, 10.0	10.0	.52	3.71
7	17.5	ι 3 v, v 1.2 a	6.5, 6.2	6.4	.33	3.90
8	19.5	a 2.8 v, v 2.5 ε	2.2, 2.5	2.4	.12	4.11
9	21.5	ζ 1.2 v, v ι	9.7, 9.5	9.6	.50	3.73
10	22.5	ι 2.2 v, v 2.5 a	7.3, 7.5	7.4	.38	3.85
11	23.5	a 0.2 v, v 5 ε	4.8, 5.0	4.9	.25	3.98
12	24.5	a 2.8 v, v 2.2 ε	2.2, 2.2	2.2	.11	4.12
13	25.5	a 3.2 v, v 1.5 ε	1.8, 1.5	1.6	.08	4.15
14	28.5	ι 4 v, v 1 a	5.5, 6.0	5.8	.30	3.93
15	29.4	a 2.5 v, v 2.8 ε	2.5, 2.8	2.6	.14	4.09
16	31.5	a 2 v, v 2.5 ε	3.0, 2.5	2.8	.15	4.08

The first column gives the number of the observation, the second the day, and the third the comparison. The remaining columns will be explained later. It will be noticed first of all that four stars are used, *a*, *ε*, *ι*, and *ζ*. On looking at the list of comparison stars which is to be found on p. 264 of the same volume, we find that these are 7 Lacertae, = *a*, *ε* Cephei, *ι* Cephei and *ζ* Cephei. In every observation two of them are used, and by means of the variable itself we can find the number of steps between them. For example, in the first observation we have *a* 1 *v*, *v* 4 *ε*, from which we obtain *a* 5 *ε*, and so on. Looking over the list of observations, picking out

the pairs of stars which are used together, and placing the steps in order under each pair, we find the following combinations:—

$a \epsilon$	$\iota a$	$\zeta \iota$
5.0	4.6	1.5
5.3	4.0	<u>1.2</u>
5.0	4.2	1.35
5.3	4.7	
5.2	<u>5.0</u>	
5.0	4.50	
4.7		
5.3		
<u>4.5</u>		
5.03		

The next step is to arrange these in order so as to form a light scale among the stars, which may be done by placing either the faintest or the brightest star at the bottom or zero end of the scale. Both methods are in use. Schönfeld and Parkhurst employ the former, and Heis and Hagen the latter. In the present case the faintest star will be given step zero. This is obviously the star  $\epsilon$ . The four when tabulated in order will then be as follows:—

TABLE II

<i>RHP.</i>	<i>Star</i>	<i>L. S.</i>	<i>Mag.</i>	$\Delta M$
8494	$\epsilon$ Cephei	0.0	4.23	
8585	7 Lacertae	5.0	3.85	.38
8694	$\iota$ Cephei	9.5	3.68	.17
8465	$\zeta$ Cephei	10.9	3.62	.06

The fourth column in Table I contains the result obtained by making use of the light step of the comparison star as found in Table II to find the light step of the variable. For example,



in the first observation,  $a$  1  $v$ ,  $v$  4  $\epsilon$ ,  $a$  is one step brighter than  $v$ , but  $a$  itself has a light step of 5.0, hence  $v$  must have light step 4.0 on the same scale. Also if  $v$  is four steps brighter than  $\epsilon$  and  $\epsilon$  is 0.0, then again  $v$  has light step 4.0. It happens that the comparisons from these two stars agree exactly, but such is not always the case, as will be seen by following down the column. The fifth column contains the mean of the separate results in the preceding column.

Since we have found the brightness of the variable in steps according to the light scale, it is possible to plot the observations and from them find the character of the curve, that is to say, the period and time of maximum or minimum. Instead of this the steps may be turned into magnitudes, and the results plotted giving the light curve in magnitudes. The latter method will be followed here.

The comparison stars, being all bright, are found in the *Revised Harvard Photometry (RHP.) Annals*, H.C.O., vol. 50, from which their numbers in Table II are taken, together with their magnitudes. The difference in magnitude between successive stars is equivalent to the number of steps between them, *i.e.*, the number of steps between  $a$  and  $\epsilon$  is 5.0, and the difference in magnitude .38, hence to find the value of one step we must divide the difference in magnitude by the number of steps. Proceeding in this manner we find the following results from the different pairs of stars:—

$$a \epsilon = .076, \quad \iota a = .038, \quad \zeta \iota = .043; \quad \text{mean value} = .052.$$

By substituting these directly in the column giving the light step of the variable we shall obtain its brightness expressed in magnitudes. The substitution may be represented by the formula

$$M = 4.23 - .052 \times L,$$

where  $L$  stands for the light step of the variable in column 5, *e.g.*, for the first observation,

$$M = 4.23 - 4.0 \times .052 = 4.02.$$

The sixth column contains the product  $.052 \times L$ . Its value, when subtracted from the constant quantity 4.23 mg., will give

the observed magnitude of the variable, which is found in the seventh column.

In plotting these observations, it is necessary first to select the scales according to which the two co-ordinates are to be drawn. While it is impossible to give any specific advice on this subject, in general it may be said that care should be taken to have the resulting curve in a fair proportion; that is, it should not be too tall and slim, nor should it be too short and flat. Furthermore, attention should be paid to the division of the squares on the paper used. A very convenient kind of squared paper in which every fifth line is heavier can be purchased from the various school supply companies. If a large square is taken as a unit, then each small one will represent two tenths. If a large square represents ten or twenty days, then the small ones will be one fifth of this unit. A division into tenths or fifths is thus obviously more convenient than one into sixths. In the curve given below, the scale is as follows: for the abscissas one large block equals 2 days and a small one .4 day, and for the ordinate one large block is .15 mg. and a small one .03 mg.

If the observations are sufficiently well placed it will then be possible to determine the time of a maximum and the length of the period. In the present case the length of the period can be determined more easily than the time of maximum, since the observations about May 16 and 21 are not well distributed. Still, since the star is a short period variable, the two times of brightest magnitude could be used for maxima. This point will be illustrated more fully later on in the chapter on the mean light curve, where this same star,  $\delta$  Cephei, is used as an example. Usually the length of the period is obtained by finding the time between successive maxima, but in this case it may be found by taking the interval of time between two similar magnitudes on corresponding branches of the curve, for example, the star has mg. 4.05 on the descending slope of the curve, on the dates 24.0 and 29.24; hence its period from these two observations is 5.24 days. A longer interval may also be taken, as

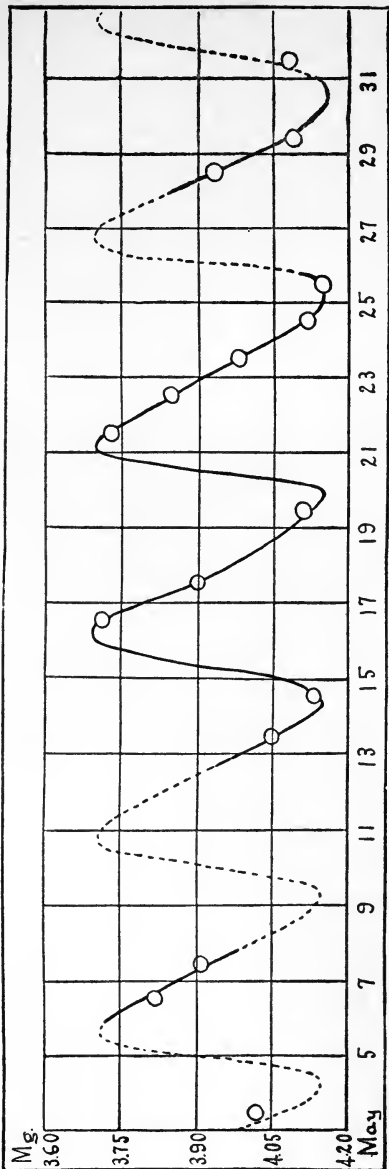

Figure 24  
SINGLE LIGHT CURVES OF  $\delta$  CEPHEI

13.4 to 29.24, or 15.84 days, which is equivalent to three periods, making one period 5.28 days in length.

The usual method of determining the time of maximum for a long period variable is, first, to draw a smooth curve through the observations. By this is meant that there should be as many points on one side of the curve as on the other and that the aggregate distances of the points from it should be equal on both sides. To use a familiar illustration, it should be like a tug of war where neither side has the advantage. The pull on one side should balance the pull on the other.

After the curve has been finished, draw chords parallel to the time axis and bisect them. Draw a line through the points of bisection and continue it until it cuts the curve. The abscissa of the point of intersection will give the time of maximum, and the ordinate the corresponding magnitude or light step, as the case may be. In drawing the chords care should be taken to have them distributed fairly well, with as many as convenient near the top of the curve. The line which passes through their middle points may itself be a curved line, and there may be observations which give a higher magnitude than the curve represents. Figure 25 is plotted from observations of  $\alpha$  Ceti made by Heis,<sup>1</sup> and published in the collection of his observations edited by Hagen. They extend from 1848, Aug. 25, to Jan. 22, 1849, or from Julian Day 239 6267 to 239 6415, as will be seen in the accompanying Table. The variation is represented in light steps, the zero being taken for the brighter magnitudes. Since the variable is of long period, no account is taken of the fraction of a day. Inspection shows that two points at least represent higher magnitudes than the curve. Following the directions given above, for bisecting the chords and drawing a line through the points thus determined, we find that the time of maximum is Julian Day 239 6316 and the light step 3.3 on the given scale.

<sup>1</sup> *Beobachtungen veränderlicher Sterne*, by Eduard Heis and Adalbert Krueger.

TABLE III

<i>Light step</i>	<i>J.D.</i>	<i>Light step</i>	<i>J.D.</i>
47.5	239 6267	6.7	239 6347
46.5	6268	7.8	6351
44.5	6273	8.9	6353
43.7	6274	8.9	6354
42.4	6275	11.2	6357
11.0	6291	13.5	6362
10.7	6292	13.5	6363
7.9	6296	20.6	6373
6.7	6297	22.6	6375
5.0	6301	22.1	6376
3.7	6303	23.4	6380
4.2	6307	25.7	6382
4.5	6321	26.2	6383
3.2	6323	28.9	6384
4.2	6326	29.2	6385
5.5	6333	28.6	6386
5.0	6334	32.6	6393
5.0	6339	45.2	6415

Before this value can be used in further work, the light steps must be changed into magnitudes. This can be done somewhat after the manner described for  $\delta$  Cephei, by making use of the magnitudes of the comparison stars as found in the various photometries. There is, however, another method, in common use at Harvard, according to which the relation between star magnitude and light step may be obtained. The magnitudes may be plotted as abscissas and the light steps as ordinates of points through which a curve is to be drawn, and this curve may then be used to find either co-ordinate when the other is

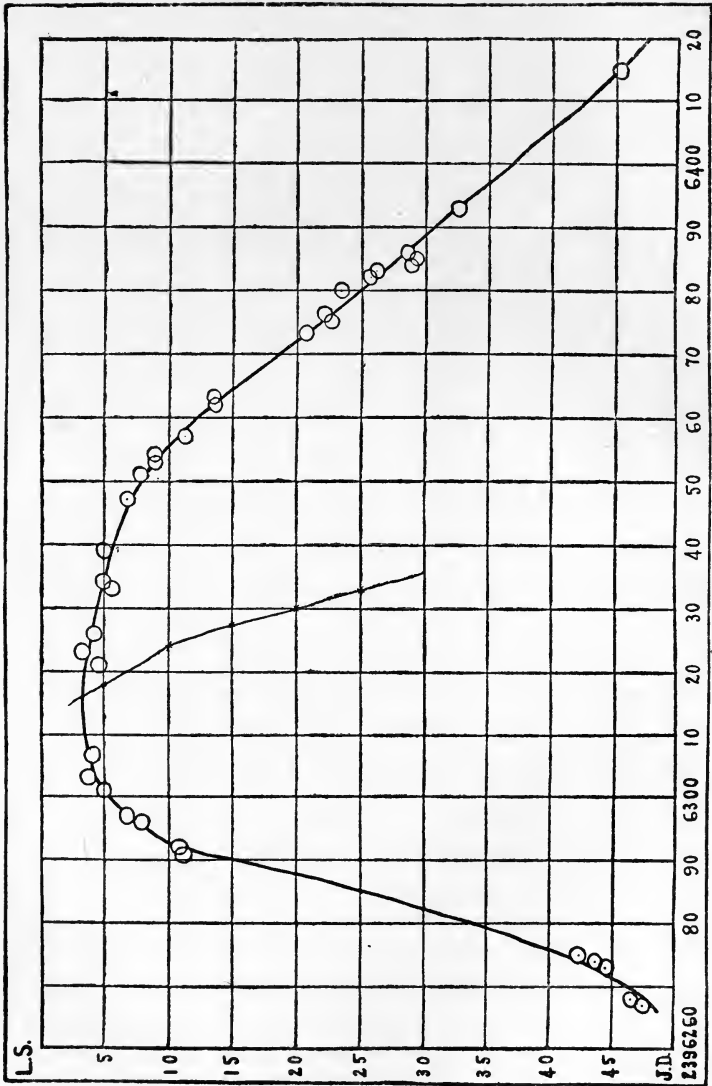

FIG. 25. LIGHT CURVE OF CETI

given. The necessary material for the example given below may be taken from Heis's observations of  $\alpha$  Ceti, from the beginning paragraphs, where Hagen has arranged in tabular form the comparison stars, their light scale, and the magnitudes according to several different authorities. Since this method is in such general use, it seems advisable to take the space here to give an illustration. The light steps are Hagen's, and the magnitudes are taken from the *Harvard Photometry*. They are as follows:—

TABLE IV

<i>Star</i>	<i>Step</i>	<i>H.P.</i>
$\alpha$ Ceti	0.0	2.8
$\beta$ Arietis	2.3	2.8
$\gamma$ Ceti	6.2	3.4
$\alpha$ Pisc.	9.6	3.8
$\delta$ Ceti	13.2	4.1
$\xi^2$ Ceti	16.8	4.3
$\mu$ Ceti	18.6	4.3
$\xi^1$ Ceti	20.5	4.6
$\lambda$ Ceti	23.6	4.7
$\nu$ Ceti	26.7	4.9
75 Ceti	30.6	5.5
63 Ceti	(31.0)	6.0
70 Ceti	33.6	5.6
84 Ceti	34.6	5.8
396 B	37.6	5.9

The accompanying curve was obtained by plotting the light steps and magnitudes as described above. Using the maximum light step 3.3, found on p. 176, we find the corresponding magnitude to be 3.06. Hence a maximum of  $\alpha$  Ceti occurred on J.D. 239 6316, or Oct. 15, 1848, with a magnitude of 3.06.

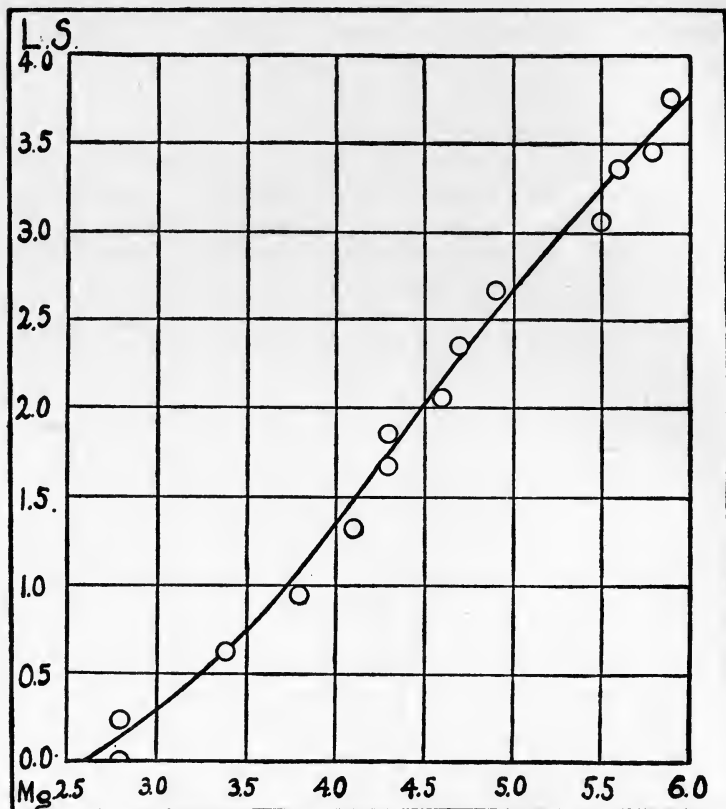

Figure 26

MAGNITUDE CURVE FOR  $\circ$  CETI

The example given for forming the light scale of the comparison stars from the observations of  $\delta$  Cephei involved only a few stars, since the variable was of small range, and it also happened that the stars were paired in the order of their light steps. It occurs sometimes that the different combinations overlap, *e.g.*, if  $v$  were compared with  $\delta$  and  $a$ , another pair would be introduced, and the resulting step difference would have to be com-



bined with the others. Sometimes several such groups occur, in which case it is necessary to alter somewhat the method of procedure, and in computing the final step for each star, to weight the individual means according to the number of observations included in each one. This may best be illustrated by reference to an example, and since one has been carefully worked out and published in an early number of the *Popular Astronomy*, by J. A. Parkhurst, the present author asked permission from him to incorporate it in this chapter, and it is given practically entire. The example presents a special advantage in that the star studied is a long period variable and hence there is a greater range of magnitude among the comparison stars.

I will use for an illustration my observations of 4557 S Ursae Majoris, from May to December, 1893, omitting for the sake of simplicity the comparisons of the comparison stars among themselves.

*Observations of 4557 S Ursae Majoris*

1893 May	11	<i>d 2 v, v 3 f.</i>
	17	<i>d 2 v, v 4 f.</i>
	27	<i>d 2 v, v 3 or 4 f.</i>
June	19	<i>f 1 v, v 1 g.</i>
July	1	<i>h 1 v, v 2 k.</i>
	10	<i>h 2 v, v k or v 1 k.</i>
Aug.	2	<i>m 2 or 3 v, n v or n 1 v, v 3 or 4 o.</i>
	11	<i>n v or n 1 v, v 1 or 2 o.</i>
	16	<i>n 1 v, v 1 o.</i>
	26	Moonlight, <i>v</i> not held.
Sept.	2	<i>n 2 v, v o, v 1 p.</i>
	6	<i>v</i> about <i>o</i> , faint, seeing bad.
	26	<i>v</i> about <i>m</i> , difficult, moonlight.
Oct.	7	<i>v m, v 1 or 2 n, low.</i>
	9	<i>l 1 or 2 v, v 2 m, seeing good.</i>
	22	<i>g 2 v, v 3 or 4 l, v 3 k.</i>
	30	<i>v 3 l, v g, f 2 v, v 3 k.</i>
Nov.	2	<i>f 1 v, v 1 g.</i>
	10	<i>f v, v 2 g, d 4 v.</i>
	17	<i>v 3 f, d 3 or 4 v.</i>
	30	<i>v 5 f, d 3 v.</i>
Dec.	3	<i>v 3 f, d 3 or 4 v.</i>

First we will form the light scale. The observations of May 11 furnish a value for the interval in steps between the stars *d* and *f*.

Since  $d$  is 2 steps brighter than  $v$  and  $v$  3 steps brighter than  $f$ , it follows that  $d$  is 5 steps brighter than  $f$ . By taking the mean of all the intervals from the observations in which  $v$  is between  $d$  and  $f$  in brightness, a good value may be obtained. Selecting similar combinations from the observations of each date, we can get values for the step intervals between all the comparison stars used. Intervals found by subtraction are not so reliable, and should only be used when better ones are wanting. The work will stand as in the following table, in which all the intervals between  $d$  and  $f$  are ranged under the heading  $df$ , and similarly for the intervals between the other stars.

		$d f$			$n o$
May	11	.....5	Aug.	2	.....4
	17	.....6		11	.....2
	27	.....5.5		16	.....2
Nov.	10	.....4	Sept.	2	.....2
	17	.....6.5			<u>4)10</u>
	30	.....8			Mean $n$ 2.5 $o$
Dec.	3	.....6.5			
		<u>7)41.5</u>			$n p$
		Mean $d$ 5.9 $f$	Sept.	2	.....3
					$o p$
		$f g$	Sept.	2	.....1
June	19	.....2			$l m$
Oct.	30	.....2			
Nov.	2	.....2	Oct.	9	.....3.5
	10	.....2			$g l$
		<u>4)8</u>	Oct.	22	.....5.5
		Mean $f$ 2.0 $g$		30	.....3
					<u>2)8.5</u>
		$g k$			Mean $g$ 4.3 $l$
Oct.	22	.....5			$k l$
	30	.....3	Oct.	30	.....0.0
		<u>2)8</u>			$f l$
		Mean $g$ 4.0 $k$	Oct.	30	.....5
					$f k$
		$h k$	Oct.	30	.....5
July	1	.....3			$d g$
	10	.....2.5	Nov.	10	.....6
		<u>2)5.5</u>			$m o$
		Mean $h$ 2.8 $k$			
					$m n$
		$m n$			
Oct.	7	.....1.5			
		$m o$			
Aug.	2	.....6			

It will be noticed that these intervals do not exactly agree among themselves. For instance, we have the intervals  $f\ 2\ g$  and  $g\ 4\ k$ , from which the interval  $f\ 6\ k$  would result. But that interval, observed directly, was  $f\ 5\ k$ . Since the value  $f\ 6\ k$  depends on six observations, while  $f\ 5\ k$  depends on only one, by giving weights according to the number of observations the mean value  $f\ 5.9\ k$  would result. The following method will be convenient to make use of all the above intervals, each with its proper weight, in forming the light scale. — Assign the arbitrary value  $o$  to the faintest star used; in this case  $p = o$ . For the next brighter star,  $o$ , we find from the observation of Sept. 2, the interval  $o\ 1\ p$ , hence  $o = p + 1.0 = 1.0$ . For the next brighter star,  $n$ , we have from the above table,

$$n = p + 3.0 = 0.0 + 3.0 = 3.0,$$

also  $n = o + 2.5 = 1.0 + 2.5 = 3.5.$

These two values for  $n$  can be combined by multiplying each by the number of observations on which it depends, and dividing the sum of the products by the sum of the number of observations. Thus

$$n = p + 3.0 = 0.0 + 3.0 = 3.0 \times 1 = 3.0$$

$$= o + 2.5 = 1.0 + 2.5 = 3.5 \times 4 = 14.0$$

$$\begin{array}{r} 5 \overline{)17.0} \end{array}$$

$$\text{Mean } n = 3.4$$

By proceeding in this manner with each brighter star successively the scale values for all will be obtained. The following table shows all the work —

$$\begin{aligned} p &= o \\ o &= p + 1.0 = 0.0 + 1.0 = 1.0 \\ n &= p + 3.0 = 0.0 + 3.0 = 3.0 \times 1 = 3.0 \\ &= o + 2.5 = 1.0 + 2.5 = 3.5 \times 4 = 14.0 \\ &\qquad\qquad\qquad 5 \overline{)17.0} \\ &\qquad\qquad\qquad \text{Mean } n = 3.4 \end{aligned}$$

$$\begin{aligned} m &= n + 1.5 = 3.4 + 1.5 = 4.9 \times 1 = 4.9 \\ &= o + 6.0 = 1.0 + 6.0 = 7.0 \times 1 = 7.0 \\ &\qquad\qquad\qquad 2 \overline{)11.9} \\ &\qquad\qquad\qquad \text{Mean } m = 6.0 \end{aligned}$$

$$\begin{aligned} l &= m + 3.5 = 6.0 + 3.5 = 9.5 \\ k &= l + 0.0 = 9.5 + 0.0 = 9.5 \\ h &= k + 2.8 = 9.5 + 2.8 = 12.3 \\ g &= k + 4.0 = 9.5 + 4.0 = 13.5 \times 2 = 27.0 \\ &= l + 4.3 = 9.5 + 4.3 = 13.8 \times 2 = 27.6 \\ &\qquad\qquad\qquad 4 \overline{)54.6} \\ &\qquad\qquad\qquad \text{Mean } g = 13.7 \end{aligned}$$

Light scale.

- $p = 0$
- $o = 1.0$
- $n = 3.4$
- $m = 6.0$
- $l = 9.5$
- $k = 9.5$
- $h = 12.3$
- $g = 13.7$
- $f = 15.3$
- $d = 21.0$

$$\begin{aligned}
 f &= g + 2.0 = 13.7 + 2.0 = 15.7 \times 4 = 62.8 \\
 &= l + 5.0 = 9.5 + 5.0 = 14.5 \times 1 = 14.5 \\
 &= k + 5.0 = 9.5 + 5.0 = 14.5 \times 1 = 14.5
 \end{aligned}$$

$$\underline{6)91.8}$$

$$\text{Mean } f = 15.3$$

$$\begin{aligned}
 d &= f + 5.9 = 15.3 + 5.9 = 21.2 \times 7 = 148.4 \\
 &= g + 6.0 = 13.7 + 6.0 = 19.7 \times 1 = 19.7
 \end{aligned}$$

$$\underline{8)168.1}$$

$$\text{Mean } d = 21.0$$

We are now prepared to assign numerical values to the brightness of the variable at the time of each observation. Here again we must take the mean of slightly different values, for instance for May 11 we have  $d \approx v$ , whence  $v = 19.0$ , also  $v \approx f$ , whence  $v = 18.3$ ; the most probable value will be the mean of the two, or  $v = 18.7$ . Proceeding in this way with the observation of each date we have —

	<i>Date</i>	<i>Observed</i>	<i>Mean</i>
1893	May 11	19.0, 18.3	18.7
	17	19.0, 19.3	19.2
	27	19.0, 18.8	18.9
	June 19	14.3, 14.7	14.5
	July 1	11.3, 11.5	11.4
	10	10.3, 10.0	10.2
	Aug. 2	3.5, 2.9, 4.5	3.6
	11	2.9, 2.5	2.7
	16	2.4, 2.0	2.2
	26		
	Sept. 2	1.4, 1.0, 1.0	1.1
	6		1
	26		6
	Oct. 7	6.0, 4.9	5.5
	9	8.0, 8.0	8.0
	22	11.7, 13.0, 12.5	12.4
	30	12.5, 13.7, 13.3, 12.5	13.0
	Nov. 2	14.3, 14.7	14.5
	10	15.3, 15.7, 17.0	16.0
	17	18.3, 17.5	17.9
	30	20.3, 18.0	19.2
	Dec. 3	18.3, 17.5	17.9

These results can be represented to the eye on squared paper by laying off the dates horizontally and the brightness vertically, and drawing a smooth curve passing as nearly as possible through the points thus located. This curve will show approximately the time of maximum or minimum, and the corresponding brightness expressed

in terms of the light curve. The time of maximum or minimum can be more accurately determined by bisecting the horizontal lines connecting corresponding points on the ascending and descending branches of the curve, drawing a line through the points thus located, and prolonging it till it intersects the light curve. This point of intersection will be the maximum or minimum as the case may be.

## CHAPTER X

### MEAN LIGHT CURVE

AFTER a long series of observations of a variable star has been made, and the single light curves drawn from which the maxima and minima have been determined, the next step in order is to combine them all so as to form the mean light curve. While there is no hard and fast rule according to which this is done, the general plan of procedure is the same, though each observer may introduce modifications depending upon the exigencies of his particular problem. The best way to make the matter clear is to give an extensive example. For this purpose a group of observations of  $\delta$  Cephei, made by Heis, have been selected from those edited and published by Hagen, and referred to in Chapter IX, which are given below in Table I. In copying them some slight alterations in the arrangement have been made for the sake of convenience. The columns in order give the calendar date, the Greenwich Mean Time, the Julian Day, with the hour expressed as a fraction of a day, and the light step.

The first step is to plot the observations and draw the single light curves. When this has been done, it will be seen that in some places the observations are too scattered to form a good curve, but from other sections where it is well defined, the shape can be perceived and made use of in the parts where observations are lacking. We may avail ourselves of the fact that the light curve of  $\delta$  Cephei is very well known, but this knowledge cannot ordinarily be expected, and in the case of a new short period variable the drawing of the single light curves may be attended with some difficulty, and several experimental curves may need to be drawn before a satisfactory one is obtained. Where the observations are incomplete, a dotted line is usually drawn. Since an illustration has already been given of the

MEAN LIGHT CURVE

187

TABLE I

<i>Date, 1848</i>	<i>Gr. M.T.</i>	<i>J.D.</i>	<i>L.S.</i>	<i>Date, 1848</i>	<i>Gr. M.T.</i>	<i>J.D.</i>	<i>L.S.</i>
d	h	239		d	h	239	
June 21	10.7	6200.4	8.3	Sept. 3	15.5	6274.6	6.8
22	10.7	6201.4	8.8	4	8.1	6275.3	7.2
24	11.5	6203.5	1.7	5	9.3	6276.4	8.4
26	13.3	6205.6	7.3	8	7.9	6279.3	2.0
27	10.2	6206.4	8.6	9	9.2	6280.4	8.3
July 1	9.9	6210.4	7.2	14	10.0	6285.4	5.9
2	13.4	6211.6	7.4	16	8.4	6287.4	7.9
3	10.6	6212.4	8.2	17	9.2	6288.4	7.2
5	13.2	6214.6	2.2	19	9.5	6290.4	3.3
6	10.5	6215.4	3.8	20	7.3	6291.3	7.3
8	11.8	6217.5	8.1	21	7.9	6292.3	6.9
12	9.8	6221.4	6.8	22	8.7	6293.4	7.9
13	9.7	6222.4	7.8	26	8.6	6297.4	7.7
16	9.7	6225.4	3.9	29	7.1	6300.3	1.2
18	9.3	6227.4	8.3	30	9.0	6301.4	4.2
22	10.1	6231.4	4.2	Oct. 2	7.6	6303.3	8.3
26	9.8	6235.4	2.0	3	9.1	6304.4	6.7
27	9.6	6236.4	4.7	5	9.6	6306.4	3.8
28	9.3	6237.4	6.5	6	7.5	6307.3	5.3
29	10.0	6238.4	7.7	7	6.7	6308.3	7.8
30	9.7	6239.4	8.6	8	8.8	6309.4	8.6
31	9.7	6240.4	4.7	15	6.6	6316.3	1.0
Aug. 1	10.6	6241.4	1.9	20	7.2	6321.3	1.5
4	10.3	6244.4	7.1	22	7.3	6323.3	5.3
5	13.8	6245.6	4.5	23	8.1	6324.3	8.3
10	14.3	6250.6	8.3	25	11.1	6326.5	3.6
19	9.1	6259.4	7.2	26	6.8	6327.3	2.0
21	9.0	6261.4	8.8	28	7.1	6329.3	7.7
22	9.2	6262.4	3.9	29	6.0	6330.2	8.3
27	12.5	6267.5	4.2	Nov. 1	7.5	6333.3	4.2
28	8.7	6268.4	2.8	2	10.2	6334.4	7.1
30	8.2	6270.3	7.7				

method of drawing a light curve, it is unnecessary to make the drawing for this star. However, the material for drawing the curve can be found in Table I, and the reader is advised to make it for himself and follow the problem with it before him.

The next step is to determine the approximate elements, *i.e.*, the epoch and period. The epoch can be selected by inspection, and is that maximum which has the most numerous and the best distributed observations. In order to find the period, select three or four of the best maxima, and by combining them in pairs obtain a fairly good approximate value. In the present case, the first maximum has observations both preceding and following; hence it may serve as the epoch. The same is true also of the eighth and twenty-fourth maxima, but since the first is equally good, and is much better situated for the rest of the work, it will be chosen as the approximate epoch  $T_0$ .

The approximate period may be found from the following combinations. The interval in time between the first and eighth maxima, 37.9 days, corresponds to seven periods, hence the value of one period will be 5.41 days. Combining the eighth and twenty-third maxima in the same manner, we find an interval of 79.9 days, which gives for the period 5.33 days. From the first and twenty-second maxima we derive a period of 5.37 days. The mean of these three separate determinations is 5.37, which will be accepted as the approximate period,  $P_0$ .

The next step is to improve these approximate determinations by employing all the other maxima, and there are six more which are satisfactory enough to be of use. While it will be found that the elements are not materially altered, the process will be carried out in full, since in the case of other stars this preliminary calculation may not give a sufficiently accurate result. Before introducing the numerical values, the equation will be developed according to which the corrections to the approximate elements may be determined.



Let  $T_0$  and  $P_0$  be the approximate elements,  
 $T$  and  $P$  be the improved elements,  
 $n$  stand for the number of a maximum in the entire  
series, counting from  $T_0$ , for which  $n = 1$ ,  
 $dT$  and  $dP$  stand for the differences  $T - T_0$  and  
 $P - P_0$ , *i.e.*, the differences between the approxi-  
mate elements and the improved elements.

Then the two equations may be formed

$$(1) \quad T_0 + nP_0 = \text{computed maximum,}$$

$$(2) \quad (T_0 + dT) + n(P_0 + dP) = \text{observed maximum.}$$

Representing the observed and computed maxima by the  
symbols  $O$  and  $C$ , and subtracting the first equation from the  
second, we have the resulting equation

$$(3) \quad dT + ndP = O - C.$$

Each observed maximum will give an equation of this kind,  
and the solution of all of them will give the desired corrections  
to the elements.

In the present case Table II shows the necessary data for  
forming the equations of type (3). The first column contains  
the number of the selected maximum, the second column the

TABLE II

No.	<i>O. Max.</i>	<i>C. Max</i>	$O - C$
1	6203.5	6203.5	0.0
3	6214.6	6214.2	+ 0.4
7	6235.4	6235.7	- 0.3
8	6241.4	6241.1	+ 0.3
15	6279.3	6278.7	+ 0.6
19	6300.3	6300.2	+ 0.1
22	6316.3	6316.3	0.0
23	6321.3	6321.6	- 0.3
24	6327.3	6327.0	+ 0.3

observed time of maximum, taken from the observations in Table I, column 3. The third column contains the predicted maximum, computed from the elements, using equation (1),

$$\text{Computed Maximum} = \text{J.D. } 239\ 6203.5 + n\ 5.37.$$

The last column contains the value " $O - C$ ," which is obtained by subtracting the numbers in the third column from the corresponding ones in the second column.

By substituting the numbers contained in the first and last columns of the above table in (3) the following equations are formed: —

$$\begin{array}{rcl}
 & + 1\ dT + 1\ dP & = 0.0 \\
 & + 1 & + 3 = + 0.4 \\
 & + 1 & + 7 = - 0.3 \\
 & + 1 & + 8 = + 0.3 \\
 (4) & + 1 & + 15 = + 0.6 \\
 & + 1 & + 19 = + 0.1 \\
 & + 1 & + 22 = 0.0 \\
 & + 1 & + 23 = - 0.3 \\
 & + 1 & + 24 = + 0.3
 \end{array}$$

An inspection of the above equations shows that they cannot be solved by the ordinary algebraic processes, since there are more equations than there are unknown quantities. Since this is a condition which usually occurs in astronomical problems, it is desirable to pause at this point and consider it somewhat in detail.

In any astronomical investigation the object is to make a series of observations from which certain desired quantities can be obtained. Since every observation involves some kind of error, it naturally follows that the greater the number of observations the more accurately the quantities sought can be determined. The errors of observation are of various sorts, and depend upon the subject under investigation. When their character is understood theoretically, their effects can be computed and applied to the observations, in which case we say that the observations have been corrected for all known errors. After this has been done, there are sometimes indicated syste-

matic variations, the sources of which may or may not be discovered, but which can usually be eliminated by some method of comparison. Over and above the theoretical and the systematic errors, there remain the accidental errors, which no kind of foresight or study can avoid, and it is with the object of eliminating these that observations are multiplied, the idea being that in the long run, small errors will occur more frequently than large ones, and that positive and negative errors will occur with equal frequency, and hence neutralize one another. The actual number of observations necessary to make a good determination will depend upon the problem.

Whenever there are more equations than unknown quantities, the solution will be indefinite, that is, there will be as many solutions as there are possible combinations of equations covering the number of the unknowns. It therefore becomes necessary to devise some way of getting around the difficulty. The one adopted is called the Method of Least Squares. While the present book is not the proper place in which to explain it, a brief statement may be made which will give the ordinary reader some idea of the principle on which it is based.

Suppose that a set of ten equations, each containing three unknown quantities, is given for solution, and suppose that a preliminary result has been obtained giving approximate values for the three unknowns. Suppose, further, that the values of the unknowns are substituted in the ten original equations. They will, in general, not be satisfied, that is to say, the second terms will not be zero, but a small remainder will result from each, which is called a residual. Another approximate solution will give another set of residuals, and a third one still another. The question then arises, whether there is any way of deciding which solution is the best. This may be answered by stating that the residuals themselves will furnish a test as to which solution is the best; for, in accordance with the Method of Least Squares, that solution is the most probable which makes the sum of the squares of the residuals a minimum, whence the name "Least Squares." There is a regular method of procedure

in the solution, which will not be described at this point, but whose development can be found in special treatises, or in the text-books of Chauvenet, Doolittle, etc. It is interesting to note that in the case of direct observations of a single quantity, the value which is ordinarily adopted, *viz.*, the arithmetical mean, is also the most probable value according to the Method of Least Squares.

Returning now to the set of equations (4), and considering their solution, it is doubtful whether it is worth while to carry out the Method of Least Squares rigorously, for two reasons: first, the number of equations is not large, and secondly, the numerical terms are already small. In such a case the simplest way would be to group the equations in two parts, four in one and five in the other. There is no rule according to which this should be done, but since the co-efficients of  $dP$  increase successively, it might be better to combine the alternate ones. By so doing we obtain the two following equations: —

$$5 dT + 69 dP = + 0.6,$$

$$4 dT + 53 dP = + 0.5.$$

The solution of these gives

$$dT = + 0.2454 \text{ days,}$$

$$dP = - 0.00909 \text{ days,}$$

and the corrected elements are then

$$\text{J.D. } 239\ 6203.7454 + 5.36091 E.$$

It is interesting to compare the period obtained in this simple manner from a few observations, with that given by Hartwig, which is 5.366386, being quite a close approximation. Excepting for the purpose of comparison it would be unnecessary to carry the values of the two unknown quantities to so many decimal places, and for use in the further computation it will be sufficient to adopt the values

$$\text{Comp. Max.} = \text{J.D. } 239\ 6203.745 + 5.361 E.$$

The next step toward the finding of the mean light curve is to compute an ephemeris, or a series of maxima covering the entire period of observation. In doing this it is advisable to use the elements as given above, even though in the ephemeris

only one decimal place is retained. The results obtained in this way are tabulated below in Table III.

TABLE III

<i>T</i>	<i>J.D. Max.</i>	<i>T</i>	<i>J.D. Max.</i>
1	6203.7	14	6273.4
2	6209.1	15	6278.8
3	6214.5	16	6284.2
4	6219.8	17	6289.5
5	6225.2	18	6294.9
6	6230.6	19	6300.2
7	6235.9	20	6305.6
8	6241.3	21	6311.0
9	6246.6	22	6316.3
10	6252.0	23	6321.7
11	6257.4	24	6327.0
12	6262.7	25	6332.4
13	6268.1	26	6337.8

The next step requires considerable care. Its purpose is to locate each individual observation in its light curve. A better understanding of this point may be obtained by examining the light curves which have been depicted in Chapter IX. A single light curve may be said to extend from one maximum to the next one or from one minimum to the next one. A point on the curve can be located in time by giving the interval from some selected point to the time of observation. This interval of time is called the phase. For example, assume that in the present problem we shall count the phase from the computed maximum. The first maximum occurs on J.D. 6203.7, the first observation after this is on J.D. 6205.6, therefore its phase is the difference in time between the two times of observations, or + 1.9 days.

The observation preceding the same maximum is on J.D. 6203.5, hence its phase, is  $-0.2$  days. It will be seen, then, that we must first find to which particular maximum an observation belongs. In order to decide this, we must choose arbitrary limits on either side of the maximum which will include an entire curve. In the case of  $\delta$  Cephei, the period is approximately 5.4 days, and the rise to maximum is more rapid than the descent to the minimum, therefore we shall choose the limits from two days before the maximum to three and four-tenths days afterward, or from  $-2.0$  to  $+3.4$  days. Keeping this in mind, and referring to the predicted maxima in Table III, it is possible to find the phase for each observation. The results thus obtained are arranged in Table IV, the first column of which gives the number of the maximum in the series, the second the J.D. of the observation, the third the phase, and the fourth the light step. It will be noticed that the first two observations occur more than two days before  $T_1$ , hence the maximum immediately preceding was computed from the elements and called  $T_0$ , having J.D. 6198.4, but this must not be confused with the approximate epoch which was also called  $T_0$ .

The next step is to rearrange the observations according to the order of the phase, selecting them for this purpose from the different light curves, wherever they happen to occur. They are contained thus in Table V, together with their accompanying light steps. The phases should begin with the one farthest preceding the maximum, or  $-2.0$ , but with this star it happens that there is no observation corresponding to this time, the earliest phase being  $-1.9$ . After they are all arranged in this final order, the next step is to divide them into groups for the purpose of taking the averages for the final mean light curve. At this point the observer must depend solely upon his judgment, and perhaps will have to experiment several times before obtaining a satisfactory result. The points obtained from the grouping must be close enough together to show the form of the curve, and yet not too close. Where the curve is known to change its curvature rapidly, the points should be closer

# MEAN LIGHT CURVE

195

TABLE IV

<i>T</i>	<i>J.D.</i>	<i>Phase</i>	<i>L.S.</i>	<i>T</i>	<i>J.D.</i>	<i>Phase</i>	<i>L.S.</i>
$T_0$	6200.4	+ 2.0	8.3	$T_{14}$	6274.6	+ 1.2	6.8
	6201.4	+ 3.0	8.8		6275.3	+ 1.9	7.2
$T_1$	6203.5	- 0.2	1.7		6276.4	+ 3.0	8.4
$T_1$	6205.6	+ 1.9	7.3	$T_{15}$	6279.3	+ 0.5	2.0
	6206.4	+ 2.7	8.6		6280.4	+ 1.6	8.3
	$T_2$	6210.4	+ 1.3	7.2	$T_{10}$	6285.4	+ 1.2
6211.4		+ 2.3	7.4	6287.4		+ 3.2	7.9
6212.4		+ 3.3	8.2	$T_{17}$	6288.4	- 1.1	7.2
$T_3$	6214.6	+ 0.1	2.2		6290.4	+ 0.9	3.3
	6215.4	+ 0.9	3.8		6291.3	+ 1.8	7.3
	6217.5	+ 3.0	8.1		6292.3	+ 2.8	6.9
$T_4$	6221.4	+ 1.6	6.8	$T_{18}$	6293.4	- 1.5	7.9
	6222.4	+ 2.6	7.8		6297.4	+ 2.5	7.7
$T_5$	6225.4	+ 0.2	3.9	$T_{19}$	6300.3	+ 0.1	1.2
	6227.4	+ 2.2	8.3		6301.4	+ 1.2	4.2
$T_6$	6231.4	+ 0.8	4.2		6303.3	+ 3.1	8.3
	$T_7$	6235.4	- 0.5	2.0	$T_{20}$	6304.4	- 1.2
6236.4		+ 0.5	4.7	6306.4		+ 0.8	3.8
6237.4		+ 1.5	6.5	6307.3		+ 1.7	5.3
6238.4		+ 2.5	7.7	6308.3		+ 2.7	7.8
$T_8$		6239.4	- 1.9	8.6	$T_{21}$	6309.4	- 1.6
	6240.4	- 0.9	4.7	$T_{22}$	6316.3	0.0	1.0
	6241.4	+ 0.1	1.9		$T_{23}$	6321.3	- 0.4
	6244.4	+ 3.1	7.1	6323.3		+ 1.6	5.3
$T_9$	6245.6	- 1.0	4.5	6324.3	+ 2.6	8.3	
	$T_{10}$	6250.6	- 1.4	8.3	$T_{24}$	6326.5	- 0.5
$T_{11}$		6259.4	+ 2.0	7.2		6327.3	+ 0.3
	$T_{12}$	6261.4	- 1.3	8.8		6329.3	+ 2.3
6262.4		- 0.3	3.9	6330.2		+ 3.2	8.3
$T_{13}$	6267.5	- 0.6	4.2	$T_{25}$	6333.3	+ 0.9	4.2
	6268.4	+ 0.3	2.8		6334.4	+ 2.0	7.1
	6270.3	+ 2.2	7.7				

together. Experience alone will indicate the best manner of proceeding.

TABLE V

<i>Phase</i>	<i>L.S.</i>	<i>Phase</i>	<i>L.S.</i>	<i>Phase</i>	<i>L.S.</i>
- 1.9	8.6	+ 0.8	4.2	+ 2.2	7.7
1.6	8.6	0.8	3.8	2.2	8.3
1.5	7.9	0.9	4.2	2.3	7.7
1.4	8.3	0.9	3.3	2.3	7.4
		0.9	3.8	2.5	7.7
- 1.3	8.8			2.5	7.7
1.2	6.7	+ 1.2	5.9	2.6	7.8
1.1	7.2	1.2	6.8	2.6	8.3
1.0	4.5	1.2	4.2		
0.9	4.7	1.3	7.2	+ 2.7	7.8
		1.5	6.5	2.7	8.6
- 0.6	4.2	1.6	8.3	2.8	6.9
0.5	3.6	1.6	5.3	3.0	8.8
0.5	2.0	1.6	6.8	3.0	8.4
0.4	1.5			3.0	8.1
0.3	3.9	+ 1.7	5.3		
		1.8	7.3	+ 3.1	8.3
- 0.2	1.7	1.9	7.3	3.1	7.1
0.0	1.0	1.9	7.2	3.2	7.9
+ 0.1	1.2	2.0	7.2	3.2	8.3
0.1	2.2	2.0	8.3	3.3	8.2
0.1	1.9	2.0	7.1		
+ 0.2	3.9				
0.3	2.8				
0.3	2.0				
0.5	4.7				
0.5	2.0				

The means of the values in the different groups should now be taken, the phase to hundredths of a day, and the light step to hundredths of grades. These means are contained in Table VI, page 198, which also includes other data to be described later. The first column gives the mean phase, the second the mean light step, and the third the number of observations included. The next step is to plot the observations and draw a curve through them, in doing which they may be given equal weight, or they may be weighted according to the number of observations in each group. If each group is of weight unity,



the process is very simple, and the curve is drawn as smoothly as possible. After this has been done, the co-ordinates of the mean light curve may be obtained by reading from the one just drawn, the light step corresponding to certain regular intervals, *e.g.*, in the case of  $\delta$  Cephei, every .3 or .5 of a day. These co-ordinates are contained in the second part of Table VI, and comprise what is technically known as the mean light curve of  $\delta$  Cephei. That is to say, when the mean light curve of a star is spoken of, we may refer to the co-ordinates of the curve, or to the curve itself. It is frequently not convenient to publish the curve, but if the co-ordinates are given they may at any time be represented to the eye by a drawing.

Returning to the second method of drawing the curve from the means in the first part of Table VI, we introduce weights which are equal to the number of observations in each group, and attach to each point plotted the number representing its weight. The points are then connected by straight lines, and each section is divided into two segments, which are inversely proportional to the weights of the points. For example, if the first point is the mean of four observations and the second the mean of five, then the line is divided by a point which is four ninths of the way from the second to the first, so that the two segments are in the ratio of 5:4, the larger segment being nearer the smaller weight. The points thus located are then connected by a smooth curve, which is the mean light curve of the star. In the present case the number of observations in each group is so small that it is hardly worth while to use weights, and, in fact, so far as the author is aware, they are generally dispensed with in treating of discussions based upon visual observations by the Argelander method, just as the strict Method of Least Squares is not generally introduced, because the observations are not exact enough to make it worth while to be so rigorous.

The present example may be criticized, and rightly so, because light steps are used throughout instead of magnitudes, and in any real investigation the magnitudes should be intro-

duced at a much earlier stage of the work, before the single light curves are plotted. However, the method of procedure is exactly the same, and since the light step is the value which was published, it was made use of in the example. Table VI and the light curve follow.

TABLE VI

<i>M.Ph.</i>	<i>M.L.S.</i>	<i>No. obs.</i>	<i>Ph.</i>	<i>L.S.</i>
da			da	
-1.60	8.35	4	-1.5	8.04
-1.10	6.38	5	1.2	6.82
-0.46	3.04	5	0.9	5.50
+0.02	1.60	5	0.6	3.95
+0.36	3.08	5	0.3	2.39
+0.86	3.86	5	0.0	1.61
+1.40	6.38	8	+0.3	2.81
+1.90	7.10	7	0.6	3.48
+2.40	7.82	8	0.9	4.00
+2.87	8.10	6	1.2	5.46
+3.18	7.96	5	1.5	6.63
			1.8	7.09
			2.1	7.43
			2.4	7.75
			2.7	8.02
			3.0	8.09
			3.3	7.82

In recapitulation the method described at such length may be summarized as follows, with the understanding that it may be modified at any point by the observer.

(1) Tabulate the observations in chronological order, giving the time in Julian Days.

(2) Plot the observations and draw the single light curves.

(3) Determine the times of the observed maxima so far as possible, and compute a set of approximate elements.

(4) Correct the approximate elements by using as many maxima as possible, deriving the adopted elements.

(5) Compute an ephemeris of maxima.

(6) Determine and tabulate the phase of each observation.

(7) Rearrange the observations in order of phase.

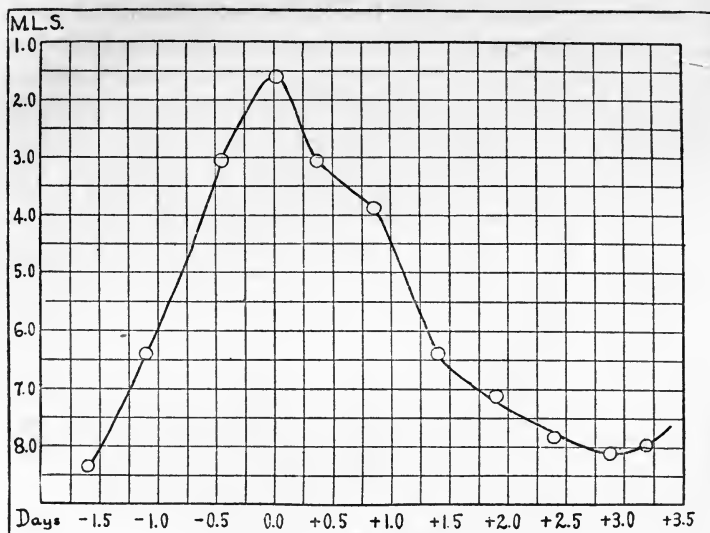

Figure 27

MEAN LIGHT CURVE OF  $\delta$  CEPHEI

- (8) Divide the observations into groups and take the means.
- (9) Plot the means and draw the mean light curve.
- (10) From the curve read off the co-ordinates of the mean light curve for regular intervals of time.

When once the mean light curve of a variable star has been determined it can be used for a number of different purposes. In fact, it is quite necessary when determining the minima of certain variables of the Algol type, as the following will show.

It will be remembered that this type is characterized by a rapid descent to minimum, followed by an equally rapid rise to maximum, while the duration of the minimum may be quite short, or it may last for an hour or more. Sometimes the two branches of the curve are not symmetrical, in which case it is not possible to use the ordinary method of bisecting the chord and prolonging the line passed through the points of bisection

until it cuts the curve. We may then make use of the mean light curve to correct for the asymmetry of its two branches. U Cephei affords the best example of this method. The data for illustration are taken from an article published by Yendell in *Popular Astronomy*, 14, 600 *et seq.*

TABLE VII

$T-t$	Before min.	After min.
h m	M	M
5 00	7.16	7.18
4 40	7.22	7.26
4 20	7.27	7.34
4 00	7.34	7.42
3 40	7.43	7.49
3 20	7.53	7.58
3 00	7.64	7.67
2 40	7.77	7.75
2 20	7.95	7.86
2 00	8.18	8.03
1 40	8.48	8.29
1 20	8.86	8.68
1 00	9.05	9.02
0 40	9.10	9.06
0 20	9.10	9.08
0 00	9.09	

The tabulated values give the magnitudes of the mean light curve for every twenty minutes before and after minimum. The lack of symmetry can readily be seen by inspecting the numbers in the table, or by examining the curve in Chapter I. Yendell gives four observations made on September 11, 1902, two as the star was diminishing in brightness, and two as it was increasing. The times of observation and the magnitudes are given below.

8 <sup>h</sup> 35 <sup>m</sup>	7.92 mg.	12 <sup>h</sup> 8 <sup>m</sup>	8.23 mg.
9 0	8.34	12 51	7.68

By making use of the above table we can find the time of minimum by a simple proportion. At the first observation the star had a magnitude of 7.92, and was growing fainter. Looking at the tabulated values, we see that this must have occurred

between 2h 40m and 2h 20m before the minimum, as the magnitudes for these two times are 7.77 and 7.95. In order to find the phase corresponding to 7.92, we must proportion between the two values as follows: the difference in magnitude between 7.77 and 7.95 is .18, and the difference in phase is 20m, the difference in magnitude between 7.77 and 7.92 is .15, while the interval in time,  $x$ , is to be determined. Hence we have

$$.18 : .15 :: 20 : x$$

$x = 16.7m$ , and this value must be subtracted from the phase of 7.77, which is - 2h 40m, giving for the phase of 7.92 mg. - 2h 23.3m. That is to say, the observation made at 8h 35m occurred 2h 23.3m before the minimum, hence the resulting time of minimum will be 10h 58.3m.

In the same manner we find the proportions for the other three observations to be

$$.30 \text{ mg.} : .16 \text{ mg.} :: 20 \text{ m} : xm$$

$$.26 : .06 :: 20 : x$$

$$.08 : .07 :: 20 : x$$

which give for the values of  $x$  respectively 10.7m, 4.6m, and 17.5m. The resulting times of minimum will be 10h 49.3m, 10h 23.4m, and 9h 53.5m. The mean of all four will be 10h 31.1m.

Chandler, in an article on this star in *Astronomical Journal*, 9, 53, expresses the same fact in a different way, giving a correction which is to be applied to the point of bisection of a chord made in the usual manner. For example, he finds that the star has a magnitude of 8.3, diminishing, at phase -1h 50m, and increasing, at phase +2h 05m, the mean of which is +7.5m. This would be applied as a correction as follows. If the times when U Cephei had the magnitude 8.3, both diminishing and increasing, were observed, and the mean were taken, then this mean would differ from the true time of minimum by +7.5m, and hence a correction of -7.5m would have to be applied to the mean in order to get the correct time. For other magnitudes he finds the following table of corrections.

mg.	min.
8.0	0.0
8.3	-7.5
8.6	-5.7
8.9	+0.3

A very interesting modification of the method of this chapter is used at Harvard in determining the mean light curves of a series of long period variables as published in *Annals*, H.C.O., 37. The observations which appear in these volumes were made by different observers at different places, hence the aggregate number is very large, and they are scattered quite thickly along most parts of the curve. Since it was difficult to handle so many observations, the proceeding was as follows. The observations were all plotted as in the case of  $\delta$  Cephei, and a smooth curve was drawn through them, making the successive branches as much alike as possible. This is not so simple as with short period variables, since the long period variables do not always reach the same magnitude at maximum or minimum, and the periods are not of uniform length. After the curves had been drawn satisfactorily, the magnitudes were read from them for every twenty days, counting the multiples of twenty, *e.g.*, J.D. 1600, 1620, 1640, etc., and tabulated. These magnitudes were used afterward in place of the original observations. The process of finding the time of maximum and minimum was also different, use being made of tabulated values instead of bisecting the chords, as is the usual custom. A second table was formed, containing the dates for every half magnitude on the ascending and descending branches of the curves, and the middle points taken. These dates were then plotted with the corresponding magnitudes as ordinates, and lines drawn through the points and extended until the maximum magnitude was obtained. As will be seen, this is practically the same method as bisecting the chords.

Other differences in method entered when the phase of an observation was found, the chief one being due to the fact that with these variables, the periods are not of uniform length, nor

is the time from maximum to minimum the same, so that the observations cannot be arranged in regular order, from the maximum throughout an entire period. Hence they were counted both ways from the maximum and both ways from the minimum, care being taken that the entire curve was covered. The two sections were then put together according to the mean value of  $M - m$ . As an illustration of this point the values for T Cassiopeiae may be cited. The mean period of this star is 445 days, and the interval  $M - m$  is 261 days, leaving 184 days for the other part of the period. The maximum part of the curve may be considered to extend from  $-130$  days to  $+92$  days, and the minimum from  $-92$  days to  $+130$  days. In order that the two branches shall overlap somewhat, and since the observations to be used are tabulated for every 20 days, the phases should extend from 140 to 100 days on either side of the initial point.

While it would be very interesting to carry through completely the investigation of one of these long period variables, space does not permit it; furthermore the problem is worked out in detail in the volume of the *Annals* just quoted, and any investigator who is engaged in such work can easily procure the volume and follow it for himself.

Many other modifications of the process are doubtless in use by different observers, which may be found and studied in various publications, but the steps to be followed are in general those indicated in this chapter.

## CHAPTER XI

### PREDICTION OF MAXIMA AND MINIMA FROM THE ELEMENTS

IN computing the maximum or minimum of a variable star from its elements the observer has two objects in view; the first is to compare the observed with the computed dates, in order to confirm the accuracy of the elements, and the second is to predict the dates in order to prepare lists for observation, such as have already been referred to in describing the ephemerides published yearly by Hartwig. Predictions are also published monthly in the *Popular Astronomy* and in other places, but the regular observer should be able to make these computations for himself; hence examples of the different methods will be given. However, before taking up a discussion of the different formulas employed to express the variation of a star, it is desirable to consider at some length the subject of Julian Day, already mentioned more than once, and to give rules for its use.

We are accustomed to associate the term Julian Calendar with the reform introduced by Julius Cæsar, according to which the year is made to consist of 365.25 days, and in the course of four years the fractional part amounts to one whole day. Hence one day is added to every fourth year, making it the leap year. Unfortunately for our convenience, the number just given is not exact, for the tropical year contains 365.2422 days. Consequently if a day is added every four years, in the course of time the error will reach several days, and the return of the seasonal festivals, which have been considered very important dates, will come out of time. The divergence from the truth can readily be perceived by a simple calculation.

A quadrennium is the name given to a period of four years consisting of three common years and one leap year, or 1461 days. Four years of the correct length will consist of



$4 \times 365.2422$  days, or 1460.9688 days, which differs from 1461 by .0312. Hence adding a day every four years makes the quadrennium too long by this amount, or each year is .0078 day too great. To find out how soon this will amount to an extra day, divide 1 by .0078 and the result is 128, therefore the 128th year, instead of being a leap year, should be a common year, and so on. This, however, would be a rather inconvenient and irregular way of making the correction, and a simpler one has been adopted. The extra time amounts to .0312 day every four years, or to 3.12 days in 400 years, hence if three leap years are omitted every 400 years, the agreement will be very nearly exact. When the calendar was reformed, under Pope Gregory, in the sixteenth century, it was decided that this could be accomplished by calling the centuries leap years only when they were divisible by 400 and not otherwise. Therefore 1700, 1800, and 1900 were not leap years, but 2000 will be one. The agreement is not even thus perfect, for .12 day will have been added every 400 years, which will amount to a day in 3333 years, but this is such a negligible quantity that for present purposes the Gregorian Calendar may be considered exact. It was introduced into the Catholic countries in 1582, at which time the difference amounted to ten days, and October 4 was followed by October 15. It was not adopted in England and her colonies until the eighteenth century, and September 2, 1752, was followed by September 14, as the difference had increased by one day more. Hence in reality George Washington was born on February 11, 1732. The Julian Calendar is still in use in Russia, and letters are frequently headed with both dates, as "January 15/28, 1914." Often a date given according to the Julian Calendar is designated as O.S., or Old Style.

The Julian Period is a certain length of time arbitrarily adopted to cover the duration of historical records, and counted according to the Julian system. It includes a cycle of 7980 Julian years, and began on the noon of January 1, B.C. 4713. This number is based upon three subordinate cycles, which are

the Solar Cycle, the Lunar Cycle, and the Cycle of Indictions. The first one consisted of twenty-eight Julian years, the second of nineteen, and the third of fifteen, and the entire cycle, which must include all three, will be the least common multiple of them, which is 7980. The year B.C. 4713 was selected as the origin of the period, since it is the year which was number one in each of the subordinate cycles. Starting from this date the days which have elapsed can be computed simply and regularly according to the Julian Calendar. Tables have been constructed for converting a calendar date into Julian Days and *vice versa*. The extreme convenience of this way of reckoning can readily be understood when we attempt to combine observations of variable stars made over a long interval of time, where the awkwardness of using calendar dates becomes quite obvious. It was first introduced into variable star work by Pickering<sup>1</sup> in 1890. Nearly all series of observations are published with the calendar date and the Julian Day, which is designated by the familiar abbreviation of "J.D." The three subordinate cycles are still used in determining the dates of festivals, such as Easter, and the *American Ephemeris* gives for every year its cyclical numbers, *e.g.*, 1916, Lunar Cycle or Golden Number, 17; Solar Cycle, 21; Roman Indiction, 14; Julian Period, 6629. Table I at the end of this volume furnishes the material for converting a calendar date into Julian Days, the use of which is explained in the introduction to the tables.

We shall now proceed to give illustrations of computing the maximum or minimum of a variable star from its elements, taking the data from Hartwig's *Ephemeriden*. On looking over the column in Table I, which gives the elements, it will be noted that in general only two terms are given, the epoch, from which the number of periods is counted, and the length of the period given in days. For example, in the volume for 1914, from which all of the examples will be taken, No. 1, SS Cass., has for its elements

$$2417504 - 139.6 E,$$

<sup>1</sup> *Annals*, H.C.O., 18, 305.

which means that J.D. 2417504 is the Julian Day of some well-observed maximum, 139.6 days is the length of the period, and  $E$  is the number of periods which has elapsed since the epoch. Star 13, T Cass., has, in addition to the ordinary elements, a sine term which indicates a periodic variation in the period itself. The same sort of additional term appears in several places. R Virginis, No. 418, has two sine terms. Some stars like No. 151, S Tauri, have a term in  $E^2$ , which signifies that the variation in the length of the period is secular and not periodic, that is, it goes on in the same direction without change. One star, R Hydrae, No. 437, has both periodic and secular terms, as does also S Serpentis, No. 484. Such a combination is by no means simple to work out, but the method should be understood.

Suppose it is desired to compute the maximum of a variable star for 1914, the first step will be to find the value of  $E$ . If the observer has made a similar prediction for preceding years, it will only be necessary to add 1 to the number used for 1913, but if the work is to be done *de novo* the value for  $E$  must be determined by a method which is more or less approximate, because of the presence of the additional terms and their numerical values. That is to say, a preliminary value of  $E$  must be found, substituted in the formula, and the Julian Day for the result determined from the table; if the date thus found does not fall in the year 1914 the value for  $E$  must be changed and the computation repeated. As a rule not more than one such additional computation is required, especially when the elements consist of but one term. Several examples will now be given to illustrate the different cases.

#### METHOD OF FINDING $E$

$E$  will always be a whole number, since it represents the recurrence of successive maxima, each of which is an integral number of periods from the epoch. The maximum which occurs during 1914 will be the last one preceding the beginning of 1915. Therefore if we find the interval of time between

the epoch and January 0, 1915, and divide by the length of the period, we shall find the number of maxima which have occurred during that time. If the period is much less than a year, and two maxima take place during 1914, the one thus found will be the last one for the year, but the preceding one may be found by subtracting 1 from  $E$ . For convenience in carrying out these computations, the two Julian Days most necessary, those for January 0, 1914, and January 0, 1915, will be given here. They are respectively,  $2420133 = T_0$ , and  $2420498$ . (H) stands for the predicted value taken from Hartwig's *Ephemeriden* for 1914.

(1) Maximum of No. 1, SS Cass.  $2417504 + 139.6 E$ .

Jan. 0, 1915	2420498	Epoch	2417504
Epoch	<u>2417504</u>	$P \times E$	<u>2931.6</u>
Diff.	2994)139.6		2420435.6
$E$	21	$T_0$	<u>2420133</u>
		Oct. 29.6	302.6
$P$	139.6	Oct. 30 (H)	
$E$	<u>21</u>		
	2931.6		

Since the period is short, two other maxima will also occur during the year, one at 139.6 days earlier than October 30, or 163 from the beginning of the year, *i.e.*, June 12, and another one 139.6 days still earlier, *i.e.*, January 23.

(2) Maximum of No. 2, TT Cass.  $2418588 + 398 E$ .

Jan. 0, 1915	2420498	Epoch	2418588
Epoch	<u>2418588</u>	$P \times E$	<u>1592</u>
Diff.	1910)398		2420180
$E$	4	$T_0$	<u>2420133</u>
		Feb. 16	47
		Feb. 16 (H)	
$P$	398		
$E$	<u>4</u>		
	1592		

PREDICTION OF MAXIMA AND MINIMA 209

(3) Maximum of No. 976, SS Pegasi.  $2418865 + 412 E$ .

Since the period is greater than 365 days it may happen that no maximum occurs during the year 1914. If this is true, the formula will give as a result a number less than the J.D. for January 0, 1914.

Jan. 0, 1915	2420498	Epoch	2418865
Epoch	<u>2418865</u>	$P \times E$	<u>1236</u>
Diff.	1633)412		2420101
$E$		3 1913, Jan. 0,	<u>2419768</u>
			333
		1913, Nov. 29	
$P$	412	Nov. 29 (H)	
$E$	<u>3</u>		
	1236		

The next maximum will occur 412 days later, which will not be until 1915.

(4) Maximum of No. 17, R Androm.  $2402596 + 410.64 + 30 \sin (12 E + 168)$ .

To obtain the preliminary value for  $E$  we can use only the first term (1) for the period. If the addition of the second term (2) throws the maximum into the adjacent year, the value for  $E$  must be changed.

Jan. 0, 1915	2420498		12°
Epoch	<u>2402596</u>		<u>43</u>
Diff.	17902)410.64		516°
$E$	43		<u>168</u>
			684
$P$	410.64		<u>360</u>
$E$	<u>43</u>		324°
(1)	17657.52		
		$\sin 324^\circ$	-.59
Epoch	2422596		<u>30</u>
(1)	+ 17657.5	(2)	-17.70 da.
(2)	<u>- 17.7</u>		
	2420235.8		
$T_0$	<u>2420133</u>		
Apr. 12.8	102.8		
Apr. 13 (H)			

210 THE STUDY OF VARIABLE STARS

(5) Maximum of No. 151, S Tauri. 2400455 + 380.0  $E$   
 - 0.15  $E^2$ .

Jan. 0, 1915	2420498	Epoch	2400455
Epoch	2400455	(1)	+ 19760
Diff.	<u>20043</u> 380.0	(2)	- 405.6
$E$	52	$T_0$	<u>2419809.4</u>
			2420133
$P$	380.0		
$E$	<u>52</u>		
(1)	19760		
$E^2$	2704		
	- .15		
(2)	<u>- 405.60</u>		

The result indicates that the value of  $E$  is too small, since it places the maximum before January 0, 1914. Accordingly the computation must be repeated, using  $E = 53$ .

$P$	380.0	Epoch	2400455
$E$	<u>53</u>	(1)	+ 20140.0
(1)	20140.0	(2)	- 421.35
			<u>2420173.65</u>
		$T_0$	<u>2420133</u>
$E^2$	2809	Feb. 9.65	40.65
	- .15		
(2)	<u>- 421.35</u>	Feb. 10 (H)	

PREDICTION OF MAXIMA AND MINIMA 211

(6) Maximum of No. 418, R Virginis.  $2381934.8 + 145.47 E + 20 \sin(1^\circ.8 E + 216^\circ) + 4.8 \sin(5^\circ.625 E + 343^\circ)$ .

Jan. 0, 1915	2420498		5°.625
Epoch	<u>2381935</u>	E	<u>265</u>
Diff.	38563)		1490.625
E	145.47		<u>343</u>

			1833.625
P	145.47	$4 \times 360^\circ$	<u>1800</u>
E	<u>265</u>		33°.625

(1) 38549.55

sin 33°.625 +.55  
4.8

E 1°.8 265 (3) + 2.640

477.0

216

693.0

360

333°.0

Epoch 2381935

(1) + 38549.55

(2) - 9.00

(3) + 2.64

2420478.19

2420133

sin 333° - .45

20

T<sub>0</sub> Dec. 11 345.19

(2) - 9.00

Dec. 11 (H)

(7) Maximum of No. 437, R Hydrae.  $2411931 + 425.15 E - 0.36 E^2 + 15 \sin(7^\circ.5 E - 202^\circ)$ .

Jan. 0, 1915	2420498		7°.5
Epoch	<u>2411931</u>		<u>20</u>
Diff.	8567)		150.0
E	425.15		<u>202</u>
	<u>20</u>		352°.0

P 425.15 sin 352° - .14

E 20

(1) 8503.00

(3) - 2.10

E<sup>2</sup> 400

- .36

(2) - 144.00

Epoch 2411931

(1) + 8503.0

(2) - 144.0

(3) - 2.1

2420288.9

2420133

T<sub>0</sub> June 3.9 154.9

June 4 (H)

The preceding examples include nearly all the varieties of method required for computing the maximum of a long period variable. In order to obtain the time of minimum which is predicted for many of the stars in Hartwig's *Ephemeriden* it is necessary to know the interval of time between the minimum and the following maximum, or  $M - m$ . This is not given by Hartwig, but may be found in Chandler's catalogues for some of the stars. It is also found in *Annals*, H.C.O., vol. 55, not as a part of the catalogue, but in Table VII, together with other material. The predicted time of minimum can be found from the time of maximum by subtracting the interval  $M - m$  from it and finding the J.D. of the result. It will be noted that this value is lacking for a great many long period variables, and the necessity of supplying this lack points to a very useful kind of observation for those who can work with a telescope large enough to show stars of the thirteenth magnitude, and can follow these variables through their minima.

The process of finding the maximum or minimum of a short period variable is similar to that in use for the long period variables. To illustrate this a minimum of Algol will be computed. The elements which are found in Hartwig are taken from Chandler's catalogue, and are given in two forms; the first gives the calendar date for the initial epoch and expresses the period in hours, minutes, and seconds, while in the second these quantities are given in fractions of a day. The second form is the one most convenient to use in predicting: —

$$m = \text{J.D. } 2410640.34111 + 2^{\text{d}}.8673102 E \\ + 0^{\text{d}}.1021 \sin (0^{\circ}.024 E + 226^{\circ}) + 0^{\text{d}}.0153 \sin \left( \frac{E^{\circ}}{13} + 216^{\circ} \right).$$

In finding the value for  $E$  the last two decimal places in the period may be omitted, but after that the complete number must be used, and the multiplication done in full, and not by logarithms, to avoid the possible inaccuracy in the last figures.



Jan. 0, 1915	2420498	<i>E</i> /13	264
Epoch	2410640		216
Diff.	9858)2.86731		480
<i>E</i>	3438		360
			120
<i>P</i>	2.8673102		
<i>E</i>	3438	sin 120°	+ .87
(1)	9857.8124678		.0153
		(3)	+ .013311 d
<i>E</i>	3438	Epoch	2410640.34111
	.024	(1)	+ 9857.8124678
	82.512	(2)	- 0.079638
	226	(3)	+ 0.013311
	308°.5		2420498.08725
sin 308°.5 - .78		Jan.	0.08725=
	.1021		
(2)	- .079638 d	Dec. 31, 2 <sup>h</sup> 5 <sup>m</sup> 38 <sup>s</sup> .4	
		Dec. 31, 2 <sup>h</sup> .1 (H)	

In changing the fraction of a day to hours, minutes, and seconds, use is made of Table II.

It will be noticed that the predicted times are called "Heliocentric minima for Greenwich Mean Time." The observed times, however, are geocentric, and must be corrected for the difference between the two before being compared with the computed times. Hartwig, in the explanation of his tables, page 293, supplies a formula for this purpose the derivation of which will be given here.

In the accompanying figure, on page 214, let *XEY* be the plane of the ecliptic, the axis of *X* pointing to the vernal equinox, *S*, is the position of the sun in this plane, *Eσ* the line of sight to the star, and *Sσ*, which is parallel to *Eσ*, the line from the sun to the star. Project *ES* on *Eσ*, forming *EH*. Then the instant of time when the light from the star reaches *H* will be the same as when it reaches *S* and will be earlier than the instant it reaches *E*, by the length of time required to pass over the distance *EH*. The problem then is to find the time required by light to pass from *H* to *E*.

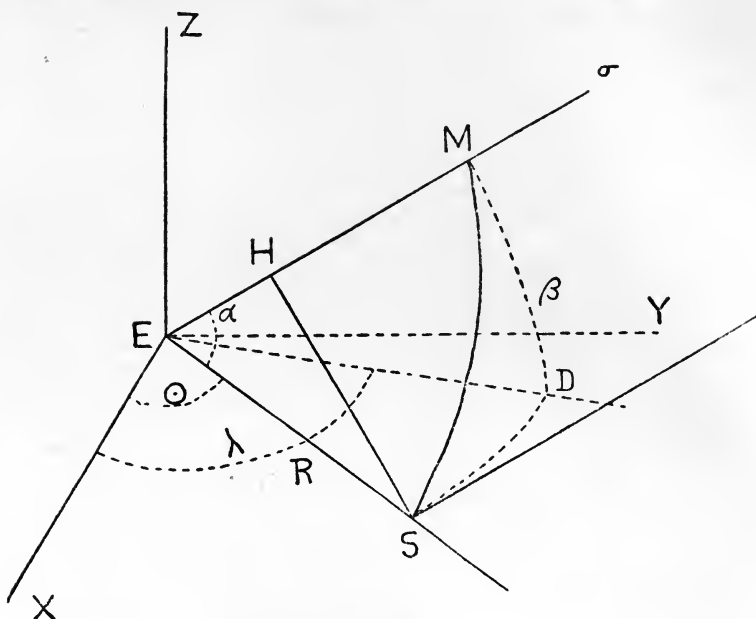

Figure 28

## DIAGRAM FOR OBTAINING THE REDUCTION TO THE SUN

Pass a plane through  $E\sigma$  perpendicular to the plane of the ecliptic, cutting it in the line  $ED$ . Let  $E$  be the center of a sphere passing through  $S$ . Then in the figure we have the following relations:—

$XES = \odot =$  the longitude of the sun,

$XED = \lambda =$  the longitude of the star,

$SED = \lambda - \odot$ ,

$SEH = a = MS$ ,

$ES = R$ , the radius vector of the earth,

$EHS = 90^\circ$ ,

$MED = \beta =$  the latitude of the star,

$MDS = 90^\circ$ .

In the plane triangle  $EHS$

$$EH = R \cos a.$$

In the spherical triangle *MDS*

$$\cos a = \cos \beta \cos(\lambda - \odot).$$

Hence

$$EH = R \cos \beta \cos(\lambda - \odot).$$

In this equation *EH* is expressed in the same unit as *R*. If we wish to find the time required by light to travel over this distance, we must divide both members of the equation by the velocity of light, or 186,300 miles per second. The same result will be accomplished if in the second member *R* is expressed in units of the earth's mean distance from the sun, and we introduce the time required by light to cross it. This is called the equation of light, and has for its value 498.5 sec. or 8.308 min. The second value is the one used in this particular case, since the predictions are not carried beyond the fraction of an hour.

In the figure, the heliocentric minimum occurs before the geocentric, hence the correction must be subtracted from the latter in order to obtain the former, which is the one sought. The formula thus becomes that given by Hartwig, —

$$\begin{aligned} \text{the Heliocentric time} &= \text{the Geocentric time} \\ &- 8^{\text{m}}.308 R \cos \beta \cos (\lambda - \odot). \end{aligned}$$

The quantities which are constant for each star are  $\beta$  and  $\lambda$ , while *R* and  $\odot$ , the co-ordinates of the sun, vary with the time of year. Since the correction is only necessary for stars which change very rapidly, and the maxima or minima of which can be determined with great accuracy, it applies chiefly to variables of the Algol type, to those of the  $\delta$  Cephei type, which have very short periods, and to the  $\beta$  Lyrae type. For the convenience of the observer, Hartwig has included in the *Ephemeriden* for 1914 for these stars, the value of  $\lambda$  for 1900, and also  $\log 8^{\text{m}}.308 \cos \beta$ , so that the necessary correction can be computed with readiness.

## CHAPTER XII

### ECLIPSING BINARIES

SINCE several types of variable stars are spectroscopic binaries, it seems desirable to the writer to discuss at considerable length the principles underlying the determination of motion in the line of sight, for it is this motion which demonstrates the binary character of the stars and furnishes important material regarding their orbits.

Wave-length and vibration frequency have been defined in the first chapter, but in order to bring them again to mind the definitions will be repeated here.

The wave-length is the distance the disturbance in the ether has traveled while the original particle is executing one vibration, =  $\lambda$ ,

The vibration frequency is the number of vibrations performed by a particle in one second, =  $n$ ,

The velocity of light is the distance traveled by light during one second, =  $V$ ;

Hence the following relation exists between  $n$ ,  $V$ , and  $\lambda$ ,

$$n = \frac{V}{\lambda}.$$

$n$  is thus the number of vibrations which fall upon the eye during one second. The numerical value of  $n$  depends upon the wave-length of the vibration emitted by the source of light. If anything were to happen to change the number of vibrations falling upon the eye during a second, the result would be to change the effective wave-length without in reality altering it at the source. Such a result could easily be produced if the source of light were to move toward or away from the observer at an extremely rapid rate, say several kilometers per second, and similarly if the observer were to move rapidly to and fro. What actually happens is that more or fewer vibrations fall

upon the eye per second, and consequently the apparent wavelength of the light emitted is changed.

This phenomenon may be further described as follows: The line connecting the observer with the source of light is called the line of sight. If the source is moving rapidly toward the observer, many more vibrations than usual will fall upon the eye per second and the effect will be to shorten all of the wavelengths. If the spectrum is continuous, no change in it will be perceived, because if a wave-length in the red is shortened and its position shifted, the one adjacent to it is also shortened and moves up, as it were, to take the vacant place. On the other hand, if there is an absorption spectrum which consists of the continuous background crossed by dark lines, then a change is perceptible, for while the continuous spectrum remains unchanged, the dark lines are all shifted toward the violet and as they are isolated from one another, there is no adjacent line moving up to take the vacant place. *Vice versa*, if the source of light is moving rapidly away from the observer, the lines will all be shifted toward the red end of the spectrum. Motion toward the observer is usually called approach, and motion away recession, and the rate at which the body is moving is called its radial velocity, or velocity in the line of sight. The statement is also often made in this form: approach shortens the wave-lengths and causes the lines to shift toward the violet end of the spectrum, while recession increases the wave-lengths and shifts the lines toward the red end of the spectrum.

The first knowledge of these very interesting and important facts resulted from the investigations of two physicists, Doppler and Fizeau. The former, in 1842, announced that rapid approach or recession would cause a change in the wave-length, but he thought erroneously that the color of the star would be changed, ignoring the fact just mentioned that all the wave-lengths were shifted at the same time, and hence there would be no change in the color. Fizeau, in 1848, was the first to announce the facts correctly, *viz.*, that the background of the continuous spectrum remains unchanged, while the dark lines

shift back and forth upon it. He outlined the method of measuring the motion of a heavenly body in the line of sight by means of the displacement of the lines in its spectrum, but not in such a way as to be of practical use to astronomers. His results were not even published until 1870. The principle is now known as the Doppler-Fizeau principle.

In order to discover whether the lines in the spectrum of a star are displaced, it is necessary to compare them with lines coming from a source of light that is stationary with reference to the observer. Such a source can be found in some terrestrial substance, which is called a comparison spectrum when it is used for this purpose, or is sometimes known as a normal spectrum. The history of the application of spectroscopic measurements to celestial bodies is full of interest. The first astronomer actually to attempt it was Sir William Huggins, in 1862 and 1863. Since the name of this brilliant and original investigator is linked with so many of the discoveries in astronomical spectroscopy it will be of interest to the reader to hear his own account of the beginning of his work in this branch of astronomy.

In 1858, having equipped an observatory with very excellent apparatus, including an eight-inch refractor by Alvan Clark, of Cambridgeport, Massachusetts, he paused to consider what problems he should plan to investigate. Many years later he recalled his ideals at that time in the following words:<sup>1</sup>

I soon became a little dissatisfied with the routine character of ordinary astronomical work, and in a vague way sought about in my mind for the possibility of research upon the heavens in a new direction or by new methods. It was just at this time . . . that the news reached me of Kirchoff's great discovery of the true nature and the chemical constitution of the sun from his interpretation of the Fraunhofer lines. . . . Here at last presented itself the very order of work for which in an indefinite way I was looking — namely, to extend his novel methods of research upon the sun to the other heavenly bodies. A feeling as of inspiration seized me. I felt as if I had it now in my power to lift a veil which had never before been lifted; as if a key had been put into my hands which would unlock a door which had been

---

<sup>1</sup> *Nineteenth Century Review*, June, 1897.



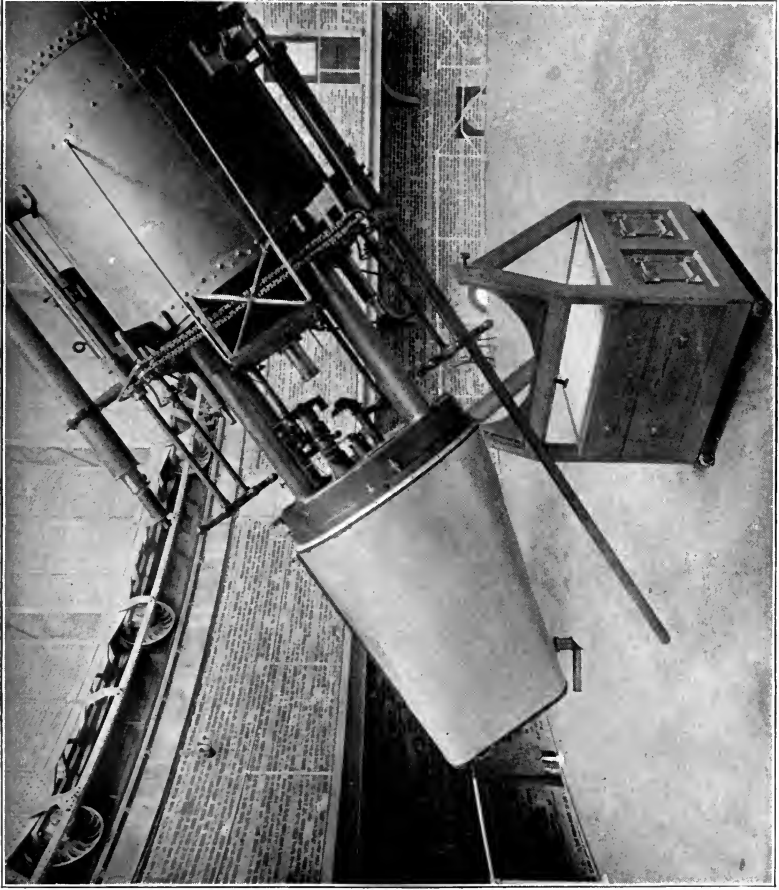

Plate VIII

THE BRUCE SPECTROGRAPH OF THE YERKES OBSERVATORY



regarded as forever closed to man — the veil and door behind which lay the unknown mystery of the true nature of the heavenly bodies.

His initial enthusiasm never deserted him. He was always entering upon new experiments in connection with stellar spectroscopy, and his name, like that of Herschel, is connected with many an original method of attack.

Astronomers in other countries were also fascinated by the new methods, and almost simultaneously investigations were carried on by Vogel in Germany, Rutherford in New York, and Secchi in Rome. However, it is not possible to give the historical details in the development of the method of determining the radial velocity of a star. Many mechanical obstacles had to be surmounted and the observations were of extreme difficulty and fatiguing to the eye. It was not until the perfection of the photographic dry plate that it was possible to obtain the sort of results which now afford such unlimited opportunity for investigation. It is true that with a large telescope like that of the Lick Observatory accurate measurements of the displacements of stellar lines could be made, but for the ordinary observer, such an instrument was out of the question. Hence when Vogel and Scheiner showed that with the aid of the photographic plate, the displacement of lines in a star of the second or third magnitude could be determined with a twelve-inch telescope with as much accuracy as that of a first-magnitude star with the thirty-six-inch telescope, a great field of research was opened to the worker with an average instrument.

In order to understand more fully the method of measuring radial velocity at the present time, a detailed description of the Bruce spectrograph<sup>1</sup> of the Yerkes Observatory will be given. It may be stated in passing that an instrument for making visual observations of the spectrum of a star is generally called a spectrocope, while one which photographs it exclusively is called a spectrograph. The photograph of the spectrum is known as a spectrogram.

Two views of the Bruce spectrograph will be presented, one

<sup>1</sup> E. B. Frost, *Ap. J.*, 15, 1.

in which it is attached to the telescope, and the other showing the interior construction, the outer covering having been removed. At the ocular end of the great telescope is a large iron ring which is racked in or out according to the kind of apparatus that is attached to the instrument. When the ordinary micrometer is in use, it is run in close to the end of the tube, but when the spectrograph is wanted, it is run out and to it is attached directly the ring which is the foundation of the mounting of the spectrograph. This latter is completely covered with a large aluminium case which serves as a protection against variation in temperature. Its walls are double and the intervening air space is filled with felt. Inside of it is a coil of wire which becomes heated when a current of electricity is passed through it, thus raising the temperature of the spectrograph. A thermometer is inserted so that its bulb is within the inner case, and any change in temperature indicated can be corrected by turning on the electric current, the purpose being to keep the temperature as constant as possible, in order to avoid errors which might arise from unequal expansion of the different parts of the instrument, causing a displacement of the prisms.

From the large ring are seen projecting three tubes, of which the shortest one is centrally placed in the ring, and hence in the optical axis of the great telescope. It carries the slit, and is the outer part of the collimating telescope of the spectrograph. To the right of it is a tube of the shape called "gooseneck," which is part of the special apparatus for guiding the instrument. This guiding must be done with great accuracy because the slit of the collimator is extremely narrow, and the star image formed at the focus of the objective very small, hence there will be considerable difficulty in keeping the image on the slit. The ordinary clockwork is not sufficient for this purpose, and some method must be devised by which the image on the slit can be seen and watched by the observer. The jaws of the slit are of speculum metal which is susceptible of a very high polish, and they are inclined at a very slight angle, so that the extra light from the star image which does not enter the slit is reflected

back onto a pair of diagonal prisms in the gooseneck; from here by other reflections they are passed down through a small telescope enclosed in the jacket of the spectrograph, and are viewed by the observer through the eyepiece which projects from its lower end. He is able by electric motors to control the motion of the clock, and thus keep the image on the slit. The reader will understand that this work may become very arduous when a faint star or a nebula is under observation and a long exposure of seven or ten hours must be made. It would appear from the photograph that the gooseneck obstructs the path of the ray of light, but there is an aperture through which a free passage is allowed.

The tube to the left holds the apparatus for providing the comparison spectrum, which is arranged so that four different substances can be utilized. Metallic electrodes are employed and the spark discharge is passed between them. At the Yerkes Observatory iron and titanium are chiefly used, and helium in a vacuum tube can take the place of one of the pairs of electrodes. When the comparison spectrum is being formed, a diaphragm covers the central portion of the slit where the star image falls.

The plate shows also a small tube projecting centrally from the main tube of the telescope. This contains a correcting lens which is situated about twenty-one inches inside of the tube. Such a lens is always necessary when a telescope which is intended for visual work is used for photographic purposes. Its object is to correct for the chromatic aberration of the objective, in the following manner. The objective cannot bring all of the different wave-lengths to a focus at the same distance behind it. When it is to be used for visual work it is ground to a curvature which will bring together the wave-lengths to which the eye is most sensitive, which are in the orange, yellow, and green. The focal point for the blue and violet rays is some distance inside this point. But these rays are the very ones that are most active photographically, hence they must in some way be brought to a focus together. A lens which is used exclu-

sively for photography is ground for it in the first place, but a visual lens may be changed into a photographic one by the addition of a small correcting lens placed within the focal point, which can be made so as to correct for any desired wave-length. (See Fig. 21.)

The second plate shows the essential parts of the spectrograph itself, and it is to be noted that, with a few differences, they are the same as those mentioned in describing the simple laboratory spectroscope in Chapter I, *viz.*, the slit, collimating telescope, prism, and view telescope. It has three prisms instead of one, a photographic plate holder is attached to the end of the view telescope instead of an eyepiece, thereby turning it into a camera, and there are two additional parts, one of which is the apparatus for producing the comparison spectrum, and the other for guiding the telescope. Both of them have been referred to in the preceding paragraphs.

We can also examine on this plate the interior of the spectrograph. Projecting outside of the heavy ring, which is its main support, can be seen the slit tube, the gooseneck, and the comparison apparatus. The gooseneck, with its tube, can be followed until the end is reached, where the eye of the observer is placed. The slit is in the outer end of the collimating telescope, the object end of which faces inward toward the first prism. Over the third prism is placed the view telescope, which is converted into a camera, having a plate holder at the other end. The prisms are adjusted so that they are effective for the wave-length 4500 A.U.

The other tubes and rods which are represented in the plate are for the purpose of making the entire instrument as rigid as possible. It rests upon a carriage, at an angle which makes it most convenient for attachment to the telescope. On the table under it is a second camera which may be interchanged with the one already in use. The three essentials for a good spectrograph are thus obtained; *i.e.*, the parts are rigidly connected so that there is no flexure in the instrument, the temperature can be kept constant, and the optical parts have been carefully



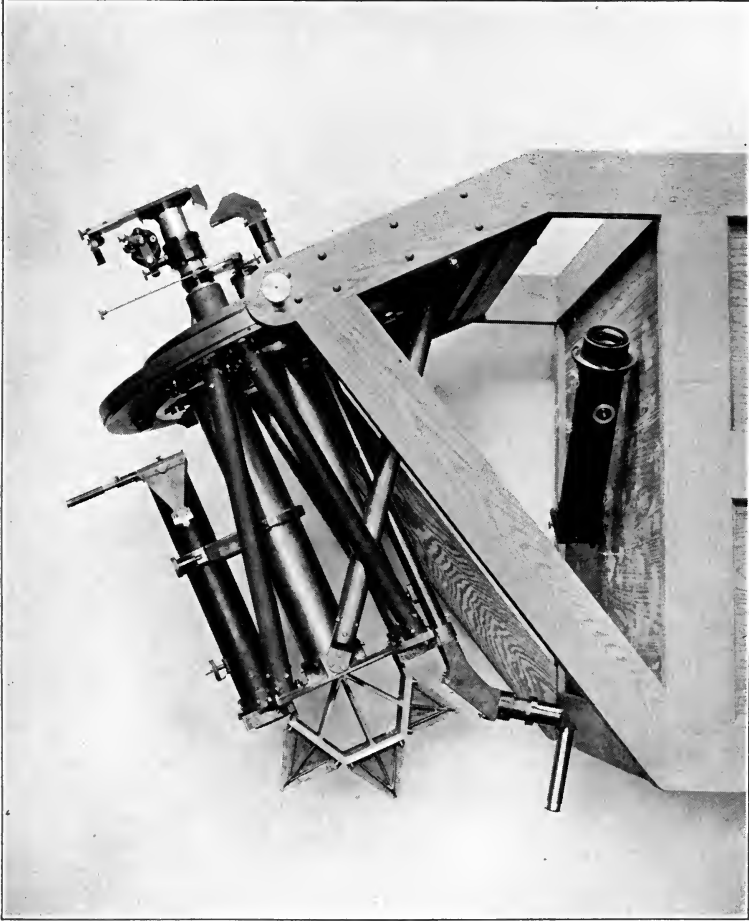

Plate IX

THE BRUCE SPECTROGRAPH OF THE YERKES OBSERVATORY — INTERIOR STRUCTURE

selected. Something may be said at this point in regard to the loss suffered by the light of a star in passing through such an instrument. The ray of light that falls upon the surface of the large objective must pass through its two lenses, which are of considerable thickness, and then through the correcting lens. They next fall upon the slit, where on account of the waverings of the atmosphere there is often much loss, then in order through the lens of the collimator, the three thick prisms, and finally the lens of the camera. Without taking into account the loss of light at the slit, Professor Frost estimates that hardly more than ten per cent of the incident light is transmitted to the photographic plate, and when the atmospheric conditions are bad, not much more than one per cent.

The next step in determining radial velocity is to measure the displacement of the lines in the spectrogram thus obtained. This is done with a special kind of micrometer called a measuring machine. The measurement consists in bisecting the line in the comparison spectrum and then the corresponding line in the stellar spectrum. Many difficulties present themselves in the process, only a few of which can be mentioned here. Since the comparison spectrum is an emission spectrum its lines are bright, but appear dark on the negative. The spectrum of the star, on the other hand, is an absorption spectrum; its lines are dark and appear bright on the negative. Consequently there is a possible source of error in measuring first a dark line and then a bright one. Another difficulty, and a very great one, arises from the fact that in the star spectrum the dispersion is usually quite small and each line is in reality a group of lines. The wavelength of this group must be taken as a whole, hence the importance of giving it the correct value. This is the point which requires the greatest skill and judgment on the part of the measurer.

The spectrum as it appears on the photographic plate is a linear spectrum, and the displacements of the lines are measured in microns or thousandths of a millimeter. These values must be changed into wave-lengths, and then into radial velocity.

The principle which connects the radial velocity with the wave-length is as follows:—

Let  $\lambda$  = the original wave-length,  
 $\lambda'$  = the wave-length of the displaced line,  
 $d\lambda = \lambda' - \lambda$  = the change in wave-length,  
 $v$  = the change in velocity, or motion in line of sight,  
 $V$  = the velocity of light;

then  $v : V = \lambda' - \lambda : \lambda$ ,

and  $v = \frac{d\lambda}{\lambda} \cdot V$ .

It will be seen from this equation that the value of  $v$  depends upon the ratio of  $\frac{d\lambda}{\lambda}$ , since  $V$  is constant, hence in the spectrum of a given star, the displacements will vary with the wave-length, and will be greater in the red end of the spectrum than in the violet.

There is also a formula well known to spectroscopists for converting the linear differences into wave-length, called the Hartmann-Cornu formula. By means of it the velocity is obtained in kilometers per second. When the velocity corresponding to the linear displacement has been deduced, it is not yet the radial velocity of the star, for a portion of it is due to the motion of the earth itself, and must be eliminated. The earth in its revolution around the sun has an orbital velocity of nineteen miles per second. This may be resolved into components in any desired direction, and that one which is in the line connecting the earth and the star can be obtained by an appropriate formula, and applied to the observed motion to obtain the true radial velocity of the star.

The action of the spectrograph must be tested from time to time to see if it is in perfect adjustment throughout and is giving accurate results. This is done by obtaining the radial velocity of the moon or of a planet such as Venus or Jupiter. In each case the spectrum observed is that of reflected sunlight, which offers not quite so much difficulty in deciding upon the wave-lengths of groups of lines as do the stellar spectra, for the solar



spectrum has been very carefully measured and the intensities of the different lines in a group are well known from Rowland's<sup>1</sup> table. However, additional observations of certain stars selected as fundamental should be made from time to time in order to discover whether there are systematic differences in the results obtained at the observatories which are engaged in this work. As stated just previously, each line in the stellar spectrum is, on account of the small dispersion, composed of a group of lines, and the wave-length assigned to it when of the solar type is determined largely by reference to the corresponding group in the solar spectrum taken under similar conditions. In the various types of stellar spectra, different lines which compose the group will have different intensities and hence will displace the center of gravity of the group, which is the point set on by the micrometer. Therefore fundamental stars of unlike types should be selected and the results from different observatories carefully compared and combined.

The number of observatories which are co-operating in this work and their wide distribution on the earth may be judged from a report which recently appeared in the *Astrophysical Journal*,<sup>2</sup> April, 1914. A letter was sent out by E. B. Frost, the editor of the *Journal*, to those engaged in the study of radial velocity, asking for information in regard to their investigations of spectroscopic binaries, in order to prevent unnecessary duplication. Answers were received from the following observatories, thirteen in all: Allegheny Observatory of the University of Pittsburg; Detroit Observatory, University of Michigan; Dominion Astronomical Observatory, Ottawa; Harvard College Observatory; Königliche Sternwarte, Bonn; Kgl. Astrophysikalisches Observatorium, Potsdam; Lick Observatory; Mount Wilson Solar Observatory; Paris Observatory; Pulkowa Observatory; Royal Observatory, Cape of Good Hope; University Observatory, Vienna; Yerkes Observatory.

Assuming then that several spectrograms of a star have been

<sup>1</sup> Henry A. Rowland, *Preliminary Table of Solar Spectrum Wave-Lengths*.

<sup>2</sup> *Ap. J.*, 39, 264.

taken and measured with as great care as possible, the results should be compared to see how well they agree. If on examination they are found to differ not more than a few kilometers, the average is taken and assumed to be the radial velocity of the star. If, on the other hand, the variation is large and is repeated at regular intervals, it is evident that the velocity in the line of sight is variable, and periodically so, hence the star must move to and fro with regularity in the line of sight. There is only one explanation for this phenomenon, namely, that the star is one of a pair, each of which must be moving in an orbit around the common center of gravity, and hence together they form the two components of what is called a spectroscopic binary.

Since we have been considering a spectrum which has only one set of lines, the body which is the companion in the binary system must be very much fainter in order that its lines shall not appear in the spectrum. It is not necessarily entirely dark, but only one or two magnitudes photographically fainter than the brighter component. As Campbell<sup>1</sup> states,

The fourth magnitude companion of a second magnitude star of the same spectral type would scarcely be able to impress itself upon the primary's spectrum. The invisible components in any, and perhaps all, spectroscopic binaries might be conspicuous stars if they stood alone.

However, there are frequent cases in which the spectrum shows the presence of two stars, in which case the lines become double and then single alternately. These are recognized at once as indicating the binary character of the star. More than three hundred spectroscopic binaries of both kinds are known at the present time, about seventy of which have had their orbits computed.

While it is impossible in this volume to give any account of the theoretical method of obtaining the elements of a spectroscopic binary from observations of its radial velocity, it is desirable to mention briefly certain facts to which allusion is fre-

<sup>1</sup> *Stellar Motions*, 278.

quently made. When a series of measurements has been collected, the period of the variation is the first element to be determined. After this has been found, the observations are arranged according to the phase, as is the case of a variable star, then plotted and a smooth curve drawn through them. If the star has no irregularities in its motion and the observations are accurate, they should lie quite close to the curve, which is called the velocity curve. It is by measurements taken from this curve that the elements can be determined, though they are not just the same as those which can be found for an ordinary visual binary star. An excellent statement of them has been given by Campbell in his volume on *Stellar Motions*.<sup>1</sup>

Passing now to the consideration of the question whether many variable stars are spectroscopic binaries, we find the evidence very conclusive, particularly with regard to certain types of variables. While we may not yet have proved the case with regard to all the members of any given class, this is because many of them are too faint for spectroscopic investigation at present, and hence the statement does not apply to those for which the spectrum has not been studied. With these exceptions we may lay down the general proposition that all of the short period variables are spectroscopic binaries. On the other hand, none of the long period variables, and none of those which are irregular, are binaries. In every case the period of the velocity curve is equal to the period of light variation, so that the existence of a connection between the type of the variation and the binary character of the star is definitely recognized. The nature of the relation is not so easily explained; in fact it is understood with certainty in only one type, the Algol type, though numerous theories have been advanced to explain the Cepheid type. The explanation of the variation of the Algol type will be taken up first. It depends upon evidence derived from the light curve as well as from spectroscopic observations. Algol is supposed to be a binary star, one component of which is very much fainter than the other. The plane of the orbit of

<sup>1</sup> *Stellar Motions*, 246-47.

revolution is inclined only a very little to the line of sight, so that an eclipse of each component by the other occurs once in every revolution.

Goodricke, in 1783, was the first to offer this explanation, placing it at the end of a communication to the Royal Society in which he gave an account of his observations of Algol and the determination of the period. He says:<sup>1</sup>

If it were not perhaps too early to hazard even a conjecture on the cause of this variation, I should imagine it could hardly be accounted for otherwise than by the interposition of a large body revolving around Algol, or some kind of motion of its own whereby part of its body, covered with spots or such like matter, is periodically turned towards the earth; but the intention of this paper is to communicate facts, not conjectures, and I flatter myself that the former are remarkable enough to deserve the attention and farther investigation of astronomers.

The eclipse theory is suggested by the appearance of the light curve, which has been shown in Figure 10 and described briefly in Chapter I. A fuller description of it is desirable in this connection. It is therefore repeated in Figure 29, where numbers are attached at different points to show the connection with the other figures and for convenient reference. An inspection of the numbers at the side of the figure will show the change of magnitude during the variation of light. The maximum brightness of the star is maintained at a constant magnitude with a slight variation of less than .1 mg. During the principal minimum it loses about 1.1 mg. The descending and ascending branches of the minimum are symmetrical, and the minimum lasts but a short time. The secondary minimum, while lasting about the same length of time as the principal minimum, is very shallow, there being a change of about .06 mg. The interval of time from 1 to 3 is called the duration of phase. We can see, then, how this light curve suggested an eclipse of a bright star by a dark one. The duration of phase occurs while the dark star is passing in front of the bright star, the eclipse being partial. The time of minimum represents the instant of greatest

<sup>1</sup> *Phil. Trans.*, 73, 482.

eclipse, while the times 1 and 3 represent the first and last contacts. During the rest of the period the entire surface of the bright star is presented to view; light comes from it alone, and the magnitude is very nearly constant. In fact, from the time of Goodricke until 1910 no evidence was offered that the light was not constant at maximum, and it was only with the application of the selenium cell, with its extreme sensitiveness to variations of light, that it was possible to determine a change so small as .06 mg.

The loss of light during the time of principal minimum, 1.1 mg., is by Pogson's rule equivalent to 64 per cent; therefore two thirds of the central body is obscured by the dark companion. Considering the duration of phase in relation to the entire length of period, the angle described by the satellite during the time of phase is about  $50^\circ$ . This, in conjunction with their sizes, would require the radius of the orbit to be very small in proportion to the size of the principal star, when compared with visual binaries. Therefore Goodricke's idea did not meet with favor, because it required a system in which the stars were very large, and yet extremely close together. His idea was later revived by Pickering, who showed by calculation that the change in brightness while undergoing eclipse could be due to obscuration caused by a totally dark satellite coming between the earth and the bright primary; but still the theory was not generally accepted. When spectroscopic apparatus was perfected, so that the displacement of the lines could be measured, Vogel very easily proved the binary character of the star, and in the years 1888 and 1889 collected observations from which he was able to determine the following facts regarding the system.

Diameter of the principal star.....	1,700,000 km.
Diameter of the satellite.....	1,330,000 km.
Distance between their centers.....	5,180,000 km.
Orbital velocity of Algol.....	42 km.
Orbital velocity of the satellite.....	89 km.
Masses of the two bodies.....	$\frac{4}{3}$ and $\frac{2}{3}$ of the sun, or in the ratio 2:1.

This was on the supposition that the satellite was a dark body, but after the discovery by Stebbins<sup>1</sup> of the secondary minimum the companion was no longer regarded as being totally dark, and new elements of the variation were derived and given the following values.

Radius of Algol.....	1.00
Radius of companion.....	1.14
Distance between centers.....	4.77
Inclination of orbit.....	82° 3
Surface intensity of Algol.....	1.00
Surface intensity of faint hemisphere of companion.....	0.050
Surface intensity of bright hemisphere of companion....	0.088
Limiting density of Algol.....	.18☉
Limiting density of companion.....	.12☉

The unusual dimensions of Vogel's system explain why astronomers were loath to believe in its stability. The radius of the satellite is fully .78 of the primary, the distance between their centers only 3.05 of the same unit, and the distance between their surfaces 1.27 of it.

The following diagrams will show the relation between the light curve, the orbital motion, the displacement of the spectral lines, and the velocity curve of the star. The numbers in the different diagrams represent corresponding instants of time. They may be described as follows.

I. *The Light Curve.* The time from 1 to 3 is known as the duration of phase; 1 represents the beginning of the phase; 2 the time of minimum or the middle of the phase; 3 the end of the phase; 4 the instant of time half-way between the principal minimum and the secondary minimum; 5 the beginning of the phase for the secondary minimum; 6 the middle of the secondary minimum; 7 the end of this phase; 8 the point midway between the secondary minimum and the next following principal minimum; and 9, which corresponds to 1, is the beginning of the phase again.

II. *The Relative Orbit.* In this diagram the larger star, *A*, is kept stationary at the center and the orbit is described by *B*,

<sup>1</sup> *Ap. J.*, 32, 213.

relative to *A*. The parallel lines which enclose the principal star are the lines of sight to the earth. On the orbit of *B* position 1 represents the instant when *B* has begun to encroach upon the disc of *A*, *i.e.*, it is the beginning of an eclipse; 2 represents the middle of the eclipse, when the fainter star is projected upon the brighter star; 3 is the end of the eclipse. These positions belong to the primary minimum, because the brighter

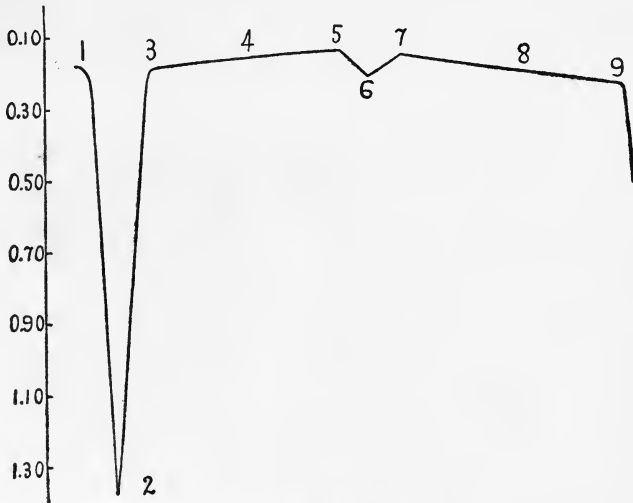

Figure 29. Diagram I  
THE LIGHT CURVE

star is the one which is obscured. 4, which is  $90^\circ$  from 2, represents the point half-way between the principal minimum and the secondary minimum; at 5 the star *B* has begun to disappear behind the disc *A*, which marks the beginning of the secondary minimum; 6 is the middle of the secondary minimum, and 7 represents the time when *B* has almost completely reappeared from behind *A*; 8 represents the point where *B* is again in quadrature with *A*. The correspondence between Figures I and II is very plain.

III. *The Real Orbits.* In this figure  $C$  is the center of gravity and the center of motion of both of the components of the system.  $A$ , being the more massive star, describes the smaller orbit, and  $B$  describes the larger orbit. At any instant they lie

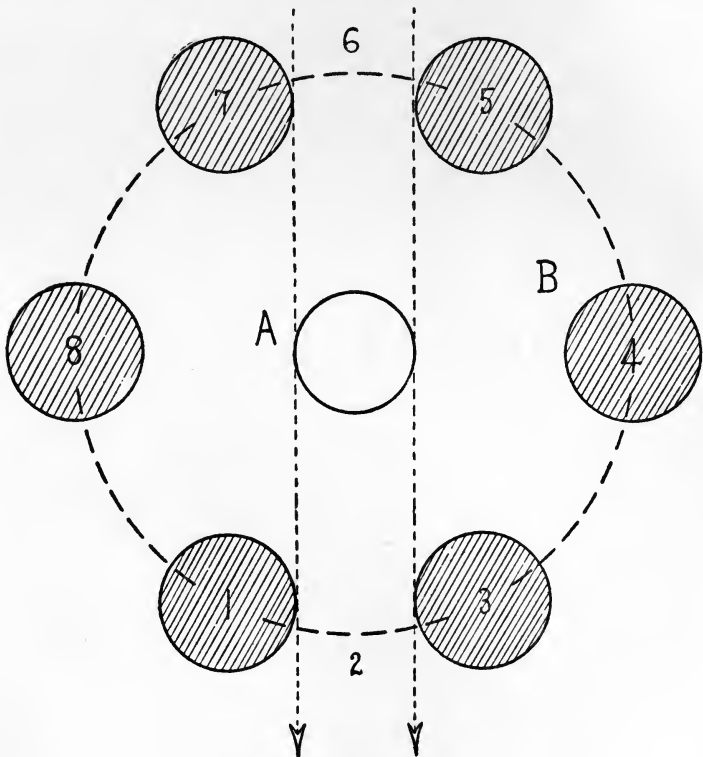

Figure 30. Diagram II  
THE RELATIVE ORBIT

in a straight line passing through the center of gravity. For our purpose it is not necessary to indicate all of the positions which are marked on the light curve, and only those at the conjunctions and quadratures are given. The motion in the orbit is supposed to be anti-clockwise.



IV. *Spectroscopic Evidence.* In this diagram the displacements of the lines in the spectrum of the principal star are given, at the times represented by 2, 4, 6, and 8. The upper line represents the normal position of the lines. Since Algol is of spectral

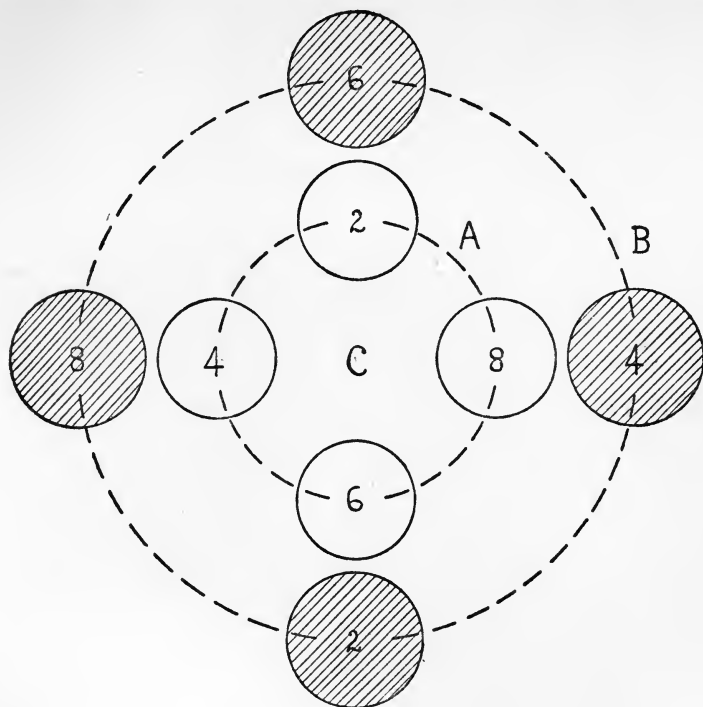
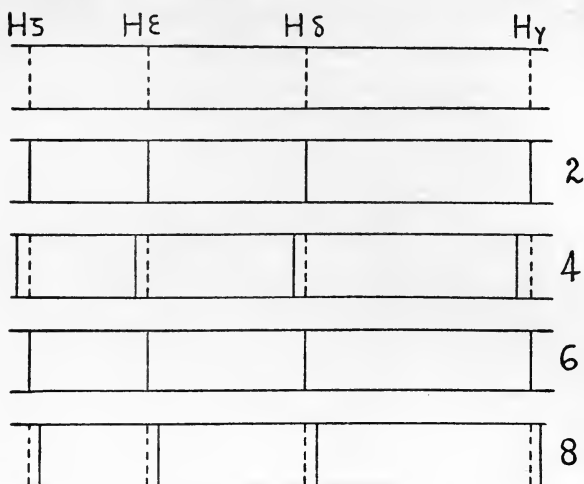

Figure 31. Diagram III  
THE REAL ORBITS

type A, the four lines are supposed to be the hydrogen lines,  $H_{\gamma} - H_{\zeta}$ .

V. *The Velocity Curve.*<sup>1</sup> To obtain it the radial velocities, or displacements of the lines, are plotted as ordinates with the

<sup>1</sup> Frank Schlesinger and R. H. Curtiss, *Publications of the Allegheny Observatory of the University of Pittsburg*, 1, 31.



times as abscissas, and a smooth curve is drawn through the points thus indicated, forming what is called the velocity curve of the star.

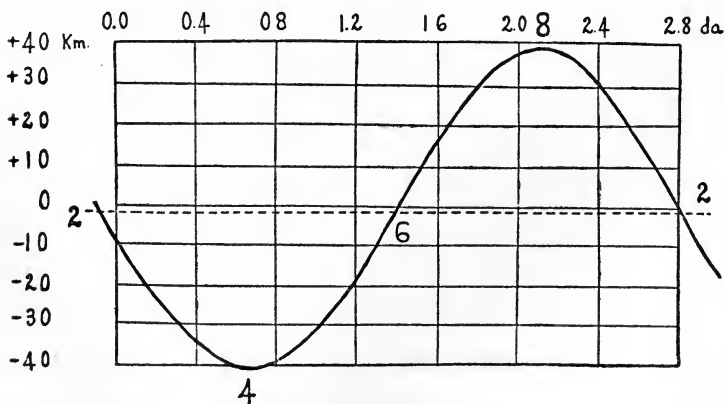



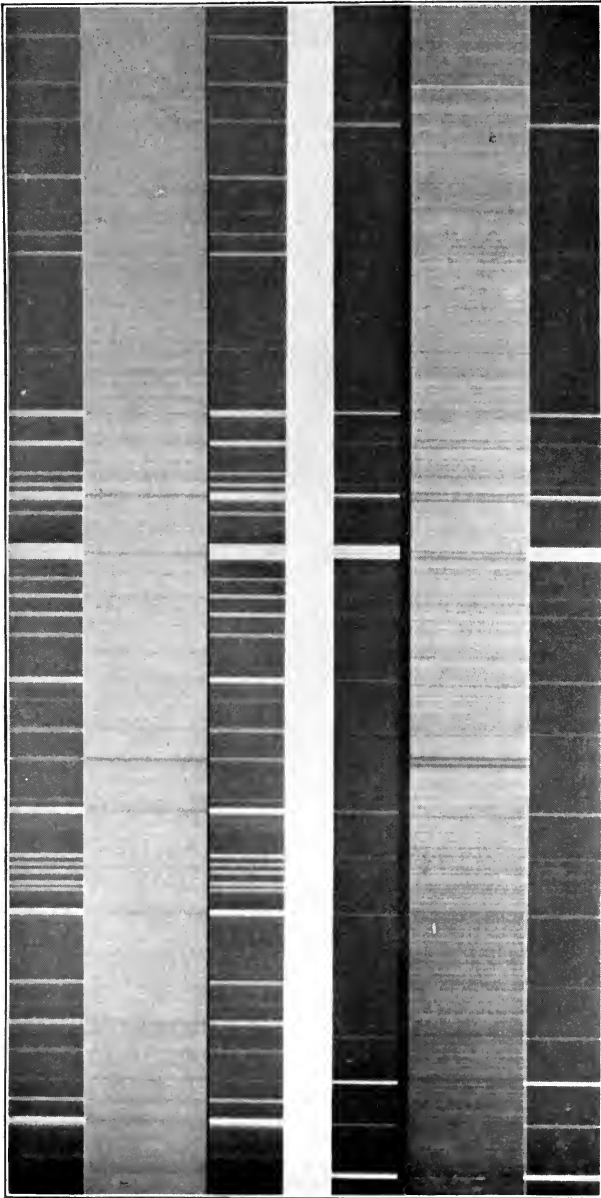

Plate X  
SPECTRA OF  $\zeta$  URSAE MAJORIS

It now remains to point out the connection between these different diagrams. Comparing first I and II, we see from the correspondence of the numbers the relative positions of the primary and satellite during one revolution. As soon as *B* reaches point 1 the light begins to diminish, and reaches a minimum at the time of conjunction, 2. It then begins to increase, and at 3 *B* is ready to pass from in front of *A*. Since the orbit is circular, point 4 will be halfway between the primary and secondary minima. Since *A* is the brighter star, the eclipse just described will be the darker one, and will correspond to the principal minimum. At position 5 the darker star, *B*, has begun to be occulted behind *A*, and the descent to the secondary minimum has begun. 6 is the position where *B* is directly behind *A*, and represents the middle of the secondary minimum. The very small change in magnitude, 0.06 mg., indicates that *B* is very faint in proportion to *A*. 7 represents the instant when *B* is about to emerge from behind *A*, and 8 again is the point midway between the two eclipses. In Diagram III the numbers correspond to those in Diagram II, but in this case *A* also describes an orbit about the center of gravity, *C*, showing that the orbital motion of *A* is to be connected directly with the displacement of the lines in IV, because *A* is the bright body, and is the only one which gives a spectrum.

At any instant the motion of *A* is in a direction tangent to the orbit at that point. In position 2 its motion will therefore be at right angles to the line of sight, and hence the lines in the spectrum will not be displaced, but will be in their normal position. In position 4,  $90^\circ$  from 2, the motion of *A* will be entirely in the line of sight, and directed toward the observer; therefore the lines will have their maximum displacement toward the violet end of the spectrum. At 6 it is again moving across the line of sight, and the lines will be in their normal position, while at 8 it will have its maximum velocity of recession, and the lines will be displaced toward the red. If, therefore, observations of the spectrum of Algol show that at the time of the principal

minimum the lines are in their normal position, are then displaced toward the violet, regain their normal position at the time of the secondary minimum, and then swing toward the red end of the spectrum, indicating recession from the earth, the connection between the orbital motion of Algol and the displacement of the lines in its spectrum is complete.

At the times between 3 and 5, and 7 and 1, the light comes from both stars, and therefore is at a constant maximum. In the velocity curve 2 and 6 represent the normal positions of the lines, where the radial velocity is 0; 4 represents the maximum positive velocity, or greatest rate of approach, and 8 the greatest negative velocity, or greatest rate of recession. If the system, as a whole, has a radial velocity independent of its orbital motion, this will be indicated in the velocity curve by the fact that the areas of the curve above and below the zero line will not be equal. If this is the case, the velocity of the system can easily be found by drawing an abscissa which shall be an axis of symmetry. This is indicated by the dotted line.

If both bodies in the system are bright there will be two sets of lines in the spectrum. When they are of the same spectral type the two spectra will be identical, except that perhaps one may be fainter than the other. Also, if they have unequal masses the orbits described by the two will be of unequal size, and the resulting displacements of the lines will not be the same; therefore the more massive body will be represented by the lines having the smaller displacement, and the smaller body by the lines having the greater displacement. When they are moving across the line of sight the spectrum will be normal, as before.

We now come to a consideration of the various combinations which are possible in an eclipsing system, and it is clear that the evidence which we have comes from two independent sources, as follows: (1) the character of the curve, including the duration of phase; and (2) the character of the spectrum. From these facts we must decide upon the physical and orbital



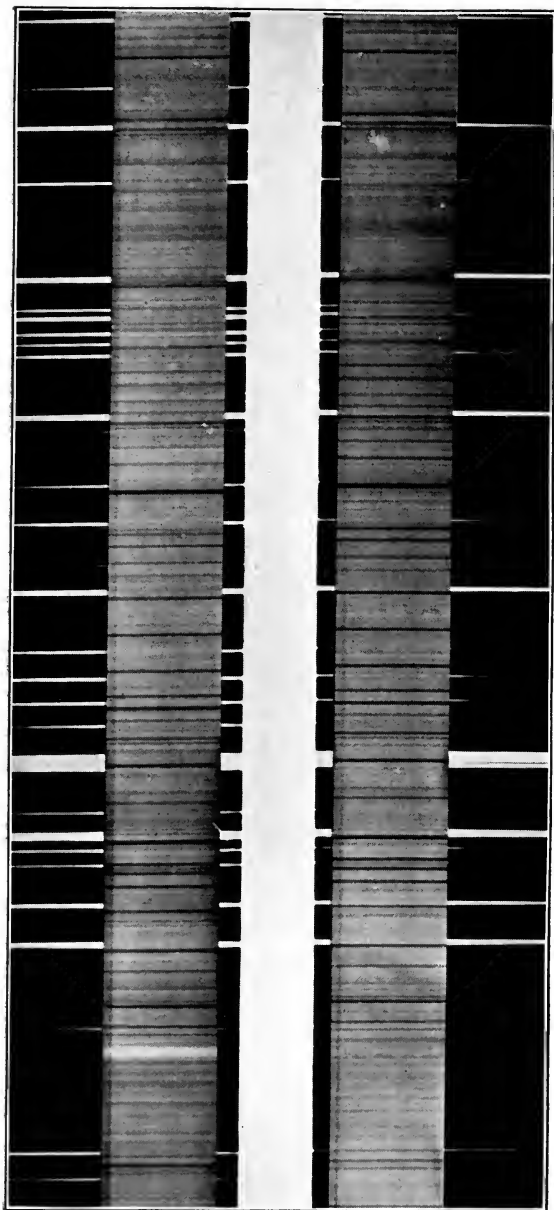

Plate XI

SPECTRA OF  $\mu$  ORIONIS SHOWING DIFFERENT AMOUNTS OF RADIAL VELOCITY



relations of the two components. The light curves may be of four kinds.

(1) There may be a series of equal minima, similar to each other in every respect, occurring at equal intervals.

(2) There may be a series of equal minima occurring at unequal intervals, but arranged in pairs, two and two, the alternate intervals being equal.

(3) There may be a series of unequal minima occurring at equal intervals, the alternate minima being always equal and similar to each other.

(4) There may be a series of unequal minima at unequal intervals, where the alternate minima are equal and similar and the alternate periods are equal.

In the above description the term *equal minima* refers to the change in brightness during the minimum, and to the shape of the curve. The character of the duration of phase also forms a fifth source of evidence which may be expressed as follows.

(5) The minimum may be prolonged, lasting an hour or more, or it may be very brief, not over twenty minutes in duration.

The spectrum may be either single or double, *i.e.*, there may be one set of lines or two: in the former case one body is bright, and the other either dark or else very much fainter; in the second case both bodies are bright. In the latter the two spectra may be of the same class, in which case all of the lines will be doubled at the time of greatest displacement; or if they are of different types only certain of the lines will be doubled. This is illustrated by Plate X, which shows the spectrum of Mizar, or  $\zeta$  Ursae Majoris, taken at two different times. In one case the lines are single and in the other they are double.

Plate XI shows the spectrum of  $\mu$  Orionis, taken on two different dates, showing a change in the displacement of the lines and hence a variable radial velocity.

We must next consider the theoretical half of the problem, that is, the physical relations of the two components and their orbital movements. Upon the former depend the phases, and

upon the latter the intervals between the eclipses. By the physical properties of the two bodies are meant their sizes and brightness per unit area, called by Stebbins surface intensity, but sometimes known as intrinsic brightness. These two properties determine the total brightness of the stars. Four different combinations may arise, for the stars may be of equal or unequal size and their surface intensities may be the same or not. It is only possible to decide which combination is present when there are two minima in the light curve.

Theoretically the orbits may be circular or elliptical. If the latter, the major axis may be in the line of sight or inclined to it, and the plane of the orbit may be inclined at a greater or less angle to the line of sight. It is obvious, then, that there are several possible combinations of stars and orbits in an eclipsing system, but there will be only four light curves to represent them; hence some curves may result from several different combinations. The following statements will indicate most of them. The numbers refer to the curves described a few pages earlier.

(1) This curve may be produced by a system in which there is one bright body and one dark body, or two bright bodies of equal size and luminosity or surface intensity. The orbit may be circular, or it may be elliptical, having its major axis coinciding with the line of sight. It will not be possible from the light curve alone to decide which of these systems is the correct one, though perhaps it may be judged which one is the most probable. Spectroscopic observations combined with the evidence from the curve will settle the point, for if there is only one bright body there will be but one set of lines, whereas if both are bright they must be equally bright in order to produce equal eclipses, hence each will produce a spectrum, and there will be two sets of lines. Measurements of the velocity curve will determine the eccentricity of the orbit and thus decide whether it is elliptical or circular. If it is elliptical, then the major axis must be in the line of sight, or else the eclipses would not occur at equal intervals. Unfortunately this evidence is

lacking for many of the Algol variables because they are faint and their spectra have not been investigated, therefore we are forced to confine ourselves to data derived from the curve alone.

(2) This curve arises from only one combination. There are two bodies equal in size and brightness in the system, the orbit is elliptical, and the major axis is not in the line of sight.

(3) This curve may result from either of two combinations. There must in any case be two unequally bright stars, but the orbit may be circular, or it may be elliptical, with the major axis in the line of sight.

(4) This curve also requires two unequally bright stars, but only one orbit is possible, which is elliptical, with the major axis, making an angle with the line of sight.

The fifth point, the duration of minimum, has been treated very fully by Russell,<sup>1</sup> who has written a series of very important articles dealing with the mathematical theory of deducing certain elements of a system from its light curve. When the minimum is very short, as with Algol, the eclipse is only partial. When it remains constant for some time, as in the case of U Cephei (see Fig. 11), the eclipse is either total or annular.

The difference between the two cases can readily be understood by analogy with solar eclipses, save that there is a greater disparity in the sizes of the two bodies concerned. The eclipse is total if a small star is obscured by a large one, in which case the beginning and end of the minimum magnitude correspond to the beginning and end of totality, or to the times of second and third contact. Whereas if the larger star is eclipsed by the smaller one the eclipse is annular and the minimum phase is reached as soon as the disc of the smaller star is entirely projected on to the disc of the larger one. The times, as before, of the beginning and end of the minimum phase will correspond to the times of the second and third contacts. Whether in any given case a total or an annular eclipse occurs can be determined only by trial, after we have found the relative sizes of the two stars and their surface intensities.

<sup>1</sup> *Ap. J.*, 35, 315; 36, 54.

In studying the light curves, Russell and Shapley<sup>1</sup> have also introduced the hypothesis that the stars may be darkened toward the limb just as the sun is, or perhaps even to a greater extent. Thus for each star of this type the orbit of which has been determined, two solutions have been made, called the "uniform" and the "darkened," the first on the assumption that the star's light is uniformly distributed over its entire surface, and the second on the assumption that the disc is darkened to zero at the edge.

But it is not possible to carry this discussion further in a theoretical direction, for space must be given rather to some of the results which have been determined by Russell and Shapley in applying their methods to the examination of stars of this type. The following are some of the facts which have been gathered from their various papers.

In certain cases, the dark companion has a volume ten times the volume of the brighter, and yet scarcely one tenth of the total light, for example, S Cancri. In some cases both stars are very nearly alike in all respects, as  $\beta$  Aurigae. Others again are similar in size but different in brightness, as U Pegasi. In the majority of instances the dark companions are larger than the bright primaries. Where they are smaller, the difference in size is always slight.

In most of the cases investigated by Shapley he found that the fainter star was self-luminous, and that it was never necessary to assume that the companion was entirely dark. He makes the further statement<sup>2</sup> that in about two thirds of the systems, the difference in brightness of the two components does not exceed two magnitudes, and that no observed difference is greater than four magnitudes. It will be seen from these facts that the differences are not greater than are usually found in visual binaries. The eclipse of a bright star by a dark companion of much less than one half of its radius would ordinarily escape detection. Where it has been possible to determine the

<sup>1</sup> *Pop. Ast.*, 20, 572; *Ap. J.*, 36, 239, 385.

<sup>2</sup> *Ap. J.*, 38, 172.

difference in color at the time of eclipse, the large faint star has been found to be the redder. Of the ninety stars investigated by Shapley, thirteen have spectral type B, fifty two A, ten F, seven G, and one K, six are marked too faint for observation and one is left blank.

The inclination of the orbits must of necessity be small in order to secure an eclipse, but in a few cases of partial eclipse it has been found to be over  $30^\circ$ . For RR Centauri it is  $48^\circ$ .

The densities of the stars in these systems are on the whole much less than that of the sun, though there are some exceptions.

Attention should be called at this point to an important piece of research work just published by Shapley<sup>1</sup> called "A Study of the Orbits of Eclipsing Binaries." Unfortunately it comes too late for the writer to cull from it anything suitable to the present chapter. However, some of the material in it has already been published in earlier articles in the periodicals.

A study of Shapley's orbits shows that he has included  $\beta$  Lyrae and similar stars with those of the strictly Algol type. This is not an unexpected classification, since  $\beta$  has long been known to be an eclipsing star, the difference being that the two components are considerably flattened, and are very close together, so that between eclipses, the area of the light-giving surface turned toward us is not uniform, and hence the light curve does not give a constant magnitude at this time. Twelve stars placed in this class by Hartwig have their elements stated among the ninety of Shapley. The accompanying figure<sup>2</sup> shows the chief characteristics of the system. The peculiarities of the spectrum will be described later.

It would appear that there is no dividing line between the members of the two groups of eclipsing stars; that in the order of evolution, the two components, as they are first formed from the original nebulous mass, are possibly surrounded by the

<sup>1</sup> *Contributions from the Princeton Observatory*, no. 3.

<sup>2</sup> G. W. Myers, *Ap. J.*, 7, 3.

same gaseous envelope, and because of their small density and rapid rotation become elliptical in shape. In the course of time, owing to tidal friction, they tend to separate, and get farther apart so that they are no longer in contact. There will always be two eclipses, but while the two bodies are in such close proximity to each other, the light curve will vary continuously. After they have become spherical and are separated, a certain

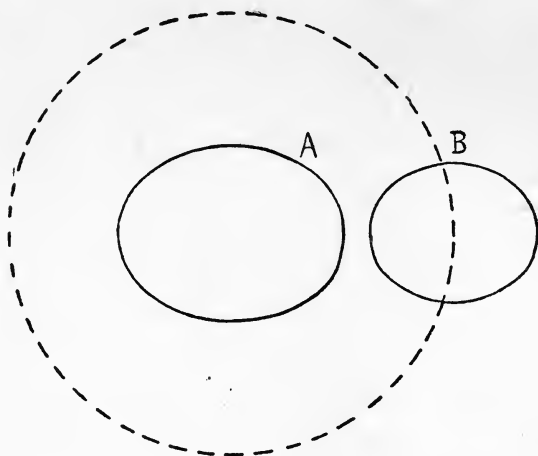

Figure 34

THE SYSTEM OF  $\beta$  LYRAE

distance, the light between the two times of eclipse will come unimpeded from both and will be constant. At the same time it is not at all certain that a star of one type will ultimately develop into one of the other.

A discussion of  $\beta$  Lyrae would not be complete without an account of its remarkable spectrum, which is undoubtedly the most complicated and interesting one in the sky. It consists of bright and dark lines which shift their positions with reference to the normal, showing quite conclusively that it is a binary and that somewhere about the system is an atmosphere which

is of a high enough temperature to give emission instead of absorption lines.

This fact was announced by Pickering<sup>1</sup> in 1891 as one of the first fruits of the Henry Draper Memorial work on stellar spectra. The first sentence in his article states: "The spectrum of the variable star  $\beta$  Lyrae is unlike that of any other star hitherto examined." He next calls attention to the swinging back and forth of the bright lines which was coincident with certain phases in the light curve, and concludes by suggesting that this may be due to the revolution of the body emitting them, and that the star is a spectroscopic binary like  $\beta$  Aurigae, although he offers other explanations also.  $\beta$  Lyrae immediately became an object of study to spectroscopists, but in spite of all the labor which has been expended on it, there are certain points about it which are still baffling. The most recent exhaustive study of it was made at the Allegheny Observatory by R. H. Curtiss<sup>2</sup> and published in 1911, and from this paper a few of the more easily understood points will be taken.

As stated above, the spectrum consists of dark lines and bright lines, that is, an absorption spectrum and an emission spectrum. The dark lines are clearly identified as belonging to two separate spectra, one of which is of type B8A and the other is B5A. The first set of lines oscillates with a range of 369 km. in the period of the light variation. The second set is apparently fixed within quite narrow limits. The lines of the emission spectrum, in the form of broad bands, accompany nearly all the hydrogen and helium lines within the region studied, and do not oscillate, but none exist alone. Narrower emission lines accompany many of the other dark lines. The hydrogen and helium lines are nearly all very complex, since they result from a combination of lines in all three spectra. The study of these lines was difficult in the extreme, and they could not in general be used for the measurement of radial velocity. From the single dark lines a sufficient number was selected upon which to base the measurement of the radial velocity. There is not much

<sup>1</sup> A.N. 3051.

<sup>2</sup> *Publications of the Allegheny Observatory*, 11, 73.

doubt that some of the phenomena of the complex lines are due to differences in pressure, or reversal, or other physical conditions under which the atmospheres of the component stars exist. The special attempts to study and measure the emission lines resulted only in the conclusion that they may oscillate in a complex manner, but that more probably they remain fixed in position while the distribution of the intensity of their different parts is altered. It was hence impossible to measure their positions with the accuracy desired in radial velocity measures.

As an outcome of the observed results, Curtiss describes two different hypothetical systems which may explain the spectral changes in the star. It seems best, however, not to attempt an explanation in this place, and to wait until further evidence has been collected, however loath one may be to leave the study of this fascinating subject. Undoubtedly a higher dispersion such as may be obtained with instruments like the Mt. Wilson reflector will make clearer the relation of the different parts of the complex lines. If it is possible to isolate the central point of the bright lines and measure their displacements, it will assist much in the desired result. As for the second set of dark lines which do not oscillate, they are considered to be due not to a third body, but more than likely to reversals in the atmosphere.

There still remains one class of variables which are spectroscopic binaries, namely, the Cepheid-Geminid group. All of the stars of these two groups which are bright enough to have had their radial velocity measured are spectroscopic binaries, and the period of light variation agrees in every case with that of the shifting of the lines. They are of spectral types F and G. The elements of the orbits of twelve of these stars were studied and compared by Miss Psyche Sutton<sup>1</sup> with the following results.

In every case investigated, only one set of lines appears in the spectrum, hence only one of the component stars is bright. The eccentricities are large, ranging from .10 to .49, and the size of the orbit is small, that is, they are close stars. The shape

<sup>1</sup> *Pop. Ast.*, 19, 408.



of the light curve precludes the possibility of an eclipse. There are some variations in the spectral lines not due to orbital motion, and there is also a significant shifting of the point of maximum energy in the spectrum accompanying the light change. A still more important fact is that the maximum brightness occurs very nearly at the time when the primary star is approaching the observer most rapidly, and the minimum when it is receding most rapidly. There is no connection between the time of maximum light and that of periastron passage.

Several theories have been offered in explanation of these facts, of which only four will be mentioned. The first is that the light variation is due to tidal action. The brighter component is the satellite and the dark one the primary. Since the orbit has a considerable eccentricity, when the bright star is at periastron it is much nearer the primary than at other times, and the gravitational force would hence cause enormous tides, which would elongate the disc, causing a greater light-giving surface to be presented. Allowing for the delay in the crest of the tidal wave due to friction, it would still be necessary for the maximum brightness to occur in the vicinity of periastron; but this relation does not exist, that is, there is no connection between the time of maximum and the time of periastron passage. Besides, as Miss Clerke suggests, such enormous tides would probably disrupt the surface and cause outbursts of heated gas, which would be indicated by the presence of bright lines in the spectrum, and furthermore they would hardly subside in the length of the period, which is after all quite short for the action of such great forces. However, while tidal action is not the main force acting to produce the variation of the star, there is no doubt that its effect is felt in the light curve.

Another theory advocated by Curtiss is that the system is pervaded by a resisting medium which enhances the brightness of that side of the star that faces the direction of motion. Here again the brighter star is the satellite. There are several objections to this theory, one being that the resisting medium would have to be rather dense in order to produce the necessary effect,

and that the material composing it would in time diminish as it is taken up by the brighter star. As it becomes less dense, the effect would be less and the variation of the star in brightness be less. Also there would be a greater range in brightness for stars having more eccentric orbits, which has not proved to be the case.

Perhaps the most acceptable theory, and the one which best fits the observed connection between the times of maximum brightness and maximum velocity of approach, is one proposed by Duncan.<sup>1</sup> He supposes that the brighter star is the satellite, and that the entire orbit is filled with a very rare envelope of nebulous matter, resembling in nature the corona of the sun, but much less dense than is required by the preceding theory. As the star is carried through this by its orbital motion, its atmosphere is brushed back by the friction of this medium, its depth becomes less on the forward side, and the light from the photosphere shines out more brilliantly since it passes through a much smaller layer of the cooler and absorbing atmosphere. This would agree quite satisfactorily with observation, for when the star is approaching the observer most rapidly, the layer of atmosphere facing us would be at its thinnest, and the star would have its maximum brightness. On the other hand, when the star is receding most rapidly, the thickest layer of the atmosphere is turned toward us and the star is at its minimum. This theory is illustrated by the accompanying figure.

The fourth theory can only be alluded to superficially. Very recently Shapley<sup>2</sup> has published a paper in which he states that there are so many objections to each of the theories based on the binary star explanation of the Cepheid type of variation, that it seemed better to him to reject it altogether and consider the light variation as being due to some intrinsic change. The most promising explanation in his opinion is founded on the conception of periodic pulsations in the masses of isolated stars.

Little need be said of the cluster type except that it is essentially identical with the Cepheid type, the division being usually

<sup>1</sup> *L.O.B.*, 151.

<sup>2</sup> *Ap. J.*, 40, 105.

based on length of period. Shapley suggests that Cepheids of periods less than a day shall be called arbitrarily cluster type

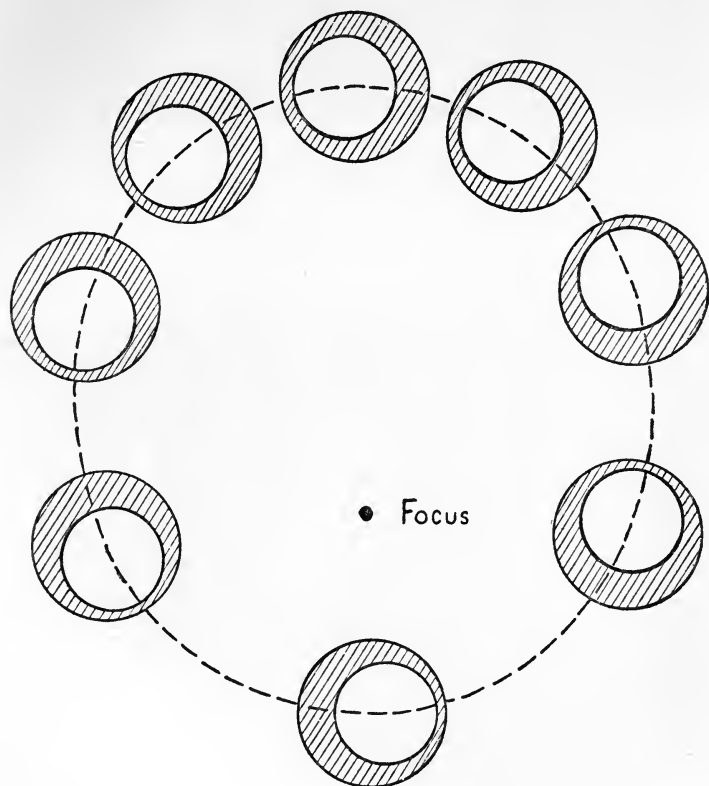

Figure 35

THEORETICAL SYSTEM OF 8 CEPHEI

variables, for there is at present no evidence of real difference between the two classes in nature or probable causes of the light and velocity variations.

## CHAPTER XIII

### LONG PERIOD VARIABLES

PASSING from the study of the short period variables to those of long period, we find ourselves with an entirely different state of knowledge both as regards the light variation and the spectroscopic evidence. The main facts will be given briefly and expanded afterward.

First, the light variation is not so regular as that of the short period variables. The length of the period is not uniform, the magnitude at maximum or minimum is not the same at different times, and the range of variation is large, extending occasionally to five or more magnitudes. Secondly, the spectrum is almost invariably of type M, and is usually marked by the presence of bright hydrogen lines at maximum. None of the stars are spectroscopic binaries.

Very interesting data regarding the curves of these stars can be found in *Annals*, H.C.O.,<sup>1</sup> where are published the results of observations of seventeen long period variables which are circumpolar in this latitude. The following figures, which give the period of S Ursae Majoris at different times and the accompanying magnitude at maximum, show irregularities in both.

S Ursae Majoris; Period,	225 days, Maximum, 7.5 mg.
	206 8.3
	232 7.7
	232 8.0
	218 7.8

The variations in the period are represented in Hartwig by a sine term, showing that they are periodic in character. His elements are

$$\text{J.D. } 240\,0571 + 226.5 E + 35 \sin (5^{\circ}.4 E + 194^{\circ}).$$

The magnitudes of Mira Ceti<sup>2</sup> at maximum are still more

<sup>1</sup> *Annals*, H.C.O., 37, 118.

<sup>2</sup> *Annals*, H.C.O., 55, 120-24.

irregular, as the following list of them taken at random from observations made during the past forty years shows:—

1868 5.2 mg.	1886 5.0 mg.
1869 3.9	1896 4.0
1875 2.5	1897 3.2
1879 4.2	1898 2.4
1885 2.8	1900 3.4

These fluctuations, however, are much greater than are usually displayed by a long period variable. The magnitude of Mira at minimum does not vary so greatly, ranging from 8.5 to 9.6 in the time mentioned. Its period, like that of S Ursae Majoris, is subject to large variations.

In the chapter on the statistical study of variable star data, many other interesting and suggestive facts will be found in regard to this class of variables, and their correlations.

It has been stated that very nearly all of this class give a spectrum of Secchi's third type with bright hydrogen lines at maximum. Practically only one star, Mira, has been investigated for motion in the line of sight in order to discover whether it may be a spectroscopic binary. The evidence is entirely negative. Observations by Campbell<sup>1</sup> made on the dark lines at the time of the bright maximum in 1897 and 1898 give a constant radial velocity and show that the variable is receding from the sun at a uniform rate of 62.3 km. per second, while those made on the bright hydrogen lines at the same time show that they have a velocity of only about 48 km. per second. This would seem to indicate that the envelope which is producing the bright lines must be moving toward the observer with a velocity equal to the difference in these two rates, or 15 km. per second. This would confirm what might already be imagined from the presence of the bright lines, namely, that the increase in brightness is due to enormous outbursts of hydrogen gas which occur with approximate regularity.

The condition of the star may be somewhat similar to that of the sun, only more advanced. It has a tendency to form a

<sup>1</sup> *Ap. J.*, 9, 31.

heavy atmosphere, full of clouds due to compounds; but just as the sun-spots occur with seeming regularity, and are due to a periodic instability in the solar atmosphere, so the balance of forces in the atmospheres of the long period variables is disturbed at certain intervals, allowing outbursts of hydrogen gas from the interior, and resulting in a general increase in the brightness of the star. There is some uncertainty as to what is the exact cause of the brightening, for it has been stated that simultaneously with the hydrogen explosions, there is a general brightening of the continuous spectrum, showing that in some way the underlying photosphere of the star is either brightened or else shines through a less dense layer of the absorbing atmosphere, since the presence of the glowing hydrogen is not sufficient to explain all of the change in the light of the star. As in many other cases, determinations of radial velocity are much to be desired, as well as careful measurements of the intensity of the spectrum at different times.

The color of many long period variables is decidedly reddish. The relation between the color and the length of period will be discussed in the chapter on the statistical study.

Pickering has separated a few stars which are of a peculiar character of variation, and placed them in two subdivisions of this group. He has called them IIb and IIc, the first of which includes U Geminorum, SS Cygni, and SS Aurigae. Its variation was briefly described in Chapter I. U Geminorum remains at the minimum brightness for a large part of the period, then without warning suddenly rises to its maximum brightness, where it remains for a time, and then gradually fades away to the minimum. The duration of the maximum is not always the same, but the curve shows two distinct types of maximum, the long and the short. This enigmatic star has been an object of interest ever since its discovery in 1855 by Hind, an English observer, for the suddenness with which it rises from the minimum makes it necessary to watch it constantly. Two of Hind's countrymen, Baxendell and Knott, were also interested in this star, and being in frequent communication with each

other, occasionally exchanged telegrams when the star unexpectedly brightened. A very complete investigation of the light curve of this star has recently been published by J. Van der Bilt,<sup>1</sup> of the Observatory at Utrecht, from which the following statements have been taken.

Its brightness, which is generally below 13th magnitude, suddenly rises to about the 9.5th magnitude, remains above the ordinary brightness, that of the minimum, for 9 or 17 days, and then repeats the process after a period varying from 60 to 152 days. All attempts to detect a law in the changes of the period have failed. The maxima are of only two types, the long and the short, and these occur alternately. The normal curves are so nearly similar to those of SS Cygni (Chapter I) that they need not be repeated here.

Since it is so faint, even at time of maximum, the spectrum has been only imperfectly observed, but is usually described as hazy, and at times as resembling Class F, the last photograph having been taken on February 28,<sup>2</sup> 1911.

The second star in this group, SS Cygni, has in addition to the long and short maximum a third type, known as anomalous, which is rather symmetrical in outline. The recurrence of the other two types is also remarkable, for sometimes two long or two short maxima will occur in succession, and sometimes the anomalous form will occur in their midst; but usually they are in the order short, long, short, long. A very complete discussion of this star by Leon Campbell<sup>3</sup> may be found in *Annals*, H.C.O.

The spectrum is peculiar and is stated at times to resemble Class F.

The diagram published in *Popular Astronomy* for April, 1914, representing the light variation for 1913 plotted from the combined observations of members of the American Association of Variable Star Observers, shows an interesting variation in what would ordinarily be the short maxima, for instead of following the usual course the upward slope is quite gradual, with a slight

<sup>1</sup> *Recherches Astronomiques de l'Observatoire d'Utrecht*, III.

<sup>2</sup> *Annals*, H.C.O., 56, 210.

<sup>3</sup> *Annals*, H.C.O., 64, 33.

irregularity in it. Whether this change is real and permanent cannot be determined at present.

SS Aurigae, the third star of this group, is quite faint, and has not been under observation long enough for the collection of many data concerning it.

The third division, IIc, of the long period variables, was announced in H.C.O., *Circular*, no. 166, 1911, by Pickering, and contains stars which are ordinarily bright, but sometimes for a year or more become faint without warning, and vary irregularly until they again attain their normal brightness. Three stars are placed in this class by him, R Coronae Borealis, RY Sagittarii, and SU Tauri. Their spectra are also peculiar and subject to changes. These three stars together with the three in the preceding group merit careful attention on the part of variable star observers.

The irregular stars have usually a rather small range, and are somewhat reddish, though varying from one extreme to the other of the color scale, some being among the reddest of the stars. Some very bright stars, such as  $\alpha$  Orionis,  $\alpha$  Cassiopeiae, and  $\alpha$  Herculis, are extremely capricious in their fluctuations, with a range of about half a magnitude.

$\eta$  Carinae is an irregular variable with a most remarkable history, which is detailed at length in Miss Clerke's *System of the Stars*. Its changes, though very great, take place rather slowly. There is at present nothing to indicate whether another rise to extreme brightness will occur now or at any time in the near future.

The peculiarity of its spectrum causes it to be classified with temporary stars rather than with variables. A photograph of it, taken at Arequipa, Peru, in 1898, showed nearly all the bright bands which were in Nova Aurigae in February, 1892, with about the same intensity. This fact was later confirmed by Gill at the Cape of Good Hope. The most recent observations of its spectrum were made by Moore<sup>1</sup> in 1913, at the D. O. Mills station of the Lick Observatory, at Santiago, Chile.

<sup>1</sup> *L.O.B.*, 252.



Three plates were exposed, one in 1912, and two in 1913. They showed a spectrum of bright lines, and no dark absorption lines could be distinguished with certainty. The identification of the lines was quite difficult. Twenty were definitely proven to be the enhanced lines of iron. Titanium and chromium were also recognized, and several other lines seemed to coincide with lines in the chromosphere. Several strong lines could not be identified, and on the other hand, lines of helium, nebular lines, and Mg. 4481 are not present. Moore says:—

A comparison of the spectrum of  $\eta$  Carinae with that of Novae in the early period of their history indicates a close connection between the two spectra. This fact, and the great fluctuation in light exhibited by this star in the past, lends support to the view, frequently expressed, that  $\eta$  Carinae is a Nova. Further support arises from the apparent location of this star in a great nebula.

The history of the temporary stars has been carefully studied and the results presented in a form well suited to the general reader by Miss Clerke. Such stars need here be considered only in their character of variable stars, the light variations of which are to be studied like that of any other variable. They may be described as variables having but a single maximum. The light curve is characterized by a swift rise to maximum followed by a slow and irregular decline to minimum. In the case of one star, Nova Persei no. 2, there was for some time an unusual semi-regular fluctuation, as can be seen by an inspection of the light curve in Chapter I. The main interest centers perhaps in the spectrum of this type, for the enormous displacement of the lines indicates a velocity which seems almost unbelievable. While at first the theory of two bodies, one emitting bright lines and the other dark ones, and moving in opposite directions, seemed to be accepted, it was with some reluctance. Later, that the displacements were due to the effects of pressure in the atmosphere or the gaseous envelope generated by the close approach of two masses of matter appeared more reasonable. At present, astronomers are waiting for more evidence, particularly spectroscopic, before advancing any further theory.

It is also important to get as early a photograph of the spectrum as possible, because in the two instances where this has been done before the typical new star spectrum has developed, spectra of different types have appeared, *i.e.*, Nova Persei no. 2, and Nova Geminorum no. 2, as mentioned in Chapter I. The former star<sup>1</sup> showed first a spectrum of the ordinary Orion type, with no trace of bright lines, except perhaps at the lower edges of the dark lines. On the next night the K line of calcium appeared to be quite strong, but on the third night, that is, February 24, the spectrum had completely changed into that of the ordinary nova. A similar history is recorded of Nova Geminorum.<sup>2</sup> It was discovered by Enebo at Dombaas, Norway, on March 12, 1912, and immediately announced, so that astronomers were enabled to observe it at once. Several plates of its spectrum were taken at Harvard, on March 13, at which time it was plainly of the F5 type, or midway between Procyon and the Sun. There were some differences between its spectrum and the type, though very slight. No change took place during the evening. The next evening, March 14, the spectrum had changed, and was transitional between that of Procyon and the typical new star type. The hydrogen and K lines had bright broad bands on the edge toward the red. On March 15 the transition to the nova type was almost complete. These facts, in connection with early photographs of the region of the sky, may decide whether the star was really a dark body, or merely faint. Long exposure negatives will show the presence or absence of nebulous matter about the star, and throw more light on its origin.

The appearance of this preliminary spectrum is the most difficult fact to account for in any theory which has been offered in explanation of the new stars. Granted that the star to which it belongs was not really a dark star, but only extremely faint, it is difficult to imagine any circumstances which would have made it grow bright, as for instance, in the case of Nova Persei, with such great rapidity, and still retain the same conditions in

<sup>1</sup> *Annals*, H.C.O., 56, no. 111.

<sup>2</sup> H.C.O., *Circular*, no. 176.

its atmosphere that existed before. Yet this is what must have happened. The causes, whatever they were, which generated the great change, must have greatly increased the heat and light radiation of the photosphere of the star before the imprisoned gases burst forth which give its typical spectrum. The subject to be investigated, then, is the exact point at which the tension of the forces within can no longer be held in check, and the disruption must take place. Only a further study of new stars in their early stages can give light on this subject, and since their occurrence is an unexpected phenomenon, it is not possible to prepare for it except as the astronomer must always be prepared for the unexpected.

The later history of these novae <sup>1</sup> is interesting, but rather uniform. The spectrum gives way ultimately to a nebular type of bright bands, which grow faint rather rapidly, leaving only the continuous spectrum, which is that of an ordinary faint star.

The rest of this chapter seems a suitable place in which to describe the collections of some of the older observations of long period variables, which have recently been edited and published. They are of undoubted value, for whatever may be said in regard to the necessity of using the most refined apparatus in making observations of short period variables, the Argelander method in the hands of an expert observer always furnishes material of scientific value for long period variables. The early observers were among the most skillful astronomers, made their observations carefully, and kept their records in good order.

The reasons why such series of observations were not prepared for publication by the observers themselves were usually the same, lack of time and means. The busy astronomer in an observatory was ordinarily occupied in more exact work with instruments of precision, and considered his observations on variable stars as ranking only second in value. There was no regular periodical that had room for publishing the individual

<sup>1</sup> W. W. Campbell, *Stellar Motions*, 38.

comparisons, though results might be welcomed. This meant that the observations must be printed in separate volumes, which could only be done at great expense. So, for one reason or another, the publication was not accomplished in the observer's lifetime. Of recent years much emphasis has been laid upon publishing the original comparisons, and hence nearly all of the longer series made by the leading observers of variables have already been edited. Before describing the contents of the different volumes, it will be necessary first to state what points are included in such a work.

Preparing for publication consists, first, in identifying all the comparison stars, and obtaining their magnitudes, on some recognized photometric scale; second, in examining the records of the original observations of the stars, made night by night, in order to determine the time of each, to see that they are correctly copied into the ledgers for each star, and to find the exact method used in making the comparisons, which was usually some variation of the Argelander method; third, in reducing the final magnitude or light step of the variable for each observation, and in general in studying all possible sources of systematic error and eliminating them. The extent to which these various duties are performed by the editor depends upon what has already been done by the observer, and upon other individual circumstances. The facts can be learned from the editor's statement and an inspection of the tables. The introduction to each collection usually has a concise statement of the equipment and purpose of the observer, and relates how the material passed into the hands of the editor. In the following pages the present writer's aim is to refer to these points, to sketch briefly the life of each observer, with particular reference to his work on variable stars, and then to state in what condition the observations have been published, so that the investigator who wishes to make use of them will have some idea of their contents. Such a report is in no sense a critical discussion of their value. Among those whose observations have been collected and published in this manner are Schönfeld, Heis, Krueger,

Schmidt, Pogson, Knott, and others, but first and foremost stands Argelander, with whom we shall begin.

Friedrich Wilhelm August Argelander <sup>1</sup> was born in 1799, at Memel, being the son of a merchant whose family was of Finnish origin. The royal family of Prussia had removed from Berlin to this part of their kingdom after the events of 1806, and lived in the house of Argelander's father. In the family was the crown prince, afterwards King Frederick William IV, with whom Argelander formed a lasting friendship. He entered the University of Königsberg and enrolled himself as a student of the science of finances. Very soon he became more interested in the lectures of Bessel than in anything else, and begged to be given some computing in the observatory. His request was granted, and he became one of Bessel's most distinguished pupils. His mind turned more and more to questions of practical astronomy, and Bessel strove to strengthen his interest in the science, and in 1820 appointed him assistant in the observatory. It was here, as described in Chapter II, that he assisted Bessel in his experiments in making the star chart, which gave him the idea of the great *Durchmusterung*. The details of his astronomical work need not be presented. He was called to the Observatory at Åbo in 1823, where he remained until the town and University buildings were destroyed by fire. Later the University was removed to Helsingfors, where he also went as the director of the observatory. In 1836 he was called to the newly established University at Bonn, where the Prussian Government had decided to erect a large astronomical observatory, and its planning and construction were placed entirely in his hands. While waiting for the plans to mature he was obliged to content himself with a small equipment, and it was to this time of restricted activity that we owe his *Uranometria Nova*, and his interest in the study of variable stars. He began in December, 1838, with an observation of  $\alpha$  Ceti. He continued this work with much zeal, even while carrying on the zone observations for the *Durchmusterung*, and imparted to the study of variable stars a

<sup>1</sup> E. Schönfeld, *VJS.*, 10, 150.

new dignity and value. Even at the age of sixty, when he felt that his eyesight was becoming feebler, and that his results in this line were no longer valuable, his interest in the subject did not wane. But this was not all. He early saw that there was an opportunity for interesting outside workers in the study of variables, and in 1844 published, in Schumacher's *Jahrbuch*, an article, "An Appeal to the Friends of Astronomy," for the purpose of urging them to make interesting and useful observations of the heavens, including, among other objects of study, variable stars. A translation of this portion of his paper, which the reader is urged to study, has been published by Miss Cannon,<sup>1</sup> of the Harvard Observatory. Argelander reviews the history of variable stars, suggests methods of observing them, calls attention to certain ones which are in need of observation, speaks of working with his friend Heis, and finally utters a fervent appeal to amateurs for co-operation which is worth quoting here, not only because of its meaning, but because it gives us an idea of Argelander himself, and his enthusiasm for his subject: —

Therefore do I lay these hitherto sorely neglected variables most pressingly on the heart of all lovers of the starry heavens. May you become so grateful for the pleasure which has so often rewarded your looking upward, which has constantly been offered you anew, that you will contribute your little mite towards the more exact knowledge of these stars. . . . The observations may seem long and difficult on paper, but are in execution very simple, and may be so modified by each one's individuality as to become his own, and will become so bound up with his own experiences that unconsciously, as it were, they will soon be as essentials. As elsewhere, so the old saying holds here; "Well begun is half done"; and I am thoroughly convinced that whoever carries on these observations for a few weeks will find so much interest therein that he will never cease. I have one request, and it is this; that the observations shall be made known each year. Observations buried in the desk are no observations. Should they be entrusted to me for reduction or even for publication, I will undertake it with joy and thanks, and will answer all questions with care, and with the greatest pleasure.

<sup>1</sup> *Pop. Ast.*, 20.

So stimulating was his character and so great his influence that it is worth while to pause and inquire a little more closely into its sources. The best appreciation of his life comes from Schönfeld, his pupil, assistant, and successor. It is published in the obituary notice given in the *Vierteljahrsschrift* and may be paraphrased in the following words. Argelander was more friendly to practical than to theoretical astronomy. As a teacher his most interesting lectures were on the practical subjects, especially when he had attentive hearers. Whenever he had pupils in whose interest he had confidence, he treated the subject very penetratingly, but he much preferred, at least in his Bonn days and before he felt his years, to talk informally with his students, especially to those closest to him, while walking or when engaged in social intercourse. At such times he often went into the most detailed and interesting explanations, for which in a general lecture there is neither time nor the right audience. But it was not alone the great astronomer whose work and teaching attracted the younger men. It was his entire personality. It would be impossible to depict this in a few words. Whoever was fortunate enough to come into contact with him never forgot the impression made by the sincerity of his character, his great kind-heartedness, his open, cheerful nature, and the fine form of his conversation. Though familiar with those of highest rank in the kingdom of Prussia from his early youth, he was nevertheless a true adviser to the least beginner, a diligent helper to the pupil, a fatherly friend to his subordinates, and a cordial companion to his colleagues. To such characteristics may be attributed in great measure his success in undertakings requiring much co-operation, such as the *Durchmusterung* catalogue. Argelander understood how to win the complete loyalty of his fellow-workers, and to retain it in the work. He studied how to remove every difficulty that might become a source of irritation, and never was his own activity greater than when he noticed, or thought he noticed, a beginning of sluggishness on the part of others.

A large portion of Argelander's observations on variable stars

he published himself in various journals, the *Astronomische Nachrichten* and others. Many appeared in the publications of the observatory at Bonn, vol. 7, part II, which covered a period extending from 1838 to 1867. Many later observations, however, had not been published in his lifetime, and when Prof. Pickering, during a visit to the observatory in 1883, discovered the fact, he asked the director, Schönfeld, if he might have the privilege of copying them for further discussion. Permission was granted, the observations, about 4000 in number, were copied, and taken to Harvard, where they were reduced, and the results published in *Annals*, vol. 33, no. 4. First comes an extended study of the comparison stars, followed by the observations of sixteen variables of long period. The final results contain the Julian Day, the calendar date, the resulting magnitudes, and the residuals. Individual comparisons are not given.

The observations of Schönfeld were edited by Valentiner,<sup>1</sup> who succeeded him as director of the observatory at Mannheim; and when later he became director of the Astronomical Institute at Heidelberg his first work was to publish the extensive series of observations made by Schönfeld. They appeared in 1900. Schönfeld, it will be remembered, was Argelander's assistant in making the northern part of the great *Durchmusterung*. He was called from Bonn in 1859 to become the director of the observatory at Mannheim, in Baden, then just established. The condition of the country did not permit the building up of a well-equipped observatory, and he suffered from lack of adequate apparatus and assistance. Nevertheless he worked diligently in the study of variable stars, and in the course of ten years accumulated a large series of comparisons. He was then called to Bonn, in 1875, to become Argelander's successor, and at once applied himself to the task of preparing the southern *Durchmusterung*, which was the continuation of Argelander's catalogue to declination  $-23^{\circ}$ . This, in conjunction with his labors as editor of the *Astronomische Nachrichten*, did not allow

<sup>1</sup> *Veröff. d. Grossh. Sternwarte zu Heidelberg (Astrometrisches Institut)*.



him time either to continue his observations or to prepare them for publication. He fell ill not long after the completion of the *SBD.*, and died in 1891. Valentiner expresses the greatest admiration and reverence for him and his accomplishment amidst difficult surroundings. "Whoever remembers having seen Schönfeld in his little workroom, which scarcely afforded space for spreading out the books which were necessary for his work of the moment; whoever recollects how unpretentious he was, and how he could always be contented with small means, and knows that Schönfeld achieved more with his small equipment than many a richly endowed institution has accomplished; to him he will be a shining example of German devotion to learning." He often worked from early evening till morning making his observations. His accuracy, as shown by the error of one observation, was about .06 mg. During the years of his stay in Mannheim he compared 117 variables with 1100 other stars, and made 35,963 complete observations, with at least 5000 observations of the comparison stars.

The identification of the comparison stars presented the most difficult task to the editor. Schönfeld was accustomed to mark with a fine pencil in his *Durchmusterung* charts the stars he used. Some of the marks had become partially erased in the course of time. Other drawings were on loose sheets which were frequently misplaced, so that the identification of all of the comparison stars is not perfectly certain. The instruments employed were a Steinheil refractor of 72 Paris lines, = 6.4 inches aperture, a Steinheil comet seeker of 27 Paris lines, = 2.4 inches aperture, and an opera glass. The estimations were made in steps which varied somewhat with the telescope employed, and on this account he frequently used .5 of a step. The publication is divided into two parts, the first of which contains only the original comparisons, and not the resulting magnitudes, and the second the identification of the comparison stars. In order to make these observations suitable for combination with those made elsewhere it will be necessary first to determine the magnitudes of the comparison stars

according to a standard photometer scale. As might be expected, this work has already been carried out at the Harvard Observatory, and the results are published in *Annals*, vol. 64, no. 3. The investigator, then, has only to introduce their values into the original comparisons and thus obtain the magnitudes of the variable. A series of observations by Schönfeld, of thirty-two variables, had been published during his lifetime,<sup>1</sup> but Pickering desired to re-reduce them with improved photometric determinations of the brightness of the comparison stars, and they are given in a manner similar to that used for Argelander's observations, described just previously, excepting that in the table containing the observations one additional column is found, which gives the light grade of Schönfeld, as published by him in the memoirs just referred to.

Another astronomer who enjoyed a friendship with Argelander was Eduard Heis, the author of the star maps described in Chapter II. He was a teacher of mathematics and physics in the Gymnasium at Cologne, and later at a school in Aachen. Astronomy, however, was his favorite science, and he had for his own use a four-inch telescope, but without a dome. In spite of his poor equipment his energy was so great and his eyesight so clear that he was able to make a large number of valuable observations. Even in his old age he was accustomed to say that he saw the stars as sharp points without any rays. He became acquainted with Argelander when the latter was called to Bonn as the director of its observatory, and under his influence he devoted much time to  $\beta$  Lyrae. After his death in 1877 the manuscript of his observations was placed by his family in the hands of Hagen, who had once been his pupil. In consequence of the many questions which came to him Hagen decided to edit and publish the observations.<sup>2</sup> He writes in the preface that the work, though laborious, was dear to him because it permitted him to express his feeling of gratitude and

<sup>1</sup> *Sitzungsberichte der Kaiserlichen Akademie der Wissenschaften* (Vienna), XLII, 146, and XLIV, 503.

<sup>2</sup> *Beobachtungen veränderlicher Sterne*, by Eduard Heis and Adalbert Krueger.

reverence toward his former teacher. In the same volume are included the observations of Krueger, which were also entrusted to him for editing, and he writes, "Their publication in the same volume with the observations of Heis, and with the same method of reduction according to the light steps, will be a welcome gift to observers of variable stars, since they were begun and carried on under the leadership of Argelander, and so establish a tradition of the method of this master."

Heis's observations were made largely with the unaided eye, opera glass, or a small comet seeker, and his list included sixteen stars known to be variable. Since he was not dependent upon an instrument for his observations he frequently made comparisons when on a journey, so that we often find references to other places than his home. In 1856 he must have gone on an unusually extended trip, and taken as his steady companions  $\delta$  Cephei,  $\beta$  Lyrae, and  $\eta$  Aquilae, for we find the names of the places at which he stopped attached to the observations. As it seems to have been his one long journey it is interesting to discover whither he went. On September 3 he was still in Münster, his home. On September 12 he was in Berlin. Proceeding on his journey, he made observations at Bodenbach (between Dresden and Prague, at the frontier), Vienna, and Kremsmünster, reaching lovely Gmunden on September 30. From there he traveled through Ischl, Salzburg, and Fraunstein, reaching Münster again on October 18. What charming memories must have come to him when he looked over his observing books and came across these entries!

In arranging the observations the editor has placed first under each star the data concerning the comparison stars, their names according to Heis, Flamsteed, the *ASV.* of Hagen, and the *BD.*; then follow the steps, zero belonging to the first star; the number of times each was used, and the magnitude, taken from the *PD.*, *HP.*, and other catalogues when possible. The color is also given when known. The observations contain in tabular form the calendar date, the Greenwich M.T., the comparisons, the results in light steps, and the Julian Days.

The observations of Krueger are not so numerous, and are of fewer stars, among them being  $\beta$  Persei and S Cancri, which were observed more assiduously than any of the others. Krueger, when a young man, went to the University of Bonn to be Argelander's pupil, and later became his assistant and son-in-law. He was made director of the observatory at Helsingfors, moved from there to Gotha, and finally became editor of the *Astronomische Nachrichten*, and director of the observatory at Kiel, where he died in 1896. The editing of both of these series of observations is done throughout with great care and thoroughness. The results are particularly useful as a source of illustration because the final mean light step is given. From the work of Heis were taken the observations which were used in Chapters IX and X for determining the light scale of the comparison stars and the mean light curve of a short period variable.

A very large number of observations of variable stars, which extended over a period of thirty-five years, from 1845 to 1879, was accumulated by Julius Schmidt,<sup>1</sup> director of the observatory at Athens. On account of the favorable climate at Athens he was able to make observations with a continuity that could not be equaled elsewhere. His entire collection was sent to Vogel, of the Potsdam Observatory, after his death, and a copy was furnished at the expense of the Harvard College Observatory to Pickering, who had them reduced, in part, and published in vol. 33 of the *Annals*, no. 6. Thirteen variable stars of long period were observed. Unfortunately, not all of the comparison stars could be identified, but in order not to lose the observations a method of relative brightness, as seen by Schmidt, was employed, rather than the absolute brightness, as measured by the photometer. For this reason, and owing also to the fact that Schmidt often used large intervals, such as seven or eight grades, in his estimations, only a portion of the observations was published, the stars selected being four in number. On the other hand, the immense number of the obser-

<sup>1</sup> *A.N.* 2577.

vations, and the persistence with which the comparisons were made, night after night, and year after year, give a decided value to the work. In the table only the Julian Day and the final magnitude are published.

Schmidt was born at Eutin in 1825. While still a schoolboy he showed a decided interest in natural phenomena, especially of an astronomical nature. His eyesight was keen and very sensitive to all the finer distinctions of form, brightness, and color, and he had a special gift for drawing. He perceived that his observations were of scientific value, and devoted himself to them with diligence, undisturbed by the lack of understanding displayed by his schoolmates and teachers. In 1846 he was appointed Argelander's assistant at Bonn, and in 1852, he became director of a private observatory in Olmütz. In 1858 he was appointed director at Athens. One of his finest pieces of work was a drawing of the chart of the moon, for which task his talents particularly fitted him.

Harding's name is mentioned in this connection because he is credited with the discovery of several of the brighter long period variables, R and S Serpentis, R Aquarii, R and U Virginis, which he made during the years 1811 to 1831. The writer was not able to find any special mention of his work on variables, and he is better known for his discovery of minor planets, for which he made a systematic search, and for his star charts, which were perhaps the best of his time. He was a professor at Göttingen, where he died in 1834.

Pogson is most noted, perhaps, on account of having given the value 2.512 to the ratio existing between the brightnesses of two stars of successive magnitudes; nevertheless he was a steady observer of variable stars, and left a large series of observations which has only recently been published in the *Memoirs, R.A.S.*, vol. 58. They were prepared for publication by C. L. Brook, but the volume contains an introductory note by Turner, who had previously edited the observations of Knott and Peek. Norman Pogson was born in 1829 in Nottingham. He was educated for commercial pursuits, but his natural scientific

interests led him to study mathematics and astronomy. He finally took up the work professionally, and held several different positions, one of them being at the Radcliffe Observatory, Oxford, where he became interested in the study of variable stars, and from which place he published his derivation of the value 2.512. Later he was appointed Government Observer at Madras, India, where he died in 1891. While in India he continued his observations of variables, and at his death the manuscript, containing 4214 observations, came into the possession of his nephew, Mr. Baxendell, Jr. Later they passed into the hands of Turner, who had them copied, but was unable to proceed with the reduction. Some time afterward a demand was made for early observations of U Geminorum. It occurred to Turner that it might be possible to secure the publication of the observations in the *Monthly Notices*, one star at a time, and it was with U Geminorum that he began. An appeal for help, however, brought the desired aid from Mr. C. L. Brook, the director of the *British Association of Variable Star Observers*, which resulted in their being published in one volume.

Pogson's observations are especially valuable because he was one of the earliest systematic observers of variables. His publication contains observations and maps for thirty-two stars, thirteen of which he discovered. Finding that there was great need of charts for variables, he planned to issue an extensive atlas, and made many observations of comparison stars for the purpose. Unfortunately the maps were never published, though a few were printed for private circulation. Later ten of them were reproduced under the direction of Hagen, and issued as a part of one of the publications of the Georgetown College Observatory.<sup>1</sup> Pogson also made many color estimations.

The observations of Baxendell (1815-87), the brother-in-law of Pogson, and friend of Knott, are in the process of publication, but not in one volume, as with most collections. The announcement of a prize question on the variable U Geminorum, by the University of Utrecht, created a demand for early

<sup>1</sup> *Supplementary Notes to the Atlas Stellarum Variabilium*, part II.

observations of this star, and hence Baxendell's observations of it were prepared for publication by Turner, in whose hands the entire set had been placed by his son for editing, and were published in advance of his other stars. Turner reports that the original observations had not been copied into ledger form, but this task was immediately performed, and the copy placed for safe keeping in a different building. Baxendell was engaged in business in Manchester, but becoming interested in astronomy, he joined with a friend, and together they built an observatory, and equipped it with a thirteen-inch reflector and a five-inch refractor. Later he removed to Southport, built a new observatory for himself, containing a six-inch refractor, and devoted himself to observation of variables. He was in constant communication with Pogson, using his star maps, and referring to him frequently in his notes. His earliest observation of U Geminorum was made February 1, 1858: —

I believe the star which I have marked U will prove to be the variable now on its march to another maximum. Though very small, it is distinctly defined, has no haziness about it, and is a dull yellow color.

These observations of Baxendell were published in the *Monthly Notices, R.A.S.*,<sup>1</sup> and in a more recent number Turner publishes also his observations of R Arietis,<sup>2</sup> states his reason for continuing the work in this form, and promises that reports on other long period variables will follow from time to time.

Several variable stars were discovered by Hind (1823–95), though no special series of observations by him is mentioned. Born in Nottingham, he was early drawn to the study of astronomy. He held several positions in observatories, and finally became the superintendent of the Nautical Almanac office, in London. He was a friend of Baxendell and Knott.

The observations of George Knott, of twenty-three long period variable stars, were edited by H. H. Turner, and published in the *Memoirs, R.A.S.*, vol. 52, extending from 1860 to 1894. Mr. Knott was one of the English scientists we so often hear of, who, while having independent means, are so thoroughly de-

<sup>1</sup> *Monthly Notices, R.A.S.*, 67, 316.

<sup>2</sup> *Loc. cit.*, 73, 124.

voted to some branch of science that, like Darwin or Huggins, they carry on their line of investigation with unflagging devotion. He early became interested in astronomy, bought first a four-inch reflector, and later a seven-inch refractor by Clark, in 1859. His records were kept with scrupulous neatness, and at his death were already partially reduced, which much facilitated the work of the editor. He gradually entered into an extensive correspondence with other observers of variables, particularly the two Baxendells, and telegrams were frequently exchanged between them, announcing unexpected changes, especially in such irregular variables as U Geminorum. Sometimes these crossed, as when Mr. Knott wrote on one occasion to Mr. Baxendell: —

I was greatly amused at receiving your telegram this morning about half an hour after I had started one to you, and one to Espin, respecting our friend U Geminorum.

After the introductory pages the volume contains a list of the times of maxima and minima as determined by Mr. Knott and entered in his ledgers. For each star is given the chart used in observing it, which is accompanied by the identification of the comparison stars and their magnitudes, and finally the observations, which include the Gr. M.T. of the observation, the light estimations, the resulting magnitudes, the mean magnitudes, and remarks.

Another volume of the *Memoirs*<sup>1</sup> contains observations made under the direction of Sir Cuthbert Peek, at his observatory at Rousdon, near Lyme Regis, during the years 1885 to 1900. These also were edited by Turner, but not until after the death of Peek, who had himself already written the introduction. In it he states that the work was in progress for about ten years, during which twenty-two long period variables were under observation, and 4133 comparisons had been made. These were all done by Mr. Grover, the assistant, though under the close personal supervision of the director. He prepared his own charts, and determined the magnitudes of the comparison

<sup>1</sup> *Memoirs, R.A.S.*, 55.



stars with much care, revising them occasionally. Argelander's method of comparison was used, five stars being employed whenever possible, some of which were brighter and others fainter than the variable. He found an interesting result ensuing when the comparison stars were all either brighter or else fainter, which may be described in his own words:—

Some of the variables rise at maximum considerably brighter than any comparison star within the same telescopic field, while others fall at minimum below the faintest visible; thus it follows that in the first case the comparison can only be made with fainter, and in the second case with brighter stars than the variable itself. A discussion of a large number of observations shows that when the comparison is made entirely with stars fainter than the variable the mean result makes it too bright, while when stars brighter than the variable are employed, the mean magnitude comes out too low.

After 1890 Harvard charts and magnitudes were used for some of the stars.

The list of English observers of variables may be completed by giving brief references to Pigott and Goodricke, friends who worked in the latter half of the eighteenth century. Goodricke was born in Groningen, Netherlands, in 1764. His father was English, and later returned to England and settled in York. In the account of Goodricke, written by Miss Clerke, which is found in the *National Dictionary of Biography*, we find mentioned several of his articles on variable stars, which were published in the *Philosophical Transactions*, but very little is said of his life. A few details of it are given by W. T. Lynn, in a letter to the editor of the *Observatory*.<sup>1</sup> He was a deaf-mute, but in spite of his infirmity he received a good education in classics and mathematics. In a small building in the garden behind his friend Pigott's house the two carried on together their astronomical observations. At eighteen he had discovered the period and the law of the variation of Algol, and suggested that it was due to an eclipse. He also discovered the variability of  $\beta$  Lyrae and  $\delta$  Cephei, and gave their periods. He died at the early age of twenty-two.

<sup>1</sup> *The Observatory*, 25, 271, 368.

Pigott (flourished 1768–1807) made a variety of astronomical observations. He discovered the variability of  $\eta$  Aquilae in 1784, and found its period. He also discovered the variability of R Coronae and R Scuti. He published a catalogue of fifty stars, known or suspected to be variable, in the *Philosophical Transactions*.<sup>1</sup>

Turning now to the American astronomers, we find two of the early workers mentioned in this book whom we wish to include, though neither one has left a collection of observations to be edited by some devoted pupil. They are Gould and Chandler. The former is prominent, not only on account of his work on magnitude, but also because he had a great influence on the development of astronomy in America. Chandler, on the other hand, by means of his papers on various aspects of variable star study, has raised the theoretical side of the subject to a dignified position. Space will be taken to mention a few facts about each. The sketch of Gould is taken from an obituary notice prepared by Chandler for the *Monthly Notices*.<sup>2</sup>

Benjamin Apthorp Gould was born in Boston in 1824, and graduated at Harvard College. After teaching for a year he decided to devote himself to a purely scientific career, and in 1845 sailed for Europe to study astronomy. He was abroad three years, during which he spent three months at the Greenwich Observatory, four at Paris, a year at Berlin, another at Göttingen, four months at Altona, and one at Gotha. He thus came into contact as a student with such men as Gauss, Encke, Wilhelm Struve, Hansen, Peters, and Argelander. As fellow-pupils he had Schönfeld and Auwers, while Von Humboldt, at that time an old man, became his friend. The earnest ambition of this young man, then just twenty-one, must have made a great impression on these European astronomers, who were not so accustomed to the American student as the present day German professor. The older men grew interested in him and assisted him to obtain what he desired, and the young ones became his ardent friends. After his return he maintained a

<sup>1</sup> *Phil. Trans.*, 76, 189.

<sup>2</sup> *Monthly Notices, R.A.S.*, 57, 218.

steady correspondence with many of the great leaders abroad, to whom he was wont to confide his projects and ambitions, and who sympathized with and consoled him in return. Their interest was the deeper, not on account of his personal ambitions, but because of his great desire to strengthen the position of astronomy, and indeed, of all science, in America. With this in view, one of the first projects he carried out on his return to America was to found the *Astronomical Journal*, in 1849. That it really meant giving up some of his personal plans is shown from a sentence in a letter to Encke:—

Though the labor of supporting it will prevent me from working, as I otherwise should, for the advancement of my own reputation, still the consciousness that I may render now a still greater service to science reconciles me to the abandonment of a great deal of personal ambition.

In a letter to Von Humboldt, written in 1850, after speaking of the self-distrust and intellectual timidity in America, he says:—

This I knew before returning home, but realize it now for the first time to its full extent. Therefore it is that I dedicate my whole efforts, not to the attainment of any reputation for myself, but to serving to the utmost of my ability the science of my country.

He edited and supported the *Journal*, offering it to astronomers for the publication exclusively of original investigations. It was interfered with, first by the Civil War, in 1861, and then by his expedition to South America, but was revived again on his return in 1885. As Chandler says of him:—

With such universal and intimate connection with the personal forces operating to advance astronomy in all lands, with his intense patriotism, with his strong intellectual and moral traits, he could not fail to exercise a powerful molding influence upon the development of American astronomy.

Only a brief mention need be made of his astronomical investigations, the most important of which were carried on in the Southern hemisphere. As planned at first the expedition thither was to be provided for by private subscriptions from friends in Boston, but through the enthusiastic support of its representa-

tive to the United States the interest of the government of the Argentine Republic was aroused, and led to the establishment of a permanent national observatory at Cordoba. In addition to the *Uranometria*, mentioned in Chapter V, for which he received the gold medal of the Royal Astronomical Society, he carried on a series of zone observations, covering the region from  $23^{\circ}$  to  $80^{\circ}$  south declination, prepared a general catalogue of stars, made plans for a *Durchmusterung*, and accumulated a series of photographic plates of the principal clusters in the southern heavens, which were taken to Cambridge, where he measured them and prepared the results for publication.

The death of Chandler has occurred so recently that no satisfactory estimate of his position in American astronomy has been published, and hence only a few meager facts of his life can be given. Seth C. Chandler was born in Boston in 1846.<sup>1</sup> After graduating from the High School he worked for Gould as his private assistant, and later entered the coast survey, in 1864. After having held various business positions he settled in Cambridge in 1881, became associated with the Harvard College Observatory, and resumed his astronomical work. From 1886 he devoted his time entirely to investigation. He soon became interested in variable stars, their colors, and the general laws pertaining to stellar variation, publishing at intervals catalogues of variable stars and other important papers. He is perhaps best known among astronomers for his discovery of the variation of latitude. One of his most important contributions to astronomical progress was the editorship of the *Astronomical Journal*, which he took up upon the death of Gould in 1896. As the present editor has written, "If the *Astronomical Journal* was the pet undertaking of its founder, Dr. B. A. Gould, it in no less measure became an object of absorbing interest to Dr. Chandler, when he assumed the responsibilities of the editorship, upon the death of the founder, in 1896." After 1905 ill health overtook Dr. Chandler, and he was not always able to perform his editorial duties. He died December 31, 1913.

<sup>1</sup> *Ast. Jour.*, 28, 101.

## CHAPTER XIV

### A STATISTICAL STUDY OF VARIABLE STARS

A STATISTICAL study may be defined as an effort to correlate sets of values in order to discover if there exists a dependence of one set upon the other. If such a dependence does exist the fact will be shown by the trend of the numbers, or it may be studied by plotting the two sets of values as abscissa and ordinate and examining the resulting curve. In a study of variable stars the quantities to be correlated for each type are number, length of period, range, color, spectrum, and galactic position. Among the sources from which the necessary data are taken is the catalogue contained in the H.C.O., *Annals*, vol. 55, published in 1907, which contains the period, the magnitudes at maximum and minimum, from which the range may be found, the spectral type, and the class of variation. Table II in the same volume contains the colors for many variables. The *Annals*, vol. 56, part VI, gives the spectral type, galactic position, and range. Hartwig's *Ephemeris* for 1914 gives the period and range for a considerably greater number of stars than is found in either of the Harvard catalogues. Hence it was used as a principal source for some of the statistics. Long period variables will be discussed first.

The most obvious relation to be studied is the distribution according to the period. The stars in Hartwig were arranged in groups according to the length of the period, the unit being twenty-five days. The numbers are given in the accompanying table, the first column of which gives the number of days included in each group, and the second the number of stars. In the third and fourth are placed the mean range for each group and the number of stars used in forming this average.

It will be noticed that the numbers in columns two and four are not identical; the reason is that for many stars no observa-

TABLE I

## CLASS II

<i>Period</i>	<i>No.</i>	<i>Mean range</i>	<i>No.</i>
d d			
51-75	8	1.1	8
76-100	8	1.5	8
101-125	10	1.8	8
126-150	16	3.3	15
151-175	19	3.1	18
176-200	23	4.1	13
201-225	46	4.5	35
226-250	53	4.0	32
251-275	51	4.8	35
276-300	48	4.8	30
301-325	47	4.8	35
326-350	49	4.8	27
351-375	38	4.3	27
376-400	37	4.5	25
401-425	21	5.4	13
426-450	16	5.3	10
451-475	7	5.8	2
476-500	9	4.6	8
501-525	3	5.4	2
526-550	1	9.4	1
551-575	3	7.2	2
576-600	1	3.2	1
601-625	1	6.5	1
626-650	0	—	0
651-675	1	0.6	1
676-700	1	1.4	1

tions of the real minimum have been obtained, but only the magnitude below which the minimum must lie, therefore the range cannot be determined exactly; *e.g.*, U Cassiopeiae is given the magnitudes of 7.7 and  $< 14.7$  at times of maximum and minimum respectively.

An examination of the above table shows, first, that the maximum of frequency is reached in the group 226-250 days, though the numbers do not vary much during the entire interval 201-350 days, ranging from 46 to 53; second, that the range increases from 1.1 mg. to 4.5 mg. during the period 51-225 days, but after that, is nearly constant. There are some cases of quite exceptional range, but it also happens that a few stars of

very long period have a small range. The exceptions may be noted.

	<i>Period</i>	<i>Max.</i>	<i>Min.</i>	<i>Range</i>
V Delphini	529 da	7.7 mg.	17.1 mg.	9.4 mg.
SW Geminorum	698	9.2	10.6	1.4
U Lacertae	659	8.5	9.1	0.6

The first of these was observed at minimum by Parkhurst, who was following it with the forty-inch telescope of the Yerkes Observatory and saw it reach a magnitude of  $17 \pm$  on August 29, 1900. This is the lowest magnitude ever observed in the case of a variable. The other two cases might seem a little suspicious, but the elements of SW Geminorum as published by Hartwig were furnished by Enebo, who is a very reliable observer. They are given in the form

$$\text{Min} = 2418683 + 698 \text{ E.}$$

No other reference to the star could be found by the writer.

The next quantities to be correlated are color and period. A valuable article on this subject has been published by Beljawsky,<sup>1</sup> who has drawn his material from the catalogue in volume 55. From Table II of that publication he took the colors of about three hundred variables, the estimations of which had been made by several different observers, but were based largely upon the scales of Chandler and Osthoff. The first step, therefore, was to make them homogeneous, but this was a matter of some difficulty, since the stars common to both scales were few in number. However, they were finally reduced to Osthoff's scale, and a table was formed containing the stars in order of period and type of variation. The first column gives the class, the second the range of the period for each group, the third the mean period for each group, the fourth the mean color, and the fifth the number of stars included.

These numbers, when plotted, show a steady increase of the color with the length of period. In order to discover if there were systematic errors in this table Beljawsky next arranged the stars of Type II, or the long period variables, according to

<sup>1</sup> *A.N.* 4238.

TABLE II

<i>Class</i>	<i>Period</i>	<i>M. Period</i>	<i>M. Color</i>	<i>No. Stars</i>
V	Algol Type	—	<sup>c</sup> 0.83	13
IV	Short period	10 <sup>d</sup>	2.44	20
II	<100 <sup>d</sup>	80	3.4	4
II	100 <sup>d</sup> –200 <sup>d</sup>	163	5.11	24
II	200–250	226	4.07	34
II	250–300	274	5.45	35
II	300–350	325	5.83	49
II	350–400	374	6.70	36
II	400–450	418	7.38	24
II	450–500	474	7.9	7
III	Irregular	—	7.29	44

their declinations, but was unable to find any variation due to this cause. He next compared the color with the maximum

TABLE III

<i>Limits of Mg.</i>	<i>M. Mg.</i>	<i>Color</i>	<i>No.</i>
> 6 <sup>m</sup>	<sup>m</sup> 5.32	<sup>c</sup> 6.8	11
6.0–6.4	6.22	6.0	10
6.5–6.9	6.66	6.0	17
7.0–7.4	7.10	6.10	27
7.5–7.9	7.66	5.90	32
8.0–8.4	8.12	5.75	46
8.5–8.9	8.62	5.56	33
9.0–9.4	9.07	4.65	26
9.5–9.9	9.5	3.1	4



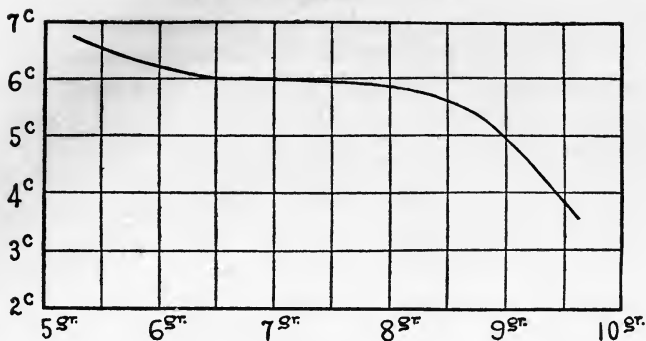

Figure 36

RELATION BETWEEN COLOR AND DECREASING BRIGHTNESS

brightness of the stars, and immediately there appeared a systematic relation, showing that there was a falling off in the color with the fainter stars. It will be remembered in this connection that Osthoff stated that these were all of a uniform grayish color. The table and the resulting curve are given here because of their very great interest.

TABLE IV

<i>M. Period</i>	<i>M. Color</i>	<i>No. of Stars</i>
13 <sup>d</sup>	<sup>c</sup> 2.2	13
80	3.6	4
163	5.04	22
226	4.44	32
274	5.62	34
325	5.79	47
374	6.64	35
418	7.30	21
474	7.8	7
Irregular	7.85	26

On account of this relationship the stars which were brighter than the fifth magnitude and fainter than 9.5 mg. were excluded from the original list, and the curves of the remaining stars were reduced to the mean magnitude 8.0. Table IV contains the recomputation.

Beljowsky also investigated the relation between the period and range with the same results as those already given above. His values ended, however, at 250 days, since the range could not be determined for many stars of longer period on account of the uncertainty of the minimum.

A few exceptional cases of stars of long period having color low on the scale are

	<i>Period</i>	<i>Color</i>	<i>Spectrum</i>
S Piscium	404 da	1.0	Md 6
Z Sagittae	452	2	Md 6
Y Delphini	487	2.0	?

Each of these stars has the average range.

Another interesting correlation to make is between spectral type and color, or between spectral type and length of period, since color and period proceed *pari passu*. Long period variables nearly all have spectra of types M or N, but since not all of them are of the same color, but vary from yellowish white to red, with a maximum at orange, it might well be inquired whether there exists any means of subdividing the class into groups which shall advance with the color. A possible source of information on this subject may be found in *Annals*, vol. 56, part VI, in the study of stars having peculiar spectra, which was carried out by Mrs. Fleming. She subdivided Class Md into ten divisions, but unfortunately her death occurred before she had written a complete description. However, the following brief statement has been published:<sup>1</sup>

A further examination of these spectra shows that they can be further subdivided into eleven groups. A classification was made from an examination of the continuous spectrum, the comparative brightness of the hydrogen lines being also carefully estimated, always assuming the brightness of H $\gamma$  as 10. The first class, of which R Lyncis

<sup>1</sup> *Publications of the Astronomical and Astrophysical Society of America*, 1, 48.

is the typical star, shows a spectrum resembling  $\alpha$  Tauri, and having also  $H\beta$  and  $H\gamma$  strong, bright, and nearly equal, while  $H\delta$  is barely visible. The last group, of which R Leonis is the typical star, shows a continuous spectrum. . . . Of the bright hydrogen lines in R Leonis  $H\beta$  is not seen,  $H\gamma$  is barely visible, and  $H\delta$  is strongly marked. The other classes form a nearly continuous sequence between these extremes.

In an effort to find out if this classification indicated any difference in color the writer collected the colors from volume 55, Table II, according to the subdivisions Md to Md 10, and took the averages, but the results were not especially satisfactory, for there was no marked increase among the divisions, and indeed this was hardly expected, as the classification depended largely upon a study of the comparative brightness of the hydrogen lines, and this would not necessarily affect the color, which would be determined by the absorption in different parts of the spectrum.

The galactic distribution of the long period variables will be given in a tabulated form, together with that of other types of stars, in a later table.

TABLE V  
CLASS IV

<i>Period</i>	<i>No.</i>	<i>Range</i>
d      d		d
0.0- 0.5	25	1.03
0.5- 1.0	15	0.91
1.0- 2.0	3	0.67
2.0- 3.0	2	0.75
3.0- 4.0	10	0.78
4.0- 5.0	11	0.82
5.0- 6.0	10	0.93
6.0- 7.0	10	0.80
7.0- 8.0	9	0.81
8.0- 9.0	3	0.67
9.0-10.0	5	0.86
10.0-15.0	14	1.03
15.0-20.0	12	1.48
20.0-25.0	8	1.34
25.0-30.0	4	1.50
30.0-35.0	0	—
35.0-40.0	4	1.62
40.0-50.0	4	1.10

A study of the short period variables of Class IV may be carried on in the same way as for those of long period. One hundred and forty-eight stars of this class in Hartwig were divided somewhat irregularly into groups in order to show the distribution and difference in magnitude. The mean range for each period was found as before, but in only one case was it necessary to omit a star from the range because the minimum magnitude was not given. This was SX Persei,  $9.1 < 11.5$  mg., Period 4.290. These results will be found in Table V on page 279.

The Algol stars forming Class V were treated in the same way, and the results are exhibited in Table VI.

TABLE VI

CLASS V

<i>Period</i>	<i>No.</i>	<i>Range</i>
d d		d
0.0- 1.0	10	0.98
1.0- 2.0	22	1.12
2.0- 3.0	22	1.63
3.0- 4.0	14	1.99
4.0- 5.0	10	1.51
5.0- 6.0	9	1.51
6.0- 7.0	4	1.08
7.0- 8.0	1	1.0
8.0- 9.0	1	2.7
9.0-10.0	2	1.7+
10.0-15.0	3	1.20
15.0-20.0	1	1.4
20.0-25.0	1	0.6
25.0-30.0	0	0.0
30.0-35.0	3	1.33

The spectral types of all the short period variables in Hartwig are given next, the authority being volume 56, no. vi. Following them are certain exceptional cases about which no special information was furnished beyond the statement that the spectrum was peculiar for the class of variation. It has been mentioned that the stars of Class II were practically all of spectral type M or N.

*Spectral Types of the Short Period Variables*

Class IV. Hartwig, Part II. A 11, Ap 1, F 18, F2 2, F5 13, F8 5, G 23, G2 4, G5 8, K 10, K5 2, M? 1, Mb 2, N 1. Total 101.

Class V. Hartwig, Part III. B3 2, B5 2, B8 4, B9 2, A 60, Ap 3, A3 1, A5 2, F 7, F2 1, G5 ?. Total 85.

Class IV.  $\beta$  Lyrae. Hartwig, Part IV. B 1, B2p 1, B3 1, A 7, Ap 2, F 2. Total 14.

*Exceptional Cases*

Class IV. Y Aurigae, M?; ST Ursae Majoris, Mb; V Ursae Minoris, Mb; V Arietis, N; W Virginis, cont.

Class V. RT Lacertae, G5?

Class II. T Camelopardis, Pec.; SU Tauri, G (this star is in Class IIc with R Cor. Bor.); R Monocerotis, ?; U Geminorum, Pec., resembles Class F; R Sagittae, G; SS Cygni, Pec., resembles Class F.

TABLE VII

<i>Spectral types</i>	<i>White</i>	<i>Yellowish white</i>	<i>Pale yellow</i>	<i>Yellow</i>	<i>Orange yellow</i>	<i>Orange</i>	<i>Orange red</i>	<i>Red</i>	<i>Very red</i>	<i>Total</i>
B and A	10	—	1	—	—	—	—	—	—	11
F	Classes IV and V	4(2)	—	—	—	—	—	—	—	4
F 5 and F 8		—	5(1)	1	—	1	—	—	—	7
G		2	5	2	—	2	—	—	—	11
G 5 to K 5		—	—	3	2	—	—	—	—	5
K		Classes II and III	—	—	2	—	2	—	—	—
Ma	—		—	1	1	1	2	—	—	5
Mb	—		—	—	1	6	2	—	—	9
Mc and Mc 5	—		—	—	1	5	6	1	—	13
Md	2		8	16	42	48	30	2	—	148
N	—		—	—	—	6	22	11	5	44
Total	10		8	19	25	47	71	62	14	5

The general relation between spectral type and color for all the classes of variables has been studied by Franks,<sup>1</sup> who based his studies on the Harvard catalogue, with additional information derived from other sources. He changed the numerical scales of Chandler and Osthoff into verbal terms. His results may be found in Table VII.

The galactic distribution of the variables was next studied with the aid of the values given in *Annals*, vol. 56, no. VI. The sphere was divided into nine zones 20° wide, with the central one including the Milky Way. Table VIII contains in the first two columns the number of each zone and its limiting parallels. In the following columns are to be found the number of variables in each zone according to their class, the last column giving the total number:—

TABLE VIII

<i>Zone</i>	<i>Limits</i>	<i>II</i>	<i>IV</i>	<i>V</i>	<i>β Lyrae</i>	<i>Novae</i>	<i>Total</i>
I	+70° to +90°	5	2	0	0	0	7
II	+50 to +70	33	9	3	0	0	45
III	+30 to +50	53	10	9	1	1	74
IV	+10 to +30	134	24	24	3	4	189
V	+10 to -10	124	88	64	6	22	304
VI	-10 to -30	160	24	25	1	1	211
VII	-30 to -50	79	9	7	1	0	96
VIII	-50 to -70	30	4	3	0	0	37
IX	-70 to -90	14	0	0	0	0	14

In order to determine the density of the variables in each zone it is necessary to introduce the area in square degrees of each zone, which was found in the following manner. The area of the segment of a circle is

$$4\pi R^2(1 - \cos a),$$

<sup>1</sup> *A.N.* 4423.

where  $a$  is the complement of the arc which forms the lower limit of the segment. In this particular case it is the co-latitude of the base of the zone. The ratios of the segments may be found by finding the values of  $1 - \cos a$  for the desired latitudes, and from them the areas of the zones simply by subtracting the area of one segment from the one adjacent. The process is as follows. The zones in the above list have for their bases galactic latitudes  $70^\circ$ ,  $50^\circ$ ,  $30^\circ$ ,  $10^\circ$ ,  $0^\circ$ . Their complements are  $20^\circ$ ,  $40^\circ$ ,  $60^\circ$ ,  $80^\circ$ ,  $90^\circ$ , which are the values of the angle  $a$  to be substituted in the above formula. The resulting values are —

$a$	$1 - \cos a$
$20^\circ$	.0603
40	.2340
60	.5000
80	.8264
90	1.0000

The areas will then be in the ratio of .0603; .1737; .2660; .3264; and .1736, or .3472 if we count the middle zone as extending from  $+10^\circ$  to  $-10^\circ$  gal. lat. If we wish to consider the central zone as unity, which is the most convenient method, they will be in the ratios .174; .500; .766; .940; 1.000.

In order to find the density per zone, divide the number of stars in it by the area and this will give the distribution per unit area. If we divide the result by 304, the number of stars in the middle zone, the result will be the density compared with that of the Milky Way. This process is given in Table IX for all of the variables taken together. The first column gives the number of the zone, the second its area relative to the middle zone, the third the number of stars in each zone, the fourth the number per unit area, the fifth the density relative to the middle zone which contains the Milky Way.

The same kind of study of the galactic distribution has been made by Zinner,<sup>1</sup> who used 1234 stars found in Hartwig's *Ephemeris* for 1912. His values are given in column six, and in the last column are the corresponding values for the distribu-

<sup>1</sup> A.N. 4538.

TABLE IX

Zone	Area	No. stars	$\frac{N}{A} = R$	$\frac{R}{M} = D$	Z	S
I	.174	7	40.2	.13	.14	.35
II	.500	45	90.0	.30	.29	.37
III	.766	74	96.6	.32	.31	.45
IV	.940	189	201.6	.66	.63	.68
V	1.000	304	304.0	1.00	1.00	1.00
VI	.940	211	224.4	.74	.60	.77
VII	.766	96	125.3	.41	.29	.47
VIII	.500	37	74.0	.24	.20	.41
IX	.174	14	80.4	.26	.23	.38

tion of all the stars according to Seeliger. The comparison of the values of these last three columns will show whether the variable stars are congregated toward the Milky Way or not. The distribution in the three middle zones corresponds quite closely to the distribution of all the stars, but variables are not plentiful in the regions about the poles. These lie in the constellations of Cetus and Coma Berenices. The former has ten variables, a very small number considering its size, and the latter only two. It, however, is a rather small constellation, but the adjacent ones, Canes Venatici and Boötis, have eight and fifteen respectively, showing that variables are sparsely scattered about this pole also.

As far as the irregular variables are concerned there seems to be very little material that can be tabulated so as to show definite relations, though a few general conclusions can be stated. The range in magnitude is not large, the average being less than 2.0 mg. The color is decidedly reddish, lying on the scale between 4.0 and 8.0. There seems to be no special connection between range and color, but the number of irregular variables for which the color has been determined is rather too small for



drawing definite conclusions. A star of range 5.3 has color 9.1, while a star of range 2.2 has color 9.7. There are six variables in this class having color grade of 2 or less, no one of which is described as being peculiar. For only two of them is the spectral type given. They are

<i>Star</i>	<i>Range</i>	<i>Spectrum</i>	<i>Color</i>
T Tauri	9.0 — 12.3	Ma ?	0
U Monoc.	5.4 — 7.2	K	2

The stars having largest range are

<i>Star</i>	<i>Range</i>	<i>Spectrum</i>	<i>Color</i>
R Cor. Bor.	5.8 — 13.8	Pec.	2.8
$\eta$ Carinae	- 1 — 7.8	Nova	5
V Hydrae	6.7 — 12.0	IV	9.1
RY Sagittarii	6.6 — 11.5	Pec.	3.5

The spectra of the irregular variables as given in volume 55 are of Type M or N with very few exceptions. Since there is always a possibility that a star long called irregular like u Herculis, Sp. B3A, may later be found to belong to the short period class, any marked peculiarity in the spectrum should at once attract attention and suggest further observations. There are eight of these, including u Herculis, just quoted, and U Monocerotis, given in the preceding list. They are: —

<i>Star</i>	<i>Range</i>	<i>Spectrum</i>
X Tauri	6.6 — 8.1	F 2 G
S Doradus	8.2 — 9.8	In cluster N.G.C. 1910. Spectrum first type, having H $\delta$ , H $\gamma$ , H $\beta$ bright.
Z Monoc.	9.0 — 10.1	G 5 K pec.
RV Librae	8.3 — 9.0	G ?
$\rho$ Cass.	4.4 — 5.1	F 8 G
U Urs. Maj.	6.0 — 6.5	Pec.

Among the irregular variables are a few bright ones which have only a small variation.

<i>Star</i>	<i>Range</i>	<i>Spectrum</i>	<i>Color</i>
$\alpha$ Cass.	2.1 — 2.6	K	5.8
$\alpha$ Orionis	0.6 — 1.1	Ma	7.3
$\alpha$ Herc.	3.1 — 3.9	Mb	6.0
R Lyrae	4.2 — 5.1	Mb	4.1
$\mu$ Cephei	4.0 — 4.8	Ma	7.0

A few statistics from Shapley's investigation of eclipsing binaries may prove interesting. The secondary minimum has been observed in the case of forty-three stars ranging from .02 mg. to .8 mg., of which 11 stars have a variation  $< .1$  mg.

The figure of the stars may next be considered. For eighteen it is spherical, eight more show only a slight flattening, the ratio between the polar and equatorial diameters being  $> .9$ . RR Centauri has the greatest flattening, .631, while  $\beta$  Lyrae has .758. In five cases only is the secondary supposed to be totally dark. The ratio of the surface intensities is in most cases  $> 1.00$ . For seven stars it is equal to unity, showing that the eclipses are equal.

A few interesting miscellaneous facts may now be given. The following list shows the constellations having the largest number of variables. Cygnus is in the lead, the last variable given to it in Hartwig being BB, which corresponds to 80. Next in order come Sagittarius, 71; Scorpio, 65; Carina, 54; Andromeda, 43; Centaurus, 42; Auriga, 41; Draco, 39; Pegasus, 38; Hercules, 38; Aquila, 36; Orion, 36; Cassiopeia, 34; and Perseus 34. These include only the stars which are lettered according to the Argelander method. A few which have other names are not included.

Another fact has to do with the number of variables discovered by a single observer. The data for these facts are taken from volume 55. Mrs. Fleming discovered 108 long period variables; Anderson, 45; Madam Ceraski, 20; Espin, 19; Hind, 18; Peters, 18; Williams, 16; 14 were discovered at Bonn, 13 by Pogson, and 11 by Gould. Of Class IV, 14 were discovered by Roberts, 10 by Williams, 7 by Madam Ceraski, and 5 by Gould. Of Class V, 13 were discovered by Madam Ceraski and 5 by Williams. Of the new stars 8 were discovered by Mrs. Fleming and 2 by Anderson.

It is interesting to note the variables which were discovered previous to the beginning of the nineteenth century. They are arranged in order with the name of the discoverer and other important facts.

1596,  $\alpha$  Ceti, Fabricius, 1.7–9.6 mg., period 331.6+ da., first recognized as periodic in 1638.

1669,  $\beta$  Persei, Montanari, 2.1–3.2 mg., period 2.8+ da., discovered independently by Goodricke in 1782.

1670, R Hydrae, suspected by Montanari, confirmed in 1704, 4.0–9.8 mg., period 425.1+ da.

1686,  $\chi$  Cygni, Kirch, 4.0–13.5 mg., period 406.0+ da.

1782, R Leonis, Koch, 4.6–10.5 mg., period 312.8 da.

1784,  $\delta$  Cephei, Goodricke, 3.7–4.6 mg., period 5.3+ da.

1784,  $\eta$  Aquilae, Pigott, 3.7–4.5 mg., period 7.1+ da.

1784,  $\beta$  Lyrae, Goodricke, 3.4–4.1 mg., period 12.9+ da.

1795, R Coronae, Pigott, 5.5–12.5 mg., period irregular (long).

1795,  $\alpha$  Herculis, W. Herschel, 3.1–3.9 mg., period irregular.

1795, R Scuti, Pigott, 4.8–7.8 mg., period irregular.

These eleven stars may be divided into practically two classes, first those which are of short period and very bright the entire time, and second, those of long period which are very bright at maximum, but telescopic at minimum.

In conclusion a few general results which seem to be quite clearly defined may be stated as follows. There is a maximum of frequency for each type of variable. For the long period class it lies between 200 and 350 days, for Class IV it is less than one day, for Class V it is from one to four days. As far as range of variation is concerned there is a marked difference between long and short period variables. The latter, including Algol, have in general a range of less than two magnitudes, though there are some exceptional cases, while for the long period variables the range increases with the period from 51 to 250 days, and then remains stationary at about fifth magnitude, though ranges of eight and nine magnitudes are known. There is a marked correlation of spectral type and class of variation. Long period variables are nearly all of Class M or N; the stars of Class IV range from A to K, with some exceptions outside of these limits, while for Class V they range from B to G.

The property of the variable stars least amenable to a satis-

factory correlation is the color. This is partly because the color scales are not uniform, and partly because the color of the variable at maximum and as it decreases are not the same. Furthermore, the relation between color and spectral type does not seem to be as fixed as might be expected from other investigations. The long period variables, which are all of Class M or N, vary in color from yellowish orange to red, while from their spectral type they should be quite red. The writer believes that visual estimates of the color are not likely to give satisfactory results, but that use must be made of some form of colorimeter or else of the method of Parkhurst and Jordan, described in Chapter VII, in which the color intensity is determined by comparing photographic and visual magnitudes and connecting these with the spectral types. This might make it possible to arrange a classification of spectral type M in which the classes would indicate the color with some degree of certainty.

## CHAPTER XV

### HINTS FOR OBSERVERS

WHILE short period variables and those with rapid changes must be observed with the best and most refined devices for measuring differences of brightness, there still remains a large field of opportunity for valuable work on the part of an observer with a small telescope, namely, the observation of variables of long period. Since these change slowly and somewhat irregularly there is no need of the great accuracy with which the variables of the class just mentioned must be observed. The number of the long period variables is much greater. They cannot, except in the case of circumpolar stars, be followed throughout an entire period of variation, on account of their being lost in the light of the sun at certain times of the year. Hence it is desirable that as many astronomers as possible should share in observing them.

Realizing that it is not difficult, with sufficient practice, to acquire skill in making comparisons by the Argelander method, Professor Pickering, many years ago, began issuing circulars inviting co-operation in making such observations. They contain directions for observing which are very complete, and cover practically all of the difficulties which the observer is likely to encounter. One of the first pamphlets was issued in 1891, and was entitled *Variable Stars of Long Period*. From it the following suggestions and directions are quoted:—

A natural classification of the variable stars seems to place together those having a period of one or two years. They have many points in common, for instance, when near maximum the lines in their spectra due to hydrogen are usually bright. This peculiarity has in several cases led to their discovery, and perhaps furnishes a clue to the cause of their variation in light. Their color is generally red, and the change in brightness very great. Several of them at maximum are visible to the naked eye, but at minimum become wholly invisible, or at least

beyond the reach of any but the largest telescopes. This variation is as great as that between the brightest and faintest stars visible to the naked eye. Numerous observations have been made of many of these stars, but generally with the object of determining the times at which they attain their greatest brilliancy. The rate of the change, or form of light curve, as it is called, has been comparatively neglected. It is the object of the present paper to provide a means of supplying this omission.

Many astronomers, provided in some cases with excellent telescopes, find difficulty in using them in such a way as will really advance astronomical science. The study of these variables seems especially adapted to such cases. Except the telescope itself no delicate apparatus like clock-work or micrometer is required; even divided circles are not essential, although they facilitate observation. The variation in brightness is also so great that even rough measures will have a value, since the laws regulating many of these variables are almost entirely unknown. When the total change in brightness is small, great skill is required to determine variations with accuracy, but less precision is needed when the variations amount to several magnitudes, especially as great accuracy seems to be unattainable, owing to the color of these stars.

There follows a description of the Argelander method, which need not be quoted here, since the method has already been fully presented in an earlier chapter. Some remarks on the sources of error to be avoided may well be given: —

Evidently the comparison stars should be near the variable, and a very low power should be used so that the apparent distance may be small. Double stars and those near brighter stars should not be used for comparison, since otherwise errors will be introduced, whose amount will vary with the instrument used. Since a star near the edge of the field of the telescope appears brighter than when near the center, it is better to bring each star in turn into the center rather than to place them equally near the edge of the field. When the distance between two stars is so small that they cannot readily be observed alternately, as just recommended, it is probable that owing to the varying sensitiveness of different portions of the retina their relative brightness will appear to vary according to their position. The head should therefore always be turned until the line connecting the eyes is parallel to that connecting the stars, in order that the error may be small in all cases. Its amount may be determined by selecting several pairs of stars, such that in each pair the stars shall be nearly equal in bright-

ness, and one above the other. Compare these stars with the upper stars in the successive pairs, alternately to the right and left, and repeat with the head turned the opposite way, so that each pair is measured once with the upper star to the right and once to the left. The mean of the differences of the results, when the upper star is turned to the right and to the left, will equal twice the error due to their position. When the variable is bright the comparison should also be made with the finder, with the field-glass, or with the unaided eye, since it is difficult to compare two very bright images.

After further remarks regarding the method of finding the region of the variable and of recording the observations, which will be touched upon later, Pickering gives the positions of the comparison stars for seventeen long period variables, which are circumpolar, and concludes with the following recommendations:—

Observations of these variable stars are much to be desired, in order that the results may be compared with those obtained at Cambridge. All seventeen may be observed in two or three hours, with proper appliances and practice. If such observations could be made several times a month by a number of observers, we could determine whether apparent sudden changes in light were due to errors in observation or to actual variation in the star. If observers with large telescopes would undertake to follow these stars when beyond the range of ordinary instruments, we should obtain valuable results regarding the light at minimum. . . . All persons observing the variables or comparing stars according to the system described above, are invited to send their results to Cambridge for reduction and publication on the same system as our own observations. It is hoped that all can be reduced to a uniform scale of magnitude, and thus indicate the nature of the variation of stars much better than we now know it. Should this work commend itself to astronomers it is hoped to extend it to other variables of long period.

The reader cannot help noticing how closely this exhortation resembles that other written by Argelander nearly fifty years earlier; although the language is less flowery, the interest and the appeal are the same.

Ten years later, in 1901, Pickering issued another circular, no. 53, entitled *Co-operation in Observing Variable Stars*:—

The number of known variable stars of long period is now so great,

and is increasing so rapidly, that the observation of many of them has been greatly neglected. Observations by Argelander's method are so easily made that they are specially adapted to observers who, for various reasons, cannot use precise photometric methods. In the case of variables of small range, including those of short period, and many of the Algol variables, the subjective errors greatly diminish the value of observations by Argelander's method. In these cases, also, the periods and light curves appear to be so regular that continuous observations are not needed. It appears to be better to observe such objects photometrically throughout their variation, if possible, and thus determine the light curves. Small variations in the period can then be determined by occasional observations, at times when the light is varying most rapidly. Many of the variables of long period appear to change irregularly, and continuous observations are required until the nature of the change is known. Moreover, the range is in many cases so great that the errors of observation are not sufficient to affect seriously the form of the curve.

After describing the method of making the observations, he continues with further remarks regarding the suitable times for making the comparisons:—

When the variable is faint it is impossible to observe it for several days every month at the time of full moon. At least one observation should be obtained in the interval between the successive times of full moon. This can only be done for polar stars, owing to the proximity of the sun at certain seasons. Since the periods of a large portion of the variables of long period exceed half a year, it is evident that monthly observations will in general give a good idea of the form of the light curve. Of course additional observations should also be obtained, but failure to secure any observation during a long interval should be avoided if possible. Since 1889 an attempt has been made to observe seventeen circumpolar variables north of declination  $+50^\circ$  at least once a month. These stars are always above the horizon at Cambridge, so that they can be observed at all seasons. . . . Similar observations have been made of about sixty other variables, but less regularly. At Arequipa similar observations have been made of a large number of southern variables. It is much to be desired that all variables of long period should be observed in the same way, or at least so that all can be reduced to a uniform scale of magnitude. Co-operation is necessary to attain success in this work. Variables near the ecliptic can be observed when near the sun much better at tropical stations than at those near the pole. The reverse is true for polar variables. Northern variables can be observed for a long portion of the year at northern



observatories, and southern variables at southern observatories. When a variable can be observed only early in the morning it is much more likely to escape observation than at other seasons. . . . When the variable is bright it is best observed with a small telescope, that is, one having an aperture of not more than six or eight inches. Observations of great value could be obtained by an observer with a large telescope if he was notified when the star was too faint to be observed with smaller instruments.

The excellent charts of Father Hagen are almost indispensable for observing the stars when fainter than the ninth magnitude. When the variables are bright, the need has been felt here for charts on a smaller scale, and covering a larger region. After various experiments photographic enlargements have been made of portions of the admirable charts of the Bonn *Durchmusterung*. A region three degrees square surrounding each variable has been enlarged three times, thus giving a map on a standard scale of one minute of arc to one millimetre. The stars on these maps, while appearing coarse by daylight, are thus easily seen and identified at night, without a light bright enough to dazzle the eye. The designations of the stars in the sequence are marked on these enlargements, and copies will be furnished at cost. Charts will be furnished free of cost to experienced observers who are ready to co-operate in the above plan of work. Observations of nearly equal value can be obtained by those unaccustomed to estimating intervals in grades. It is only necessary to enter on the charts the standard magnitudes of the comparison stars, and from these to estimate directly the magnitude of the variable.

There follows a list of fifty-three stars, for which the charts were prepared, with the corresponding magnitudes of their comparison stars.

In *Circular 112*, issued in 1906, Pickering again calls attention to the importance of continuous observations of variable stars of long period, stating that they are especially suitable for observation by amateurs provided only with small telescopes, and unable to devote much of their time and energy to astronomy. He describes again the maps in use at Harvard, which are suitable for this work, the *Durchmusterung* enlargements, and the Hagen charts, and adds that the latter "are supplemented by enlargements which have been made of photographs of 175 regions, taken with the 8-inch Draper and Bache telescope, and show stars of the 12th or 13th magnitude. The scale is

20" = .1 cm., and 8×10 prints on thick paper covering about 1° square have been made of them. They will be sold at cost or given to observers qualified to use them."

He then describes another method of observation which was substituted at the Harvard Observatory for that of Argelander. Though it has already been mentioned in an earlier chapter, we may with advantage quote Pickering's account of it: —

A sequence of comparison stars is selected for each variable, and the photometric magnitude determined, as described in *Annals*, 37. This magnitude, to the nearest tenth, is entered on the photographic charts described above. It is well to omit the decimal point to avoid mistaking it for a star. . . . With the chart thus marked the observation consists in estimating the magnitude directly by comparing it with a brighter and fainter star. Thus, if found to be distinctly fainter than a star marked 96, or of magnitude 9.6, and brighter than one marked 100, we enter the magnitude of the variable 9.8; if nearly as bright as the brighter star, 9.7; and if equal to it, 9.6. These estimates are seldom found to differ by more than a tenth of a magnitude from those obtained by Argelander's method. No further reduction of these observations is required, and the light curve may be constructed the next day, using times and magnitudes as co-ordinates. The observer should never look at the light curve before making the observations, as if he knows what magnitude is to be expected his observations will have little value.

There are about 400 variable stars of long period of the magnitude 9.0 or brighter at maximum, and having a range of three magnitudes or more. Observations of each of these should be made at least once a month. About 300 of those north of declination  $-30^\circ$  are under observation at Cambridge, and about 40 of those south of  $-30^\circ$  at Arequipa. The pressure of other work renders it difficult to follow all of these variables closely, especially in the case of southern stars. Several observatories are now taking part in this work, and it is hoped that the number may be increased, especially for stars in the southern hemisphere. It is only necessary that an observer should be provided with a telescope, preferably of 4 inches or more in aperture, and be able to identify faint stars with certainty. . . . Careful watch of the remarkable and often unexpected changes of a number of stars is an interesting occupation, and the fact that the time is thus usefully expended should induce many observers to undertake it seriously.

The reiterated efforts of Pickering to arouse the interest of astronomers in the observation of long period variables

finally met with considerable success, so much so that he was able to divide up the work among different observers. In 1911, in *Circular 166*, entitled *Co-operation in Observing Variable Stars*, he gives an account of what had been accomplished along this line, and includes a list of 373 variables of long period, which have a range of at least three magnitudes, and are of the magnitude 9.0 or brighter at maximum. He makes the following statement: —

During the years 1906 to 1910 about 17,000 observations have been made by astronomers connected with this observatory, of which 12,000 have been made by Mr. Leon Campbell. Six thousand observations have been kindly communicated by other astronomers, also a very large number of observations have been obtained by the members of the Variable Star Section of the British Astronomical Association, and by many individual observers. To avoid unnecessary duplication and to secure the best results some form of co-operation seems advisable. In the past comparatively few observations have been secured of the southern variables, and accordingly Mr. Campbell has gone to Arequipa to undertake their observation.

He then mentions the names of those who are regular contributors of their observations, and earnestly requests further observations for the following reason: —

While it is often possible to determine the form of light curve from observations made once a month, much more frequent observations are desired, especially in the case of stars whose periods are short. Accordingly a large number of the variables have been assigned to two or more observers. Past experience has shown that owing to clouds, moonlight, and other causes, it will be difficult even then to avoid intervals exceeding a month. On the other hand, there appears to be an endless duplication in the case of certain variables, and it is hoped that this may be avoided by correspondence between the observers. Certain stars of special interest have been assigned to all. This is also desirable for purposes of comparison. It is hoped the observers will find that they can follow many more stars than those assigned to them, as it is not probable that more observations will be secured for a large portion of the stars than will be needed to determine the light curves in each case. Observations of the stars in the east, late at night, or early in the morning, will be of special value in diminishing the interval when the star is too near the sun for observation. For similar rea-

sons observers having large telescopes could do very useful work by observing stars when too faint to be seen with small telescopes.

For several years the approximate magnitudes of variables of long period have been published each month in *Popular Astronomy*. To continue this work it is necessary that astronomers should send to the Harvard Observatory, on the first of each month, a copy of their observations, giving for each star the name, or designation, the date, and the concluded magnitude. Forms will be furnished for this purpose, and charts will be given to observers of the regions of such variables as they will observe systematically.

Collections of observations contributed in this way have been published, together with observations made by the regular staff at the Harvard Observatory, and will be found in volumes of the *Annals*, 37, 57, and 63.

From its beginning, in 1893, *Popular Astronomy* has served as a vehicle of communication for those who are interested in variable star observations. The first number contains the predicted minima of eight variables of the Algol type, for the months of September and October of that year. These predictions were continued through the entire volume, and later other data regarding variable stars began to appear. It would be very interesting to follow historically the developing interest in this work, as expressed by the material contributed to this magazine, but space will not permit it. The interest culminated, however, in 1911, in the formation of a regular society for the purpose of co-operating in the observation of variable stars, which received the title, "The American Association of Variable Star Observers." The first notice of it comes in the form of some recommendations by the editor of the journal, H. C. Wilson, called "What an Amateur Can Do."

Many amateur observers would like to do astronomical work of scientific value, if they only knew what they could do with the appliances which they have. Many spend the time which they devote to evening observation simply looking at various portions of the sky, exclaiming to their friends over the beauties of what they see, and perhaps jotting down a few notes. This is all very well for one who is simply amusing himself, but it should not be dignified by the name of "practical astronomy."

He then mentions several kinds of work that the amateur can do, the first of which is the study of variable stars. He ends with the query: —

Can we not have in America an association of observers with a "variable star section"? . . . We invite correspondence in regard to the matter.

In the next number of *Popular Astronomy* he states that his suggestions seem to have met with a favorable reception, and the necessary correspondence in the direction of such a section was placed in the hands of Mr. W. T. Olcott, 62 Church Street, Norwich, Connecticut, who is still the secretary of the permanent association. He quotes a letter from Professor Pickering, who expresses his interest in the new movement, and states that while the work done by outside observers was being systematically cared for at the Harvard Observatory, still a large amount of useful work could be done in corresponding with the members of the association, providing for neglected stars, distributing photographs, etc. "I believe," he says, "there is useful work for amateurs instead of merely looking at the moon and planets." In the succeeding number of the *Popular Astronomy* the new organization is fully launched, and the first report of Mr. Olcott, the corresponding secretary, appears, which contains suggestions for the future work of the association: —

A preliminary publication should be made of the stars being observed by each member co-operating in this plan. Thus each member will know at the outset who besides himself are observing certain stars on his individual list, and if he has occasion to correspond respecting certain observations he will know at once whom to address in each case. The further suggestion is made that each member of the association send in his list to the writer by the tenth of the month, in order that the report may reach the editor of *Popular Astronomy* in time for publication each month. The list should contain, first, the name and address of the observer, second, the type and diameter of aperture of the instrument used, then the name of the star, the date of observation, and the estimate of its magnitude. As fast as lists are sent to the corresponding secretary they will be forwarded to the editor of *Popular Astronomy* for publication, and soon we hope to have such complete sets of observations that a comparison of estimates will in

each case be a source of pleasure and profit to all participants in this plan. All observations made by members of the association will be sent each month to Professor Pickering, Director of the Harvard College Observatory, who provides the necessary charts, and publishes from time to time discussions of the observations.

He then gives the names of six observers who have signified their intention of joining the association. In November, 1911, the first monthly report of the new association appeared. By this time the membership had increased to fifteen, and in the next month to twenty-five observers, representative of thirteen States in the Union, and Canada. In a letter recently received by the author from Mr. Olcott, the statement is made that the association now has a membership of thirty-five, and that during the past year, 1914, they contributed 14,506 observations of 255 variables.

The British Astronomical Association also has a variable star section, with a membership of thirty-nine observers. Its director is Mr. Charles W. Brook, of Meltham, Yorkshire, England. The work of the section for the year 1913, as published in their annual report, may be summed up as follows: 5014 observations of 33 long period variables were made by 21 observers, and 2786 observations of 6 short period variables by 9 observers.

Many useful hints may be given to the new recruit who is taking up variable star observing, and those who have been working at it for a longer time are only too glad to contribute such suggestions as they have found from their own experience to be most useful. For convenience these may be grouped under the headings: (1) Use of Telescope; (2) Time; (3) Identification of Variable; (4) Method of Recording; and (5) Precautions.

(1) **USE OF TELESCOPE.** The owner of a small telescope can find in any well-known handbook, such as that of Gibson or Noble, complete directions for testing the lens of a telescope and its mounting, and he is supposed to understand the technical part of handling it. Hence we need here give only such suggestions as apply directly to the observation of variable stars.

These include particularly the determination of the width of the field, the penetrating power, and the method of setting. It is necessary to obtain the width of the field in order to know how much of a star map is included in the field of view. This may be ascertained as follows. Turn the telescope to a star which is near the equator and not far from the meridian. Note the time required for it to cross the field, from one side through the center to the other side. This may be done by using a stop-watch, or by counting the beats of a common clock which ticks the seconds. The interval, multiplied by fifteen, to reduce it to arc, will give the width of the field. This should be determined for the finder of the telescope as well as for each of the powers used.

The penetrating power is determined by finding the magnitude of the faintest star visible with the telescope under the best conditions of seeing. This can be accomplished by examining on a clear and steady dark night a field of stars, the magnitudes of which have been well determined photometrically. One such field is the Pleiades, a map of which can be found in Ball's *Popular Guide to the Heavens*. Their magnitudes and positions are given in an excellent article by Muller and Kempf, entitled "The Brightness of 96 Stars in the Pleiades," in *A.N.* 3587-88.

This group of stars has been investigated more frequently than any other in the sky, but there are other fields which can equally well be used for this same purpose. Some of the maps which have been prepared particularly for variable stars will serve this purpose, if we can be sure that the magnitudes of the faint stars have been well determined. Parkhurst, in his *Researches in Stellar Photometry*, has investigated with a wedge photometer attached to the forty-inch telescope, the magnitudes of the faint comparison stars of twelve variables, maps of which may be found in that publication. These furnish, perhaps, the best determinations of magnitudes of the faint stars.

In locating the variable, if the telescope has no circles it should be pointed directly at the region in the sky where the

variable is supposed to be. In case it has circles the setting should be made in the following manner. From the right ascension of the variable and the sidereal time find the hour angle from the equation, —

$$\text{Hour angle} = \text{Sidereal time} - \text{Right ascension.}$$

If the sidereal time is greater than the right ascension, the star has already crossed the meridian, and the hour angle is west, or positive. If the sidereal time is less than the right ascension, the star has not yet come to the meridian, and the hour angle is east, or negative. In order to perform the subtraction indicated in the second member of the above equation, it is sometimes necessary to add twenty-four hours to the sidereal time, but in any case the resulting hour angle must be less than twelve hours.

If the telescope have no clamp in declination, it will be convenient, after setting in declination, to set in hour angle by taking hold of the end of the declination axis, thus avoiding touching the telescope itself and disturbing the setting in declination already made. The order for the observer to follow in setting on a variable, then, would be: first, find the hour angle, decide whether the star is east or west of the meridian, and place the telescope in the proper position with reference to the pier. Next set in declination, and then set in hour angle. If the variable is not in the field of the main telescope, it should, if the setting is correct, at least be near the center of the field of the finder. In handling the telescope, the observer should accustom himself to swinging it, either in right ascension or declination, so that he can move it in either co-ordinate without disturbing the other. This is facilitated if the observer holds his eyes parallel to the diurnal motion of the stars, for then the motion in right ascension will be parallel to that direction, and the motion in declination perpendicular to it.

(2) TIME. Usually the amateur observer has no sidereal clock to use in determining the hour angle. The sidereal time must then be obtained by reducing the mean solar time to the corresponding sidereal time, with the aid of the *American Ephemeris*. The simplest way to proceed is to select some in-



stant of time early in the evening, such as 7 P.M., and change this into the corresponding sidereal time. Set the ordinary clock by the result and it will serve during the hours of observation. Since common clocks read only to twelve hours, and not to twenty-four, when the sidereal time is greater than twelve the observer must remember to add twelve to the face time of the clock. The *Ephemeris* for 1916, which is already in print, gives (on pp. 713-14) the method for computing the change of time with an example. As this can easily be procured from the Government Printing Office, Washington, no further explanation need be given here. The observer must know approximately his longitude. Care must be taken that the mean time clock is set according to U.S. Observatory time, which can be obtained from any reliable jeweler.

(3) IDENTIFICATION OF VARIABLE. The first step to be taken in the identification of variable star fields is to learn how to hold the map properly. Various observers have different ways of doing this. The rule which is given here is one which the writer has used for many years, and considers the simplest and most direct way of accomplishing the desired purpose. It is as follows. Every star map is made for use with the inverting telescope, according to which the lower edge of the diagram is north, the right hand is east, the upper edge south, and the left edge west. The eastern part of the field is also known as the *following edge*, and the western as the *preceding*. It will be noted that the letters N, E, S, W follow each other in an anti-clockwise order. It should also be remembered that by diurnal motion the stars move across the field in a direct line from east to west. Furthermore, in different parts of the sky the inclination of this east and west line to the horizon will vary. Since in looking in the telescope, the observer generally places his eyes parallel to the horizon, this line will make an angle with the line passing through the two eyes, and the map must be turned so as to allow for it. Therefore, on first looking into the telescope, the observer should allow the stars to travel across the field by their diurnal motion. Having noted the direction of

this line, he should hold the map so that the east-west line shall be parallel to the east-west line in the telescope. West can be very easily distinguished from east because the stars come in on the eastern edge of the field, and pass out at the western edge. When west is once located, the other directions, north, east, and south, follow each other in the anti-clockwise direction. This rule seems to be a very easy one to remember, because it is invariable, no matter in what part of the sky the observer is looking, and hence the directions east and west and right hand and left hand need not be considered.

The writer has also found it very advantageous, in comparing the telescopic field with the star map, to incline the head at such an angle that the line joining the eyes is parallel to the east-west line. If the telescope is provided with circles, and the diameter of the field of view has been obtained, it is a comparatively simple matter to identify the variable, for when once the telescope is set for the right position the variable should be in the center of the field, and can be recognized by its position with reference to some conspicuous group of stars in the field. It naturally happens that some fields are more easily recognized than others, but after some experience the observer should have no difficulty in being sure of the identification of the variable. If the telescope is not provided with circles that matter is not so simple.

Since the writer has always been fortunate enough to observe with a mounted telescope she has had no experience in pointing directly at a variable, and has made use of the following hints, which were kindly furnished her by Mr. Olcott: —

The first step, if the glass is not furnished with circles, is to plot on the star atlas (Klein, Schurig, or Upton) the position of the variable. Make a tracing showing its exact position as regards lucid stars near it in the sky. Use the lowest power ocular (a power of thirty on a three-inch glass is excellent). Direct the telescope at the approximate location of the variable, and slowly sweep in this region until you locate the exact field covered by the chart. Identification of the field is greatly facilitated by connecting with lines on the chart the brightest stars on the field. This yields several geometrical figures, and with a

mental picture of these in sweeping with the telescope there should be little difficulty in locating the variable.

In general it may be said that the observer should make use of some star which can easily be identified with the naked eye. This should be placed in the finder, and then, by alignment, or passing from group to group, the field immediately surrounding the variable can be found.

(4) **METHOD OF RECORDING.** The entries made in the record vary more or less with the circumstances of the observer. They should include the date, the instrument and power used, the condition of the sky, whether the seeing is good, mediocre, or poor, whether there is bright moonlight, whether it is misty or frosty, whether the star images are sharply defined, or poor and fuzzy; the name of the star, and the comparisons (here the character of the entry will depend upon the method of observation). The time of the observation should next be given. In the case of long period variables this need be stated only to the nearest tenth of a day; but with variables the period of which is thirty days or less, including the very short period variables, the nearest minute should be given also. If the circles are used for setting it is often convenient to record the sidereal time and the hour angle of the observation.

(5) **PRECAUTIONS.** Several precautions have already been mentioned in Chapter VI, and also appear in the *Circulars* issued by Professor Pickering. The following are given by Parkhurst as essentials for good visual comparisons. Since some of them merely repeat what has been said before quite fully, they need only be briefly mentioned here. First, the line joining the two stars to be compared should be parallel to the line of the eyes. Second, two or three comparison stars should be used at each observation, if they can be found in proper distances and magnitudes. Third, the stars to be compared should be in the same field. Fourth, the interval in brightness should be less than half a magnitude. If this limit is exceeded, the comparisons should be weighted in the reduction inversely as the interval. Fifth, prejudice which might arise from anticipating the

star's expected change should be avoided by postponing reductions till the maximum or minimum is complete. Sixth, the comparison of two bright stars should be avoided by reducing the aperture by a suitable cap (this may sometimes be accomplished by using the finder). Seventh, light in the eyes should be avoided by using for recording a one-candle-power incandescent lamp, so shielded as to illuminate faintly a circle one or two inches in diameter on the record book. In another place Parkhurst suggests using a red light. We have already stated that in the case of colored variables it is essential to take a long and steady look at the star, since it grows brighter by so doing.

Two miscellaneous precautions may be added here. One is intended for the observer who is using Hagen's charts. The scale for Series IV is different from that of Series I-III, the former being one half that of the latter, that is, the field of view of the telescope covers a circle of half the diameter for Series IV, since the side of the square is 60' instead of 30'. This may also be described by saying that the stars on the maps of Series IV will be further apart in the field of the telescope, apparently, than they are for the maps in Series I-III.

The second comes from Yendell, who states that in combining different comparisons of a variable made on the same night, he usually assigns weights depending upon the step intervals of the individual comparisons, as follows: <sup>1</sup>

It is considered that the comparisons most likely to be carefully studied and decided upon are those showing the equality of the variable with its comparison star, so that to such comparisons should be assigned the highest weight. For each step of interval this weight is supposed to be less. From the nature of the case any such scheme of weights is an arbitrary one. The writer has used for many years a system of weights suggested to him by a very experienced observer. The weight of a comparison showing equality is assumed as 8, so that when the interval shall be as much as four or five steps the weight shall still be sufficient to give it its fair share of influence in forming the mean. For each step of interval the weight is reduced by one. The difference between the result obtained by this method and by the ordinary method of taking the simple mean is not sufficient to be

<sup>1</sup> *Pop. Ast.*, 14, 540.

perceptible for single observations, but in reducing long series the use of a system of weights tends to diminish the influence of discordant comparisons, and to smooth out final results.

While it is not possible to reproduce here any star maps for the observer to use, enough has been said to show that they can very easily be obtained by the serious observer, either from the Harvard Observatory, or from the secretary of the Variable Star Association. The latter has kindly furnished a list of variables that are easy to locate because of their proximity to lucid stars, and are therefore recommended for observation with small telescopes which are unmounted. In the list is given the Harvard number as well as the name of the star. If the designation is underlined it signifies that the star is of south declination. The second list contains variables recommended for observation to those who have small telescopes mounted, with circles. These lists are not in any sense complete; they are merely recommended for the beginner.

## LIST I

072708	S Can. Min.
092411	R Leonis.
103769	R Urs. Maj.
141954	S Boötis.
154428	R Cor. Bor.
162119	U Herculis.
<u>170215</u>	R Ophiuchi.
180531	T Herculis.
<u>184205</u>	R Scuti.
193449	R Cygni.
230110	R Pegasi.

## LIST II

021403	o Ceti.
023133	R Trianguli.
043274	X Camelop.
174922	U Geminorum.
123160	T Urs. Maj.
123961	S Urs. Maj.
134440	R Can. Ven.

142584	T	Camelop.
154615	R	Serpentis.
163266	R	Draconis.
194632	$\alpha$	Cygni.
205923	R	Vulpeculae.
210868	T	Cephei.
213843	SS	Cygni.
230759	V	Cassiopeiae.

It is not possible, in the limits of this volume, to include an extended bibliography of the subject of variable stars. There are, however, a few publications that are extremely useful and suggestive to the non-professional worker, which may be mentioned here. It may also be stated that Hagen, in the first volume of *Die Veränderlichen Sterne*,<sup>1</sup> gives a very good bibliography which contains in general separate books, publications of observatories, and proceedings of Academies, but not ordinary articles from periodicals. The books which the author has found to be specially useful are André, *Traité d'Astronomie Stellaire*;<sup>2</sup> Campbell, *Stellar Motions*;<sup>3</sup> Clerke, *Problems in Astro-Physics*,<sup>4</sup> and *The System of the Stars*;<sup>5</sup> Scheiner, *Populäre Astro-Physik*,<sup>6</sup> section on photometric apparatus, which gives a brief account of a great many of the different kinds of photometers; Turner, *The Great Star Map*,<sup>7</sup> which gives an account of the formation of the *Carte du Ciel*. Gould's *Uranometria Argentina*<sup>8</sup> is excellent for its miscellaneous information regarding magnitudes and star maps; Baly, *Spectroscopy*,<sup>9</sup> though very technical, has some useful descriptive and historical sections. André has the best material on the history of stellar magnitude. The *Annals* of the Harvard Observatory are so well known that

<sup>1</sup> *Hedersche Verlagshandlung*, Freiburg in Breisgau, Germany; 1913.

<sup>2</sup> Gauthier-Villars, Paris, France; 1899.

<sup>3</sup> Yale University Press, New Haven, Conn.; 1913.

<sup>4</sup> Adam and Charles Black, London; 1903.

<sup>5</sup> Longmans, Green and Co., London and New York; 1890.

<sup>6</sup> B. G. Teubner, Leipzig and Berlin; 1908.

<sup>7</sup> E. P. Dutton, New York; 1912.

<sup>8</sup> Printed by Paul Emile Coni, Buenos Aires; 1879.

<sup>9</sup> Longmans, Green and Co., London and New York; 1905.

it is hardly necessary to make any special reference to them. However, they contain so much material on the subject of variable stars that it is sometimes difficult to find exactly what one wishes. For the purpose of obviating this difficulty Pickering has recently issued a pamphlet which summarizes the contents of the *Annals*. In it there appears first a classification of the volumes according to the subjects. This is followed by a list including the titles of the different parts of all the volumes. After this is given a description of the contents of each part which is sufficiently full to enable the investigator to find the object of his search. The writer may perhaps mention a few of the volumes which have proved most useful in her work. Volume 37 was the first to give the lists of comparison stars for variables and the method of determining their magnitudes. It also furnishes the method of determining the mean light curve of long period variables. The second part, which was issued after the first three series of Hagen's *Atlas* had appeared, contains the material for converting the Hagen grades into magnitudes on the Harvard photometric scale, for many stars in Series I-III.

Volume 57 contains also observations of long period variables, made during the years 1902-1905; the second part includes lists of comparison stars for 252 variables, for the rest of Hagen's stars in Series I-III, not included in Volume 37, and also stars in the other series. Volume 55 contains the catalogue of variable stars, also a table stating the colors of variables, so far as they have been observed, and an index to the maps which have been published. Volume 24 contains the magnitudes of 20125 faint stars, in zones 20' wide, and having centers in declinations  $-20^{\circ}$ ,  $-15^{\circ}$ ,  $-10^{\circ}$ , etc., to the north pole. These are particularly useful in forming light scales for new variables, where the observer must depend upon the *Durchmusterung* maps alone. Volume 50 contains the magnitudes of 9111 stars, mainly of mg. 6.5 and brighter, and superseding the catalogue of stars in the preceding volumes. At the end is a very useful abbreviated Table, VII, which is called an index to the Bayer

and Lacaille letters. The stars are arranged in order of constellation, and the tables contain: first, the letter; second, the number in the catalogue; third, the magnitude; and fourth, the spectral type. Volume 28 gives the classification of stellar spectra, with plates. Volume 9 contains Peirce's work with the Zöllner photometer, and his discussion of the older catalogues, including the manuscripts of Ptolemy's *Almagest*.

THE END



## APPENDIX



TABLE I

<i>Table Ia</i> For Century		<i>Table Ib</i> For Year in Century					<i>Table Ic</i> For the Day		
-1900	1 027 083	00	0 or-1	50	18 262				
-1800	1 063 608	01	365	51	18 627				
-1700	1 100 133	02	730	52	18 992	Jan. 0	0	0	
-1600	1 136 658	03	1 095	53	19 358	10	10	10	
-1500	1 173 183	04	1 460	54	19 723	20	20	20	
						30	30	30	
-1400	1 209 708	05	1 826	55	20 088				
-1300	1 246 233	06	2 191	56	20 453	Feb. 0	31	31	
-1200	1 282 758	07	2 556	57	20 819	10	41	41	
-1100	1 319 283	08	2 921	58	21 184	20	51	51	
-1000	1 355 808	09	3 287	59	21 549				
- 900	1 392 333	10	3 652	60	21 914	Mar. 0	59	60	
- 800	1 423 858	11	4 017	61	22 280	10	69	70	
- 700	1 465 383	12	4 382	62	22 645	20	79	80	
- 600	1 501 908	13	4 748	63	23 010	30	89	90	
- 500	1 538 433	14	5 113	64	23 375				
						April 0	90	91	
- 400	1 574 958	15	5 478	65	23 741	10	100	101	
- 300	1 611 483	16	5 843	66	24 106	20	110	111	
- 200	1 648 008	17	6 209	67	24 471				
- 100	1 684 533	18	6 574	68	24 836	May 0	120	121	
0	1 721 058	19	6 939	69	25 202	10	130	131	
						20	140	141	
+ 100	1 757 583	20	7 304	70	25 567	30	150	151	
+ 200	1 794 108	21	7 670	71	25 932				
+ 300	1 830 633	22	8 035	72	26 297	June 0	151	152	
+ 400	1 867 158	23	8 400	73	26 663	10	161	162	
+ 500	1 903 683	24	8 765	74	27 028	20	171	172	
+ 600	1 940 208	25	9 131	75	27 393	July 0	181	182	
+ 700	1 976 733	26	9 496	76	27 758	10	191	192	
+ 800	2 013 258	27	9 861	77	28 124	20	201	202	
+ 900	2 049 783	28	10 226	78	28 489	30	211	212	
+1000	2 086 308	29	10 592	79	28 854				
						Aug. 0	212	213	
+1100	2 122 833	30	10 957	80	29 219	10	222	223	
+1200	2 159 358	31	11 322	81	29 585	20	232	233	
+1300	2 195 883	32	11 687	82	29 950	30	242	243	
+1400	2 232 408	33	12 053	83	30 315				
+1500	2 268 933	34	12 418	84	30 680	Sept. 0	243	244	
						10	253	254	
+1600	2 305 448	35	12 783	85	31 046	20	263	264	
+1700	2 341 972	36	13 148	86	31 411				
+1800	2 378 496	37	13 514	87	31 776	Oct. 0	273	274	
+1900	2 415 020	38	13 879	88	32 141	10	283	284	
+2000	2 451 545	39	14 244	89	32 507	20	293	294	
						30	303	304	
+2100	2 488 069	40	14 609	90	32 872	Nov. 0	304	305	
+2200	2 524 593	41	14 975	91	33 237	10	314	315	
+2300	2 561 117	42	15 340	92	33 602	20	324	325	
+2400	2 597 642	43	15 705	93	33 968				
		44	16 070	94	34 333	Dec. 0	334	335	
						10	344	345	
		45	16 436	95	34 698	20	354	355	
		46	16 801	96	35 063	30	364	365	
		47	17 166	97	35 429				
		48	17 531	98	35 794				
		49	17 897	99	36 159				

TABLE II

<i>da</i>	<i>h m s</i>	<i>m s</i>	<i>s</i>	<i>da</i>	<i>h m s</i>	<i>m s</i>	<i>s</i>
0.01	0 14 24	0 8.64	0.09	0.51	12 14 24	7 20.64	4.41
0.02	0 28 48	0 17.28	0.17	0.52	12 28 48	7 29.28	4.49
0.03	0 43 12	0 25.92	0.26	0.53	12 43 12	7 37.92	4.58
0.04	0 57 36	0 34.56	0.35	0.54	12 57 36	7 46.56	4.67
0.05	1 12 0	0 43.20	0.43	0.55	13 12 0	7 55.20	4.75
0.06	1 26 24	0 51.84	0.52	0.56	13 26 24	8 3.84	4.84
0.07	1 40 48	1 0.48	0.60	0.57	13 40 48	8 12.48	4.92
0.08	1 55 12	1 9.12	0.69	0.58	13 55 12	8 21.12	5.01
0.09	2 9 36	1 17.76	0.78	0.59	14 9 36	8 29.76	5.10
0.10	2 24 0	1 26.40	0.86	0.60	14 24 0	8 38.40	5.18
0.11	2 38 24	1 35.04	0.95	0.61	14 38 24	8 47.04	5.27
0.12	2 52 48	1 43.68	1.04	0.62	14 52 48	8 55.68	5.36
0.13	3 7 12	1 52.32	1.12	0.63	15 7 12	9 4.32	5.44
0.14	3 21 36	2 0.96	1.21	0.64	15 21 36	9 12.96	5.53
0.15	3 36 0	2 9.60	1.30	0.65	15 36 0	9 21.60	5.62
0.16	3 50 24	2 18.24	1.38	0.66	15 50 24	9 30.24	5.70
0.17	4 4 48	2 26.88	1.47	0.67	16 4 48	9 38.88	5.79
0.18	4 19 12	2 35.52	1.56	0.68	16 19 12	9 47.52	5.88
0.19	4 33 36	2 44.16	1.64	0.69	16 33 36	9 56.16	5.96
0.20	4 48 0	2 52.80	1.73	0.70	16 48 0	10 4.80	6.05
0.21	5 2 24	3 1.44	1.81	0.71	17 2 24	10 13.44	6.13
0.22	5 16 48	3 10.08	1.90	0.72	17 16 48	10 22.08	6.22
0.23	5 31 12	3 18.72	1.99	0.73	17 31 12	10 30.72	6.31
0.24	5 45 36	3 27.36	2.07	0.74	17 45 36	10 39.36	6.39
0.25	6 0 0	3 36.00	2.16	0.75	18 0 0	10 48.00	6.48
0.26	6 14 24	3 44.64	2.25	0.76	18 14 24	10 56.64	6.57
0.27	6 28 48	3 53.28	2.33	0.77	18 28 48	11 5.28	6.65
0.28	6 43 12	4 1.92	2.42	0.78	18 43 12	11 13.92	6.74
0.29	6 57 36	4 10.56	2.51	0.79	18 57 36	11 22.56	6.83
0.30	7 12 0	4 19.20	2.59	0.80	19 12 0	11 31.20	6.91
0.31	7 26 24	4 27.84	2.68	0.81	19 26 24	11 39.84	7.00
0.32	7 40 48	4 36.48	2.76	0.82	19 40 48	11 48.48	7.08
0.33	7 55 12	4 45.12	2.85	0.83	19 55 12	11 57.12	7.17
0.34	8 9 36	4 53.76	2.94	0.84	20 9 36	12 5.76	7.26
0.35	8 24 0	5 2.40	3.02	0.85	20 24 0	12 14.40	7.34
0.36	8 38 24	5 11.04	3.11	0.86	20 38 24	12 23.04	7.43
0.37	8 52 48	5 19.68	3.20	0.87	20 52 48	12 31.68	7.52
0.38	9 7 12	5 28.32	3.28	0.88	21 7 12	12 40.32	7.60
0.39	9 21 36	5 36.96	3.37	0.89	21 21 36	12 48.96	7.69
0.40	9 36 0	5 45.60	3.46	0.90	21 36 0	12 57.60	7.78
0.41	9 50 24	5 54.24	3.54	0.91	21 50 24	13 6.24	7.86
0.42	10 4 48	6 2.88	3.63	0.92	22 4 48	13 14.88	7.95
0.43	10 19 12	6 11.52	3.72	0.93	22 19 12	13 23.52	8.04
0.44	10 33 36	6 20.16	3.80	0.94	22 33 36	13 32.16	8.12
0.45	10 48 0	6 28.80	3.89	0.95	22 48 0	13 40.80	8.21
0.46	11 2 24	6 37.44	3.97	0.96	23 2 24	13 49.44	8.29
0.47	11 16 48	6 46.08	4.06	0.97	23 16 48	13 58.08	8.38
0.48	11 31 12	6 54.72	4.15	0.98	23 31 12	14 6.72	8.47
0.49	11 45 36	7 3.36	4.23	0.99	23 45 36	14 15.36	8.55
0.50	12 0 0	7 12.00	4.32	1.00	24 0 0	14 24.00	8.64

## EXPLANATION OF TABLES

Table I is for the purpose of converting a calendar date into Julian Days or *vice versa*. It is divided into three parts, which are to be used as follows: *Ia*, for the beginning of the century; *Ib*, for the year in the century, and *Ic*, for the day of the month. Table *Ia* contains the day of the Julian period corresponding to the first day in each century counted according to the Julian calendar through 1500, but according to the Gregorian calendar for the succeeding centuries. Table *Ib* contains the number of days in each year of the century counted from its beginning. If the zero year of the century is a leap year, -1 should be used. Table *Ic* gives the day in the year corresponding to the day of the month. It contains three columns; the first gives the tenth day of each month; the second, the corresponding day of the year to be used for the common year; and the third, the day to be used for a leap year. The use of the table can best be explained by an example.

Find the Julian Day corresponding to the calendar date March 26, 1915. Entering the column *Ia* with the argument 1900, the corresponding number will be 2 415 020. From Table *Ib* find the number corresponding to 15, which is 5478. Since 1915 is not a leap year, the day of the year for March 26 should be taken from the second column of *Ic*. It is 85. The sum of these three numbers will be the Julian Day corresponding to the given calendar date. The computation may be arranged as follows:—

<i>March 26, 1915</i>	
Table <i>Ia</i> , 1900.....	2 415 020
Table <i>Ib</i> , 15.....	5 478
Table <i>Ic</i> , March 26.....	85
	2 420 583

The reverse process is frequently necessary in the prediction of the time of maximum or minimum of the variable star, as illustrated in Chapter XI. The computation may be made as follows. Given Julian Day 2 405 693; change to the corresponding calendar date. From Table *Ia* the century is found to be 1800, or Julian Day 2 378 496. Subtract this value from the Julian Day given and the result, 27 197, is the number of days since the beginning of the century. From Table *Ib* this is found to be 74 years, for which the number of days is 27 028. Subtracting this number from the remainder just given, the

result, 169, indicates the number of the day in the year. Since 1874 was not a leap year this number should be taken from column two of Ic. This corresponds to June 18. The resulting date is, then, June 18, 1874.

Julian Day . . . . .	2 405 693
Table Ia, 1800 . . . . .	2 378 496
Remainder . . . . .	27 197
Table Ib, 74 . . . . .	27 028
Table Ic, June 18 . . . . .	169

The observer who is working continuously with the observation of variable stars will often find it convenient to arrange a small table which contains the zero day of each month for the years covered by his observations.

Table II is for the purpose of changing from hours, minutes, and seconds to the fraction of a day or *vice versa*. The argument of this table is made to serve for all three columns of tabular values. As printed, it gives the first two decimal places of the fraction of a day. The tabular values for this are given in hours, minutes, and seconds in the second column; *e.g.*,  $0^{\text{da}}.05$  is equivalent to  $1^{\text{h}} 12^{\text{m}} 0^{\text{s}}$ . The third column contains the minutes and seconds for .01 of the argument; *e.g.*,  $^{\text{da}}.00 05$  is  $0^{\text{m}} 43^{\text{s}}.20$ . The numbers in the fourth column give the seconds corresponding to .00 01 of the argument; *e.g.*,  $^{\text{da}}.00 00 05$  is equivalent to  $0^{\text{s}}.43$ .

For example, change  $^{\text{da}}.213 675$  into hours, minutes, and seconds. With the argument .21 take the value from the second column. With the argument .00 36 take the value from the third column. With the argument .00 00 75 take the value from the fourth column. The sum will be the hours, minutes, and seconds corresponding to the given fraction of a day.

$0^{\text{da}}.21$	$5^{\text{h}} 2^{\text{m}} 24^{\text{s}}$
.00 36	5 11 .04
.00 00 75	6 .48
<hr/>	<hr/>
0.21 36 75	5 7 41.52

The reverse process is illustrated by the following example. Change  $16^{\text{h}} 23^{\text{m}} 29^{\text{s}}.66$  into the fraction of a day. From column two we find the first two figures of the result to be  $0^{\text{da}}.68$ , which corresponds to  $16^{\text{h}} 19^{\text{m}} 12^{\text{s}}$ ; leaving a remainder of  $4^{\text{m}} 17^{\text{s}}.66$ . From column three this is found to correspond to  $^{\text{da}}.00 29$ , with a remainder of  $7^{\text{s}}.10$ . From column four this is found to correspond to  $^{\text{da}}.00 00 82$ , which is equal to  $7^{\text{s}}.08$ . The given time is equivalent, then, to .682 982 days.

0 <sup>da</sup> .68	16 <sup>h</sup> 23 <sup>m</sup> 29 <sup>s</sup> .66	
	16 19 12	
		4 17.66
.00 29		4 10.56
		7.10
.00 00 82		7.08
0.68 29 82		

## DESCRIPTION OF STELLAR SPECTRA

The following three plates are intended to illustrate the classification of stellar spectra, which was explained in Chapter I of this book, being abbreviated from the original in H.C.O., *Annals*, vol. 28, from which Plates XIII and XIV are also taken. In describing them, an attempt will be made to indicate the groups of lines on which the classification is based.

The first plate, No. XII, which is taken from Huggins's *Stellar Spectra*, represents the solar spectrum, which is of Class G, and four stars of Class A. The photograph covers a region from wave-length 4050 to wave-length 3625, with the red at the right. As the K line at  $\lambda$  3933 is at the limit of visibility, the greater part of the spectrum as here depicted is in the ultra-violet. This plate is particularly valuable because it shows the hydrogen series of lines (1), of Chapter I, page 32. The lines are known by the letters of the Greek alphabet, the first one on the right being H $\epsilon$ , and can be followed by their positions as far as H $\pi$ . These hydrogen lines are always recognized in the earlier classes of spectra by their rhythmic order. They are very apparent in types A and F of Plate XIII, and can easily be followed into B, G, and K. On Plate XIV they can be recognized in  $\alpha$  Cygni,  $\zeta$  Puppis, and  $\circ$  Ceti. In the last star they are bright instead of dark.

The second group (2) consists of another series of hydrogen lines, which may be seen in the spectrum of  $\zeta$  Puppis, Plate XIV, where they are intermediate between the hydrogen lines, a little to the left of the middle of each space. This set of lines is characteristic of the early stars.

The Orion lines (3), which comprise the lines of helium and other substances, not including hydrogen, are seen in the spectrum of  $\epsilon$  Orionis. It should be stated that the spectra on Plates XIII and XIV include the lines between the wave-lengths 3800 and 5000; hence they

are almost entirely in the visible part of the spectrum. The hydrogen lines in the spectrum of  $\alpha$  Can. Maj. or Sirius are thus  $H\beta$ ,  $H\gamma$ ,  $H\delta$ , and  $H\epsilon$ . Nearly all the lines in  $\epsilon$  Orionis, with the exception of the hydrogen lines, are classed as characteristic Orion lines. Of the three most intense lines lying between  $H\beta$  and  $H\gamma$  the first and last are due to helium. The group of lines near  $H\delta$  includes an oxygen triplet to the left, and two helium lines to the right. The strongest line, which is nearly midway between  $H\epsilon$  and  $H\delta$ , belongs to helium.

The calcium lines H and K (4), which are very strong in the solar spectrum, appear toward the right of Plate XII, where they have a great intensity, and also on Plate XIII, in the spectrum of  $\alpha$  Carinae,  $\alpha$  Aurigae, and  $\alpha$  Boötis. H coincides very closely with  $H\epsilon$ ,  $H\epsilon$  having the shorter wave-length of the two. The dispersion is not sufficient in any of the accompanying photographs to show the separation between the two lines. The K line appears a little to the right of the center of the space between  $H\epsilon$  and  $H\zeta$ . It shows as a rather faint line in the three lower spectra of Plate XII, where it is not as intense as the hydrogen lines.

The solar lines (5) can be seen readily in the spectra of  $\alpha$  Aurigae and  $\alpha$  Boötis, on Plate XIII, and in the ultra-violet portion of the spectrum of the sun, shown in Plate XII. It would be impossible to select any particularly characteristic lines in this set, but they may perhaps be described as being of rather small intensity and quite closely crowded together. The distinction between the arrangement of lines in Class B and Class G, as shown on Plate XIII, is very apparent. In the latter star, the H and K lines, and the thickness with which the solar lines are packed in the spectrum, distinguish it at once from Class B, where the stronger lines are isolated, and the finer lines are scattered, appearing in groups of not more than two or three lines together. Group G (6) appears first in the spectrum of  $\alpha$  Aurigae, just a little to the left of  $H\gamma$ . It is easily recognized because it consists of two rather strong lines in the midst of a large number of fine lines. This group is one of the distinguishing features of Class G.

The bright bands (7) are seen in the spectrum of  $\gamma$  Velorum, Plate XIV.

It is important to note how the different sets of lines just described change in intensity in passing from one spectral type to another, and this may be traced, to a certain extent, on Plate XIII, though there are not enough examples of spectra given there to show it in detail. The broad hazy bright bands appear first, and are accompanied by bright hydrogen lines of both series. The star  $\gamma$  Velorum has the bright bands, but the hydrogen lines are dark. For this reason it is marked Oa Pec., for if it were a typical star of this class, the lines



would be bright instead of dark. The hydrogen lines become narrower and finally give place to dark hydrogen lines of both series, as illustrated in the spectrum of  $\zeta$  Puppis. The series (1) increases in intensity through Class B, reaching its maximum in Class A, as illustrated by the spectrum of Sirius. They then diminish through Class F and G into K, in which they are no more conspicuous than many other solar lines. The second series of hydrogen lines reaches its maximum intensity in O $\delta$ , and then quickly disappears. They can also be seen faintly in the spectrum of  $\gamma$  Velorum.

The Orion lines appear as the bright bands (7) disappear, increase in intensity, reaching a maximum in B 2 and B 3, then diminish, and in A are barely visible.  $\epsilon$  Orionis belongs to Class B, in which the Orion lines have not yet reached their greatest intensity. The calcium line, K, appears in Class A, as pointed out in the spectrum of Sirius, and increases in intensity until, with H, it dominates the spectrum. The other solar, or metallic, lines, appear faintly in type A, become more and more strengthened, particularly the G band, and finally the entire spectrum becomes banded. Attention should be called to the spectrum of  $\circ$  Ceti, the well-known long period variable, because its spectrum is of the banded type, having bright hydrogen lines at maximum. It is interesting to note that these bright lines have not all the same intensity. Those seen in the illustration are H $\beta$ , H $\gamma$ , H $\delta$ , H $\zeta$ , and H $\eta$ . H $\epsilon$  is absent. The explanation given is that it is hidden by an over-lying calcium line, H. If the reader is interested in studying the spectra of the stars further, ample explanation for identifying the lines will be found in volume 28, referred to above.



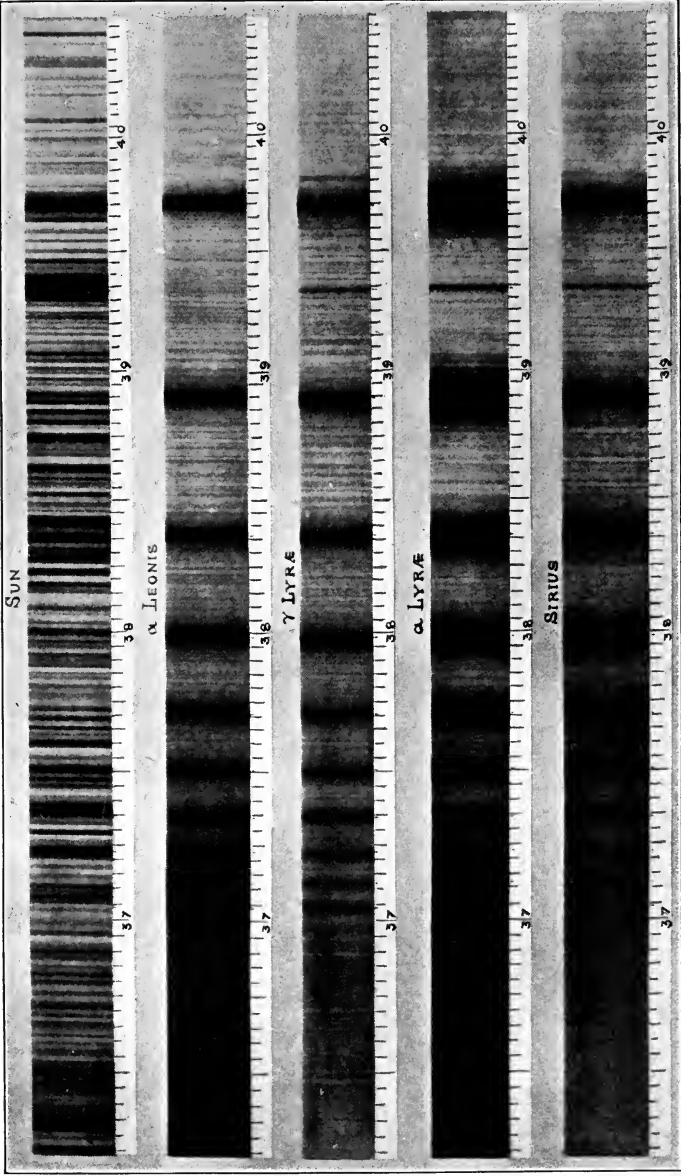
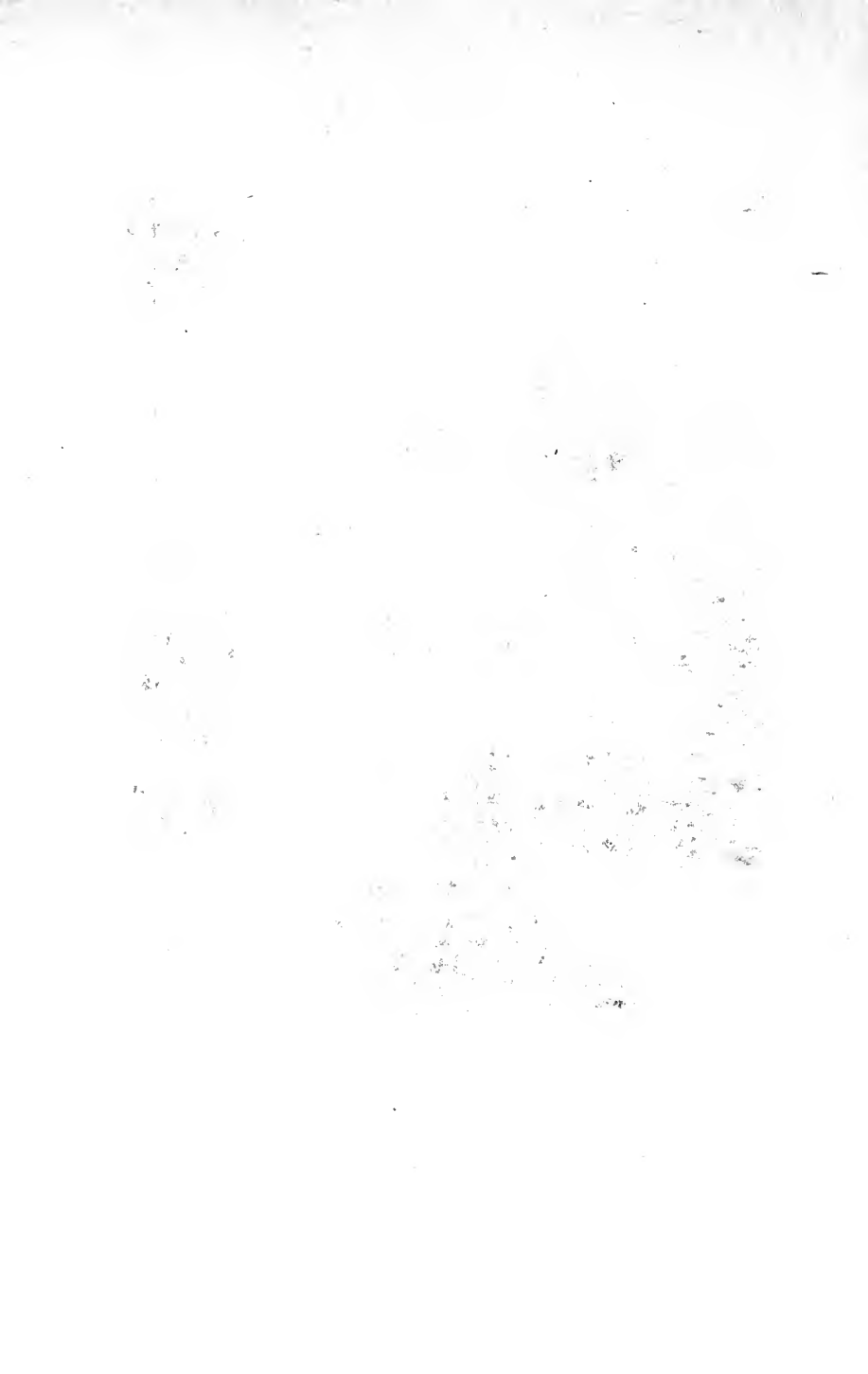

Plate XII  
SPECTRA OF SUN AND TYPE A



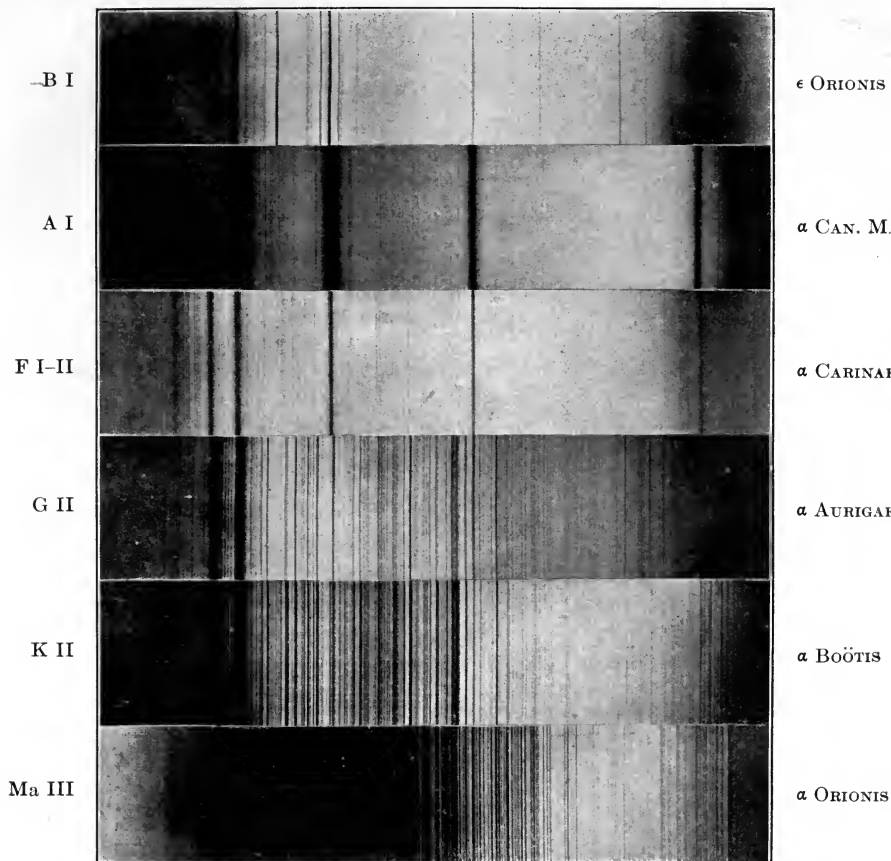

Plate XIII  
TYPICAL SPECTRA



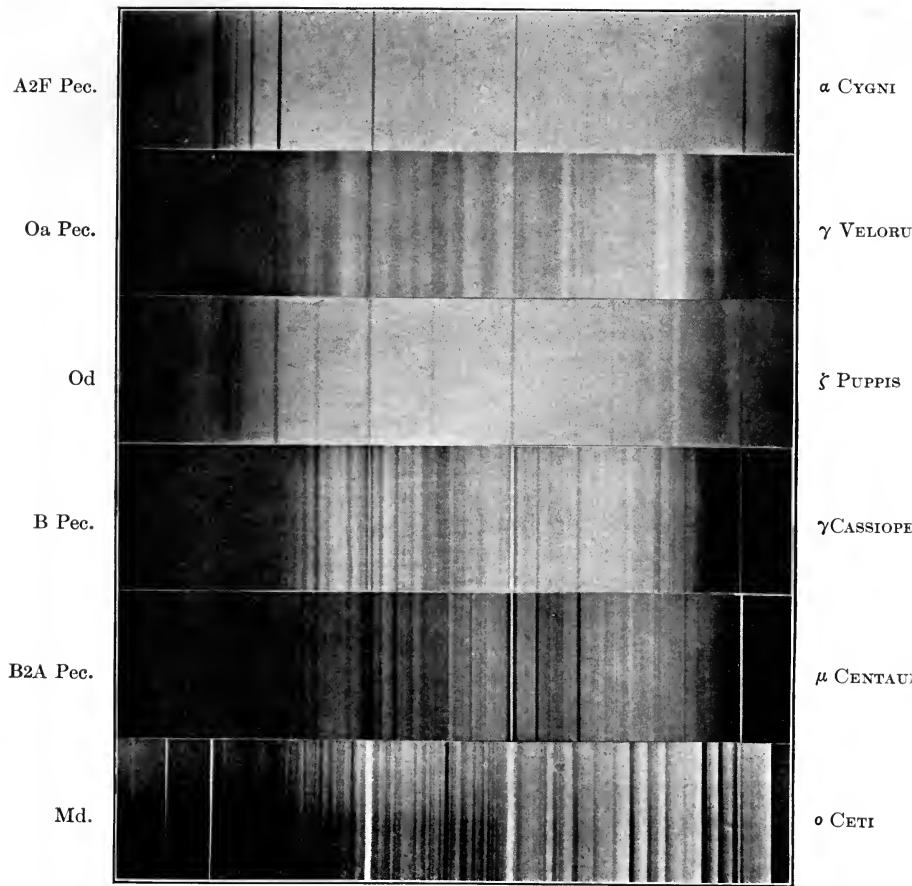

Plate XIV  
PECULIAR SPECTRA





## INDEX



## INDEX

- Algol, type, 6, 13, 17, 241; description of type, 14; light curve, 15; spectrum of type, 36; on Hagen Charts Series IV, 58; Ephemeris in Hartwig, 72; discovery of variable by Goodricke, 75, 269; method of observing with selenium photometer, 156, 157; discovery of secondary minimum, 157; use of mean light curve to correct for asymmetry, 199, 200; explanation of variability of type, 228-236; Goodricke's hypothesis, 228, 229; dimensions of system, 229, 230; Stebbins, 230; displacement of lines in spectrum, 233; normal position of lines at minimum, 235; connection between orbital motion and displacement of lines, 236; partial eclipse shown by short minimum, 239.
- Allen, photo-electricity, 158-159.  
*Almagest*, 81-82.
- Al Sūfi, magnitudes, 82-83.
- American Association of Variable Star Observers, 296-297, 305.
- Anderson, discovery of new stars, 6, 75.
- André, 306; method of naming variables, 69-70.
- Ångström unit, 21.
- Ant-Algol stars, 13, 72.
- S Arae, 13, 14.
- Argelander, *Uranometria Nova*, 38, 39, 88, 89, 92, 126; *Bonner Durchmusterung*, 40, 41; second edition, 41; director of Observatory at Åbo, 42; detailed account of *Durchmusterung*, 42, 43, 44; limiting magnitude, 45; arrangement of stars, 45; description of catalogue, 45; description of charts, 46, 47, 48; continuation of *Durchmusterung* to  $-23^\circ$  by Schönfeld, 49; use of precession, 51; method of determining positions of stars, 57; method of naming variables, 68; variables discovered in making catalogue, 76; Bayer's method of assigning letters, 83; William Herschel's method of determining magnitude, 86; Argelander step method, 86, 170, 256, 269, 289, 290, 292, 294; *DM*. magnitudes, 87-88, 89-91; cases of variability in *Durchmusterung*, 91; scale of *Uranometria Nova*, 93; description of step method, 103-106; modifications of step method, 107-108; *DM*. magnitudes used as standards, 121-122; color scale, 130; effect on color of increased aperture, 131; step method adapted by Chandler to color scale, 132; step method adapted to photographic magnitudes, 153; notation of magnitudes, 163; sketch of life, 257-260; succeeded by Schönfeld, 260; friendship with Heis, 262; friendship with Krueger, 264.
- SS Aurigae, 10.
- Averted vision, use in observing faint stars, 104.
- Bailey, discovery of variables in cluster  $\omega$  Centauri, 80.
- Baly, *Spectroscopy*, 306.
- Barnard, observations of temporary stars, 8-9; color of Nova Lacertae, 134-135; Bruce photographic telescope, 144.
- Baxendell, observations of U Geminorum, 250-251; sketch of life, 266-267.
- Bayer, position of Mira Ceti, 74; *Uranometria*, 83-85, 89.
- Becker, suspected variables, 77.
- Beljawsky, statistical study of color and period, 275-278; period and range, 278.
- Bell, color of double stars, 135-137.
- Bemporad, use of extinction photometer, 129.
- Bessel, effort to construct star charts, 41-42.
- Bibliography, brief, 306-307.
- Blink Stern*, substitution for "Cepheid," 12, 13.
- Blue stars, 134.
- Bond, study of photographic image, 137-138.
- British Association of Variable Star Observers, 266, 298.
- Brooks, editor of Pogson's observations, 265; director of British Association of Variable Star Observers, 266, 298.
- Campbell, components of spectroscopic binary, 226; elements of orbit, 227, 306.
- Campbell, Leon; discussion of SS Cygni, 251; observer at Harvard, 235.

- Cannon, classification of stellar spectra, 31-34, 37; Argelander's Appeal to Friends of Astronomy, 258.
- ♄ Carinae, peculiarities of spectrum, 252-253.
- Carte du Ciel*, charts, 51.
- Catalogues of variables, Harvard provisional, 5, 73; Harvard, 51, 70, 77; Hartwig's, 70-72; Chandler's, 73.
- ♁ Cephei, light curve typical of Class IV, 11; spectrum of type, 36; formation of light scale by Schönfeld, 170; explanation of type, 227; spectroscopic binary, 244; Shapley's theory, 246, 247; discovery of variability by Goodricke, 269.
- U Cephei, light curve, 16; discovery of variability, 76, 77; correction for asymmetry of light curve, 200, 201; long minimum, 239.
- Cepheid variables, typical star, 11; *Blink Stern*, 12, 13; spectrum, 36; theories in explanation of type, 227; spectroscopic binaries, 244; Shapley's theory, 246; cluster type identical with Cepheid, 246; variables with periods less than day, 247.
- Ceraski, Prof. and Mme., discovery of variability of U Cephei, 76-77.
- Chandler, material in Hagen Charts, 53, 54, 57, 58, 62, 63; method of numbering variables, 69; catalogues, 73; color scale, 130; method of forming scale, 131-132; correction for asymmetry of light curve, 201; elements in Hartwig, 212; M-m, 212; obituary of Gould, 270, 271; sketch of life, 272; colors of stars based on Chandler's scale, 275.
- Charlier, formation of photographic star image, 140; method of determining stellar magnitudes from measurement of photographic images, 145-147.
- Classification of variable stars, Pickering's, 5-17.
- Clerke, temporary stars, 6, 253, 306; Cepheids system, 245; ♄ Carinae, 252; Goodricke, 269.
- Cluster type of variable, 14; distinguished from Cepheid variable, 246-247.
- Color, star; relation to spectrum, 134-135, 148-151; Nova Lacertae, Barnard, 134-135; of double stars, 135-137; effect on photographic image, 137, 145, 148-151; of variables, 287-288.
- Color curve, 141-142.
- Color intensity, 149; and spectral type, Parkhurst and Jordan, 149-150; King, 151.
- Color scale, *Potsdam Photometric Durchmusterung*, 121, 130; Schmidt's, 130-131; effect of instrument on, 131; Chandler's, 131-132; Osthoff's, 132-133.
- Color screen, 142.
- Comparison spectrum, 218, 221.
- Cordoba Durchmusterung*, 49-50, 57.
- Cornu, see Hartmann-Cornu.
- R Coronae Borealis, 252, 270.
- Correcting lens, 141-142, 221-222.
- Curtiss, study of  $\beta$  Lyrae, 243-244; theory of Cepheid type, 245-246.
- SS Cygni, class, 6; Parkhurst's light curve, 10; discussion of light curve by Leon Campbell, 251; diagram from *Popular Astronomy*, 251-252.
- Discovery of variable stars, 6; announcement, 68; methods, 73-80; visual, 73-78; photographic, 78-79, 80; from spectrum, 79-80; miscellaneous, 265, 286; earliest made, 286-287.
- Doppler-Fizeau principle, 28; explanation, 217-218.
- Double-slide plate-carrier, for photography, 139.
- Double stars, colors of, 135-137.
- Dove's phenomenon, 108, 109.
- Duncan, explanation of Cepheid variables, 246.
- Durchmusterung*, charts for telescopic work, 38, 39; division, 40; detailed account, 41, 42; method of Argelander, 43, 44; present use of original records, 44; limiting magnitude, 45; arrangement of stars in catalogue, 45; description of chart, 46-47; second edition, 48; continuation of *Durchmusterung* to  $-23^\circ$  by Schönfeld, 49; connection with Hagen charts, 54, 57, 58; scale of magnitude, 56; enlargements of charts, 65-66; connection with Harvard catalogue, 70; connection with *Ephemeris*, 71; magnitudes, 89-91; connection with *Potsdam Durchmusterung*, 121, 122; with *Harvard Photometry*, 126.
- Dürer, Albrecht, drawings for Bayer's *Uranometria*, 84.
- Eclipsing binary, general relations, 230; light curve, 230; relative orbit, 230-231; real orbits, 232; spectroscopic evidence, 233; velocity curve, 233, 234; conclusions, 235-236; possible combinations in system, 236-239.
- Elements of variation, 4-5.
- Elster and Geitel, studies in photo-electricity, 158-159, 163.
- Enebo, discovery of Nova Geminorum no. 2, 254; elements of SW Geminorum, 275.

- Espin, discovery of variable, 76.  
Extra-focal images, 151-152.
- Fabricius, first observation of Mira Ceti, 74.
- Fechner, psycho-physical law, and connection with stellar magnitude, 98, 99.
- Fizeau, *see* Doppler-Fizeau.
- Fleming, discovery of long period variable, 79; discovery of new star, 79-80; discovery of variable in cluster Messier 5, 80; list of stars of fifth type, 134; subdivisions of spectra, Class M, 273-279.
- Fowler, spectrum of hydrogen and helium, 37.
- Franks, spectral type and color, 282.
- Fraunhofer, stellar spectra, 30.
- Frost, loss of light in spectograph, 223.
- Galactic distribution of variables, 282-284.
- ζ Geminorum, 14.
- U Geminorum, Class I Ib, 6, 250; description of variation, 10, 250; observations edited by Turner, 266, 267, 268.
- Gill, 78, 252.
- Goetz, drawings for Hagen charts, 62.
- Goodricke, discovery of variability of β Lyrae, 75; explanation of variability of Algol, 228-229; sketch of life, 269.
- Gould, *Uranometria Argentina*, 62, 63, 91-93, 126, 306; sketch of life, 270-272.
- Grover, observer at Sir Cuthbert Peek's observatory, 268.
- Guiding telescope, 138-139.
- Guthnick and Prager, photo-electric photometer, 154, 159-167.
- Hagen, star charts for variables, 52-53; designation in light scale, 172; light scale for Heis's comparison stars, 179; editor of Heis's observations, 186, 262; reproduction of Pogson's charts, 266; bibliography, 306; statement regarding colorimetry, 134.
- Hagen charts, description of Series I-III, 52-58; description of Series IV, 58-61; magnitudes of Series IV, 59-61; description of Series V, 61-64; charts by Goetz, 62; description of Series VI, 64, 65; general index, 65; index to Parkhurst photographs, 67; use, 170, 293, 304, 307.
- Halma, M. l'Abbé, edition of *Almagest*, 81.
- Harding, discovery of several long period variables, 265.
- Hartmann, sensitiveness of photographic plate, 138; -Cornu formula, 224.
- Hartwig, adoption of name *Blink Stern* for Cepheid variables, 12, 71; classification of δ Cephei and S Arae, 13; stars of ζ Geminorum type, 14; minima of Algol type, 62; yearly Ephemerides, 62, 68, 70-72, 204, 208, 212, 215, 273, 283, 286; period of δ Cephei, 192; elements of Algol, 212; formula for reduction to sun, 213; stars in β Lyrae class, 241; period of S Ursae Majoris, 248; elements of SW Geminorum, 275.
- Harvard College Observatory, contents of *Annals* pertaining to variable stars, 306-308.
- Harvard photographs, used to trace history of new star, 6, 8; maps for variable star observers, 65, 66; connection between spectral type, color, and magnitude, 136; variation of size of image, 137, 138; relation between spectral type and color intensity, King, 151-152; magnitude determined by photographic images, 152, 153.
- Harvard Photometry*, magnitude in Schurig's *Atlas*, 40; magnitudes in Hagen, Series IV, 59; magnitudes in Hagen, Series V, 63; magnitudes in Hagen, Series VI, 64; magnitudes obtained for 757 stars, 82; publication of first volume, 126; *Revised Harvard Photometry*, 173.
- Heis, *Atlas Coelestis*, 38, 39, 62, 126; adopted *Uranometria Nova* as model, 89; order in light scale, 172; use of observations, 179, 186; collected observations, 256; friendship with Argelander, 258; sketch of life, 262-263.
- u Herculis, 10, 11, 36.
- Herschel, John, numerical relation between magnitude and relative brightness, 94-95, 97.
- Herschel, William, method of comparing stellar brightness, 85-87; fractional magnitudes, 88; importance of magnitude, 94, 167; comparison of method with Argelander's, 103; fluctuating stars, 105, 219.
- Hertz, effect of light on electric discharge, 158.
- Hind, discovery of U Geminorum, 250; interest in variable stars, 267.
- Hipparchus, globe of, 81-82; star catalogue, 94, 167.
- Hisgen, drawings for Hagen charts, 58; grades for Hagen charts, 59.
- Holwarda, discovery of variability of Mira Ceti, 74-75.
- Huggins, early work in spectroscopy, 218-219.
- RV Hydrae, magnitude curve for, 61.

- Irregular variables, color, range, 252-253, 284-285; spectral type, 285.
- Johnson, determination of magnitude ratio,  $\rho$ , 96, 98.
- Jordan, *see* Parkhurst and Jordan.
- Julian Day, 5, 70; explanation of, 204-206; table for converting into calendar date, 311, 313.
- Kempf, *see* Müller and Kempf.
- King, color intensity and spectral type, 150.
- Kirchhoff's law, 23.
- Klein, star atlas, 38.
- Knott, observations of U Geminorum, 250-251; collected observations, 257, 265; sketch of life, 266, 267-268.
- Krueger, assistant to Argelander, 48; catalogue of colored stars, 63, 64; *DM* magnitudes, 90; collected observations, 256, 263; sketch of life, 264.
- Küstner, present use of *Durchmusterung* records at Bonn, 44, 48, 76, 77.
- Lalande, *Histoire Celeste*, 41; magnitudes in, 88.
- Least Squares, statement of principle, 191-192.
- Light curve, single, 3-4; method of plotting, 174; determination of period, 174-176; of maximum, 176.
- Light curve, mean, 5; plotting of observations, 186-188; approximate elements, 188; correction of approximate elements, 188-190, 192-193; determination of phase, 193-194; arrangements of observations according to phase, 194; grouping of observations, 194-196; mean light curve, 196-197; recapitulation, 198-199; use of curve for Algol type, Yendell's method, 199-201; Chandler's, 201-202; Harvard modification of method for long period variables, 202-203.
- Light scale, formation of, 170-173; change from light step into magnitude by formula, 173-174; by curve, 177-179; Parkhurst's method with weights, 180-185.
- Light wave, 19; length, 19-20; connection with color, 20-21.
- List of variables for beginners, 305-306.
- Lockyer, enhanced lines, 26.
- Long period variables, irregularities in range and period, 248-249; type of spectrum, 248, 249-250; color, 250; subdivisions in Class II, 250-252.
- Lynn, sketch of Goodricke's life, 269.
- $\beta$  Lyrae, typical star of Class IVb, 6, 13; light curve, 13; Algol type, 17, 241; spectrum of type, 36; Ephemeris, Hartwig, Table IV, 72; discovery by Goodricke, 75, 269; account of spectrum, 242-244; observations by Heis, 262; flattening of disc, 286.
- Magnitude curve, Hagen grades and Harvard magnitudes, 61.
- Measurement of displacement of spectral lines, 223-225.
- Meridian photometer, description, 122-124; method of reduction, 124-125.
- Meyer and Rosenberg, photo-electric photometer, 154.
- Mira Ceti, discovery, 74-75; light curve and maximum, 176-179; irregularities in period and magnitude, 248-249; spectrum, 249-250.
- Moore, spectrum of  $\eta$  Carinae, 252-253.
- Mt. Wilson Solar Observatory, Laboratory of, 28.
- Müller, Committee of *Astronomische Gesellschaft*, 65.
- Müller and Kempf, *Potsdam Photometric Durchmusterung*, 120-122; magnitudes of Pleiades, 299.
- Nova Aurigae, discovery by Anderson, 6; account of discovery, 6, 8.
- Nova Geminorum no. 2, change in spectrum, 35, 254.
- Nova Lacertae, Barnard, color of, 134-135.
- Nova Persei, discovery by Anderson, 6, 75; light curve, 6, 253; history, 8; change of spectrum, 35, 254; theories, 253, 254.
- Observation of variables, precautions, 104-105, 108-110, 290-291, 303-305; distribution of, 292-293; methods, 294.
- Observations, collected, Argelander, 257-260; Schönfeld, 260-262; Heis, 262-264; Schmidt, 264-265; Pogson, 265-266; Baxendell, 266-267; Knott, 267-268; Peek, 268-269.
- Observatories co-operating in radial velocity work, 225.
- Olcott, secretary American Association of Variable Star Observers, 297, 298, 302, 305.
- $\alpha$  Orionis, 10.
- Osthoff, color scale, 63, 132-133, 275, 282; color of faint stars, 133, 277; color of doubles, 135.
- Palisa and Wolf, photographic charts, 50.
- Paris Ecliptic Charts*, 38, 50-51, 53.
- Parkhurst, light curve of SS Cygni, 10; photographs of Hagen fields, 66-67; maps

- in *Researches in Stellar Photometry*, 67; researches with photographic wedge photometer, 128; formula for photographic magnitude, 147; order in light scale, 172; formation of light scale with weights, 180-185; minimum of V Delphini, 275; magnitudes of very faint stars, 299; precautions, 303-304.
- Parkhurst and Jordan, visual magnitudes obtained photographically, 143-149; relation between color intensity and spectral type, 149-150; method of extra focal images, 152.
- Peek, observatory at Lyme Regis, 265, 263-269.
- Pearce, study of Ptolemy's magnitudes, 82; *DM*. magnitudes, 88, 89-91.
- Perrine, *Cordoba Durchmusterung*, 49-50; investigation of photographic images, 140.
- Peters, star charts, 51, 53.
- Phase, in light curve, definition, 193.
- Photo-electricity, principles of, 158-159; applied to photometry, 159-167.
- Photographic image, affected by star color, 137, 144-145, 148-151; appearance and formation of image, 138-145; theory of Charlier, 140; experiments of Perrine, 140; appearance due to kind of telescope, 140-141; effect of chromatic aberration, 141-142; use of color screen, 142; use of stained plates, 142, 148-151; effect of focal length of telescope, 142-144; effect of spectral type, 145.
- Photographic magnitude, method of determining, Charlier, 145-147; Parkhurst, 147; method of extra focal images, 151-152; Harvard method, 152-153.
- Photographic telescope, Bruce, 144.
- Photographic wedge, method of preparing, 151.
- Photography, importance in spectroscopic work, 219.
- Photometer, Zöllner, description, 116-120; — use in preparing *Potsdam Photometric Durchmusterung*, 120, 122; meridian, 122-126; photographic wedge, 126-129; extinction, 129; selenium, 154-158; photo-electric, 154, 158-167.
- Photometry, development of, 167-169.
- Pickering, classification of variables, 5; subdivisions of Class IV, 11; Pickering's Type V, 30; secondary hydrogen series, 31, 37; Harvard photometric magnitude adopted by Hagen, 60, 61, 64; elements used by Hagen, 65; photographic maps for amateur observers, 66; variation of TY Aquilae confirmed by, 77; discovery of SV Hercules, 77-78; study of Orion region with photographic plates, 78; discovery of long period variables with bright H lines, 79; discovery of variable in Omega Centauri, 80; comparison of Ptolemy's and Harvard magnitudes, 82; publication of Herschel's manuscript, 87; discussion of Herschel's magnitudes, 87; method of comparing variables, 106-107; method of direct estimation of magnitudes, 107; meridian photometer, 122-126; variation of Polaris, 125; photographic wedge photometer, 126-129; résumé of methods in photographic photometry, 153; explanation of variability of Algol, 229; spectrum of  $\beta$  Lyrae, 243; subdivisions, in Class II, 250; Class IIc, 252; publication of Argelander's observations, 260; publication of Schönfeld's observations, 262; publication of Schmidt's observations, 264; circulars concerning variable star observations, 289-296, 303; Section of Variable Star Observers, 297-298.
- Piggott, sketch of work, 269, 270; friendship with Goodricke, 269.
- Pogson, rule for expressing relation between magnitude and relative brightness, 94, 95, 96, 97; connection with Fechner's law, 99; examples of rule, 100-102; application in observation, 106; application of rule to Algol, 229; collected observations, 257, 266; sketch of life, 265-266.
- Polaris, variation in brightness, 125.
- Polarized light, application to photometry, 114-116.
- Potsdam Photometric Durchmusterung*, description, 120-122; color scale, 121, 130; 40, 57, 61, 63.
- Prager, *see* Guthnick and Prager.
- Precession, for *Durchmusterung* catalogue, 51.
- Prediction of maximum and minimum of variable stars, 206-207; method of finding E, 207-208; examples of method for long period variables, 208-211; for Algol, 212-213.
- Ptolemy, description of catalogue, 81-83; fractional magnitudes, 82, 88, 167, 168; magnitudes adopted by later astronomers, 82-83; value of division into magnitudes, 82; division into magnitudes, 94, 97, 99.
- Purkinje phenomenon, 108-109, 131, 137.
- Radial velocity, definition, 217; measurement of, 223-224; observatories engaged in measuring, 225.

- Red stars, precautions in observing, 104-105, 108.
- Reduction to sun, 213-215.
- Refraction, description of principle, 110-111; double refraction, 111-114; application to photometry, 114-116.
- Roberts, magnitudes for southern variables, 63.
- Rosenberg, *see* Meyer and Rosenberg.
- Rowland's tables of solar wave-lengths, 224-225.
- Russell, effect of duration of minimum on Algol system, 239.
- Russell and Shapley, hypothesis of darkened limb in Algol variables, 240.
- Rutherford, early work in spectroscopy, 219.
- Scheiner, 306; early work in spectroscopy, 219.
- Schmidt, color scale, 63, 64, 130-131, 132, 133; connection between color and period of variables, 132; color of doubles, 135; collected observations, 257; sketch of life, 264-265.
- Schönfeld, assistant to Argelander, 48; southern *Durchmusterung*, 49; catalogue of variables, 57, 73; magnitudes in *DM.*, 88, 89-91; collection of observations, 170, 256; order in light step, 172; estimate of Argelander, 259; sketch of life, 260-262.
- Schultz, photo-electric photometer, 154, 158.
- Schurig, star atlas, 38, 39-40.
- Secchi, classification of stellar spectra, 30; early spectroscopic work, 219.
- Seeliger, galactic distribution of stars, 283-284.
- Selenium cell, 153, 154; physical principle, 154-155; description, 155-158; value for short period variables, 157, 168, 229.
- Shapley, relative luminosity of components of eclipsing binary, 240; spectral types of eclipsing binaries, 241; "A Study of the Orbits of Eclipsing Binaries," 241; theory of Cepheid variables, 246; distinction between Cepheid and cluster variables, 246-247; statistics of eclipsing binaries, 286. *See also* Russell and Shapley.
- Solar spectrum, description, 23-29.
- Spectral type and color intensity, 149-151; effect on photographic image, 145.
- Spectral type of variable star and type of variation, 35-36; temporary stars, 35; long period variables, 35; irregular variables, 36; short period variables, 36; Algol variables, 36.
- Spectrogram, definition, 219; measurement of, 223-225.
- Spectrograph, Bruce, description of, 219-223; testing, 224-225.
- Spectroscope, 18-19.
- Spectroscopic binary, definition, 225-226; connection with variable stars, 227-228.
- Spectroscopy, early workers in, 219.
- Spectrum, formation of, 17-18; invisible, 21; continuous, 22; emission, 22; absorption, 23; of hydrogen, 23; effect of change in temperature and pressure, 23, 25-26; investigations in, 24-28; banded, 25-26; lined, 26; enhanced lines, 26; effect of pressure of magnetic field, 26-27; reversal of lines in, 27; methods of producing, 27-28; recent investigations of hydrogen and helium, 37.
- Spectrum analysis, laws of, 22-23; applications, 23-24.
- Stained plates, use of, in stellar photography, 142, 148-150.
- Statistical study of variable stars, long period variables, distribution and period, 273-275; color and period, 275-278; period and range, 278-279; short period variables, period and range, 280; spectral types, 281; spectral type and color, 282; galactic distribution, 282-284; irregular variables, range, color, spectral type, 284-285; eclipsing binaries, 286; number discovered by a single observer, 286; early discoveries, 286-287; conclusions 287-288.
- Stebbins, selenium cell, 153, 154, 155-158; secondary minimum of Algol, 157; elements of Algol's orbit, 230; surface intensity, 238.
- Steinheil, determination of magnitude ratio,  $\rho$ , 96.
- Steinheil binoculars, for observing brighter variables, 64.
- Stellar spectra, classification, Secchi, 30; Fraunhofer, 30; Harvard, 31-34; development of types, 34; description of plates, 315-317.
- Struve, color of double stars, 136.
- Sutton, study of Cepheid-Geminiid group of variables, 244.
- Telescope, guiding, 138-139; penetrating power, 299; setting with circles, 300-301; identification of field, 301-303.
- Temporary stars, description, 6-9; spectrum, 35; light variation, 253; history, 253-255.
- Tenth meter, 21.
- Turner, 306; interest in observations of



- Pogson, 266; editor of observations of Baxendell, 267; of Knott, 267.
- Tycho Brahe, globe, 82, 85; adopted Ptolemy's magnitudes, 83; constellation of Gemini, 84-85.
- Ulugh Beigh, magnitudes, 83.
- Upton, star atlas, 38, 40.
- Uranometria Argentina*, 62, 63, 91-93, 126, 306.
- Uranometria Nova*, 88; magnitude scale, 38-39, 92, 93, 126.
- S Ursae Majoris, light scale of comparison stars by Parkhurst, 180-185; irregularities in elements, 248.
- Valentiner, editor of Schönfeld's observations, 260, 261.
- Van der Bilt, investigation of U Geminorum, 251.
- Variable stars, definition, 3; Pickering's classification of, 5-17; provisional catalogue of, 5; of long period, 9-10; irregular, 10-11; of short period, 11-14; of Algol type, 14-17; cluster type, 14; spectral types, temporary stars, 35; long period, 35; irregular, 36; short period, 36; Algol type, 36; catalogue of, 51, 70; method of naming variables, Argelander's, 68-69; Harvard, 69; Chandler's, 69; André's, 69-70; Nijland, 70; discovery, 73-80; methods of observation, visual, Argelander's step method, 103-106; Pickering's, 106-107; other modifications, 107-108; effect of color on observations, 108-109; precautions, 109-110; value of photo-electric photometers for short period variables, 157-158, 166; light scale of comparison stars, 170-172; light steps of variable, 172-174; method of plotting single light curve, 174; determination of time of maximum and length of period, 174-176; change from light steps into magnitudes, 177-179; formation of light scale with weights, 180-185; method of deriving mean light curve, 186-199; its use, 199-202; Harvard modification for long period variables, 202-203; prediction of maximum and minimum, 206-212; correction to geocentric minimum for short period variables, 213-215; evidence that Algol variables are spectroscopic binaries, 227-236; possible combinations in eclipsing systems, 236-240; evidence for  $\beta$  Lyrae type, 241-244; theories for Cepheid-Geminid type, 244-247; for cluster type, 246-247; irregularities in elements of long period variables, 248-252; irregular variables, 252-253; temporary stars, 253-255; collections of observations, 255-270; statistical study, 273-286; number of discoveries attributed to single observer, 286; earliest variables discovered, 286-287; value of observations by Argelander's method, 289-294; method of observation, 294; amateur associations, 297-298; identification of variable in field, 301-303; precautions, 303-305; list of variables for beginners, 305-306.
- Variation, elements of stellar, 4-5.
- Velocity curve, 233-234.
- Vibration frequency, 21-22, 216.
- Vogel, early work in spectroscopy, 219; spectroscopic observations of Algol, 229-230, 231; at Potsdam, 264.
- Wallace, stained plates, 148; Pan-iso plates, 149.
- Webb, color of double stars, 135.
- Wilson, value of amateur work on variable stars, 296-297.
- Wing, Vincent, *Harmonicon Celeste*, list of stars in constellation of Gemini, 84-85.
- Wolf, early photograph of Nova Aurigae, 8; Palisa's, photographic star charts, 50; discovery of variables with aid of stereo-comparator, 78.
- Yendell, effect of parallactic angle on observations, 109-110; use of mean light curve in determining minimum of Algol type, 199-201; precautions, 304-305.
- Zeeman effect, 27.
- Zinner, galactic distribution of variables, 283-284.
- Zöllner photometer, 116-119; method of reduction, 119-120; use in *Potsdam Photometric Durchmusterung*, 120.

**The Riverside Press**  
**CAMBRIDGE . MASSACHUSETTS**  
**U . S . A**







THIS BOOK IS DUE ON THE LAST DATE  
STAMPED BELOW

AN INITIAL FINE OF 25 CENTS  
WILL BE ASSESSED FOR FAILURE TO RETURN  
THIS BOOK ON THE DATE DUE. THE PENALTY  
WILL INCREASE TO 50 CENTS ON THE FOURTH  
DAY AND TO \$1.00 ON THE SEVENTH DAY  
OVERDUE.

APR 5 1926

ICLF (N)

MAY 1 1948

DEC 12 1967

LIBRARY USE

DEC 11 '67-5 PM

APR 6 1950

LOAN DEPT.

LIBRARY USE

APR 7 1950

LIBRARY USE

APR 16 1950

29 May '50

3 Sep '53 LO  
AUG 29 1953 LU

314951

QB835

Furness

F8

UNIVERSITY OF CALIFORNIA LIBRARY

