

IRON AND STEEL

J·H·STANSBIE ·B·SC·(LOND)·F·I·C

WESTON'S SERIES

LIBRARY
OF THE
UNIVERSITY OF CALIFORNIA.

Class



The "Westminster" Series

IRON AND STEEL



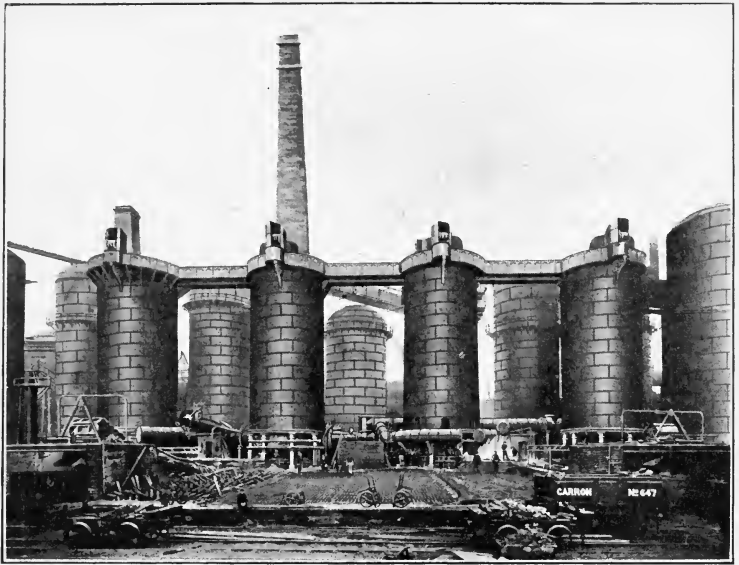

A Scotch Blast Furnace Plant, Carron Works.

IRON AND STEEL

BY

J. H. STANSBIE, B.Sc. (Lond.) F.I.C.

ASSOCIATE OF MASON UNIVERSITY COLLEGE, AND LECTURER
IN THE BIRMINGHAM MUNICIPAL TECHNICAL SCHOOL



NEW YORK

D. VAN NOSTRAND COMPANY

23 MURRAY AND 27 WARREN STREETS.

1908

T. 1102
1975

GENERAL



PREFACE



IRON is the most important of all the metals that have been pressed into the service of man, which is due, not only to its great abundance in Nature, but also to its unique properties. The result of this is that no one metal has received so much attention from both practical men and scientists, as is shown by the fact that some of the most prominent men in Europe and America are investigating the many chemical and physical properties of the metal and its application to the requirements of civilisation. Thus an enormous mass of information has accumulated, and is to be found in original papers and books. Portions of the subject are still in their youth and are growing vigorously, so that the teacher of to-day must become the student of to-morrow. On the other hand, parts of it are so old that their origin is lost in the mists of time, and dates back to the first glimmerings of that intelligence which now enables man to utilise to the fullest extent the valuable properties of the metal.

Although the necessity of technical instruction for the worker in metals has become an acknowledged fact, the question of what form it shall take is still engaging the attention of educationalists. It is clear, however, that the greater the knowledge the worker has of the material

he is using, the more satisfactory will be the result of his labour, both to himself and to the community he serves. Therefore the aim of technical instruction should be to foster intelligent effort to the utmost. To teachers who have assisted in the growth of technical education in this country, and have come into contact with those workers who are willing to take advantage of it, one fact stands out clearly, viz., that a very large proportion of technical students come to the work more or less tired with their daily labour, and have but a limited time to devote to self-improvement. This requires that every assistance should be given to their efforts, and that the subjects they study should be as self-contained as possible. The aim should be to increase the general capability of the greatest number, and not to turn out a few highly trained men.

In the works, economy of material and labour should be the first aim, and nothing can conduce so much to this as a thorough knowledge of the material itself.

The aim of this book is to give as comprehensive a view as its limits will permit of the modern aspects of iron and steel manufacture, together with a sufficient account of its history to enable the reader to follow its march of progress. The methods of producing varieties of the metal suitable to the requirements of the engineer, foundryman and mechanic are described sufficiently to enable the user to follow the producer in his work, and thus learn the history of the material he is handling. The main portion of the book has been written from notes used for courses of lectures on iron and steel manufacture extending over many years, and has been brought up to date by reference to the latest books and papers on the subject. The author

has, therefore, to express his sincere obligation to the many authors of works and papers on the subject, and to the practical men with whom he has come into contact who have so freely given him information that can only be obtained from such sources. Throughout the iron and steel industry both master and man are always willing to give of their best, and that freely.

The diagrams are intended to assist the reader in following the text, and are not to be regarded as working drawings. Whenever possible, photographs of the actual apparatus have been introduced to supplement the drawings, and in this connection the thanks of both reader and author are due to such well-known firms as Messrs. Firth, of Sheffield; Messrs. Hickman, and Messrs. Perry, of Bilston; Messrs. Avery, of Birmingham; Messrs. Massey, of Manchester; the Cambridge Scientific Instrument Company, and the Carron Company of Glasgow.

The thanks of the author are also due to the Council of the Iron and Steel Institute, and to the Committee of the Faraday Society for permission to copy diagrams from original papers in their Proceedings. He is also grateful to Messrs. C. R. Clark and W. H. Juggins for assistance in the preparation of diagrams and in reading the proof sheets.

J. H. S.

MUNICIPAL TECHNICAL SCHOOL,
BIRMINGHAM.

October, 1907.

CONTENTS

CHAP.	PAGE
I. INTRODUCTORY	1
II. IRON ORES, COMBUSTIBLE AND OTHER MATERIALS USED IN IRON AND STEEL MANUFACTURE	14
III. PRIMITIVE METHODS OF IRON AND STEEL PRODUCTION	51
IV. PIG IRON AND ITS MANUFACTURE	67
V. THE REFINING OF PIG IRON IN SMALL CHARGES	116
VI. CRUCIBLE AND WELD STEEL	140
VII. THE BESSEMER PROCESS	156
VIII. THE OPEN HEARTH PROCESS	182
IX. MECHANICAL TREATMENT OF IRON AND STEEL	214
X. PHYSICAL AND MECHANICAL PROPERTIES OF IRON AND STEEL	254
XI. IRON AND STEEL UNDER THE MICROSCOPE	268
XII. HEAT TREATMENT OF IRON AND STEEL	284
XIII. ELECTRIC SMELTING	319
XIV. SPECIAL STEELS	343
GLOSSARY	357
INDEX	367

LIST OF ILLUSTRATIONS



NO.		PAGE
	A SCOTCH BLAST FURNACE PLANT <i>Frontispiece.</i>	
1.	THE THOMPSON CALORIMETER	25
2.	CHARCOAL PILE	31
3.	THE OTTO-HOFFMAN COKE OVEN	34
4.	THE DUFF-WHITFIELD PRODUCER	40
5.	IRON SMELTING IN INDIA	53
6.	THE CATALAN FORGE	55
7.	THE HIGH BLOOMERY	58
8.	THE HUSGAFVEL FURNACE	60
9.	BLAST FURNACE WITH OPEN TOP	68
10.	GJERS CALCINING KILN	72
11.	MODERN BLAST FURNACE	75
12.	WATER-COOLED HOT-BLAST TWYER	78
13.	BOTTOM OF BLAST FURNACE SHOWING TWYERS IN POSITION	79
14.	COWPER'S HOT-BLAST STOVE	81
15.	BLOWING CYLINDER	83
16.	A MODERN BLAST FURNACE PLANT	85
17.	CUP AND CONE	91
18.	MECHANICAL CHARGING APPARATUS	101
19.	FRACTURES OF PIG IRON	105
20.	FOUNDRY CUPOLA	113
21.	SWEDISH LANCASHIRE HEARTH	117
22.	DIAGRAM OF PUDDLING FURNACE	123
23.	WORKING SIDE OF PUDDLING FURNACE	126
24.	THE PERNOT FURNACE	136
25.	CEMENTATION FURNACE	142

LIST OF ILLUSTRATIONS.

No.		PAGE
26.	CRUCIBLE FURNACE	146
27.	CRUCIBLE STEEL MELTING AT NORFOLK WORKS, SHEFFIELD .	148
28.	STYRIAN OPEN HEARTH	150
29.	CONCENTRIC CONVERTER	161
30.	ECCENTRIC CONVERTER	162
31.	TILTING LADLE	164
32.	CASTING LADLE	164
33.	CONVERTER AND CRANES IN BESSEMER SHOP	168
34.	BESSEMER CONVERTER IN POSITION	171
35.	CONVERTER BOTTOM IN REPAIRING SHOP	173
36.	CASTING BASIC STEEL AT SPRING VALE WORKS	175
37.	MOULDS AND CRANES IN BESSEMER SHOP	179
38.	REGENERATIVE OPEN HEARTH, DIAGRAM	183
39.	REGENERATIVE OPEN HEARTH (TRANSVERSE SECTION)	186
40.	FRONT VIEW OF REGENERATIVE OPEN HEARTH	188
41.	WORKING PLATFORM OF OPEN HEARTH FURNACES	191
42.	TAPPING SIDE OF OPEN HEARTH FURNACE	194
43.	CAMPBELL TILTING FURNACE (DIAGRAM)	205
44.	TILTING FURNACE WITH ELECTRIC CHARGER	207
45.	THE HELVE HAMMER	214
46.	INTERIOR OF THE CLAY WHEEL FORGE	215
47.	EXTERIOR OF THE CLAY WHEEL FORGE	217
48.	STEAM HAMMER	219
49.	A STAND OF ROLLS	222
50.	REHEATING OR MILL FURNACE	223
51.	MILD STEEL INGOT	227
52.	GAS-FIRED REHEATING FURNACE OR SOAKING PITS	235
53.	A STAND OF THREE HIGH ROLLS	241
54.	BLOOMING SHEARS	243
55.	RAIL ROLLS	245
56.	A 3,000-TON HYDRAULIC PRESS	249
57.	INTERIOR OF STEEL ROLLING MILL	252
58.	DIAGRAM OF TENSILE TESTING MACHINE	257
59.	TENSILE TESTING MACHINE IN POSITION	258
60.	TENSILE TEST PIECES	260

LIST OF ILLUSTRATIONS.

xiii

NO.	PAGE
61. SHACKLES FOR CRUSHING TESTS	261
62. DIAGRAM OF TRANSVERSE TESTING MACHINE	262
63. TRANSVERSE TESTING MACHINE	263
64. PENDULUM DROP TEST MACHINE	264
65. FERRITE	275
66. CEMENTITE	276
67. PEARLITE	277
68. AUSTENITE AND MARTENSITE	278
69. GRAPHITE AND FERRITE	280
70. CAST IRON CONTAINING SULPHUR	281
71. CAST IRON WITH PHOSPHIDE EUTECTIC	282
72. ANNEALED AND HARDENED STEEL	283
73. COOLING CURVES OF COPPER AND IRON	285
74. COOLING CURVE OF LEAD TIN ALLOYS	289
75. COOLING CURVE OF SALT SOLUTION	291
76. COOLING CURVES OF IRON CARBON ALLOYS	297
77. THE ROBERTS-AUSTEN-ROOZEBOOM CURVE	299
78. MUFFLE FURNACE	304
79. RESISTANCE PYROMETER	313
80. RADIATION PYROMETER	316
81. ALTERNATORS IN POSITION	321
82. THE HÈROULT FURNACE	327
83. THE HÈROULT FURNACE IN POSITION	329
84. THE KJELLIN FURNACE	330
85. THE STASSANO FURNACE	332
86. THE KELLER FURNACE	337



IRON AND STEEL

CHAPTER I.

INTRODUCTORY.

PURE IRON belongs to a class of bodies composed of substance or matter which is as simple in character as it can possibly be. These simple bodies are the elements which enter into the composition of all the more complex bodies that form the crust of the earth, the water which covers the greater part of it, and the atmosphere that surrounds it on all sides. The number of elements is small, but the number of complex bodies formed from them is very large, for the elements bear somewhat the same relation to the other bodies into the composition of which they enter, as do the letters of the alphabet to the words of the language of which they form a part.

The distinctive properties of the elements enable them to be arranged in two groups, of which the pure metals form the largest. The general properties of the metals are so characteristic that there is no difficulty in recognising them by simple inspection. The members of the other group have properties so distinctly opposite to those of the metals that for the want of a better name they are termed *non-metals*. Such well-known substances as sulphur, phosphorus, and carbon are non-metals. Compare, for example, a piece of iron with a piece of charcoal, and the

difference between a metal and a non-metal becomes quite evident. A few elements, however, are very close to the border line between the two groups; but these need not be discussed here. The well-known elements exist in different physical states under ordinary atmospheric conditions: thus, four are gases, oxygen, hydrogen, nitrogen, and chlorine; two are liquids, mercury and bromine; the remainder are well defined solids. A table of those elements with which the reader should be more or less acquainted will be found on p. 13.

The rusting of iron is one of the well known properties of the metal, and there are few who have not noticed the very characteristic change that takes place during the process; the difference between the dark red rust and the metal from which it is formed is so very marked. Why does iron rust? To answer this question it is necessary to refer briefly to the nature and composition of air. A good working atmosphere is a mixture of four gases—oxygen, nitrogen, carbon dioxide and water vapour, of which the oxygen and nitrogen form respectively about one-fifth and four-fifths of the main bulk. These gases are elements, but the carbon dioxide and water vapour are complex bodies or compounds. Now the rusting process, as it takes place under ordinary circumstances, depends upon the presence of oxygen and condensed water vapour. A piece of bright iron exposed to the air will not begin to rust until water vapour condenses to the liquid state on its surface. Then an action is set up; oxygen is absorbed from the air, and the rusting goes on slowly but surely. When perfectly dry rust is strongly heated, water is driven off and a red powder is left behind. This shows that water takes part in the change, and enters into the composition of the rust. The red powder obtained by strongly heating the rust is found to contain iron and oxygen only, to contain these elements in definite and invariable proportions, and to

differ entirely in properties from the elements which enter into its composition. These are the characteristics of a given chemical compound, which always contains the same elements in the same proportions. The red powder is *red oxide of iron*, a definite body of invariable composition.

If a piece of iron is kept in the fire for some time a black scale forms on its surface. This scale can be scraped off and ground to a fine powder, and is very different from the metal from which it is formed. It contains a definite proportion of oxygen which it has obtained from the air passing through the fire. The proportions of iron and oxygen are, however, different from those in the rust, so that a different body is obtained. It is another chemical compound of iron and oxygen.

When an element unites with oxygen to form a *chemical compound*, the compound so formed is called an *oxide*. The red rust and black scale are then oxides of iron, and the difference between them is due to the difference in the proportions of the two elements they contain, and to that only. All the elements that will be noticed in these pages unite with oxygen to form one or more oxides, so that the oxides are a most important class of bodies.

It is easy to find by actual experiment the proportions of the two elements in any oxide. These proportions can then be stated as a percentage composition, that is, so many parts of each element in 100 parts of the compound. Thus the red oxide contains 70 parts of iron and 30 parts of oxygen; and the black oxide 72.4 parts of iron and 27.6 parts of oxygen in 100 parts of the compounds.

But chemists have devised a much more convenient way of representing the composition of compounds. The combining proportions of all elements are compared with the combining proportion of hydrogen, which has the smallest combining proportion of any known element. This allows of the elements being arranged in a tabular form according

to their combining proportions. It is to be distinctly understood that the numbers representing these combining proportions, or *chemical equivalents*, are the results of direct experiments, and the only assumption made is that there are such things as elements, and that they combine together to form compounds.

It has, however, been found more convenient to use the Atomic Theory of Dalton in fixing these proportional numbers for the elements generally. This theory assumes that sensible masses of all definite bodies, either elements or compounds, are made up of exceedingly small particles called *molecules*, and that these molecules are again made up of still smaller particles called *atoms*. Now molecules are supposed to be the smallest possible particles of either elements or compounds which can have a free existence, and atoms are the smallest particles of elements which can exist at all. It must be carefully borne in mind that molecules are the smallest possible particles of compounds, and the smallest particles of free elements.

Now the one invariable property of matter or substance is its *mass*, which is usually measured by weight; so that atoms, however small they may be, must have mass and therefore weight. The term *atomic weight* is, therefore, justifiable. A number of considerations, which cannot be entered into here, are taken into account in fixing the atomic weight of an element, but the first is always the combining proportion as determined by experiment, and it is found that a very simple relation exists between the combining proportion of an element and its atomic weight. The atomic weight of an element is either the same as its combining proportion or a simple multiple of it.

In thinking of atoms their weights must be recognised, and if atoms are represented by symbols, such symbols will also represent their weights. Thus the symbol for iron is Fe, taken from the Latin name *Ferrum*, so that Fe

means the same as the phrase "one atom of iron," and is a ready way of stating it. Also, $\text{Fe}=56$ means that the atomic weight of iron is 56 compared with the atomic weight of hydrogen, which is $\text{H}=1$. Similarly, the symbol and atomic weight of oxygen are expressed thus: $\text{O}=16$.

Now, if it is assumed that a given weight of iron is made up of a definite, although very large, number of atoms, that weight divided by the atomic weight of the metal will give a quotient which is proportional to the number of atoms of iron in the mass. Similarly, a given weight of oxygen divided by its atomic weight will give a number proportional to the number of atoms in the mass. It is proved by experiment that red oxide of iron contains 70 parts by weight of iron and 30 parts by weight of oxygen in 100 parts by weight of the compound, and if these weights are divided by the atomic weights of the elements, thus:—

$$\frac{70}{56} = 1.25, \text{ and } \frac{30}{16} = 1.875$$

it is easily seen that the ratio 1.25 to 1.875 is the same as the ratio 2 to 3, so that must be the proportion between the number of atoms of iron and the number of atoms of oxygen in the molecules of the red oxide of iron. This is shown by arranging the symbols together thus: Fe_2O_3 , which represents the composition of the oxide according to the atomic theory, and is called the formula of the compound. Similarly the black oxide contains 72.4 parts of iron and 27.6 parts of oxygen in 100 parts.

$$\text{Therefore, } \frac{72.4}{56} = 1.292, \text{ and } \frac{27.6}{16} = 1.729$$

so that the ratio 1.292 to 1.729 is very nearly the same as 3 to 4, or the formula for the oxide is Fe_3O_4 .

There are two ways of regarding these symbols and formulæ: the theoretical way, in which they represent atoms of elements and molecules of elements and compounds; and the practical way, in which they represent the composition in definite parts by weight of the definite bodies under consideration. Thus 100 tons of iron scale contain 72 tons 8 cwts. of iron and 27 tons 12 cwts. of oxygen. This appeals most to the practical man; but that is not to say that it is not as well to take the other view sometimes.

The chemist also uses these symbols and formulæ to represent in a connected manner the chemical changes taking place when compound bodies are either formed or decomposed. Thus, when the iron scale is forming in the fire the molecules of oxygen in the air taking part in the change may be pictured as dividing up into atoms, and these atoms linking themselves with the atoms of iron to form the oxide. Further, two molecules of oxygen are supposed to break up into four atoms, and these to link with three atoms of iron to form one molecule of the oxide. This may be expressed graphically thus:—

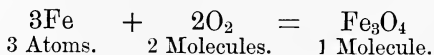

and it may be predicted that what takes place in this group also takes place in every other similar group in the whole mass undergoing the change. This is strongly supported by the fact that the statement is proved by experiment, for

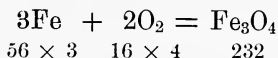

expresses exactly how much oxygen will be absorbed from the air by a given weight of iron during its conversion into scale. This formulated statement of fact and theory is a *chemical equation*. Such equations are found very

useful in following the chemical changes and in calculating the weights of materials taking part in various operations.

The element next in importance to the iron and steel maker is the non-metal carbon, which is the principal combustible constituent of the combustible bodies wood, coal, charcoal, and coke. If carbon is to burn vigorously it must be well supplied with air, and the chemical change that takes place is exactly similar to the formation of iron scale, for it consists of the rapid absorption of oxygen from the air, and the formation of an oxide of carbon; but this oxide is a gas and escapes into the space surrounding the burning body as fast as it is formed. It may, however, be collected in suitable apparatus and weighed, and is then found to contain carbon and oxygen in definite proportions. It is carbon dioxide, CO_2 . The change is expressed by an equation thus:—

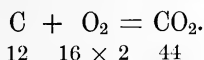

This may be read as follows: one atom or 12 parts by weight of carbon, and one molecule or 32 parts by weight of oxygen furnish one molecule or 44 parts by weight of carbon dioxide; or, taking concrete quantities, 12 cwts. of carbon and 1 ton 12 cwts. of oxygen furnish 2 tons 4 cwts. of carbon dioxide, together with a large, but just as definite, quantity of heat.

But when carbon is burning at a very high temperature in a current of hot air, only half the oxygen is absorbed, and a lower oxide of carbon formed, thus:—

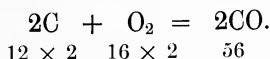

This gas is known as carbon monoxide and is combustible, for it can absorb more oxygen and be converted into the higher oxide. It takes a very important part in the manufacture of iron and steel.

Carbon dioxide is found associated with another oxide of iron still richer in iron than the two already described. It is represented by the formula FeO , which shows that it contains 56 parts of iron to 16 parts of oxygen; or 77.7 per cent. of iron and 22.3 per cent. of oxygen. The two oxides combine to form a compound which has the formula $\text{FeO} \cdot \text{CO}_2$, and is known as ferrous carbonate, a most important natural compound of the metal.

It will be noticed that ferrous carbonate is made up of two oxides, one an oxide of a metal and the other an oxide of a non-metal. Now these oxides are representatives of two classes of oxides: (1) the oxides of the metals, with a few exceptions, are known as *basic oxides*; (2) the oxides of the non-metals, with some exceptions, are known as *acid-forming oxides*. The acid-forming oxides generally unite with water to form acids. Water itself is an oxide of the non-metal hydrogen, and contains 2 parts by weight of hydrogen to 16 parts by weight of oxygen, so that its formula is written H_2O .

The most widely occurring and best known acid-forming oxide is *silica*, which is the only oxide of the non-metal silicon. It occurs in the pure form in the transparent colourless crystals of quartz, and in a less pure form in silica sand. It is also a constituent of a large number of rocks in the earth's crust. The atomic weight of silicon is 28, and the oxide contains silicon and oxygen in the proportion of 28 to 32, so that its formula is SiO_2 . It combines with the basic oxides to form a class of well-known compounds, the silicates; but the combination only takes place at a high temperature. Some of the simple silicates melt at a red heat; others require a very much higher temperature. But if two or more basic oxides are present with the silica so as to form a complex silicate, the melting point of the mass is always lower than the melting point of the most infusible silicate in it. These facts are taken

advantage of in separating infusible siliceous matter during the processes of iron and steel manufacture.

The most important silicates met with in the processes and materials to be described later are the silicates of ferrous oxide, FeO ; lime, CaO ; magnesia, MgO ; and alumina, Al_2O_3 .

Another important acid-forming oxide is phosphoric oxide, P_2O_5 , which is always formed when phosphorus burns in air or oxygen. It combines readily with basic oxides to form phosphates, a well-known class of compounds. Phosphorus also unites with many of the metals to form phosphides.

Sulphur is another non-metal that makes itself very evident in the metallurgy of iron. It has a powerful affinity for the metal, and combines with it readily at a moderate temperature. If a mixture of fine iron filings and powdered sulphur is heated until the latter begins to melt, rapid combination of the two elements takes place with the liberation of much heat, and the mass is raised to a bright red heat without any further heating from outside. Iron burns in sulphur vapour in much the same way that it burns in oxygen. The properties of the resulting compound are quite distinct from those of the elements that enter into its composition. The chemical change and the weight relations are expressed by the equation—

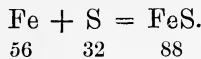

The compound ferrous sulphide is the stable sulphide of iron. Others will be mentioned later, but this is the most important one to the iron metallurgist. The presence of a small quantity of it in commercial iron renders the metal unworkable at a red heat. Sulphur itself is a yellow, crystalline solid that melts readily when heated, and burns with a blue flame in air or oxygen. The compound formed

in the burning is sulphur dioxide, SO_2 ; but there is another compound, sulphur trioxide, SO_3 , which is the principal acid forming oxide of sulphur, and is present in sulphuric acid, H_2SO_4 .

Water plays a most important part in several of the reactions and processes to be considered later. It is an oxide of hydrogen, and is formed when the gas hydrogen, or any combustible body containing it, is burnt in air or oxygen. Much heat is developed by the combustion, and the change is represented thus:—

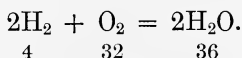

By dividing each of the proportional weights by 4 it is seen that 1 part by weight of hydrogen combines with 8 parts by weight of oxygen to form 9 parts by weight of water.

Hydrogen will also remove the oxygen of some metallic oxides when they are heated in its presence, and thus set the metals free. This action is spoken of as *reduction*, and the gas itself as the reducing agent. If hydrogen is passed through a glass tube in which some red oxide of iron is being heated to a dull red heat, the red colour of the oxide disappears, and water collects in a receiver connected with the exit end of the tube. The black powder left in the tube is found to be finely divided metallic iron. The change is thus expressed:—

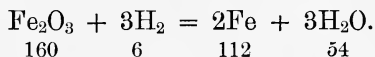

Carbon, C, and carbon monoxide, CO, will also remove the oxygen from metallic oxides when heated in contact with them, and in the case of oxides of iron the reduction takes place at a comparatively low temperature. Thus, if carbon monoxide gas is substituted for hydrogen in the experiment described above, metallic iron is still obtained, but it is

found to have reacted on the excess of the monoxide, and to have absorbed some carbon from it. The change is as follows:—

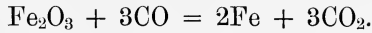

If a mixture of powdered charcoal and oxide of iron is made red hot, the carbon of the charcoal unites with the oxygen of the oxide, and iron is set free. It is in a finely divided state, and must not be exposed to the air while it is hot, or it will oxidise again very rapidly. The change is—

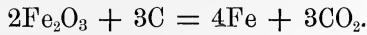

The atmosphere which surrounds the earth is so essential to life that we become familiar with it at an early age, and learn to recognise it by its general properties. It is a mixture of gases of which two, oxygen and nitrogen, are regarded as the essential constituents. Oxygen is the supporter of combustion, and enters into all oxidation changes. If used in the pure state, all such changes take place much more rapidly and energetically than when it is diluted by the presence of nitrogen, which is an inert gas. In fact, the chief function of nitrogen in the atmosphere is to modify the action of the oxygen by diluting it. The oxidation processes by which carbon dioxide is formed are largely responsible for the presence of the gas in the atmosphere; but as this gas is absorbed by growing plants, a more or less rough balance is struck, and the proportion of carbon dioxide in the atmosphere is fairly constant. Water vapour is also a constant constituent of the atmosphere, into which it passes from the large bodies of water in contact with it. But the proportion present varies considerably from time to time, as it depends upon a number of conditions, the principal one of which is temperature. The higher the temperature of the air, the more water vapour it will absorb; but the saturation point is rarely reached.

The following may be taken as an average composition by volume of atmospheric air¹ :—

Oxygen, O ₂	20·66
Nitrogen, N ₂	77·91
Carbon dioxide, CO ₂	0·03
Water vapour, H ₂ O	1·40
		100·00

The most important physical and mechanical properties of the atmosphere are due to its temperature and pressure, both of which are variable. The general tendency of lowering the temperature of gases and vapour is towards changing them into liquids, and finally into solids; but the ordinary changes in the atmosphere have very little effect upon its gases, with the exception of water vapour. Liquid water separates from the air when its temperature falls below the saturation point of its contained water vapour; but even a considerable reduction in the temperature only effects a partial separation of the water from air. The familiar phenomenon of dew and rain are the results of this condensation, which can also be effected artificially, so that it is possible to regulate the quantity of water vapour in air to be used for manufacturing purposes by cooling it before use.

The barometric pressure of the air also varies considerably from time to time, so that a standard pressure is adopted for comparison. This is equal to the pressure of a column of mercury 29·92 inches, or 760 millimetres high. This is equal, roughly, to a direct pressure of 15 pounds on the square inch of surface exposed to it; but in still air this pressure is exerted equally in all directions, and is not noticeable, although it can be measured by causing it to balance a column of mercury as indicated above. But air in motion through pipes has a pressure greater than this, and the excess of pressure depends upon the driving force

¹ Small quantities of several gases, of which argon is the most important, are also present in the atmosphere.

producing the motion. The greater the excess of pressure the more rapid the motion, and the greater the quantity of air passing through a given cross-section in unit time. Such excess pressures are usually stated in pounds per square inch, and may vary in ordinary furnace practice from a few ounces to twenty-five pounds per square inch.

TABLE OF SOME COMMON ELEMENTS AND OXIDES.

Non-Metals.

Elements.	Symbols.	Atomic Weights.	Oxides.	Formulae.	Common Names.
Arsenic .	As	75	Arsenic Trioxide	As ₂ O ₃	White Arsenic.
Bromine .	Br	80			
Carbon .	C	12	Carbon Monoxide .	CO	Carbonic Oxide.
			" Dioxide .	CO ₂	" Acid Gas.
Chlorine .	Cl	35.5			
Hydrogen .	H	1	Hydrogen Monoxide	H ₂ O	Water.
Iodine .	I	126.5			
Nitrogen .	N	14	Nitrogen Dioxide .	NO	Nitric Oxide.
			" Tetroxide .	NO ₂	" Peroxide.
Oxygen .	O	16			
Phosphorus	P	31	Phosphoric Oxide .	P ₂ O ₅	Phosphoric Acid.
Silicon .	Si	28	Silicon Dioxide .	SiO ₂	Silica.
Sulphur .	S	32	Sulphur Dioxide .	SO ₂	
			" Trioxide .	SO ₃	

Metals.

Aluminium.	Al	27	Aluminium Oxide .	Al ₂ O ₃	Alumina.
Calcium .	Ca	40	Calcium Oxide . .	CaO	Lime.
Chromium .	Cr	52.5	Chromium Oxide .	Cr ₂ O ₃	Chromic Oxide.
Copper .	Cu	63	Cupric Oxide . .	CuO	Black Oxide of Copper.
			Cuprous Oxide . .	Cu ₂ O	Red Oxide of Copper.
Iron . . .	Fe	56	Ferrous Oxide . .	FeO	
			Triferrous Tetroxide .	Fe ₃ O ₄	Black Oxide of Iron.
			Ferrous Oxide . . .	Fe ₂ O ₃	Red Oxide of Iron.
Lead . . .	Pb	207	Lead Oxide	PbO	Massicot or Litharge.
			Triplumbic Tetroxide .	Pb ₃ O ₄	Red Lead.
Magnesium .	Mg	24	Magnesium Oxide .	MgO	Magnesia.
Manganese .	Mn	55	Manganous Oxide .	MnO	
			Manganese Dioxide .	MnO ₂	Black Oxide of Manganese.
Molybdenum	Mo	96	Molybdenum Trioxide .	MoO ₃	Molybdic Acid.
Nickel . . .	Ni	58.6	Nickel Oxide	NiO	
Titanium .	Ti	48	Titanium Oxide . .	TiO ₂	
Tin	Su	118	Stannic Oxide . . .	SuO ₂	Tin Oxide.
Tungsten .	W	183.6	Tungsten Trioxide .	WO ₃	Tungstic Acid.
Vanadium .	V	51	Vanadium Pentoxide	V ₂ O ₅	
Zinc	Zn	65	Zinc Oxide	ZnO	Zinc White.

CHAPTER II.

IRON ORES, COMBUSTIBLE AND OTHER MATERIALS USED IN IRON AND STEEL MANUFACTURE.

THE earth's crust is the storehouse from which come the solid materials used in making iron and steel; and the occurrence, distribution, and properties of such materials may now be considered. The formation of the crust of the earth, as far as it is known to man, can be traced to the action of well-known forces, and may be said to have begun when the temperature of the cooling solid crust was such that water vapour in the atmosphere surrounding it began to condense and fall as rain drops on the surface. The various atmospheric influences, such as wind and rain and alternations of heat and cold, commenced the breaking up of the solid structure, and the transport of the *débris* from one part to another. The same agents are working to-day, slowly and surely, and from their present action the geologist is able to draw deductions as to what took place during the long periods of time in which the rocks with which he is acquainted were formed. The formation of stratified rocks is due to atmospheric agencies, assisted by running water, which, if allowed to work undisturbed, would gradually reduce the surface to one dead level; but forces working in the crust itself have to be considered, for the gradual cooling of the earth's mass, with its accompanying shrinkage, has broken up the surface into vast ridges and hollows, forming mountain chains and ocean beds.

By careful examination of stratified rocks, all the world over, geologists have been able to classify them into well-

marked systems. The presence of a given stratified rock, or system of rocks, presupposes that the underlying rock was under water during its formation; so that whether a particular rock or system is present in the crust of a given district depends upon whether that district was submerged or not during the period when such rocks were in course of formation. If, then, certain metalliferous minerals are known to be associated with a particular system of rocks, it is evidently necessary to find out if that system is represented in the strata of the district before commencing the search for such minerals there; but the practical man of the past was not always educated up to this point, and much money and labour have been expended in vain.

The stratified rocks in various parts of the crust have been disturbed and altered by the intrusion of molten matter from below from which the igneous rocks have been formed. The granites and similar rocks are of igneous origin.

It is well known that the useful metals are associated for the most part with the older rocks, and the seeker for such metals usually makes for the hills where these rocks have been brought to the surface during the crumpling process by which the hills were formed. It must not be thought from this that every mountain-side will furnish a store of metalliferous matter, but in portions of most mountain ranges all over the world some of the useful metals are to be found. Although the common metals are very widely distributed through the earth's crust, it is only when they have become concentrated in veins, beds, or irregular deposits of considerable extent that they pay for getting. Also, during the weathering of rocks on the mountain-side, and the transport of broken material by mountain streams and rivers, with the deposition of finely divided matter in the beds of lakes and the estuaries of rivers, a selective process took place, and layers of different materials were deposited one over the other to form stratified rocks. In



this manner rich metalliferous deposits may have been formed in positions far removed from the hills.

Very few metals are found in the metallic, or "native" state in paying quantities. Certain elements, of which oxygen, sulphur, and carbon are the most important, are known as mineralising agents, that is, they have combined with the metals to form the compounds which are present in the ores. But it is rarely that these compounds are found in the pure state; they are associated with more or less mechanically mixed earthy matter which forms the "gangue," or "vein stuff" of the ore. So that an *iron ore* may be defined as a compound of iron and oxygen, or of iron, oxygen and carbon, associated with earthy matter or gangue. Oxide of iron, which is widely distributed through the earth's crust, is often found in a highly concentrated state forming rich deposits of ore at various depths from the surface, and sometimes in close proximity to seams of coal, beds of clay, and deposits of limestone. Sulphides of iron are very widely distributed, but are not usually regarded as iron ores, as they are very little used as such at present.

The black magnetic oxide is of frequent occurrence, but the red oxide, either by itself or combined with water, is the most important oxide, and ferrous oxide combined with carbon dioxide in ferrous carbonate is the iron compound present in a very important series of ores. The principal gangues are argillaceous (chiefly clay), calcareous (chiefly limestone), and siliceous (chiefly silica), but vary with different ores. They are often so intimately mixed with the iron compound as not to be distinguished from it; this is especially so in the case of the clay-stones and spathic ores.

THE CHIEF IRON ORES.

Magnetite, Fe_3O_4 , contains 72.4 per cent of iron when pure; but usually gives from 58 to 65 per cent. of the

metal. It is a hard, heavy, black stone, that gives a black streak on unglazed porcelain. The gangue is more or less complex, but usually siliceous in character.

Red Hæmatite, Fe_2O_3 , contains 70 per cent. of iron when pure; but usually gives from 40 to 62 per cent. of metal. The hæmatites vary very much in appearance and physical character. They vary from very dense, hard, and compact varieties of a dark red colour to less dense, friable varieties of a lighter shade of red; but they all give a red streak. The gangue is variable.

Brown Hæmatite, $\text{Fe}_2\text{O}_3 \cdot x \text{H}_2\text{O}$, where $x \text{H}_2\text{O}$ represents varying quantities of water in the different varieties. Thus, limonite is represented by the formula $2\text{Fe}_2\text{O}_3 \cdot 3\text{H}_2\text{O}$, and göthite by $\text{Fe}_2\text{O}_3 \cdot \text{H}_2\text{O}$. The colour and physical characters vary considerably, from brown to yellow, and dense and hard, to light and friable. The content of iron varies very much.

Carbonate Ores, $\text{FeO} \cdot \text{CO}_2$. The pure carbonate contains 48·3 per cent. of iron, but the ores themselves are very variable. They form a very important series, and are of widely different characters, which is largely due to the nature of the associated gangue. The purest member of the series is *siderite*, and this is closely followed by the *spathic ores*. These ores vary in colour from white to yellow and brown, and the gangue is usually calcareous. The *clay ironstones* carry an argillaceous gangue, are compact and stony in appearance, and vary in colour from light to dark slaty brown. The *blackbands*, in which the ironstone, with its clay gangue, is intermixed with thin bands of coaly matter, are also important members of this series.

Sulphides of Iron.—Iron pyrites, FeS_2 , is the most abundant of the natural sulphides, but is not worked directly for the iron it contains, nor will it be so worked until other ores give out, on account of the difficulty and expense

of getting rid of the sulphur. It is brass yellow in colour, hard, and readily reduced to powder.

Occurrence of Iron Ores.—Deposits of iron ores are found among all the rock formations known to geologists, from the oldest to the most recent. They occur in veins, beds and irregular deposits. How they were formed is to some extent a matter of conjecture; but the simplest explanation of the formation of veins is that water, highly charged with iron chloride, FeCl_3 , or iron bicarbonate, $\text{FeO} \cdot 2\text{CO}_2 \cdot \text{H}_2\text{O}$, percolated through fissures in the rocks already filled with limestone, and gradually dissolved the limestone, leaving precipitated oxide of iron in its place. In this way a kind of substitution of one mineral for another took place, the less soluble rocks forming the sides of the fissure being still left as the boundary walls. In the case of magnetites and red hæmatites either the temperature of the solution was such as to cause the precipitation of the anhydrous oxide, or the heat of the surrounding rocks was sufficient to expel the water, and leave the ore in the anhydrous condition. Examples of such formations are to be found in the magnetites of Norway and the hæmatites of Cumberland. In the case of irregular deposits such as those in the Forest of Dean, the iron solution found its way into the limestone beds, dissolved the limestone from particular portions, and deposited oxide of iron in its stead. In this way churns were formed. One such churn yielded no less than 60,000 tons of rich ore.

Beds of ore may have been laid down during the ordinary formation of strata by the deposition of oxide of iron or carbonate of iron suspended as fine particles in the waters of lakes and estuaries, or by the drying up of waters containing the iron compounds in solution. Or, they may have been formed by substitution as already explained. The ironstone beds associated with the coal measures are good examples.

The presence of gangue is explained on the assumption that it was already present in the beds in which the substitution took place; or that it was carried mechanically into the pores of the deposited ore by water filtering through it.

Winning the Ore.—Mining or quarrying is resorted to according as the deposit is deep down in the earth, or near to the surface. The cost of deep mining is heavy, and only rich deposits pay for working; but quarrying is a comparatively inexpensive method, and poorer ones can be worked at a profit. An excellent example of iron ore quarrying is to be found in the Spanish province of Vizcaya, which has an annual output of upwards of four million tons of good hæmatite ore. The quarrying of spathic ore from the sides of the Eisenberg in Styria is also a notable example. Large deposits of a somewhat poor and phosphoric ore are now being quarried in the neighbourhood of Banbury, Oxon. Here the overburden, as the overlying strata are called, is stripped off, and put back again after the ore has been taken out. The surface is thus restored at a lower level, and the value of the land but slightly depreciated. This is an excellent example of modern method.

Great Britain.—The British Isles have been and are still a prolific source of iron ores. All the ores enumerated, with perhaps the exception of magnetite, occur in abundance. Magnetite is found in Devonshire and Yorkshire; red hæmatite in Cumberland, Westmorland, and Yorkshire; brown hæmatite in Northamptonshire, Lincolnshire, Leicestershire, Oxfordshire, Gloucestershire, and Glamorganshire; clay ironstones of the coal measures in Staffordshire, Shropshire, Derbyshire, Warwickshire, Yorkshire, and in Wales and Scotland.

Iron ore is also found in Ireland, but it does not yield a large percentage of iron, and usually contains a considerable quantity of alumina; it forms a useful flux.

Germany also furnishes important deposits of spathic ores and hæmatites.

Styria possesses large deposits of spathic ores.

France is rich in ironstone of the Lias formation in the neighbourhood of Nancy; red hæmatite, and ironstone of the coal measures in the great coal centres are also abundant.

Belgium has large deposits of ironstone of the coal measures.

Sweden is celebrated for its magnetites and red hæmatites. The important deposits of magnetite are at Danne-mora and Gellivare.

Spain is at present an abundant source of red hæmatites, ruby ore and Bilbao ore are largely exported to England.

India possesses very extensive deposits of magnetite. Red and brown hæmatites, and sometimes specular ore, are found in the hill districts, and are at present only superficially worked by the natives. They await future European enterprise.

America.—The principal ores of the United States are magnetites and hæmatites, some of which are very rich in iron. Poor ores are also abundant, and when they contain the magnetic oxide they are concentrated by magnetic separation.

Canada is very rich in deposits of magnetites and hæmatites.

Australasia possesses abundant supplies of all kinds of ores, which, however, have not been worked to any extent.

Iron ores are sometimes classified into non-phosphoric and phosphoric ores, according to the percentage of phosphorus they contain. This is important, as in some of the processes of manufacture practically all the phosphorus present in the ore passes into the metal separated from it.

Non-phosphoric ores are those from which the pig-iron

extracted contains less than 0·1 per cent. of phosphorus. They are principally the rich magnetites and red hæmatites of Cumberland, the Forest of Dean, Spain, Sweden, America, etc.

Phosphoric ores give pig-iron containing from 0·1 to upwards of 2 per cent. of phosphorus. These are for the most part the clay iron-stones and brown hæmatites of this and other countries.

The nature of the compounds usually present in iron ores is shown in the Table below.

AVERAGE COMPOSITION OF IRON ORES.

Compounds Present.	Magnetite.	Red Hæmatite.	Brown Hæmatite.	Carbonates.
Ferric Oxide, Fe ₂ O ₃		79·92	69·92	
Magnetic ,, Fe ₃ O ₄	85·41			
Ferrous ,, FeO				48·13
Silica, SiO ₂	5·82	8·86	9·00	5·73
Alumina, Al ₂ O ₃	1·57	1·64	3·16	4·52
Lime, CaO	1·42	1·85	2·93	2·47
Magnesia, MgO	1·20	0·38	0·45	2·36
Manganous Oxide, MnO	0·56	0·37	0·30	2·27
Phosphoric ,, P ₂ O ₅	0·11	0·02	0·90	0·53
Sulphur, S	0·04	0·01		0·01
Carbon Dioxide, CO ₂				32·28
Water, H ₂ O	0·72	6·95	13·34	1·70
Insoluble Matter	3·15			
	100·00	100·00	100·00	100·00

FUEL.

Materials used for the generation of heat on the large scale are required in enormous quantities in the manufacture of iron and steel, and a plentiful and cheap supply at the works is one of the essentials to their success. Coal is the most important of these heat generators, and a short

account of its origin, nature and distribution will be useful in following out its application.

Coal has been defined as mineralised vegetable matter, and occurs for the most part in beds or seams among the rock formations of the carboniferous system, which is bounded by the old red sandstone below and the new red sandstone above. This system, which is without doubt the most important to the iron industry, contains beds of limestone, clay, and ironstone, in addition to the coal measures, and indicates the existence of prolific vegetable life and of the lower forms of animal life on the earth's surface during its formation. Dense masses of vegetation must have accumulated at the estuaries of enormous rivers, to be submerged, then to be covered by rock-forming materials during periodic inundations, and to undergo that slow decay out of contact with air that has resulted in the concentration of carbon in the enormous masses of coal which form part of the system. Sometimes the coal beds crop out near the surface, but generally shafts have to be sunk through the overlying strata to reach them.

The elemental constituents of vegetable matter are carbon, hydrogen, oxygen, and nitrogen; and in addition there is inorganic matter which is left behind as ash when the substance is completely burned. During its conversion into coal gaseous matter is liberated, and carbon becomes concentrated in a smaller mass of material. The thermal value of the coal depends largely upon this concentration of carbon, and the composition of the different varieties brings this out very clearly. The older the deposit the more pronounced is the change, and the nearer the coal approaches in composition to pure carbon.

Coals are usually classified into three groups: (1) *Lignites*, (2) *Coals*, (3) *Anthracites*; but there is no very sharp line between them. Some coals give out a large quantity of combustible gas when strongly heated out of

contact with air; others give out a much smaller quantity under the same conditions. This gives rise to the classification into *long flaming* and *short flaming* coals. Some varieties also leave a firmly coherent residue after all the gaseous matter has been driven out of the powdered coal; others leave a pulverulent residue. The former are the *caking* coals, and the latter the *non-caking* coals, or free-burning coals.

Lignites are coals belonging to more recent formations than the carboniferous system, and still show traces of their woody (ligneous) origin. They vary very much in appearance, from brown, dull and earthy, to black and shining; but they all give off a dense black smoke when burnt in a moderate current of air. When lignites are strongly heated out of contact with air, much water and volatile matter is driven off, and a residue of less than 50 per cent. of friable coke is obtained. The total carbon varies from 57 to 75 per cent., and the ash from 3 to 30 per cent. The principal drawback to the use of lignites as fuel is the large amount of water they contain, which in the freshly-mined fuel may reach 30 per cent., but about half of it disappears on air drying. Lignites are found in parts of Germany.

Coals belonging to the carboniferous age have a deep black colour, shiny appearance, and lamellar fracture. In them the ligneous structure has entirely disappeared. They vary much in properties and composition; and even those of the same composition may vary widely according to the manner in which their elements are combined together. The amount of fixed carbon is always greater than 50 per cent., and from a good coking coal upwards of 80 per cent. may be obtained. The total carbon varies from 75 to 93 per cent., and the ash from 1 to 30 per cent., but rarely exceeds 8 per cent. The volatile matter varies between 43 and 15 per cent. Free burning and long flaming coals are

the best for furnace work; the short flaming coals are most suitable for conversion into coke. The Welsh steam coal is a good example of a free-burning coal used for the firing of marine and locomotive boilers. They are found in all the coal-bearing districts of the world.

Anthracites.—These are the most concentrated form of coal. They contain from 93 to 95 per cent. of carbon, and leave a residue of coke from 85 to 93 per cent., which, however, shows no indication of caking even at a bright red heat. They are bright jet black in colour, homogeneous in structure, and clean to handle. The moisture is small, and the ash varies from 1 to 6 per cent. The South Wales and Pennsylvanian deposits are the most noted.

Testing Coal.—Much information of the general character of a sample of coal may be obtained from the following simple experiments:—

(1) The sample of coal to be tested is crushed to a coarse powder, 400 grains weighed into a small clay crucible, and the lid carefully luted on with moist clay, a small space being left for the escape of gas. The crucible is then heated to a bright red heat for twenty minutes, and the general appearance of the flame of the escaping gas noted. When the crucible is cold the lid is removed, the residue weighed and examined. A simple calculation gives the percentage of coke, and the percentage of volatile matter is obtained by difference.

(2) Fifty grains of the finely-powdered coal are weighed in a porcelain crucible, and heated in a muffle furnace at a bright red heat. When the coal is completely burnt the residue of ash is weighed, and the weight multiplied by 2 gives the percentage.

Calorific Power.—To obtain fuller information it is necessary to determine the elemental composition of the coal by actual analysis. In computing the heat-giving power of the fuel from its composition it is usual to

consider the whole of the carbon as available for the generation of heat, but only that portion of the hydrogen in excess of the amount required to combine with the whole of the oxygen present in the coal to form water. This excess, or available hydrogen, as it is called, and the whole of the carbon, are the useful combustible constituents of the coal, and when their percentages are known the *calorific power* of the fuel can be calculated. Carbon develops its maximum amount of heat when it burns to form carbon dioxide, and one pound of charcoal gives out sufficient heat to raise 8,080 pounds of water through 1° C., and this is the measure of the calorific power of carbon. Similarly, one pound of hydrogen when burnt to water furnishes sufficient heat to raise 34,462 pounds of water through 1° C. The unit quantity of heat may be taken as that quantity required to raise one pound of water through 1° C. in temperature. A steam unit is also used in which the heat required to convert one pound of water at 100° C. into steam at the same temperature is taken. It is 537 times greater than the water unit.

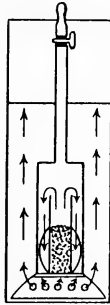

FIG. 1.

But what the practical man wants is a quick, ready method of determining the calorific power of a fuel, and though the result may be only approximate it is usually sufficiently close for his purpose. The Thompson calorimeter is largely used in comparing the calorific values of various coals. A weighed quantity of the finely-powdered and dried coal is mixed with sufficient saltpetre and chlorate of potash to furnish the oxygen for its complete combustion. The mixture is then packed in a metal cylinder and a short cotton fuse pushed into it ready for firing. The cylinder is held on a perforated stand by metal springs, and when the fuse is ignited a metal chamber, open at the bottom, is pushed over the springs, and the

whole is immersed in a glass vessel containing a weighed quantity of water at a known temperature. The fuse on burning down to the mixture fires it, and the gaseous products of the combustion are forced by their own pressure through the holes in the bottom of the stand, and escape through the water by which their heat is absorbed before they pass into the air. When the combustion is finished a tap connected with the chamber is opened, and the interior of the chamber flooded, so that the whole of the heat is absorbed by the water. The temperature of the water is then taken, and the experiment is finished. From the weight of coal burnt, the weight of water in the vessel, and its rise in temperature, the calorific power of the fuel can be calculated. The apparatus is shown in Fig 1. The heat lost owing to the roughness of the experiment is estimated at 10 per cent. of the whole, and this is allowed for.

Example: Weight of coal 30 grains.
 „ water 29,010 grains.
 Rise in temperature 6.5° C.

$$\text{Then } \frac{29010 \times 6.5}{30} = 6285 + 628 = 6913$$

That is, the heat generated when 1 lb. of the coal is completely burnt would raise 6,913 lbs. of water through 1° C., or would evaporate $\frac{6913}{537} = 12.8$ lbs. of water at 100° C. to steam at the same temperature.

The complete apparatus is sold for use in the works, and when the instructions are followed it is only necessary to read the temperature in degrees Fahrenheit, and then add 10 per cent. to at once obtain the evaporative power of the coal being tested.

In the case of a dense fuel, such as hard coke or

anthracite, it is often necessary to mix with it a weighed quantity of a more easily burnt coal, or charcoal, the calorific power of which is known. The calorific value of the fuel under examination is then obtained by difference.

Similar apparatus is also in use in which a stream of oxygen gas is passed through the combustion chamber to take the place of the chlorate and saltpetre, and the products of combustion are made to pass through the water in the calorimeter.

For very accurate determinations a more elaborate form of apparatus is necessary, and the Berthelot-Mahler calorimeter is largely used for the purpose. It consists of a steel shell which has been nickel-plated outside and enamelled inside, and is fitted with a screw top provided with a tap through which a gas can be forced into the interior. The fuel to be burnt is placed in a platinum cup suspended from the under side of the movable top, and sufficient oxygen to burn it is forced under pressure into the shell. The bomb is then completely immersed in the water contained in the calorimeter vessel, which is very carefully protected from loss of heat by a surrounding jacket. The fuel is ignited by passing an electric current through a spiral of thin platinum wire suspended just above it. The spiral becomes red hot and ignites the fuel, which then burns vigorously in the compressed oxygen. The heat developed is absorbed by the water in the calorimeter, and its quantity determined. All kinds of fuel, solid, liquid, and gaseous, can be burnt in this apparatus with very accurate results; but many precautions have to be taken, and corrections made, to obtain them.

The calorific power of a combustible body can also be calculated from its composition, but for this purpose the analysis of the fuel is required. The following is given as an example of this method :—

A sample of coal was found to contain—

Carbon	68·01 per cent.
Hydrogen	3·33 „
Oxygen	5·21 „

Constituents not given consisted of moisture, ash, sulphur, etc.

Then the weight of carbon in unit weight of the
fuel = 0·6801

And the number of units of heat liberated by
its combustion = $0·6801 \times 8080$. . . = 5494

The weight of available hydrogen in unit
weight of the fuel = $0·0333 - \frac{0·0521}{8}$. . . = 0·0268

And the units of heat liberated by its com-
bustion = $0·0268 \times 34462$. . . = 924

Therefore calorific power = $5494 + 924$. . . = 6418

The number obtained by an actual combustion
was 6370

The observed and calculated values are found to agree fairly well in the majority of cases, which gives confidence in the practical methods.

The calorific power of a fuel may then be defined as the number of units of heat developed by the complete combustion of a unit weight of the fuel. In measuring the heat it is necessary for the products of combustion to come to the same temperature as the materials were when the combustion commenced. The whole of the effective heat is thus measured. The unit of heat is arbitrary, but when once fixed is definite. Water is commonly used as the absorbing medium on account of its great capacity for heat, or specific heat as it is called. It has the highest specific heat of any pure substance, either solid, liquid, or gaseous, and is taken as unity. All other substances have, therefore, specific heats less than 1.



The following Table gives the calorific power of a number of common bodies. The unit weight may be taken as 1 lb. and the unit temperature as 1° C.

TABLE OF CALORIFIC POWER.

Substance burnt.	Compounds Formed.	Units of Heat.
Charcoal, C	CO ₂	8080
Graphite, C	CO ₂	7797
Diamond, C	CO ₂	7770
Carbon, C	CO	2473
Marsh Gas, CH ₄	CO ₂ ; H ₂ O	13063
Olefiant Gas, C ₂ H ₄	CO ₂ ; H ₂ O	11857
Carbon Monoxide, CO	CO ₂	2400
Hydrogen, H ₂	H ₂ O	34462
Silicon, Si	SiO ₂	7830
Phosphorus, P	P ₂ O ₅	5700
Iron, Fe	Fe ₃ O ₄	1181
Dry Wood	CO ₂ ; H ₂ O	3616
Coal, average	CO ₂ ; H ₂ O	8000
Coke, average	CO ₂	7000
Anthracite	CO ₂	8460
Sulphur, S	SO ₂	2240

Note.—Carbon monoxide contains $\frac{C}{CO} = \frac{12}{28} = \frac{3}{7}$ of its weight of carbon, so that unit weight of carbon is contained in $\frac{7}{3}$ of the oxide. Therefore $2400 \times \frac{7}{3} = 5600$ heat units are obtained by burning the weight of carbon monoxide containing unit weight of carbon. Then $2473 + 5600 = 8073$. Thus it is evident that the same quantity of heat is developed whether the carbon is burnt in two stages, or at once. This is generally true for other combustible bodies that admit of partial as well as complete combustion.

Calorific Intensity.—This term indicates the temperature to which the products of a given combustion would be raised if the whole of the heat developed were confined to

these products. This is, however, never the case, so that the practical temperature always falls short, and often very short, of the theoretical one; but the more rapid the action the higher the temperature obtained, for there is less time for the heat to escape into surrounding bodies.

The quantities to be taken into account in calculating the calorific intensity of a given fuel are: (i.) the weight of the fuel; (ii.) its calorific power; (iii.) the weight of the products of combustion; (iv.) their specific heats. Also, if there is any inert matter within the zone of combustion, that too has to be raised to the same temperature, so that its weight and specific heat must also be taken into account. The usual plan is to take unit weight of the fuel, which simplifies the general statement. Thus—

$$\frac{\text{Calorific power of fuel}}{\text{Weight of products of combustion} \times \text{Specific heat of products}} = \text{Calorific intensity.}$$

The following examples will serve to illustrate the general principles:—

(1) Carbon burning in oxygen. The product of combustion is carbon dioxide, CO_2 . Now the proportion of oxygen to carbon in this compound is $\frac{32}{12} = \frac{8}{3}$; therefore the weight of the product containing unit weight of carbon $= \frac{11}{3} = 3.66$, and the specific heat of carbon dioxide is 0.2164.

Therefore
$$\frac{8080}{3.66 \times 0.2164} = 10125^\circ\text{C.}$$

(2) Carbon burning in air. Here the inert nitrogen in the air is mixed with the products, and must be raised to the same temperature. The proportion between the weights of oxygen and nitrogen to the air is 1:3.35. Therefore the 2.66 parts of oxygen will bring $2.66 \times 3.35 = 8.9$ parts of nitrogen into the combustion zone. The

specific heat of nitrogen is 0.244, and the statement becomes—

$$\frac{8080}{3.66 \times 0.2164 + 8.9 \times 0.244} = 2727^{\circ} \text{C.}$$

This brings out clearly the great influence of inert matter in the combustion zone upon its temperature.

Sulphur is invariably present in coal, usually as iron pyrites, FeS_2 , and sulphate of lime, CaSO_4 . It is very objectionable in some processes, and is very difficult to remove completely. Fuels used for particular purposes are analysed to determine the percentage of sulphur present in them.

Charcoal. — This fuel is used to some extent in the metallurgy of iron, and is prepared by heating sound, well grown wood in contact with a limited supply of air. The usual plan is to make the logs into a circular pile round a rough wooden chimney, and cover it with turf and soil so as to make it fairly airtight. The pile is then fired from the top of the chimney, and the “burning” regulated by making holes in the cover. The combustible gas driven out of the wood by the heat burns within the pile and carries on the charring. When the pile is “burnt” out the cover is removed, and the hot charcoal quenched with water. The general arrangement of the pile is shown in Fig. 2. The average yield is about 20 per cent. by weight of the original wood, and the average composition of the charcoal free from ash is, carbon = 90 per cent., hydrogen = 3 per cent., oxygen and nitrogen = 7 per cent. Thus there is about 10 per cent. of gaseous matter left in the product. Charcoal is usually free from sulphur, and the ash amounts to about 1 per cent.

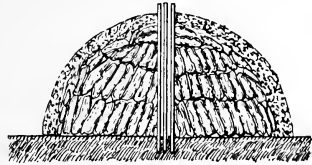

FIG. 2.—Charcoal Pile.

Coke.—This is the most important prepared fuel, and is made in large quantities. Coke of good, or even of medium quality, is a hard, compact, coherent body. It is grey in colour, and usually has a more or less columnar structure. It contains the fixed carbon, a little oxygen and hydrogen, the whole of the ash, and the greater part of the sulphur originally present in the coal from which it was manufactured. Omitting the gaseous constituents, an average coke for blast furnace work should be sufficiently hard and compact to bear the furnace burden without breaking down, and should have the following composition:—

Average Composition of Coke.

Carbon	90
Ash	7
Sulphur	1
Moisture	2
	100

In modern coke manufacture the primary object is to obtain the maximum quantity of suitable coke from the coal used, and to utilise as far as possible the useful constituents of the volatile matter driven out of the coal during the coking operation. To obtain the maximum yield the coking must be conducted in a chamber from which the air is excluded, and the old wasteful methods of coking in piles, kilns, and ovens into the interior of which air must be admitted to carry on the coking, are gradually giving way to the more scientific methods of modern practice. The first principle of coking is that the combustible volatile matter shall furnish the heat necessary to carry on the operation, and that this is more than sufficient will appear in the sequel. If it is to be burnt in the coking space then air must be admitted to burn it, and it is impossible to so

regulate the admission of air that none of the fixed carbon shall be burnt. Hence such a method must be wasteful. But there is no difficulty in burning the gases outside the coking chamber while still using the heat for coking, and so doing away with the necessity of admitting air into the chamber. A large number of coke ovens are based upon this principle, but a brief description of one of the most modern will suffice to make the method clear.

The Otto-Hoffman Coke Oven.—The coking chamber in this oven is rectangular in section, and is closed at both ends by tightly fitting doors, so as to exclude the air as completely as possible. The internal dimensions of the chamber are about 30 feet long, 2 feet wide, and 4 feet high. The walls are constructed of fire-brick, and have a number of vertical flues running through them which are connected with horizontal flues under the floor of the chamber. Along the top are three holes at regular intervals through which the crushed coal is charged. These are made air-tight while the coking is going on. Between these are two vertical pipes connected with horizontal pipes through which the volatile matter is drawn off from the chamber as fast as it is liberated from the coal. Below the floor level at each end of the coking chamber and in the foundation are two rectangular chambers lined with fire-bricks, and partly filled with a chequer work of fire-brick. These are the regenerators, and just above them are the mains for bringing back the combustible gas to the oven. The oven works continuously, and the walls of the chambers are always hot, so that directly a charge is introduced the coking commences. The volatile matter is drawn off through the mains to condensers and scrubbers by which the watery liquid containing ammonium compounds and the tar are separated. The gas then passes back to the oven, and enters a wide flue under the bottom of the chamber, where it mixes with hot air driven in through

the regenerator at that end by a fan. The flame and products of combustion from this burning gas then pass up the vertical flues in one wall over the top of the chamber and down through corresponding vertical flues in the other wall into another horizontal flue, from which they pass into the regenerator at the other end of the chamber, where they leave the greater part of their waste heat before escaping into an underground flue. Thus practically the whole of

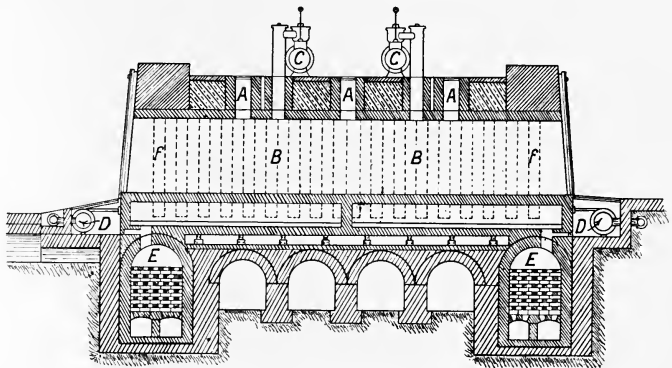

FIG. 3.—The Otto-Hoffman Coke Oven.

- | | |
|------------------------|-----------------------|
| A. Charging holes. | D. Gas mains, intake. |
| B. Coking chamber. | E. Regenerators. |
| C. Gas mains, outtake. | F. Vertical flues. |

the heat developed by the burning gas is kept in the oven to carry on the coking. When the regenerator has cooled down somewhat, due to the loss of the heat carried back into the oven by the air passing through it, the order of working is changed. The gas is cut off from the one end and turned on at the other, and the air is forced through the second regenerator, which has now been heated up by the waste heat. The course of the products of combustion is now just exactly the opposite of what it was before, and the cooled regenerator absorbs heat from the escaping

gases. This reversal takes place periodically, and is readily effected by an arrangement of valves connected with the air and gas passages. Several of these chambers are built in one block, and worked together. A block of sixty, with the necessary condensing plant, costs about £36,000 to construct.

When the coking is finished both doors are opened, a power ram is brought into contact with the mass of coke at one end, and it is pushed out bodily at the other. As it leaves the chamber water is squirted on it to prevent waste by oxidation. The empty chamber is re-charged at once, and the working continues. The doors are generally in two parts, so that the bottom portions may be closed and the top left open for spreading the incoming charge. See Fig. 3.

The salving of the tar and ammoniacal liquor considerably reduces the cost of coking, and pays for the erection of costly condensing apparatus on account of the value of these by-products. With a good coking coal the yield of coke amounts to 75 per cent. of the coal used. The coal is crushed, and often washed when it is desired to get rid of pyritic and earthy matter so as to reduce the percentage of ash and sulphur as much as possible. Some sulphur is removed during coking and quenching, but not all. So that coke always contains sulphur. The coke produced in these ovens is good, coherent material, and suitable for blast furnace work.

Gaseous Fuel.—The primitive process of burning solid fuel in an open grate, although very wasteful, still persists to a considerable extent; but the use of gaseous fuel for all purposes is increasing, and is a distinct advance both from the economical and hygienic point of view. As already pointed out, ordinary coal contains a considerable proportion of combustible volatile matter, which is driven out of the coal by heat alone, but it is also possible to convert nearly all the fixed carbon into combustible gas, and thus obtain

practically the whole of the heat-producing portion of the coal in the gaseous form. This is made clear by considering the chemical changes that take place in an open fire, and the way in which they can be modified. When a fresh supply of coal is thrown into the grate the heat from the burning of the fuel already there expels the volatile matter from the fresh fuel with the production of smoke and flame. A current of air entering the bottom of the grate passes through the fire and supplies the necessary oxygen to carry on the combustion of the carbon, upon which the development of heat depends. In the complete burning of the coke carbon dioxide is formed, thus :

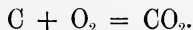

Now the whole of the oxygen is used up before the current of air reaches the top of the fire, and the deeper the layer of fuel the further the gases will have to travel before escaping from the top. The oxygen of the air is replaced by carbon dioxide, and this gas coming into contact with red-hot carbon loses part of its oxygen, and the combustible gas, carbon monoxide, is formed thus :

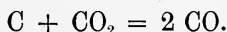

This gas burns with a blue flame over the top of the fire. The combustion taking place there is due to the current of air passing over the fire on its way to the chimney. Also, the water vapour, which is always present in the air passing into the fire, undergoes changes by which carbon monoxide, hydrogen, and marsh gas are formed thus :

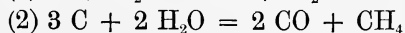
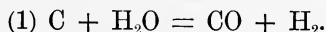

The change represented in (2) takes place to a much smaller extent than that represented by (1). Now the reactions by which carbon monoxide alone is formed are *exothermic*, or heat producing, but those in which water is decomposed by

carbon are *endothermic*, or heat absorbing, and unless sufficient heat is developed by the other reactions to keep the carbon above a limiting temperature, the decomposition of water vapour ceases.

It is clear that if the upper current of air is entirely cut off by closing the top of the grate, the combustible gas formed by the coking, together with that formed in the interior of the fire, must pass up the flue unburnt, and could be drawn off to be burnt in any convenient place. Combustible gaseous matter obtained in this way is known as "producer gas," and in making it the aim should be to so regulate the proportions of air and water vapour as to get as large a proportion of carbon monoxide and hydrogen, and as small a proportion of carbon dioxide as possible. It seems, however, that a certain proportion of this gas must be formed in order to keep up the necessary temperature.

As the nitrogen of the air cannot be excluded, this gas is always present in large quantity. An average composition for producer gas may be given as follows, but this may vary considerably with the kind of apparatus used, and with the mode of working it :

Producer Gas	{	Nitrogen, N ₂ . . . 55	} Non-combustible,
		Carbon Dioxide, CO ₂ . . 5	
		Carbon Monoxide, CO . . 25	} Combustible, 40%
		Hydrogen, H ₂ . . . 10	
		Hydrocarbons 5	

It is well known that a large excess of steam may be used under proper conditions, but in that case more of the carbon is converted into carbon dioxide. This is shown by the equation :

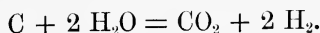

And this is the chief reaction used in the production of "Mond gas," which contains :

Mond Gas	{	Nitrogen, N ₂ 43	} Non-combustible,	
		Carbon Dioxide, CO ₂ . 17		60%
		Carbon Monoxide, CO 11		} Combustible, 40%
		Hydrogen, H ₂ 27		
		Hydrocarbons 2		

As this gas contains a smaller proportion of the poisonous carbon monoxide, it is much safer to use by the inexperienced or careless, and will no doubt be largely used in the future.

On the other hand, when steam is blown through very hot coke, the issuing gas is almost entirely a mixture of carbon monoxide and hydrogen, and is known as "water gas." But the production of this gas is intermittent, for the reaction is endothermic, and the coke cools rapidly under the action of the steam. This difficulty is got over by cutting off the steam, and blowing air through at intervals to heat up the coke.

Water Gas	{	Nitrogen, N ₂ 3	} Non-combustible,
		Carbon Dioxide, CO ₂ . 4	
		Carbon Monoxide, CO 52	} Combustible, 93%
		Hydrogen, H ₂ 41	

There are numerous forms of producer, as the apparatus is called, all of which have points in their favour ; but the names of Siemens and Wilson will always stand out in connection with the pioneer work in the use of gaseous fuel. It will, however, be better to describe one of the more recent forms of producers in order to make clear the general principles as they are applied now.

One of the principal difficulties in the working of a producer plant which is not constructed to salve the by-products is caused by the accumulation of tar in the

gas mains. This not only makes the working less satisfactory, but also causes waste of combustible matter, and recent developments have been in the direction of preventing this waste. Another difficulty met with in the early working was the removal of the ashes, and in the first form of the Wilson producer the working had to be stopped periodically to enable the "clinker" to be removed. This has now been got over entirely by the use of a water bottom, through which the ashes can be removed without interfering with the working. In one form an ash discharger, in the form of an inclined screw, in addition to the water bottom, is used; the screw forms the bottom of the receptacle into which the ashes fall from the grate bars, and as they collect in the spaces between the threads the motion of the screw works them forward to the discharge hole below the level of the water seal. The modern producer may be worked continuously until it is stopped for repairs.

The use of caking coal in the producer tends to the formation of a dense solid mass of coke, which prevents the proper penetration of the gaseous current, and the working is unsatisfactory. This difficulty is got over, in one producer at least, by the introduction of a mechanical arrangement for breaking up the coke, and so preventing it clotting into a solid mass. A free burning coal always gives good results.

The original Siemens producer was simply a deep grate with a closed top, limited bar space, and an open ash pit. It was then modified by closing the ash pit and blowing steam into it, by which the changes shown in equations 1 and 2, p. 36, are increased. It has been further modified by forming a partition between the hopper and the gas port, and below the level of the charge, by which the volatile matter driven out of the fresh coal by the heat of the charge below is forced back under its own pressure through the glowing fuel. In this way much of the tar is split up

into gaseous compounds, and water vapour is decomposed, so that the trouble due to tar and water collecting in the mains is reduced, and the gas enriched.

The original Wilson producer consisted of a closed cylindrical chamber with an arrangement at the bottom for forcing in air by a steam jet blower, by which the proportion of steam to air could be regulated. This has been modified by

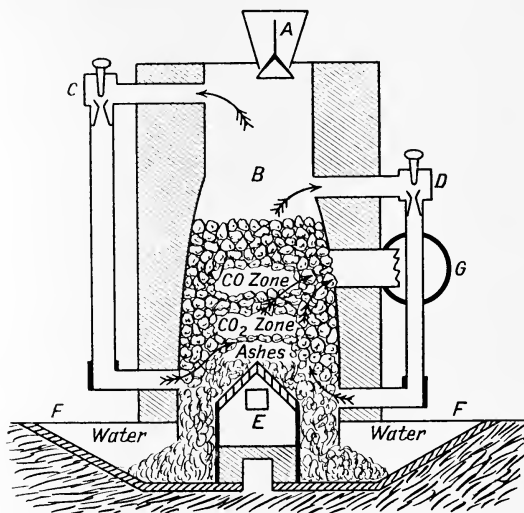

FIG. 4.—The Duff-Whitfield producer.

carrying off the gases from below the surface of the charge, thus causing the volatile products from fresh coal to be driven back through a hot layer of the charge to decompose the tar and water. It has also been further modified by the introduction of a water bottom in place of the old solid bottom, and with mechanical means of removing the ashes.

The *Duff-Whitfield*, producer shown in vertical section in Fig. 4, embodies most of these improvements, and may be

taken as a modern type. It is iron-clad, and lined with refractory brickwork. The horizontal section is rectangular. The fuel is charged through the hopper, A, by filling it, closing the top, and then lowering the conical bottom for the charge to drop into the body, B, which is thus kept nearly full. The heat of the producer cokes the fresh coal, and the volatile matter from it is drawn off by the steam jet, C, and forced into the hot mass below; while a similar action is effected lower down by the steam jet, D. A regulated quantity of air blown in through E, passes upwards through the sloping grate bars, and furnishes the oxygen for carrying on the production. The ashes are largely directed outwards by the sloping grate, and fall to the bottom of the water seal, F, from which they can be readily removed without interfering with the working. The producer gas is drawn into the gas main G, through which it passes to the furnace. The general temperature of the gas as it leaves the producer is about 500°C.; and the volume of gas formed is about 150,000 cubic feet per ton of coal used.

When producer gas is to be used in the cylinders of gas engines, in the place of coal gas, it must be made more carefully, and from good quality fuel. It must also be "cleaned" after it comes from the producer, and for this purpose a wet scrubber and a sawdust scrubber are required. Also a gas holder for storing the gas is necessary. These requirements have led to the modifications of the producer when used for gas engine work, and what is known as the *suction gas producer* is making much headway. The principal modification is to make the engine itself regulate the quantity of air and steam drawn through the producer, and therefore the quantity of gas formed. Thus an increase in the load on the engine causes more gas to be made and drawn into the cylinder. No gasholder is required, and the cleaning is effected by a wet scrubber.

An evaporator, in which water is kept at a constant level, surrounds the body of the producer, and absorbs heat from it, by which the water is raised nearly to boiling. The supply of air is drawn through this chamber and over the hot water from which steam rises and mingles with the air. The mixture is then drawn down and through the closed ash pit into the producer to generate the gas. Anthracite, or coke, is the best fuel for clean working. "Suction" gas is very similar in composition to good producer gas, and the plant is being used to work engines up to 75 h.-p. But this limit will be extended in the near future.

Mond Gas.—An important point in the making of Mond gas is in the salving of the by-products, especially ammonia. This is effected by using an excess of steam, so as to keep the temperature as low as possible consistent with continuous working, and so prevent the ammonia from being decomposed as it is in ordinary producer working. The usual condensing and scrubbing plant is used in connection with this producer. The hot gas from the producer passes through a series of channels on its way to the recovery plant, and heats their walls. The air and steam on their way to the producer are driven through a second series of channels, in which they come into contact with the outer walls of the first series, absorb heat from them, and carry it back to the producer. This allows of a much larger proportion of steam than usual being used. The gas is cleaner and less poisonous than the ordinary gas, and should come into use for domestic purposes.

Water Gas.—The most economical method of producing water gas is due to Messrs. Dellwik and Fleischer, and depends on the fact that if the air is rushed through, even a deep layer of red-hot coke, the carbon is rapidly and completely burnt with the production of a very high temperature throughout the mass. Very little carbon monoxide is formed,

for there is excess of oxygen everywhere throughout the layer. If, then, the air blast is cut off and steam turned on, the changes already described will take place, and water gas will be formed; but this soon brings down the temperature of the hot coke, and in a short time the steam must be cut off and the air rushed through again. Air is blown through the producer for one minute and steam for eight minutes alternately. The burnt gas passes away into a chimney, and the water gas is drawn off for use.

REFRACTORY MATERIALS.

Refractory materials used for metallurgical purposes may be defined as bodies that can be exposed to the furnace temperatures for which they are to be used without softening or disintegration. The well-known compound *silica* in any of its fairly pure natural forms is a very refractory body, and may be exposed to the furnace temperatures produced by the combustion of ordinary fuel in air without softening. It will withstand a clear white heat. The form very suitable for refractory purposes is quartz when it occurs as a pure sand, sandstone, or quartzose rock, which often contains upwards of 98 per cent. of silica, SiO_2 .

Silica (p. 8) is an acid-forming oxide, and when heated in contact with basic oxides unites with them to form silicates that are invariably more fusible than the silica itself; but the actual fusibility of these bodies depends upon the nature and proportion of the basic oxide present. Thus, given silica and a basic oxide, there is one proportion between them that has a higher fusing point than any other, and the addition of either one or other of the oxides, within limits, lowers the fusing point of the mass. If another basic oxide is added the fusibility is still further increased, and it may be taken as a general statement that complex silicates are more fusible than simple ones of the same general character. The range of fusibility for silicates

is a very wide one. The most fusible are those containing potash, K_2O , and soda, Na_2O , and the least fusible those containing alumina, Al_2O_3 .

A system of naming silicates that has been largely adopted by metallurgists depends upon the proportion between the number of atoms of oxygen in the acid and basic portions of the silicate. Clearly this is based upon the assumption, strongly supported, that a silicate is a combination of two or more oxides, one of which is always silica. When the proportion is 1 : 1 it denotes a monosilicate, 1 : 2 a bisilicate, 1 : 3 a trisilicate, 2 : 3 a sesquisilicate, and 2 : 1 a subsilicate. These relations are shown in the following table, in which they are illustrated by the silicates of lime and alumina :

Ratio of number of atoms of oxygen in basic oxide to number of atoms of oxygen in acid oxide.	1 : 1	Mono	$2CaO.SiO_2$	$2Al_2O_3.3SiO_2$
	1 : 2	Bi	$CaO.SiO_2$	$Al_2O_3.3SiO_2$
	1 : 3	Tri	$2CaO.3SiO_2$	$2Al_2O_3.9SiO_2$
	2 : 3	Sesqui	$4CaO.3SiO_2$	$4Al_2O_3.9SiO_2$
	2 : 1	Sub	$4CaO.SiO_2$	$4Al_2O_3.3SiO_2$

Experiments made at ordinary assay furnace temperatures show that among the silicates of lime the monosilicate is the least fusible and the bisilicate the most fusible, while the silicates of alumina are infusible, although the bisilicate shows signs of softening at a very high temperature. Small quantities of other bases render them more fusible.

Clay.—The principal constituent of this abundant rock is the monosilicate of alumina combined with water. Clay beds are made up of very fine particles formed by the disintegration of silicate rocks by the combined action of air and water, and then deposited as a sediment similar to other sedimentary rocks. Very often the clay is contaminated with oxide of iron, lime, potash, and soda, in which case it is useless for refractory purposes. But a clay

associated with the coal measures, and usually containing an excess of silica, with only small quantities of other oxides, is very refractory in character, and is known as *fireclay*. Its composition may be represented generally by the formula $x\text{SiO}_2.2\text{Al}_2\text{O}_3.3\text{SiO}_2.2\text{H}_2\text{O}$, where $x\text{SiO}_2$ represents a variable proportion of the acid oxide. This clay, in common with other clays, enjoys the property of *plasticity* by which it can be moulded into shape after being made into a stiff paste with water. When heated to a red heat the combined water is driven off, and the clay is "burnt," after which it is no longer plastic. Considerable shrinkage takes place on burning, and to counteract this, clay already burnt is mixed with the raw clay for making bricks, crucibles, &c. The common mixture is 2 parts of raw clay to 1 part of burnt clay, which usually consists of old bricks and pots cleaned and ground up for the purpose.

The sandstones are not sufficiently plastic when mixed with water, although they usually contain a small proportion of clay in admixture with the silica. The material could be moulded, but when dried and burnt would break down too readily. In this case, when used for making very refractory silica bricks, a small proportion of fireclay is added, or the ground material is mixed with milk of lime sufficient to carry in about 1 per cent. of the oxide. When moulded and burnt such bricks are somewhat friable, but the lime fluxes with a small quantity of the silica and forms a cement which holds the particles of silica together, and makes the brick coherent. The following table on p. 46 shows the composition of various clays, sandstones, and sands suitable for furnace building and working :

It will be noticed that the examples of fireclays given contain varying proportions of silica, and when the silica runs high it is not necessarily all in combination ; part of it may be in the form of sand, and can be separated by careful washing from the homogeneous clay. Fireclays rich in silica

are acid in character, but when the ratio of silica to alumina approaches 9 : 10, which is roughly the composition of the monosilicate, they are regarded as neutral material. White Cornish clay (Kaolin) is the nearest approach to the neutral composition.

Ganister is sufficiently binding to be used for some pur-

Constituents.	Fireclays.			Silica Rocks.		
	Stourbridge, Worcestershire.	French.	Stammington, Yorkshire.	Dinas Rock, Vale of Niah.	Ganister.	Sandstone.
Silica, SiO ₂	65·10	63·57	48·04	98·31	94·6	98·51
Alumina, Al ₂ O ₃	22·22	27·45	34·47	0·72	1·4	0·51
Ferric Oxide, Fe ₂ O ₃		0·15	3·05	0·18	0·9	0·07
Ferrous Oxide, FeO.	1·92					
Lime, CaO	0·14	0·55	0·66	0·22	0·5	0·13
Magnesia, MgO	0·18		0·45		0·2	0·06
Alkalies, Na ₂ O, K ₂ O	0·18			0·14	0·1	0·33
Water, H ₂ O	9·86	9·91	11·15	0·50	2·7	

poses without admixture, as it contains from 2 to 3 per cent. of clay.

The other oxides present vary from 2 to 4 per cent. They are all fluxing in character, and the alkalies are the most injurious.

Basic Materials.—The term basic as applied to refractory materials implies that these bodies contain basic oxides, that is, oxides which react with acids to form salts. The principal basic oxides of a refractory character are lime, magnesia, and alumina. Lime and magnesia are not found in the free state. They are combined principally with carbon dioxide in carbonates, with silica in silicates, and with sulphuric oxide in sulphates. Gypsum is the well-known sulphate of lime, and Epsom salts is sulphate of magnesia.

Carbon dioxide can be driven off by calcining the carbonates at a red heat, so that there is no difficulty in obtaining the basic oxides in the free state.

Limestone is one of the commonest rocks in the earth's crust, and is found in huge masses among the rocks belonging to the carboniferous period. Carbonate of lime CaO.CO_2 , is the principal constituent of limestone, marble and chalk. The difference in the physical properties of these bodies is due to the manner in which they were deposited, and to the difference in the temperature conditions to which they were exposed through long periods of time. What the metallurgist has to consider is the nature and proportions of the impurities present. When limestone is strongly heated it is decomposed thus :

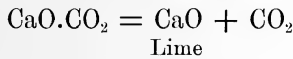

Dolomite, or magnesian limestone, is a rock containing carbonates of lime and magnesia. When these are present in molecular proportions the composition may be represented thus: CaO.MgO.2CO_2 . The proportions of the two carbonates, however, vary somewhat in different samples. Dolomite does not occur to anything like the same extent as limestone, but it is found in sufficient quantities to form a very useful refractory material. When strongly heated it is decomposed as follows :

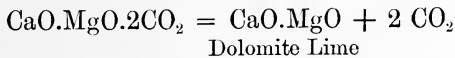

Magnesite.—This rock, which is not widely distributed, is nearly pure carbonate of magnesia, MgO.CO_2 . When strongly heated magnesia is obtained thus :

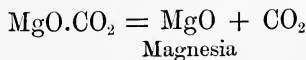

It is a very valuable, but expensive, refractory material.

Bauxite. The principal constituents of bauxite are ferric oxide and alumina. It may be regarded either as an iron ore or as a flux, and is also largely used in the extraction of aluminium. It is white to whitish brown in colour, friable, and refractory. The chief sources of supply in Europe are France and Ireland.

The following table gives the general composition of the commoner basic materials, and will serve as a guide :

	Limestone.	Dolomite.	Magnesite.	Bauxite.
Lime, CaO	54·82	34·2	1·8	—
Magnesia, MgO	0·22	19·8	42·7	—
Alumina, Al ₂ O ₃	} 0·22	} 1·4	} 4·7	52·0
Ferric Oxide, Fe ₂ O ₃				27·6
Carbon Dioxide, CO ₂	43·07	43·4	50·0	—
Silica, SiO ₂	0·36	1·2	1·0	—
Alkalies, Na ₂ O, K ₂ O	0·14	—	—	—
Water, H ₂ O	0·26	—	—	20·4

Neutral Materials.—Bodies that are refractory in character and also indifferent to the fluxing action of either basic or acid-forming oxides are termed neutral materials. Fireclay, approximating to the monosilicate in composition, is usually regarded as neutral material, although it does not resist fluxing action very well.

Graphite, or plumbago, is a natural crystalline form of carbon produced by the metamorphosis of vegetable matter. It is found associated with the oldest rocks, and seems to have gone a stage further than anthracite, as it contains no gaseous matter. It practically consists of carbon and ash-forming matter, which varies considerably in different samples. It is not as widely distributed as coal, but considerable deposits are found in different parts of the world. A rich deposit existed in Cumberland, but is now largely worked out. The most abundant supplies at present come

from Ceylon, America, Siberia, and Styria. It is also an artificial product of the electric furnace, and is then prepared from anthracite. Its principal use as a refractory material is in the manufacture of plumbago crucibles, the best of which contain about 30 per cent. of the prepared graphite together with the usual clay mixture. It is absolutely infusible at the highest furnace temperature, and if excluded from the air is indestructible. The following examples will give an idea of the variations in the composition of the natural material:—

Styrian graphite, carbon 79 per cent. ; ash 21 per cent.

Ceylon graphite, carbon 90 per cent. ; ash 10 per cent.

Chrome Iron Ore, or chromite, is the most abundant ore of the useful metal chromium, and is found in Scotland, France, Germany, Greece, Russia, and America. The principal compounds present are oxides of iron and chromium. It is a dark coloured, heavy, hard, refractory stone, and is represented by the formula $\text{FeO} \cdot \text{Cr}_2\text{O}_3$. It is infusible at ordinary furnace temperatures, and is used to a limited extent as a refractory material, but much more as an ore of the metal chromium.

Ores of Rare Metals.—The rare metals tungsten, molybdenum and vanadium have come into use in some branches of steel manufacture, and a short description of their sources of supply will be found useful.

Wolframite is the chief ore of tungsten, and is usually found associated with tin ore, from which it is readily separated. It is a compound of the acid-forming oxide of tungsten with ferrous oxide, and has the formula $\text{FeO} \cdot \text{WO}_3$. The ferrous oxide is sometimes partly replaced by manganous oxide, MnO .

Molybdenite, the chief ore of molybdenum, contains the metal as the disulphide, MoS_2 , which is easily converted into the oxide by a simple roasting in the presence of air. It is found in Bohemia and Sweden.

Vanadinite is the important ore of vanadium, and is a chloro-vanadinate of lead. It is found in Europe principally in Spain, in Arizona, and Mexico. The metal is also present as oxide in some sandstones, and in this way is somewhat widely distributed. The vanadiferous sandstones of America are the most important. The ash obtained by burning the anthracite from the Yauli deposits in Peru is very rich in vanadium, and will probably be used as a source of the metal, but at present the deposits are somewhat inaccessible.

All these metals form acid oxides, and they are concentrated as such by fusing the concentrated ores with carbonate of soda (Na_2CO_3) and coal. The oxides are thus converted into soluble soda compounds, and can then be dissolved out of the insoluble matter. They are separated as oxides from their solutions by combining the soda with a stronger acid, such as sulphuric acid, and are then in a good condition for the extraction of the metals.

CHAPTER III.

PRIMITIVE METHODS OF IRON AND STEEL PRODUCTION.

Historical.—The most ancient method for the extraction of iron from its ores and adapting it to the use of man originated, without doubt, in the East; and India was most probably the seat of this primitive manufacturing process. It has been remarked that by the artificial production of fire primitive man passed the barrier which now exists between the human race and the rest of the animal kingdom, and it is certain that when he could use this source of power with intelligence the extraction of the common metals, among them iron, became possible. But when and where the possibility became an accomplished fact is lost in the mists of time, for the faculty of doing things was no doubt antecedent to that of recording them.

In order to follow the working of these primitive processes it is necessary to understand the principles upon which they depend. Red hæmatite and magnetite are the purest ores of iron, and as they often outcrop, they are easily accessible. The gangue is siliceous, so that to obtain the iron in the metallic state the oxygen must be removed from its chemical combination with the iron, and the silica from its mechanical mixture with the reduced metal. Either carbon or carbon monoxide will combine with the oxygen at a red heat. For a piece of red hæmatite, when imbedded in red-hot charcoal, has its iron set free; but the silica is still intermixed with the reduced metal, and renders it useless. If, however, the temperature is increased, part of the iron compound is first reduced to ferrous oxide, which unites with the silica to

form a fusible compound; at the proper temperature the whole mass becomes pasty, and part of the fluid cinder drips out. If then the spongy mass is well hammered, the fluid matter still remaining is squeezed out, and the pasty metal obtained as a compact malleable mass. The changes taking place are expressed by the equations—

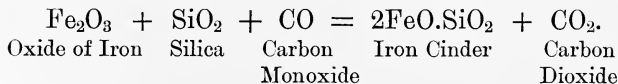
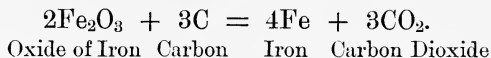
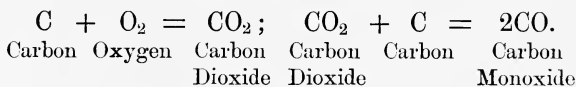

It is thus seen that the changes are simple in character, and not at all difficult to control; and it is easy to picture a primitive man in some iron-bearing district using lumps of iron ore for his fire stones, and after an unusually brisk fire finding a pasty lump of metal from which the cinder had dripped out. He, like his modern representative, being of an inquisitive turn of mind, would hammer it with his flint hammer, and, finding it pliable, would be led to further trials, ending in the discovery of the method of extracting iron from its ore. Now, such a discovery would fill several pages in the proceedings of some learned society; then, it was probably registered by a few gashes on the nearest tree trunk.

Iron Manufacture in India.—Large deposits of easily reducible ores occur in many of the hilly districts of India; and the Hindoos have always been notable workers in iron. The extraction of the metal was, however, almost entirely carried on by hill tribes of low caste; and it is difficult to conceive of any simpler smelting process than that still in operation among them—a process which, with very little

modification, has been in existence for several thousand years. The piling of stones round and above the surface of the fire to form a rough shaft or chimney would soon come into use as the increased briskness of the fire due to the increased draught was noticed; also the increased heat of the fire after the wood had charred would lead to the use

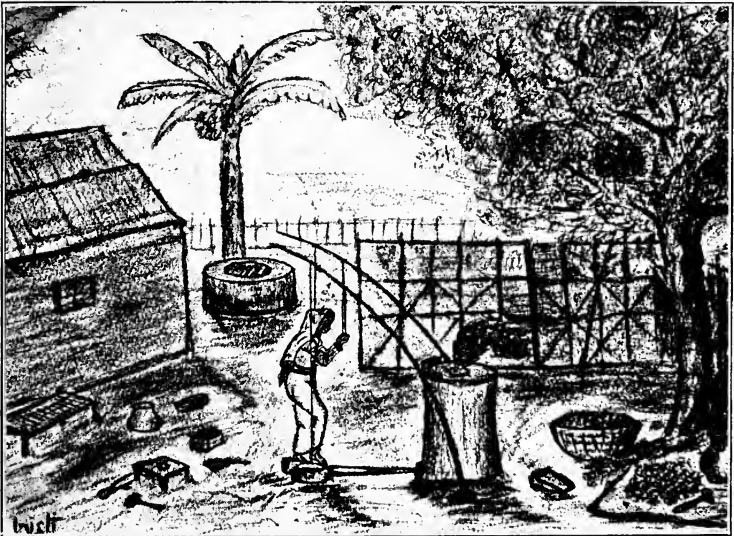

FIG. 5.—Iron Smelting in India.

of charcoal for special purposes. And so all the essentials for successful working would be obtained. Then the use of a more rapid current of air, obtained either by natural means or by blowing, would come into operation, and more rapid working would result.

The smelting furnace may be described as a circular shaft built of refractory stone, and daubed over with clay to make it airtight; or it is made entirely of fireclay

plastered inside a frame of stakes driven into the ground to act as a support for the clay until it sets. Such a furnace has an internal diameter of one or two feet, being a little narrower at the top, and a height of four feet. A hole at the bottom serves to run off the liquid cinder, and another a little higher up for the introduction of the blast pipe, a bamboo tube, to convey the blast from a pair of primitive bellows made of goat skin or buffalo hide.

Fig. 5 is the reproduction of a sketch of a native iron-works at Nania Bathan, made on the spot by Mr. I. E. Lester as recently as 1897.

The ore and charcoal are put in through the top of the furnace, and the fire urged for several hours; the pasty mass of iron, wet with the liquid cinder, is lifted out through the top. It is then hammered while still hot to squeeze out the greater part of the cinder and to obtain the metal in a solid lump. Such lumps of malleable iron, weighing from five to thirty pounds, were, and are still, the finished products of these primitive ironworks. They are sold to artificers, who fashion them into various shapes. The cinder is collected in heaps and left as waste, and deposits in various parts of the country show that the workers have wandered from place to place in search of ore and fuel. As a matter of fact, the native worker takes as little trouble as possible in procuring his materials, and will only work those portions of the outcrop that have weathered and broken down into small pieces. He will not trouble to mine and crush the ore, and so moves on until he finds a deposit of suitable ore and wood for charcoal.

When a narrow ravine, through which the wind blows in a fairly constant direction, is available a furnace is erected at its head, and the natural draught through the ravine made to take the place of bellows.

The Hindoos also employed a primitive method for the conversion of iron into steel, viz., by melting small charges

of iron mixed with wood and leaves, and thus produced excellent steel from which weapons and cutting tools were made.

The Assyrians and Egyptians, and probably the Jews, obtained their iron from India at a very early period; later the Greeks and Romans received supplies of the metal from the Chalybes, a tribe living and working on the south coast of the Black Sea.

As the process migrated westward it was improved by the greater energy of the Western races. The Etruscans mined the hæmatite ore of Elba, and extracted the metal by a process similar to that still in use in some remote districts of the Pyrenees.

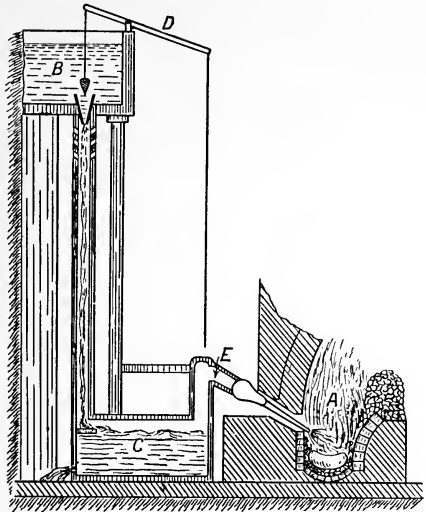

FIG. 6.—The Catalan Forge.

The Catalan Process.—This method takes its name from the province of Catalonia. The furnace used is an open hearth built of rough masonry, and is shown in Fig. 6. The bottom and back of the hearth A are formed of sandstone blocks, and the two sides are lined with iron slabs. The front or working side consists of two iron plates, the lower one of which is perforated by a tap hole for running off the molten cinder, whilst the upper one is used to support the bar required in the manipulation of the charge. The blast is supplied by a trompe worked by the water

from a mountain stream. The upper cistern B is connected with the lower cistern C by wooden pipes, about 15 feet long, the tops of which are perforated by air-holes inclined downwards; the outlet from B is fitted with a conical valve worked by the lever D. The cistern C has a closed top, and an outlet at the bottom; it thus forms an air-chest connected directly with the copper blast-pipe, or twyer, E. When water is allowed to fall through the pipe from B it draws in air through the air channels at the top, carries it down into the chest below, and forces it through the blast pipe into the hearth. The strength of the blast is regulated by raising and lowering the valve. Sometimes two air pipes are used for better control of the blast. The whole arrangement is usually built on a hillside.

In working the process, charcoal is thrown into the hot hearth, and moved up to the twyer side; then iron ore is introduced, and the whole covered with moistened charcoal dust and small ore. The blast is then partially turned on, and the full charge of ore gradually added. In two hours the hearth is in full blast, and the charge is being worked from the side towards the twyer. The molten cinder is tapped away at intervals, and in about four hours the reduction is complete. The bloom, as the mass of pasty iron is called, weighing about 300 pounds, is broken up into smaller blooms, which are then taken to the hammer and thoroughly hammered to squeeze out the molten cinder as far as possible, and form the metal into rough bars. These bars are re-heated and hammered to render them more homogeneous. The cinder, which contains upwards of 50 per cent. of iron, is a waste product as far as this method is concerned.

The conditions in the furnace are favourable to the formation of carbon monoxide, and this gas, in conjunction with the charcoal, reduces the oxide of iron partly to the metallic state and partly to ferrous oxide, which unites with the silica

to form the cinder (*see* p. 52). The twyer is inclined so as to blow into the hearth, and exert a refining action. The inclination of the twyer is decreased, so that it may blow more across the hearth than into it, when steel is to be produced. This is assisted by tapping the cinder away at more frequent intervals, so that the metal is more exposed to the hot charcoal and absorbs carbon from it. Much of the iron and steel used by the Spaniards in the zenith of their power came from this source.

The American Bloomery.—According to Howe, a hearth called a bloomery is still in use in America to work up a pulverised and washed ore of good quality, using charcoal as fuel. The hearth is nearly square, in horizontal section, and is about two feet wide and one foot deep below the twyer; it is formed of cast-iron plates, two of which, the bottom plate and the back plate through which the twyer enters, are hollow for the circulation of water to keep them cool. These hearths are usually built in ranges on each side of a quadrangular mass of brickwork, and above each hearth is a heating chamber into which the hot gases from the hearth pass, and in which is a coil of iron pipe for heating the blast to about 250°C. Charcoal and ore are added to the hearth at intervals, and a loup of metal some 300 pounds in weight is produced and removed every three hours. It is brought in front of the twyer to be further heated before it is taken to the hammer to be worked up into a bloom. The cinder is tapped at intervals through a tap hole in the front of the hearth.

In other parts of Europe the early furnaces were deeper than the Catalan forge, and more of the shaft form. They finally culminated in the *high bloomery*, a furnace of some 10 to 15 feet in height, and 4 to 6 feet internal diameter in the middle, but narrower towards the top and bottom. It was built of rough masonry, and had an arched opening at the bottom which was loosely bricked up during the

working of a charge. The blast was supplied by two twyers. The charge, consisting of ore and charcoal, was added a little at a time through the top of the furnace until the full charge had worked down, and the bloom of metal formed in the hearth. The loose bricks were then taken out and the bloom removed through the opening thus made. There was a tap hole at the bottom of the hearth through which the cinder drained away. The general

form of the furnace is shown in Fig. 7.

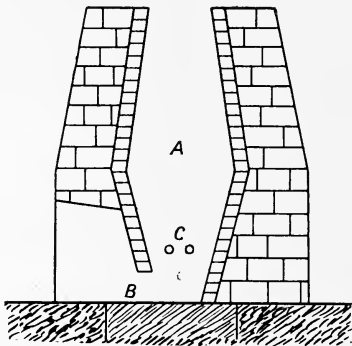

FIG. 7.—The High Bloomery.
A, Shaft. B, Arch. C, Twyer holes.

In shallow hearths the spongy metal soon found its way to the bottom, and was protected from the action of the carbon by the fluid cinder, which also exerted a refining action by removing carbon already absorbed by the metal. But in the tall bloomeries the iron was longer in contact with the charcoal and absorbed

more carbon, thus becoming steely in character. The first sample of cast iron was no doubt an accidental product of one of these furnaces when working under such conditions that more than 2 per cent. of carbon was absorbed, and the temperature rose high enough to melt the metal.

The Osmund Furnace, which comes between the shallow hearth and the high bloomery, was in use in the North of Europe for many centuries, and is probably still to be found in remote districts. It is a small shaft furnace worked by a single twyer, and was extensively used to reduce the bog ore dredged from the shallow lakes and rivers of the district. The ore, which is a brown hæmatite,

was air-dried, mixed with wood fuel and calcined in heaps. It was then smelted with charcoal for the production of a spongy mass of iron called an osmund, from which the furnace takes its name. The ore is somewhat rich in phosphates, but the metal produced was fairly free from phosphorus on account of the refining action of the very fluid, highly basic cinder formed in the operation. A tap-hole was provided for the cinder, and the front of the furnace had to be taken down to remove the osmund.

The Husgafvel Furnace.—The chief drawback to the working of the Osmund furnace is that it has to be practically blown out after each charge, and the furnace partially removed and replaced before a fresh charge can be introduced. This means waste of time, labour, and fuel, and in 1875 Husgafvel commenced to experiment in the direction of larger furnaces, more rapid removal of the metal sponge, and larger outputs. The outcome of this is a furnace which may be described as a modern high bloomery. The shaft of this furnace is formed of a double casing with a space between, through which a spiral partition runs from the top to the bottom, thus converting the space into a spiral pipe through which air is blown to furnish the blast. The blast is thus heated to about 200° C., and is regulated by dampers placed at intervals in the spiral space. The shaft and the charge are thus cooled while the air is being heated. The hearth is movable, and is supported on trunnions fixed to a bogie carriage which can be run in and out from the shaft. It is supported on a platform directly under the shaft, which can be raised and lowered by a hydraulic ram. The joint between the hearth and the shaft is luted round with clay when the former is in position. There are four tap-holes one above another in the side of the hearth, through which the slag can be tapped at different levels. There are also four twyers which blow into the hearth in pairs at different levels, the

lower pair being in blast at the beginning of the operation, and the upper pair when much metal has collected in the hearth. The slag is tapped off so as to keep the metal just covered. Owing to the shaft being kept comparatively

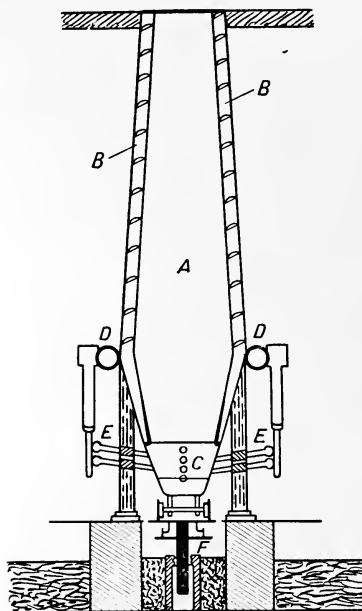

FIG. 8.—The Husgafvel Furnace.

- | | |
|------------------|---------------------|
| A, Shaft. | D, Blast main. |
| B, Spiral space. | E, Tuyers. |
| C, Hearth. | F, Hydraulic table. |

cool the reduction takes place very largely in the lower part of the furnace, and the metal does not remain long in contact with the charcoal, so that not much carbon is taken up, and even this is in part removed by the oxidising character of the blast from the inclined tuyers, and the fluid cinder. The charge is composed of prepared bog ore in small pieces, rich cinder, and charcoal, and is fed in at the top. When the bloom has collected the hearth is run away and another run in from the opposite side. The cinder is drained away and the bloom removed by rotating the hearth on the trunnions and tipping it out. (See Fig. 8.)

The slag rarely contains more than 18 per cent. of iron, with the softest iron produced, and with hard irons may run as low as 7 per cent., so that other bases must be present in the ores, and as rich cinder is used this also forms a source of iron. The ores are phosphoric, but if the cinder is kept basic the greater part of the phosphorus

is found in it, and at the same time the metal is comparatively free from carbon; this is effected by inclining the twyers so as to blow more into the hearth. This is general in direct methods, for the passage of much carbon into the iron is coincident with passage of phosphorus into the metal when the ores contain phosphates. Thus the more perfectly the metal is separated from the ore, and the smaller the quantity of it that passes into the cinder, the more impure and unworkable it is, so that, unless very pure ore such as magnetite is used, the metal must be further treated for the elimination of the impurities, and the basic open hearth, which will be described fully later, has been used in conjunction with the Husgafvel furnace.

Many attempts have been made during the last sixty years to produce iron by direct processes, and if they have failed it is not because the men who took them in hand lacked either energy, knowledge, or capital, but that the output is so small relatively that it is only under very exceptional conditions that such processes can be made to pay.

Thus in the *Chenot Process* a sponge of iron sufficiently soft to be cut with a knife was produced. The furnace used in the process took the form of two vertical retorts about 28 feet high, 6 feet long, and 18 inches wide, built side by side, and surrounded by a firebrick case furnished with the necessary flues and grate for heating the lower portions of the retorts externally by the combustion of solid fuel. A rich and pure ore broken into small pieces and mixed with charcoal was charged into the retorts. Thirty cwts. of calcined ore, 10 cwts. of charcoal, and 26 cwts. of coal for the external firing were used for the production of a sponge weighing about 12 cwts. About six days elapsed from the commencement of the firing before the sponge was ready for removal. The metal was so finely divided that even when only moderately warm it would

take fire on exposure to the atmosphere, and form oxide of iron again. A rectangular iron cooler at the bottom of each retort was used to prevent the metal from coming into contact with the air until sufficiently cooled. The sponge could be compressed when cold, reheated, and hammered or rolled into bars.

The process was not a commercial success, and even the *Blair Process*, an American modification of it, has been abandoned. Blair's furnace consisted of a group of three vertical cylindrical retorts four feet wide and forty feet high, each having a brickwork casing lined with firebricks so as to form a combustion space round the retort. The outside of the retort was heated by burning producer gas in this combustion space, and as the external heat did not penetrate to the centre of the charge it was assisted by a jet of burning gas driven down the centre of the retort by a blowpipe arrangement fixed in the top of each. A water-jacketed iron cooler was arranged at the bottom of the retort to receive the sponge before its final removal to be worked up. In spite of several modifications in which advantage of gas firing and regeneration was taken, the process did not prove a commercial success.

The *Siemens Rotator Method* should also be noted as a somewhat recent attempt to create a modern direct process for the extraction of iron. It was used to some extent both in England and in America, but was unable to compete with advances in other directions. It comprised the regenerative system of Siemens, which has been already referred to in connection with fuel and will be more fully dealt with later, and the rotating cylinder of Danks. The reduction chamber consists of an iron cylinder lined with refractory bricks made from bauxite mixed with a little clay and plumbago. It could be rotated on a horizontal axis by the necessary gearing, and was so arranged with respect to the producer and the regenerators that the

flame from the combustion of the producer gas could pass right through it and into a movable flue at the other end. The fire bridge end of the cylinder was protected by the circulation of water through it, as also were three ribs projecting above the lining at right angles to the axis of the cylinder. These were used for the separation of the charge into three portions at the end of the operation. The ore was reduced by coal assisted by the rotation of the cylinder, which produced thorough mixture, and a little lime was added to prevent the too rapid corrosion of the lining. A fluid cinder of basic character was tapped away, and the reduced metal collected into three sponges by the protruding ribs. The sponges were removed from the flue end of the cylinder by pushing aside the movable flue, and passed on to the forge to be worked up into bars.

Iron Manufacture in Africa.—Sir Lothian Bell, in his work on “Iron and Steel,” states that Colonel Grant furnished him with a sketch of a primitive forge which he had seen at work in the interior of Africa. It was apparently a hole in the ground supplied with ore and charcoal, and the fire urged by the blast from a pair of primitive bellows worked by two natives. The smelting charge of crushed ore and charcoal was added in small portions at a time until a bloom of sufficient size was obtained. The product of such a furnace would not exceed a dozen pounds of metal per day.

An interesting paper on the same subject was read at the meeting of the Iron and Steel Institute in 1904, by Mr. C. V. Bellamy in which he describes a West African iron works, consisting of a few huts, but producing iron high in carbon and of excellent quality. The ore, which is a siliceous hæmatite, is found just below the surface, and after calcining over a slow wood fire, is concentrated by grinding and washing to 60 per cent. metallic iron. The prepared ore is then reduced in a small cupola furnace built

in the centre of a hut or smelting house. The cupola is formed entirely of clay, and consists of a dished out circular hearth below the floor level covered with a domed roof. It is about seven feet in external diameter and four feet high. There is a tap hole in the bottom to which access is obtained by a tunnel underneath the floor; also there are a number of openings round the side above the floor level, and inclined downwards towards the centre, one of which is larger than the others, and is used as a working door. The tap hole is plugged up from below with moist sand, and clay pipes about one inch in diameter, two to each opening, are inclined downwards towards the centre of the hearth. Charcoal is added and fired, and then the apertures are all luted up, when a current of air is drawn naturally down the pipes, while the products of combustion escape through a hole in the top of the dome. An effective natural draught is thus obtained, and the charging is commenced by the addition of a flux of rich cinder, after which ore and fuel are added at intervals through the hole in the dome. The cinder is tapped away from time to time through the hole in the bottom, and the last runnings are saved for flux. The smelters say that without this flux they are unable to carry out the reduction, and are careful to take some with them when they change their location. But this is probably only a tradition. At the end of thirty-six hours a bloom of iron rich in carbon is obtained, and removed through the larger opening in the side of the furnace. When it is cold it is broken up into suitable pieces and sold to the smiths, who decarburise it in small forges. In this way a steel containing about 1 per cent. of carbon is obtained which is worked up into tools and weapons. The tools used by the smelters themselves are very primitive, and are made of wood for the most part; iron itself is used vary sparingly.

There is no record of how long the process has been in

use, but it has been carried on by the same tribe for many generations ; and, like the Hindoo smelters, these African ironworkers have moved from place to place in search of ore and fuel. On finding both in sufficient quantity they settled on the spot, and remained there until the supplies were worked out.

Great Britain.—The evidence of early iron manufacture in this country is mostly objective, for the written records are very meagre. But in nearly all parts of the country where iron ores are found there are found also deposits of iron cinder, which prove conclusively that the metal was extracted on an extensive scale in early times. This is supported by the fact that the Britons who opposed the landing of the Romans some two thousand years ago were supplied with iron weapons. That these were home-made is most probable, for it is unlikely that Britons were importing the metal at that time, whatever we may do now.

The Romans seem to have soon discovered the methods in use, for it is said that a large forge for military purposes was erected at Bath to work up supplies of iron obtained from various parts of the country. Iron smelting must have been carried on very extensively in the Forest of Dean at a very early period, for cinder deposits rich in iron were smelted for their metal in the more modern blast furnaces during a period of 300 years.

An extensive deposit of rich cinder has been recently discovered in Warwickshire, which it is proposed to work for the metal ; and the convergence of the old roads in the district towards the deposit seems to indicate extensive workings, although there is at present no evidence in these heaps of the remains of furnaces and tools.

The presence of cinder on the banks of streams in various parts indicates that water power was used for the production of the blast, and for forging ; so that some advance must have been made upon the primitive process. Whether the

Romans worked the rich deposits of Cumberland hæmatite is doubtful, but there is evidence of early working in the district; and the Scots during their frequent incursions across the border were assiduous collectors of iron, which they preferred to any other form of spoil. The internal dissensions following the departure of the Romans, and the constant strife during the Saxon period, must have interfered with the manufacture of the metal, and the advent of the Normans also checked it further, for it is stated that the iron utensils in the kitchens of Edward III. were classed among the royal jewels.

Later, Kent, Sussex, Northamptonshire, and the Forest of Dean were the principal seats of iron manufacture, and kept this country well to the front among the iron producers of the world until the advent of cast iron, when she gradually took the lead, and maintained it until 1895.

CHAPTER IV.

PIG IRON AND ITS MANUFACTURE.

THE metallurgical chemist, when called upon to analyse a sample of commercial iron, always looks for carbon, silicon, manganese, phosphorus, and sulphur, in addition to iron, and when more than 2 per cent. of carbon is present he calls the metal cast iron.

The melting point of pure iron (about 1600° C.) is above the working temperature of any of the furnaces described in the last chapter; and although the passage of one or more of the elements named above into the reduced metal lowers its melting point, the iron produced in such furnaces did not melt, but remained in a semi-solid or pasty condition, and was so removed from the furnace. It is probable, however, that under exceptional conditions a charge having absorbed more carbon and silicon than usual, melted, and was run from the furnace in the molten condition. This is supposed to be the origin of cast iron; the date is usually given as 1350 A.D., and the locality Germany.

The process was not introduced into Great Britain until 1500 A.D., when furnaces began to appear in districts where a plentiful supply of wood for charcoal could be obtained. For more than a hundred years cast iron was produced solely with charcoal in this country. Then in 1619 Dud Dudley introduced the use of pit coal in the smelting of iron ores for cast iron; but it was not taken up generally, as it was not a success in the hands of these early British ironworkers. In 1713 Darby commenced to use coke in the blast furnace, which very rapidly replaced both charcoal



and coal, and caused a transference of the industry from wooded to coal-producing districts. In 1740 there were about sixty blast furnaces at work in this country, and fifty years later the number had increased to 106, of which 81 were coke furnaces and 25 charcoal furnaces. The weekly

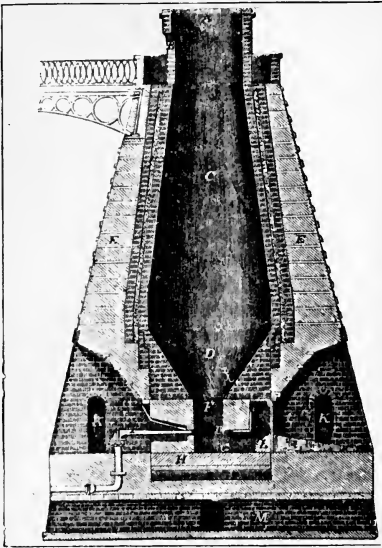

FIG. 9.—Blast Furnace (Miller).

makes were very small, about 10 tons for a charcoal and 15 tons for a coke furnace, as compared with the enormous yield, upwards of 3,000 tons, of a rapidly driven American furnace of to-day.

The last charcoal furnace in the south of England was blown out in 1827, and in Scotland in 1866; but some survived in the north of England until a few years ago. A furnace some 30 feet in height, and producing 30 tons of metal per week from a working charge of charcoal, red

hæmatite, Irish aluminous ore, and limestone, was in use in the Ulverstone district as late as 1894.

But charcoal furnaces are still in use on the Continent of Europe, principally in Styria and Sweden, and in North America for the production of special brands of iron. Their existence, however, depends upon an abundant supply of wood.

As the use of coke extended, the furnaces gradually increased in capacity, and became very ponderous struc-

tures on account of the supposed necessity for very thick walls of rough masonry surrounding the refractory lining. These furnaces were worked with open tops, and the large body of flame issuing from them was a familiar sight in iron-making districts some fifty years ago. The lurid glare in the sky at night in the "Black Country," when Staffordshire was the busiest iron-making district in the world, was then a notable feature. Now a chimney on fire would probably do more to attract the attention of the passer-by than a modern furnace in full blast. Fig. 9 shows an open-topped blast furnace of the old type.

Preparation of Iron Ores.—The ore as it comes from the mine or quarry in the raw state may or may not be fit to pass at once to the smelting furnace. Assuming that there is enough iron in it to render its extraction profitable, it is then necessary to determine whether the ore requires any preliminary treatment before it is smelted. This is readily done by heating an average sample of the powdered ore to a temperature below that at which it softens and clots together. If the loss is considerable, it shows that there is much volatile matter present that should be got rid of by a preliminary operation. The process is known as *calcination*, and may be carried on in heaps, stalls, or kilns. The last of these is the modern method, and the best for general work. The calcination of clay ironstone furnishes a good illustration of the changes that may take place as the operation proceeds. The iron is present in the form of ferrous carbonate, $\text{FeO} \cdot \text{CO}_2$, and when this compound is raised to a low red heat in contact with air it undergoes the following change:—

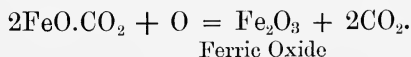

Then the clay of the gangue loses its water of hydration, and any hygroscopic moisture is also got rid of.

Any iron pyrites present loses part of its sulphur thus :—

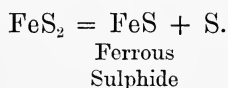

And the liberated sulphur burns to form sulphur dioxide. Part of the ferrous sulphide also undergoes change in contact with excess of air.

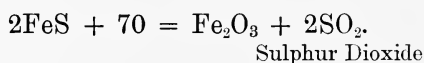

Thus clay ironstone loses all its carbon dioxide and water and part of its sulphur, and ferrous oxide is converted into ferric oxide; while the lumps of ore are rendered more porous by the escape of this volatile matter. Blackband ironstone loses, in addition, the bituminous matter it contains. Brown hæmatite loses water and part of its sulphur. But red hæmatite and magnetite have very little to lose, and are rarely calcined. Phosphates are not affected by the process, so that there is no reduction in the quantity of phosphorus present. The following may be taken as the average losses of various ores on calcination :—blackbands, 50 per cent.; clay ironstones, 27 per cent.; brown hæmatites, 14 per cent.; red hæmatites, 6 per cent.

The conversion of ferrous oxide into ferric oxide is important, as the higher oxide has much less tendency to flux with silica than the lower one, and iron is thus prevented from passing into the slag. The following table gives the approximate percentages of the principal constituents of a clay ironstone before and after calcination, and shows the general effects of the operation. It will be noticed that the escape of volatile matter causes an increase in the proportion of the solids in the residue.

	Ferrous Oxide, FeO.	Ferric Oxide, Fe ₂ O ₃ .	Alumina, Al ₂ O ₃ .	Lime, CaO.	Silica, SiO ₂ .	Carbon Dioxide, CO ₂ .	Phosphoric Oxide, P ₂ O ₅ .	Water, etc.
Raw	35	5.5	10	5	11	18	1.25	10
Calcined	—	58.5	13.5	6.5	14.5	—	1.65	—

Calcination in *heaps* is carried out by dumping a layer of the ore on the selected ground and covering it with a layer of small coal. This is followed by alternate layers of ore and coal until the heap is made up. Such a heap may be 50 feet wide, 6 feet high, and 200 feet long, and may contain about 2,000 tons of ore. It is fired at one end and allowed to burn out, which occupies several weeks. From 8 to 10 per cent. of coal is used. The method is wasteful of time, labour, and fuel, and is not much in favour. More sulphur, however, is eliminated than by other methods. The blackband ores of Scotland are sometimes calcined in this way, and they contain sufficient coaly matter to calcine without the addition of fuel.

Calcination in *stalls* is equivalent to surrounding a small heap of ore and fuel by three walls, and loosely closing up the front with bricks or lumps of ore. A series of stalls is made by building a number of short walls at right angles to a long wall, so as to form a number of compartments. These are filled with the ore and fuel, the fronts loosely bricked up, and the charge fired. Air gains admission through the fronts, and the calcining proceeds in a fairly uniform manner. The ore and fuel may be dumped from trucks running on rails over the tops of the stalls, and the calcined ore drawn from the floor level. The proportion of fuel to ore is rather less than for heap calcining.

Calcining in *kilns* is most largely used, and is more economical than either of the other methods. Various forms of kilns are used, but they mostly belong to the

barrel type of furnace. Some are fired with solid fuel, and others with the combustible gas from the blast furnace.

Gjers' kiln is a good illustration of a coal-fired kiln, and a short description of its construction and mode of working will furnish sufficient details of the general process. The shell of the kiln consists of a huge iron cylinder tapered off into a conical portion at the bottom, and formed of iron

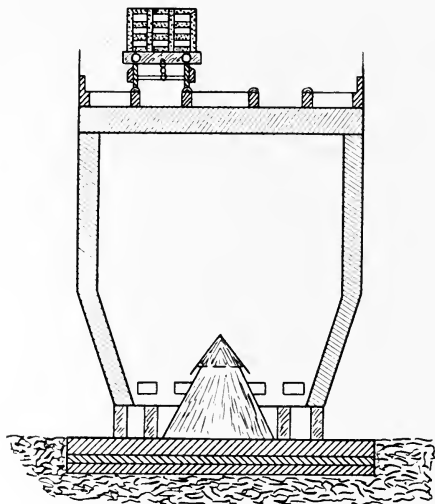

FIG. 10.—Gjers' Calcining Kiln.

plates riveted together. It is lined with a 14-inch course of firebricks, and is closed at the bottom by a circular iron plate supported on short pillars about $2\frac{1}{2}$ feet from the ground. A cast iron truncated cone, built up from the floor level, passes through a circular hole in the bottom plate up into the body of the kiln. The top of this cone is surmounted by another slightly wider cone which forms a kind of cap, and at the same time allows air to pass between the two into the kiln without risk of the air space being stopped up by dust and small ore. The bottom plate is pierced by a number of holes that serve as discharging doors; and in the conical part of the shell is a second set of openings which serve for the admission of air, and for the insertion of iron rods to break up any obstruction that may form during working. The top of the kiln is open, and has sets of rails passing across it, on which trucks

containing the ore and fuel can be run, and their contents dumped into the kiln. Such a kiln, 24 feet in diameter and 33 feet high, has a capacity of about 8,000 cubic feet, and will hold some 250 tons of ore and fuel. The consumption of fuel is, roughly, 1 ton of coal to 25 tons of ore. It works continuously, the mixture of ore and fuel passing in at the top, and the calcined ore being raked out at the bottom. The cone serves the double purpose of admitting air into the centre of the kiln and directing the calcined charge outwards. About 150 tons of ore pass through the kiln per day. Fig. 10 shows the general form of the kiln.

Weathering.—Pyritic and shaly ores are improved by exposure to wind and rain. This is termed weathering, and may extend over months or even years. Iron pyrites, FeS_2 , is slowly oxidised to ferrous sulphate, FeSO_4 , which, being soluble, is washed away by the rain. Shaly ore is slowly disintegrated, and the useless portions can be picked out. The general effect of weathering on a spathic ore is to convert it into brown hæmatite, but the necessary conditions are not always present.

Concentration.—Poor ores containing magnetic oxide, Fe_3O_4 , can be concentrated by passing the finely divided material through magnetic concentrators in which powerful electro-magnets attract the iron compound, and allow the particles of non-magnetic gangue to fall into a hopper by which it is passed out of the machine. The magnetic particles are carried by revolving drums out of the magnetic field, when they fall into another hopper, and pass out of the machine. Not only is the iron concentrated in a smaller bulk of material, but phosphates and pyrites, which are non-magnetic, are concentrated in the gangue, and thus eliminated to a considerable extent. The concentrates are mixed with some binding carbonaceous material and pressed into briquettes for the blast furnace. Ores containing ferric oxide, Fe_2O_3 , which are non-magnetic, may be rendered

so by heating to a low red heat with a regulated quantity of ground coal, or in a current of reducing gas, by which the oxide is reduced to the magnetic condition, and can then be concentrated.

THE SMELTING OF PIG IRON.

The process, which is not a very complicated one, is carried on entirely in a blast furnace, and as the output is very large it is also a cheap process. In the evolution of the modern blast furnace as used in the smelting of iron ores for pig iron the general principle has been but slightly modified. The important modifications are in the dimensions and proportions of the furnace, and in the method of working. Thus in the earlier furnaces the height was about three times the greatest diameter. Since then the height has increased, and in greater proportion than the width, and now the height is about four times the greatest diameter. According to Ridsdale, the modern English furnace varies from 70 to 100 feet in height, depending upon the general conditions of working.

The Modern Blast Furnace.—One of the first requisites is a thoroughly good solid foundation to carry the huge bulk without slipping. If the ground is at all loose, piles must be driven in to make it firmer. The main shell of the furnace consists of a huge cylinder formed of curved iron plates, half an inch thick, riveted together, and rising from a flat iron ring supported on cast iron pillars set in the solid foundation of the furnace. Next to the shell is a casing of ordinary brickwork, and the inside lining is of refractory bricks, 18 inches thick. They are both built up from the ring, and inside the shell, so that the whole of this part of the furnace is independent of the portion below the ring, which is built in after the stack is complete. The top of the furnace is closed by the charging apparatus and

by the gallery upon which the materials of the charge are brought previously to their introduction into the furnace.

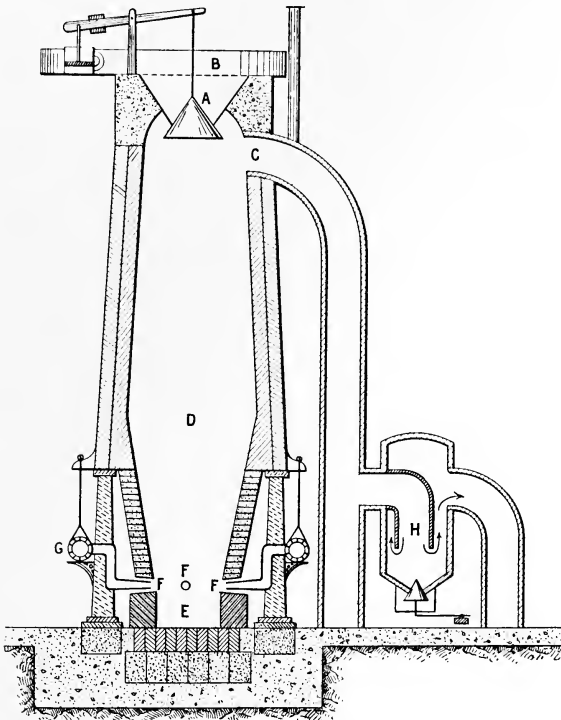

FIG. 11.—Modern Blast Furnace (vertical section).

- | | |
|----------------------|---------------------|
| A, Cup and cone. | E, Hearth. |
| B, Charging gallery. | F, Tuyers. |
| C, Gas outlet. | G, Horse shoe main. |
| D, Boshes. | H, Dust catcher. |

The common way of closing the furnace top is by means of a cup and cone arrangement, in which the centre of the gallery floor is dished out to form a conical charging hopper. The opening from this hopper into the throat of

the furnace is closed by an iron cone suspended at its apex from a lever arrangement by which it is held in position, and effectively closes the mouth of the hopper cone, except when it is lowered to admit a charge. The gallery floor is lined with iron plates.

Below the charging apparatus, but above the level of the charge, there is a wide circular opening in the brickwork which leads outwards to a wide pipe, the "down comer," that passes down the outside of the furnace to an expanded portion, the *dust catcher*. The gallery is usually reached from the ground level by an inclined plane furnished with rails, on which a trolley furnished with front and back wheels of different diameters and a horizontal platform, is made to ascend and descend. The trolley is counterpoised by a heavy weight suspended from a steel cable passing over a pulley at the top of the plane; so that the load only has to be lifted to the furnace top, and this is done by a steel cable worked by steam power. The lower terminus of the trolley is the dock on which the materials of the charge are accumulated in iron charging barrows that can be wheeled straight on to the trolley platform. The upper terminus is the charging gallery on to which the barrows are wheeled when the trolley reaches it. One hoist usually serves several furnaces, the galleries of which are connected together by bridge-ways. Vertical lifts worked by hydraulic power are also used for the same purpose.

The above description of the stack or shaft of the furnace may be followed by that of the *hearth* and *combustion zone*, which is built in afterwards, so that it can be taken out and replaced during the life of the furnace without interfering with the shaft, as it is here that the principal wear and tear takes place. The most refractory materials are used in its construction, as the effects of high temperatures and the corrosive action of molten matter must be counteracted as much as possible. For rapid

working, as in American practice, for example, water blocks through which water can be made to circulate are built into the parts exposed to the highest temperature to prolong the life of the lining. In a still later form a more continuous and more effective circulation of water is obtained by means of bosh jackets, which encircle the furnace just above the twyer region. No leakage can take place into the furnace, as the jacket pockets are only 24 inches deep, and the blast pressure in the furnace would more than counterbalance this depth of water in the jacket. The hearth in which the molten matter collects is circular in plan and lined with shaped bricks. It has a slightly concave bottom, built in the form of an inverted arch so as to prevent bulging upwards. In the side of the hearth and close to the bottom is a rectangular opening, the *tap hole*, which is closed with clay during working; and at the top of the hearth are a number of circular openings through which the twyers or blast pipes are inserted. Below these, and usually on a diameter at right angles to the tap hole, is the opening known as the *cinder notch*. Above the hearth the furnace gradually widens until it reaches its maximum at the *boshes*. The outside of the hearth is surrounded by a moat filled with water and stones. The water serves to keep the lower part of the hearth cool, and the stones prevent the formation of a solid ring of metal in case of a break through. The size of the hearth depends generally upon the size of the furnace, and is usually about 10 feet in diameter; but the ratio of the hearth to the other dimensions varies in different furnaces. Until somewhat recent years an arch was built in the side of the hearth, the lower portion of which was closed by the "damstone" and the upper portion by the "tymptone." These were faced on the outside by iron plates, and the cinder notch, a semi-circular channel in the top of the dam-plate, led out between the upper and lower plate. In this arrangement the hearth was

wider near the arch, and the space behind the damstone was known as the fore hearth. But this seems now to have entirely disappeared, and the hearth of the modern furnace has a uniform cross section.

The following dimensions of a recently-constructed furnace are given: height, 80 feet; diameter at boshes, 20 feet; diameter of hearth, 9 feet; diameter of throat, 11 feet. A vertical section through such a furnace is shown in Fig. 11.

The ring of pillars on which the shaft is supported also carries the *horse-shoe* blast main, which is an iron pipe

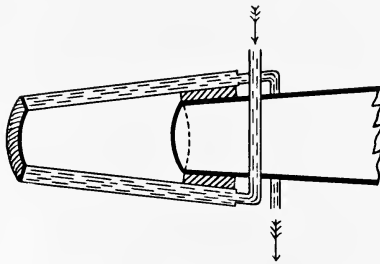

FIG. 12.

about 3 feet in diameter, and lined with a 9-inch course of firebricks. It has therefore an internal diameter of 18 inches, and nearly encircles the furnace, being supported on brackets standing out from the pillars. Elbow tubes or *goosenecks* pass downwards from it to

the twyer level, there to be connected with the twyers. The portion of the twyer that enters the furnace is a water jacket (Fig. 12), through which water is kept circulating, and the pipe from the gooseneck through which the blast passes is fitted into this. A view of the interior of the hearth in the region of the end of the twyer can be obtained through a hole in the elbow, known as the *furnace eye*, which is closed by a plate of mica, or by a plug, when not in use. Each twyer is furnished with a throttle valve by which the blast can be cut off from it without interfering with its fellows. Six twyers are used for a furnace of the dimensions given above, but the number varies in different furnaces. The arrangement at the bottom of the furnace is shown in Fig. 13.

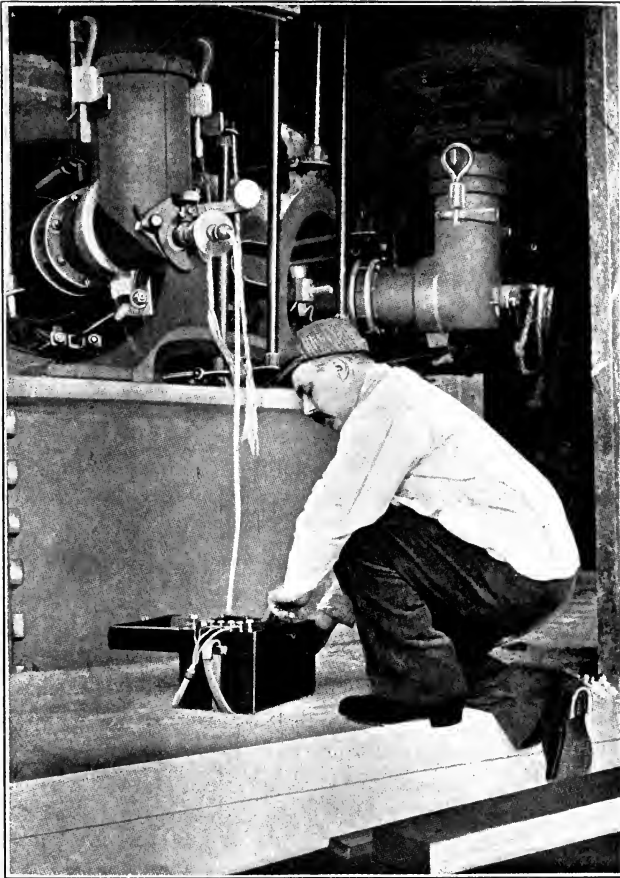

FIG. 13.—Bottom of Blast Furnace showing twyers in position.

The Blast.—Smelting for pig iron is now almost entirely carried out with hot blast, which was introduced by Neilson in 1828, and it is only high grade pig iron for special purposes that is now smelted with cold blast.

The method of heating the blast has undergone many

changes since Neilson's time, when an expanded portion of the blast main was surrounded by a furnace in which solid fuel was burnt, and the blast driven through it before entering the furnace. Various forms of iron pipe stoves heated with solid fuel or waste gas have been used, but have now almost entirely given place to stoves of the regenerative principle, which are much more suitable for using the blast furnace gas itself for heating the blast. One of the earliest stoves of this pattern was designed and constructed by Cowper in 1860 to burn solid fuel; but shortly after he proposed to use "waste" gas, and the later ones are all modifications or extensions of Cowper's original stove. The principle of regeneration demands at least two stoves, and each stove consists of a huge chamber, the interior of which is built in with firebrick intersected by flues, in which combustible gas is burnt to develop heat, which is absorbed by the brickwork and re-absorbed by the air when the chamber is put in the path of the blast on its passage from the blowing engine to the furnace. Thus the chambers are alternately heating the blast and being re-heated by the burning gas; hence the necessity for at least two stoves.

The Modern Blast Stove is almost as large as the furnace it serves. It is circular in cross-section, and consists of a gas-tight shell formed of curved iron plates. In some cases it is from 70 to 80 feet in height and 25 to 30 feet in diameter. The inside of the shell is lined with firebricks, and the interior is built in with a mass of brickwork through which run the necessary flues and passages for carrying on the combustion of the furnace gas, and for exposing a very large total heating surface to the air brought into contact with it when the blast is passing through. It is estimated that five square feet of heating surface are necessary for every cubic foot of air. The passages should therefore be arranged so as to expose as

large a surface as possible, compared with their cross-section, as is consistent with the other conditions of working. It is easy to see that the smaller the cross-section of the passages the greater will be the total heating surface, but also the

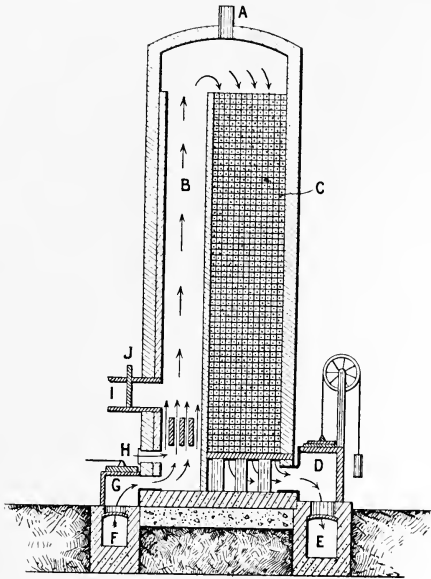

FIG. 14.—Cowper's Hot-blast Stove.

- | | |
|-------------------------|---------------------|
| A, Man-hole. | F, Gas culvert. |
| B, Combustion flue. | G, Gas valve. |
| c, Honeycomb brickwork. | H, Air inlet. |
| D, Chimney valve. | I, Hot-blast main. |
| E, Culvert to chimney. | J, Hot-blast valve. |

greater the frictional resistance to the passage of gas through them. Other conditions, such as total capacity, rate of flow, and facilities for cleaning, determine the size of the stove and its general arrangement. In the modern Cowper stove, the general construction of which is shown in Fig. 14, the regenerative part presents somewhat

the appearance of a honeycomb in cross-section. This honeycomb structure is built up from an iron grid which is supported on columns just above the bottom. It fills more than two-thirds of the cross-section, and extends nearly to the top of the stove. It is built of shaped bricks, and the walls dividing the passages are about two inches thick ; but the passages themselves are about six inches wide, and hexagonal in cross-section. The combustion flue, which is a lens-shaped passage with thick walls, extends from below the grid up to the level of the regenerative brickwork. The lower portion of this flue is divided into several narrower channels by vertical partition walls. The gas and air inlets are at the bottom of the flue just below these partitions, and the hot blast outlet just above them. The outlet to the chimney communicates with the space under the grid, and leads into an underground culvert connected with the main stack. Reference to Fig. 14 will make the general arrangement clear. The cold blast inlet is not shown.

For working the stove combustible furnace gas is admitted to the combustion flue through the gas inlet valve, while sufficient air to burn it completely is drawn through the air inlet valve just above. The flue being hot, the gas fires immediately, and the current of burning gas is broken up into sheets in passing through the spaces between the partition walls. This is said to ensure more perfect combustion of the gas. The flame and products of combustion then pass up the flue and down through the hexagonal passages in the honeycomb structure ; and in doing so leave behind in the brickwork practically the whole of the heat developed by the combustion of the gas, for the burnt gas leaves the stove at much the same temperature as the raw gas entered it ; but strictly, the heat carried off by the nitrogen of the air used to burn the gas would have to be considered. When the temperature of the stove has been sufficiently raised, the gas and air supply is cut off, the

chimney valve closed, and the cold blast turned on. The cold air passes into the space under the grid, through the regenerator passages, down the combustion flue, and through the hot-blast outlet into the hot-blast main, by which it is conveyed direct to the furnace. The blast is driven through the hot stove until the brickwork is sufficiently cooled down, when it is cut off and the gas and air supply turned on again. From this it is clear that two

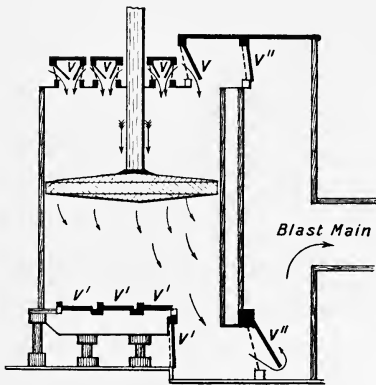

FIG. 15.—Blowing Cylinder.

- V*, Air valves for down-stroke.
- V'*, Air valves for up-stroke.
- V''*, Valves to blast main.

stoves at least must be in use, one for heating the blast while the other is itself being heated. The temperature of the blast often reaches 800° C., and a large quantity of heat must be absorbed by the air to obtain this result. The rush of air from the cold blast main is immediately slowed down by the larger sectional area over which it is spread, and the slower current has a long path to travel through, so that time is given for suffi-

cient heat to be absorbed by the air to raise it to the proper temperature.

The blast is furnished by blowing engines of the cylinder type, and as enormous quantities of air must be set in motion, they are very large. They form a very important part of blast furnace equipment, as from five to six tons of air must be driven through the furnace for every ton of pig iron produced. A cubic foot of air weighs about 0.076lb., so that a ton of air would have a volume of about 30,000

cubic feet. Blowing engines of the beam type have not yet disappeared, but direct-acting engines in which the blowing cylinder and the steam cylinder are placed one above the other are now largely used. The two pistons are connected by the same rod, and move up and down the cylinders at the same time. Double-cylinder engines for using both high and low pressure steam are the most economical when steam is to furnish the motive power; but gas engines burning blast furnace gas direct will no doubt furnish the whole of the blowing power in the future, and are extensively used in some works at the present time.

The size of the blowing cylinders varies somewhat with the work to be done. Some of them are upwards of ten feet in diameter and of the same length, with a piston area of about 100 square feet. Such a cylinder will deliver upwards of 50,000 cubic feet of air per minute. An idea of the general construction of a blowing cylinder is given by Fig. 15.

In this country it is the general practice to use a powerful engine for supplying the blast to several furnaces; but in America the furnaces are more self-contained, the blast being supplied direct to a single furnace, so that smaller engines are required. This is no doubt due to the greater pressure required for the very rapid driving common to the Western continent.

The blast pressure used in different furnaces varies considerably according to the kind of furnace and the work to be done in it. Thus a charcoal furnace may be driven with a pressure of less than 1lb. per square inch, while a rapidly driven American furnace may require a pressure of 15lb. per square inch. In general practice it varies from 3lb. to 7lb. The height of the furnace, the density of the materials in the charge, and the rate of working have all to be taken into consideration; but sufficient air must be driven in to keep up a continuous stream through the

furnace. The greater the pressure in a given cylinder the greater will be the weight of air supplied in unit time. Considerable fluctuation of the blast pressure takes place during actual working, but it is fairly under control. Mercury pressure gauges are placed near the blowing cylinder, and also near the hot-blast main.

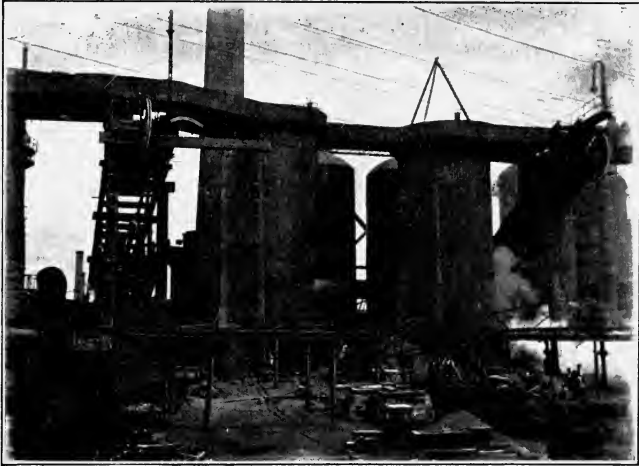

FIG. 16.—A Modern Blast Furnace Plant.

Fig. 16 gives an idea of the general arrangements of the blast furnace plant in a modern ironworks.

The Blast Furnace Charges.—The charge passing through the hopper at the top of a blast furnace consists of a properly proportioned mixture of ore, flux, and fuel, which is so arranged that the gangue of the ore, together with the ash of the fuel, is converted into slag by the flux, while the iron is separated as metal by the reducing action of gas furnished by the incomplete combustion of the fuel. The charge sinks down the furnace at the rate of about three

feet per hour. This, however, depends upon the rate at which the furnace is being driven. This descending stream of solid matter is penetrated by a current of gas that passes upwards at the rate of about three feet per second, also depending on the working of the furnace.

The zone of combustion, as that part of the furnace near to and just above the twyers is called, is the region in which the highest temperature is generated, and no solid matter remains long in the solid state in this region except the coke, which is constantly falling into it from the charge above. It is, in fact, a solid bed of white-hot carbon, through which the molten metal and slag trickle into the hearth below. The blast of hot air comes into contact with this highly-heated fuel, and the carbon is practically burnt at once to carbon monoxide, CO , instead of being first completely burnt to carbon dioxide, CO_2 , as would be the case with cold blast and a fuel bed at a lower temperature. The current of air is thus robbed of its oxygen low down in the furnace, and passes upwards, carrying the carbon monoxide with it; this gas is thus brought into contact with the heated oxide of iron in the charge, and reduces it to the metallic state, thus:—

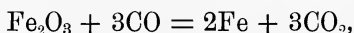

but the carbon monoxide must be in considerable excess or the oxide of iron is only partially reduced, thus:—

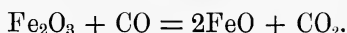

Also, if carbon dioxide accumulates in large excess in the furnace gas, the reduced iron is oxidised again, as follows:

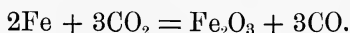

This makes it clear that the furnace gas must contain a large proportion of carbon monoxide, if the oxide of iron is to be properly reduced.

Oxide of iron is also reduced at even a low red heat by solid carbon; but this reaction is probably not an important one in blast-furnace changes. Carbon dioxide is formed by this reaction, thus :—

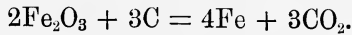

Under proper conditions the metal is completely reduced in that part of the furnace where the temperature reaches a red heat. The iron thus produced is in a spongy state, and is able to abstract carbon from the carbon monoxide, and from the fuel, with which it is in contact. The reaction may be expressed in a general way by the equation—

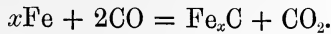

The limestone flux is decomposed at a red heat into lime and carbon dioxide, and the latter is largely converted into carbon monoxide in contact with the red hot coke, thus preventing the accumulation of carbon dioxide in the reducing zone. This is shown by the equation :—

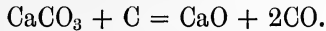

Lower down the furnace, where the temperature is much higher, silica is reduced by solid carbon in the presence of iron, and the silicon passes into the metal. Phosphorus, manganese, and sulphur are also reduced from their compounds, and pass into the metal, which is now in a perfectly fluid state, and filters through the coke bed into the hearth below. The lime unites with the remaining earthy matter of the gangue and the ash of the fuel to form the liquid slag, which runs down into the hearth, and floats on top of the molten metal. The reduction of these oxides is a simple matter when the furnace conditions are favourable, as they are decomposed by carbon at a white heat with formation of carbon monoxide, and being set free

in the presence of the metal, pass into it. The reduction of phosphoric oxide and silica is typical:—

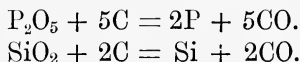

The impurities that find their way into the metal all come from the gangue and the fuel. The proportions, however, that pass into the metal depend very largely upon the temperature of the furnace and the composition of the slag.

The Furnace Charge.—As already indicated, the gangue of the ore and the ash of the fuel are for the most part converted into fusible slag, and since the composition of this slag must be kept within somewhat narrow limits the proportion between the ore and the flux must be carefully arranged. The nature of the gangue must also be considered. Limestone is the common flux, but if the chief ore is siliceous, then material containing alumina must be added, and clay is sometimes used for this purpose. But it is preferable to use iron-bearing materials when they can be obtained, and Irish bauxite, which is rich in alumina and ferric oxide, is very useful. Sometimes a slag rich in alumina is added. When a variety of ores is at hand it is often possible to prepare an ore mixture containing sufficient alumina to flux properly with the added lime; and at times a mixture can be made “self-going,” that is, to require no added limestone.

The composition of the main bulk of the slag formed in hot-blast working may be represented by the formula—

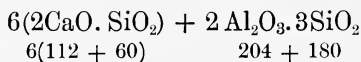

from which the percentage composition is readily calculated, and gives—

Silica, SiO ₂	38·1
Alumina, Al ₂ O ₃	14·7
Lime, CaO	47·2
	100·0

This forms about 85 per cent. of the average slag, the remaining 15 per cent. being made up of the silicates of other oxides, such as ferrous oxide, FeO, manganous oxide, MnO, magnesia, MgO, and the alkalis. Phosphates and sulphides, too, are often present.

Strictly speaking, this slag is a normal double silicate of lime and alumina (monosilicate), but it is usually described as basic in character on account of the large percentage of bases it contains. It is not readily fusible, and requires the high temperature of the hot blast to render it perfectly fluid. Dolomite is sometimes used in the Cleveland district in place of lime, although it thickens the slag, as it is supposed to favour the passage of sulphur into the slag.

In cold-blast working the slag usually aimed at has the composition expressed by the formula—

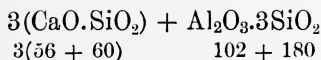

This gives—

Silica, SiO ₂	57·2
Alumina, Al ₂ O ₃	16·2
Lime, CaO	26·6
	100·0

It is the acid double silicate (bisilicate), and is more fusible than the one given above; it forms the main bulk of the slag.

In certain conditions of the furnace, with regard to the composition of the charge and the general working, a very fluid slag, called a “scouring” slag, is produced. This

contains an unusual amount of ferrous oxide, and exerts a corrosive action on the furnace lining. Such a slag is produced when a large proportion of cinder is used in the charge.

Blast furnace slags vary considerably in appearance. Some are dull and stony looking, and others are glassy in character. This depends upon the composition of the slag and its rate of cooling. Rapid cooling tends to the formation of a glass. Slags vary in colour from brownish yellow to black, passing through various shades of green and blue. Parts of the same piece sometimes differ in colour and character.

Most blast furnace managers have their own methods of making up the charge; but this presents no difficulty to the experienced man when the composition of the materials at hand is known. He has to consider the grade of pig to be produced and use his knowledge of the general working of the furnaces under his control. Tables and curves, such as Balling's, are used, but only general outlines can be given. The following are typical:—

(1) Scotch Furnace using coal (Sexton)—

INTAKE.		OUTPUT.	
Ore mixture . . .	2.50 tons.	Pig iron . . .	1.00 tons.
Limestone . . .	0.50 „	Slag . . .	1.50 „
Coal . . .	1.75 „	Furnace gas . . .	8.25 „
Blast . . .	6.00 „		—
	—		10.75 tons.
	10.75 tons.		

(2) Cleveland Furnace using coke (Turner)—

INTAKE.		OUTPUT.	
Ore mixture . . .	2.4 tons.	Pig iron . . .	1.0 tons.
Limestone . . .	0.6 „	Slag . . .	1.5 „
Coke . . .	1.0 „	Furnace gas . . .	6.5 „
Blast . . .	5.0 „		—
	—		9.0 tons.
	9.0 tons.		

The average composition of the furnace gas from a coke furnace may be taken as follows :—

Carbon monoxide, CO 29	} Combustible.	
Hydrogen, H ₂ 3		
Carbon dioxide, CO ₂ 9		} Non-combustible.
Nitrogen, N ₂ 59		
100			

In the ordinary method of charging, the materials in the proportions for the charge are raised to the gallery of the furnace in iron barrows, and tipped into the cup by the “fillers,” as the men at the top are called. The cone is then released, and sinks under the weight of the charge, which then slides down its inclined sides into the furnace. When relieved of the charge the cone is raised again by the counterpoise weight

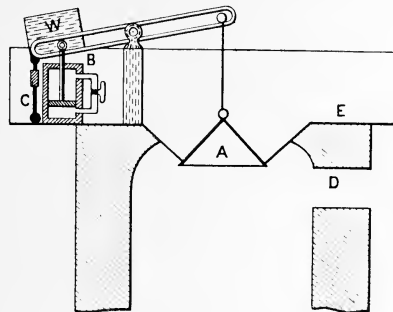

FIG. 17.

at the other end of the lever, and the cup closed. The proper distribution of the charge in the furnace is most important, and depends upon the diameter of the aperture in the cup, and the slope of the sides of the cone, both of which are carefully regulated. In the form of apparatus shown in Fig. 17, the motion of the lever from which the cone A is suspended is governed by means of a cylinder and plunger B, as well as by the counterpoise W. The cylinder is full of water, and when the tap in the connecting pipe is closed the plunger is held in position, but when it is open the plunger can move either up or down. The motion of the cone is, therefore, well under control. The bolt rod C is

also used while the charge is being thrown in. The level of the charge is not allowed to rise above the gas outlet D, and is determined by pushing an iron rod through apertures in the gallery floor E into the throat of the furnace. The motion of the cone up and down is made as rapid as possible so as to prevent the escape of the furnace gas.

Variations in the Air.—The composition and general character of the various ores, limestone, and coke have been described in Chapter II., and it remains to describe the general properties of the air used for the blast. It is quite evident from the enormous quantity used that variations in its composition must have considerable influence on the working of the furnace. The variable constituent which exerts the greatest influence is water vapour. It has long been known that an increase or a decrease in the quantity of water vapour driven into the furnace has a decided influence on its working. If, then, a perfectly uniform blast is to be obtained the percentage of water vapour in it must be kept constant. It would be impossible to completely remove the moisture from so large a bulk of air at anything like a reasonable cost; so that all that can be done is to reduce the quantity, and produce a blast that shall be of uniform composition from time to time. J. Gayley, an American authority, states that a saving of coke and an increase in the output can be effected by causing the air to pass through refrigerators before it enters the blowing cylinders. The air is thus cooled down below its saturation point, and the excess water vapour condensed and deposited in the refrigerators. In this way it is possible to reduce the quantity of moisture in the dried air to about 1 grain per cubic foot. It is well known that the quantity of water vapour in the air may vary from day to day, and that it is less in the winter than in the summer. In this country the average quantity is said to be 5·5 grains per cubic foot for summer and 3·5 grains for winter. More heat is carried

away in the gases when moist air is used than when it is dried ; so that the furnace top is hotter, and there is more liability to the reduction of carbon dioxide to the monoxide, where it is not wanted, with a consequent increase of the coke consumption. This is borne out by the fact that the fuel consumption is less in the winter than in the summer.

W. Richards is of opinion that it is preferable to dry the air than to try to regulate the temperature of the blast according to atmospheric variations.

The principal action of the water vapour in the furnace seems to be to reduce the temperature of the coke bed by causing the change ($C + H_2O = CO + H_2$), which is endothermic in character, and results in the absorption of heat. This extends the zone of combustion upwards and tends to a hotter top, as stated by Gayley. Thus, the more moisture there is in the air, the hotter must be the blast to preserve uniform working. Some of the hydrogen set free no doubt takes part in the reduction of the metal, but free hydrogen is nearly always found in the furnace gas. There has been much discussion as to the general utility of drying the blast, but, like other modifications in blast furnace practice, it will have to pass through the test of experience.

Hot Blast.—When Neilson introduced his method of heating the blast in 1828 it was thought that there would be little or no saving of fuel, as it was difficult to understand why the burning of a given weight of fuel in the furnace should not give as good a result as when part of it was burnt outside to heat the blast. This was probably due to the then imperfect knowledge of the furnace changes. But in practice it was soon found that a great economy was effected. According to Prof. Turner a consumption of upwards of 8 tons of coal per ton of pig iron was reduced to about 5 tons by heating the blast to $170^\circ C.$, and a still further reduction to about $2\frac{1}{2}$ tons when the blast was heated to $300^\circ C.$ This was in 1833, so that the

economy of the system was soon proved; and, although the consumption of fuel per ton of pig was greater in Scotland than in other parts of the country, the use of hot blast grew rapidly. In South Wales it enabled anthracite to be used in the furnace; and in Staffordshire it initiated the smelting for "cinder" pig as distinguished from "all mine" pig.

In considering the theory of the hot blast it should be borne in mind that there are two oxides of carbon, and that where there is a sufficient quantity of air the tendency is for the carbon to burn completely to the higher oxide, CO_2 , while with a limited quantity of air the lower oxide CO is formed, provided the temperature generated is high enough to allow of the change—

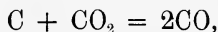

and this is probably the origin of the carbon monoxide in a furnace working with cold blast.

Now there is a temperature range within which carbon dioxide is decomposed into carbon monoxide and oxygen—



and when the temperature of the zone of combustion is well within this range very little carbon dioxide is formed; or, what amounts to the same thing, is decomposed as fast as it is formed. Therefore the principal product of the combustion is carbon monoxide. Now, it is perfectly clear that by blowing hot air into the zone of combustion its temperature would be raised in proportion to the temperature of the incoming air, as the heat it brought in would be added to that generated by the combustion induced by its oxygen. It is, therefore, readily understood that the temperature might be high enough to prevent the formation of the higher oxide, except in small quantity. So that in considering the extra efficiency and economy of the hot

blast it must be borne in mind that the heat carried into the furnace by the blast causes an increase in the temperature of combustion, with more rapid melting of metal and slag. That the zone of combustion is more localised, as carbon monoxide is practically formed at once instead of carbon dioxide being first formed and then having to pass some distance up the furnace before its conversion into the monoxide. Also, that as a smaller quantity of air is required with the hot blast to generate the same temperature, the consumption of coke is reduced, and therefore the amount of ash to be fluxed off is less. Thus the top of the furnace is cooler, the burden is heavier, the working is more rapid, and the yield is increased.

The thermal efficiency of the blast furnace has formed the subject of important papers by Mr. W. J. Foster,¹ who is of opinion that the problem is a complicated one, to which the manager who wishes to get the best out of his furnaces must give careful consideration. For a full determination it would be necessary to know the specific heats of all the matter in the system and their variations with the changes of temperature in the furnace. He draws attention to the influence of heat on compounds, such as water, which are dissociated at high temperatures with absorption of much heat, and concludes that part of this heat is absorbed and rendered latent at temperatures below the dissociation point. Thus the specific heat of water vapour would be largely increased at the temperature of the furnace, and further heating of the blast would not be equivalent to the removal of a corresponding quantity of water vapour calculated according to its ordinary specific heat. He also discusses the endothermic changes mentioned above, and considers the whole of the matter concerned in the working of the furnace.

¹ Journal of the Iron and Steel Institute, 1904, and Proceedings of the Staffordshire Iron and Steel Institute, 1907.

Temperature and Pressure of the blast require careful regulation for uniform working. Now the temperature of the air entering the furnace depends upon the manipulation of the hot-blast stoves, and when thermal measurements are taken they are made in some part of the hot-blast main near the furnace. A recording pyrometer affords the best means of dealing with this problem, for it may be made to trace a curve that will show the variations in the temperature of the blast from time to time. Sometimes thin rods of alloys of known melting points are used. These are pushed through a special aperture in the hot-blast main so as to be in contact with the hot air, and its temperature is then known to lie between the melting points of two rods, one of which melts while the other remains solid.

The pressure is recorded by pressure gauges attached to the main, but sometimes the twyers get stopped up so that little or no blast passes through them, and this causes irregular working. A very simple arrangement for indicating when a twyer is not blowing may be described as follows: a small aperture in the blast main just above the goose neck is connected by a pipe with one limb of a U tube pressure gauge, and a similar aperture in the goose neck itself just below the throttle valve is connected with the other limb of the gauge. The friction of the parts of the valve and the sides of the tube as the air rushes through the goose neck on its way to the twyer reduces the pressure from what it is in the blast main above. This causes the liquid in the limb of the gauge connected with the goose neck to be higher than it is in the limb connected with the main, for the lower pressure in the one limb requires a longer column of liquid to help to balance the higher pressure in the other limb. This is a clear indication that the twyer is working. If, however, the twyer gets stopped from any cause, the liquid sinks, and the gauge reads level

in both limbs, for with no friction the pressure is the same on both sides.

The pressure of the blast varies very considerably in general practice. It may be as low as 2 lbs. per square inch in a slowly-driven furnace, or as high as 15 lbs. per square inch in a rapidly-driven American furnace. But there is always considerable leakage between the blowing cylinder and the twyer, and the greater the pressure the greater the loss. Thus with a pressure of 2 lbs. the loss is only 2 per cent., but with a pressure of 10 lbs. it may amount to as much as 25 per cent., the greater part of which is lost in the stoves.

Equalisers.—In ordinary hot blast practice with regenerative stoves the blast is turned on and off a given stove at regular intervals. During the “on” interval the blast is taking heat from the brickwork of the stove and cooling it down, so that at the end of the interval both the stove and the blast it is heating are at a lower temperature than at the beginning. This fall in the temperature of the blast, if it is at all considerable, must interfere with the uniform working of the furnace. In order to remedy this Messrs. Gjers and Harrison suggested the use of a smaller stove, which they called an equaliser, between the heating stove and the hot blast main. The open brickwork in this stove is divided into two portions by a central partition wall so as to cause the blast to pass up one side and down the other. The principle is very simple: the hotter air from the heating stove during the first part of the interval gives up heat to the brickwork of the equaliser, and is thus reduced in temperature, and during the last part the cooler air absorbs heat from the equaliser, and is raised in temperature. In this way the general temperature of the blast is kept nearly uniform. One equaliser is required for two stoves.

Tapping the Furnace.—The molten iron and slag collect in the hearth, and as they do not mix together the heavier

metal sinks to the bottom, and the lighter slag rises to the top. The slag when it reaches the cinder notch runs from the furnace, is collected in iron tubs or ladles mounted on wheels, and is taken to the slag tip. The tubs are run on to a siding below the level of the furnace, and the slag run into them through a gutter which slopes from the cinder notch and projects over the siding. The slag is either allowed to solidify before it is dumped on to the slag heap, or it is taken there at once, and run from the ladles in the fluid state. Slag machines are also used which consist of an endless chain of rectangular iron troughs. These are brought one by one under the slag gutter, and as they fill are carried forward, water cooled, and their contents dumped into trucks at the other end of the machine. Large quantities of slag are used for various purposes, but the supply is very much greater than the demand. It may be granulated by running it into water, and then used for making cement and bricks; or it may be converted into "slag wool" by blowing a jet of steam against it as it runs from the gutter. It may also be used as "ballast" for road making. The metal is run from the tap hole at the bottom of the hearth. This is closed by a clay plug while the metal is collecting in the hearth, and is opened by driving an iron bar through the clay stopping into the hearth. As the bar is withdrawn the metal follows it, and brings away the remainder of the stopping, thus making a clear passage for itself. When the metal is to be cast into pigs it flows in a continuous stream down a gutter into lateral channels called "sows." The pig bed is made up of a large number of open sand moulds into which the metal runs from the sows and forms the pigs. When these are sufficiently cooled they are broken away and removed. The metal is always cast in this way for foundry and general purposes; but for steel making, when the blast furnaces are in the neighbourhood of the steel works, it is now the

common practice to run the metal into a tilting ladle, and convey it to a "mixer" furnace from which it is tapped as required.

Grey iron runs from the furnace readily and quietly, but white iron is more sluggish and gives off sparks as it runs. When the tapping is finished a lump of plastic clay is rammed into the tap hole, and being rapidly baked by the heat forms an effective stopping. The intervals between successive taps vary with the rate of working.

The general arrangement of the pig beds and slag machines is shown in the frontispiece.

Furnace Obstructions of various kinds occur from time to time, and these have to be removed if the furnace is to work uniformly. A twyer stopped by a slag nose, or other cause, is usually opened by a pricker rod inserted through the elbow; but sometimes it is necessary to use a cartridge for the purpose, or the twyer may have to be removed while the furnace is in blast. It is interesting to see the last operation carried out by skilful workmen. Another method now coming into use is to direct a jet of coal gas burning in oxygen (the oxyhydrogen flame) against the obstruction, and melt it out. If the obstruction is metallic, it is only necessary to heat it up with the flame, and then direct the jet of oxygen under great pressure against it. The metal in front burns, and the heat developed melts that behind it, and a passage is blown through. The gases for the blow-pipe are contained in steel cylinders under great pressure. The furnace man can usually tell how a particular twyer is working from its appearance through the "eye." He knows, for example, that a bright twyer is doing more work than a glowing one.

Other obstructions occur that may be more difficult to remove. Thus the materials of the charge when they get into the softening zone may stick to the sides of the boshes and form a kind of shelf on which the descending charge

lodges. This is termed a *scaffold*, and when the charge recedes from underneath leaving an empty space, it may give way, and thus cause a *slip*. The furnace then resumes its ordinary working. Scaffolds rarely occur above the boshes, and are commoner in hot blast than in cold blast working. They usually occur over the twyers, and where two are formed on opposite sides they may gradually extend inwards, and form a bridge right across the furnace. This is the most difficult form of scaffold to deal with. Sometimes they extend right round the furnace in the form of a ring. These obstructions are indicated by the irregular working of the furnace, which influences the nature of the metal, slag, and furnace gas.

They are located by the appearance of the twyers, and by sounding the level of the charge in the top of the furnace. This is done by inserting a long iron rod until it touches the charge, which is always higher over the obstruction. Irregular charging with bad distribution, soft or small ore, weak coke, unsuitable flux, and the internal shape of the furnace are the common causes of their formation. Various means are employed to dislodge a scaffold after it has formed. A crowbar may be sufficient when it is just above the twyer. The temperature of the blast may be increased, and petroleum injected to get a very high temperature, and so melt it away. Special twyers are sometimes inserted above the ordinary twyer level, and in some furnaces means are provided for doing this, otherwise the furnace has to be cut through from outside. Suddenly cutting off and turning on the blast will sometimes "jerk" the obstruction down.

American Blast Furnace Practice.—Great reductions in the cost of blast furnace working have been effected in the United States by the introduction of mechanical appliances for handling the raw materials right from the time they are run on to the works' siding until they are dumped into the

top of the furnace. The same may be said of the molten metal and slag run from the bottom. The increase in the rate of production by the use of hotter blast and more powerful blowing engines has also tended to reduce the cost; while the extra wear upon the furnace by this very rapid driving has been met by the introduction of water-cooled plates into the walls of the boshes and the combustion zone. There has been, generally speaking, no increase in the size of the furnaces. Howe states that a single furnace in Ohio has made no less than 806 tons of Bessemer pig-iron in twenty-four hours. An idea of the magnitude of the operations entailed by this rate of working is obtained from the statement that, roughly, 1,400 tons of ore, 700 tons of coke, and 400 tons of limestone have to pass through the furnace to produce the output; and that no less than 4,000 tons of air must be

blown in at the bottom of the furnace, while 1,200 tons of slag will leave it with the outcoming metal. It is questionable whether the primitive language of the ancient ironworker with his goatskin bellows would have been of much use in helping him to express his surprise at such operations.

Operations of this magnitude could not be carried on without considerable help from mechanical appliances, and

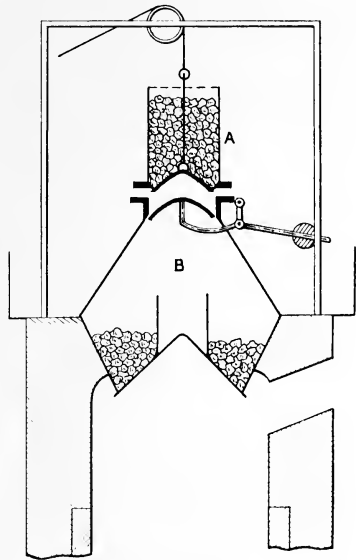

FIG. 18.

a short description of how it is done will make the matter clear. The ore, fuel, and flux are run direct from bins into the charging buckets, which are then raised by a cable hoist to the top of the furnace. The loaded bucket A, Fig. 18, which is fitted with a flange and movable conical bottom, is then lowered on to the top of a flanged hopper B, that encloses the cup and cone-charging arrangement, and the conical bottom of the bucket is allowed to drop a little, when the charge falls out into the charging hopper. The bucket is then lifted and passes back to receive another charge. When enough has accumulated in the cup the cone is lowered, and the charge passes into the furnace. This is the common method of mechanical charging.

The metal is not tapped into the pig moulds direct, but into a mounted ladle, which is then run to the pig casting machine (Uehling's), that consists of a large number of iron pig moulds formed into an endless chain mounted on sheaves, on which it moves round two horizontal drums. The metal is run from the tilting ladle through a funnel into the moulds as they slowly pass under it. The filled moulds are carried forwards and downwards into a water cooling tank, in which they are submerged during part of their journey, and the cooled pigs are dropped into a railway truck as the moulds pass over the end cylinder. The moulds pass back under the tank to receive a fresh cast.

Or, the metal, after it has been tapped from the furnace into the ladles, is passed on direct to the Bessemer shop for conversion into steel. The slag is removed by a machine of similar construction to the above, delivered into trucks, which hurry it off to the slag tip.

As many as three, and sometimes four, hot blast stoves with a total capacity about three times that of the furnace they serve are used for each furnace. Only one stove is "on blast," the others being "on gas" in the proper order.

The most modern stoves differ very little in principle from the Cowper stove described on p. 81.

The world's output of pig iron has increased enormously, in fact, more than doubled, within the last five-and-twenty years, and from what has been said it is not surprising that America has shot far ahead of all other iron producing nations in this respect.

Iron Alloys.—Pig metal containing a much higher percentage of other elements than is usually present in the ordinary pig is sometimes produced in the blast furnace. These are the iron alloys or ferro alloys now so largely used for a variety of purposes.

Ferro Silicon.—Alloys containing up to 20 per cent. of silicon can be prepared with little difficulty in the blast furnace. For this purpose it is necessary that the charge should be very siliceous, and the furnace worked at as high a temperature as possible. This means a very hot blast, a large fuel consumption, and a slag acid in character, so that the proportion of limestone in the furnace charge must be reduced.

Ferro-Manganese.—These alloys, which contain from 5 to 85 per cent. of manganese, are a common product of the blast furnace. When they contain from 5 to 25 per cent. of manganese they are classed as spiegeleisen, and when from 25 to 85 per cent. as ferro-manganese. The general conditions for their production are very hot working and sufficient lime to prevent too much of the manganese from passing into the slag. But it cannot be kept out entirely, on account of the great fluxing action of its oxide MnO . The charges are usually prepared to allow $\frac{1}{4}$ to $\frac{1}{5}$ of the manganese present to pass into the slag, according to the richness of the ore charge. The carbon is higher and the silicon lower than in ordinary pig iron. The following is a typical ferro-manganese: $Mn = 82.23$, $Fe = 11.0$; $C = 5.95$; $Si = 0.2$.

Ferro-Chromium.—This alloy is much more difficult to

prepare in the blast furnace than either of the above alloys. The ore used is the well-known chrome iron ore, and it is usually smelted in a small cupola furnace. Unless the whole of the chromium is reduced the slag becomes very pasty, due to the presence of oxide of chromium in it. This seriously interferes with the working of the furnace, and sometimes stops it altogether, portions of the furnace having to be pulled down to remove the obstruction. A very high temperature must be maintained by a very hot blast, and the fuel consumption is about three times as great as for ordinary pig. Carbon is greedily taken up by the alloy, and as much as 12 per cent. may be present. Forty per cent. chromium is the highest for the blast furnace method. Richer alloys were formerly made in crucibles. Now they all come from the electric furnace. Fluor spar, alkaline carbonates and borax are often used as fluxes.

Typical analysis: Cr = 65; Fe = 22; C = 12; Si = 0.4; Mn = 0.4.

PIG IRON.

The metallic product varies with the general working of the furnace, and with the composition of the charge, but it is stated that with care upwards of 70 per cent. of the particular grade worked for can be obtained. The different varieties of pig iron depend upon the nature and proportions of the other elements present with the iron. The proportion of carbon generally lies between 2 and 4 per cent., and when it is practically all in the free or graphitic form the pig is decidedly grey, and its fractured surface has a characteristic crystalline appearance due to the graphitic scales present in it. Grey pig is usually siliceous, and may contain from 0.5 per cent. to 4 per cent. of silicon. Phosphorus, sulphur, and manganese are present in varying proportions. Still, if non-phosphoric ores are smelted, and the furnace is worked at a high

temperature with a sufficiently basic slag, the pig may be remarkably free from both phosphorus and sulphur. Thus very high grade grey pig can be made even with the hot blast.

The different grades of grey pig iron are indicated by numbers. Thus, Nos. 1, 2, 3 and 4 are foundry irons.

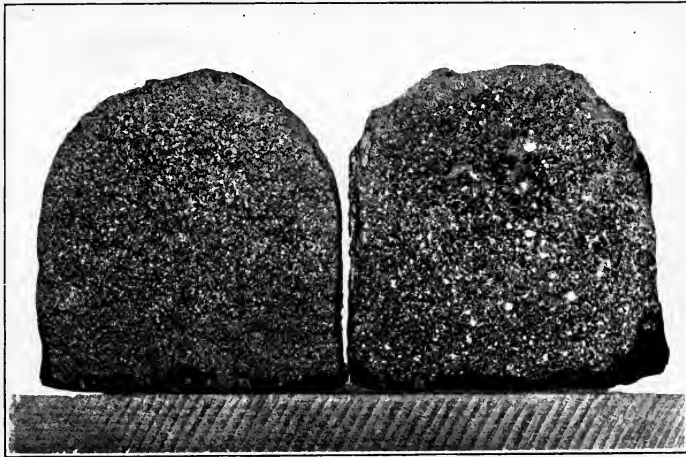

No. 4.

FIG. 19.

No. 1.

No. 1 is the greyest, and has the most open fracture, while No. 4 has a much closer grain, and is a stronger iron. No. 4 forge is also a grey iron, but is more phosphoric than the corresponding foundry iron, and is generally used for conversion into wrought bars.

Now, iron, carbon, and silicon may be regarded as the normal constituents of grey pig, and it may be taken as a general rule, that as the number increases the proportion of the carbon in the combined state also increases, while the percentage of silicon decreases, and the grain becomes

closer. But this is merely a generalisation, for appearances are often deceitful, and experts are sometimes misled by the fracture of the pig, which does not depend entirely upon composition. Thus an iron may be classified as No. 1 that is really No. 2 or even No. 3. For foundry purposes analysis is the only true guide. The difference in the appearance of the fractured surfaces of No. 1 and No. 4 grey pig is shown in Fig. 19. The white specks in No. 1 are plates of graphite. When the greater part of the carbon is in the combined form the fractured surface of the pig is white, crystalline, and free from graphitic scales. It is then described as white iron. The total carbon is usually less than in grey iron, and the silicon under 1 per cent. As the proportion of graphite increases patches of grey iron appear on the white surface; this variety of pig is known as mottled iron. The variation in the form of the carbon in the three varieties may be shown in a general way as follows:—

	Grey.	Mottled.	White.
Graphite	3.40	2.20	0.12
Combined carbon	0.08	1.43	3.17
Total carbon	3.48	3.45	3.29

In Staffordshire the grade numbers are from 1 to 8, and in America from 1 to 10. The last number in each case is white iron. In the north of England and Scotland the grades are usually 1, 2, 3, 4, 4 forge, mottled and white.

A common form known as "cinder" pig is produced in districts where the puddling process is carried on. The cinder from this process, which is rich in iron, also in phosphorus and sulphur, is used freely in the furnace charge, and an impure pig results that is distinguished

from the "all mine" pig, which is made entirely from ores. At the present time cinder is being used in the furnace charge for the production of "basic" pig required for the Bessemer and open hearth processes.

Cold Blast Irons.—For some purposes it is still found necessary to smelt iron ores with cold blast, although for reasons already stated the cost of production is considerably increased, and the irons command a higher price. The principal uses to which these irons are put are to improve the mixture for foundry purposes, to make the best qualities of wrought bar, and for casting chilled rolls.

The best Yorkshire cold blast iron is smelted from a calcined clay ironstone with a good quality coke low in sulphur. The furnace charge consists of $2\frac{1}{2}$ tons of calcined ore, $1\frac{1}{2}$ tons of coke, and 1 ton of limestone. The output is about 25 tons of pig per day; but this varies with the size of the furnace. With a large furnace such as that used at Low Moor the output is about 350 tons per week.

The *World's Output* of pig iron for fifty years, and the share taken in it by Great Britain, is shown in the following table:—

Years.	Total output in millions of tons.	Great Britain's output in millions of tons.
1855 . . .	6·4 . . .	3·2
1865 . . .	9·7 . . .	4·8
1875 . . .	14·0 . . .	6·3
1885 . . .	22·0 . . .	7·4
1895 . . .	33·0 . . .	7·7
1905 . . .	53·0 . . .	9·5

It is not to be expected that this country could possibly keep pace with America, considering the enormous resources of that country, and the great demand made upon them by its rapid development during the last twenty-five years. When, therefore, America took the lead in 1895, those acquainted with the general conditions of the industry were

not at all surprised. Much the same may be said of the position when Germany advanced to second place in 1903. But the enormous increase in the output is not entirely due to the activity of the Americans and Germans, for France and Belgium have considerably increased their production of pig iron in the last few years. The one consolation to the British ironworker is that his lower position in the iron-producing world is not due to either want of skill or energy on his part, and he must take pride in the fact that most of the great advances had their origin in his own country, or were fathered by his own kin in America.

FOUNDRIY IRONS AND THEIR USE.

Sulphur is one of the most injurious impurities in any form of commercial iron, and, perhaps, the most difficult to remove. It is one of the very few elements associated with iron for which no one has a good word. The iron smelter has, therefore, to take every means of reducing the quantity present in the pig metal, where it is required for foundry work especially, as the simple melting process in the cupola does not remove it. The furnace conditions for smelting pig iron with a low content of sulphur are hot working and a basic slag, and given these conditions, together with raw materials not too high in sulphur, good foundry irons are produced. But hot working means always a powerful reducing zone in which silicon is reduced by carbon and passes into the metal. The same conditions are favourable for the reduction of phosphorus and the passage of this element, together with carbon, into the metal. So that if phosphorus is barred, the ores used must be non-phosphoric. But phosphorus has not the bad reputation among foundrymen that sulphur has; in fact, it is of more or less advantage on account of the extra fluidity it imparts to the molten metal.

Foundry irons are mostly of the grey variety on account of their high silicon content, and their quality is presumably judged by the appearance of the fracture. But the modern foundryman doubts his own ability to give a reliable judgment by fracture alone. There are not many "tricks of the trade" among iron men, and an appearance such as the fractured surface of a pig which does not depend entirely on composition, but is influenced by rate of cooling and other conditions, might deceive the seller as well as the buyer.

The following analyses show the variations in composition of samples of No. 1 and No. 3 grey pig from different sources. The other numbers vary in much the same way :—

Typical Analyses of No. 1 Foundry Irons.

Combined carbon.	Graphite.	Silicon.	Manganese.	Phosphorus.	Sulphur.
(1) 0.25	3.50	3.50	1.75	0.90	0.04
(2) 0.07	3.49	3.15	0.25	0.68	0.01
(3) 0.14	3.50	2.80	1.45	0.88	0.05

Typical Analyses of No. 3 Foundry Irons.

	Staffordshire.		Derbyshire.		Northants.	
Combined carbon	0.07	0.40	0.60	0.30	0.40	0.15
Graphite	3.60	2.70	2.50	3.20	3.20	3.00
Silicon, Si	2.60	2.90	3.30	2.70	3.40	3.00
Manganese, Mn	0.40	2.30	0.25	0.90	0.40	0.20
Phosphorus, P	0.90	1.00	0.60	1.40	1.20	1.30
Sulphur, S	0.05	0.04	0.08	0.04	0.04	0.02

The variation in the percentage of silicon is quite

marked. But when the furnaces of a particular maker are working regularly, the numbers show a gradually decreasing content of silicon, and the influence of this element on the structure of the pig and the appearance of its fracture is clearly brought out. The following are analyses of the first four numbers of a well known brand :—

	Carbon.	Silicon.	Manganese.	Phosphorus.	Sulphur.
No. 1 .	3·38	3·25	0·782	0·40	0·045
„ 2 .	3·38	2·75	0·782	0·40	0·050
„ 3 .	3·38	2·35	0·758	0·40	0·058
„ 4 .	3·38	2·00	0·758	0·39	0·073

The marked difference in the fracture of No. 1 and No. 4 is shown in Fig. 19.

Foundry Practice.—It is very seldom that a single number, or a single brand even, is used for casting purposes. The general practice is to make a “mixture” of different numbers and different brands in order to produce a casting of given composition ; and it is clear that if the composition is judged from the appearance of the fracture of the pigs, the mixing is by pure rule of thumb, and the result may or may not be that desired. The actual analyses of the pig irons to be used are evidently the only sure guides. Small users may have to rely upon the maker’s analyses, but in large foundries the consignments of pig are all sampled, and check analyses made.

In making the mixture the first thing to consider is the limit to the content of phosphorus. This may vary from 0·06 to 2 per cent., the latter, however, only being allowable for light ornamental castings in which strength is of no importance. The usual run is under 1 per cent. for general engineering work. The content of manganese is also



important on account of its influence on the structure and properties of the casting. It strengthens the metal by neutralising the effects of the sulphur, with which it forms a less dangerous sulphide of manganese, and may even cause some of the sulphur to be eliminated in the melting when high sulphur in the mixture is unavoidable. It also closes the grain of the metal and increases its strength in that way. The manganese varies up to 1.5 per cent. in ordinary mixtures. The influence of silicon appears to be exerted mostly in decomposing iron carbide and setting free its carbon in the form of graphite, so that its action is a softening one. Thus the higher the silicon, the lower the combined carbon, and the softer and weaker the metal is. Manganese acts in opposition to silicon, in that it forms a double carbide of iron and manganese which appears to be more difficult to reduce. The content of manganese can be easily raised when necessary by the addition of ferro-manganese to the ladle before casting.

It would be a difficult matter to arrange a mixture in which all the constituents were present in the right proportion, so that one at least must be treated somewhat loosely, and that one is usually carbon. The principal thing is to arrange for the proper content of combined carbon, as it is this that imparts the required strength and hardness to the cast metal. Thus castings to be turned, planed, etc., contain about 0.2 per cent.; while those required to have considerable tensile strength contain about 0.5 per cent. of combined carbon. Transverse strength is imparted by 0.7 per cent., and crushing strength by 1 per cent. of the combined form. This must be arranged for by altering the content of silicon, taking as the general rule that the lower the silicon is the higher will be the combined carbon. The amount of total carbon is not of great moment, but when too much is present it may be reduced by the addition of steel scrap of known composition. The

content of silicon is often varied by the use of "softeners"—that is, high silicon pig iron and ferro-silicon. The extra silicon acts by separating carbon as graphite, and thus softening the metal. These softeners are very useful when hard scrap is being worked up.

The general effect of melting the mixture is to reduce the content of silicon by from 0·2 to 0·3 per cent. Manganese is oxidised and passes into the slag, and the loss depends upon the original content, but may amount to 0·3 per cent. on 1 per cent. and upwards. Phosphorus is very little affected, and sulphur is more likely to be increased than diminished, by absorbing some from the coke fuel used in the melting.

It is seen that little difficulty should be experienced in obtaining a mixture which in melting should give a very close approximation to the required composition. No one should depreciate the "instinct" born of long practice, and often unerring, that decides the melter to throw in half a pig of this or that brand to a given mixture; but at the same time it only requires a little knowledge of percentage and proportion, together with the analyses of the pigs, to be reasonably certain of the result. In good practice, then, the foundry manager has a stock of different brands of both hot and cold blast irons, together with good scrap, ferro-silicon, and ferro-manganese. With these any kind of castings can be produced.

Malleable Castings.—This name is given to a class of small castings made from white and mottled pig irons. These irons do not contain sufficient silicon to cause the carbon to separate as graphite to any extent when they are rapidly cooled from the molten state. The mottled irons are used for small castings and the white iron for larger ones. They are very hard and brittle, and require further treatment before they are fit for use. This will be described in Chapter XII. The content of silicon in the metal varies

from 0.4 to 1 per cent., and should not exceed this very much, or graphite will separate even in the rapidly-cooled castings.

The *Cupola* used for melting pig iron in the foundry is a small ironclad blast furnace. The blast is driven into the furnace through one or more tuyers at a pressure of $\frac{1}{2}$ to 1 lb. per square inch, and is supplied by either a fan or a Root's blower. The pig iron mixture and coke, together

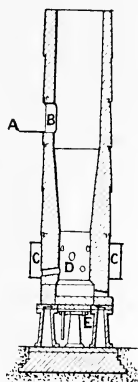

FIG. 20.—Foundry Cupola.

A, Platform.
 B, Charging door.
 c, Blast belt.

D, Tuyers.
 E, Drop bottom.

with a little limestone flux, are charged through the charging door, and the metal is practically fused on a bed of coke through which it sinks to collect in the bottom. When melted it is tapped into a ladle and carried to the moulds. Sometimes it is tapped directly into the moulds. The average consumption of coke may be taken as $1\frac{1}{2}$ cwts. per ton of pig melted. Most modern cupolas are supplied with a "drop" bottom for the ready removal of any unfused material left in at the end of a run. Side doors are also used for the same purpose.

Moulding.—When the selected mixture has been melted in the cupola and tapped into the ladle it is ready for casting, and is taken to the moulds prepared for its reception. The preparation of these moulds is the exclusive function of the moulder, and there are few operations requiring more skill than the making of a good mould from a complicated pattern. An expert once said to the writer: “I can show you how to make a mould, but I cannot tell you how to do it.”

The material used is known as casting sand, and contains just sufficient clayey matter to make it bind when slightly moistened with water, but not enough to cause it to shrink much when the molten metal comes into contact with it. The raw sand is mixed with about 10 per cent. of coal dust, and the mixture is termed “green” sand. If dried before use it is known as “dry” sand. The moulds are generally made in two parts, which are contained in frames or “flasks” to hold up the sand. After the operation by which the pattern is properly worked into the sand the two halves are separated, the pattern removed, and the surface of the impression “faced.” The halves are then put together and clamped in position, when the mould is ready to receive the metal, which is poured in through a channel or “gate” leading from the outside to the interior of the mould. The metal rises in the mould, and finally fills the channel, when the casting is finished.

When parts of the casting are to be hollow, “cores” are prepared of the same shape as the hollows, and are fixed in the impression made by the solid pattern, so that when the mould is complete the metal will run round them and fill every other part of the impression. When the casting is cold, the cores are broken up and removed. The pattern must be prepared so that it will leave the mould readily, and undercut portions must be put into the impression in the same way as a core. Projecting portions, called prints, are

left on the pattern so as to make impressions for the ends of the cores to fit into. They are thus kept into their proper position in the mould.

No pattern is required for "loam" moulding, for the mould is built up of bricks or other refractory materials, and faced with loam. The latter is a very binding sand, and is made plastic by mixing with water. It is then plastered over the rough core and levelled to shape by means of templates.

Some of the moulds for machine and engine parts are very large and complicated, and require much skill and labour in the making. It may be stated generally that however complicated a pattern may be, an expert moulder will take an impression of it, and reproduce it in cast iron.

CHAPTER V.

THE REFINING OF PIG IRON IN SMALL CHARGES.

THE presence of 5 per cent. or more of impurities in pig iron renders it quite unworkable under the hammer, although the softer varieties may be either filed or machined. Thus for iron which is to be forged or rolled the impurities must be sufficiently removed to render the metal weldable and malleable. In the early days of cast-iron this was done by a refining process carried on in a small forge or hearth worked by a blast, and by using charcoal as fuel.

The Swedish Lancashire Hearth.—This refinery may be taken as a type. It consists of a rectangular closed chamber, the bottom and sides of which are built of cast-iron plates. The upper part of the hearth communicates with the stack by a horizontal flue through which the products of combustion pass, and in which the pig iron is placed to get a preliminary heating before being drawn into the hearth for manipulation. The blast, heated to 100° C., is supplied through a single inclined twyer at a pressure of about one pound per square inch. The metal used for the process is a white pig iron low in silicon, phosphorus, and manganese; and about 2 cwts. is drawn from the flue to the hearth to be melted. During the melting down the impurities, principally carbon, are oxidised by the oxygen of the blast, and the metal becomes less fusible; it is then broken up by the workmen, brought in front of the twyer,

more charcoal added, and the blast increased. In this way the impurities are brought within the limits, and the pasty mass of refined iron is ready for the mechanical processes

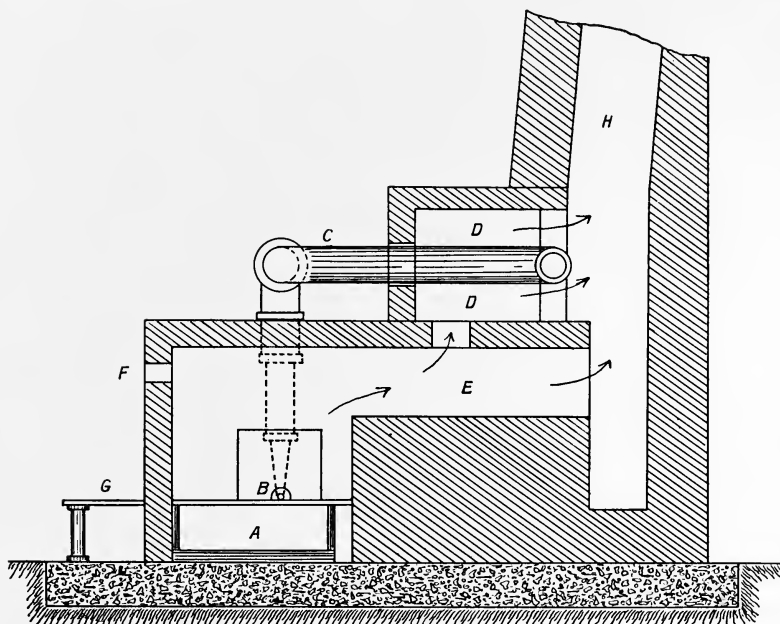

FIG. 21.—Swedish Lancashire Hearth (vertical section).

- | | |
|---------------------------------------|-------------------------------------|
| <i>A</i> , Hearth. | <i>E</i> , Heating chamber for pig. |
| <i>B</i> , Twyer. | <i>F</i> , Rod hole. |
| <i>C</i> , Blast main. | <i>G</i> , Platform. |
| <i>D</i> , Heating chamber for blast. | <i>H</i> , Chimney. |

of hammering and rolling into bars. The cinder obtained is principally ferrous silicate, formed by the oxidation of iron and silicon in the refining. Larger hearths with three twyers were also used.

The excellent quality of the iron produced by this process

is shown by the following analysis, which is exclusive of iron :—

Carbon, C	·05
Silicon, Si	·01
Manganese, Mn	·10
Phosphorus, P	·02
Sulphur, S	·01

In the *Walloon* process a smaller hearth is used, with a correspondingly smaller output, but the metal is said to have more “body” and to be better suited for use in steel making.

The South Wales Process.—It was found that the white pig iron produced in furnaces using coke as fuel contained too much sulphur to furnish a good refined iron; so that grey pig obtained by working the furnace at a higher temperature, with a more basic slag, and consequent reduction in the sulphur content, had to be used. This gave rise to a modification of the process by refining in two stages. The first stage is conducted in a larger hearth with several twyers, and consists in melting down the grey pig to largely remove the silicon and convert it into the equivalent of white pig. The charge of about 5 cwts. of metal when perfectly fluid is divided between two smaller hearths, and the refining finished as described above. By having the smaller hearths at a slightly lower level the metal can be run direct to them from the larger hearth at the conclusion of the melting down stage. But sometimes it is tapped into a flat plate mould and then broken up while still hot and tender, the broken pieces of “plate metal” being melted and finished as before.

This process was used very extensively for the production of the very malleable iron used in the manufacture of “charcoal plates” for the tin plate industry. It has, however, been almost entirely superseded by the introduction

of ingot iron; but there are still some old-fashioned people who specify that the metal they buy must be made by this process. There is one forge still in regular use within twenty miles of Birmingham in which pig iron is refined in a hearth, and the product worked into sheets and bars by water power. In other districts, too, hearths are still kept in readiness for the supply of special orders. Old processes, like prejudices, die hard.

The Puddling Process.—This process is a comparatively modern one, as it was first used by Cort in 1784. It introduced quite a new feature into the refining of iron, for up to that time the metal to be refined and the fuel used to develop the necessary heat were mixed together in the same hearth, hence only a pure fuel, such as charcoal, could be used. But in Cort's method the refining furnace is divided into three parts: (1) the grate in which the fuel is burnt; (2) the bed or hearth upon which the refining is carried on; and (3) the chimney for creating the necessary draught. In such a furnace, which belongs to the well-known *reverberatory* type, the chimney is at one end of the bed and the grate at the other; so that the flame and products of combustion from the grate must pass over the bed to reach the chimney, and by having a low and properly formed roof, materials placed on the bed can be raised to a high temperature without coming into contact with the fuel. Thus there is much less risk of contamination, and raw coal can be used for firing. Also, by regulating the admission of air an oxidising or reducing atmosphere can be maintained over the bed. According to Prof. Gowland, furnaces based upon this principle were used for copper smelting as early as 1583, so that the form of furnace was well known in Cort's time.

Assuming that the cast iron to be refined was similar to that already dealt with in the description of the older processes, carbon and silicon were the chief impurities to

be removed, and Cort's original process is open to a simple explanation. The furnace bottom was lined with silica sand, and the white iron heated upon it would assume a pasty condition, not becoming perfectly fluid at the furnace temperature. Then by well exposing it to the oxidising atmosphere over the bed, oxide of iron would be formed, and assist in the oxidation of the silicon and carbon. Thus by keeping the pasty mass well stirred up, the metal would gradually come to "nature," and could then be made up into several balls for removal from the furnace. The loss of metal was very large, for in the production of one ton of bars two tons of pig iron had to be used. This would mean the formation of a considerable amount of cinder, which would obtain its silica largely from the acid lining, and the bed would require frequent repairs. Also, the actual refining was very slow, from two to three hours being required for the puddling of $2\frac{1}{2}$ cwts. of pig iron. In the palmy days of the process it was considered good practice to obtain one ton of bars from 26 cwts. of pig.

The original furnace bottom was probably a solid one, but in 1816 Rogers substituted an iron bottom, protected by oxidised iron, for the sand bottom; this added materially to the life of the bottom, and reduced the loss of metal during refining.

It was found that the white pig iron produced in coke blast furnaces contained too much sulphur to furnish good quality puddled iron; so that the expedient of converting the purer, but more silicious, grey pig produced at higher temperatures into white iron in the coke refinery was adopted. This refinery was largely used in Staffordshire, Yorkshire, and South Wales some fifty years ago, and is still in limited use in Yorkshire for the production of a special brand of iron.

The Refinery or Running-out Fire may be described as a shallow rectangular hearth having an area of 4 square

feet and a depth of 18 inches. The back and sides are formed of hollow cast iron blocks through which water can circulate, and the front consists of a solid iron plate containing the tap hole. A rectangular space above the hearth is enclosed by two wrought iron side plates, two swing doors at the back, and a single lever door in front, the whole being surmounted by a chimney to carry off the products of combustion. The blast is supplied by six tuyers, three on each side. They are inclined downwards at an angle of 25 to 30 degrees so as to blow into the hearth, and are arranged so that they do not blow against each other.

To run down a charge a layer of coke is spread over the bottom of the hearth and blown up to a red heat. The blast is then turned off, the doors at the back opened, and part of the charge of grey pig iron thrown in. More coke and pig iron are added, until the full charge of from one to two tons of metal is added; then the doors are closed, the blast turned on, and the charge melted down. During the melting both silicon and iron are oxidised and a fluid cinder formed; also some carbon is oxidised, together with phosphorus and sulphur, so that a partial refining is effected. A comparison of the analyses of the pig iron used and of the refined metal obtained shows that the content of sulphur is reduced somewhat, and that of the phosphorus rather more. This is due to the very basic character of the cinder formed by the oxidation of iron and silicon. When the metal has run down it is tapped into a shallow iron mould, which is so supported that water can circulate underneath to keep it cool. The metal is thus rapidly cooled and the carbon kept in the combined form, with the result that a white iron is obtained. The cinder, which runs from the hearth with the metal, is tapped from the surface into another mould when the metal itself has solidified. The cooling of the metal is also hastened by

throwing water on to it. The "plate metal" thus obtained is broken up and puddled.

In 1830, J. Hall, of the Bloomfield Ironworks, Staffordshire, discovered the effect of adding oxide of iron to the puddling charge in the furnace, and noticed the boiling up due to the rapid oxidation of the carbon by the oxygen of the rich oxides added. This no doubt suggested the modern process of "pig boiling," which is now almost exclusively used in the manufacture of wrought iron by the puddling process.

The Puddling Process of To-day.—The puddling furnace, a vertical section of which is shown in Fig. 22, is a rectangular fire-brick structure, about 12 feet long, 4 feet wide, and 6 feet high, cased outside with iron plates, which are held in close contact with the brickwork by means of tie rods that pass along and across the structure, and are kept in position by nuts screwed on the ends. The low roof is slightly arched across the direction of its length, and slopes down a little towards the flue-bridge. The grate is at one end, and is separated from the bed by the fire-bridge, which stretches right across the furnace. The grate bars are supported on bearers let into the opposite walls. A rectangular opening in the working side of the furnace, about 12 inches above the bars, communicates with the grate space, and is used to feed the grate with fuel during the operation. There is no door to this opening, and it is usually closed with lumps of coal in the intervals of firing. The foundation of the bed is formed of iron plates, and is supported either on iron standards, or on brickwork built out from the side walls. It is so arranged that air can freely circulate under it to keep it cool. The side plates are solid, but the fire-bridge and flue-bridge are hollow castings through which air can freely pass. The fire-bridge is cased with fire-brick on the grate side and top, the brickwork projecting a little over on the bed side; the flue-

bridge is protected in a similar manner. The working doorway opens on to the middle of the bed, and is furnished with a door suspended by a chain from the end of a lever, and is kept in position by guides at the sides. It is readily raised or lowered, as it is nearly balanced by a weight at the other end of the lever. The door itself consists of an

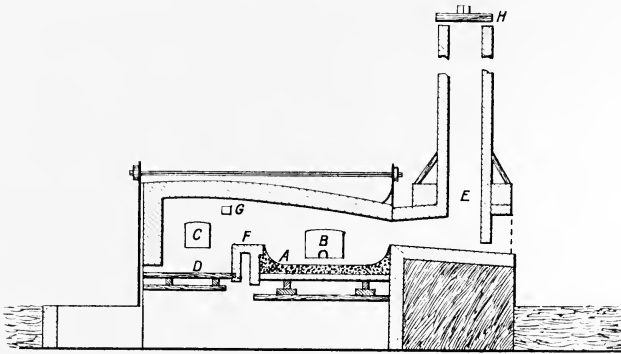

FIG. 22.—Puddling Furnace (vertical section).

- | | |
|------------------|-----------------|
| A, Working bed. | E, Chimney. |
| B, Working door. | F, Fire-bridge. |
| C, Firing door. | G, Staff-hole. |
| D, Grate. | H, Damper. |

iron frame lined with fire-bricks, and has a small opening called the *stopper hole*, in the middle of the bottom edge. The heavy projecting piece of iron on which the door rests when it is down is known as the *fore plate* and beneath it is the *cinder notch*, through which the cinder is tapped from the bed. The fore plate is used as a rest for the tools in working the furnace.

The flue-bridge slopes down somewhat to the opening into the stack which, when used for a single furnace, is about 40 feet high. A tall chimney is necessary to give the requisite draught, but it must be under control. This is effected by a damper on the top, which can be raised or

lowered by means of a chain suspended from the end of a lever, and within reach of the puddler. Sometimes several furnaces are connected to one high stack ; in that case the flues from the several furnaces are controlled by their own dampers. When the waste heat of the furnace is utilised to raise steam the flame and products of combustion pass through a boiler fixed over the top of the furnace before passing to the flue. A portion of the boiler can be seen in Fig. 23.

In preparing the bed for work the iron bottom and side plates are covered with a protecting layer of material rich in oxides of iron. This is effected by spreading a layer of crushed tap cinder of good quality (best tap) over the bottom, and then firing to soften it. This is again covered with a layer of hammer scale and hæmatite ore about 2 inches thick. Then the side plates are "fettled" by ramming "blue billy" (roasted pyrites) and "bull-dog" (roasted tap cinder) all round the sides and ends under the projecting brickwork, and levelling up the banks with puddler's ore, or calcined pottery mine. This is a black-band ore found in the pottery districts of Staffordshire.

The selection of the various materials for forming the bed depends to some extent on the kind of pig to be puddled and the quality of the product expected. The purer materials are used in the production of the better qualities of wrought iron. Also, with a very siliceous or "hungry" pig iron the fettling is made as refractory as possible.

The Process.—The coal used for firing is of the free burning, bituminous variety, for a caking coal would coke to a solid mass in the grate, and hinder the draught. It should also be fairly free from ash to avoid excessive clinkering of the bars. One-third lumps and two-thirds fine are used, and about 25 cwts. is consumed per ton of puddled bars produced. The following is a general descrip-

tion of the process: The furnace bottom being hot and in good condition, about $\frac{3}{4}$ cwt. of fluxing cinder (hammer slag) is first shovelled through the working door on to the bed; then the charge of about $4\frac{1}{2}$ cwts. of pig iron is thrown in and the door closed. The pig iron commonly used for the puddling process is hot blast metal of either the grey or mottled variety (forge pig), and contains all the elements usually present in pig iron, namely, carbon, silicon, manganese, phosphorus and sulphur; but the last element should be low if good quality iron is to be produced. Now it will be well to consider how these elements are eliminated from the metal during the process. With the exception of the carbon, they are present in the pig as compounds of iron, and to separate them from the metal it is necessary that they should be converted into oxides, and that these oxides should be completely removed from the main mass of metal. In Cort's process this oxidation was said to depend largely on the oxygen of the air, oxide of iron being first formed and then acting as a carrier of oxygen to the impurities in the main mass of metal. In wet puddling the oxygen is supplied largely by the oxides in the fettling, although the air no doubt plays an important part. It would appear that silicon and carbon are easily removed, and that manganese offers no difficulty; but the last portions of the phosphorus are difficult to get rid of, and sulphur is always a troublesome impurity to deal with.

Both the red oxide, Fe_2O_3 , and the black oxide, Fe_3O_4 , no doubt assist in the refining, but it is usually considered that the latter plays the more important part. The following gives a general view of the changes:—

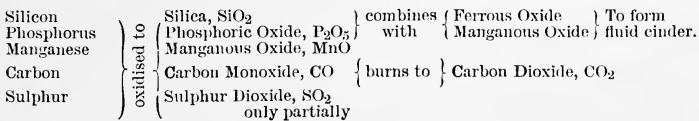

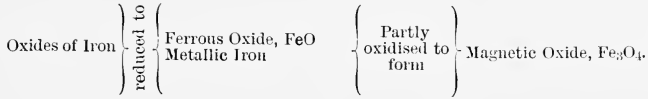

The fluid cinder is the receptacle for all the impurities that leave the refining metal, except the carbon which



FIG. 23.—Working Side of Puddling Furnace.

finally escapes as carbon dioxide, and probably a small portion of the sulphur, which escapes as sulphur dioxide. The larger proportion of the cinder, often upwards of 80 per cent., consists of the monosilicate of iron, $2\text{FeO} \cdot \text{SiO}_2$, the remainder being made up of ferric oxide, phosphoric oxide, manganous oxide, lime and alumina.

The question then arises as to how the refining is actually effected in the furnace. The oxidation of iron itself by the free oxygen in the furnace gases would result in the formation of the black oxide, Fe_3O_4 ; and a similar change would

take place between the various impurities and this free oxygen, resulting in the formation of their oxides, should they come into contact. The impurities, however, are shielded more or less by the large mass of iron present. But they are all capable of reducing oxides of iron to the metallic state, so that it is most probable that these oxides are the chief oxidisers, although they may be formed in part by the atmospheric oxidation of the iron itself. Now the better the contact between the oxidising material and the bodies to be oxidised the more readily does the oxidation take place. The contact between solids is very imperfect, and reaction between them correspondingly slow; but the contact between solid and liquid, or between liquid and liquid, is much more intimate, and reaction between them takes place much more rapidly. Ferric oxide is a somewhat refractory body, but when strongly heated is converted into the more fusible black oxide. Therefore the latter would appear to be the more probable oxidiser. Ferrous oxide in the form of ferrous silicate, although quite fluid at the furnace temperature, is not so readily reduced as the higher oxides, for not only is the ferrous oxide more difficult to reduce, but also its combination with silica increases its stability. But this fluid cinder will dissolve the black oxide and thus bring it into close contact with the material to be oxidised. Siemens advocated the black oxide theory of refining, and Snelus was of opinion that ferric oxide plays the more important part, but the former explanation is the one mostly accepted. If, however, the black oxide is regarded as complex in constitution, and is represented by the formula $\text{FeO} \cdot \text{Fe}_2\text{O}_3$, then it may be looked upon as the medium for carrying the otherwise infusible Fe_2O_3 into the liquid cinder, and thus increasing its oxidising power. Whatever may be the true explanation, the refining is very rapid, and a considerable quantity of metal must be reduced from the cinder. The total iron in

the finished product is usually greater than the total iron in the pig itself, and this can only be accounted for by the reduction of iron from the fettling. Say that the loss in puddling is from 3 per cent. to 5 per cent. between pig and bar, and that the pig contains 6 per cent. of impurities, this would show a gain of from 1 per cent. to 3 per cent. of metal; but when the loss due to oxidation while the balls are standing in the furnace, and are being worked into bars, is taken into consideration it is seen that the quantity of iron reduced from the fettling must be considerable. This is by no means an extreme case, for it is not unusual to obtain the same or even a greater yield of bar than of pig charged. But there is no reason why silica, for instance, should not partially reduce the higher oxide, and thus produce a base for the silica formed, thus:—

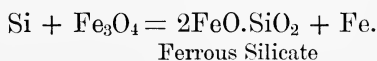

The equations usually given to show the oxidation of the various impurities are as follows:—

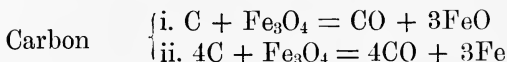
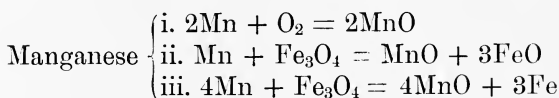
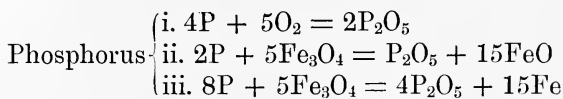
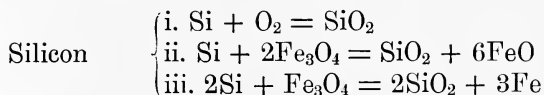

The removal of sulphur is somewhat obscure, and some authorities state that it is not oxidised at all. It is probable, however, that some sulphur dioxide is formed and

escapes, and that the remainder of that eliminated passes into the cinder as sulphide of iron or manganese. The presence of manganese in the charge helps in the elimination of both phosphorus and sulphur, for the metal acts as a cover to the carbon, and thus prolongs the fluid stage, so that the phosphorus is more perfectly oxidised. It also readily combines with the sulphur, and carries it into the cinder.

The part taken by ferrous oxide is twofold: part of it unites with silica and phosphoric oxide to form silicate and phosphate of iron respectively, and part of it is oxidised to the black oxide again, which thus acts as a carrier of oxygen to the charge. It is sometimes stated that the phosphorus is largely removed as phosphide of iron, squeezed out during the shingling, but this is hardly borne out by the composition of the hammer slag.

It will now be easy to follow the changes taking place in furnace as the charge works down. In describing the process it is usual to divide it into stages, although these naturally run into one another in the actual working. They are—

I. *The Melting Stage*, in which the pig metal put into the furnace as described above is melted down into a liquid bath on the bed together with the fluxing cinder; and the most uniform results are obtained when the two melt simultaneously. In the interval the puddler watches his charge, and turns the pigs over to ensure uniform heating, and when the melting is well on the way stirs up the fluid portion collecting on the lower part of the bed. The melting stage occupies about 35 minutes, in which oxidation goes on freely. Silicon, manganese and iron are rapidly oxidised, and phosphorus to a smaller extent. The oxides thus formed pass into the cinder. Towards the end the bath settles down, and becomes clear.

II. *The Fluid Stage*.—The temperature of the bath is

kept up while the puddler thoroughly mixes or "rabbls" the charge, thus bringing the rich cinder and the metal into intimate contact. The remainder of the silicon and manganese, and a further portion of the phosphorus, are oxidised and pass into the cinder. This stage occupies from 7 to 10 minutes, and towards the end jets of blue flame appear on the surface.

III. *The Boiling Stage.*—The damper is lowered to reduce the draught somewhat. The surface of the bath now presents the appearance of boiling, due to the rapid escape of carbon monoxide formed by the oxidation of the carbon. The jets of gas, "puddlers' candles," burst through the surface and burn with a blue flame, and the bath rises several inches; the cinder overflows and runs over the fore plate. This portion of the cinder is known as "boilings." The mass is then well rabbled to prevent the iron from sinking to the bottom. The refining metal is now becoming pasty, due to the rise in the melting point of the purer iron. Small patches of bright metallic-looking matter appear in different parts of the bath, and grow larger. The iron is now *coming to nature*. This stage lasts about 25 minutes.

IV. *The Balling Stage.*—The puddler has now to gather the bright patches of purified metal together, and form them into balls of about 80 pounds each, turning them over to get them uniformly heated. Oxidation of the metal is prevented as much as possible by keeping the damper down, but at the same time the temperature of the furnace must be maintained so that the puddled balls may be hot enough for the shingling operation. The cinder is tapped through the cinder notch into small iron waggons. The balling stage lasts about 15 minutes, and when the balls are drawn from the furnace on to the iron trolley, by which they are taken to the forge, the puddler's work is done. The full time of working off a charge is about $1\frac{1}{2}$ hours; but this depends somewhat on the skill of the workmen, as

well as on the character of the pig iron to be treated. A puddler and his underhand can work through 6 heats per day, and if Longfellow's lines,

“Something attempted, something done,
Has earned a night's repose,”

are true of the blacksmith, still more are they true of the puddler, than whom no man endures harder or more exhausting labour.

Materials and Products.—Pig iron for puddling is usually a close-grained, strong, grey iron, No. 4 forge, but mottled iron is also used. When a very soft, ductile iron is required for special purposes, the puddling charge consists of “foundry irons,” and the other materials are carefully selected. A typical pig may be said to have the following compositions, exclusive of iron:—

Carbon, C	3·5
Silicon, Si	1·5
Manganese, Mn	1·0
Phosphorus, P	1·0
Sulphur, S	variable.

The tap cinder is usually described as “boilings,” and “tappings,” the latter of which is the purer, as it is tapped from the furnace towards the close of the process. The following analyses given by Turner show the difference in the composition of the two portions of tap cinder usually obtained.

	Boilings.	Tappings.
Ferric Oxide, Fe_2O_3	6·94	12·90
Ferrous Oxide, FeO	62·61	64·62
Silica, SiO_2	19·45	15·47
Phosphoric Oxide, P_2O_5	6·32	3·90
Not determined	4·68	3·11
	100·00	100·00

Manganous oxide, MnO ; lime, CaO ; magnesia, MgO ; alumina, Al_2O_3 , and sulphur are generally present in small quantities, and are included in the "not determined" given above.

Shots of metal are often present in the "boilings," and can be separated from the powdered cinder by a magnet. This might be expected, as the cinder in swelling up is sure to bring away portions of the metal entangled in it.

Hammer slag is purer and richer in oxides of iron than the tappings, for oxidation of the metal takes place during the shingling, and the oxides formed mingle with the expelled cinder.

Bull-dog is the refractory residue obtained by the calcination of tap cinder in a free current of air. The calcination is carried on in small kilns. Part of the tap cinder liquefies and separates from the main mass, bringing with it the greater part of the phosphates. It either settles on the bottom of the kiln, or drains away through special openings. It is more siliceous than tap cinder, and is known as "bull-dog slag." The bull-dog itself consists largely of ferric oxide and free silica. The mode of formation may be expressed by the equation:

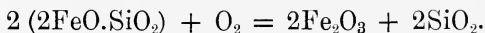

It is used to a limited extent in the fettling of the furnace bottom.

Blue billy or purple ore is the oxide residue left in the pyrites burners used for roasting iron pyrites in the manufacture of sulphuric acid. When it is used for fettling it should be low in sulphur, less than 0.5 per cent., and free from copper, which is often present in small quantities in pyrites, for both these elements tend to make the finished metal "red short." Spanish cuperiferous pyrites that has been roasted for sulphuric acid, and the residue

treated for the extraction of its copper, furnishes a good quality purple ore containing upwards of 95 per cent. of ferric oxide.

Pottery mine is a black band ore containing manganese, which occurs in the pottery district of Staffordshire. It is calcined for use in the puddling furnace, and in the calcined state is rich in oxides of iron.

Best tap is the cinder from a mill furnace worked with an oxide bottom. It contains about 94 per cent. of iron oxides, and only 3 per cent. of silica. When it can be obtained it takes the place of ore in the fettling.

Hammer scale consists principally of the black oxide, Fe_3O_4 , and is collected from round the hammers and rolls used in forging and rolling re-heated iron.

The following materials are given by Prof. Turner as the average quantities for a "turn," which usually consists of 6 heats, in the manufacture of best Staffordshire iron. It gives a good idea of the intake and output of a furnace :

Pig iron	25 cwts. 2 qrs.
Hammer slag	4 ,, 0 ,,
Best tap	3 ,, 0 ,,
Bull-dog	2 ,, 2 ,,
,, (powdered)	1 ,, 2 ,,
Purple ore	0 ,, 3 ,,

The output would be about 25 cwts. of puddled bars, and 13 cwt. of tap cinder.

It is not unusual when the pig and fettling suit each other, and the puddler is skilful, for the yield of bars to be heavier than the charge of pig iron put into the furnace. In the production of common iron the quantity of fettling used is less than that given above, and less care is taken in its selection. Also the yield is usually less than the pig charged, the difference amounting to from 3 per cent. to 5 per cent. That is, a ton of pig produces from 19 cwts. to

19½ cwts. of bars. But as there is often as much as 7 per cent. of impurity removed, some iron must be reduced from the fettling, and pass into the refined metal.

A pig high in silicon and phosphorus is said to be "hungry," and uses up the fettling very fast, so that a purer and more refractory fettling should be employed. Generally much care is taken in proportioning the quantity and quality of the fettling, for if the cinder is deficient too much of the iron itself will be oxidised, the cinder will thicken, and be unable to do its work properly, with consequent deterioration of the product.

Mechanical Puddling.—For many years the puddling process was responsible for the production of such constructive ironwork as could not be made of cast iron, and much attention was given to such modifications of it as would reduce the excessive labour required, and increase the output. Apparatus was designed in connection with stationary furnaces to relieve the puddler, and among the most successful were those of Pickles, Eastwood, and Clough. In all these an arrangement of levers, supported on a frame above the top of the furnace and worked by a small engine, gives a to and fro motion to the rabble across the bed, and a similar motion at right angles to this. These two motions compound and give to the rabble a stirring motion that can be directed to any part of the bed by the puddler, who holds the free end of the rabble. It is worked, as usual, through the stopper hole, but the puddler is relieved of much of the labour of rabbling. The drawback to the use of all these mechanical contrivances is that they cannot do the balling up, and this is really the heaviest part of the work. Therefore they never came into very general use.

With regard to the increased output, larger furnaces were built with doors on both sides, so that the charge could be worked simultaneously by the puddlers and their underhands. A heavier charge could thus be worked, but the

product was not so uniform on account of the difficulty of keeping the temperature equal, and of providing men of equal skill for the two sides. Still, such furnaces were found to be economical of fuel and fettling. A still larger furnace with four working doors, two on each side, was tried in America.

Revolving Furnaces.—A measure of success was obtained by the use of revolving beds, some of which were made to revolve round a horizontal axis, and others round an axis slightly inclined to the vertical. But as such furnaces are now practically out of use, only a short account of them need be given.

The Danks Furnace.—This is a reverberatory furnace, of which the middle portion or bed consists of a cast iron cylinder with conical ends. The cylinder is four feet long and five feet three inches in diameter, and is made of segments bolted together. It is furnished inside with a number of radial ribs to keep the fettling in place, and when in position is geared so that it can be rotated round a horizontal axis. The foundation of the bed consists of a moistened mixture of non-siliceous ore and lime plastered on and then well dried; and the working surface is made by melting on to this a mixture of hammer slag and ore, and then throwing in lumps of refractory ore to roughen it. The grate has a closed ashpit, and the air for the combustion of the coal is blown into the ashpit under a light pressure, and also in jets over the top of the fuel in the grate. The draught can thus be controlled, and the flame varied as desired. The other end of the cylinder is fitted with a movable flue-piece, that can be pushed back when a charge is to be introduced or withdrawn. The smaller furnaces were designed to work a charge of from five cwts. to six cwts. of solid pig with the usual fettling, but in the larger furnaces a ton of pig iron melted in a cupola and transferred to the cylinder together with the necessary fettling of rich ores and

best tap cinder can be worked through in about thirty minutes. The molten pig and fettling are well mixed together by the revolution of the bed, and the refining is very rapid. The fluid cinder is tapped from the flue end, and the puddled ball removed through the flue opening, very large apparatus being required to handle it and to work it up on account of its size. The cost of repairs in this furnace is very heavy, but in spite of this it was very largely used in America for many years, due principally to the high price of labour in that country; but in England, with cheaper labour, it did not pay, and was used only to a limited extent.

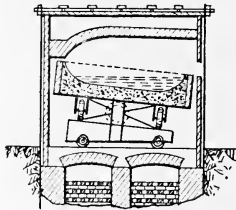

FIG. 24.—The Pernot Furnace.

The Pernot Furnace.—The bed of this furnace consists of a shallow circular iron pan formed of segments riveted together. At the centre, and underneath, a short shaft is fixed at right angles to the surface, and the whole is fitted to a circular trolley, so that the bed slopes at an angle of 6° from the horizontal. The

upper surface of the trolley slopes at the same angle as the bed, and is, therefore, parallel with it. A number of rollers connected with the bottom of the bed are made to run in a channel round the circumference of the trolley, and help to support the bed while allowing it freedom of motion round the central driving shaft. The trolley carrying the bed is run in through a gap in the furnace at the back and brought into position under the roof, and between the fire bridge and the flue bridge. When in place, the lowest part of the bed is directly under the working door on the other side of the furnace. If a new bed has just been put in, the central shaft is connected with the driving gear, consisting of a worm and worm wheel driven by a small engine, and the working bottom

is made up of iron ore and tap cinder melted on and levelled by the aid of the rotating shell. The prepared bed may be described as a shallow basin sloped so that molten matter will run down and collect in one part. The charge of pig iron (15 cwts. to 20 cwts.) is introduced with the fettling and melted. The bed is then rotated at the rate of three revolutions per minute. In this way the fettling on the upper part of the bed is oxidised by exposure to the furnace gases, and is then carried into the metal on the lower part of the bed, there to exert its refining influence, and then to be brought out again by the motion of the bed to absorb more oxygen. In this way the fettling and the scrap, which is often introduced, acts as an oxygen carrier to the impurities. The rotation of the bed takes the place of the rabbling in the hand-worked furnace, but when the iron has come to nature the balling up has to be done by hand. The whole operation, including shingling, occupies about two hours. The labour required is the same, but less fatiguing, and with more rapid working there is greater economy of fuel. The initial cost is heavy, and the wear considerable. The furnace has also been largely used for steel making, which will be referred to later. See Fig. 24.

Washed Metal.—Sir I. L. Bell found that by mixing rich oxides of iron, such as iron ores, hammer scale, etc., with molten pig iron a violent reaction is set up, and in a few minutes practically the whole of the silicon, phosphorus, and manganese is removed, while the carbon is very little affected. If then the refining is stopped at this stage a very pure white cast iron is obtained. Krupp, of Essen, used the Pernot furnace fettled with rich oxides for carrying out the process. The molten pig metal is brought straight from the blast furnace and run on to the bed of the furnace, and the necessary oxides added. In from five to ten minutes there is a sudden evolution of carbon monoxide, when the process is stopped and the metal tapped. The Americans

are making a specially pure washed metal containing only traces of silicon, phosphorus, manganese, and sulphur, with 3·25 per cent. of carbon. It is a practically pure alloy of iron and carbon.

Gas Furnaces for Puddling.—A number of furnaces have been designed for working with combustible gas instead of coal, and the most successful of these are based upon the regenerative principle adopted by Siemens. The working of a charge in one of these furnaces is much the same as in a coal-fired one, and the method of using the gas will be made clear in Chapter VIII. The economy of gas firing was recognised as early as 1855, and its popularity is evidenced by the fact that the gas puddling furnace, under various names, has been largely used in this country, on the Continent, and in America.

Yorkshire Bar Iron.—The best quality Yorkshire bar has long been noted for its uniform quality and excellence. That made at the Low Moor Works is, perhaps, the best known. A short description of the pig iron used is given on p. 107. The pig is a grey or strongly mottled iron, containing about 3·5 per cent. of carbon, 1 per cent. of silicon, and 0·5 per cent. of phosphorus. It is first refined in a refinery similar to that described on p. 120. In this process nearly all the silicon and the greater part of the phosphorus is removed while the carbon is very little affected, owing, no doubt, to the contact of the metal with the coke fuel in the hearth. The charge consists of about 1½ tons of pigs placed on a bed of coke, and melted down by a blast driven in under a pressure of from 1½ lbs. to 2 lbs. per square inch. The blast is directed downwards into the bath of metal, and its oxygen oxidises both impurities and metal. Much care is required in conducting this refining, and in judging the right time to stop. The metal and slag are tapped into a shallow iron mould, water thrown on to the mass to solidify it, and the slag removed.

The plate of white iron thus obtained is about 3 inches thick, and contains all its carbon in the combined form. The plate is broken up, and the iron puddled; but as there is very little silicon and phosphorus to be removed very little fettling is required, and the puddling is "dry." The puddling furnace in which the process is carried on differs somewhat from the ordinary type. At the flue end is a heating chamber called the "dandy," in which the charge is made red hot by the furnace gases on their way to the flue. The bed is formed of iron plates, and the charge when drawn from the flue at a red heat is rapidly worked upon it. The metal does not actually melt, but remains in a pasty state, and is kept at a welding heat while the carbon is being removed. When the refining is finished the mass is broken up into a number of balls, which are taken to the hammer to be shingled into "noblins," about 12 inches square and 2 inches thick. These are then broken into pieces, and sorted according to their fracture. The pieces are then piled, re-heated and hammered into billets, which are again re-heated and rolled into the required form. The soft fibrous pieces give the most malleable bars.

As 10 heats of about 3 cwt. each are worked off in 12 hours the process is very rapid, and this is due to carbon only having to be removed in the final process.

CHAPTER VI.

CRUCIBLE AND WELD STEEL.

THE general effect of carbon on iron would be noticed at a very early date, as it is absorbed by the metal at a comparatively low temperature in sufficient quantity to influence the working properties of the metal. But although the real cause of the useful properties of ancient steel was not known, these properties were taken full advantage of in the manufacture of cutting tools and weapons.

Bergman (1781) was the first to trace the modification in the properties of iron to the presence of variable proportions of carbon.

The ancient term *steel* was applied to the variety of iron which could be forged and welded; hardened and tempered by heating and sudden cooling; and often softened and toughened by heating and slow cooling. Most of these properties are possessed in high degree by iron containing about 1 per cent. of carbon. As the percentage of carbon decreases the hardening property decreases, and below 0·2 per cent. carbon it practically disappears; but as the carbon increases the forging property decreases, and in the neighbourhood of 2 per cent. of carbon disappears altogether. Thus there are limits to the amount of carbon permissible in old-fashioned steel, and the various authorities are not quite in agreement with regard to these limits: but there are a number of well-known grades of steel suited to different uses, and these will be noticed later.

The modern term *steel* has a much wider meaning, and includes not only true steel, but also a number of alloys of

iron with manganese, nickel, chromium, tungsten, vanadium, and similar metals, and these alloys furnish steels suited to a large variety of purposes. It is, in fact, the adaptation of steel to modern requirements.

All the ancient iron and steel was what is known as *weld metal*, from the fact that it was produced in a spongy state and then hammered to weld it into a more or less homogeneous mass. Now, by far the greater part of both iron and steel is finished in the molten state, and on that account is called *ingot metal*. The following is a general view of the different varieties of iron and steel depending upon the percentage of carbon present:—

Weld Iron; Ingot Iron	Weld Steel; Ingot Steel
0·05 to 0·25 % carbon	0·25 to 1·8 % carbon
Cast Iron or Pig Iron	
1·8 to 4·3 % carbon	

Weld metal always contains more or less enclosed slag, while ingot metal is quite free from it.

The modifications required in the old direct processes of extracting iron to adapt them for the production of steel may be briefly described before passing on to the more modern methods of manufacture. If in one of these direct processes the operation is prolonged so as to leave the reduced metal longer in contact with the carbon of the fuel; and if the cinder is not too basic in character, or is tapped away more frequently so as to lessen its refining action, the reduced metal is found to contain carbon, and the finished metal possesses the ordinary properties of steel. The prolongation of the smelting is brought about by altering the inclination of the twyer so as to cause it to blow more across the hearth than into it.

Steel may also be made by the puddling process, for if the pig iron contains sufficient manganese to act as a cover for the carbon, and so prevent its too rapid removal, and if

the finishing temperature is kept lower than for iron, the metal on coming to nature will contain carbon. But the process is not sufficiently under control to furnish a uniform product.

The Cementation Process.—High-class carbon steel, or best tool steel, is made in this country from the finest qualities of bar iron, and either Swedish, Russian, or Yorkshire weld iron is preferred. For high grade cast steel best Swedish hammered bar iron, made by the Walloon process in a small open hearth, is generally used. The bars are first caused to absorb carbon by surrounding them with charcoal, and then subjecting them to prolonged heating at a uniform temperature until the metal has taken up sufficient carbon to convert it into steel. The process is called cementation, and is carried on in the cementation furnace (Fig 25).

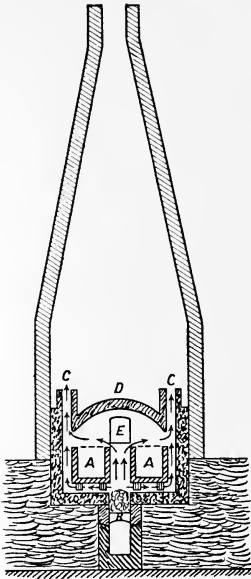

FIG. 25. -- Cementation Furnace.

The firebrick boxes A, A, about 4 ft. by 4 ft. by 12 ft., are built on each side of a fire grate B, running the full length of the furnace, and are arranged so that the flame from the grate can circulate completely round them, and heat them uniformly. The heating chamber is rectangular, and has an arched roof C, sufficiently above the tops of the boxes to allow room for the workmen to charge and discharge them. Six flues, C, C, three on each side, pass through the roof D, where it springs from the side walls, into a conical chimney, which carries off the products of combustion, and also prevents

loss of heat by radiation from the arched roof. The grate is fired through doors at both ends.

The bars for conversion are usually 3 inches wide, $\frac{5}{8}$ inch thick, and 12 feet long. A layer of crushed charcoal freed from dust by screening, part new and part from a previous operation, is placed on the bottom of the box; then a layer of bars with narrow spaces between them, then another layer of charcoal, and so on until the box is completely filled. Each box holds about 12 tons of bars. The top is then covered over with a layer of moist swarf from the grinding troughs, which forms a good tight cover to protect the contents of the boxes from the action of the furnace gases. A trial bar is left protruding through a rectangular slot in the end of each box, through which it can be withdrawn from time to time for examination. It is luted round with clay, where it protrudes from the box, to prevent the admission of air. The firing is then commenced, and in two days the boxes are at a uniform temperature, and the cementation is proceeding regularly. The length of time required to complete the firing depends upon the amount of carbon to be absorbed, but the quantity absorbed also depends upon the temperature. The maximum for 800° C. appears to be about 0.9 per cent. carbon, and increases with the temperature. The temperature usually obtained is about 1000° C., and this is kept up for from eight to eleven days, depending upon whether mild, medium, or hard steel is required. About twelve tons of coal are burnt in the firing. The technical terms for the duration of the heats are spring, country, shear, double shear, and steel through heat. The furnace takes about six days to cool down after the firing is stopped before the workmen can enter to take out the cemented bars.

The converted bars, which are known as "blister bars," on account of their blistered appearance, are broken into short lengths, and sorted into grades by an expert. The

blisters are said to be caused by the reducing action of carbon on the enclosed slag, resulting in the formation of carbon monoxide, which, accumulating in the neighbourhood of the slag patches in larger quantities than will dissolve, raises the pasty metal above the general surface of the bar, and so causes the blister. This explanation was suggested and then proved by Dr. Percy; and it is now well known that mild steel that has been melted, and, therefore, freed from slag, can be cemented without the formation of blisters.

During cementation carbon slowly penetrates the bar from outside towards the centre, and appears to do so by a true diffusion process. On examining the fractured surface of a bar at different stages the shell of converted metal is seen to encroach from all sides on the iron core, which finally disappears in the steel through heat. Roberts-Austen heated iron with diamond dust under conditions in which no gaseous matter could possibly take part, and found that carbon was absorbed into the metal. Abel clamped together accurately planed slabs of steel and iron, and after heating them to a bright red heat for several hours found that carbon had passed from the steel to the iron. Bell made a similar experiment with wrought and cast iron, and proved that the carbon in the wrought iron increased from 0.04 to 0.4 per cent. In the Harvey process for the cementation of armour plates, the absorption of carbon is found to follow the ordinary law of diffusion. But under the conditions that obtain in the cementation boxes it is probable that gaseous compounds of carbon also play an important part. The oxygen of the enclosed air would form carbon monoxide, CO , which is capable of diffusing into the hot iron, and would then give up carbon to the iron, and be converted into carbon dioxide, CO_2 . The carbon dioxide thus formed would escape, and coming into contact with red-hot carbon

on the outside would be reconverted into carbon monoxide. That would again diffuse into the bar, and thus act as a carrier of carbon to the metal. Also cyanogen and hydrocarbons, usually present, would probably assist in the cementation. The action is, therefore, a complicated one.

Weld Steel.—Before Huntsman's time (1740) the blister bars were piled, reheated, and hammered or rolled into bars, having a much more homogeneous structure, and this piling, reheating, and working was repeated with further improvement in the quality of the steel. Even now this is done on a somewhat limited scale for the production of shear steel and double shear steel suitable for welding. But steel used for many purposes can now be made by much cheaper processes. According to Dr. Percy, the original process consisted in cutting the blister bars into ten-inch lengths, which were then raised to a red heat and drawn out under the hammer into longer and thinner bars. Several of these were then made into a pile, one end of which was gripped by a holder, and dusted over with a mixture of clay and borax to prevent oxidation. The pile was then reheated in a hollow fire, hammered down, turned in the holder, the other end reheated and hammered. This formed a bar of single shear steel; and if it was cut into two, the two halves put together, reheated, and again hammered into a single bar, this formed the double shear steel. The finer varieties of steel were imported from Germany.

Crucible or Cast Steel.—Huntsman, a clockmaker of Doncaster, succeeded in melting blister steel in a crucible and casting it into an ingot, by which metal quite free from slag, and practically homogeneous, was obtained. He removed to Sheffield, which soon became the home of the crucible steel process, and has remained so to the present day. It is carried on there in many large and small works, and produces steel second to none for the purposes to which it is suited.

Steel melting crucibles are made from a carefully selected mixture of fireclays with a little coke dust added. They are 18 inches high and 7 inches wide at the top. Each crucible has a hole in the bottom, and is provided with a circular stand of the same diameter as the bottom. A closely fitting cover with a circular hole in the centre, through which an iron rod can be passed, is put on when the crucible is in position. The crucibles are carefully

dried and heated to a red heat before use. Plumbago crucibles are sometimes used, and are more durable than the clay ones, but there is more risk of too much silicon being reduced and passing into the metal. The melting is preferably carried on in a wind furnace (Fig. 26), using coke for fuel; although gas furnaces of the Siemens regenerative type have been used, and oil furnaces have received some attention. But steel melters say that they get the best results in a coke fired furnace.

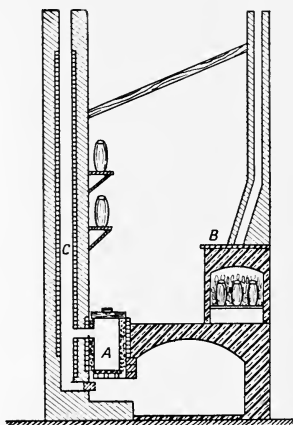

FIG. 26.—Crucible Furnace.
A, Furnace. B, Annealing oven. C, Chimney.

Each furnace or "hole" is oval in shape, and will take two pots side by side with room around them for the fuel. It is lined by putting a wooden core of the proper internal dimensions on the grate bars and then ramming moistened ganister round it. When the core is removed and the ganister well set a very satisfactory lining is formed. When a new pot is used it is placed on its stand in the furnace, a handful of silica sand thrown in to fill up the hole, and the fire made up. When the crucible is hot enough a charge of 50 pounds of blister steel in small pieces is emptied in

through a sheet iron funnel, and the cover put on. It gradually melts, and when "killed" is ready to pour. Considerable experience is required to judge when the metal is in the right condition for pouring; for if it has not been in the fire long enough it will teem "fiery" and the ingot will be full of blow-holes, and if too long it will teem "dead," and the ingot, although sound, will be brittle and unworkable. When the metal is properly "killed" the ingot will be quite sound except for the usual "pipe" at the top. The killing is probably due to the reduction of silicon from the silica in the walls of the pot, and its passage into the steel. Silicon is said to increase the solvent power of the metal for gases, and so produce a sound casting. If too much silicon is reduced and passes into the metal it teems dead.

When the metal has been poured there is a well-defined slag line round the inside of the pot where corrosion has taken place at the surface of the molten charge. The second charge, therefore, consists of 44 lbs. of blister steel, and the final charge of 38 lbs. Each crucible is used for three heats under normal conditions.

The iron moulds are usually square, in cross-section, and produce an ingot about 3 inches wide. They are made in two parts, which are clamped together after the whole surface with which the molten metal comes into contact has been reeked with the smoke from burning tar.

The teeming, as the pouring of the metal into the mould is called, must be done very carefully and at the right time if a sound ingot is to be obtained. The ingot mould is placed in a slightly inclined position to receive the metal, which is poured down the centre of the mould in as thin a stream as possible. The small cross-section favours rapid cooling, and the slow pouring allows the solidifying metal to follow up the incoming fluid, so that the structure of the ingot when cold is uniform, and the pipe at the top is

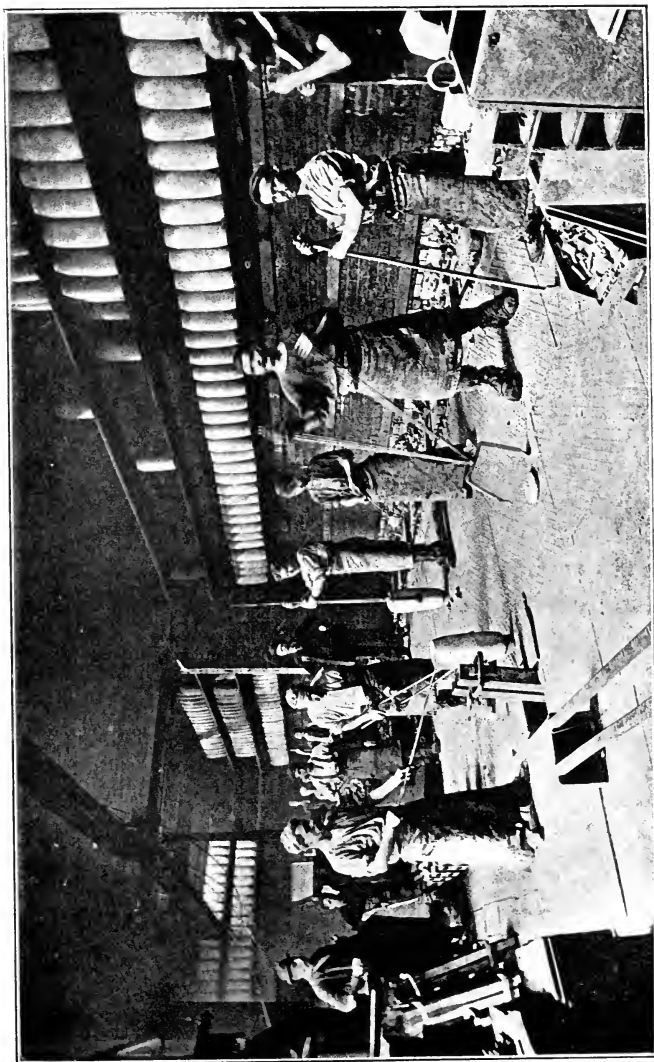

FIG. 27.—Crucible Steel Melting Shop at Norfolk Works, Sheffield.

reduced to a minimum. The presence of the pipe is an indication of sound metal. There is always a certain amount of waste, for the ingots have to be "topped," that is, the piped portion cut off. This is generally about 10 per cent. of the whole.

The melting down of carefully-selected blister bars is without doubt an ideal method for making the highest grade crucible steel; but cast steel is also made from bar iron without cementing it. For this purpose the bars are sheared into short lengths, and charged into the crucible together with a calculated quantity of charcoal to bring the metal up to the required content of carbon. The melter knows from experience what proportion of the added carbon will pass into the metal, and makes his calculations accordingly. A little spiegeleisen is added when the charge is melted, as it is found to improve the quality of the steel. This method is largely employed in America, where cemented bars do not appear to be made.

The melting down of proportioned charges of blister steel and unconverted bar or good quality scrap is largely followed, and forms a very useful general method. The method of making an inferior quality of cast steel by melting bar iron with charcoal and black oxide of manganese was used by Mushet as early as 1801. J. M. Heath strongly heated a mixture of the black oxide and coal tar in a crucible, and added the resulting carbide of manganese to the charge of British bar iron and charcoal. He thus produced a moderately good steel from inferior bar iron.

Pure white pig iron may be melted down with good mild scrap or bar iron. The carbon of the pig is disseminated through the whole charge, and thus brought down. Either Swedish white pig iron or good "washed" metal may be used. Also it is probable that much good open hearth and Bessemer scrap is used in crucible steel manufacture.

When special tool steels are being made the calculated

proportion of the iron alloy, ferro-tungsten, ferro-chrome, etc., is added to the crucible charge, and when properly melted the resulting steel is teemed into the moulds in the usual manner.

It is not often that crucible steel containing less than 0·5 per cent. of carbon is made unless for special purposes.

Generally the range is from 0·5 per cent. to 1·8 per cent., although more carbon can be introduced. But these high carbon steels are very difficult to manipulate, and are only used for special work. A good general view of a steel melting shop is shown in Fig. 27. The melting holes are on the right, nearly level with the floor, and there are no less than 100 of them in the complete shop.

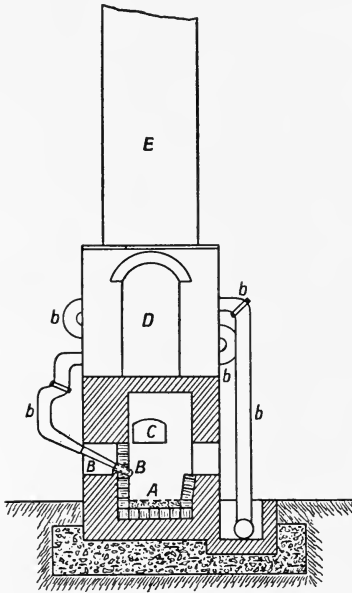

FIG. 28.—Styrian Open Hearth.

excellent quality in a charcoal finery, which is shown in section in Fig. 28. The hearth, A, is rectangular in plan, and is about 30 inches long by 20 inches wide. The sides are formed of cast iron plates inclined at a small angle, and the bottom, or sole, is lined with a brasque of charcoal and slag well stamped in. The blast, which is supplied through an inclined tuyere, B, at a pressure of

Styrian Steel.—The Erzberg, or ore mountain, in Styria furnishes a good spathic ore, from which a very pure white iron is obtained, and this metal is converted into steel of ex-

$\frac{1}{2}$ lb. on the square inch, is heated by being driven through a hot iron pipe *b*, before entering the hearth. This pipe passes to and fro through the chimney, D, where it is heated by the waste heat of the gases escaping from the hearth through C, and the temperature of the blast is thus raised to 160° C. The tall wide chimney is necessary to prevent the escape of sparks into the open air, as the buildings round the works are largely constructed of wood, and thus liable to take fire. The hearth is supplied with charcoal fuel, and when in working order a pile of pieces of white iron weighing about 130 lbs. gripped in a pair of tongs is brought into the hearth and held over the glowing charcoal, but not in the blast. It is balanced by a weight hung on the shanks of the tongs, the edge of the side plate acting as a fulcrum. It is thus gradually heated, and when uniformly hot a second pile of 88 lbs. is placed in the hearth, and the first one brought over the twyer. During the heating the metal is freely sprinkled with slag. The two piles are then melted one after the other, and run down into the hearth. The slag is tapped at once, the blast reduced, and a shovelful of wet slag thrown on to the metal, which then becomes pasty and can be raised in the hearth. The pasty mass is allowed to remain for a few minutes to cool to the proper temperature for hammering, when it is taken to the hammer and divided up into 12 slabs or "massel," which are then ready for reheating and welding. These massel are made into piles to be held in tongs and reheated as occasion offers in the same hearth as the refining is carried on. The various piles in the hearth are moved about as required.

About 2 cwt. of white iron is refined at one operation lasting about 3 hours. The loss is about 10 per cent. of the metal charged in. It is said that a skilful operator can produce refined metal varying from the purest iron to the hardest tool steel at will.

The reheated piles are drawn out into bars under the hammer, quenched in water, broken into short pieces, and sorted. An expert sorter can judge the content of carbon very accurately by the appearance of the fractured surface. Formerly the crude metal thus obtained was cemented by further heating with charcoal, and finished as weld steel; but now the sorted pieces are melted in graphite crucibles for the production of cast steel, as in the case of cemented bars. The composition of the cast iron used and the steel obtained is shown below:—

	Carbon.	Silicon.	Manganese.	Phosphorus.	Sulphur
White Cast Iron .	3·430	0·110	1·010	0·066	0·016
Crucible Steel .	1·020	0·020	0·043	0·019	0·005

A glance at the composition of the cast iron shows that the changes taking place during the refining process are simple in character. Only small quantities of silicon, phosphorus and sulphur have to be eliminated, and there is sufficient manganese to act as a cover for the carbon while they are being sufficiently removed to produce high-class metal. Carbon can thus be kept in the charge until the refining is finished. No working up in front of the twyer, as was necessary in the old fineries, is required. The cinder contains oxide of manganese, which renders it more fluid and less oxidising than ordinary cinder, and so protects the “young” steel as it comes to nature. With the more impure pig worked in this country it is necessary to remove practically the whole of the carbon in order that the impurities may be sufficiently eliminated.

The Styrian process does not depend for its success so much upon skill in working as upon locality. The districts in which the process is carried on are densely wooded, and

abundant supplies of charcoal can be obtained. This is used both for smelting the local ores and for the refining process. Some 55 bushels of pine charcoal are used in producing 2 cwts. of steel. It is only in such countries as Styria and Sweden that these processes can be made a commercial success. Another point of importance is that the country is hilly, and water power is sufficiently abundant to enable the mechanical operations to be carried on by the power derived from turbines and water-wheels. Thus the tilt hammers used in working the refined metal into bars are actuated by water power.

While the pure white iron is the principal product of Styrian blast furnaces, both grey pig and spiegeleisen are made. Also the puddling furnace and the Siemens open hearth are found working side by side with the primitive fineries; but the steel they produce is only mild or middling hard in character. Styrian steel, however, has long been noted, and still holds its own, for an excellence of quality probably second to none.

Case Hardening.—It is often necessary that a tool or part of a machine should possess a moderately soft and tough core with a hard resisting surface. It is then usual to resort to a partial cementation, and the process of case hardening is carried out. This consists in heating the finished machine parts or tools to a sufficient temperature in contact with carbonaceous matter. This is usually either wood charcoal or animal charcoal obtained by charring leather scrap. When a large number of articles are to be treated, they are packed in an iron box with the cement powder, and heated to the proper temperature in a muffle or reverberatory furnace. Care is taken to exclude air by a well-fitting lid; and the duration of the heating depends upon the thickness of the case or shell of cement steel to be formed. A shell about $\frac{1}{4}$ inch thick is formed in about four hours. The articles are then plunged into

water while red hot to harden the surface. Care must be taken that the quenching is sufficiently rapid and uniform for the whole charge, if good results are to be obtained. As the point of saturation depends upon the temperature, this must be carefully regulated, or the shell will be too hard or too soft for the purpose. Many case hardeners are now using pyrometers with their furnaces in order to better control their working. Also the success of the process depends largely upon the condition of the uncemented core or sap of the piece when the shell is hardened. Now this core is not always in the best condition for the purpose when the hardening is effected straight from the cementing vessel; so that it is preferable to allow the articles to cool in the vessel, and to re-heat them rapidly to a red heat for hardening in the ordinary way. This is more trouble, but a better and more uniform result is obtained. When a few small articles are to be case hardened they are heated, dipped in yellow prussiate of potash ($K_4FeC_6N_6$), which supplies the carbon, re-heated, and plunged into water to harden the surface. Various preparations are sold for the purpose, but they all act in the same way by giving up carbon to the hot metal.

The Harvey Process for cementing one side of large mild steel armour plates containing up to 0.35 per cent. of carbon is carried on in regenerative gas furnaces. The bed of the furnace is movable, and consists of a trolley that can be run in and out at will. The bottom of the trolley is covered with a thick layer of fire bricks, in the upper part of which flues are constructed for the circulation of hot gases; and upon this a layer of fireclay is formed. The plate to be cemented is placed on the clay, and covered with a layer of charcoal. On the top of this another plate is placed, and covered with a layer of sand. Another layer of firebrick is arranged on the top of the sand to form a protective covering. The

trolley thus prepared is brought into position under the roof of the furnace. The end doors, which are cast-iron frames filled in with fire bricks, are closed, and the firing is commenced. The carbon diffuses downwards into the bottom plate, and upwards into the top plate, and the amount absorbed depends upon the temperature of the furnace and the duration of the process. This may extend from five to fourteen days. The trolley is moved in and out of the furnace by an endless chain, and the wheels and gearing generally are far enough removed from the working bottom to prevent their being damaged by the heat.

The surface layer of the cemented plate may contain as much as 1·35 per cent. of carbon; but in the inner layers the percentage of carbon gradually diminishes to the original content, say 0·35. The plates are several tons in weight, and usually about 10 inches thick.

When the plates have cooled down sufficiently, they are machined and shaped, if necessary. Then they are re-heated to a cherry red heat in a special trolley furnace, and hardened by quenching with a water spray. This portion of the work must be carefully done, if the surface is to have a uniform resistance.

Some of the uses to which crucible steel is put, with the approximate amount of carbon present, are indicated below:—

Cutlery . . .	0·6 per cent. C.	Taps and dies . . .	1·1 per cent. C.
Chisels . . .	0·7 ,,	Turning tools . . .	1·2 ,,
Dies . . .	0·8 ,,	Long files . . .	1·3 ,,
Saws, chisels . . .	0·9 ,,	Saw files . . .	1·4 ,,
Drills . . .	1·0 ,,	Razors, lancets . . .	1·5 ,,

Shear steel is largely used for welding to iron in the manufacture of edge tools for agricultural and other purposes.

CHAPTER VII.

THE BESSEMER PROCESS.

THE conversion of pig iron into weld iron or wrought iron has already been considered, and the character of the changes taking place explained ; so that the consideration of the problem of converting pig iron into ingot iron and steel will not present any difficulty. The silicon and carbon of the pig must be as completely removed in the case of ingot iron as in the case of weld iron, and for ingot steel the carbon must be either partially removed, or completely removed, and then sufficient carbon added to the metal in the finishing stage to bring it up to the required percentage. Also, if phosphorus and sulphur are present in notable quantities they must be brought down, as in the case of weld irons, so as not to interfere with the working properties of the metal. The presence of manganese in the pig metal presents no difficulty.

In puddling and finery processes the removal of the non-metals is largely effected by the oxygen in basic iron cinders and rich oxides of iron. But there is no reason why the oxygen of the air should not be directly utilised to do the work, providing the necessary conditions can be complied with. This was attempted by Bessemer in the years preceding 1855, in which year he took out a patent for a process that has developed into the process which forms the subject of this chapter.

It is a far cry from the clay crucible with its charge of 12 pounds of pig iron melted in a wind furnace to the modern vessel with its charge of 20 tons of molten metal ; and

Bessemer had a very tedious task to make his process even a partial success.

In explaining the principles of the process it will be best to consider the treatment of a non-phosphoric pig iron, that is, one from which the removal of silicon and carbon only need be considered. If a clay pipe is thrust to the bottom of a charge of such metal in the molten state, and a rapid current of air driven through it, the silicon will burn to silica, much heat will be developed by its combustion, and the temperature of the metal will rise rapidly. When the silicon has burnt the carbon will burn, and the evolution of heat will continue until the carbon has all disappeared. Now this internal heat is developed so rapidly that the rise in temperature of the mass more than keeps pace with the increase in the melting point of the iron as it refines; so that the final metal, though free from silicon and carbon and with a melting point approaching 1600° C., is still perfectly fluid, and can be readily cast into an ingot. But it is impossible to drive air through the metal without oxidising some of it along with the impurities, and the oxide thus formed, in part at least, dissolves in the molten metal, and gives to it the general character of burnt iron, which is unworkable. This was Bessemer's great stumbling block; he could remove the silicon and carbon, but his refined metal would not forge. About this time Mushet was using manganese in a crucible steel process, and he suggested that the addition of manganese in some form to the bath of molten refined iron would remove the oxygen, and render the metal workable. This proved to be the solution of the difficulty; and in practice the manganiferous pig iron *spiegeleisen* was found to be a suitable medium for introducing the manganese. This, however, carried carbon into the charge, and as it was not all removed subsequently, iron often containing more carbon than weld iron was obtained, and to this the term "mild steel" was applied. Now, the manufacture of

ferro-manganese containing as much as 80 per cent. of manganese enables a much smaller quantity to be used in order to introduce the necessary manganese, and as the comparatively small amount of carbon carried in with it is practically all oxidised, ingot iron can be produced at will. It may be remarked in this connection that Styrian and Swedish pig irons, which are often rich in manganese, may produce good Bessemer metal without the addition of manganese, and as much as 0·3 per cent. of manganese be left in the steel.

Part of the oxide of iron formed while the air is being blown through the molten metal combines with the silica, and a slag or cinder rich in silica is produced ; and the oxide of manganese formed during the reduction of the dissolved oxide of iron by the added manganese, not being soluble to the fluid metal, passes out and comes into contact with the siliceous slag, by which it is readily taken up. The manganese thus acts as a clearing agent by removing the excess of oxygen and giving a good workable metal.

The evolution of the Bessemer converter, as the vessel is called, forms a very interesting part of the modern manufacture of iron and steel, and is one of the best examples of difficulties overcome in the march of industrial progress. Bessemer himself recognised the necessity (*a*) of blowing vigorously into the very heart of the metal ; (*b*) of blowing only when the whole of the charge was in the vessel ; and (*c*) of being able to stop or resume the blowing at will. This led to the adoption of a vessel which could be rotated on an axis, and to blowing through the bottom of the vessel. But there are still some moderately successful, fixed, side-blown vessels in use. The converting vessel has undergone various changes both in size and shape ; and several modifications of the simple process of blowing cold air through the molten metal have been tried, but none of them proved successful. The principal are: (1) the injection of finely

divided carbon with the blast to effect the final carburisation; (2) heating the blast to increase the temperature; (3) the blowing in of air and steam alternately; (4) blowing with pure oxygen and hydrocarbons obtained from petroleum to effect the expulsion of phosphorus and sulphur at very high temperatures in a reducing atmosphere of hydrogen and hydrocarbons.

Among the early successes of the original process was a simple converter worked with hand-gearing that turned out ingots of good metal at £18 per ton.

The Acid Bessemer Process.—This is the original process in which the molten metal is always in contact with the highly siliceous lining of the converting vessel, and on that account the slag formed is highly siliceous or “acid” in character. Hence the title of the process, which is sufficiently expressive. On account of the acid nature of the slag, any phosphorus present in the metal at the beginning of the operation is still there at the end; for the character of the slag prevents any phosphoric oxide formed during the blow from passing into it, or if it passes into the slag it is eventually reduced, and the phosphorus passes back into the metal. On this account only pig iron practically free from phosphorus can be used. This has created a demand for a pure pig iron smelted from pure hæmatite ores, and known as Bessemer pig.

The Converter.—The shape of the vessel has varied considerably during its evolution, but the one now largely used is circular in horizontal section, and symmetrical with regard to its vertical axis. It is known as the concentric converter, and the shell, which is made of shaped wrought iron plates one inch thick, held together by straps and rivets, takes the form of a cylinder with a conical end. The bottom edge of the cylinder, which projects inwards, is made of strong angle iron to act as a support for the lining. The conical end forms the neck of the vessel, and is made

separately, so that it can be detached if necessary. Round the middle of the cylindrical portion is fixed a strong steel belt, from the ends of a diameter of which project two trunnions formed of cast iron box sections. The trunnions are supported on piers between which the vessel can be rotated at will. The rotation may be effected by a worm wheel fixed to one of the trunnions, and geared to a screw which is worked direct from the cranks of a pair of hydraulic engines fixed to one of the piers. In this way the converter can be rotated in either direction. One of the trunnions is hollow, and is connected with the blast main by a telescope joint. The working lining is made of ganister (see p. 46), which is moistened with water to make it bind, and then rammed between the inside of the shell and the outside of a wooden core, the space between the two forming the thickness of the lining. The neck is lined in the same manner. The bottom, which is also made separately, consists of a strong iron frame that supports the refractory material forming the working bottom. The central portion, which is usually somewhat raised above the general level, forms the twyer region, and is pierced by a number of slightly conical holes opening above into the body of the vessel, and below into an iron box, the blast chest. The interior of this chest is connected directly by a goose neck with the hollow trunnion jointed to the blast main. The twyers are slightly tapered fire clay cylinders, each of which is perforated by a number of channels $\frac{3}{8}$ inch in diameter. These twyers are passed through holes in the bottom plate which also forms the top plate of the blast chest, so that their inner ends are just flush with the bottom. They are held in position by eccentric catches fitted to the sides of the holes through which they pass, and the ends are luted round with clay. The number of twyers and perforations vary according to the size of the vessel, but 10 twyers, each containing 10 channels, may be

taken as an average, which would represent a blast opening into the converter of nearly 4 inches diameter. The bottom plate of the blast chest, although quite air-tight when in position, is easily removed, so that the twyers can be examined between the heats, and replaced if necessary. The bottom lining is subjected to the principal stress and corrosive action during working, and must be replaced after some 20 to 30 heats, while the side lining will last through from 400 to 500 heats under normal conditions.

The bottom is fixed to the body of the converter by cotters, which are readily removed, and the joint where the body and the bottom meet is made tight by

ramming in a mixture of moistened ganister and clay. There is a hydraulic lift directly under the converter when it is in position, on to which a trolley can be run to be lifted into contact with the bottom when it has to be repaired. In this way an old bottom can be readily taken away, and a relined one put in its place. The general form of the concentric

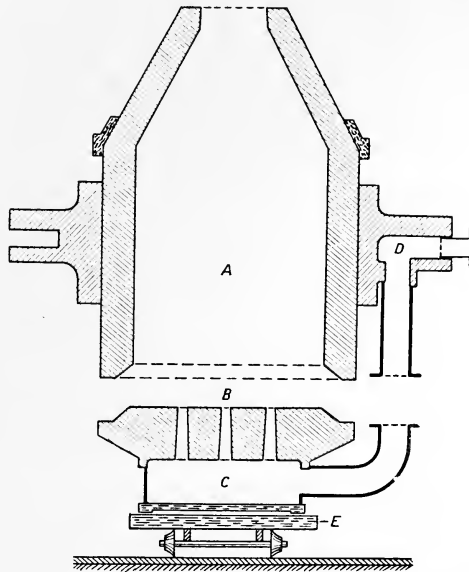

FIG. 29.—Concentric Converter.

- | | |
|-------------------------|-----------------------------|
| <i>A</i> , Body. | <i>D</i> , Hollow trunnion. |
| <i>B</i> , Bottom. | <i>E</i> , Trolley. |
| <i>C</i> , Blast chest. | |

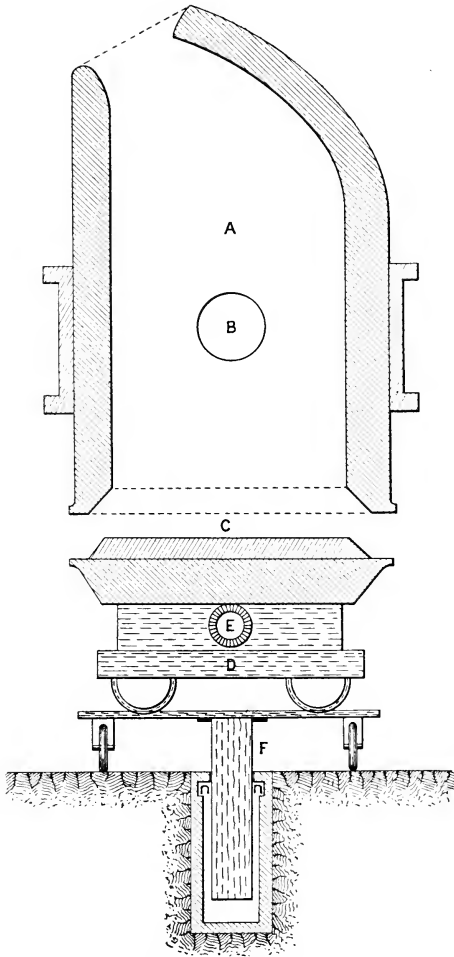

FIG. 30.—Eccentric Converter.

- | | |
|--------------|---------------------|
| A, Body. | D, Trolley. |
| B, Trunnion. | E, Blast main. |
| C, Bottom. | F, Hydraulic table. |

converter, and the method of connecting the bottom with the body and the blast main, is shown in Fig. 29.

A 15-ton converter of the concentric type has the following dimensions:—24 feet 5 inches high and 10 feet 5 inches in diameter; it is mounted on standards or piers 20 feet high, and weighs from 60 to 70 tons. It can be moved readily into various positions round its horizontal axis, such as the horizontal when charging, the vertical when blowing, and the more or less inverted when running slag or metal, or for tipping out residues. It can also be worked from both sides if necessary.

The capacity of a converter depends upon the width of the mouth; the wider the mouth the smaller the capacity, for the whole of the molten charge must lie in the vessel when it is in the horizontal position, and a wide mouth means a shallow bath of metal, and consequently a small charge. The wider the mouth the less the waste through ejection, as the ejected metal has more chance of falling back into the vessel; but the narrower the mouth the higher the temperature obtained in working, and the greater the back pressure. So that there are limits to the width of the mouth, and these can only be determined by practical experience.

In converters of the eccentric type the axis of the neck is at an angle of about 30° to the vertical axis; this increases the capacity of the converter, as the belly is larger; but there is no chance of the ejected metal falling back, and the converter can be worked from one side only. In Fig. 30 is shown the form of the eccentric converter, and the hydraulic table for lifting the bottom into position.

Blowing Engines.—The blast required to work the converter is usually supplied by a double cylinder blowing engine of the horizontal type. The air is driven into a large iron reservoir to convert the pulse-like flow into a steady one, and leaves it under a pressure of, from 20 lbs.

to 25 lbs. per square inch to enter the vessel through the twyer holes.

The Ladles.—These vessels, which are used for bringing the molten pig iron to the converter and for receiving the finished product, must correspond in dimensions to the converters with which they are used, as they have to hold the full charge of metal in each case. The feeding ladle, which consists of an iron shell lined with a course of firebricks, is mounted on a trolley,

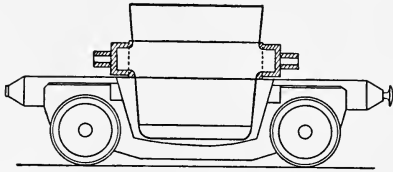

FIG. 31.—Tilting Ladle.

and is fitted with hand-gearing so arranged that the ladle moves laterally towards the converter at the same time as it is tilted over the mouth. So that when the metal is ready to run the lip is well over the mouth of the converter, which has been brought into the horizontal position for receiving the charge. The actual tilting is often done by attaching a chain to the off-side of the ladle, and raising it by means of an overhead travelling crane. The general form of the ladle is shown in Fig. 31. It is drawn along the platform in front of the converter

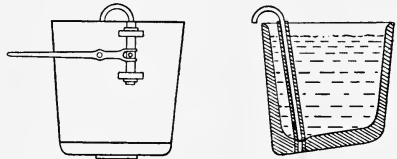

FIG. 32.—Casting Ladle.

by a steel rope. The casting ladle (Fig. 32), which receives the finished metal, consists of a wrought iron shell with a ganister lining that slopes from all parts to the tap hole in the bottom. This is closed by a clay stopper attached to an iron rod coated with fireclay where it is likely to come into contact with the molten metal. The upper part of the

rod is bent over the side in the form of a swan's neck, so as to pass through guides fixed to the outside of the ladle. It is also connected with the short arm of a lever in such a way that when the long arm is raised the plug is lifted out of the tap hole, and when it is lowered the plug is pushed back again. This ladle is suspended on trunnions from the horizontal arm of a hydraulic crane having a circular motion; it can thus be brought under the mouth of the converter to receive the charge, and then over the moulds in the casting pit to cast the metal.

The converters, when there are several of them, are arranged in a row, with a platform running along in front of them at such a height that when the converters are horizontal their mouths are just above it. The charging is carried out on this platform.

Working the Charge.—The converter is hot from a previous blow, or, if newly lined, has been heated by blowing coke in it. The ladle containing the full charge of molten metal is raised to the platform by a hydraulic lift, and drawn in front of the converter. The metal is then run in, the blast turned on, and the converter brought into the vertical position. The pressure of the blast and the narrowness of the tuyer channels through which it is driven prevents the metal from running back into the blast box, and the reactions proceed rapidly. The silicon burns to form silica, which unites with basic oxides to form a slag, and there is very little flame during this part of the blow, as no combustible gases are formed. Then the carbon burns with formation of carbon monoxide, which gives a brilliant flame at the converter mouth. Particles of iron and slag are also driven out, causing a shower of sparks. When the carbon is all burnt the flame drops, and if the blowing is continued the metal itself will oxidise rapidly. The dropping of the flame is usually taken as the indication that this part of the operation, which lasts from ten to fifteen minutes,

is finished. The converter is then turned down, and the blast cut off. The bath is now ready for the spiegeleisen or the ferro-manganese to be added. If the addition is only a small proportion of the whole charge it may be thrown into the converter cold, but if a larger proportion is to be added it must be heated before it is thrown in. The metal is then ready to be run into the casting ladle, which is brought under the mouth, and receives the full charge. The molten metal in the ladle is covered with a layer of slag that has run from the converter with it. This protects the metal from the air, and prevents the too rapid escape of heat from it. The ladle is then brought over the casting pit, the tap-hole opened, and the metal run into the ingot moulds placed there to receive it. The moulds are heavy iron castings, having a rectangular cross-section with the corners rounded off. They are open at the bottom, and a little wider there than at the top, so that they may be readily stripped from the ingots. For casting they are placed vertically on an iron plate in the bottom of the casting pit, and when the metal has set sufficiently for handling they are lifted off by a crane, and the ingots removed in a similar manner. The further treatment of these ingots will be described later.

Analyses of the gas taken from the converter at intervals during the blow show that some of the carbon is burnt at the same time as the silicon, but as the temperature is lower it is burnt to carbon dioxide and escapes as such. Later, when the greater part of the silicon has burnt, and the main bulk of the carbon is burning, the temperature is higher and carbon monoxide is the gaseous product. Thus the carbon dioxide was found to decrease from 10·7 per cent. to 1·3 per cent., and the carbon monoxide to increase from 0 to 31 per cent. in the course of a blow. The nitrogen decreases from 88·4 per cent. to 66 per cent. The high percentage of nitrogen during the earlier part of the blow shows conclusively that the oxygen of the blast is being

principally absorbed by the silicon in the charge. In the early days of the process the character of the flame was carefully noted, and the flame itself was looked at through a spectroscope to observe the appearance and disappearance of certain lines in its spectrum. Now the experience of the blower is more depended upon, and the spectroscope but little used. The manganese present in the pig is oxidised and passes into the slag, but the phosphorus is practically unchanged. Oxide of iron is formed freely, and is in part removed in the slag; the remainder is left in the molten metal to be reduced by the deoxidiser.

If too little silicon is present the blow is "cold"; that is, the temperature does not rise sufficiently for a good finish. According to Howe about 1.25 per cent. silicon is the best for general blowing; but in American practice metal with as low as 0.66 per cent. silicon is blown, and the difficulty is got over by using a converter with a larger bottom and twyer area, so that the bath of metal is not so deep, and the blowing more rapid. The duration of such a blow is usually less than ten minutes, and the blows are made to follow each other rapidly. In this way the converter is kept very hot, and the finished metal is good in spite of the low silicon content of the pig. This rapid working has been tried at Barrow, but was not found suitable for the grade of pig iron produced there, nor for the atmospheric and other conditions obtaining in this country. The twyer blocks in the Barrow converters were reduced from 33 to 24 twyers, for the metal was found to be so hot at the end of the blow as to be quite unmanageable. In Sweden low silicon irons are blown, but the metal is very hot at the beginning.

On the other hand, if the silicon content is too high the temperature rises too much, and this does not give satisfactory results. But this difficulty can be overcome by the addition of cold scrap; this is known as "scrapping." But

this can be avoided by the use of a mixer from which molten metal of fairly uniform composition can be taken. According to Siemens the oxidation of silicon in the molten

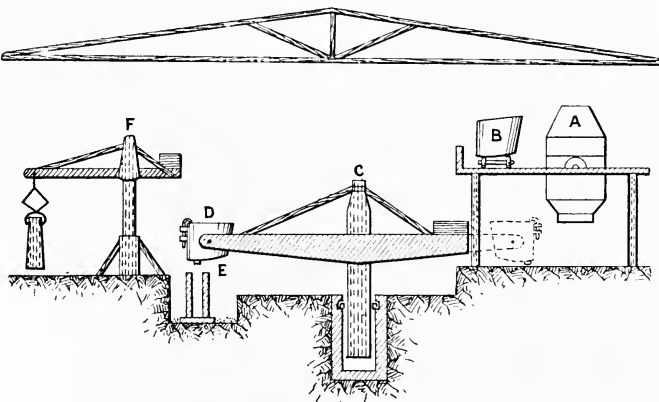

FIG. 33.—Converter and Cranes in Bessemer Shop.

A, Converter. C, Casting crane. E, Ingot mould.
B, Tilting ladle. D, Casting ladle. F, Ingot crane.

bath determines the oxidation of iron to furnish the silica formed with a basic oxide. The general arrangement of the converter and cranes in a Bessemer shop is shown in Fig. 33. The composition of Bessemer pig used in different countries and in different parts of the same country varies considerably; but the following table will give an idea of the working limits:—

	Carbon.	Silicon.	Manganese.	Phosphorus.	Sulphur.
Limits of composition	4·4 to 3·1	2·5 to 0·6	3 to 0·1	0·4 to 0·02	0·15 to 0·02
Typical pig	3·5	2	0·3	0·05	0·05
Finished metal	Variable but fairly under control.	0·04	0·6	0·06	0·05

The slags formed are very acid in character and not at all uniform in composition, some portions not having properly fused. The fluid portion runs from the converter, and collects upon the top of the metal in the ladle as already described; the remainder is tipped out by inverting the converter after the metal has been run. An average composition of slag taken from the converter at different periods of the blow is given below:—

Composition of Acid Bessemer Slag.

Silica, SiO_2	55.0
Manganese oxide, MnO	27.0
Ferrous oxide, FeO	13.0
Alumina, Al_2O_3	3.0
Lime, CaO	1.5
Magnesia, MgO	0.5
		100.0

There are three ways in which the molten pig may be prepared for the process.

(1) It may be run directly from the blast furnace into the feeding ladle, and is then known as "direct metal." But this means that the smelting furnace must be sufficiently near to the Bessemer plant for the metal to be brought to it without undue cooling, and that a fairly regular supply can be guaranteed, or the working of the plant will be intermittent, and therefore costly.

(2) The metal in the form of pigs may be melted down in a cupola and run into a ladle for transference to the converter. This was the method usually adopted, as regular working of the plant could then be ensured. The cupolas used for this purpose vary from 8 feet to 10 feet in outside diameter, and are 14 feet to 24 feet high up to the charging door. They are worked with a blast pressure of

$\frac{1}{2}$ lb. to $\frac{3}{4}$ lb. per square inch. The largest will melt about 16 tons of pig per hour with the consumption of 1 ton of coke. Some of the silicon is oxidised and removed, which is an advantage with high silicon pig, but the reverse when the silicon is low. It allows, however, of the charge being mixed to suit the requirements. This method is being largely used, but will probably gradually disappear.

(3) The most recent method is to take the molten metal from a mixer, which is a kind of reservoir for the molten metal from the blast furnace. This method, which will be described in the next chapter, allows of very uniform working.

The loss of metal from pig to steel varies somewhat, but does not exceed 9 to 12 per cent. for direct metal, and 14 to 15 per cent. for cupola metal.

The Basic Bessemer Process.—It has been known for a long time that when the amount of silica in a refining slag exceeds 30 per cent. that phosphorus will not pass into it, and that practically the whole of that element present in the pig iron is found in the refined metal. For this reason pig iron containing a notable quantity of phosphorus cannot be treated in a silica-lined converter, as the slag formed is very acid in character. It was also known that a sufficiently basic slag would take up practically the whole of the phosphorus from a very phosphoric pig, with the production of good workable metal. But it was also thought, although erroneously, that at a very high temperature phosphorus would not pass even into a basic slag. This tended to retard progress.

As early as 1872 Mr. Snelus succeeded in reducing the phosphorus in a charge of molten pig from 2 per cent. down to 0.1 per cent. by the use of a basic lining, but not in a Bessemer converter, and Mr. E. Riley had worked in the same direction. It was left, however, to Messrs. Thomas and Gilchrist to perfect a practical method for

treating phosphoric pig iron by the Bessemer process, and in doing this they received the assistance of such well



FIG. 34.—Bessemer Converter in Position.

known men as E. P. Martin, Windsor Richards, and J. E. Stead.

The chief difficulty lay in the selection of a suitable lining, but dolomite lime was finally selected, and the

difficulties attending its use on the large scale overcome. The process was first carried to a commercial success in the works of Messrs. Bolckow, Vaughan & Co. at Middlesbrough.

The Basic Lining.—The substitution of a basic for an acid lining constitutes the essential difference between the two processes ; and dolomite lime appears to be the only generally suitable material, although lime itself has been successfully used. The principal difficulties are due to the great shrinkage which dolomite undergoes when it is burnt to form the lime, and to the fact that water cannot be used in the moulding process. The dolomite is first burnt at a temperature sufficiently high to effect the maximum shrinkage, but not high enough to cause the pieces of stone to cinder into a solid mass. A basic-lined cupola worked with a blast pressure of 1 lb. per square inch, and burning $1\frac{1}{4}$ cwt. of coke per ton of raw stone, gives the best results. The coke and stone are charged in alternate layers at the top, and the burnt stone is raked out through a door in the bottom. The partially burnt pieces are picked out and returned to the cupola, none but properly burnt stone being passed on. This is then ground to a coarse powder in a mill under edge runners, and then mixed with hot, well-boiled tar to render the mass plastic. It may then be used for ramming round a core to form the converter lining, as already described for the acid process ; or, as is more common, it is moulded into bricks by being subjected to considerable pressure in a powerful hydraulic press. The moulds in which the bricks are made are shaped so that the bricks will follow the curve of the converter shell, and can be set without the use of mortar of any kind. In lining the converter, the bricks are built a little away from the shell, and the space between is rammed in with the same mixture as is used for making the bricks. This tends to drive the bricks inwards, and force them closer together.

Formerly the bricks were burnt at a low, red heat after moulding; but now they are brought straight from the press, with the exception of a few burnt ones to form the bottom rows. Fig. 34 shows the concentric form of converter, which is almost entirely used in the basic process.

The Basic Bottom.—This is formed differently from the acid bottom. There is the usual frame and bottom plate, which also forms the top of the blast box, in which are a

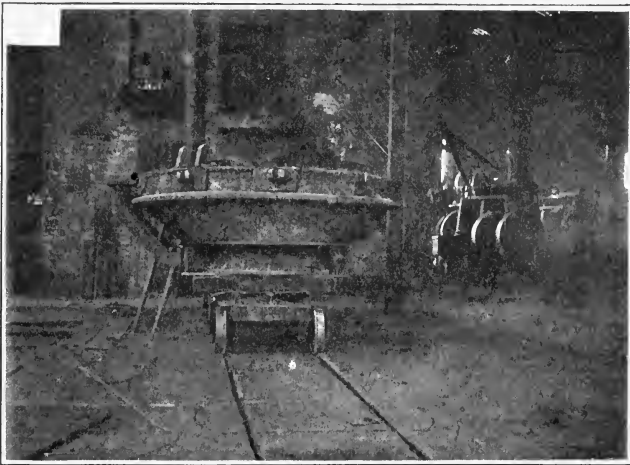

FIG. 35.—Converter Bottom in Repairing Shop.

number of holes corresponding to the number of air channels required in the tuyer plug, or central portion of the bottom. Iron rods are placed upright in these holes, a large iron ring fixed round them, and the dolomite mixture well rammed in between the rods with a circular rammer having a central hole large enough for a rod to pass through. In this way they are uniformly rammed round. The iron ring is then withdrawn, and the remainder of the bottom rammed in. When the rods are taken out, channels are

left for the passage of the blast from the chest to the interior of the converter. The bottom is brought into position and secured as already described. Fig. 35 shows a bottom in the repairing shop. The grinding mills for the basic material are on the right.

The Process.—The details of a blow vary somewhat in different works, so that the following must be taken as a general description. The converter is already hot from a previous charge, or has been heated by blowing fuel in it. A quantity of lime, about 3 cwt. per ton of metal, is added, together with some coal, and blown until hot. The converter is then brought down, and the charge of molten pig run in from the tilting ladle. The blast is now turned on, the converter rotated into the vertical position, and the blowing continued. In about 10 minutes the silicon, the carbon, and the greater part of the manganese, together with a small part of the phosphorus, have been oxidised, and the flame drops; the blow is continued for 2 or 3 minutes, during which the remainder of the phosphorus is oxidised. There is no positive indication of the disappearance of the whole of the phosphorus from the metal; but long and careful observation enables the blower to detect even slight changes in the appearance of the flame. He is, therefore, able to tell how the blowing is proceeding, and when the metal is ready for the deoxidiser. However, he is unable to rely entirely on his judgment, so that the converter must be brought down at intervals during this *after-blow*, a sample dipped out with a small ladle, and tested. For this purpose the metal is poured into a round mould, hammered into a round plate about $\frac{1}{2}$ inch thick under a small steam hammer, broken across, and the fracture examined. An expert can tell from the appearance of the fracture whether the blow is to be resumed, or whether it has gone far enough. The presence of phosphorus causes the metal to crystallise, and as the element disappears the

size of the crystals decreases. The blowing is continued until the test piece shows a granular fracture.

When the blow is finished, the slag is run into a truck on the roadway below the platform, or on the floor directly under the converter, and the bath of metal is ready for the addition of the deoxidiser. If mild steel is being made, the weighed quantity of ferro-manganese, broken up into small lumps and made red hot, is shovelled into the con-



FIG. 36.—Casting Basic Steel at Spring Vale Works.

verter, and the bath allowed to stand for a few minutes to soak. It is then run into the casting ladle and taken to the casting pit. The ladle in position over the moulds is shown in Fig. 36. While the bath is standing, after the addition of the ferro manganese, reactions are set up by which some phosphorus is caused to pass back into the metal, but the blower always blows the metal until the percentage of phosphorus is lower than that allowed in the finished metal, so as to compensate for this passing back.

Sometimes the converter is turned up, after the addition of the ferro-manganese, and the blow continued for a few seconds before the metal is poured. The casting ladle in position over a mould is also shown in Fig. 33. If higher carbon metal is required, as for the production of rail steel with about 0.4 per cent. of carbon, the addition is not made to the converter. The metal is run into the ladle with as little slag as possible, and the proper proportion of molten spiegeleisen added to it there. But the changes indicated above still take place, for it is impossible to prevent some slag from running into the ladle and forming a layer on the top of the metal. The carbon and manganese of the spiegeleisen react on this slag, and a little phosphorus is reduced and passes back into the metal.

The oxidation of the phosphorus during the after-blow seems to determine the oxidation of iron to a greater extent than in the acid process, and the addition of 2 to 3 per cent. of manganese is necessary to obtain metal workable at a red heat, for the oxygen must be cleared out while some manganese is still left in the metal. It would appear, according to some authorities, that if carbon monoxide is formed, it acts upon the phosphate in the slag, and phosphorus passes back into the steel; but manganese acts as a cover for the carbon by preventing its rapid oxidation, so that as long as manganese is present, phosphorus remains in the slag. Stead, however, is of opinion that manganese itself will reduce phosphate of lime, and he thus accounts for the phosphorus that passes back into the metal.

If a manganiferous pig is being blown, it is found that as much as 0.2 to 0.3 per cent. of manganese may be left in the metal after the phosphorus has been removed, and as this tends to prevent over-oxidation during the after-blow, less ferro-manganese or spiegeleisen is required to be added. Also other additions, such as hæmatite pig, silicon-

spiegel, and carbonaceous matters have been used in order to reduce the quantities of the usual deoxidisers to be added. In the case of the higher carbon steels, it should be noticed that the deoxidiser is also the recarburiser.

The removal of sulphur does not appear to be by any means certain. Sometimes it is nearly all eliminated, at others a considerable proportion remains in the finished metal. To obtain sulphur-free metal a manganiferous pig, in which the sulphur is always low, should be used.

The slag is an important item in the basic process, for it contains much phosphate of lime, and is valuable as a manure. It is removed from the Bessemer shop to the slag mill, broken up and ground to a fine powder. It is then ready for the market. The composition of the slag must be controlled as far as possible, and frequent analyses of it made, for the presence of much oxide of iron in it means loss of metal from the charge, and a correspondingly lower output. Sufficient lime must be added to prevent this. The lime should be of good quality, with a low content of silica, as this acid oxide requires from three to four times its weight of lime to slag it off, with a consequent decrease in the lime available for the removal of phosphorus. The following will give a general idea of the composition of basic slag:—

Lime, CaO	50·0
Phosphoric oxide, P ₂ O ₅	20·0
Ferrous oxide, FeO	15·5
Silica, SiO ₂	7·0
Manganous oxide, MnO	4·0
Alumina, Al ₂ O ₃	2·0
Magnesia, MgO	1·0
Sulphur, S	0·5
	100·0

The general composition of the pig iron used, and of the finished product, is shown below :—

	Carbon.	Silicon.	Manganese.	Phosphorus.	Sulphur.
General limits .	3·3 to 3·6	0·54 to 1·7	0·4 to 1·5	1·2 to 3·0	0·03 to 0·15
Suitable pig .	3·2	1·5	0·5	2·2	0·06
Finished steel .	Variable but fairly under control.	0·016	0·54	0·092	0·04

It is just as necessary that the phosphorus content of "basic" pig should not fall below a certain limit as that there should be sufficient silicon in "acid" pig. The reason for this is that the character of the blow depends upon the amount of phosphorus to be oxidised, and if there is not sufficient, a cold blow is the result, that is, the metal is too cold for satisfactory casting, and skulls, or masses of solidified metal, are left in the ladle. On the other hand the silicon content must not be too high or the blow is hotter than it should be, and equally unsatisfactory results are obtained. Sometimes a very siliceous basic pig has its silicon blown down in an acid lined converter, and is finished in a basic lined one. The judicious addition of cold steel scrap is very useful in the case of very hot blows, and is known as "scrapping." Fig. 37 shows the cranes and moulds in position, and gives an idea of the cramped condition of a Bessemer shop.

Small Converters.—Such vessels are still in use where small charges of steel are manufactured, and are either fixed or arranged for tipping, as the case may be. They are side blown, and with the fixed converters the finished metal is tapped from a tap-hole which is plugged with clay

while the blow is going on. The blast box is usually in the form of a belt round the body of the converter, and the twyers lead from it through the side lining. The blast pressure is lower than is used for bottom blown vessels, and averages about 6 lbs. per square inch. High quality metal is produced in Sweden in acid lined converters of this type, but it is only fair to say that the pig iron used is of

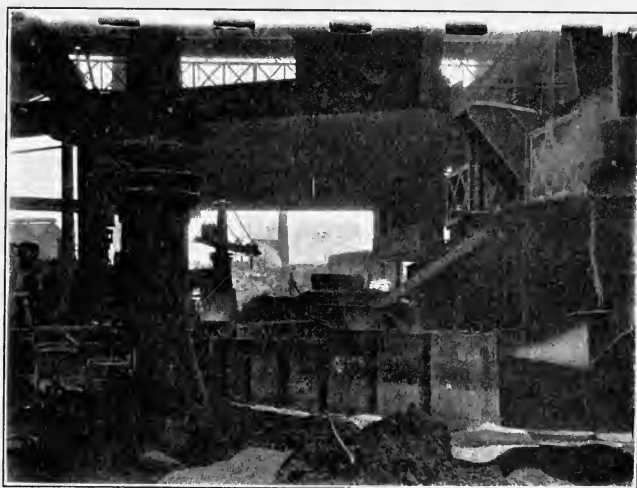

FIG. 37.—Moulds and Cranes in Bessemer Shop.

exceptional quality. The carbon in the finished metal may be high enough for high grade tool steel, as the following analysis will show:—

Carbon = 1·3; Manganese = 0·4; Silicon = 0·05; Phosphorus = 0·02; Sulphur = Trace.

In this country the Hatton modification of the Clapp-Griffiths fixed converter is one of the best forms. The original converter had a fixed bottom, but Mr. Hatton made

the bottom movable, which offers greater facilities for working and repairs. The vessel is side blown, and the twyers, which are round the circumference and a few inches above the bottom, are connected with the blast belt by a descending pipe that can be easily moved aside when a twyer is to be replaced. High grade pig containing about 2 per cent. of silicon is used, and a blow requires about 15 minutes from the time the molten metal is run in. The oxidation of iron is excessive, and the loss of metal is about 20 per cent. of the charge. Only dead soft metal can be produced; but it is of excellent quality, the carbon being about 0.1 per cent., and the phosphorus and sulphur low.

The Robert Converter is an example of a small side-blown tipping vessel of the eccentric type. It is circular in horizontal section with a flat side, so that it takes somewhat the form of a D. The twyers pass through the flat side, and are inclined a little towards each other as they pass through the lining, so as to blow more towards the centre of the bath. It is claimed, however, that the blast does not penetrate the metal very far, but refines it by a kind of surface action. The inclination of the twyers can be altered by tipping the converter into various positions. A large excess of air is used, so that the carbon is probably burnt straight to carbon dioxide, and the temperature of the bath thus increased. The converter may be either acid or basic lined to suit non-phosphoric or phosphoric pig as the case may be. Ferro-manganese, and sometimes ferro-silicon, is added at the end of the blow, and the finished metal is run from the neck by tilting the vessel. Such converters are more suitable for the production of steel castings than for ingot metal.

The principal difficulty in dealing with these small charges is to keep the metal sufficiently fluid to cast well, and this is overcome in the Walrand-Légénissel process by running in a calculated quantity of ferro-silicon after the

carbon has been blown out, and then turning up the converter again for an after-blow, during which the silicon is rapidly burnt and the temperature of the bath increased. The ferro-manganese is then added, and the metal is ready to pour. Small bottom-blown converters that can be rotated by hand gearing, and taking charges of 6 cwts. to 12 cwts., are used in the process, and sound steel castings of excellent quality are obtained.

The uses to which Bessemer steel is put depend largely upon the amount of carbon present. A general idea is given by the following table:—

Ship plates	...	0·2	per cent. C.	Axles	...	0·25	per cent. C.
Boiler	...	0·2	„	Tyres	...	0·30	„
Shafting	...	0·2	„	Rails	...	0·40	„
Sheets	...	0·2	„	Springs	...	0·50	„

CHAPTER VIII.

THE OPEN HEARTH PROCESS.

THE very high temperature generated in the Bessemer acid or basic converter by the rapid burning of the silicon, carbon, and phosphorus is sufficient to keep even low carbon metal in a condition for satisfactory casting; and this, together with the rapid output, made it difficult to devise an ordinary furnace method that should prove a serious rival to the Bessemer process. Sir William Siemens and his brother, however, overcame all difficulties at the cost of much labour and capital, and gave to the iron world a method of steel making that is more under control than the Bessemer process, and by which large quantities of iron and steel are made in all iron-producing countries.

It is an open hearth or reverberatory furnace method, and although the furnace itself has undergone considerable modification as regards detail, it is the same in principle and general working as when first introduced. Clearly the principal factor to the general success of such a method is the generation of a sufficient temperature to obtain a large mass of low carbon metal in a condition for tapping into a ladle, and casting into ingots, after the refining and finishing operations have been carried out. This is effected in the open hearth by the use of the principle of regeneration, which was first made a practical success by Siemens; and the adaptation of this principle to the reverberatory furnace is the leading feature of the Siemens' and all the more modern open hearths.

The Regenerative Furnace.—A description of the puddling furnace has already been given, so that the type of furnace is familiar. The hearth of the furnace in which the puddling process is carried on is heated by the passage of the products of combustion of solid fuel from the grate on their way to the flue, and the heat is concentrated on the hearth by the lowness of the roof above it. Such a furnace works in one direction only; but it is easy to imagine a

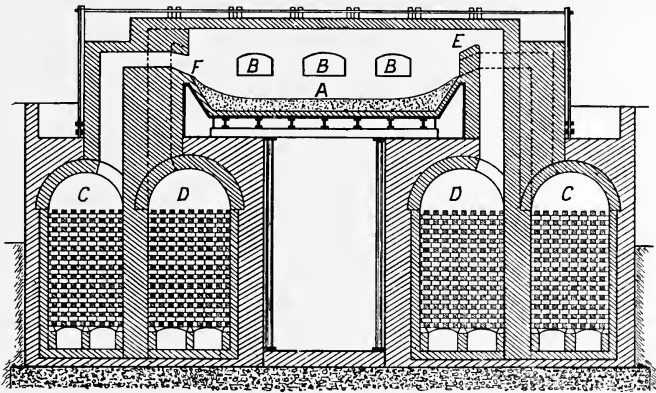

FIG. 38.—Regenerative Open Hearth (longitudinal section).

- | | |
|-----------------------------------|-----------------------------|
| <i>A</i> , Working bed or hearth. | <i>D</i> , Air regenerator. |
| <i>B</i> , Working doors. | <i>E</i> , Air port. |
| <i>C</i> , Gas regenerator. | <i>F</i> , Gas port. |

fire-grate and chimney at each end of the bed, so that the furnace could be fired from both ends alternately. This is, in effect, the principle of the regenerative furnace, but the firing is carried on by burning hot producer gas in hot air, the heating of the gas and air being effected by utilising the waste heat of the furnace itself. The application of the principle of regeneration requires that the combustion should be carried on at both ends of the hearth alternately. As the burning of hot producer gas in hot air gives a much

higher temperature than could be obtained by burning solid fuel, or by burning cold gas in ordinary air, the heat of the furnace is sufficient to raise mild steel well above the casting temperature, so that it can be tapped from the furnace, and cast into ingots without difficulty.

The furnace itself consists of an outer casing of iron plates riveted together, and held in position by strong bands fastened by tie rods. The interior is lined with very refractory material to resist the excessive heat obtained. The roof, sides, and ports are built of silica bricks of the finest quality, made from a pure quartz rock mixed with 2 per cent. of lime, and the bed is lined with silica sand. The bottom consists of cast-iron or steel plates, which are carried by strong girders supported on the foundation walls. The bottom plates are faced with a layer of silica bricks which thickens towards the sides and ends, so as to follow roughly the curved surface of the finished bed, and a hole about 18 inches square is left on the tapping side of the furnace. A taper iron plug is pushed into this hole from outside through a corresponding hole in the iron casing, so as to project right into the furnace. The plug is then well rammed round with moistened gannister, and when this is well set the plug is withdrawn from the outside, leaving the properly formed tap hole. The tap hole is stopped by ramming in clay from the outside, and filling the remaining part with anthracite from the inside. The temperature of the furnace is then raised to cause small pieces of sand-stone strewn over the brick lining of the bed to frit to the brickwork. The working lining, consisting of the best silica sand, mixed with a small proportion of a more fusible sand to cause it to vitrify, is then fritted on inch by inch until it attains a thickness of about 16 inches. An excellent working surface is thus obtained. The hearth is rectangular in form and dished out more or less. Various shapes have been tried, but the rectangular bed gives the

best results. The lowest part of the bed is connected with the tap hole, which is at the back side of the furnace. There are three working doors on the front side, each of which consists of an iron frame lined with silica bricks, and suspended by a chain from the end of a lever attached to the top of the furnace. The door is thus easily raised or lowered by means of a chain hanging from the other end of the lever, or by depressing the lever itself.

The ends of the furnace are exactly similar, and each is furnished with a number of openings or ports through which the air and gas enter the hearth space. For example, there may be at each end five such ports arranged in two horizontal rows, three in the upper row through which the air enters, and two in the lower one through which the gas is admitted. The brickwork through which these ports pass is usually very massive, so as to prevent the ports from giving way under the excessive heat, and sometimes hollow castings through which water can circulate are built in with the brickwork. The three air ports at one end communicate by flues with a rectangular chamber which contains a mass of firebrick forming a kind of chequer work. The arrangement is equivalent to the three air flues opening out into a large number of smaller flues in the top part of the chamber, and being gathered together again at the bottom into a common flue. The two gas ports at the same end are connected with a similar but smaller chamber, the flues of which are also gathered together into a common flue at the bottom. The chambers are separated by a thick, well-built dividing wall, so as to prevent any risk of air and gas mixing before they reach the furnace. The arrangement of the flues and chambers at the other end is exactly the same, for the two ends of the furnace are duplicates in all respects. The chambers are the regenerators, and are usually built below the furnace level. In the older furnaces they formed the

foundation, and were put in first, the furnace being then built on the top. But experience has shown that with larger furnaces the weight of the superstructure is too much for the walls of the regenerators to carry. Also, in case of a break through from the hearth above, considerable damage is done to the interiors of the regenerators by the molten metal. The general practice now is to support

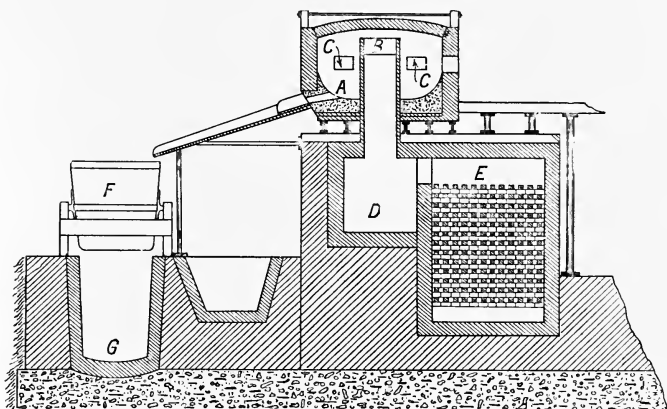

FIG. 39.—Regenerative Open Hearth (transverse section).

- | | |
|-------------------------|---------------------------|
| <i>A</i> , Tap hole. | <i>E</i> , Regenerator. |
| <i>B</i> , Gas port. | <i>F</i> , Casting ladle. |
| <i>C</i> , Air port. | <i>G</i> , Casting pit. |
| <i>D</i> , Slag pocket. | |

the body of the furnace on strong girders carried by separate piers or walls, and to build the regenerators so as to leave the middle of the bed quite clear. This arrangement is not only safer and less troublesome in case of a break through, but also serves to keep the bottom plate cool, as it is exposed to the air underneath.

The original idea with regard to the roof of the furnace was to make it slope downwards from both ends towards the centre, so as to cause the flame to beat down on to

the bed, but now the roof is raised a little in the centre, if anything, to increase the space above the hearth so that it can hold a larger body of flame. Also, there is a tendency to build the ports closer together and nearer the top. A vertical section of such a furnace as described is shown in Fig. 38.

As the furnace bottom is considerably above the ground level a platform extends along the front sufficiently below the bottom of the working doors to allow of ready manipulation. The materials for charging the furnace are brought on to this platform so that it is, as a rule, very commodious. A narrower platform stretches along the back of the furnace, and below the tap hole; this supports the gutter through which the metal runs when the furnace is tapped, and is used by the men when breaking through the tap hole.

Usually two or more furnaces are built in a row, and then the platform extends the full length of the range. The regenerators are below the platform, and the valves for regulating the gas and air are worked by levers from the platform, so that the melter has full control of the gas and air supply. The *valves* for regulating the supply of gas, and for reversing the course of the gas and air, are of two kinds. The regulating valve is of the mushroom type, and is raised and lowered from its seat by a vertical rod actuated by a lever. The reversing valves are of the butterfly pattern, and are reversed by levers. The parts exposed to the hot gases are water cooled to prolong their life. A diagrammatic sketch of the arrangement of flues at the bottom of the regenerators is given in Fig. 43.

The producers for supplying the gas are built as near as possible to the furnaces they are to supply, and are usually of the water bottom type. See p. 40.

The regenerators must have a sufficient area of heating surface for efficient working, and the exact dimensions of the chambers are also important. Thus a shallow chamber

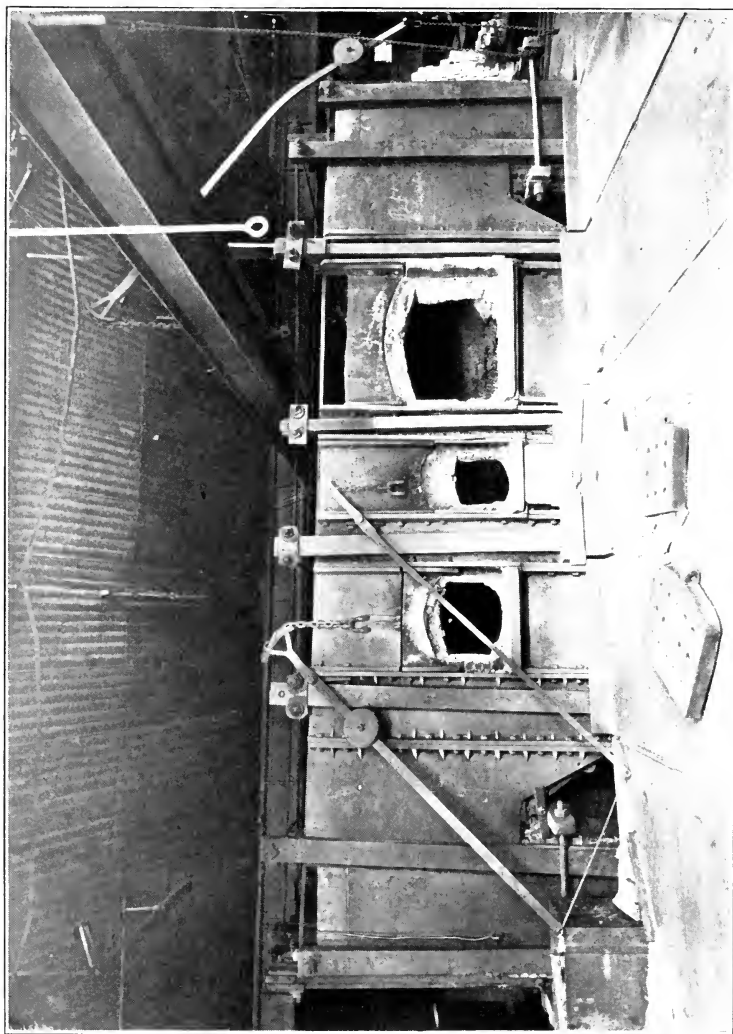

FIG. 40.—Front View of a 25-ton Regenerative Open Hearth Furnace showing the Working Doors, Norfolk Works, Sheffield.

of a given area of heating surface is less efficient than a deeper one of the same area; but there is a practical limit to the depth. Large modern furnaces require regenerators from 15 to 20 feet in depth. The usual ratio of the dimensions of the gas and air chambers is 1 to 1.37. A separate chimney stack of sufficient dimensions to cause a strong draught is used with each furnace. It is always easy to reduce the pull of the chimney by means of a damper.

Auxiliary chambers are sometimes built between the ports and the regenerators to intercept as far as possible the fine particles of solid matter carried from the furnace by the escaping gases. These dust catchers or slag pockets increase the life and facilitate the working of the furnace by preventing the passages through the regenerators from becoming choked, and the surface of the brickwork from being fluxed by the dust particles. Also they are a safeguard in case of the slag boiling over and running down the gas ports. See Fig. 39.

The casting ladle is similar to the one already described (p. 164), but is mounted on a trolley running on rails over the casting pit, which is parallel to the back of the furnace, or is swung from an overhead crane. A good idea of the general appearance of an open hearth furnace is given in Fig. 40.

The Siemens Process.—The first method introduced by Siemens consisted in melting pig iron practically free from phosphorus on the bed of an acid lined open hearth, and then refining the metal by the addition of good hæmatite ore. This was known as the pig and ore process, but the results were not altogether satisfactory, for the lighter ore did not mix well with the bath of metal. Another process, due to Martin, was to melt the charge of pig iron, and then to put in a large proportion of good quality scrap, which was dissolved by the molten pig, and the carbon and silicon

distributed through the whole charge ; but there was also a certain amount of refining due to oxide of iron formed in the furnace by the oxidation of a portion of the charge. Again the results were not satisfactory, and the present open hearth process is a combination of the two ; for pig, scrap, and ore are all used. This allows of more regular working, and more even distribution of the charge, and is better suited to general furnace conditions than either of the simpler processes. It is sometimes called the Siemens-Martin process.

The Acid Process.—If the furnace bottom is new, it is prepared for regular working by melting a small charge of pig iron, together with some siliceous material to form slag, and then raking the molten matter all over the bed and up the sides so as to well saturate them. The charge is then tapped, and the metal taken to the scrap heap. An alternate method, largely used in America, is to melt acid slag on the bed, and well rabble it over the sides. Several charges smaller than the capacity of the furnace are then worked off, gradually increasing up to the full capacity.

The proportion of pig and scrap in the charge varies considerably in different works according to the quality of the pig and the quantity of scrap on hand ; but in general practice from 70 to 80 per cent. of pig and 20 to 30 per cent. of scrap are used. The pig should be non-phosphoric, with a moderate content of silicon, if good steel is to be produced. Heavy scrap is also much more satisfactory than light scrap, for the latter oxidises more freely, and is much larger in bulk. The pigs are broken in two for convenience, and charged into the furnace first. In order that the charge may be put in as rapidly as possible all the three doors are used, and at least six men are required for the work. The furnace man uses an iron tool called a peel. He rests the blade of the peel on the step of the door while a labourer puts half a pig on it, and then shoots the metal

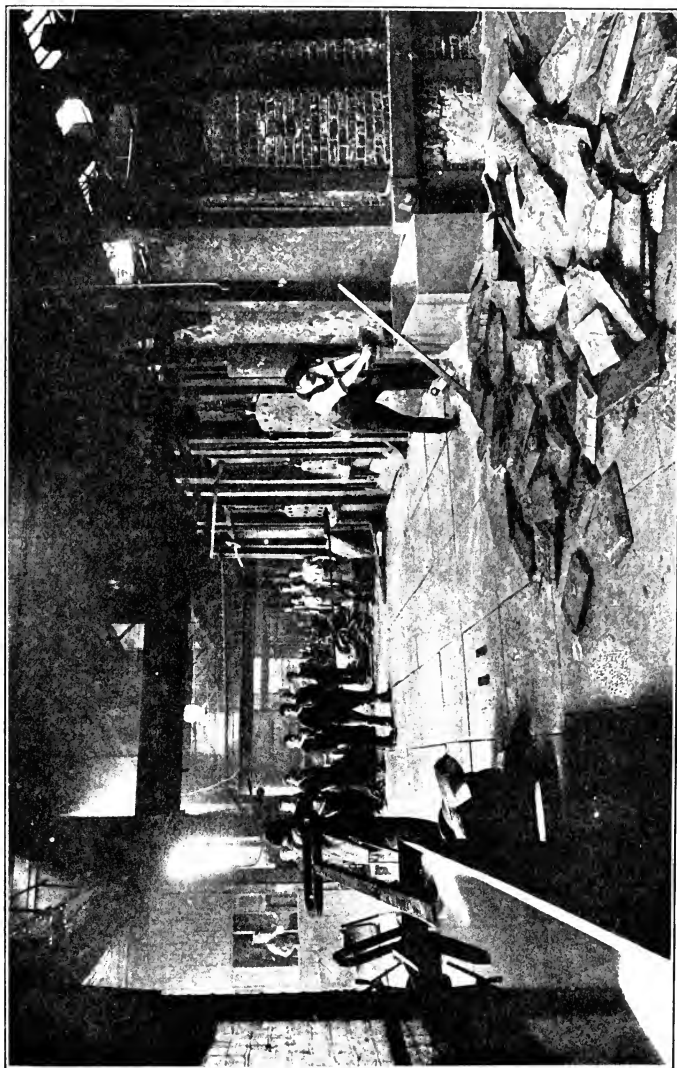

FIG. 41.—A Row of Regenerative Open Hearth Furnaces, with General View of the Working Platform.

on to the bed. This is repeated until the whole of the charge is introduced, and the men get so expert at the work that the charge is evenly distributed over the bed. The scrap is then put in, and the furnace doors closed. With light scrap it is sometimes impossible to get the whole in at once, and the remainder has to be added as the charge melts down. When the furnace is charged and the doors are down the "melter," as the man in charge of the furnace is called, has very little to do but to see that the furnace is working properly, and to reverse the direction of the air and gas every twenty minutes. In about three hours the charge is quite molten and ready for the addition of the ore. Pure hæmatite ore is then thrown into the bath a little at a time, the additions being so regulated as not to cause the bath to "boil" too rapidly, or some of the charge would flow out of the furnace. During the boiling the oxygen of the iron oxide added is oxidising the carbon in the charge with the formation of carbon monoxide, and it is the escape of this gas that causes the boil.

The carbon thus gradually disappears from the bath, and the melter takes out samples from time to time in a small ladle called a spoon. These are cast in a round mould, flattened under a hammer, and quenched in water. From the appearance of the fractured surfaces of these samples the condition of the bath is judged, and more ore added or not as required. For soft metal the carbon is worked down to about $\frac{1}{10}$ per cent. The silicon in the pig is oxidised to silica and passes into the slag in the earlier stages of the process, so that the disappearance of the carbon indicates the end of the refining. When the metal is considered ready for tapping a few lumps of pig are thrown into the bath, just sufficient to keep it working, but not enough to appreciably affect the percentage of carbon. The bath is now ready for the addition of the ferromanganese, which is either thrown into the furnace in

lumps, or added in a stream of small pieces to the metal as it runs into the ladle.

Fig. 41 shows the working side of a row of three open hearth furnaces, one 45 tons and two 30 tons, at Messrs. Firth's, Sheffield.

Tapping.—To tap the furnace an iron bar tipped with steel is driven with sledges through the clay stopping, and then hammered back by striking the inside of projections on the free end. When the hole is free the melter enlarges it from the inside by thrusting in a pricker rod and working it about. The molten metal runs from the tap hole through a clay lined iron gutter, previously made hot by burning coal in it, into the ladle placed underneath to receive it. As the metal runs into the ladle a small sample is caught in a spoon, cast into a small ingot, tested for weldability and toughness, and then analysed. A record of each cast from the furnace is thus kept.

The slag must be kept sufficiently fluid to protect the metal while the refining is in progress, and to prevent trouble during the tapping. A thick, pasty slag is to be avoided, and if it forms, a few lumps of limestone must be added to flux it before the furnace is tapped.

The tap hole will give trouble if not carefully cleared after each tapping and before it is made up with anthracite and clay for the next heat. Should the tap hole break through during the working of a charge, and the ladle cannot be got under, the metal must run into the pit and be broken up for removal. Sometimes the tap hole becomes hard set, and a number of rods and hard sledging are required to break through it. These difficulties, which have to be overcome by much labour, give rise to the terms "break through" and "hard tap," and are among the worries of even the most expert furnace managers.

The ladle, which has already been described in the casting of Bessemer steel, is then brought over the moulds



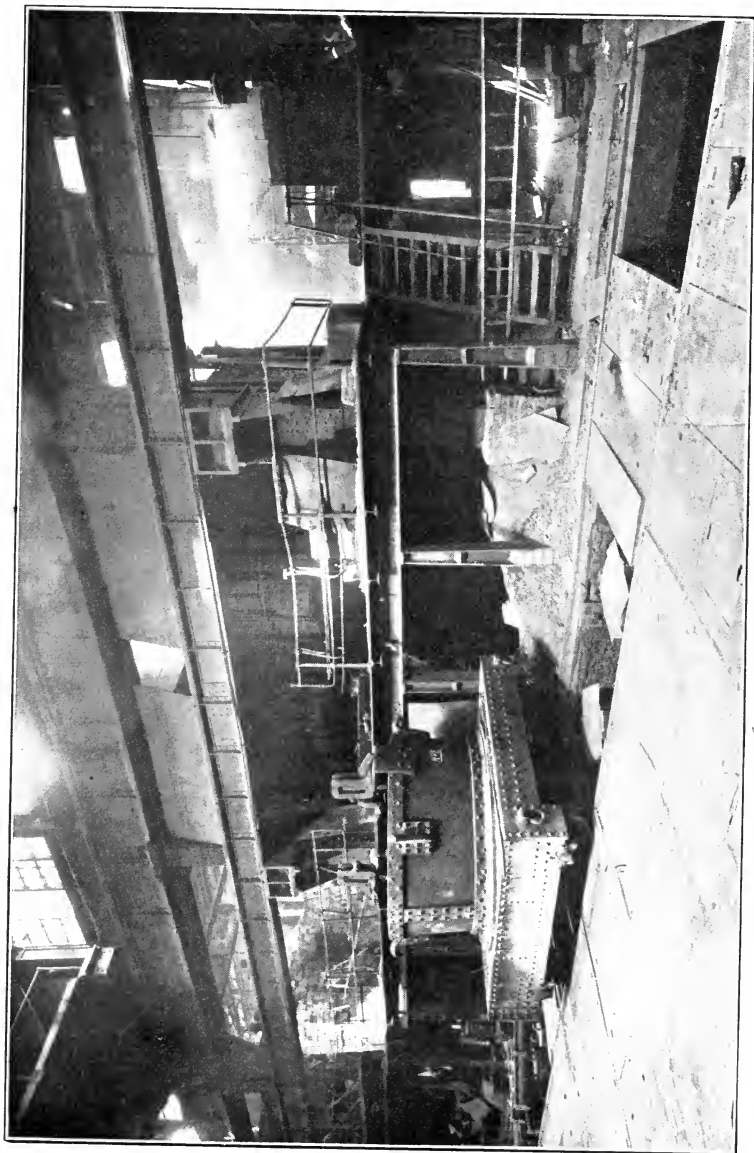

FIG. 42.—Tapping Side of an Open Hearth Furnace with the Casting Ladle in position.

in the casting pit, and the metal tapped into them. The centre crane method of carrying the ladle is not much used in connection with the open hearth as the pits are usually straight. The ladle is mounted on a carriage which can be moved by hand gearing or drawn by a locomotive, and so moved from mould to mould on rails running along the sides of the pit. The ingots are then stripped and removed as soon as they are sufficiently set to handle. See Fig. 33. Sometimes the ladle is suspended from an electric travelling crane which runs parallel to the row of furnaces, and by which it can be brought into position under any one of them. This arrangement is very suitable where the system of car casting is in use; that is, when the moulds are placed on cars running on rails at the bottom of the casting pit, and are drawn under the ladle one by one to receive the metal. The stripping of the ingots and their removal need not be so hurried as in the case of the Bessemer process, for several hours intervenes between the casts from a particular furnace. The stripping crane mostly used is a "traveller," and runs on rails outside the pit. It is of the locomotive type with a vertical boiler. Separate engines are used for working the lifting portion, or crane proper, and for moving the trolley, but it is self-contained, and is used for a variety of purposes. The ingots are stripped by it, and then carried to the soaking pits, or re-heating furnaces.

Fig. 42 shows the casting ladle in position with the end of the gutter leading from the tap hole directly over it.

Refining in the open hearth, which consists of the removal of silicon and carbon from the charge, is effected in part by the oxidation of a small proportion of the iron during the melting down, for the atmosphere in the furnace is oxidising in character, and in part by the oxygen from the rich oxide added to cause the boil. Pig iron too high in manganese is objectionable, as that metal exerts a

corrosive action on the sides of the bed, and makes the slag too thin. Phosphorus and sulphur are not removed at all in the refining on a silica bed, and will be slightly higher in the finished metal than in the original charge. This necessitates careful selection of the pig, scrap, and ore if high-class metal is to be produced. The following table gives a general idea of the character of the pig, scrap, and finished metal:—

	Carbon per cent.	Silicon per cent.	Manganese per cent.	Phosphorus per cent.	Sulphur per cent.
General limits	3 to 3·6	1·9 to 2·5	0·7 to 0·9	0·03 to 0·04	0·02 to 0·04
Suitable pig .	3·5	2·25	0·80	0·035	0·03
Scrap metal .	0·2	0·04	0·5	0·01	0·04
Finished steel	Variable, but under control.	0·03	0·5	0·05	0·05

The *slag* contains an excess of silica, and is, therefore, acid in character. The following is a typical composition:—

ACID OPEN HEARTH SLAG.

Silica, SiO ₂	57·0
Ferrous oxide, FeO	25·0
Manganous oxide, MnO	8·0
Lime, CaO	5·5
Alumina, Al ₂ O ₃	3·5
Magnesia, MgO	1·0
		100·0

In making acid open hearth steel all the materials must be of the best, and as free as possible from impurities not removed in the furnace. On that account the steel produced commands a good price. The percentage of

carbon can be controlled within fairly wide limits, and high carbon steels produced. The metal, however, is not quite suitable for the best cutting tools, and only a small proportion is used for that purpose. The description of the process given above refers to the production of "dead soft" steel, or more correctly high-class ingot iron. When higher carbon steels are to be made the process is modified at the finish so as to introduce the necessary content of carbon. This may be done in several ways; (1) by finishing the refining when the carbon is reduced to the proper percentage, and then tapping the metal; (2) by refining the charge until nearly all the carbon is removed, and then working it back by the addition of pure pig or spiegel, or both; (3) by refining until nearly all the carbon has disappeared, and then adding the required carbon to the ladle. In making axle-steel, which usually contains less than 0.5 per cent. of carbon, the first method is often adopted, but the process must be conducted with care. The addition of the ore is so regulated that when the carbon has been brought down to the proper content the slag is free from active oxidising bodies. If not, the composition of the bath will be disturbed on the addition of the ferromanganese, for carbon would be removed by the action of the slag.

For higher carbon steel the bath is worked down to about 0.2 per cent. carbon, and then brought back by the addition of pure pig iron and spiegel. These bodies are placed on the banks of the hearth, where they melt down and run into the bath of metal carrying in the necessary carbon and manganese. Even more care must be taken to have the slag non-oxidising, and not too thin. The percentage of carbon in the metal can be determined by dipping out a small sample with a "spoon," and comparing it with a standard steel by the Eggertz colour-test, which only requires a few minutes to complete.

The method of introducing the carbon in the ladle is also largely used. Mr. Darby, of Brymbo, invented a process for the rapid carburization of steel by running the molten metal through a layer of charcoal contained in a perforated tube. In this way he increased the content of carbon in a charge of metal from 0·2 to 1 per cent., and found that the amount taken up depended on the depth of the layer through which the metal had to pass.

It was found, however, that much the same thing could be effected by adding charcoal to the ladle, as the carbon is taken up rapidly by the metal. The method now largely adopted is to place the charcoal in paper bags and throw them into the ladle at intervals. The first bag is thrown in when the metal just covers the bottom of the ladle. Another method is to feed in the charcoal through a hopper fixed vertically over the casting ladle while the metal is being tapped into it. About half the carbon put into the ladle is taken up by the metal, and the process seems to give very accurate results. In one American steel works twenty-four casts were made, and the greatest difference from the desired content of carbon in the whole series was 0·02 per cent. A considerable saving of ferro-manganese and spiegeleisen is thus effected.

The Bessemer converter and the open hearth furnace are sometimes used in combination. When the metal has been blown until nearly the whole of the silicon and part of the carbon have been removed two charges from the converters are run into an open hearth, sampled for carbon, ore added to produce the boil, and the charge finished and tapped.

Basic Open Hearth Practice.—Although it was thought to be practically impossible to remove the whole of the phosphorus from a charge of phosphoric pig iron without the use of a blast of air, it has not proved so in the sequel, and highly phosphoric pig can be treated in the open

hearth without the aid of more air than passes through the furnace in the ordinary course.

The details of the furnace used for the basic process are very similar to those already described for the acid-lined furnace. The main difference is in the bed lining, which must be basic in character, and burnt dolomite is the best material for the purpose. As is generally the case, more modifications in the construction of the furnaces used in the early basic practice were introduced than were necessary for successful working; and in modern basic practice the furnace is very similar to that used for the acid process, except in the hearth lining. Theoretically the walls and roof of a basic furnace should be lined with basic materials; but this is impossible, as basic bricks break down so readily that they cannot be used for the roof and walls. It is found, however, that the fluxing tendency of good silica bricks when in contact with dolomite lime is not nearly so great as might be expected, even at the high temperature of the open hearth, especially if they are not subjected to much pressure where they are in contact; so that only ordinary precautions need be taken, and the roof and walls constructed of silica bricks in the usual way. A layer of some neutral material, such as chrome iron ore, may be used to separate the two where they would come into contact, and the liability to fluxing thus greatly reduced.

The *Batho* furnace was one of the earliest in use for basic work, and it was in the construction of this furnace that the regenerators were first built independently of each other and quite separate from the furnace. It was claimed for this arrangement that there was no danger of gas and air firing between the two regenerators, and that no damage could be done to them in case of a break through of metal from the bed. The bed was round, and the roof, which was independent of the rest of the furnace, was suspended

from girders overhead so that it could be raised for repairs. Messrs. Riley and Dick, and others, have modified the construction of this furnace in various ways, but it has not come into general use, for the modern basic furnace is essentially the Siemens open hearth.

Various methods are adopted in the construction of the side walls and roof, and in the lining of the hearth. The following may be taken as the most general, and is largely due to Mr. Darby, of Brymbo. The roof of silica bricks is carried on a horizontal arch so that there shall not be much pressure between the brickwork of the side walls and the basic material of the hearth where they come into contact. A chrome ore joint may thus be dispensed with. The bottom plates are covered with a layer of silica bricks, and then basic bricks are built round the sides of the hearth to help to form the banks. Dolomite lime mixed with tar is rammed all over the bottom and well burnt on; then more dolomite lime is spread over and glazed on an inch at a time until the bed is complete. In this way a good durable bed is formed with the tops of the banks well above the slag line. Dolomite lime although very refractory is just fusible enough to frit at the temperature of a Siemens furnace. This is probably due to the small quantity of silica it contains forming a fusible double silicate of lime and magnesia in sufficient quantity to slightly soften the mass. Pure lime does not frit, so cannot be used in place of dolomite. Unless the bed is well formed as described, portions of it may break away during working and rise through the bath of metal. The tap hole is formed in a similar manner to that already described for the acid open hearth.

Working a Charge.—The furnace being hot and ready for charging, some lime and iron ore are first placed on the bed, and then the pig is charged with the addition, from time to time, of more lime and ore; finally the scrap is

added. When the charge has melted down and become quite clear, non-siliceous iron ore, or basic reheating furnace cinder free from silica, is added together with lime, these additions being made from time to time as required. The melter watches the boil carefully and takes out small samples, which are hammered out, quenched and fractured. From the appearance of the fracture he is able to judge of the extent to which the phosphorus has been removed. The sufficient removal of the phosphorus is the *sine quâ non* of the process, which is not complete until the phosphorus has been brought down to 0.05 per cent. or less. The information obtained from the appearance of the fracture is sometimes checked by the rapid estimation of the phosphorus in the sample. The chief aim of the melter is to keep the bath on the boil until the phosphorus is brought down sufficiently; but as the boil ceases when the carbon has gone, its too rapid removal must be guarded against. Should the boil moderate too rapidly the temperature must be regulated and pig iron added to prolong the action. The boil is caused by the rapid escape of carbon monoxide due to the oxidation of the carbon in the bath. This agitates the molten mass and brings the metal well into contact with the oxidising bodies and the lime. The phosphorus is thus oxidised, and the phosphoric oxide formed unites with the lime to form a phosphate of lime, which passes into the slag.

When the melter is satisfied that the phosphorus is low enough and the carbon is right, a little hæmatite pig is thrown in and the charge is ready for tapping. The tap hole, which is made up from the inside with anthracite as in the acid process, and from the outside with dolomite lime and tar instead of clay, is broken through in the usual manner, and the metal tapped into the ladle. The necessary ferro-manganese in small pieces is allowed to fall into the stream of metal as it runs from the furnace. A

general idea of the composition of the pig, scrap, and finished metal is given by the following table:—

	Carbon per cent.	Silicon per cent.	Manganese per cent.	Phosphorus per cent.	Sulphur per cent.
General limits	3.25 to 3.75	0.5 to 1.0	1.5 to 2	0.1 to 2.5	0.07 to 0.05
Suitable pig .	3.5	0.8	2.0	1.5	0.05
Scrap metal .	Variable.	0.06		0.1	0.05
Finished steel	Variable, but under control.	0.06	0.06	0.05	0.05

The *Slag* contains an excess of phosphate of lime, and a typical analysis is given below.

Basic Open Hearth Slag.

Silica, SiO ₂	12
Oxide of Iron, Fe ₂ O ₃	17
Phosphoric Oxide, P ₂ O ₅	14
Manganous Oxide, MnO	10
Lime, CaO	42
Magnesia, MgO	5

—
100

The important points to be noticed in the working of the basic process are connected with the permanent removal of the phosphorus. In basic Bessemer practice the phosphorus is an important heat producer, and is necessary to the conduct of the process; but in the open hearth the heat required to carry on the refining is very largely produced by the combustion of the external gases. Therefore, pig iron low in phosphorus, which would probably give an unsatisfactory blow in the Bessemer converter, can be dealt with readily in the open hearth. As a matter of fact, an

iron too high in phosphorus is difficult to deal with, as the carbon may be all removed before the phosphorus is low enough, and thus cause trouble. But with care all grades of phosphoric pig may be used. Also, the scrap used in the process may contain more phosphorus than would be admissible in the acid process, and on that account is often cheaper.

High silicon pig is usually low in sulphur, and thus produces good metal; but it should have its silicon reduced before being put into the basic hearth. An easy way of doing this is to blow the metal for a few minutes in an acid lined converter; but this means waste of metal and the maintaining of two plants which may more than balance the extra cost of selected pig. The late Sir I. L. Bell introduced a "washing" process by which silicon can be largely removed and phosphorus considerably reduced by acting upon the metal with a strongly oxidising slag at a moderate temperature. See p. 137.

The relation of the slag to the bath of metal is also very important, for although the phosphate of lime formed is stable at the temperature of the furnace, it is reduced by carbon at that temperature, and the reduced phosphorus passes back into the metal. The slag must be sufficiently basic, and silica should not be allowed to accumulate in it, as silica is able to replace phosphoric oxide, which is then more readily reduced by carbon. On this account care must be exercised in the additions made to the charge at the end of the boil. For example, it is impossible to put in hæmatite pig, as in the method of "pigging back" already described in the acid process, except in small quantities, for the carbon this introduced would reduce phosphate in the slag, and the reduced phosphorus would pass back into the metal. Also, the ferro-manganese must be put into the ladle and not into the furnace, and the slag must be kept out of the ladle as far as possible.

Most of the basic steel produced is low in carbon ; but high carbon metal can be made by putting carbon into the ladle. The simple bag method has already been described, but in the opinion of some authorities more uniform results are obtained by feeding in the ground anthracite from a hopper suspended over the ladle on to the metal while it is being tapped from the furnace. The proportion of carbon absorbed to that added depends upon the quantity it is desired to introduce into the metal. The higher the percentage of carbon in the finished steel the smaller the proportion of the added carbon that is absorbed. The quantity absorbed seems to vary from $\frac{1}{2}$ to $\frac{1}{3}$ of that added.

Silicon is readily removed in the furnace, but it is not desirable to use pig containing much silica, as this would cause an accumulation of silica in the slag, which, as already indicated, is to be avoided.

The presence of sulphur in the pig is objectionable if low sulphur metal is to be produced, for the removal of that element in the process is more or less erratic, and certainly not under control. The presence of manganese in the charge facilitates the removal of sulphur, but its action is limited. The elimination of sulphur has received much attention, and various methods have been proposed to effect this. The conditions seem to be a highly basic and very fluid slag. The fluidity of the slag is usually increased by the addition of calcium chloride, CaCl_2 , and fluor-spar, CaF_2 . Both these compounds are recommended by Saniter, whose process is the one most largely used. In the basic open hearth or Bessemer process the desulphurisers may be added to the molten charge in the furnace or converter, and the lime increased to upwards of 50 per cent. in the slag ; but the time required for working the charge is increased. This is regarded by some makers with disfavour, as it reduces the output of a given furnace ; but if sufficient

calcium chloride is added to keep the slag very fluid to the finish, this need not be a serious objection. The addition could not be made in the case of acid lined apparatus, as a basic slag is then quite inadmissible; but this difficulty can be overcome by running the molten metal from the blast

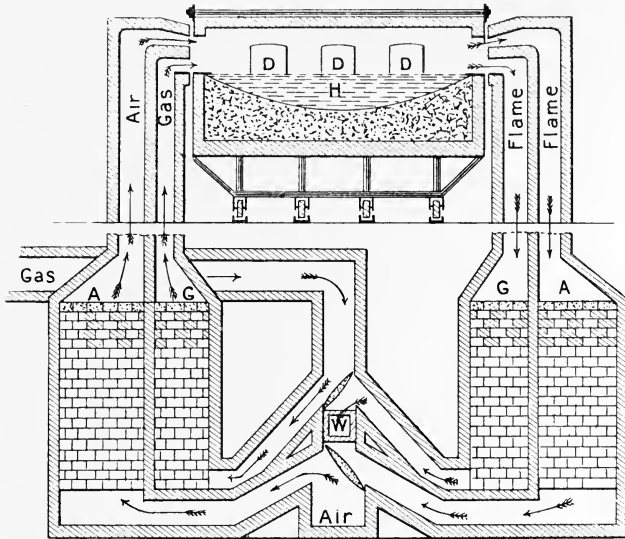

FIG. 43.—Diagram of a Campbell Tilting Furnace (longitudinal and vertical section).

A, Air regenerator.
D, Working doors.
G, Gas regenerator.

H, Hearth.
w, Waste gas culvert.

furnace or mixer into a ladle on the bottom of which a mixture of calcium chloride, fluor-spar, and lime has been placed. The mixture melts, rises through the metal, and removes upwards of 50 per cent. of the sulphur present. The desulphurised metal may then be cast into pigs, or it may be run direct into the converter.

Tilting Furnaces.—One of the most important advances

in open hearth practice is marked by the introduction of the tilting furnace. This furnace does not differ in any essential from the Siemens furnace. It is usually larger than the ordinary type, and the body is movable, so that either the charging side or the tapping side can be tilted down as required. There are two systems by which the rotary motion is given to the furnace body. In the *Campbell* type the body rotates round its longitudinal axis on sets of rollers moving over the segment of a circle at each end. The tilting is produced by a hydraulic ram working in a horizontal cylinder. In the *Wellman* type the body is supported on rockers, and can be moved through the required angle by a ram working in a vertical cylinder. These furnaces are usually of large size, ranging in hearth capacity from 40 to 600 tons of molten metal. In some of the large steel works in America as many as twelve 50-ton furnaces are at work. The largest furnaces of the tilting type are usually constructed for, and used as, metal mixers, and several are now in use in this country. A modified Wellman furnace of 200 tons capacity is being used at the Round Oak Steel Works, Brierley Hill, and another of the same capacity at the Spring Vale Iron Works, Bilston. They are not only useful as mixers, but a certain amount of refining may be effected in them. Thus by the introduction of manganiferous material into the bath, sulphur may be partly eliminated as manganous sulphide, MnS, in the slag. Also, some silicon would be oxidised as the result of the metal being exposed to an oxidising atmosphere in the furnace, and to an oxidising slag. These mixer-furnaces are used with both Bessemer and fixed open hearth plants. Fig. 43 shows the Campbell tilting furnace in vertical section. It is seen that the body is quite independent of the fixed ends which carry the flues, so that it can be rotated without interfering with the course of the gases through it. The manner in which the gases

circulate through the system is clearly shown, but the arrangement must be regarded as diagrammatic.

The mechanical appliances for handling the charges worked in these large furnaces correspond to the furnaces themselves. The *electric charger* designed by Wellman is one of the latest forms of mechanical charging apparatus. Its position and general appearance is indicated by B, Fig. 44.

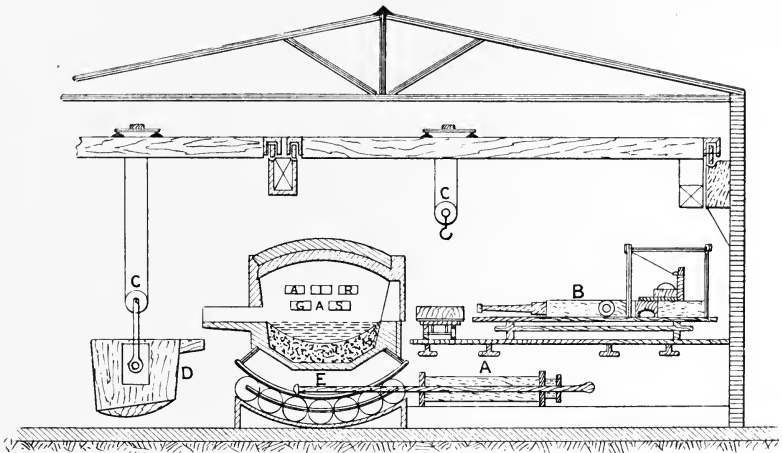

FIG. 44.—Diagram of a Campbell Tilting Furnace (cross section).

- | | |
|------------------------|-------------------|
| A, Hydraulic cylinder. | D, Casting ladle. |
| B, Electric charger. | E, Hydraulic ram. |
| C, Travelling cranes. | |

The body of the machine is mounted on wheels so that it can travel along the platform in front of the furnace. The horizontal charger bar has three distinct motions: it can be moved to and fro in the direction of its length; it can be raised and lowered vertically; or it can be rotated round its own axis. The iron charging box, which contains the solid materials to be charged into the furnace, is supported on a bogie carriage running on rails between the

charger and the furnace, and is readily brought in front of the door. At one end of the box there is a socket into which the end of the charger bar fits, and with which it is readily locked or unlocked by a rod running through the centre of the bar, and under the control of the operator at the back of the machine. The box can thus be raised from the bogie, thrust into the furnace, its contents tipped out, and rapidly withdrawn. The travel of the machine and the movements of the bar are brought about by electric motors fixed to the body. When the furnace is used for a mixer the molten metal is brought from the blast furnace in a ladle, which is then raised to the platform by an electric travelling crane, and its contents run through a gutter into the furnace by way of the charging door. The furnace is tilted when either metal or slag is to be run from it. The general arrangement of the tilting apparatus is shown in Fig. 44.

The original form of mixer can scarcely be called a furnace; it is more of the nature of a very large ladle or reservoir, and was called into existence by the demand for uniform fluid metal for the Bessemer process. It is either rectangular or semi-cylindrical in form, and the body is made of wrought iron plates, strongly braced together, and lined with firebricks. It is mounted so that it can be tilted in either direction by means of a hydraulic ram. The molten metal from the blast furnace is brought up to the mixer in a tilting ladle, and run in on one side, while the molten metal for the Bessemer charge is run into a tilting ladle from the other side. By the tilting arrangement the outlet is brought below the surface of the metal when a charge is to be withdrawn, and raised again when the required amount of metal has been run into the ladle. The surplus heat of the metal that is run in is supposed to keep the temperature of the mixer above the melting point, and this is so when a steady supply of metal from the blast furnaces

is available. But the gas-fired mixer is taking the place of the simple form, as it is more under control, and a preliminary refining can be effected in it.

The Talbot Process.—There have been several modifications of the Siemens-Martin process introduced, and mostly with the object of shortening the time of working off a charge. As already stated, when cold pig and cold scrap are charged, what with repairing the bed and making up the tap hole, it is seldom that more than two heats are taken from the same furnace in twenty-four hours. Thus anything like a steady supply of ingots straight to the mill is out of the question. Mr. B. Talbot has introduced a more continuous process, which was first used in America, but is now in use in this country. The principle of the process is to run a quantity of molten pig iron into a bath of already refined metal, and then to work the bath to the finish again. A regulated proportion of this finished metal is tapped from the furnace, and the usual addition to prepare the steel for casting added to it in the ladle.

The process can be worked in a fixed furnace of large capacity, but a tilting furnace is much more readily handled, and probably gives better results than would be obtained with the same metal in a fixed one. The Wellman furnace is generally used, but this is not because it is superior to the Campbell furnace for general work. It costs less to construct. About 60 tons seems to be the lower, and 200 tons the higher, limit of capacity for the furnaces used in the Talbot process. The Wellman furnace, as used for this process, has a deep bed, and the ports can be moved back a little when the body is to be tilted, and far enough back for a man to get between when repairs are required. The joints between the ports and the furnace are made by water blocks. The slag can be run either from the charging or the tapping side of the furnace.

The following is the description of the working of a

60-ton charge: the furnace being ready, 30 tons of molten pig is run in, and 30 tons of scrap added. The charge is then worked for steel in the usual way by the addition of ore and lime in the case of the basic process. One-third of the charge is then poured into the ladle by tilting the hearth, and two-thirds left in the furnace. The run metal is then finished by the addition of ferro-manganese to the ladle. As soon as the required quantity has been run off the hearth is brought back and crushed oxide of iron added to enrich the slag which is not run off after this first heat. When the slag is thoroughly molten again a charge of 20 tons of molten pig is run in. This causes a very energetic action in the bath, during which the gas is shut off, much carbon monoxide is given off, and the metal boils up. The oxygen is furnished by the oxide added to the slag, and sufficient heat is generated by the oxidation to keep up the temperature of the bath. In about fifteen minutes the slag becomes normal again, and part of it is run off through a tap hole by tilting the hearth. When the quantity of slag has been sufficiently reduced the hearth is tilted back and the slag hole made up. The gas is then turned on, the bath worked to steel by the addition of ore and lime as before, and 20 tons tapped into the ladle to be finished as usual. The sides of the bed at the slag line are examined and made up, if necessary, and the process exactly repeated. The interval between the casts is about four hours. The furnace is worked as described for a week, and it is said that thirty-two casts can be made in that time when the molten pig is taken from a mixer. Thus the output of a single furnace is upwards of 600 tons of steel ingots per week in a fairly continuous stream to the mill. By using furnaces with a greater capacity, and tapping a smaller proportion of the total charge, the time between the casts can be still further reduced to about one hour.

When the furnace is shut down at the week-end the

whole of the last charge is tapped, and the bed thoroughly repaired ready for the next week's campaign. One of the advantages of the process is that the greater part of the bed is covered with molten metal, which has little or no corrosive action on the lining. In fact, the corrosive wear is mostly confined to the slag line, although there is the constant mechanical wear due to the large body of metal on the bed.

A Talbot plant with a 100-ton furnace is in use at Frodingham, and a still larger furnace at the works of Messrs. Guest, Keen & Co., Cardiff. In America 200-ton furnaces are used in the same process.

According to Professor Harbord, there is an important future for this process in the treatment of good hæmatite pig taken from a mixer and worked on a basic bed. He says that in this way a very uniform steel of excellent quality can be produced, for the silicon is rapidly oxidised, and there is very little phosphorus to be removed, so that the metal can be finished without working down the carbon to the limit.

The Bertrand-Thiel Process.—This is another open hearth process which has for its object the saving of time and the more regular supply of ingots to the mill. It is a double furnace method, and is adapted to the use of molten pig direct from a mixer. The charge of molten pig is run on to the bed of the first furnace, which already contains iron ore and lime, and is partly refined by the action of these substances. The phosphorus is brought down to 0·1 per cent., while there is still 2 per cent. of carbon left in the charge, which is amply sufficient for the final boil. The partly refined metal is then transferred to the second furnace, which contains ore, lime, and scrap already at a sweating heat. The full charge is then melted and finished ready for tapping.

A shallow bath of metal is required for rapid refining, so

that the furnaces must have a much larger bed area than is necessary for the ordinary open hearth process. Also the wear is greater on account of the cutting action of the molten metal. The latter is reduced, however, by the presence of the ore and lime on the bed when the metal is run in. The time in the first furnace is four hours, and in the second two hours; but as the furnaces are working jointly five casts can be made in twenty-four hours. The metal from the first furnace is either run through a gutter direct, or tapped into a ladle and then run into the second furnace. In running direct the bed of the first furnace must be at a higher level than that of the second.

This process is being successfully worked at the Earl of Dudley's steel works, Round Oak. It is said that the second furnace is unnecessary, and that the steel can be finished in the same furnace. To do this the partially refined metal is tapped from the furnace into a ladle, the ore, lime, and scrap charged at once, and the molten metal run back to be finished. The advantage of tapping the partially finished metal and then running it back again seems to be in the formation of an entirely new slag which, being clean, favours the more rapid removal of the remaining silicon, phosphorus, and carbon. The second part of the operation occupies about two and a half hours.

Remarks.—There is little doubt but that the rate of manufacture of open hearth steel will continue to advance, while that of Bessemer steel will probably decrease, or at any rate will make little or no progress. This is largely due to the more regular quality of the open hearth metal on account of the greater control that can be exercised over the process. Still, with the new impetus given by the use of mixers the older process is not likely to decline very rapidly. In 1906, more than 12,000,000 tons of Bessemer ingots were cast in America, while the output of the open hearth amounted to nearly 10,000,000 tons. It is reported,

however, that eighty-six new open hearth furnaces are in course of erection in different parts of the United States. The capacity of these furnaces will be from 50 to 60 tons, and the estimated yearly output about 4,000,000 tons. No such increase is indicated in connection with the Bessemer process.

The basic process is largely increasing in both cases, and this is due to several causes, the principal one of which is the demand by the acid process for a high-class pig iron practically free from phosphorus. This demand is becoming more difficult to meet, as non-phosphoric ores are not nearly so widely distributed and abundant as phosphoric ones. Also, the natural prejudice against basic steel engendered by the old practice of considering any kind of scrap good enough to convert into this class of metal is being gradually overcome. The only limit to the scrap seemed to be the width of the furnace doors; but now, with careful selection of the materials, there is no reason why the metal should not satisfy every test for purposes to which ingot metal can be put. As will be indicated in Chap. IX., much scrap is necessarily made in working up the ingots, and the open hearth is hungry for it. It is a case of furnace to shears, and back again to the furnace. But in the Bessemer process the use of scrap is very limited.

The higher carbon steels are more often a product of the open hearth than of the Bessemer converter. A few of the uses to which open hearth steel is put are indicated below:—

Boiler plates	0·20 per cent. C.
Sheets	0·20 „
Structural steel	0·25 „
Rails	0·45 „
Springs	0·65 „
Tools	1·30 „

CHAPTER IX.

MECHANICAL TREATMENT OF IRON AND STEEL.

IN the preceding chapters the production of masses of iron and steel in a sufficiently pure state to be worked under the hammer and between rolls has been described. In this chapter the physical and mechanical treatment necessary to render the metal suitable for the use of the engineer and mechanic generally will be considered.

THE IRON MILL.

Treatment of Blooms.—The ancient ironworker with his small furnace would have only small masses of metal to

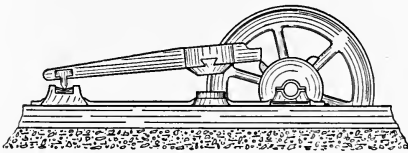

FIG. 45.—The Helve Hammer.

deal with, but they would be in a spongy state, and wet with fluid cinder, so that hammering to consolidate them and remove the cinder as far as possible would be necessary. The hand hammer, however, would be sufficient for the purpose. But as the furnaces increased in size the blooms from them were larger, and the use of sledges even would be ineffective, so that where water power was available, power hammers would come into use for manipulating these larger pieces of metal. Such hammers are very simple in principle, and are still somewhat extensively used, even when steam has to furnish the motive power. They are of two

kinds, the *tilt hammer* and the *helve hammer*, and are based upon the lever principle. In the tilt form the fulcrum is nearer one end, and the hammer head is fixed at the end of the longer arm. In the helve hammer the lever is of the second order, with the fulcrum at one end and the hammer

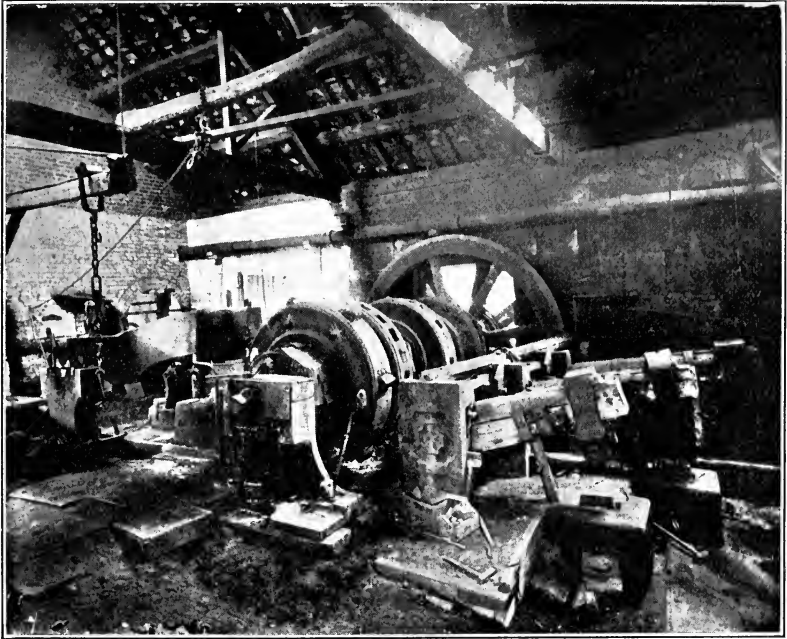

FIG. 46.—Interior of the Clay Wheel Forge showing Tilt Hammers driven by Water Power.

head near to the other. The motive power is furnished by a wheel with a number of projections on its rim; and when these projections are made to press down upon the end of the short arm of the lever to raise the hammer it is of the tilt form; but when the projections press upwards upon the end near the head to raise it, it is of the helve form.

Fig. 45 will serve to illustrate the general principle of the helve. If the tail of the helve is made to project a little beyond the fulcrum, and the driving wheel is arranged for its projections to press down the tail piece and then release it, the arrangement is that of a tilt hammer.

Fig. 46 shows the interior of the Clay Wheel Forge with tilt hammers in position; and Fig. 47 is a view of the exterior of the forge showing the water wheels by which the hammers are driven. The forge is situated on the river Don, about three miles from Sheffield, and is still doing its daily work under the direction of Messrs. Firth.

The tilt hammer is used for light work, and the part to be raised rarely exceeds 5 cwts., often much less. On this account it can be driven rapidly, and made to deliver a large number of moderate blows to the piece of metal on the anvil beneath. It is, no doubt, the original form of the power hammer, and is still in use in the small fineries of Styria and Sweden.

On the other hand, the helve is used for heavy work, and is of considerable size, the part to be raised often weighing from 8 to 10 tons, and having a drop of two feet. It can be made to deliver its blows at varying speeds up to sixty per minute. It is still to be seen doing excellent work in some large forges, but is, of course, driven by steam power.

Treatment of Puddled Balls.—The spongy mass of refined metal drawn from the puddling furnace at the end of the process is at a welding heat, and wet with molten cinder. It is taken direct to the steam hammer, or other form of *shingling* apparatus, and thoroughly hammered or squeezed into a more or less rectangular mass. While the hammering is going on sparks fly in all directions, liquid cinder flows out, and jets of burning gas spurt from the glowing mass. All exposed parts of the body of the hammerman are protected by sheet iron or leather, and to the onlooker he has a very formidable appearance. The work of the hammer-

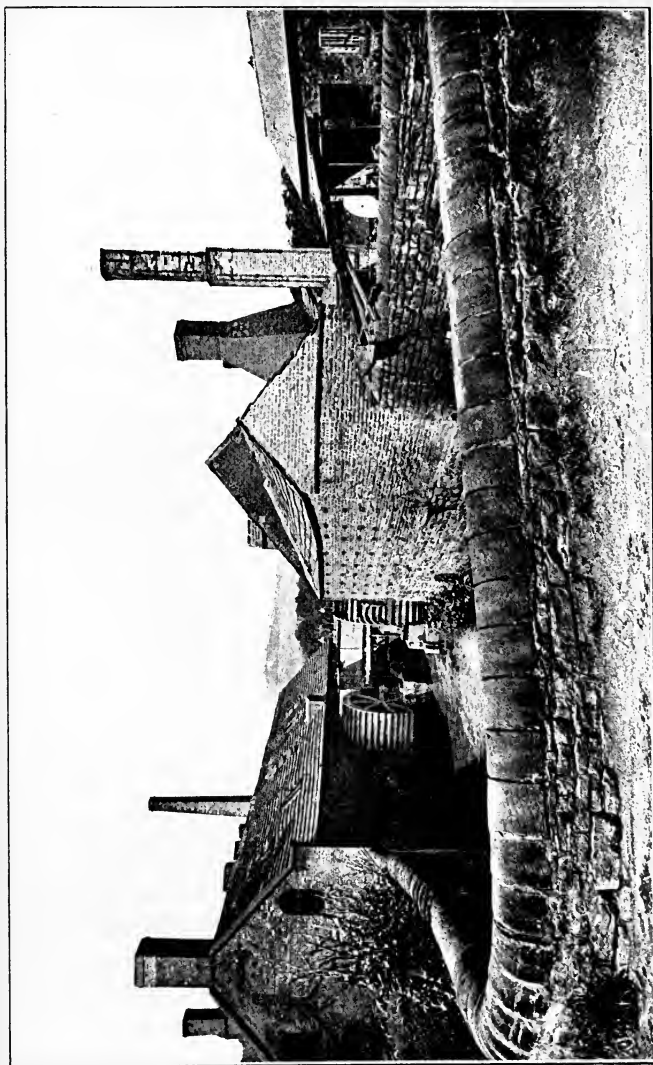

FIG. 47.—Exterior of the Clay Wheel Forge showing the Water Wheel Race.

man is to turn over the hot mass so that it shall be uniformly welded under the rapid blows of the hammer. As the operation proceeds the metal settles down and is finally formed into a rough square slab or bar. As the mechanical energy of the hammer is largely converted into heat during the hammering it helps to keep up the temperature of the metal, and so favours the expulsion of the cinder, which, however, is never complete. The expelled cinder, which is a fairly pure form of tap cinder, collects round the hammer, and is called *hammer slag*. It is used, as already described, as a flux in the puddling process itself.

Steam hammers used for shingling are not very large, as the work they have to do is not particularly heavy. The steam hammer was invented by Watt and improved by Nasmyth, so that it often bears the latter's name. In its perfect form it consists of a steam cylinder and piston supported by standards. The hammer head or "tup" is fixed to the outer end of the piston rod by a kind of ball-and-socket joint, which allows of a little play, and thus prevents the piston from snapping, as it moves up and down in the guide grooves between the standards. The anvil block upon which the work is placed is directly under the head. The whole should be fixed upon a very firm foundation, as the vibration is very great when the hammer is at work. The larger the hammer the greater the care required in making it solid. When steam is admitted below the piston the hammer is raised, and when it is admitted above the piston the hammer is driven down; and the energy of the steam being added to the energy of the falling mass increases the strength of the blow given to a body on the anvil. In a "drop" hammer the steam is admitted under the piston only, and the energy of the blow it delivers entirely depends upon the weight of the head and the height from which it falls. Also, the workman has very

little control over this form of hammer ; but when the piston is double-acting the blow can be regulated with the greatest precision, and very skilful work can be done. The steam

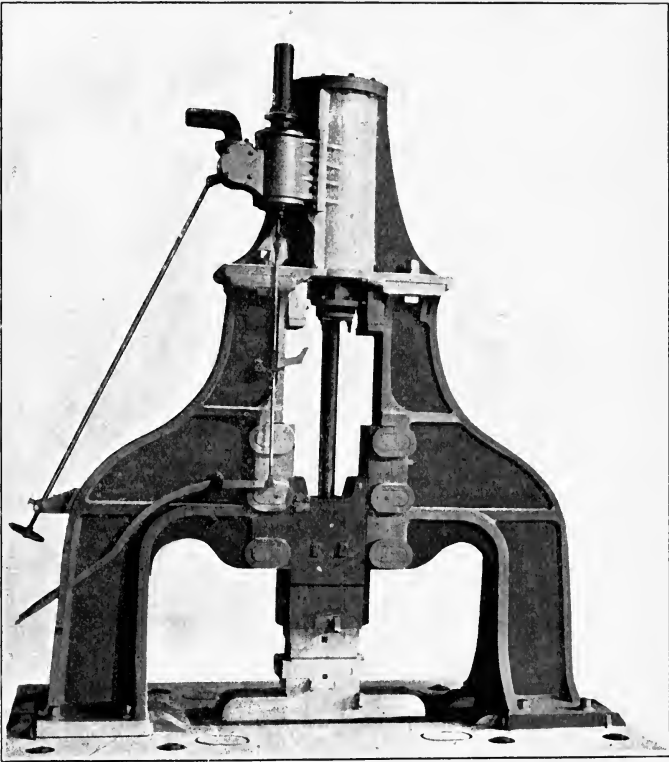

FIG. 48.—Steam Hammer.

valves are connected by lever or screw gearing with the working handles, and the hammer may be stopped suddenly at any part of its journey. Fig. 48 is an illustration of a modern hammer.

Squeezers.—In hammering puddled balls the first blows are delivered so as to exert a squeezing action as far as possible, for it is desired to extend the effects of the blows right to the centre of the mass. Herein lies the principal defect of all hammers. The blow is delivered rapidly, and its effect in the case of a large mass of metal does not extend to the centre; so that the interior is not properly consolidated. In some cases a prolonged pressure, which thus has time to extend through the whole mass, gives better results. This led to the introduction of squeezers, for dealing with the large blooms produced in mechanical furnaces such as the Danks and the Siemens rotators. In the crocodile squeezer the hot bloom is forced between two heavy jaws, which are made to open and close by means of a powerfully driven crank and connecting rod. The lower jaw is fixed, and the upper one movable. The shingler is thus able to push in the ball as the jaw rises, so that it is gripped by the serrated under-surface of the jaw as it descends, and is effectively squeezed. This is repeated until the shingling is finished.

Rotatory squeezers are usually very simple in principle. In one form a segment of a strong iron cylinder is fixed with its cross-section horizontal, and a smaller complete cylinder is made to revolve eccentrically within it so that the space between the fixed and the moving surfaces gradually decreases in width. The working surfaces are serrated, so that when a bloom is pushed into the widest part of the space between the fixed and moving parts it is gripped, dragged through the gradually narrowing space, and finally expelled from the narrowest part thoroughly squeezed and ready for the rolls. The cinder squeezed out drips through the bottom of the machine.

In another form of squeezer two rolls are made to revolve on the same level and in the same direction by means of a pair of horizontal and parallel shafts, while a large cam

revolves above them in such a way that the space between the cam and the rolls gradually decreases. The bloom is dropped into this space when it is at its widest, and is slowly squeezed by the combined motion of the rolls and cam. At the same time its exposed end is hammered by a small horizontal steam hammer. The cinder drips out between the rolls.

Puddled Bar.—The rough slab of metal when it comes from the hammer or other shingling apparatus is still at a bright red heat, and is taken straight to the forge-train, passed through the rolls, and thus worked down to puddled bar. The forge rolls consist of two pairs, one for roughing and the other for finishing. The spaces between the roughing rolls are diamond-shaped, and the working surfaces in the larger ones are roughened so as to grip the metal better. The spaces between the finishing rolls are oblong with the long side horizontal. The rolls themselves are usually made of close grained cast iron. Their necks run in gun-metal bearings supported in heavy iron frames firmly bolted to the ground. The bottom rolls are keyed together, and are driven by a shaft attached to the end of one of the rolls. The top rolls are usually geared to the bottom ones so that they revolve with them but in the opposite direction, and the distance between them is regulated by screws that pass through the tops of the " housings " to the upper bearings. The usual rate of revolution is from 60 to 80 per minute.

The hot slab is passed through the largest space in the roughing rolls, sent back over the top roll, passed through the next largest space, and so on to the end of the finishing rolls, from which a somewhat rough rectangular bar—the puddled bar—is obtained, the original heat of the metal allowing this much work to be put upon it.

Merchant Bar.—The bars produced as described above are very rough-looking and far from homogeneous in

structure, as they still contain cinder distributed through their mass in more or less irregular patches. These bars are sent to the mill to be cut up into short lengths and made into piles. The piles are then raised to a welding heat and worked down to the required sections. A stand of rolls is shown in Fig. 49.

The Reheating or Mill Furnace in which these piles are heated is of the reverberatory type, and is fired either by

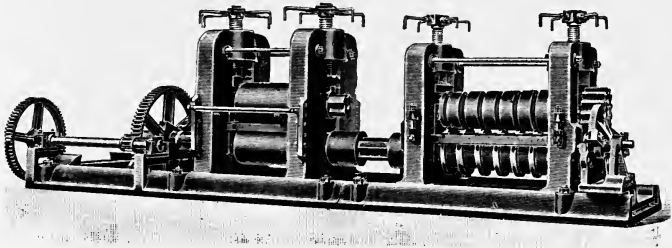

FIG. 49.—Rolls.

solid or gaseous fuel. A vertical section through a coal-fired furnace is shown in Fig. 50, which will serve to illustrate the construction and use of such furnaces. It is similar in general form to the puddling furnace, but the ratio between the grate and the bed is not quite so large. The working bottom is usually lined with sand, and slopes from the fire bridge to the flue, while the roof slopes in the same direction as the bed. The bed plates are of iron, and the inner structure is of firebrick, cased on the outside with iron plates. There is one door, sometimes two, on the working side, and the usual firing hole. In some furnaces a layer of oxide of iron is used for a working bottom, and in others the sand is replaced by basic slag.

The temperature of the furnace has to be kept up to a welding heat. The piles are carefully placed lengthwise

across the bed by means of a charging tool called the "peel," and when the full charge, from one to two tons, has been put in the door is closed, and the air excluded as much as possible. The fire is made up, and the piles are turned occasionally so that they may be uniformly heated. The reheating takes from fifteen minutes to an hour according to the weight of the piles, which varies from $\frac{1}{2}$ cwt. to 6 cwts.,

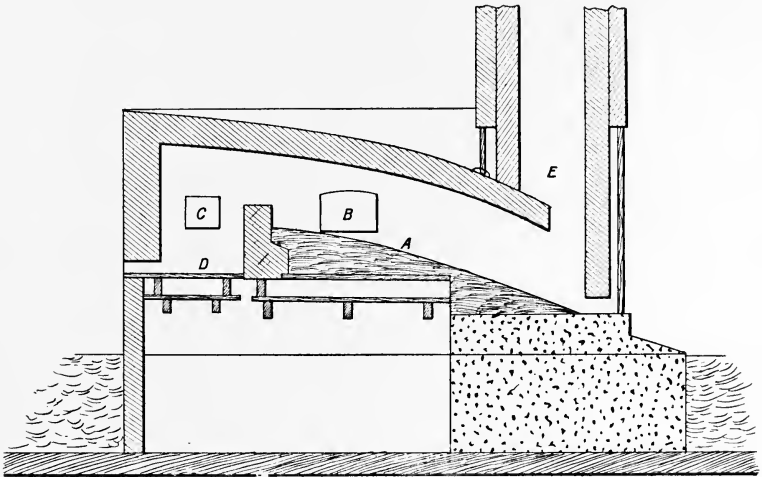

FIG. 50.—Reheating or Mill Furnace.

A, Bed; *B*, Working door; *C*, Firing door; *D*, Grate; *E*, Chimney.

according to the size of the section to be produced. The pile when hot enough is withdrawn by means of a pair of tongs, transferred to a small iron trolley, and at once taken to the rolls. When the furnace has been discharged the bottom is made up and a fresh charge introduced. The cinder drains down the slope of the bed and runs from the flue end. It is known as "mill cinder" or "flue cinder," and consists largely of ferrous silicate rich in silica when a sand bottom is used. When an "oxide" bottom

is used the cinder is much richer in oxides of iron, and is more valuable.

A coal-fired furnace is comparatively inexpensive to build and is easily worked, but these are its only recommendations, for it is very extravagant in fuel, using from three to four times as much as a gas-fired furnace to do the same amount of work. The latter form of furnace is, therefore, very largely used.

The changes taking place in the reheating process are simple in character, for if air is excluded from the furnace as much as possible the amount of oxidation should not be serious. As the temperature of the pile increases the cinder mechanically mixed with the metal in the bars liquefies, and part of it liquates out. In doing so it is brought into contact with the small quantity of impurities not removed in the puddling process, and being oxidising in character, oxidises and carries them out. In this way, not only is the quantity of intermixed slag reduced, but also small quantities of phosphorus, carbon, and sulphur are removed. This liquated cinder, together with that formed by the oxidation of the metal itself, makes up the flue cinder which runs from the furnace. The process is, therefore, to some extent, a refining as well as a reheating one.

The reheated pile is taken to the rolls, and rolled down into a bar, sheet, or section as required. A further improvement in the structure and quality of the metal is sometimes effected by cutting up the bars, piling, and reheating them a second, or even a third time. This extra work, however, increases the price as well as the quality of the metal. But the best qualities of bar iron are now produced more by the careful selection of the materials and their systematic treatment during the manufacture.

The rolls used in the production of the various forms of merchant iron vary much in shape according to the sections

to be produced. Roughing rolls and finishing rolls that have to be turned to shape are cast in sand from a good mixture of foundry irons, or from mild steel. Sometimes they are made of forged steel, and although the first cost is greater the rolls are much more durable. Rolls are also cast in a heavy iron mould by which the metal is chilled to a depth of from $\frac{1}{4}$ inch to $\frac{3}{4}$ inch, and a shell of hard white iron thus formed. Such rolls are used for finishing sheets and plates that are intended to have a smooth surface. The rolls in an iron mill generally vary from 6 inches to 18 inches in diameter.

The mill train, like the forge train, usually consists of two sets of rolls, one for roughing and one for finishing, and resembles it generally. The bottom finishing roll, especially for small sections, has a stripping plate in front of it that follows the contour of the roll to direct the section outwards, and so prevent it from wrapping round the roll. For some purposes, such as sheet rolling, the distance between the rolls must be readily and accurately adjustable. They are, therefore, fitted with adjusting screws that can be turned by lever arms within reach of the roller. The bottom roll is always made a little smaller than the top one, which tends to make the section bend downwards as it passes through, and thus prevents it from wrapping round the top roll.

For rolling small light sections guide mills are used in which the bars are directed into the passes between the rolls by guide plates fixed opposite the collars on each side of the pass. This is necessary because the work has to be done rapidly, as such thin sections cool quickly. A fuller description of the apparatus and processes will be found in the section on Steel Mills.

In the manufacture of sections such as angle, tee, and channel iron, wrought iron is being replaced by mild steel, and for unmarked bar, for which there is no guarantee of

quality, the competition is so keen that it scarcely pays to make it. But marked bars of good quality will hold their own, as the metal undoubtedly works better in the smithy than mild steel. Best Yorkshire bar iron has already been noticed for its quality.

THE STEEL MILL.

In considering the mechanical processes for the treatment of steel, it must be borne in mind that the metal comes from the furnace in the fluid state and is cast into ingots ; so that it is in a different condition to the puddled iron already considered. With iron the welding process may be carried out to any extent within the limits of the apparatus at hand, and large masses may be built up by welding smaller ones together, for the metal can be raised to a welding heat and welded perfectly under the hammer without serious deterioration. But small steel ingots cannot be welded together to form larger masses in the same way, so that whatever may be the size of the section required the metal to form it must be cast into one ingot.

In the old puddling days large masses of metal were seldom treated, and the iron mill was furnished with comparatively small and simple apparatus; nor was there any difficulty in dealing with the waste, as the crop ends could be included in the piles for reheating, and so used up. But had it not been for the introduction of the Bessemer and open hearth processes, further development would no doubt have taken place, for the mechanical puddling furnaces described at the end of Chapter V. would have been improved and enlarged. The men, however, who could have done this had their energies diverted into other channels during the development of the new processes.

Treatment of Ingot Metal.—Now when a piece of iron or steel is heated it expands and increases in volume as the

temperature rises. When it liquefies there is a further expansion, for the liquid occupies a larger volume than the solid at the same temperature, and the higher the temperature is above the melting point the larger will the volume be. Exactly the reverse changes take place as the liquid cools, freezes, and then cools to the temperature of the air. If, then, a given volume of molten steel is run from a ladle into a mould, the volume of the ingot into which it solidifies will be considerably smaller than the original volume. The amount of this contraction is, roughly, 6 per cent. of the original volume. If the mass could by any means be made to solidify uniformly from its centre, the ingot would occupy a smaller volume than the fluid metal, and be uniform in structure. But exactly the reverse takes place, for the metal in contact with the cold surface of the mould is at once chilled and solidified with formation of a thin shell. This shell thickens as the metal cools, and as it contracts during the solidification, the fluid metal in the interior is left in a larger cavity, so that it sinks. But as a skin has also formed on the free surface in contact with the air, it falls in a little as the fluid sinks from under it to form the well-known cavity or "pipe" usually found in the top of the solid ingot (*see* Fig. 51). The metal crystallises as it solidifies, and in doing so passes through a pasty state. When the central portion is just about to set it is in this condition, and is surrounded by a thick shell which it is trying to fill. If it succeeds the solid will be spongy, but if not, a crack or cracks will develop in it. This is a defect in the ingot, as the sides of the crack do not weld together under further treatment. Cracks due to contraction are of the same nature as the pipe. Now if the metal were pure, and no cracks developed, the pipe would form, and the mass generally



FIG. 51.

would be in a state of unequal strain with a tendency to sponginess.

Segregation.—But when the metal is impure, as is usually the case, the impurities, such as phosphorus, sulphur, carbon, etc., are combined with a portion of the iron, and these compounds have a lower melting point than the main mass. As the solidification proceeds from the outside these fluid bodies are partially squeezed inwards from layer to layer towards the centre, and generally towards the top of the ingot. The movement of the impurities inwards is known as segregation. This action is more often beneficial than otherwise, as it tends to concentrate the impurities in one part of the mass. With a moderate percentage of impurities present the segregation is fairly uniform, as is shown by analyses of different parts of the ingot, and by practical experience; but when the metal is very impure the segregation is not, as a rule, uniform.

Occlusion of Gases.—Liquids dissolve gases, and the volumes of different gases dissolved by a given liquid depends upon the nature and volume of the liquid, the nature of the gas, and the temperature and pressure at which the dissolution is effected. The effect of pressure is indicated by the rush of gas from the liquid in a soda water syphon when the pressure is suddenly reduced by opening the valve. Also, when a liquid solidifies on cooling, gas dissolved in it is largely liberated as such. This is noticed in the case of water, which always contains a small quantity of dissolved air, for when it freezes the dissolved gas is liberated and then imprisoned in the form of bubbles in the solid mass. This is due to the water solidifying first on the surface and forming a crust of ice which prevents the expelled gas from escaping. All gas not expelled during solidification is left in solid solution.

Now when a metal absorbs a gas and retains it after solidification the gas is said to be occluded by the metal;

but the absorption may take place when the metal is in the solid or semi-solid condition, as in the absorption of carbon monoxide by red hot iron, which was proved by Graham. Hydrogen and nitrogen are dissolved by iron, and when both are present they may be, in part at least, in combination with each other as ammonia. Gaseous hydrocarbons may also be present, and some authorities say carbon dioxide too; but this is somewhat difficult to account for, as carbon dioxide is reduced to the monoxide by red hot iron.

The method of detecting the presence of gas bubbles in the solid metal is to drill a piece of it, either under water or under mercury, in such a way that the escaping gas can be collected, measured, and analysed. The problem is a difficult one, and varying results have been obtained by different observers; but that does not affect the general statement that gas does remain in solid solution in iron and steel at ordinary temperatures. The influence of occluded gas on the physical and mechanical properties of the metal is not at all understood, but there seems to be a general consensus of opinion that if the gas, whatever may be its nature, can be kept in solid solution, its influence may be neglected. It is when the gas is liberated in the pasty metal and, failing to escape, causes blow-holes, that difficulties arise.

A mass of molten steel may be fairly tranquil in the ladle and still contain a considerable volume of gas in solution, but when it is teemed into the mould the gas commences to escape, and this escaping gas usually consists of hydrogen, nitrogen and carbon monoxide during a normal solidification. But sometimes, when the deoxidisers have not removed the oxygen sufficiently, reaction takes place between it and carbon, with formation of carbon monoxide and dioxide, and the sudden escape of these gases will sometimes cause the metal to boil out of the centre of the ingot, and leave

only a shell in the mould. This phenomenon is known as a "wild heat," and the metal is said to be "wild." It is well known that certain chemical changes are held in abeyance until the temperature falls below a certain limit, and then take place rapidly. This is the probable reason why the metal does not "boil" until it is in the mould. This wildness is usually noticed in the case of Bessemer metal that has blown too hot from the presence of too much silicon in the charge. The deoxidisers are then not able to sufficiently reduce the oxide of iron formed, and the metal is "wild."

The presence of a dissolved solid in the solution of a gas may prevent the liberation of the gas, while the solution itself becomes solid, and this is put into practical use for the prevention of blow-holes in ingots. Aluminium and silicon seem to possess this property, though why the gases are kept in solid solution by these elements is not clear, but the actual result is remarkable. The writer saw an experiment to demonstrate this conducted in Prof. Arnold's laboratory at Sheffield. Two exactly similar charges were melted down in two crucibles placed side by side in the same fire; after they had been molten for some time a small piece of aluminium was dropped into one of the crucibles, and both charges were teemed into similar moulds. The ingot containing the aluminium was very compact and considerably shorter than the other, which, from its appearance, was very spongy towards the top. On the same day he saw a few ounces of aluminium thrown into a ladle containing 20 tons of steel ready for casting. Aluminium and silicon may also act as deoxidisers, and thus prevent carbon from reducing oxide of iron, left in by the manganese, with liberation of carbon monoxide.

It would appear, however, that ferro-aluminium is the best form in which to introduce the aluminium on the large scale. Ferro-silicon is used in the same way, and Pourcel,

the French metallurgist, states that he always found silicon in steel free from blow-holes, which supports the statement that the silicon acts by keeping the gases in solution.

The escape of gases from the molten metal is facilitated by rapidly rotating a paddle in it just before tapping it from the ladle into the moulds. This purely mechanical process was introduced by Mr. Allen.

The influence of pressure in keeping the gases in solution has been practised, and this pressure has been applied in a variety of ways. At the Krupp works a gas-tight cap was fitted on the top of the mould into which the metal had just been tapped, and liquid carbon dioxide was allowed to vaporise from a strong receiver into the space above the molten metal, there to exert its pressure. Jones, of Pittsburg, tried the effect of introducing high pressure steam into a similar cap. But these methods, although partially successful, have not come into permanent use.

The Whitworth Press.—The method introduced by Sir J. Whitworth for compressing fluid steel is the most successful, but as the apparatus is very costly it has only come into limited use in the casting of steel required for ordnance purposes. The latest hydraulic press used for the process can exert a pressure of 8,000 tons, and is probably the most powerful in existence.

In the Whitworth process a special mould able to resist a very powerful side thrust is required. It is made up of a number of forged steel hoops lined with shaped cast iron bars. Radial grooves in these bars open into vertical channels between the lining and rings, made by bevelling off the outer edges of the bars. Gases have thus a free exit from the interior of the mould, and can escape through the vertical channels from the top and bottom of the mould. The iron lining is coated internally with refractory material spread on in a layer about $\frac{3}{4}$ inch thick. The bottom of the mould consists of an iron plate faced with firebrick, and the

top is closed by an iron plate with a circular hole in it. A plug faced with firebrick and fitted to the upper fixed table of the press can just pass into the hole in the top plate with a clearance of about $\frac{1}{20}$ inch. After the inside has been coated with plumbago and warmed to expel any moisture, the mould is put into position on a small truck in the casting pit close to the press, and filled with molten steel: it is then run, with the truck, on to the lower table of the press. The ram then raises the table until the plug enters the hole in the top plate of the mould. As the ram moves upwards some of the liquid metal, which is now in contact with the lower face of the plug, is forced into the annular space around it, and, chilling, forms a perfectly tight joint. As the pressure is increased much combustible gas issues from the top and bottom of the mould with a loud hissing noise, and burns there. The gas is usually accompanied by a fine metallic rain. The ingot shortens rapidly at first, then slowly, and the pressure is continued for a time after the metal has set. When the mould has been removed the ingot is found to have decreased in length by about $1\frac{1}{2}$ inches per foot, and the proportion of scrap made in working it is considerably reduced.

Various estimates of the pressure required to be effective have been given, and it appears that any pressure under 2 tons per square inch is insufficient. Sir J. Whitworth himself contemplated using a pressure of 20 tons per square inch.

M. Harmet, of St. Etienne, France, uses a mould with a short square section at the bottom and then tapered off slightly to the top. The top of the mould is open, and a cast iron plug fits into the bottom. If, when the metal has been tapped into this mould and is partly set, the plug is forced upwards by a hydraulic ram, the ingot is compressed laterally by being driven up the tapering portion of the mould. Harmet claims that the proportion of sound metal

is considerably increased. The process has also been introduced into a Scotch steelworks.

The general effect of pressure on the fluid appears to be to increase the proportion of sound metal in the ingots. But although the gas seems to be driven out, it is the opinion of those who have had most to do with the process that no more gas is expelled than would escape under normal conditions of cooling. Any blowholes formed in the pasty metal would, however, be smaller in proportion to the initial pressure on the gas in them; and it would seem that the general tendency would be to keep such gas in solid solution.

With regard to the decrease in the weight of the crop ends, this seems of no importance in a general way, as the open hearth is eager to take back such waste metal, and, in fact, could use up more than is formed. It would appear from statistics of American practice that the portion of steel ingots going back to the furnace is upwards of 20 per cent. of the output. In fact, it is only in special cases that ingots are treated in the moulds, except being stoppered as in the case of mild Bessemer metal.

Soaking Pits.—After the mould has been removed from an ordinary cast the ingot stands at a red heat, and to all appearance solid; but as already indicated, the central portion is still fluid, and if it is allowed to solidify by normal cooling in the air the segregation will not be so perfect nor the strains in the mass so uniform as if it had solidified in a hot shell. Bessemer himself had this in mind when he covered the stripped ingots with sand to retard the cooling; but Gjers clearly grasped the best conditions when he introduced the principle of the soaking pit. Now the shell is thick enough while still at good red heat to allow of the ingot being handled. If then it is lowered into a rectangular chamber, the walls of which are as hot as the outside of the ingot, the latent heat of liquefaction of

the solidifying core will, as it escapes outwards, be in part arrested by the cooler shell, and the general temperature of the ingot will be increased. In this case, when the whole is solid it will be hotter than the shell was when the ingot was put into the chamber. Also, the solidification will be slower, and there will be more opportunity for segregation towards the top, and for the equalisation of strains through the mass. This is assisted by the upright position of the ingot. Another good point is that the interior is usually hotter than the exterior, and the ingot works without a "bone" in it as is sometimes the case with re-heated ingots, the outside of which may be hotter and softer than the insides. Theoretically, the simple principle of the soaking pit is ideal; but it requires the walls to be heated first to the necessary temperature, and then a constant and regular supply of ingots to pass through it, each ingot being in the pit about twenty minutes. Practically, these conditions are more or less difficult to comply with, and it is usual to keep up the temperature of the walls during intermittent supply by the use of solid or gaseous fuel in modified pits. The pits are generally built below the floor level close to the mill, and have flues in their side walls in which producer gas is burnt, or, failing this, the gases from a slack-fired grate attached. The pits can thus be heated up to commence work, and the temperature regulated during working.

A Reheating Furnace, in which the ingots can be placed in a vertical position, consists of a rectangular chamber lined with ordinary firebricks, and divided at the top by brickwork partitions that extend down to about half the depth of the chamber. The spaces on the floor level between these partitions are fitted with covers, any one of which can be removed separately when an ingot is to be put in or taken out. The bottom on which the ingots rest is best made up of hard, infusible basic material, such as

good hæmatite ore, hammer scale, or non-siliceous flue cinder. Messrs. Harbord and Tucker introduced the use of basic slag for this purpose some years ago, and it has been very successful. With such a bottom very little fluid cinder is formed in working, and the little that does form runs away through a tap hole provided for the purpose. For a coal-fired furnace the grate is at one end of the chamber, and the products of combustion from it pass through the space below the partitions to the flue, and so keep up the temperature of the side walls and partitions. It is clear

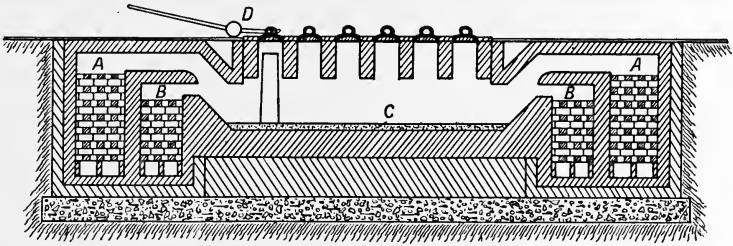

FIG. 52.—Gas-fired Re-heating Furnace or Soaking Pits.

A, Air regenerator.
B, Gas regenerator.

C, Working bottom.
D, Lever cover lifter.

that such an arrangement can be used to soak ingots as well as for reheating.

Gas-fired furnaces to which the regenerative principle is applied are also used, especially in America. They are constructed on the same general plan as the Siemens open hearth furnace, but the heating chamber is modified so as to receive the ingots in the vertical position, and to allow of working from the floor level. Fig. 52 is an illustration of a gas-fired reheating furnace or soaking pits. When an ingot is to be put in one of the spaces the cover is removed, either by hooking it on to a chain suspended from a travelling crane, or by means of a bent lever bar, the

short arm of which is pivoted to the axle of a pair of wheels, so that its end can be pushed into a lug on the cover. On depressing the long arm of the lever the cover is raised, and can be run back clear of the opening. Then the ingot, suspended from the end of a crane, and held by a pair of "dogs," is brought over, lowered into the furnace, and the cover replaced. When ready for the mill it is taken out in a similar manner.

To put a partly solidified ingot on its side in a reheating furnace is not good practice, and should be avoided, for the pipe at the top of the ingot is thus encouraged to extend itself, and in some cases may run nearly the whole length of the ingot. Another objection with large ingots, which are difficult to turn over, is that they are not uniformly heated, so that even with cold ingots it is better that they should be re-heated in a vertical position. Another point of importance in the case of large ingots that have been allowed to get cold, is that they should be heated up slowly. Such ingots are in a state of unequal strain, and if put suddenly into a very hot space may develop cracks. Also, steel ingots containing a high percentage of carbon must be slowly and uniformly heated, or they will deteriorate. It is too costly to put such ingots into a comparatively cold furnace and then gradually heat them up, for the furnace would have to be cooled down after each heat before another could be charged. The difficulty has been got over by the use of a furnace with a long sloping bed, into which the ingots are introduced at the flue end, and gradually rolled down the bed into hotter and hotter positions. The ingots are turned over and moved forwards by means of iron bars put through the working doors in the side of the furnace, so that they are heated uniformly all over, and ready to withdraw by the time they reached the fire bridge. The hot gases from the grate in their passage to the flue come into contact with cooler and cooler ingots, by which their heat

is absorbed, and pass into the flue at a comparatively low temperature. A considerable economy of fuel is thus effected. The first furnace of this description was constructed by Ekman in Sweden about 1848. Several modifications of it have been constructed and used in this country, on the Continent, and in America. One of the latest is the *Talbot Continuous Furnace*, which is gas fired with producer gas burnt in hot air. The direction of the gas is not reversed in the furnace, but only in the regenerators, so that one end of the bed is continually cooler than the other. The bed slopes but slightly, and the ingots, which are put into the furnace at the cool end, are pushed along by a hydraulic pusher, and finally discharged on to live rollers, by which they are hurried off to the mill. Blooms, billets, and slabs can also be reheated in continuous furnaces. But they are more commonly dealt with in the ordinary reheating furnace.

The Rolling Mill.—The rolls used in a steel mill are for the most part cast iron, and are made from a mixture of cold blast foundry irons of the higher numbers. For chilled rolls the silicon should not be more than 1 per cent. and the phosphorus less than 0·5 per cent., while the sulphur should be less than 0·1 per cent. The mixture is melted for casting in a reverberatory furnace fired with coal low in sulphur. Steel rolls, both cast and forged, are also used, and pay for the extra cost in the long run, as they are much more durable than cast iron ones.

The “two-high” mill contains two rolls carried in “housings” and driven in opposite directions at the same rate. A single roll, as it is cast and finished ready for insertion in the housings, consists of the body or barrel, the two necks or journals which revolve in the bearings, and the two wobblers. The body must not be too long compared with its diameter, as it would bend or break under the heavy stresses put upon it. The usual limits are from two to four times its diameter. The two rolls are

rarely duplicates except for square, rectangular, and round sections. They are cast, and then turned in a lathe to the necessary shape.

The two *housings* or standards in which the rolls work, and by which they are kept in the proper relative positions, are massive cast iron or steel frames firmly fixed to the bed plate by means of pins and wedges, and further held in position by tie rods at the top and bottom. The bed itself is firmly bolted down to a very solid foundation, so as to be practically immovable. The masonry of the foundation is several feet thick, and the bolts or pins run right through it, and are fastened on the underside by plates and nuts. This fixing is augmented by running in cement all round the bed plate. The *chocks* which carry the bearings are fitted loosely into the housings to allow for expansion when they get hot, and the bearings themselves are made of gun metal, bronze, or white metal. The space in the housings, in which the chocks are fitted, should be large enough to allow of the roll being drawn through endwise after the chocks have been removed. This is very convenient, and saves time when the rolls have to be changed. The bearing for the bottom roll may either be fitted with a chock or form part of the housing itself, but the bearing for the top roll must be arranged so that it can be moved up and down during working. It is raised or lowered with the roll by the movement of a screw passing through the top of the housing. To do this the chock is suspended by rods from a cross-piece through which the screw passes. The bottom of the screw is expanded, so that when the screw is turned upwards the projection at the bottom catches against the cross-piece and raises it together with the chock and roll. But when the screw is turned downwards it passes through the cross-piece, and coming into contact with the top of the chock, forces it down and the roll with it. In this way the two rolls can be arranged at a

given distance apart, or brought into contact as desired. The bearing in the chock must extend round the neck of the roll sufficiently to hold the roll when it is raised, but it is seldom that the bearing extends far enough round in one piece to grip the neck. It is usually in three pieces, one at the top and one on each side, so as to reduce the friction as much as possible, consistent with steady working. Very heavy rolls are balanced so as to reduce the power required to raise them, and also the shock when the roll drops back after a pass.

In a fully equipped mill for rolling sections there are fittings on each side of the rolls to ensure proper working. When the bar of metal is presented to the pass between the rolls it must enter properly, or it will probably get between the collars on one or other side of the pass, and damage the rolls. To prevent this, *guides*, which follow the contour of the rolls, are fixed close to the collars of each pass, so that the metal is forced to enter the pass properly. There is also a *fore plate* parallel with the rolls, and under the guides, over which the metal slides on entering the pass. There is always a tendency for the hot metal to stick to one or other of the rolls, and thus to wrap round it. This must not happen, so the top roll is made slightly larger than the bottom one, which determines that the metal shall cling to the lower one on leaving the pass; it is then prevented from winding round the roll by having a guard plate sufficiently close to and following the contour of the bottom roll. This directs the metal outwards. All these fittings are not necessary for every rolling operation.

Driving the Rolls.—Since the top roll rises and falls when at work, although in some cases this motion may be small, it is evident that the connection with the source of power cannot be perfectly rigid. Both rolls are driven in most cases to ensure uniform working. To effect this, the wobblers at the same end of the two rolls are connected

with the wobblers of a pair of helical pinions by short spindles kept in position by two coupling boxes. These boxes, which loosely fit the spindle, are on it when it is brought into line with the end of the roll and the end of the corresponding pinion. They are then slipped on to the wobblers, and are prevented from moving back by pieces of wood laid along the exposed part of the spindle and bound to it by iron hoops. A sufficiently loose gearing is thus obtained to allow of easy working. As both rolls are fitted in the same way, and the two pinions are geared together, when one pinion is driven both rolls revolve and in opposite directions. The pinions, which are in effect short rolls, run on bearings in their own housings. The mill is usually driven through the bottom pinion by connecting it directly with the shaft of the engine. Coupling boxes and a spindle are used as before. The helical pinions are in effect open screws with their axes vertical, so that the teeth come into action with a sliding motion that produces very little shock. Ordinary cog-wheels are sometimes used, but as the teeth must be strong there can only be a few of them, and the motion produced is of a bumping character.

The Pull-over Mill.—The original method of working, and one that is still largely followed for light work, may be described as follows: one end of the hot bar to be rolled is brought on to the fore plate by the workman, called the “roller,” and pushed into the pass, through which it runs rapidly. The man on the other side, the “catcher,” then grips it with a pair of tongs and passes it back over the top roll to the roller, who pushes the end into the next pass. These operations are repeated until the rolling is finished. This method is more or less satisfactory in dealing with light sections, for the workmen are very expert in passing them to and fro, especially when they are on “piece” work; but for dealing with heavy masses of hot metal lifting machinery is necessary, and time is wasted.

The Reversing Mill.—One way of saving time is to reverse the rolls at each pass so that the bar may be passed backwards and forwards through them until the rolling is finished. In rolling heavy ingots the bottom roll is nearly level with the floor, and a number of auxiliary rollers are fitted into the floor in front of the roll and parallel with it. The one between the housings is driven from the roll itself and takes the place of the foreplate. A number of vertical bars are arranged between the rollers, so that when not in use their upper ends are below the general level. One set

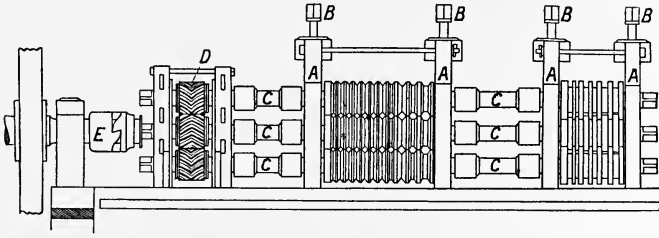

FIG. 53.—A Stand of Three-High Rolls.

- | | |
|-------------------------------|-----------------------------------|
| <i>A</i> , Housings. | <i>D</i> , Helical gearing rolls. |
| <i>B</i> , Adjusting screws. | <i>E</i> , Driving coupling box. |
| <i>C</i> , Coupling spindles. | |

of these bars can be forced up vertically to lift an ingot off the rollers and tilt it over. These are the “tilters.” Another set can be raised and then moved in a horizontal direction between the rollers so as to push the ingot sideways. These are the “skids.” There is exactly the same arrangement on the other side of the rolls. Suppose now that a red hot ingot of from one to two tons is dropped on to the rollers, it is first tilted and skidded into the proper position, and then the rollers are started to bring it to the rolls, through which it passes. The rolls are then reversed, and it is passed back in the same way. This is repeated until the ingot is sufficiently brought down. It is interesting

to see the rapidity with which the tilters and skids deal with large masses of red hot metal.

When two sets of rolls are used, as in plate rolling, travelling tables, fitted with live rollers, and mounted on wheels, are provided. These can be drawn from one set of rolls to the next, along rails laid parallel to the rolls. The bar to be rolled into a plate is passed backwards and forwards through the one set of rolls, and then taken to the next set (usually chilled rolls) to be finished. This is easily effected by drawing the table with the plate on it in front of the finishing rolls.

The Three-High Mill.—Fig. 53. In a mill with three rolls the return pass is obtained without reversing, which is a great advantage for moderately light work. The three rolls are arranged one above another in the housings, and are geared together by spindles and pinions in the same manner as to the two-high mill. The mill is driven from the middle roll, and as the top and bottom rolls revolve in opposite directions relatively to the middle one, a bar may be passed between the bottom and the middle rolls and back again between the middle and top rolls. The bar will, therefore, only have to be raised through a height equal to the diameter of the middle roll on the one side, and lowered through the same distance on the other. This is of no importance with light pieces, but with heavy ones the necessary lifting apparatus would be required. This form of mill was first used in America in 1857, and has been brought to great perfection there. Some of the largest American mills used for very heavy work are “three high.”

Continuous Mills consist of a number of two-high mills arranged in tandem. The rolls all run in the same direction, and the passes between them gradually decrease in section from the first, where the metal enters, to the last, where it leaves in the finished state. The difficulty with small pieces of metal is to keep them sufficiently hot for the

necessary amount of work to be put into them; and it is clear that the more rapidly they are passed through the process the better. In the continuous process different parts of the bar may be passing through several mills at the same time.

The Looping Mill furnishes a good example of rapid working. It consists of several three-high mills arranged side by side in a straight line. Suppose that telegraph

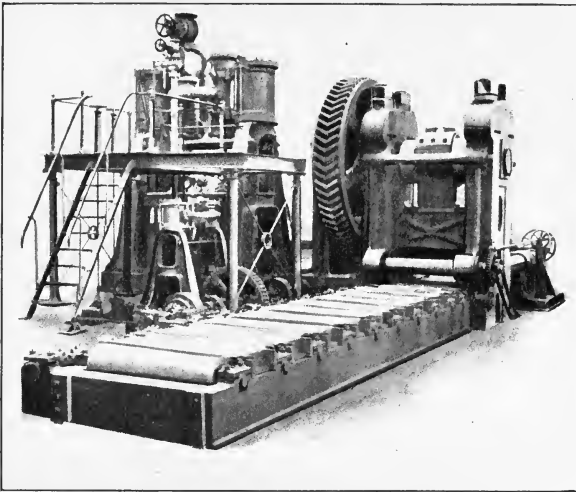

FIG. 54.—Blooming Shears.

wire is being rolled in this mill. The bar is run backwards and forwards, and as soon as it can be bent up it is directed into the next pass above before it is through the last. It is then pulled down into the next pass on the other side, and so on. The bar is then passing through the rolls in a series of loops, and as soon as the end is through the last pass it is carried on to the next mill, and treated as before. The operation requires expert workmen, but it takes the minimum time for completion.

In a complete steel mill there are two sets of operations. (1) *Cogging* or blooming; (2) *Section* rolling. At one time cogging was all done with a steam hammer, but the cogging rolls have now largely taken its place, as they are much more economical of both power and labour per ton of ingots treated. Still, first cost has to be considered, and a cogging mill is a very expensive item; but in large works, where upwards of 1,000 tons of ingots are put through per week, there is no doubt as to its success. The cogging process is used for ingots varying from 15 cwts. to 4 tons. They are square in cross section, and from 12 inches to 22 inches on the side. The object is to reduce the cross section, increase the length, and improve the structure by putting work into the metal. The cogging rolls vary in size according to the general run of ingots to be passed through them. For small ingots the rolls are about 30 inches, and for large ones about 45 inches in diameter.

The ingot is brought direct from the soaking pit or reheating furnace, and passed through the rolls backwards and forwards until it is reduced to the required section, which may be either square or rectangular. When the bar is square and 6 inches or more on the side, it is called a *bloom*; and when it is wider than it is thick it is termed a *slab*. If, however, the section is square and less than 6 inches on the side, the bar is known as a *billet*.

Powerful apparatus for shearing blooms, slabs, and billets is required for economical working. When an ingot has been cogged down to a given section, its weight per foot of length is known, and if it is then taken to the shears, the imperfect ends can be chopped off, and the remainder cut into lengths of known weight. These are then passed direct to the ordinary mill, and rolled to the required shape and size with very little waste. This is much less costly than keeping a large stock of moulds of different sizes, and attempting to cast ingots of given weights.

Fig. 54 represents a pair of powerful blooming shears with live rollers for carrying the blooms forward. The lengths cut off are regulated by the use of stops on the further side. If the pieces are not hot enough to go to the finishing rolls they are reheated.

The number of shapes into which steel is rolled is very large, and section rolling has almost developed into a fine art. Some rolling processes are very ingenious, and are protected by patent rights.

Rail Rolling.—The making of a railway rail is a good example of section rolling, and will serve as a general illustration of the process. The mill used in this country is reversing, and the reheated bloom is gradually broken down to the required section. The general form of the rolls is shown in Fig. 52. The numbers represent the order in which the passes are made. The rail, when it comes from the last pass, is cut into lengths by saws while still hot, and slowly cooled. It is then pared to the exact length, straightened, and the holes for the fish bolts drilled in it simultaneously. Each rail is, therefore, an exact duplicate of its fellows. The weight of the rails for main lines is about 100 lbs. per yard.

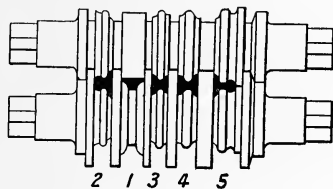

FIG. 55.—Rail Rolls.

Plate and Sheet Rolling.—Slabs are used for conversion into plates and sheets. The difference between the two is largely a matter of thickness, for plates are more, and sheets less, than $\frac{1}{4}$ inch thick. Plate and sheet mills are furnished with plain rolls and accurate adjusting screws. They require considerable experience and care to roll to exact size. The rolls always spring a little, and the heavier the pinch put upon the metal between them the more they give

way. This causes the thickness of the plate to vary somewhat in parts. Long rolls are usually turned a little thinner in the middle, and all rolls used for this kind of work require frequent redressing. Armour, ship, and boiler plates are largely produced, and when they are of considerable dimensions require heavy auxiliary apparatus for handling, straightening, and shearing purposes. Large plates are an advantage from the constructor's point of view, but there are limits to the size, such as the weight of the ingot, the capacity of the mill, and the means of transport to the user. Ship plates 30 feet long and 4 feet wide are common, and boiler plates 22 feet long, 5 feet wide, and $1\frac{1}{4}$ inches thick, are not uncommon.

Small thin sheets are still largely made in pull-over mills. The roller and his underhand keeps the sheets going through the rolls one after the other. The roller starts the first through the rolls, and follows it up with the second. By the time this is through the underhand has passed the first back over the rolls, and this goes on until both are reduced to the required thickness. The rolls are brought nearer together by the adjusting screws between each double pass. When thinner sheets than can be rolled singly are made, two of the singles are placed one on top of the other and rolled together; while for still thinner sheets, the two ends of a "double" sheet are brought together, the whole pressed flat, and the four thicknesses passed through the rolls after reheating, if necessary. The single sheets in the pack usually stick together, and are then separated by passing through a machine which breaks up the film of oxide between them. Sheets that are to have a clean bright surface are pickled in dilute sulphuric acid, dried, and passed through smooth chilled rolls, by which the surface is brought up. Cold rolling is not much resorted to except when a bright finish is desired, or when the dimensions of the section must be accurate, as in the case of shafting. In

rolling to size, it is to be remembered that the exact dimensions of the finishing pass depend on the temperature of the rolls, and those of the finished section, on the temperature from which it cools. The higher this temperature the smaller will the section be when cold. Therefore, for exact work, the piece must be brought down to the approximate section while hot, and finished in chilled rolls when cold.

Rod Rolling.—No operation in the mechanical treatment of iron and steel has undergone so much development as that of rod rolling. It will be readily understood that much breaking down is required in converting a short thick billet into a very long thin rod. Also, that the thinner the rod becomes the more rapidly will its parts cool, and, therefore, the faster must the operation be carried on. A square billet cannot be broken down at once into a round rod, but must be gradually made to take the final shape as it increases in length. In the case of rounds, the spring of the rolls causes the section not to be truly circular, but this defect diminishes as the rod thins down. A very long thin rod approximates to a wire in character, but it is not strictly so, although it is sometimes called wire when used for rough purposes, such as fencing. But iron or steel wire is first rolled hot, and then cold drawn through a plate to the required gauge. The looping, or Belgian mill, has already been mentioned, and is largely used for rolling long rods. A three-high mill or its equivalent must be used, as the loops form on both sides. As the section decreases the rod runs through faster, and the loops become longer, so that they have to be run out, and this requires extra labour, with more floor space. The free end, when it leaves the last pass, is attached to a reel, and the rod wound on as fast as it comes through. Thus the rod is in a coil when finished. The free end of the rod, as it issues from a pass, is caught and twisted before it is presented to the next. In this way the sides are brought

to the top and bottom of the next pass, and a more uniform section is obtained.

Bedson, of Birmingham, adapted the continuous mill very successfully to rod rolling, and it is now used in a more or less modified form both in this country and in America. Now it is evident that the smaller the section of the part of the rod running through a given pair of rolls, the faster must they run in order to take in the increasing length of rod coming through the pair behind them. To meet this difficulty the rolls are geared to the main driving shaft in such a way that succeeding pairs run faster in the same proportion as the rod lengthens. Also, alternate pairs are run vertically, so that the rod is presented at right angles to each succeeding pass. Difficulties were met with in working the original mill that have been overcome in the modified forms; while the winding on the reel at the end has been made automatic. The billets are brought straight from the reheating furnace to the first pass, and the rod is rolled through to the last. The energy of the rolls appears largely as heat in the rod, and the operation is carried on so rapidly, that when it leaves the mill the rod is nearly as hot as the original billet was on entering, and this in spite of the fact that the rolls are cooled with water. During the cooling of the coil on the reel the surface is oxidised and scale formed; to prevent this the rod is sometimes passed through water before it reaches the reel. In the case of medium carbon steel rod the cooling is regulated so as not to harden the metal sufficiently to necessitate its being annealed before being drawn into wire.

The length of rod in one coil varies considerably, and may be as much as 600 yards. It is often rolled down to $\frac{1}{8}$ inch in diameter when it is to be used for wire drawing.

Wire Drawing is a very ancient process, and consists in drawing the piece of metal through a series of holes of

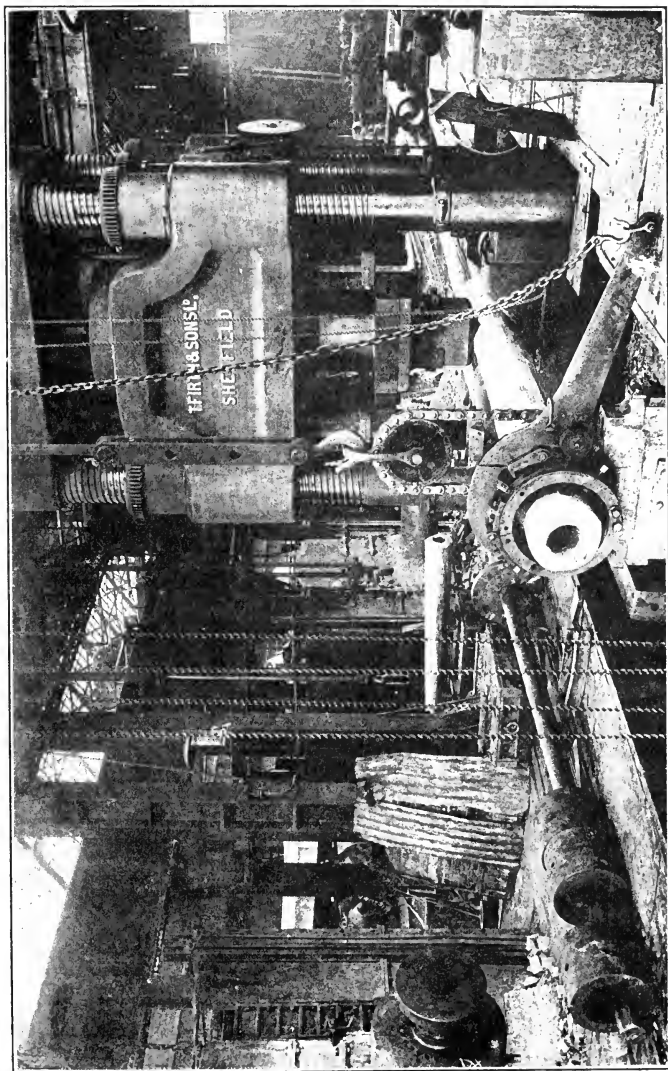

FIG. 56.—3,000-Ton Hydraulic Press with Work in Position.

gradually decreasing size in a draw plate, until it is reduced to the required diameter. If the thickness to be reduced is considerable, the wire will require annealing one or more times during the process, as it is hardened and rendered brittle by the work put upon it. But this may not be necessary with iron or steel wire, if it is first reduced by hot rolling. In a continuous wire drawing machine, which is the latest development in this direction, a series of vertical dies and horizontal drums are arranged in line, and the coil of rod is placed on a loose reel at one end. The rod is started through the first die and wrapped round the first drum several times; it is then passed through the second die to the second drum, and so on through the series. The free end is then connected with the winding reel, which is revolved with sufficient force to draw the wire through the last die. The different drums are revolved at varying speeds to compensate for the increasing length of the wire, and each drum draws the wire through the preceding die. In this way the pull is distributed and no part of the wire is unduly strained. The rod must be carefully pickled in dilute sulphuric acid to remove the scale, passed through lime water to remove excess of acid, swilled, and dried. Unless this is done the hard scale will injure the dies, and the wire will be defective. The number of dies is regulated by the thickness of the wire, and how much it can be reduced without annealing. The wire as it comes from the machine is hard, and if wanted soft has to be annealed. Common wire is often annealed in the ordinary furnace, and a scale is formed on its own face. This can be avoided by close annealing in an iron pot. Both hard and soft wire are put on the market.

Steel Forging.—The tilting of tool steel has long been practised, and for some purposes gives better results than rolling. It is now carried out with small steam hammers in a very effective manner. For large forgings, hammers of

corresponding size have to be used ; but with a considerable thickness of metal the blow is not sufficiently penetrating, and the centre has little or no work put into it. Still, many large pieces are forged into shape under the hammer for engineering purposes. But much more effective work is done by the *forging press*, especially with large masses of metal. The pressure lasts long enough for its effect to extend to the centre of the mass. These presses are now used in all the large steel works. One in regular work at Messrs. Firth's, Sheffield, exerts a pressure equal to 3,000 tons, and is worked by engines of 1,200 h.-p. The writer had the pleasure of seeing this powerful tool at work on a 20-ton ingot that was being drawn out under it.

There are a number of hydraulic presses in use, which vary in construction and detail of working, but in all of them the pressure put on the work is exerted by water in a hydraulic cylinder, the ram of which moves downwards. The head of the ram carries the pallet which comes into contact with the forging. Auxiliary cylinders are required for raising the ram after it has worked through its stroke. In some forms accumulators are used, into which water is forced under a dead weight ; in others, direct acting pumps supply the pressure ; and in others a long piston of small section is forced from a steam cylinder into the pressing cylinder to drive the ram to its work. Very strong cylinders of cast or forged steel are necessary to withstand the enormous pressure of four tons per square inch used in some of these presses, and the valves and collars must be as perfect as possible. The best forms of the press are under perfect control.

Large ingots are not usually cast square in section, but in the form of a hexagon with slightly fluted sides, as they then take the forging better. On account of the slow rate of cooling of such large masses, segregation of phosphides and sulphides may take place to a hurtful extent. Also, there is more liability to unequal distribution of

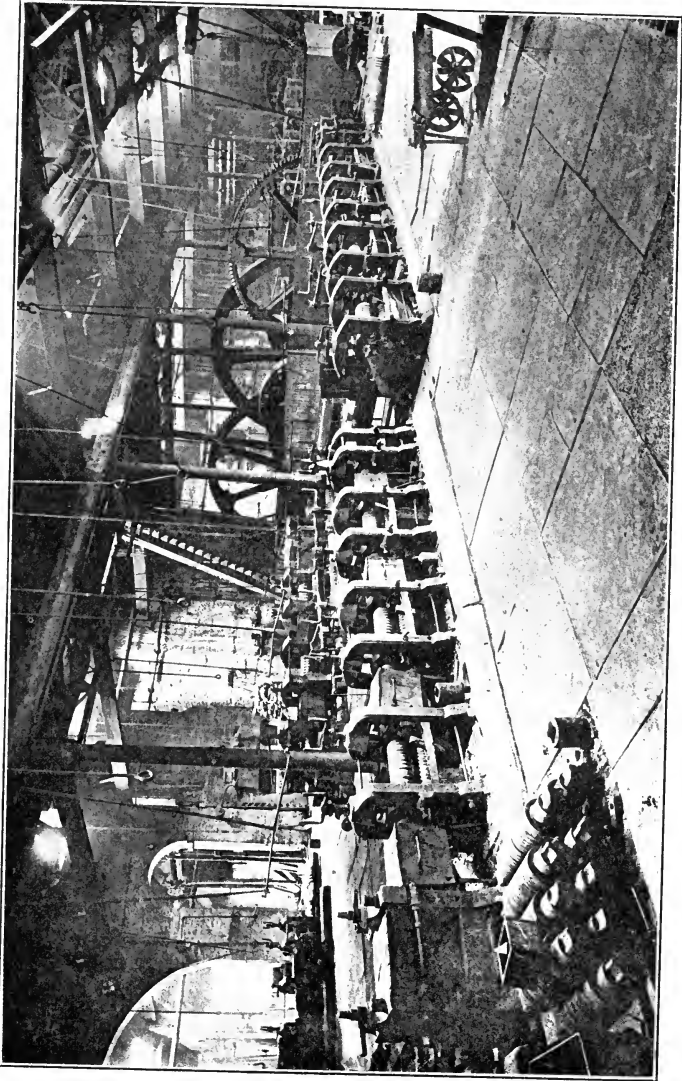

FIG. 57.—Interior of Steel Rolling Mill.

strains in the solidifying mass, and to the formation of dangerous flaws. Reheating has to be carried out most carefully, especially with the higher carbon steels. Thus a 50-ton ingot will require to be soaked for two or three days before removal to the press. The porter bar, which holds the ingot while it is in the press, is a heavy bar with a collar that is fastened to one end of the ingot before it is put into the reheating furnace. The collar is outside the furnace, and the space round the ingot is filled in to prevent the admission of air. Siemens reversing gas furnaces are used for reheating large ingots. At the back of the collar is a wheel round which an endless chain passes to a pulley above, which is suspended from a travelling crane. The pulley is arranged so that it can be rotated, together with the porter bar and the ingot. This is used to move the ingot round when it is in the press. Both solid and hollow forgings are made in these presses. The general details of the plant are well brought out by the photograph of a 3,000-ton press shown in Fig. 56, which has been kindly supplied by Messrs. Firth.

The general arrangement of a rolling mill is shown in Fig. 57.

When two pieces of iron or steel are welded together the success of the operation depends upon the plasticity of the metal at a *welding heat*. In this condition pressure exerted either by hammering or squeezing causes the particles on the surfaces in contact to interpenetrate, and a sound joint is the result. The surfaces must be clean, and to ensure this silica sand is sprinkled on the hot iron, while borax is used for steel. In this way the oxide formed during the heating is converted into a fluid slag which is squeezed from between the surfaces and a clean contact obtained. It is a fact difficult to explain that ingot metal will not weld properly, and so is rarely welded.

CHAPTER X.

PHYSICAL AND MECHANICAL PROPERTIES OF IRON AND STEEL.

IRON in its various forms is used for so many and such diverse purposes, that careful testing by various methods is necessary to determine the suitability or otherwise of a particular variety of the metal for a given purpose, and in constructive work particularly to determine the limit of safety. Iron, in common with other metals, possesses a number of physical and mechanical properties, some of which are peculiar to metallic bodies, and its usefulness for a given purpose is often determined by the possession of one or more of the properties in a high degree. The most important of these properties are tenacity, elasticity, ductility, malleability, toughness and hardness.

Tenacity is the property by which the particles of the metal cling together so as to resist separation by forces acting in opposite directions along their common axes. This tenacity, tensile strength, or ultimate strength is measured by the magnitude of the forces acting through a cross section of unit area. The sum of these forces makes up the *breaking stress*, which is expressed in this country in either tons or pounds to the square inch of cross section, and on the continent in kilograms per square centimetre. The forces making up this breaking stress are represented by a dead weight, and are, therefore, *static* in character. They are uniformly distributed over the cross section, and act at right angles to it, so that whatever may be the area of the cross section the magnitude of the forces will be proportional to it. The method of testing is to strain a bar

or wire of known length and cross section, by gradually increasing stresses in the direction of its length until it breaks. Thus the magnitude of the forces distributed over $\frac{1}{4}$ square inch would be one quarter of that for 1 square inch, or one quarter the stress would be required to break the $\frac{1}{4}$ inch section as would be required for the 1 inch section. That is, whatever may be the cross section of the test bar if the breaking stress is known, it can be calculated to that required for a bar of unit cross section. The bars may be of any shape as long as the section is uniform, but round, square, and rectangular bars are commonly used, as it is easy to compute their cross section.

The simple rules for determining cross section of bars may be stated as follows:—

For a square bar of side "a" the cross section	= a × a
For a rectangular bar of sides "a" and "b" the cross section	= a × b
For a circular bar of diameter "d" the cross section	= d × d × 0.7854.

Elasticity.—This important property governs the recovery of form after the removal of a stress insufficient to produce rupture. All bodies are more or less distorted when a stress is applied to them, and the greater the stress the greater the distortion. Also, all bodies recover their form more or less after the stress is removed. A perfectly elastic body would recover itself immediately and completely; but solid bodies are not by any means perfect in this respect, and the stress causes a kind of *fatigue* in that the last portions of the strain die out slowly, and the body only recovers itself completely after some time. If, however, the stress exceeds a certain limit for a given body the body is unable to recover itself even in time, and is permanently deformed. This gives rise to the terms *elastic limit* and *permanent set*. The determination of the elastic limit is most important, as the limit of safety lies

well within it. In practice the elastic limit never falls below 50 per cent. of the tensile strength, and as it is difficult to determine the former during rapid commercial testing, the tensile strength is relied upon to furnish sufficient information for the purpose. But the yield point, which is in the neighbourhood of the elastic limit, can be determined on commercial machines, and furnishes a very desirable check.

Within the limit of elasticity the increase or decrease in the length of a uniform bar is proportional to the applied stress, and it is easy to imagine the bar increased to twice its length or decreased to zero without the limit being passed. The calculated stress that would be required to effect this lengthening or shortening is called the *modulus of elasticity* or Young's Modulus. If E denote the modulus, S the stress on unit area, and R the extension or compression,

$$\text{Then } E = \frac{S}{R} = \text{modulus of elasticity.}$$

In the case of hardened steel the extension to the limit is small and the load great. Thus the load on a bar of 1 inch cross section is 62 tons, and the extension per linear inch is 0.00418 inch.

$$\therefore E = \frac{62}{0.00418} = 14,832 \text{ tons.}$$

The idea is practically impossible, but it is sometimes very useful from a theoretical point of view.

Ductility is the property of the metal that allows its particles to flow under lateral pressure. In wire drawing this pressure is exerted by the sides of the hole in the die through which the metal is drawn by a tensile stress applied at one end. Now, when the stress is applied at both ends, and there is no lateral pressure, the bar thins down in the middle and towards the two ends. This causes

it to increase in length and decrease in cross section. An actual, though small lengthening takes place within the elastic limit, and constitutes the temporary deformation from which the bar recovers on removal of the stress. But when the limit is passed the elongation is permanent and goes on increasing until the bar breaks. Thus, if the length of the bar being tested is measured before and after rupture, the amount of elongation is known and can be calculated as a percentage of the length under stress. This

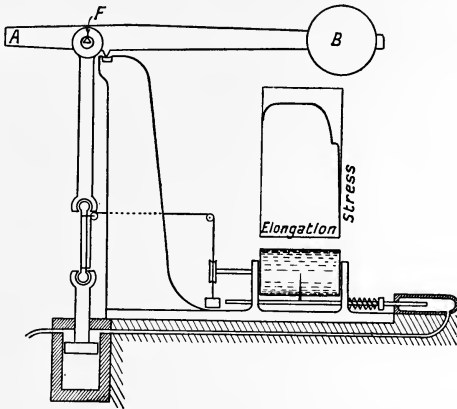

FIG. 58.—Diagram of Tensile Testing Machine.

gives the *elongation per cent.* Similarly the area of the fractured surface can be measured and the *reduction of area per cent.* obtained. Some authorities consider the elongation the more important, but the reduction of area is a good measure of tensile ductility or toughness. After the elastic limit is passed the bar elongates appreciably without further increase in the stress. This is known as the *yield point*. After this is passed if the stress is increased slightly the bar thins down and breaks. The actual breaking stress is less than the ultimate strength of the bar because it

has thinned down, and fractures across a smaller cross-section.

The Tensile Testing Machine.—The various measurements mentioned above are made during a single test with a properly equipped machine. There are various machines in practical use, and in the larger ones the stress is applied at one end of the bar by a hydraulic ram, and balanced at

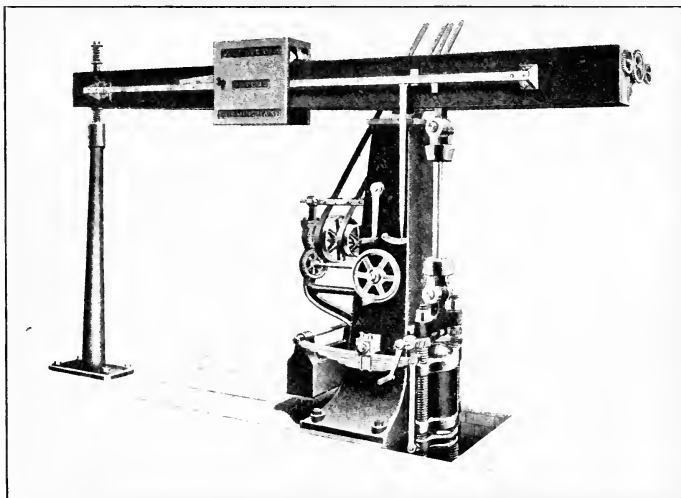

FIG. 59.— Tensile Testing Machine in Position.

the other by a weighted lever which, acting like a scale beam, measures the stress in dead weight.

The general principles of Wicksteed's machine, which is largely used in this country, are shown in Fig. 58. A long lever bar, AB, is supported on a fulcrum at F, on which it can move freely. The ratio of the two arms A F, B F is 1 to 50, so that a dead weight of 1 ton at B would balance a stress of 50 tons at A. Directly under A is a hydraulic

cylinder, to the ram of which a grip is attached. A second grip is suspended from A, and a bar placed in them and pulled tight is in a vertical position. Fastened on to the bar near the grips are two clips, the upper one of which carries a small pulley. An inextensible thread passes from the bottom clip over the pulley to a second pulley, and then down to and several times round a pulley attached to the drum. The free end is attached to a weight which, hanging down, keeps the whole of the thread tight. A small hydraulic cylinder directly connected with the main cylinder, and therefore sharing its pressure, is arranged so that its ram moves out in a horizontal direction carrying with it a pointer that presses lightly against the surface of the drum. The pointer is kept in position by a spring, and can only move in a horizontal direction. The surface of the drum is covered by a sheet of squared paper. The bar to be tested is measured and fixed on the grips of the machine so that the parallel marks on the ends of the bar, between which the length to be stressed is measured, just show outside the faces of the grips. The clips and thread are then arranged, and the pressure applied by forcing water into the cylinder, either by a pump or an accumulator. As the bar stretches the thread moves over the pulley and causes the drum to rotate, while the increased pressure in the small cylinder drives the pointer over the surface in a horizontal direction. These two motions are combined, and the pointer traces a curve on the squared paper. Thus the exact nature of the elongation is known. As long as the strain is within the elastic limit the stress is proportional to it. After the limit is passed the strain, elongation increases more rapidly, and this goes on until the bar breaks. While the stress and strain are proportional the pointer traces a straight line, but when the proportionality ceases the straight line becomes a curve, and it is evident that the stress at this point is the measure

of the elastic limit, but it is difficult to tell exactly where the straight line passes into the curve. The yield point, however, is clearly shown. After the bar is broken the increase in length and the reduction in area are measured. It is thus possible to obtain the four quantities, tensile strength, elastic limit, elongation, and reduction of area; and these are usually determined. A rough indication of

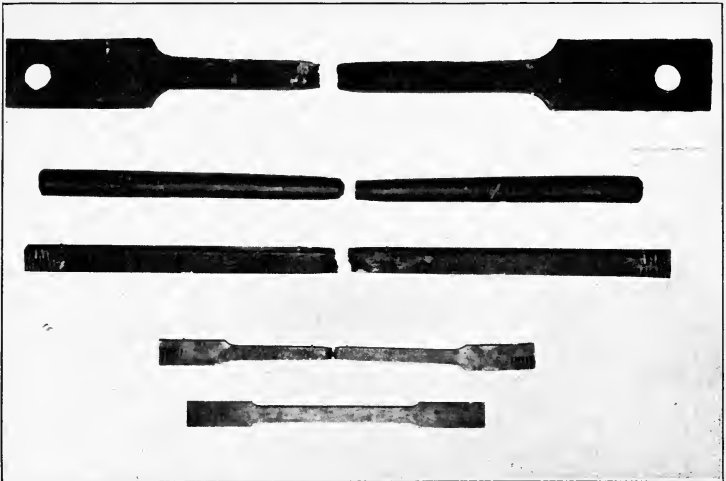

FIG. 60.

the nature of a stress-strain diagram is shown above the drum in Fig. 58. Fig. 59 is an illustration of a modern tensile testing machine. Its capacity is from 50 to 100 tons. The sliding weight is propelled along the beam by means of a screw worked by power, and for the fine adjustment by a hand wheel fixed to the column. The graduated scale on the beam is fitted with a vernier by which sub-divisions of 1-100th of a ton can be read. The hydraulic cylinder by which the stress is applied is seen on the right of the

column. There is a 300-ton Wicksteed machine at the National Testing Laboratory, Paris. A similar machine is also in course of construction by Messrs. Avery for the Birmingham University. These powerful machines can be used for a variety of tensile, transverse, bending and torsional tests of constructive iron and steel.

Fig. 60 is a photograph of a number of test pieces that have been broken in a tensile machine. The bottom pair were exact duplicates before the upper one was tested. They show clearly the effects of the stress on the length and cross-section of the piece.

Resistance to Torsion is an important property, and is readily determined. One end of the test bar is rigidly fixed in the machine, and the other end is made fast to the centre of a wheel, with its axis at right angles to the plane of the wheel. When the wheel is turned the bar is twisted, and the resistance to this twist is proportional to the force required to produce it. The test is not usually carried beyond the limit of elasticity, and readily indicates any lamination which may exist in the material being tested.

Resistance to Crushing.—A crushing force acts in just the opposite direction to a tensile force, and the test is usually made upon the metal used for columns which have to carry a dead weight on their upper ends. Both cast iron and structural steel are tested in this way. The test is carried out with a tensile testing machine, but the test piece, C, a short cylinder, is put between the moving parts, A_1 , A_2 , of a pair of shackles, which are so arranged in the grips of the machine that when the pressure is put on the moving pieces are drawn closer together, and

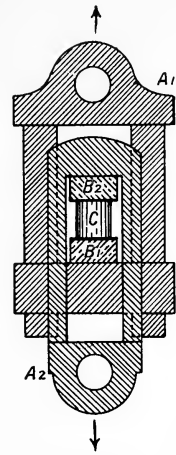

FIG. 61.—
Shackles.

crush the test piece between the hard steel blocks, B_1 , B_2 . The test cylinders are usually small, about $\frac{1}{2}$ inch in diameter, and the length is from one to three times the diameter. Steel test pieces usually bulge, and the resistance to crushing is judged by the deformation; but cast iron usually fractures, and the mode of fracture is generally a shear at an angle of 56° with the vertical axis of the cylinder. The form of the shackles is shown in Fig. 61.

Transverse Strength.—Tests for determining the resistance to transverse stress are commonly used for cast iron, and are carried out with a transverse testing machine. The test

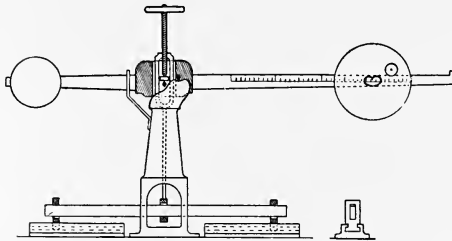

FIG. 62.—Diagram of Transverse Testing Machine.

bar is held by two dogs or eye-pieces so fitted to the base of the machine that they can be adjusted one on each side of the centre pillar, and at a regulated distance apart. A screw passing through the top of

the pillar can be forced downwards by a hand wheel connected directly with the top of the screw. This presses a steel knife edge on the short arm of a lever bar, the fulcrum of which is inside the pillar. The pressure is balanced by a sliding weight on the long arm of the lever. As the screw is revolved it raises a connecting rod, to the end of which a stirrup is suspended through which the test bar passes. The dogs are fixed at a regulated distance apart, and the stirrup is exactly midway between them, so that as the connecting rod moves upwards the test bar is pulled up against the dogs, and a steady upward pressure is exerted upon it at its centre. This pressure is balanced and measured by

the sliding weight, and when it just exceeds the transverse strength of the test bar, the bar breaks. The exact dead weight stress is measured by the position of the sliding weight on the lever arm. The ordinary test bars are 3 feet 6 inches long, 2 inches wide, and 1 inch thick. They are placed in the machine with the supports 3 feet apart and

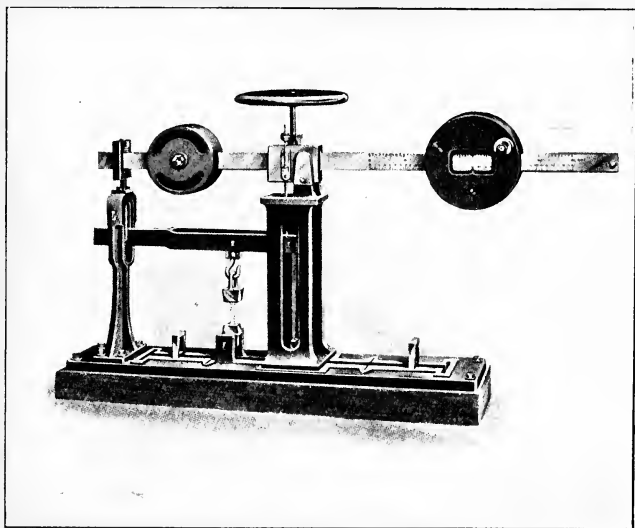

FIG. 63.—Transverse Testing Machine.

with their broad sides vertical. The transverse strength of cast iron bars of this section varies from 25 to 40 cwts. according to the quality of the metal. But test bars of various dimensions are used according to the power of the machine. The pressure is always applied by the hand wheel. Fig. 62 shows the general principle of the machine, and Fig. 63 is an illustration of Avery's combined tensile and transverse testing machine, which has been found very useful

for foundry purposes. It will exert a transverse stress up to 36 cwts., and a tensile stress of fourteen tons per square inch on a round bar $\frac{1}{2}$ inch in diameter, and of fifty tons per square inch on a bar $\frac{1}{4}$ inch in diameter.

Dynamic Testing.—Much useful information about the

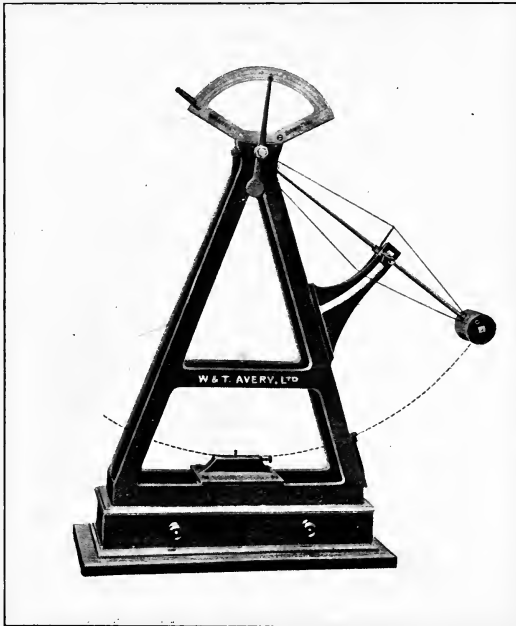

FIG. 64.—Pendulum Drop Test Machine.

strength of materials is obtained by the static tests described above; but it is also necessary that dynamic tests should be applied in cases where the material is to be used for the construction of moving parts continually exposed to dynamic stresses, or for fixed parts exposed to a series of shocks. A railway axle and rail are typical examples.

The Drop Test.—This well-known test is used for axles, rails, and tyres. The machine for carrying it out consists of two standards between which a heavy mass of iron, the tup, or monkey, usually weighing one ton, can be raised to a given height, and then allowed to fall on to the test piece below. The rail or axle is placed on supports fixed at a regulated distance apart, and the tup raised to the proper position, where it is secured by a catch. On being released, it falls and delivers a blow to the test piece, the magnitude of which depends upon the height from which it falls. This is repeated several times according to the nature of the test. The bar is turned up after each blow, so that alternate blows are delivered on opposite sides of it. In a good test the rail or axle is bent by the first blow, straightened by the second, and so on; it should show no signs of fracture at the end of the operation. Thus an axle $4\frac{3}{4}$ inches in diameter should not fail under five blows from a tup weighing one ton, and falling through a distance of 20 feet. With bars of smaller diameter the height of the drop is decreased. Now one ton, in falling through a height of 20 feet, would develop during its fall $2,240 \times 20 = 44,800$ foot pounds of energy, which is the measure of the blow delivered to the test bar.

For tyre testing the tyre is placed in the running position under the weight, and distorted by repeated blows. Sometimes this test is made in a hydraulic press. For the above tests it is usual to select the test pieces haphazard from a number of the rails, axles, or tyres made from the same material. They are not put to work after the test.

Modifications of the drop test have also been described. In one of these used by Messrs. Seaton and Jude the test piece is a small notched bar, which is subjected to a number of blows from a falling weight until it is fractured across the notched portion. Either the number of blows or the quantity of energy absorbed in effecting the fracture may be taken as

the measure of resistance to fracture. This method is used in at least one large engineering works.

An important form of apparatus for dynamic testing is shown in Fig. 64. It may be described as the pendulum hammer test. The test piece is a small bar 2 inches long, $\frac{3}{8}$ inch wide, and $\frac{3}{16}$ inch thick. A notch 0.05 inch deep is cut across the broad side $\frac{7}{8}$ inch from one end, and leaving a thickness of 0.137 inch behind the notch. This test piece is fixed upright in the bottom plate of the machine, and the pendulum raised to a given height. It is then allowed to fall, when a projection on it strikes the test piece and fractures it at one blow. The pendulum swings past the vertical position, and the distance to which it rises on the other side is indicated by a pointer. The height to which it rises evidently depends upon the quantity of energy absorbed in breaking the test piece. Thus the more the kinetic energy of the falling weight is absorbed in the work of breaking the bar the smaller will be the height to which it will rise after doing this work. A measure of the dynamic energy required to break the bar is thus obtained and comparison between different test pieces made.

Alternating Stresses.—Simple bending backwards and forwards of the test piece by hand is a very old method of applying alternating stresses, and gives good results in experienced hands; but the personal equation comes in, and this is always more or less unsatisfactory. Prof. Arnold has, however, developed a method and constructed a machine for carrying out alternating tests that is sure to be largely used in the future. The test bar, which is $\frac{3}{8}$ inch square and several inches long, is fixed in a die in a vertical position, so that a length 4 inches is left free. The free end is then bent rapidly backwards and forwards by means of an eccentric geared to a vertical shaft. In this way a large number of pushes and pulls per minute can be given to the bar. Also the rate and magnitude of these alternating

stresses can be varied to suit the particular test. The average stress is a little above the elastic limit of the test bar, and so determines its fracture in a reasonable time. Prof. Arnold gives as an illustration the case of good boiler plate steel, which, when under these alternating stresses at the rate of 166 per minute, broke after 1,375 alternations. On increasing the rate to 266 per minute a similar bar of the same steel broke after 878 alternations. Thus the resistance diminishes as the rate increases, and this shows that care is required in the selection of materials for the construction of high speed engines. Captain Sankey gives an example of a test bar of chromium vanadium steel tested by Arnold that endured 1,206 alternations at the rate of 710 per minute. The motion of the free end of the bar on each side of the vertical line is $\frac{3}{4}$ inch. The test appears to be a most important one in the selection of material, and is sure to be developed to its full extent in the able hands of its inventor. Another method of applying these transverse stresses is by hanging a weight at the free end of a bar, and then causing the bar to rotate rapidly. The test bar, which has a shallow groove turned in it, is fixed in a chock that can be driven by a pulley, the number of revolutions of which is counted by a registering apparatus attached to it. The free end of the bar is fitted with a small pulley, over which a flexible cord passes. One end of this cord is fastened to the floor a little out of the vertical line passing through the pulley, and the other end is attached to a weight which thus hangs from the pulley, and exerts a steady pressure upon the bar to which the pulley is fastened. This pressure may be regarded as acting along a vertical diameter of a given cross-section of the bar, and as this diameter is reversed in every revolution of the bar, the pressure alternates in direction with respect to the moving bar. The stresses here are comparatively small and well within the elastic limit. This method has been developed by Mr. J. E. Stead.

CHAPTER XI.

IRON AND STEEL UNDER THE MICROSCOPE.

PURE iron, in common with other metals, has a crystalline structure, and this is shown very clearly when a small sample of the metal is properly prepared and examined under the microscope. Iron crystals of considerable size have been observed from time to time, but they are only formed under exceptional circumstances, and for general observation the microscope must be used. Crystalline bodies are very common among the solids of the mineral kingdom, and have taken on their crystalline character while passing from the liquid into the solid state. Such bodies may have been in solution in water, or other solvent, from which they have crystallised, the solvent remaining in the liquid state after the separation of the solid; or they may have been in solution in molten solid matter, and then crystallised out during the extremely slow cooling and solidification of the whole mass; or, if pure substances, they may have crystallised on solidification. An isolated crystal has a definite geometrical form which is easily recognised by the crystallographer; but when a molten mass crystallises on solidification the individual crystals interfere with each other, and it is often difficult to recognise the particular form of the crystals, although the crystalline character of the whole may be evident. When the crystals are microscopic they are usually spoken of as "crystal grains," and the fractured surface of a piece of metal made up of these minute crystals presents a finely granular appearance.

Some of the commercial irons show the crystalline structure very markedly, but this evident crystallisation is usually caused by the presence of other elements, and to the treatment the metal has undergone. The constituents of the different varieties of iron are often spoken of, and they have now to be considered; but it is well to remember in approaching this subject that pure iron has only one constituent, and to that the name "Ferrite" has been given. This constituent is crystalline when solid, so that if a mass of pure iron in the molten state is allowed to solidify, it crystallises as it becomes solid, and when the solidification is allowed to take place under given conditions the crystals are always the same. The size of the crystals will vary, but this is simply a matter of detail.

The preparation of perfectly pure iron is a most difficult, if not impossible, task; but a specimen of the metal with so little impurity in it that its presence cannot be detected under the microscope can be prepared, and it is upon the examination of such specimens that general statements are based. The limits of this book will not allow of a detailed account of this very interesting subject, but it is hoped that sufficient may be given to render it intelligible. The method is applicable to the examination of any specimen of iron, whatever the treatment it has undergone, provided it is large enough to handle for preparation.

Preparing the Specimen.—The piece to be examined should be of convenient size to hold in the fingers. If it is soft enough, it is filed flat and smoothed on the side to be examined. It is then rubbed on emery cloth carefully glued on a smooth plane surface of hard wood. A convenient number of these emery blocks is six, ranging from F to 0000, but they need not all be used for one specimen. The filed surface of the specimen is rubbed in one direction over the coarsest block until the surface looks uniform; it is then rubbed at right angles to the former direction on

the second block until it again looks uniform. This is repeated on the other blocks, starting at right angles to the last direction, until the finest has been used. A pocket lens is useful for examining the specimen during the rubbing down process. The surface has then to be polished and freed from microscopic scratches by rubbing it on a rouge pad, which consists of a piece of good chamois leather stretched on a flat surface. The rouge must be of the finest if a perfectly polished specimen is to be obtained. A well prepared surface has a smooth, bright, uniform appearance when looked at under the microscope. It is quite free from scratches, and generally shows no signs of structure, but sometimes the polishing may bring out certain structures which become evident under the microscope. This is so when the constituents differ in hardness. The softer portions of the surface are more rubbed away than the harder ones, and this is accentuated by the use of a yielding polishing surface.

For research work, in order that false impressions may be avoided, very great care must be taken in the preparation of the polished surface, and elaborate descriptions of this preparation are given in original papers and works on the subject. But for the recognition of well-known constituents by the expert in the works laboratory, such fine work is not necessary, and the preparation already described is ample. The labour, however, is much lightened by the use of polishing machines. In most of these the polishing disc is screwed on to a vertical spindle so that it can be rotated rapidly in a horizontal plane at, say, about 2,000 revolutions per minute. For polishing with rouge a piece of fine cloth is stretched over the disc, and held in position by a metal ring, which is forced over the circumference of the disc like the tyre of a wheel. The cloth is slightly wetted, the rouge applied, and the polishing effected by pressing the specimen on the revolving surface.

A tin disc, or "lap," revolving in a horizontal plane, and fed with a thin paste of emery and water, is very useful for grinding down hard specimens that cannot be filed flat. The usual preparation then follows.

Etching.—The next process is the etching of the surface with some corrosive liquid, and this requires some care and considerable experience to do satisfactorily; but the principle upon which it depends is very simple. Now, suppose the surface to be perfectly uniform, both chemically and physically, then, if it were immersed in any solvent liquid, the surface would be dissolved away equally all over; but if the surface is not uniform, either physically or chemically, and few surfaces are, then the solvent liquid will act more rapidly on some parts than on others, and the structure will be brought out. The chief thing in etching is to stop the action of the solvent liquid as soon as the structure is sufficiently developed, and this is largely a matter of experience.

The following are the common etching solutions:—

- (1) A 10 per cent. solution of iodine in alcohol.
- (2) A 5 per cent. solution of picric acid in alcohol.
- (3) A 2 per cent. solution of nitric acid in water.
- (4) A 1 per cent. solution of hydrochloric acid in alcohol.
- (5) A 2 per cent. solution of ammonium nitrate in water.
- (6) An infusion of liquorice root in water.

(1) and (2) are largely used for cast irons, and (3) for steels. A much stronger solution of nitric acid than (3) is sometimes used.

Before etching, the surface is examined to see that it is free from grease and finger marks. If the tincture of iodine is used, a drop is put on the surface to be etched and rubbed over it with the finger tip. This is repeated until

the structure is brought out. The surface is then washed with alcohol and dried.

When an acid is used, the metal is immersed in the solution contained in a porcelain or glass dish. As the action proceeds, the surface is watched through a pocket lens, and when it is judged to have gone far enough the piece is removed, well swilled with water, immersed in alcohol, and dried. The surface is passed lightly over the rouge pad, or a similar pad free from rouge, and is then ready for mounting. The simplest method of mounting is to put a metal ring over the specimen as it lies on the rouge pad, and to press upon its upper surface a cover glass, on which a piece of plasticene has been stuck. If the cover glass is pressed down until it is stopped by the ring, the metal adheres to the plasticene, and when the glass is lifted away comes away with it. The prepared surface is parallel with the surface of the glass, and the mounted specimen is ready to be placed on the stage of the microscope. The etching may have to be repeated one or more times to bring out the structure properly.

Liquorice root and ammonium nitrate solutions are usually put on to a piece of parchment stretched on a plate of glass. The polished specimen is then rubbed on the moistened parchment until the required effect is produced. Ammonium nitrate is the more effective of these two reagents.

A rapid method for works practice is described by Professor Arnold. The sample is filed or ground flat and rubbed down on the 0 and 00 emery blocks; it is then immersed in nitric acid solution of sp. gr. 1.2 for about a minute, or until a black film appears on the surface, and bubbles of gas are about to escape. The metal is then removed, swilled, dried, and mounted for the microscope. Any scratches left in from the rubbing down are largely removed by the acid, and the structure is well defined. It is suitable for the rapid examination of many steels.

Another way of bringing out the structure is known as "heat tinting." The polished specimen is put on a hot iron plate, watched till the colours appear, and then plunged into mercury. In this way the different constituents often take on different colours. Some of the reagents themselves often impart colour to one or more of the constituents in the structure of the etched surface.

The Microscope.—The specimen is now ready for examination under the microscope, and a short description of this instrument may be useful. It is well known that a piece of curved glass, or "lens," as it is called, will magnify a body which is looked at through it. The magnified appearance as seen by the eye is simply an enlarged image of the object formed by the lens. With an ordinary pocket lens the image is on the same side of the lens as the object, and is a virtual image, but this depends upon the position of the object with respect to the focus of the lens; if it is outside the focus a real image is formed in the space on the other side of the lens. In the compound microscope an arrangement of lenses which acts as nearly as possible like a perfect single lens, and known as the *objective*, is used to obtain a magnified real image of an object placed behind it, and just outside the focus. This image is then looked at by another combination of lenses, the *eye-piece*, which is so placed that the real image formed by the objective falls inside the focus of the eye-piece, and a magnified virtual image of the real image is seen on looking through the eye-piece. Thus, by this combination, two magnifications are effected, and a sharp image is obtained when the object, the objective, and the eyepiece are in their proper relative positions. The two lenses are at the opposite ends of a double tube, so that the distance between them can be readily regulated by drawing out or pushing in the tube carrying the eye-piece. The object is placed on a stage on which it can be moved into any required position, and

the tube carrying the object glass can also be moved to and from the object by means of a coarse and fine rack motion, the fine motion being used for the final adjustment. The microscope, therefore, consists of a stand to support the stage on which the object is placed, and the tube carrying the lenses, together with the necessary gear for getting the object into focus.

An object, to give a clear, well defined image, must be illuminated, and this presents more difficulty in the case of opaque objects than it does with transparent ones. All metal specimens are opaque, so that only the following mode of illumination need be considered.

The light must be reflected from the surface of the object through the objective, up the tube, and through the eye-piece to the eye. Now when the light is focussed on the object entirely from outside, the axis of the tube must be inclined to the surface of the object, so that the light striking the surface may be reflected up the tube. This is called oblique illumination, and although sometimes used, does not give much information. Vertical illumination is mostly used, and this is best effected by placing a right angled glass prism inside the tube, and just above the objective, so that it can be rotated opposite to a hole in the side of the tube. The light from a lamp is focussed through this hole by a condensing lens, and is reflected downwards by the oblique side of the prism. It thus falls on the surface of the specimen, which then reflects it back through the objective, behind the prism, and to the eye-piece; so that the image is formed by light coming vertically from the surface under examination, and no distortion is caused.

The object lenses are in a small case which can be screwed on and off the end of the microscope tube. The prism also is often fitted in a case which can be screwed into the tube before the objective is put in. There are usually several objectives of different focal lengths. The

most useful are the $\frac{1}{8}$ inch, $\frac{1}{4}$ inch, and the 1 inch. The shorter the focal length the greater the magnifying power of the objective; but the actual magnification depends also on the character and position of the eye-piece. The magnification is usually expressed in linear dimensions as so many diameters. The most useful magnifications are from 50 to 500. The limit is about 2,000 diameters.

By arranging a camera in the place of the eye-piece the image of the section under the microscope can be projected on to a photographic plate, and a photograph of it taken, developed, and printed in the usual manner. The figures which follow have been produced in this way.

The Constituents of Iron and Steel.

—As already stated, the commercial varieties of iron contain a number of other elements in various proportions, and the varying properties of different forms of the metal are due, not only to the presence and properties of these elements, but also to the way in which they are associated with the iron and with each other.

The association of some of the elements in a mass of iron is influenced very largely by the treatment the metal has undergone, especially in heating and cooling. The complete analysis of a sample can only tell the actual amounts of the various elements present, and nothing about their condition, except in case of carbon, when it occurs both as graphite and as combined carbon. Of course, assumptions can be made from the known properties of the elements present, but they are only assumptions after all. By the use of the microscope, some of these have been found to be correct, and others fallacious; whilst the general view of the constitution of iron and steel has been enormously



FIG. 65.—Ferrite
(Hiorns).

extended. Dr. Sorby, of Sheffield was the first worker in this field of research, and published some of the results of his labour as early as 1864. Since then many well-known men have taken up the work, and among them may be mentioned Howe (America); Martens (Germany); Osmond (France); and Stead (England).

Ferrite.—Now it might be supposed that the polished surface of a piece of pure iron would be perfectly uniform and continuous, and so it is chemically, consisting as it does



FIG. 66.—Cementite (Stead).

of a single element; but it is not so physically, for the surface cuts through crystals, the boundary planes of which must be regarded as marking out the surface in the form of a network of lines. The metal is more readily attacked by the etching liquid along these lines than in any other direction, accordingly it is more eaten away, with the result that when looked at under the microscope the lines are rendered visible. These lines on the etched surface are regarded as marking the boundary planes of crystals. Fig. 65 is the micrograph of a piece of pure iron prepared by the author.

Cementite.—This constituent is regarded as a definite compound of iron and carbon, to which has been assigned the formula Fe_3C , as it contains approximately 6.67 per cent. of carbon. It is very much harder than ferrite, more difficult to scratch, and is attracted by a magnet. Its name is derived from the fact that it is present in abundance

in cemented bars, and the late Sir F. Abel obtained it as a greyish-black spangly mass by treating carefully annealed steel with chromic acid solution, which dissolves out the ferrite without affecting the carbide to any great extent. With other acid solvents the carbide is more or less decomposed. Abel obtained as much as 92·8 per cent. of the combined carbon of annealed steel in this residue. The percentage of carbon was found to vary from 6·39 to 8·09 as compared with the calculated percentage of 6·67; but it is probable that the residues were contaminated with small quantities of water and graphite, which would account for the variations. When hardened steel was treated in the same way only 4·7 per cent. of the combined carbon was isolated as carbide. Abel's conclusions have been confirmed by other workers, and there is now no doubt of the existence of this constituent of iron and steel. The light portions in Fig. 66 are patches of cementite.

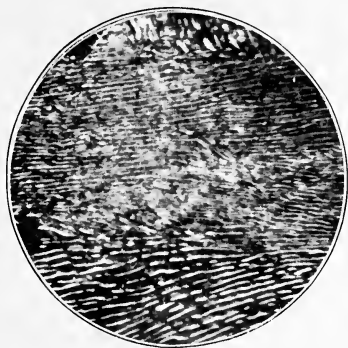

FIG. 67.—Pearlite (Stead).

Pearlite.—This is the most striking constituent of iron and steel, and was discovered by Sorby, who gave it the name of the pearly constituent from its appearance under the microscope. In its most easily recognised form it consists of alternate layers of cementite and ferrite, which are more or less curved, and the average thickness of a pair of these layers is, according to Stead, not more than 0·001 millimetre. This is known as lamellar pearlite, and is shown in Fig. 67. The black streaks are cementite, and the white ones ferrite. Sometimes it separates in granules, and is

then known as granular pearlite. The general appearance of lamellar pearlite is due to the different degrees of hardness of the constituent layers causing the arrangement of the layers, after polishing and etching, to resemble somewhat that of mother-of-pearl, and imparting to the surface the same play of colour, though in a less marked degree. It has been determined that pearlite contains approximately 0.9 per cent. of carbon; so that a steel of this composition, when properly annealed, should be practically all pearlite. In a steel containing less than 0.9 per cent. carbon the



FIG. 68.—Austenite and Martensite.

excess of ferrite separates or segregates from the pearlite; but in a steel containing more than this quantity cementite segregates. These constituents are easily recognised in sections containing them.

Martensite. — This constituent is just as well defined under the microscope as any of the others, but there is not such a

general concensus of opinion of its composition among the various authorities. The simple view is that it is unsegregated pearlite, that is, a combination of iron and carbon containing 0.9 per cent. of carbon which has crystallised without separating into carbide and ferrite. Most authorities follow Osmond in regarding it as a solid solution of carbon, or of the carbide, in iron which crystallises as such. Arnold, however, thinks that it is an iron sub-carbide $Fe_{24}C$. Martensite takes the form of interlacing needles, and is best produced for recognition in steel containing less than 0.8 per cent. carbon, when it is raised to a bright red heat, allowed to cool to a cherry-red, and

then suddenly quenched in a freezing mixture of ice and salt.

In the 0·9 per cent. carbon steel the martensite is known as *hardenite*. This name was proposed by Howe for the principal constituent of hardened steel. Osmond regards hardenite as martensite saturated with carbon.

In the higher carbon steels another constituent has been recognised, and is called *austenite*; it is softer than martensite, and can be scratched with a needle. It separates from martensite when a steel containing more than 1·1 per cent. of carbon is raised above 1,000°C. (a light yellow heat), and then quenched in ice-cold water. The structure is developed by polishing the prepared specimen on parchment, moistened with either ammonium nitrate solution or an infusion of liquorice. The austenite remains white while the associated martensite turns brown. Fig. 68 shows both austenite and martensite. Some authorities do not recognise the existence of austenite, and as it has only been observed in specimens submitted to abnormal treatment, it is not of much importance to the practical man. On the other hand, martensite exists in all steels at a temperature above that at which they are hardened when quenched.

If steel is allowed to cool slowly, the martensite undergoes transition into pearlite, and if during this transition the metal is quenched by plunging it into molten lead, its microstructure indicates that the transition has been arrested, and a permanent structure produced. The most familiar of these transition forms is called *sorbite*, after Dr. Sorby, and its permanent formation in medium carbon steel has been put to practical use, as will be indicated later. Another, but much more difficult transitional form to obtain, is known as *troostite*.

Graphite.—As the content of carbon increases there is a tendency for some of that element to crystallise from the

cooling metal in the elementary form. The slower the cooling through a particular range of temperature, the greater the tendency of the carbon to crystallise as graphite. The metal in which graphite is best observed is grey pig iron; and it is considered that the presence of silicon in the commercial metal is largely responsible for the formation of graphite under the normal conditions of cooling of the pig metal in the beds. Mr. A. H. Hiorns has shown that graphite separates from iron containing



FIG. 69.—Graphite and Ferrite.

very little silicon by keeping it above $1,000^{\circ}\text{C}$. for several hours. Fig. 69 shows the graphite plates obtruding among the crystal grains of ferrite in the micro section of a grey pig iron.

Generally speaking, as the grade number of the pig iron increases, the size of the graphite plates decreases; in the mottled variety it is somewhat scanty, and the plates small. In white iron the graphite is practically absent. Graphite is not usually met with in steel; but the micrograph of a high carbon steel, kept for some time at a temperature

within the graphite forming range, shows evidence of its separation.

All the variations in structure which have been described so far, can be produced in alloys of iron with varying proportions of carbon by suitable heat treatment ; but the other elements, silicon, manganese, sulphur, and phosphorus, when they are present exert a considerable influence on the structure of the metal. This is most marked in the case of cast iron, for the quantities present in wrought iron and steel are usually small, except manganese, which is often present in ingot iron and steel, and acts as a corrective.

Silicon unites with iron to form silicides, of which there appear to be two, Fe_2Si in low silicon, and FeSi in high silicon metal. The presence of silicon can only be detected in ferro-silicon. In cast iron it probably remains in the solid solution or structureless matrix from which the graphite has been rejected.

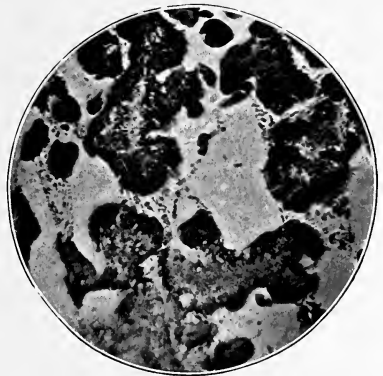

FIG. 70.—Cast Iron containing Sulphur.

According to Heyn, silicon lowers the range of temperature within which the graphite can separate, and thus facilitates its separation under normal conditions of cooling.

Manganese acts against the separation of graphite, and this is probably due to complex causes, for manganese combines with both carbon and silicon to form fairly stable compounds.

Sulphur unites with iron to form ferrous sulphide, FeS , but when manganese is present the sulphur appears to

combine with it, and the influence of the separate elements is largely counteracted. Sulphide of manganese crystals are sometimes plainly discernible in the micro sections of cast irons. Manganese is usually regarded as an antidote for sulphur, and it is certain that the bad effects of the latter element on the working properties of the iron are not nearly so marked in the presence of manganese.

The general effect of sulphur on cast iron is to harden it and render it brittle. There should not be more than

0.2 per cent. present, and, if possible, the amount should be less than 0.1 per cent. Fig. 70 shows the microstructure of a white cast iron containing 0.2 per cent. of sulphur. The dark patches are pearlite, and the light ones cementite, in which the sulphide is imbedded.



FIG. 71.—Cast Iron with Phosphide Eutectic.

Phosphorus unites with iron to form a fairly stable phosphide of the metal having the composition Fe_3P . The general effect of phosphorus in wrought iron and steel is to render the metals "cold short." In cast iron the presence of the element lowers the melting point, and makes the metal more fluid when melted. It thus enables the molten metal to take the impression of the mould more readily, and produce finer castings. At the same time it reduces the strength of the castings, so that the percentage of phosphorus present must be carefully regulated according to the purpose for which they are to be used. The iron phosphide forms a eutectic which is

distributed in patches through the structure of the metal. Fig. 71 is the micro section of phosphoric pig iron, containing 1·5 per cent. of phosphorus, in which the phosphorus

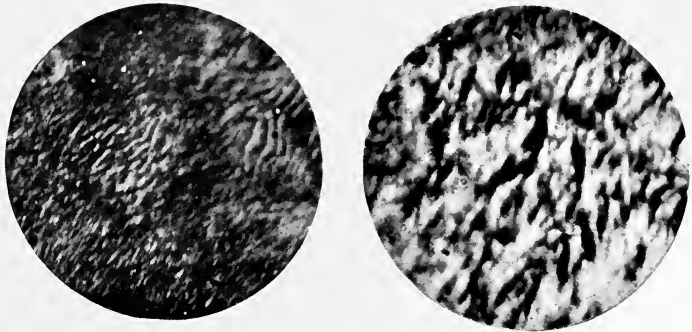

Annealed.

FIG. 72.

Hardened.

eutectic appears as small dark marks in the irregular patches of lighter cementite.

Copper and arsenic are found in some varieties of iron and steel, but their influence on the structure and properties of the metals is not very marked, on account of the smallness of the quantities usually present.

Fig. 72 shows clearly the great difference in the structure of the same steel (*a*) when carefully annealed, and (*b*) when quenched in cold water from about 800° C. The samples from which the specimens were cut contained 0·9 per cent. of carbon, and had been subjected to a very careful and prolonged annealing. The hardened specimen was heated in a muffle, and plunged into cold water.

CHAPTER XII.

HEAT TREATMENT OF IRON AND STEEL.

IN dealing with the complex changes that take place when pieces of iron and steel are subjected to the action of heat, it would be well to keep in mind the kind of material to be dealt with. The generalisation proposed by Professor Howe is the best for this purpose. He regards all the varieties of commercial iron as more or less impure steels, or alloys of iron and carbon. As already stated, the normal constituents of annealed steel are pearlite, ferrite, and cementite. Thus the softest and purest Swedish bar iron would consist almost entirely of ferrite with a little pearlite. Then, as the percentage of carbon increased the ferrite would be more and more replaced by pearlite until with 0.9 per cent. of carbon the whole mass would consist of pearlite. With further increase of carbon the pearlite would be partially replaced by cementite, and this would continue until about 2 per cent. of carbon is reached, and the steel becomes white cast iron. This generalisation is borne out by the fact that the difference between steel and white cast iron is only one of degree. The mottled iron may be regarded as consisting of a matrix of steel with graphite scattered through it; and the grey iron as mild steel with graphite distributed in the same manner, with variations in structure produced by silicon, manganese, phosphorus, and sulphur considered as impurities.

The ultimate effect of heat upon iron is to convert it into vapour, but an exceedingly high temperature is necessary for the rapid vaporisation of the metal. The range of

temperatures usually considered lie between the temperature of the atmosphere, and the melting point of the metal, a range of about $1,600^{\circ}$ C. But Moissan has experimented with iron at the exceedingly high temperature of the electric arc, and Dewar at the exceedingly low temperature produced by liquid air.

The general method of finding the effect of heat on a solid is to melt it, and then note the changes which take place as the liquid cools, solidifies, and finally cools down to the original temperature of the solid. The usual way of doing this is to put a thermometer (or pyrometer for very high temperatures) into the liquid, and note the rate of fall in temperature. The cause of the fall in temperature is the escape of heat from the body into the surrounding space, and if no internal change other than the escape of heat takes place this will follow a regular law. The simple way of recording the outward flow of heat is to note the temperatures at equal

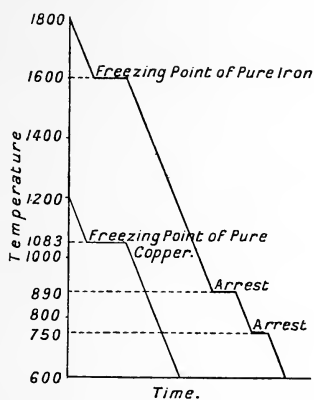

FIG. 73.

intervals of time, and record them on a curve diagram. Take the case of pure molten copper: the fall in temperature is represented by a regular curve until the metal begins to solidify, when the fall is arrested, but as the time still goes on this portion of the curve becomes a horizontal line. The reason for this is well known, for when a solid liquefies heat disappears as such in effecting the physical change from solid to liquid. When the liquid solidifies again the heat of liquefaction appears at the same rate as heat is radiated from the cooling body, so that the internal

temperature does not fall as long as any of the body remains liquid. When the copper has solidified the fall in temperature is again represented by a regular downward curve. See Fig. 73.

In the case of pure iron the same is exactly true down to the freezing point, but the downward curve is not regular, for an arrest takes place at 890° C., and still another at 750° C., when the curve becomes slightly horizontal. These points are denoted by the symbols Ar_3 and Ar_2 , and their existence shows clearly that an internal change of some kind takes place by which sufficient heat is developed to counterbalance that given out by the cooling metal. When the Ar_2 point is passed the cooling curve becomes regular again, and keeps so down to the temperature of the atmosphere. An explanation of this difference between iron and copper was naturally sought for. Now, if iron be regarded as an element with its atoms all alike, these evolutions of heat must be accompanied by some rearrangement of the atoms in the molecules themselves, by which the quantity of energy associated with them is diminished to the exact amount of the heat liberated.

Allotropy.—There are several elements that can exist in different forms at the same temperature, and it is well known that different quantities of energy are associated with them. These are called allotropic modifications of the elements. Carbon is the well-known example in its three forms, the Diamond, Graphite, and Charcoal. A given weight of each of these bodies when completely burnt furnishes exactly the same weight of carbon dioxide; but the quantity of heat developed is not the same. This shows conclusively that the three bodies are one and the same chemical element, but that the internal arrangement of the atoms and molecules and energy associated with them are not the same, and it is to this that the marked variations in properties are due. These forms of carbon exist through

a wide range of temperature, and are therefore popularly regarded as stable bodies. But even the diamond is changed into a mass of black charcoal when rapidly heated to the temperature of the electric arc.

Sulphur furnishes another example. This element can exist in three distinct allotropic states; but the temperature range is much smaller than in the case of carbon. There are two well-known crystalline forms, one of which, the monoclinic, is stable above 96° C., and the other, the rhombohedral, below that temperature. The latter is the stable form at ordinary temperatures, and well defined crystals can be obtained from a solution of sulphur in carbon bisulphide; but when the solid is melted (114.5° C.) and then slowly cooled monoclinic crystals are formed. Also when the liquid is heated above 250° C. and then suddenly cooled by being poured into cold water, a plastic form of the element is obtained. Both these pass back to the stable form with evolution of heat, if left to themselves at the temperature of the air, for they are below their *transition point*, as the lowest temperature at which they are stable is called. But there is a considerable amount of reluctance or lag about this change, which is due to some kind of molecular inertia. The form tends to persist below its transition point, and is then said to be in the metastable condition. Tin furnishes a good example of this. The transition point of ordinary tin is 20° C., so that it is in the metastable condition except in very hot weather; but its passage to the stable form, a grey powder, is excessively slow under normal conditions, although when subjected to great cold it may be effected in a few months. Thus blocks of tin have been known to crumble to powder when exposed to the rigour of a severe Russian winter.

With these well-known cases in view it is not at all difficult to accept the conclusion of Osmond, that iron can exist in different allotropic states within certain ranges of

temperature; and just as we speak of diamond-carbon, graphitic-carbon, and amorphous-carbon he speaks of alpha-iron, beta-iron, and gamma-iron, using the names of the first letters of the Greek alphabet α , β , γ , to distinguish the different forms. Now α -iron is the normal form, and exists below 750°C .; β -iron exists in the range between 750°C . and 890°C .; and γ -iron above 890°C . These different forms of the metal have different physical and mechanical properties. Thus alpha-iron is soft and magnetic; beta-iron is hard and non-magnetic; gamma-iron is non-magnetic and soft. Now it may be remarked that although this allotropic theory for iron is not universally accepted, general opinion is strong in its favour, and it certainly gives a simple explanation of observed facts.

But when carbon is associated with the iron these changes are considerably modified, and with about 0.6 per cent. present the points Ar_3 and Ar_2 are both lowered, and appear to run together at 720°C . with a marked evolution of heat. Then, when the temperature reaches 660°C . a very marked evolution of heat takes place, and the cooling metal glows again with the added heat. This change has long been known by the name of *recalcescence*, although its cause was not properly understood.

Eutectics.—Now in order to understand this important phenomenon it will be necessary to consider the cooling curve of an alloy such as plumber's solder, which consists of two parts of lead and one part of tin. At a temperature about the melting point of lead it is perfectly fluid, and if it is allowed to cool begins to solidify at about 240°C ., but the temperature continues to fall through a range of some 60°C . before complete solidification takes place. The freezing mass thus assumes a pasty condition, which enables a skilful workman to work it round the junction of two pieces of lead pipe in the process of "wiping" a joint. A simple explanation of this may be given. When solidification

first sets in it is pure lead that crystallises, and this crystallisation proceeds until an alloy of approximately two parts tin and one part lead is left in the liquid state. This then solidifies at 180° C., and the whole mass becomes solid. The pasty material with which the plumber works, consists of small crystals of solid lead wetted by the molten alloy of lead and tin. The alloy containing two parts tin and one part lead has the lowest melting point of any alloy of the two metals. It is called the *eutectic alloy*. The freezing curve of a series of lead-tin alloys is given in Fig. 74.

The characteristics of a chemical compound are its absolute constancy of composition with regard to both the nature and proportions

of the elements it contains, and the complete merging of the properties of these elements into those of the compound. When a body of any kind is dissolved in a liquid, the solute, as the dissolved body is

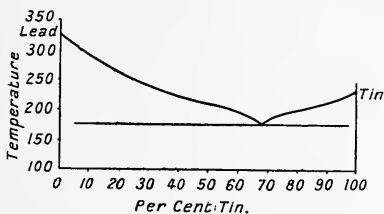

FIG. 74.

called, is uniformly distributed through the solvent, and the solution becomes perfectly homogeneous; it is said to be a body of uniform concentration. A solution, however, differs from a chemical compound in that the proportions of the solute and the solvent may vary between wide limits—that is, from a very small proportion of the solute up to the saturation point. But the saturation proportion depends very largely on the temperature of the solution, and in most cases is lowered by a reduction in its temperature. Liquids tend to freeze when they are cooled, and the general result of dissolving a solid in a liquid is to lower its freezing point; but the extent of this lowering depends upon the nature of the liquid and the nature and proportion

of the dissolved solid. Take the simple case of common salt dissolved in water, and suppose that the solution contains one part of salt and nine parts of water. If such a solution is surrounded by a freezing mixture, and a thermometer is put into it, the effects of cooling may be watched. The temperature falls below the freezing point of water 0°C ., and the solution still keeps perfectly liquid until the thermometer reaches -8°C ., when solid commences to separate. If this is removed and examined it is found to be pure ice, so that the concentration of the salt in the solution is increased. This causes a further lowering of the freezing point, and the temperature again falls, with separation of more ice. The lowering of temperature and separation of ice goes on until the concentration reaches 23.5 per cent. of salt and 76.5 per cent. of water, and the temperature falls to -22°C . The solution then solidifies completely. If on the other hand the solution contains more than 23.5 per cent. of salt, then no solidification takes place until -12°C . is reached, when salt commences to crystallise out, and separation of salt with lowering of the freezing point goes on until -22°C . is again reached, when the remaining solution contains 23.5 per cent. of salt, and solidifies completely as before. Thus there is one particular concentration from which it is impossible to separate either the solute or the solvent by merely cooling the solution, for if it is cooled sufficiently it solidifies as a whole. This is the well-known *eutectic solution*, which has always, for the same solute and solvent, a constant composition; but it is not a chemical compound. Guthrie, its discoverer, called it a cryohydrate; but it is not a hydrate, for when the solid eutectic is examined under the microscope it is found to consist of a mixture of ice crystals and salt crystals. The solute and the solvent appear to mutually reject each other at the moment of solidification; and this is the probable constitution of all eutectic mixtures. Now, if a

solution containing an excess of either the solvent or the solute over the eutectic proportions is cooled until it solidifies, without removing the excess as it crystallises out, the solid will consist of crystals of the excess constituent imbedded in the matrix of the eutectic, and this will appear when the structure is examined. The freezing curve of a salt solution is shown in Fig. 75.

Solid Solutions.—Suppose a solution to become solid without any separation whatever of its constituents taking place, it would then retain its uniform concentration and homogeneousness, and be in every particular the same as a liquid solution, but in the solid state. Then suppose that a lowering of the temperature of this solid solution caused a separation of one or other of the constituents, this separation would go on until the eutectic proportions were reached, and then further cooling would not effect any further separation of either constituent alone, and the solid mass would have the same general structure as

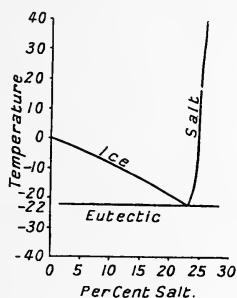

FIG. 75.

a solidified solution containing an excess of either constituent over the eutectic proportions. This is the modern idea of a solid solution, as distinguished from a solidified solution which need not be homogeneous when just solidified, and in which change of temperature within ordinary limits does not cause further separation of the constituents.

Solution of Carbon in Iron.—Molten iron will dissolve carbon in much the same way that water dissolves salt, and as much as 7 per cent. of the element will pass into solution under proper conditions. The melting point of pure iron is about $1,600^{\circ}$ C., and the presence of carbon lowers it in just the same way that salt lowers the freezing

point of water. A molten mass of iron containing upwards of 5 per cent. of carbon deposits graphitic carbon as it cools, so that when the temperature falls to $1,130^{\circ}$ C. the solution contains 4.3 per cent. of carbon. As this is the composition of the iron-carbon alloy of lowest melting point the whole mass becomes solid. The eutectic is said to contain 2.3 per cent. of graphite, and the other constituent is the solid solution of carbon in γ -iron, to which the name austenite has been given. In its saturated form it contains about 2 per cent. of carbon. When the molten alloy contains less than 4.3 per cent. of carbon it deposits austenite as it cools, instead of graphite. The eutectic has not been traced in steels containing less than 1.2 per cent. of carbon, so that at $1,130^{\circ}$ C. iron can hold 1.2 per cent. of that element in solid solution. It must be borne in mind that austenite is similar to other solutions in that its concentration may vary. Thus its carbon may vary from 0 to 2 per cent., and this will cause variation in its properties. The cooling curve is shown in the upper range (1600° C. to 1130° C.) of Fig. 77. The carbon in the molten alloy is regarded by some authorities as being in the elemental form, but Professor Sauveur is of opinion that it is present as carbide of iron. Mr. Stead also favours this view, and brings forward the effect of chill casting on molten pig iron in support of it. It is said, however, that the carbide Fe_3C is dissociated above $1,050^{\circ}$ C., and only forms below that temperature. Also, that at $1,000^{\circ}$ C., iron can hold more than 1.2 per cent. of carbon in solid solution, due to its being in the form of carbide. But whichever view is taken, the fact remains that a number of important changes take place in the cooling solid, and much experimental work has been done in investigating them. It is almost invidious to select from the many distinguished men who have taken up this work, but the names of the late Sir W. Roberts-Austen,

Osmond, and Le Chatelier must always occupy a foremost place.

The allotropic modifications of iron are supposed to play an important part in the constitution of steel. Thus β -iron is capable of forming a solid solution with carbon, but α -iron does not dissolve that element. Now the β to α range is 890° C. to 750° C. in pure iron, but the presence of carbon retards the passage from the β to the α form. Speaking generally, there is always a certain amount of lag during the passage of an element from a higher to a lower, or more stable, allotropic form. This lag, which is caused by a kind of sluggishness or disinclination on the part of the element to alter its form, is accentuated in the case of iron by the presence of carbon. When pure iron is heated up, the points Ac_2 and Ac_3 corresponding to Ar_2 and Ar_3 on the cooling curve occur at rather higher temperatures, and the lag in the case of the pure element thus rendered evident.

In much the same way a solution may become supersaturated when carefully cooled below its point of saturation, without any separation of solid. Similarly a liquid may be supercooled, that is, cooled below its freezing point, without freezing. A body in this supersaturated or supercooled condition is in unstable equilibrium, and when solidification does take place there is a rise in temperature due to the evolution of heat that marks the passage of the liquid to the solid state. Water, for example, may be cooled several degrees below its freezing point without solidifying, but if the smallest crystal of ice is dropped into the supercooled liquid solidification at once sets in, and the temperature rises rapidly to the normal freezing point of the liquid. Similarly crystals of thiosulphate of soda may be melted and cooled to the temperature of the atmosphere without solidification, but the smallest crystal of the salt will induce crystallisation together with a rapid rise in

temperature and considerable evolution of heat. Similar phenomena no doubt play an important part in the cooling of steel and cast iron.

The Phase Rule.—Any body, a mass of iron for instance, may be regarded as an independent system made up of matter and energy, and such a system is said to be in stable equilibrium when there is no inherent tendency to change as long as the outside conditions remain the same. Such a system may consist of one or more components. These components may be either elements or compounds which are not decomposed under the existing conditions. These components may pass from solid to liquid or liquid to gas, and *vice versâ*; they may be grouped together in various ways; they may even combine together to form definite compounds and be decomposed again. Every homogeneous entity in the system, whether it consists of one or more of the components, is called a phase, which may be either solid, liquid, or gaseous. That is, a phase does not necessarily indicate the particular physical state in which the components of the system exist. It may be anything in the form of matter provided it is homogeneous. Thus water is a system of one component which may exist in three phases, solid, liquid and gaseous. On the other hand, a solution of salt in water is a system of two components with one phase, that is a homogeneous liquid solution. A system has certain properties that may vary, and these are known as the variables of the system. Thus in a simple gas system there are three variables—volume, pressure, and temperature—and two of these must be known before the state of the system can be strictly defined. In the case of a solid system pressure may be neglected, which simplifies the matter somewhat. Thus volume or concentration and temperature only need be considered.

Systems are said to have one or more degrees of freedom

when they can survive a change in one or more of these variables; but no degree of freedom when they cannot survive even the slightest change in the variables. Thus there is only one temperature and pressure at which the one component system water can exist in the three phases, ice, water, and vapour. With the slightest alteration of either temperature or pressure one of these phases must eventually disappear. This is summed up generally in the *Phase Rule* formulated by Gibbs, and expressed by the equation :

$$F = C + 2 - P.$$

F denotes the number of degrees of freedom; C the number of components; P the number of phases.

Thus, when the system water is in three phases, ice, water, vapour, the equation becomes :

$$F = 1 + 2 - 3 = 0,$$

or there are no degrees of freedom; but when it exists in the two phases, liquid and vapour, then :

$$F = 1 + 2 - 2 = 1,$$

and the system has one degree of freedom, or is monovariant.

It is to be remembered that the phase rule does not deal with the quantities of the phases, but only with their existence. There may be much or little of a particular phase.

Now, when concentration and temperature only are considered, the equation becomes :

$$F = C + 1 - P.$$

Thus the molten lead-tin alloy already mentioned is a system of two components and one phase, therefore it has two degrees of freedom, or is di-variant; but when one of

the metals commences to freeze out there are two phases, and when the eutectic begins to solidify the other metal is added as a third phase. The system thus becomes mono-variant, and finally in-variant. The eutectic is not a phase, for it is not homogeneous, consisting as it does of a mixture of the two constituents of the system.

Then consider the case of molten iron-carbon alloy ; it is a di-variant system of two components, iron and carbon, and one phase, the liquid solution. As it cools either the solid solution or graphite crystallises out, and the system becomes mono-variant. Then when the eutectic commences to solidify a third phase is added, and the system becomes in-variant. One or other of these phases must now disappear, and it is the liquid solution, for the mass solidifies ; it then consists of two phases, graphite and solid solution, when the carbon exceeds 2 per cent., and of one phase, the solid solution, when less than 2 per cent. of carbon is present.

The solid continues to cool, and at about $1,000^{\circ}$ C. cementite, Fe_3C , forms and separates from the solid solution. There are now three phases, ferrite, cementite, and graphite. Now, according to the phase rule, the system cannot survive a further change in temperature ; one or other of the phases must disappear. Prof. Roozeboom, who gathered together the results of Roberts-Austen and others, applied the phase rule to their elucidation, and assumed that as the temperature falls below $1,000^{\circ}$ C. ferrite and graphite unite to form cementite to bring the mass again into stable equilibrium. But there seems to be conclusive evidence that this change does not take place, and that graphite, once formed in the solid mass, becomes inactive. Prof. Sauveur argues that this is no deviation from the phase rule, but that the graphite, once separated, no longer belongs to the system. He refers to the Roberts-Austin-Roozeboom diagram as being

classical, and it is without doubt a very fine example of generalisation.¹

Fig. 76 is a diagram prepared for teaching purposes, in which the cooling curves of a series of carbon-steels obtained by Roberts-Austen are represented. The cooling curve of pure iron is given for reference. Temperatures are plotted on the vertical line, and time in seconds on the horizontal line. The first arrest point Ar_3 , which indicates the passage of γ -iron into the β form, occurs at 890°C . in

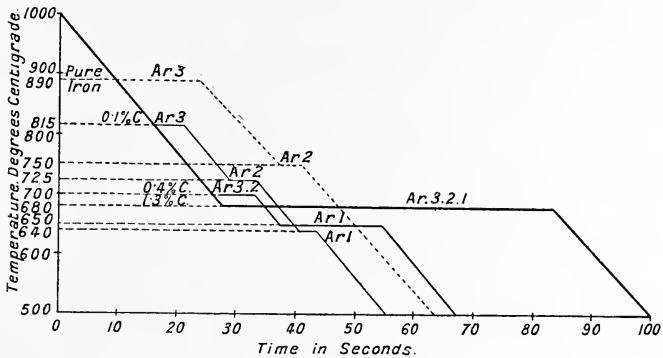

FIG. 76.

pure iron, and is lowered to 815°C . by the presence of 0.1 per cent. of carbon. The second arrest Ar_2 , which takes place at 750°C ., corresponds to the passage of β -iron into the α form, and is lowered to 725°C . by 0.1 per cent. of carbon. With 0.4 per cent. of carbon these two points are brought together at 700°C . The arrest Ar_1 , which is observed only in iron containing carbon, occurs at 640°C . with 0.1 per cent., and at 650°C . with 0.4 per cent. carbon. With 1.3 per cent. of carbon the three points coalesce at 680°C .

¹ *Journal of the Iron and Steel Institute*, No. IV., 1906.

The arrest Ar_1 , which is only observed in iron-carbon alloys, is due either to the formation of cementite or to its separation from the solid solution, the latter being probably the correct explanation. The heat developed by this separation is the cause of recalescence, and is augmented in the case of the 1.3 alloy by the heat due to other changes. It is to be born in mind that these changes are not by any means instantaneous, so that they really take place within definite ranges of temperature, but for simplicity these are represented by definite temperatures.

According to Sauveur, steel at $1,000^\circ\text{C}$. is a solid solution of carbide in γ -iron, known as austenite. Within the first critical range it is transformed into the solid solution of carbide in β -iron, martensite. Then in the second critical range the β -iron is transformed into α -iron, which cannot form a solid solution, and so the carbide separates and segregates with ferrite to form pearlite. The resemblance of this change to the solidification of a eutectic alloy caused the pearlite, which has a constant composition represented by $\text{Fe}_3\text{C} + 21\text{Fe}$, to be regarded as a eutectic, but objections were raised, and Howe's term "eutectoid" is now largely adopted. The composition given above contains 0.89 per cent. of carbon, and the terms hypoeutectoid and hyper-eutectoid have been applied to steels containing less than and more than 0.9 per cent. of carbon. The former steels, when in the soft state, consist of pearlite and ferrite, and the latter of pearlite and cementite. Martensite, when it has the same composition as pearlite, is better known as hardenite.

It is to be understood that the shortening of the range in the case of high carbon steels, within which the various changes take place, does not mean the suppression of any one of them, but only that they follow one another in the proper order within the contracted range. The change from austenite to martensite can be partially arrested by

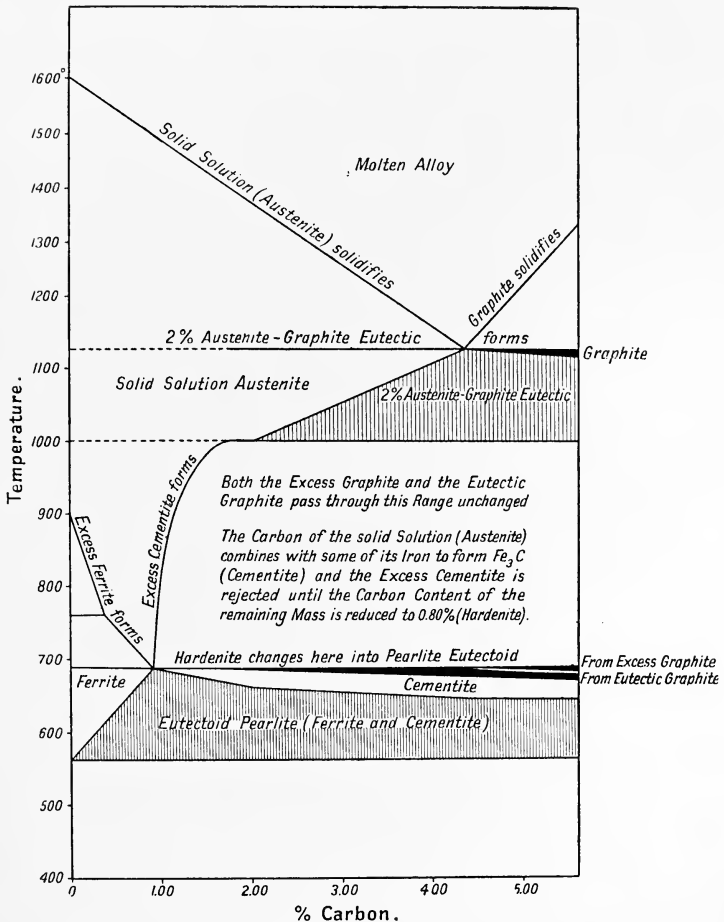

FIG. 77.—The Roberts-Austen-Roozeboom Curve (Sauveur).

quenching the steel from a high temperature in iced brine. It is a comparatively soft constituent of the steel in which it occurs, as it can be scratched with a needle. The change from austenite to martensite appears to be fairly rapid, as

a steel quenched when well within the contracted range is almost entirely martensitic in character. Some of the transition forms between martensite and pearlite are well known, such as troostite and sorbite. In them the segregation of the pearlite is arrested at different stages. The work of Mr. J. E. Stead on the production of sorbite in large masses of steel by proper heat treatment is well known, and is a good example of the practical application of the results of research work. Much labour has been bestowed upon the subjects briefly outlined above, and there is little doubt of their great practical value, although still open to controversy. The Roberts-Austen-Roozeboom curve, as modified by Sauveur, is given in Fig. 77. If a line is drawn through the diagram parallel to the temperature line the point where it cuts the base line determines the percentage of carbon in the alloy, and if this line is traced downwards towards the base line the changes in the constitution of the alloy as it passes through the various temperature ranges are indicated.

HARDENING AND TEMPERING.

When a piece of steel containing more than 0.2 per cent. of carbon is raised to a red heat and then suddenly cooled, it becomes hard and brittle, and the higher the percentage of carbon present the harder and more brittle does the metal become. Further, if this hardened and brittle metal is heated to a temperature between 200° and 300° C. the hardness is somewhat reduced, and the brittleness is very largely removed. These are the processes of hardening and tempering.

Quenching Liquids.—The hardness of a given sample of steel depends upon the suddenness with which it is cooled through the critical range. The rate of cooling depends upon the nature, and to some extent upon the bulk of the

quenching liquid. The difference in the action of different liquids is well shown by the following experiment: Three similar bars of the same steel are heated together to the same temperature, separated, and plunged, one into mercury, one into water, and one into oil. When they are tested for hardness the bar cooled in the mercury is found to be the hardest, and the one cooled in oil the softest, the water cooled bar taking an intermediate place.

Now heat escapes from a body in three ways, (i) radiation, by which the heat passes from the body through space without the intervention of ordinary matter; (ii) absorption into the gaseous, liquid, or solid matter surrounding the hot body; (iii) conduction through the surrounding matter. All these are more or less concerned in removing the heat from a hot body, and the rate at which it is removed depends upon the properties of the surrounding bodies. Now mercury, though not such a good absorber of heat as water, is a very much better conductor, and this property more than counterbalances the greater absorbing power of the water; hence the more rapid cooling and the greater hardness of the bar quenched in it. Also, water has a greater absorbing power, and is a better conductor than oil, which explains its greater hardening property. Mercury is not often used in practice, for the action of water can be increased by dissolving a body such as common salt in it, and by having it cold. The presence of the salt in the water increases its conductivity, and thus causes more rapid cooling. This is the only action of the salt and other substances added to the water. Ice cold water is sometimes used, and the cause of its increased action is obvious.

There is for each quality of steel a temperature limit above which the metal must not be heated in the hardening process, so that if extra hardness is required this must be arranged for in the quenching. An instructive experiment

in this connection can be made thus : a bar of steel 12 inches long is nicked at every inch, and heated so that one end is at a white heat, and the other at a very low red heat, the parts in between being at intermediate temperatures. The whole bar is then quenched in cold water, and broken into pieces across the nicks. The fractured surface of the piece that was hottest, although hard, is found to have a very open crystalline structure. This diminishes in the other pieces until the grain becomes close, even, and velvety in appearance, and this piece is found to have the best and most uniform hardness. The hardness of the pieces from the other end is defective, and the grain more open. It is evident from this that there is a temperature range within which the best hardening effects are obtained, and the metal should not be heated above it, for even though the steel is allowed to cool to the proper temperature before quenching, the grain does not close again, and cracks are likely to develop. If it is overheated by mistake it should be allowed to cool slowly, and then be heated again to the proper temperature before quenching. This will modify, although it may not cure, the effects of overheating. The temperature should be high enough to harden the metal sufficiently, but not high enough to open the grain. A little liberty may be taken with the lower carbon-steels, but absolutely none with the high carbon metal, if the best result is to be obtained.

A tool should not be hardened straight from the forging process even though it be hot enough, but should be allowed to cool before heating for hardening. Tools with sharp edges and corners should be allowed to cool a little before quenching, for the edges are usually hotter than the main mass when it is removed from the heating chamber. In a short time the temperature is equalised, and the body is ready to be plunged into the cooling liquid. Large tools are more difficult to harden than small ones, and should be

raised to a slightly higher temperature. This is due to the more rapid quenching of the smaller body. Also, large tools take some time to heat up to the necessary temperature, so that oxidation is unavoidable unless their surfaces are protected. This may be done by coating them with some substance that has no effect on the steel. Thus common salt and borax, or borax alone, sprinkled over the surface, melts and forms a glaze. Soft soap rubbed over the surface of the tool protects it somewhat. A good mixture for the purpose consists of two parts of charcoal and one part of yellow prussiate of potash boiled with water, and thickened with gelatin. When the tool has been heated to a dull red it is dipped in and out of this mixture until it is well coated, and is then heated up for hardening. Scale formed by oxidation is a bad conductor, and when firmly adherent keeps in the heat, thus rendering the cooling slower, and interfering with the operation. The prevention of oxidation is not so important in the case of forged tools that have to be ground up after hardening; but when the articles are finished before they are hardened, as is the case with some machine parts, it is necessary that they should come out bright, or at any rate practically free from scale. Such articles can be heated by immersing them in a bath of molten common salt, or nitre, the temperature of which is above the recalescence point. They are then quenched in the usual manner. This method gives uniform results, as the temperature of the bath is fairly under control. The melting point of common salt is 815° C., and that of nitre 352° C. The bath is usually an iron pot set over a coal-fired grate by which it is heated. Some pots are gas-fired.

Thin films of oxide may be removed by the use of dilute hydrochloric acid (smoking salts) for quenching. This is really hardening and pickling at the same time, but it must be remembered that the addition of the acid increases the hardening power of the water. A solution of zinc chloride

(killed spirit) is also used, and this gives a pleasing appearance to the surface of the finished work.

When the heating is carried on in a smith's fire, or in a furnace filled with flame, the surface of the metal is exposed to the fuel and products of combustion, and the metal may be injured by the absorption of sulphur, which is often

present in the fuel. This method may be described as forge hardening. A safer method, now largely used, is to carry on the heating in a muffle furnace, the heating chamber of which is completely cut off from the fuel and products of combustion. There is more liability to oxidation, but as the surface of the metal can be protected, if necessary, this is not a serious objection. Also, two or more chambers, one above the other and heated to different temperatures, can be used, and the

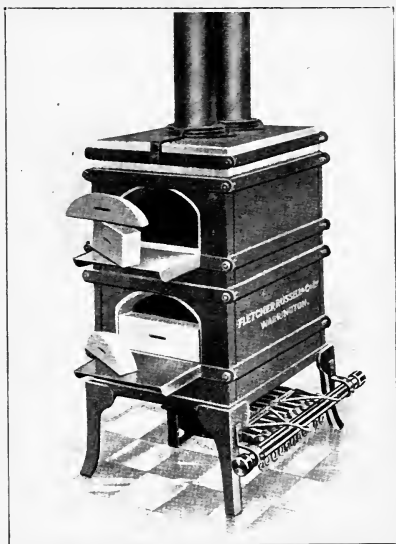

FIG. 78.—Muffle Furnace.

steel heated more gradually and uniformly by passing it from chamber to chamber. This is most important, for if a cold tool is put straightway into a very hot space the temperature of the outside is suddenly raised, causing rapid expansion of that part before the heat is sufficiently conducted to the metal beneath, so that there is a greater tendency for cracks to develop. This improved method of heating is rapidly coming into



use, and the difficulties of the hardener are gradually disappearing.

With tools that only require to be hard in one part the heating must be conducted so that the temperature grades off uniformly, for if there is a sharp break, fracture is likely to result. Fig. 78 is an illustration of a muffle furnace with two heating chambers.

Tempering.—The sudden quenching of the steel prevents the segregation of the cementite, and thus keeps the carbon in solid solution, or in the hardening form. As the temperature of a piece of hardened steel is raised, there is

Colour.	Temperature.	Suitable for
Faint yellow	220° C.	Surgical knives.
Straw ,,	230° ,,	Razors, taps, dies.
Brown ,,	255° ,,	Scissors, shears.
Purple brown	265° ,,	Axes, planes.
Purple	275° ,,	Table knives, punches, chisels.
Light blue	288° ,,	Swords, coiled springs.
Dark ,,	293° ,,	Fine saws, augurs.
Nearly black	316° ,,	Hand saws.

a tendency towards segregation and reduction of hardness. This becomes marked at about 200° C., and the higher the temperature to which the metal is raised the softer does it become. If a piece of hardened steel is rubbed until its surface is bright, and is then gradually heated in contact with air, the bright surface undergoes change due to oxidation. The film of oxide is exceedingly thin at first, and colour effects are observed similar to those on a soap bubble. The colour of the film furnishes a good indication of the temperature of the steel, for it changes as the metal gets hotter. When the proper colour appears the steel is quenched. The above table gives the more noticeable

colours, and their approximate temperatures. The explanation of the internal changes in the light of the solution theory is very simple: the cementite in the solid solution martensite or hardenite commences to segregate, and thus softens the metal. The higher the temperature the greater the segregation, and the softer the temper of the steel.

The simple process as used for a single tool may be thus described. The tool is rubbed on a brick, and then placed on a hot bar of iron with the brightened surface upwards. This is closely watched until the proper colour appears, when the tool is tipped off the bar into the quenching liquid.

But a variety of methods are now in use where tempering is carried on largely. Lead melts at 326° C. and alloys of lead and tin melting at lower temperatures are easily obtained. In fact, all the temperatures given above can be obtained in a series of lead-tin baths. An iron vessel containing the alloy and heated as already described is used. The metal or alloy is kept just melted, the articles are immersed in it, and when they have reached the temperature of the bath, are removed and quenched. Nor is it necessary in many cases to make the tempering a separate process, for the steel at the hardening temperature may be plunged into the bath and held there till it comes to the same temperature; it is then removed and plunged into water.

Oil baths, which are readily maintained at a definite temperature, are largely used for hardening and tempering. Of course, much depends upon what the tool or part is to be used for. In some cases it is not necessary to heat up to the recalescence point before quenching in the oil bath. An oil hardening tank 75 feet deep and containing 15,000 gallons of oil, is in use at Messrs. Firth's, Sheffield, for hardening heavy gun tubes. It is served by a 50-ton crane.

Some tools are made in large quantities, and are treated in a uniform manner. Files, for example, are covered with

a paste of salt and flour, heated in a coke fire, straightened on a block with a lead hammer, and then dipped into a brine bath. Saws are quenched in whale oil, and the oil that adheres to the surface burnt off to temper them. Large pieces, such as steel-faced anvils, are sprayed from above with water. Very thin sheets may be hardened by quenching them between thick metal plates, which treatment also prevents them from warping.

Annealing.—The hardening effect of working on iron and steel, especially on the cold metal, is well known, and is largely due to the internal strains set up in the metal by the external stresses brought to bear upon it. The operations having the greatest effect are forging, rolling, and wire drawing. The object of annealing is to remove these internal strains, or to redistribute them. Steel hardened by cold or nearly cold working is not hard in the same sense that quenched steel is hard; but when worked hot the hardness may be due, in part at least, to the arrest of some of the changes that take place on slow cooling. The annealing should be conducted so that the metal, whether hard from working or from quenching, is obtained in the softest and most ductile condition possible, and the resistance to sudden shocks is a maximum. Also the elastic limit should be high. It may be stated generally that the higher the percentage of carbon in the metal the greater the care required in regulating the temperature of annealing. The operation should be conducted as far as possible out of contact with air, to prevent oxidation, particularly so with high grade steels, as some of the carbon itself is burnt out.

According to Brinell, steel annealed at gradually increasing temperatures up to about 680° C. undergoes very little change in structure as far as the grain is concerned, but at 730° C., just above the recalescence point, the structure becomes fine grained. He distinguishes this important range of temperature by marking the lower limit

by the letter *V* and the upper limit by the letter *W*. These are practically the same as the arrest points Ar_1 and Ac_1 already described. Above this temperature range the grain gets coarser, until at $1,100^\circ$ C. it is quite coarse, and at $1,400^\circ$ C. it is very coarse grained and "burnt." This burning is distinguished from simple overheating by the extreme brittleness of the metal both hot and cold, and its coarse, shining fracture. The grains are probably only slightly coherent, and at this high temperature small quantities of occluded gas are liberated, the pressure of which forces the grains apart, and makes the structure more open. Air can thus filter in and the grains are oxidised superficially. The oxygen thus introduced may also assist in opening the structure by forming carbon monoxide with some of the carbon, which by its pressure would help to separate the grains. If this is true it becomes clear why high grade steel is more easily burnt than low carbon metal.

Annealing the burnt metal at a lower temperature will not cure it, as it cannot close up the grains. Nor is such metal benefited very much by hammering or rolling. It must be melted again, so that it is best for burnt metal to be scrapped straightway. On the other hand, metal that has been simply overheated can be in a great measure restored by annealing at a lower temperature, and by mechanical working.

According to Stead, the prolonged heating of low carbon steels between 600° C. and 750° C. renders them coarsely crystalline, but not necessarily brittle. On reheating to about 900° C. the coarse grain and brittleness disappear. Thus he found that steel rails and blooms which had been rendered dangerously brittle by overheating were restored to the best possible condition by reheating them to 870° C., and without working them down to a smaller size. Test pieces were taken from these bars and subjected to alternating stress tests, and to impact tests.

Campion, who has investigated the effects of heat on steels containing from 0·1 to 0·5 per cent. of carbon, states that the best temperature for annealing, so as to obtain a high elastic limit and great ductility, lies between 750° C. and 850° C. The metal is then in the best possible condition to resist sudden shocks. The higher the temperature the shorter the time the metal requires to be exposed to it; but although slower heating at a lower temperature may be suitable for some steels, the recalescence point must be exceeded to obtain the finest grain.

Professor Howe also emphasises the importance of a careful regulation of the temperature during annealing, which, by the way, he calls "heat refining," and states that it must be carried above the recalescence point, or to the *W* of Brinell, if the finest grain is to be obtained. "Hammer refining" is also another expressive term used by Howe in dealing with the effects of mechanical work upon the hot metal. It may be noted here that the effect of work of any kind at temperatures below a dull red heat is to distort the grains, but this distortion and its effects can be removed by heating the metal through the range *V*—*W*.

The usual practice with heavy gun tubes, large axles, etc., is to heat to about 800° C. and quench in oil at 20° C. Then reheat to 550° C. This considerably increases the resistance of the metal to shock.

From what has been said, the great importance of the proper heat treatment will be readily understood, if the best is to be got out of the metal.

The term annealing is also used in connection with the heat treatment of some forms of cast iron. Grey iron when cast into large pieces is sufficiently soft to be machined, but there is often a thin skin of hard metal to be removed first. With small articles, which cool rapidly in the moulds, the chilling effect is much more marked, and the skin of white

metal is moderately thick. This may be modified by prolonged heating in a slow fire, and the surface can then be dressed. Common cutlery is often produced in this way. When, however, white or mottled irons, which are low in silicon, are used, the nature of the castings is the same as that of the metal from which they are cast. The castings are, therefore, hard, brittle, and unworkable, and must be annealed. But the annealing has for its object the decomposition of the cementite, and the liberation of the carbon in the form of what Ledebur calls "temper carbon." This is free carbon but not graphite, and it gives to the fractured surface of the iron a black velvety appearance, which has gained the name of "black heart" for the castings in which it is present. To bring about this change the castings are imbedded in sand in an iron pot, and the lid luted round with clay to exclude the air. The pot is then heated in a furnace to a temperature of 850° C., and maintained at this heat for about two days. It is then allowed to cool down slowly. A skin of malleable iron is formed due to the oxidising effect of the small quantity of air in the box, but inside this is the black heart peculiar to castings of this class. They are stronger than similar castings made from grey iron, and machine readily.

For "malleable castings" so called, the process is somewhat different. They are cast from white or mottled iron, and are glass hard and brittle. To soften them and render them workable they are imbedded in coarsely powdered haematite ore, and heated in cast iron pots to 850° C. Two or three days are required to get up the temperature, and about the same time to complete the annealing. The length of time, however, depends upon the size of the pieces, and the extent of the annealing required. The operation is sometimes called oxidising cementation, and it is certain that oxidation takes place which results in the removal of

some of the carbon ; but the principal change appears to be the decomposition of cementite and the liberation of its carbon, either as finely divided graphite, or as temper carbon. Thus a malleable casting after annealing consists of a shell of iron softened by the removal of most of its carbon, and a core softened by the liberation of its combined carbon as graphite.

MEASUREMENT OF TEMPERATURE.

Specific heat and temperature are regarded as the two factors of heat energy, and are measured by reference to arbitrary standards. Specific heat is in effect the capacity of unit weight of a body for absorbing heat, while temperature indicates the tendency of heat to escape from the body. Generally, when heat enters a body its temperature rises, but the greater the specific heat of the body the smaller will be the rise in temperature for a given quantity of heat absorbed. Whatever may be the capacity for heat or the size of the body, it can be raised to a given temperature if sufficient heat is passed into it. Thus a 50 ton ingot may be raised to the same temperature as one weighing a pound, and the temperature determined from either of them, for it is the same in both. Temperature bears much the same relation to heat that height of level does to water. The pressure of the water in a tank depends upon the height of the level and not upon the dimensions of the tank. The fixed points for the arbitrary measurement of temperature are the freezing and boiling points of water. On the Centigrade scale the interval between these two points is divided into 100 parts or degrees. Thus 0° C. is the freezing point, and 100° C. the boiling point, of water. $1,000^{\circ}$ C. is equal to ten times this interval of temperature. On the Fahrenheit scale the interval is divided into 180 parts and 32 are added below the freezing point, so that the freezing

point is 32° F. and the boiling point 212° F. Degrees on one scale can be expressed in degrees on the other by the following simple formulæ :—

$$C^{\circ} = \frac{5}{9} (F^{\circ} - 32) ; F^{\circ} = \frac{9}{5} C^{\circ} + 32.$$

The instruments for measuring temperatures up to 300° C. are usually called thermometers, and are mostly based upon the expansion of a liquid as its temperature rises. Mercury is the common liquid for the purpose, and a few minutes spent with a mercurial thermometer will render its action perfectly clear. For measuring higher temperatures the instruments depend upon other principles, and are known as *pyrometers*. A large number of such instruments have been devised for the purpose. The two forms most generally used are electrical in principle.

The Resistance Pyrometer.—The Siemens pyrometer depends upon the increase in the resistance of a thin platinum wire to the passage of an electric current through it as the temperature to which it is exposed rises, and the measure of this increase in resistance is also a measure of the increase in temperature. By correlating these the temperature is determined. A modern portable form of this instrument, made by the Cambridge Scientific Instrument Company, is shown in Fig. 79. The porcelain or steel tube contains a coil of thin platinum wire wound on a mica frame. The free ends of the coil are connected by stout leads to the indicator. The tube is inserted in the hot space the temperature of which is to be determined, when the resistance of the coil increases until the space and the tube are at the same temperature. This resistance is then balanced by an opposing resistance in the recorder that is put into the circuit by turning a milled head connected with it. The balance is indicated by a magnet needle which points to zero on the scale when the balance

is made. The temperature is then read off on the temperature scale. These instruments are calibrated with



FIG. 79.—Resistance Pyrometer.

great care, and give good results. In Fig. 14 a labourer is shown taking the temperature of the hot blast with one of these instruments.

The Thermo-Electric Pyrometer.—This instrument depends upon the fact that if two wires of different metals or alloys

are twisted, soldered, or welded together at both ends so as to form a closed loop, and if one of the junctions is heated while the other is kept cool an electric current will circulate in the wire. This current, although very small, can be made to deflect a sensitive galvanometer needle, and a record of its strength is thus obtained. As the deflection of the needle is proportional to the strength of the current, and the strength of the current is proportional to the temperature of the junction, this last quantity can be determined. Various metals and alloys might be used for the junction, but for recording high temperatures the platinum and platinum-rhodium alloy introduced by M. Le Chatelier is the best. In the Roberts-Austen form of this pyrometer the galvanometer carries a small mirror which is made to reflect a small spot of light on to a photographic plate. When the galvanometer is deflected by a current passing through it the mirror is deflected also, and the spot of light travels along the plate in a horizontal direction. If at the same time the plate is caused to move at a uniform rate the spot of light will trace a curve upon it that will come into view when the plate is developed, and will thus form a permanent record of the variation in temperature of the thermo junction. Apparatus based upon these principles was used for obtaining the data from which the curves given in Fig. 77 were plotted.

A portable pyrometer of this type is made for use in works. It consists of a platinum and platinum-rhodium junction inserted in a porcelain or steel tube and a recorder. The wires are carefully insulated from each other, and the cold junction is contained in a box at the top of the tube, together with two other junctions—copper-platinum and copper platinum-rhodium—formed by putting the copper leads from the galvanometer into the circuit. But as these junctions are all in the same space they are kept at the same temperature, which is registered by a thermometer

and is thus known. The galvanometer is not always of the reflecting type, but in some forms an automatic record can be obtained from a curve traced on the prepared surface of a revolving drum, which may be arranged to revolve once in a given number of hours, say up to twenty-four hours. The recording part of the apparatus may be placed at any convenient distance from the junction, and connected with it by leads. The manager's office is a good place for it.

In the portable type, for taking the temperature at intervals, it is read on a dial plate attached to the recorder box. Each instrument has to be calibrated before it is used, and this is done by means of substances, principally metals, of which the melting points are accurately known. To do this all the junctions are brought to the same temperature, and the zero point, where the pointer comes to rest on the galvanometer scale, is marked. A piece of one of the metals is melted in a small crucible imbedded in a mass of sand contained in a larger crucible. The whole is then removed from the furnace and the thermo junction, incased in a thin clay tube, held in the molten metal. When the freezing point of the metal is reached the cooling is arrested for a time, and the position of the pointer on the galvanometer scale remains practically stationary until the metal is solid. This point is noted, and other metals are treated in the same manner. In this way a number of points are obtained on the scale, which is then divided in proportion. The strictly correct method is to plot a curve from the data thus obtained, and so find the intermediate points. It is said that these instruments, when correctly calibrated, will read up to $1,600^{\circ}$ C. ; but the shorter the range the more open it is. The actual temperature registered is the difference between the temperatures of the hot and cold junctions *plus* the temperature of the cold junction. The temperature of the recalescence point of steel is easily determined by one of these instruments.

The steel bar, which has a hole drilled in it to take the thermo-junction, is heated to a bright red heat, the junction inserted, and the whole allowed to cool. The pointer is deflected and then travels back across the scale towards the zero point, but when the recalescence commences it is

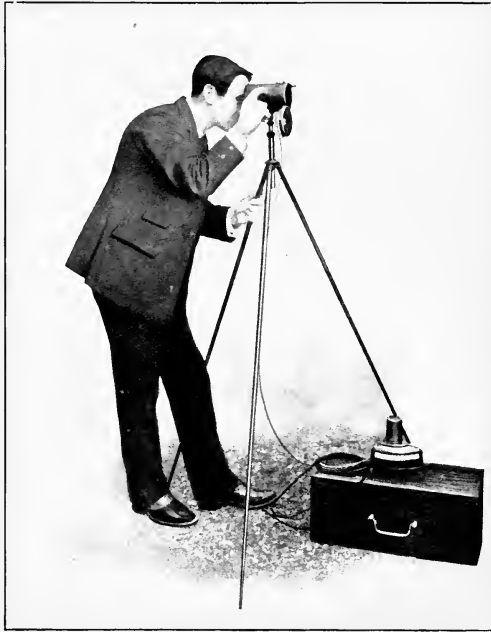

FIG. 80.—Radiation Pyrometer.

again deflected, thus showing a sudden increase in the temperature of the cooling steel. When the recalescence is passed the pointer resumes its journey towards zero.

The Féry Radiation Pyrometer.—The drawback to the resistance and thermo-electric pyrometers is that there is a limit to the temperature to which they can be exposed, as

the themometric portions of these instruments must be actually in the hot space the temperature of which is to be measured. This is obviated in the Féry instrument by having the thermo-couple outside the space, and focussing the radiations from the furnace or other hot body upon it. The pyrometer consists of a small reflecting telescope, the concave mirror of which receives the radiations from the hot body, and brings them to a focus on a copper-constantan thermo-junction placed there to receive them. The free ends of the junction are connected with binding screws on the side of the telescope tube, and leads pass from these to the sensitive galvanometer that registers the current generated. It is evident that the hotter the body is from which the radiations come the higher will be the temperature of the junction, and the stronger the current registered by the galvanometer. Theoretically, the distance of the instrument from the hot body would have to be taken into account, as some radiation is absorbed by the air through which it passes, but practically it makes very little difference whether the space between is 5 feet or 50 feet. A hole leading into a furnace is required for sighting, but a red hot ingot or a stream of molten steel may be sighted direct. On looking through the eye piece of the telescope the junction is seen as a black disc in the middle of the field, and the image of the hot body shows as two half-circles formed by two mirrors placed near the junction. The pyrometer is in the proper position for taking the temperature when these two half-circles join to form a complete circle that clearly over-laps the junction disc. The galvanometer is calibrated to read degrees Centigrade. Two temperature scales, one from 600° C. to 1,300° C. and another from 1,000° C. to 2,000° C., are ordinarily divided on the galvanometer. When high temperatures are to be registered a diaphragm is used to cut off a portion of the heat from the telescope. The temperature of the

hot junction rarely exceeds 80°C ., so that it is under perfect control, and the sighting is an easy matter. A permanent record for a given period can be obtained by using a thread recorder in place of the direct reading galvanometer.

Professor Féry has, by using one of these instruments, estimated the temperature of the sun to be $7,800^{\circ}\text{C}$., and it is certain that they give the very best means at present available of determining the temperature of electric furnaces and other very hot bodies. Fig. 80 shows the general form of the pyrometer as used in works.

CHAPTER XIII.

ELECTRIC SMELTING.

THE employment of the energy of an electric current for doing various kinds of work is now well known. Heating, lighting, and traction are the most familiar, but the chemical action of the current is also largely used in manufacturing processes. There are a variety of ways in which an electric current with its accompanying energy can be generated, but in whatever manner it is brought into existence an equivalent quantity of some other form of energy disappears. The only way of generating electricity on the large scale for practical use is by means of the dynamo, and this machine requires to be driven by power of some kind. The common sources of such power are steam, water, and combustible gas, and which of these sources is the most economical depends upon surrounding conditions.

There are two principal types of current generators: direct-current dynamos and alternators. In machines of the first type the effective parts are so arranged that a continuous current flows through an outside conductor connecting the terminals or brushes which press upon the revolving commutator. That is, the main current is always in the same direction, for one terminal is constantly at a higher potential than the other, and it is assumed that electricity flows from points of higher potential to points of lower potential through a conductor joining them. In machines of the second type the arrangement is such that the current ebbs and flows with a concertina-like motion in

the conductor joining the terminals, so that, in effect, the main current is made up of series of currents in opposite directions. This is the result of the constantly changing potential of the terminals, for when one is high the other is low, and they change alternately, so that currents passing between them alternate in direction.

The action of these current generators depends upon the rapid cutting of the lines of force in a powerful magnetic field by properly arranged coils of insulated copper wire. The larger the number of lines cut in a given time the higher is the potential at which the current is generated. Therefore, for a given coil the more powerful the field, and the faster the coil cuts through it, the higher is the average potential generated in the coil. But as the coil moves into the field the potential rises to a maximum, and as it moves out of the field the potential falls to a minimum, so that there is a constant rise and fall with its accompanying alternation in the direction of the current, for the current ebbs and flows in the coil in exactly the same way that it does in the conductor joining the terminals. This is the natural order inside the machine, so that in its simplest form it is an alternator.

The coils are fixed to a spindle working in bearings, and having a driving pulley at one end. The other end is fitted with two copper rings insulated from each other, to which the two free ends of the coils are joined. The whole is called the armature. The electro-magnets, which consist of soft iron parts surrounded by insulated coils of copper wire, form part of the fixed portion of the machine. Two contact pieces press against the rings, and are connected with the terminals from which the power is drawn off for use. In direct current machines the end of the armature is divided into a large number of copper segments insulated from each other, and to these the ends of the coils are so connected that when the two contact pieces, or brushes, are pressed

against opposite ends of a diameter, the current is always passing out of the end of the coil connected with the segment being pressed upon by the one brush, and passing into the coil connected with the segment being pressed upon by the other brush. The terminal of the machine connected with the high potential brush is said to be the positive + terminal, and that with the low potential brush the negative - terminal. This divided end is called the commutator, and the greater the number of segments in it the nearer the current approaches to a continuous one through the outside conductor. Thus in alternators the currents are allowed to flow as they are generated, and in direct-current machines they are diverted into one direction. The electro-magnet in either machine is excited by a direct current which, in the case of the alternator, is furnished by a small direct-current dynamo attached to the frame, and in the case of the direct-current machine from the armature of the machine itself.

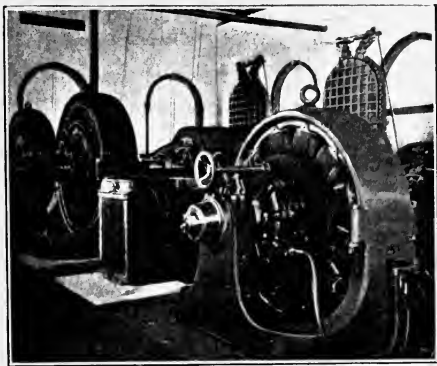

FIG. 81.—Alternators in Position.

Alternators are either monophase or polyphase, according to the number and arrangement of their coils. In polyphase machines a pair of rings and leads may be used for each phase, or they may be combined with a common return. In a well designed machine a very large proportion of the mechanical power used in driving it is converted into electrical energy to pass out of the terminals with the

current. Alternators are by far the best for heavy work for which the alternation in the direction of the current is of no importance. A difference of potential up to 16,000 units may be generated in them with safety, but in direct-current machines the limit of safety is about 2,000 units. Very large and powerful alternators are now being designed, nor has the limit to their size and power yet been reached.

Fig. 81 shows several Westinghouse alternators in position at a water-power station.

The electrical engineer usually speaks of difference of potential as electrical pressure, and regards the two factors of electrical energy as pressure and quantity of electricity. The former is, in effect, the driver that forces the current through resistances of various kinds, and the latter the quantity of electricity which passes through the resistance. The pressure, quantity of electricity, and resistance are all measurable quantities and have their proper units of measurement.

The Volt is the unit of electrical pressure or difference of potential.

The Ohm is the unit of electrical resistance.

The Ampere is the unit of current strength, and is defined as the current that passes through a resistance of one ohm under a pressure of one volt.

These units are recognised standards of measurement, and are just as well defined as the pound and the foot units of weight and length.

When these are properly correlated they may be put into the following form :—

$$\text{Current} = \frac{\text{pressure}}{\text{resistance}}, \text{ or amperes} = \frac{\text{volts}}{\text{ohms}}, \text{ or } C = \frac{V}{R}$$

This relation is known as *Ohm's Law*, and forms the basis of a large number of electrical calculations.

The energy carried by a current is directly proportional

to the pressure and to the current strength, and when it does no outside work is entirely converted into heat which under proper conditions can be used as such.

The Watt is the unit of electrical power and is carried by an ampere of current; it is further defined by introducing the element of time. The watt is a very small unit, so for practical purposes it is multiplied by 1,000, and is then known as the *Kilowatt*.

Joule proved that one watt-second, that is, the quantity of energy expended in one second by one ampere of current working through a resistance of one ohm under a pressure of one volt, develops heat sufficient to raise 3·7 grains of water through 1° C.

He also proved that the quantity of heat required to raise 1 lb. of water through 1° C. would, if expended in doing work, raise 1,390 lbs. through a vertical height of 1 foot. Watt estimated that a horse working for one second would raise 550 lbs. through a vertical height of 1 foot; and this is equivalent to raising 2,765 grains of water through 1° C.

$$\text{Therefore 1 horse power} = \frac{2765}{3\cdot7} = 746 \text{ watts.}$$

$$\text{And the kilowatt} = \frac{1000}{746} = 1\cdot34 \text{ h. p.}$$

Value of 746 watts is sometimes called the electrical horsepower—E.H.P., and the kilowatt-hour is the Board of Trade unit of electrical supply. A simple calculation shows that 8 kilowatt-hours would, if converted into heat, melt 1 cwt. of cast iron. When large supplies are to be considered the kilowatt-year is used, and this is usually taken as $365 \times 24 = 8,760$ kilowatt-hours; but it would be simpler to take 10,000 for this large unit. The cost of production depends upon a number of circumstances, among which the cost of

the mechanical power used in driving the dynamo is the most important.

One of the first, if not the first, applications of electricity to the treatment of iron and steel was made by Pepys in 1815, when he split a piece of iron wire, filled the gap with diamond powder, and passed a powerful current through the wire. The metal was thus raised to a bright red heat, and in six minutes the diamond dust had disappeared, while the iron was converted into "blistered steel." The late Sir W. Roberts-Austen repeated this experiment in a vacuum with every possible precaution, and proved conclusively that red-hot iron will absorb solid carbon.

In 1849 Despretz obtained metallic iron from a mixture of oxide of iron and carbon by the heat developed with an electric current.

In 1867 the residual magnetism of soft iron was first taken advantage of in dynamo construction, and the machine was thus made independent of everything but the power required to drive it. Enormous strides have been made since then, and now the only limit to the use of electricity in iron and steel manufacture is the cost of the energy. Much has been done, and very much more attempted, since Siemens introduced his small electric steel-melting furnace in 1879. Only the more successful work can be referred to here.

Electric Furnaces are conveniently classified into (i.) arc furnaces, (ii.) resistance furnaces, (iii.) induction furnaces. They all, however, depend upon the heat developed by electrical resistance.

In the arc furnace the heat is due to the resistance of gases and vapours, and in the resistance furnace to that of solid and liquid bodies, but in most cases there is also more or less arcing through the gaseous matter in the furnace. In these types of furnace the terminals of the generator are connected by leads with the corresponding

terminals of the furnace, so that in the empty furnace there is a gap between the terminals, and no current can pass. When this gap is bridged over by conducting matter the current passes, and its energy is converted into heat. The furnace terminals are in almost all cases rods or blocks of strongly compressed carbon, and when these are brought together and then separated, an arc is formed between them when the pressure exceeds 40 volts. The arc space absorbs an enormous amount of energy from the current with the development of a correspondingly high temperature, and it is probable that a temperature of 4,000° C. or more has been obtained. It is in arc furnaces generally that processes requiring exceptionally high temperatures are carried out. Resistance furnaces are used when a lower and more distributed temperature is required.

There are no terminals required in the induction furnace, as it is based upon the principle of the transformer used in general electrical practice for reducing the pressure of high potential currents. To understand the principle involved, suppose that a ring of soft iron, such as a link of a heavy cable, has a coil of several loops of insulated copper wire wrapped round one part of it, and that an alternating current is passing through these loops. An alternating magnetic flux is set up in the soft iron corresponding to the alternations of the current, and if an independent coil with a smaller number of loops is wrapped round another part of the iron ring, alternating currents are induced in this secondary coil. Now, it is found that, neglecting small losses, the average pressure of the current in the secondary coil is reduced in the same proportion as the number of loops in the coil is smaller than the number in the primary coil, and that the quantity of electricity is increased in the same way. Thus, suppose an alternating current of 10 amperes, under a pressure of 1,000 volts, is passing through a primary coil with 1,000 loops, it will induce a current of

100 amperes at a pressure of 100 volts in a secondary coil consisting of 10 loops, and with one loop 1,000 amperes at 10 volts. These heavy currents are much more useful for heating and lighting purposes, as a conductor of given cross-section offers more resistance to their passage. High-potential currents are usually conveyed over long distances by comparatively thin conductors, and transformed into low-potential currents where they are to be used. Induction furnaces are in effect transformers in which the metal to be melted is made to take the place of the secondary coil.

Steel Making in the Electric Furnace.—It is improbable that the electric furnace will be able to compete with the Bessemer and open hearth processes in the manufacture of steel for constructional purposes, except under special conditions; but it will prove a serious rival, and finally oust the old processes of making high-class tool steel. Up to the present the electric furnace has flourished in districts where abundant water power is available; but with the introduction of gas-driven generators, and especially where blast-furnace gas can be used, it is sure to make its way into the iron working districts of this country.

The Héroult Process.—The furnace used in this process is of the resistance type, and has been producing high-class tool steel in considerable quantities for several years past. It is a small iron-clad tilting furnace, lined with refractory material. The bed plate is covered with a layer of either dolomite or magnesite bricks, on the top of which is rammed the working bed of dolomite lime. The roof is lined with silica bricks. There is the usual spout for pouring, and the charging door. Two massive carbon blocks are suspended side by side through two openings in the roof, but out of contact with the sides, so that they can be moved freely. These blocks form the terminals or electrodes of the furnace, and are so arranged that they can be raised or lowered separately, either by hand gearing

or by small motors fixed to the supports. In the parts of the roof between the electrodes the iron plates are replaced by bronze to prevent the forming of a magnetic circuit when the current is passing; and the parts of the

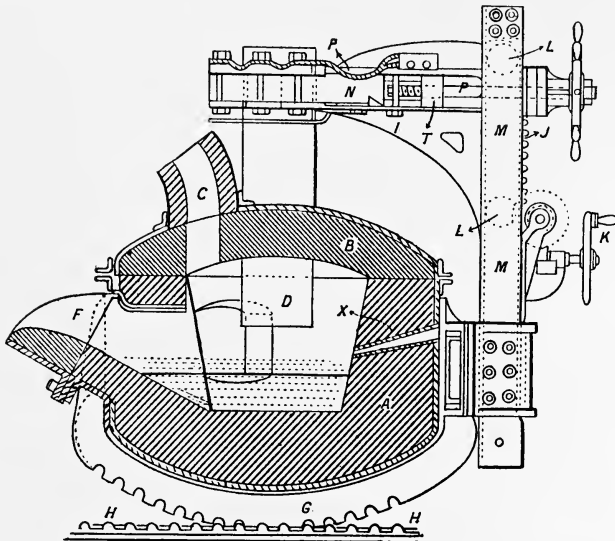

FIG. 82.—The Héroult Furnace.

- | | |
|------------------------------|---|
| <i>A</i> , Furnace lining. | <i>F</i> , Tapping spout. |
| <i>B</i> , „ roof. | <i>G</i> , <i>H</i> , Tilting gear. |
| <i>C</i> , Outlet for gases. | <i>M</i> , <i>N</i> , Supports for carbons. |
| <i>D</i> , Carbon block. | <i>K</i> , <i>L</i> , Regulating gear. |

electrodes exposed to the heat of the roof are water-jacketed. The furnace is shown in section in Fig. 82.

Steel or iron scrap of average quality, such as crop ends from the mill, is worked into high-class tool steel, and the operation is thus described:—

The scrap is charged on to the bed, together with lime, and the electrodes are brought down so as to touch parts of the charge. The current then passes from one electrode

to the other through the charge. A number of arcs are formed by the imperfect contact at various points, and heat is developed due to the resistance of the charge generally. During the melting down it is usual to switch out the motor control of the carbons, and regulate them by the hand gearing, so as to avoid short-circuiting as much as possible. As the charge melts down more scrap and lime are added, and when it is quite fluid some pure ore is thrown in. The carbons are now above the molten bath, and form two arcs with its surface. It is in these arcing spaces that most of the heat necessary to keep the bath molten is generated. Slag forms, and after a time the furnace is tilted to run it off as completely as possible, the last portions being raked off. The furnace is then tilted back, and more ore and lime added to form a fresh slag. This is poured, and a third slag formed in the same way. The removal of the last traces of impurity is thus ensured. When the last slag has been run off the metal is finished in the case of low carbon steel by the addition of ferromanganese, and for high carbon steel by adding a calculated quantity of a fritted mixture of pure iron and carbon, according to the percentage of carbon required in the finished steel. The furnace is then tilted and the metal run into the ladle ready for casting.

At La Praz, in the South of France, such a furnace has been at work for several years. The electrical supply is obtained from an alternator connected directly with a water wheel, giving, with a full supply of water to the wheel, 4,000 amperes at a pressure of 110 volts. This is equivalent to 590 h.p., and in working for tool steel as much as 350 kilowatts = 470 h.p. were being absorbed by the furnace. According to Harbord, the cost of the electrical energy is 7s. 1d. per ton of ingots for the production of 2 tons 6 cwt. of steel during a run of 7 hours. These figures were obtained in 1904, when the Canadian

Commission visited La Praz with Professor Harbord as its metallurgical expert.

Dr. Hèroult was supplying steel to the Creusot Works as early as 1900, and he stated that by the end of 1904 the plant in operation in France would give an output of 150 tons of steel per day. The same type of furnace is also at work in Sweden and Germany. In the last-named, the

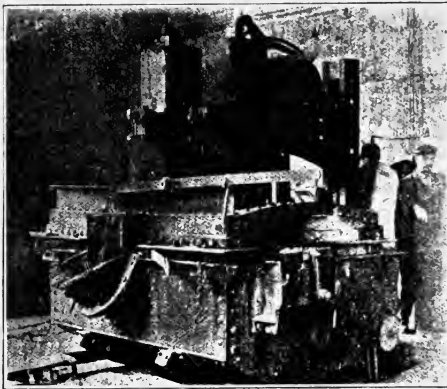

FIG. 83.—The Hèroult Furnace in Position.

electrical energy is generated by the use of blast-furnace gas in a gas engine.

The following is a typical analysis of the tool steel made in this furnace :—

S = 0·016 ; P = 0·006 ; Si = 0·02 ; Mn = 0·092 ; C = 1·08

The carbon may be varied from 0·06 to 1·87 per cent. ; that is, various grades of metal from the softest and most ductile iron to the hardest tool steel can be made at will. A furnace in position is shown in Fig. 83.

The Kjellin Process.—The furnace used in this process is a very successful example of the application of the principle

of induction to either a melting or a smelting process. The body of the furnace is built of ordinary furnace masonry and may be either circular or rectangular in cross section. Looked at from above, the hearth or crucible is seen to consist of a ring-like space in the masonry, lined with either acid or basic refractory material, and fitted with a movable cover made in segments so that parts of it can

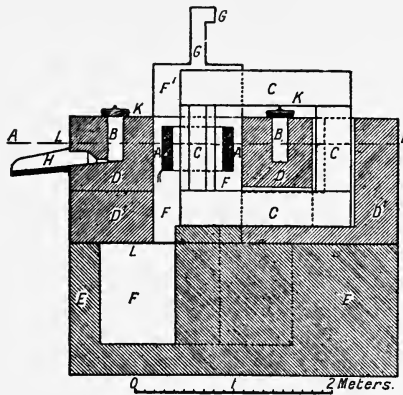

FIG. 84.—The Kjellin Furnace.

- | | |
|--------------------------------|--------------------------|
| <i>A</i> , Primary coil. | <i>F</i> , Air chamber. |
| <i>B</i> , Furnace hearth. | <i>G</i> , Exhaust pipe. |
| <i>C</i> , Iron core. | <i>H</i> , Tap hole. |
| <i>D</i> , <i>E</i> , Masonry. | <i>K</i> , Covers. |

be taken off as required. This ring hearth is nearer to one side of the structure, and the tap hole leads from this near part of the hearth to a spout fixed to the outside wall. Inside the hearth ring and concentric with it is a circular space separated from the hearth by a thick ring of firebrick. In the centre of this space is a laminated core made up of soft iron plates, and surrounded by a coil of insulated copper wire of many turns. The core is continued horizontally above and below to a second piece let into the masonry

outside the hearth space. The whole thus forms a closed magnetic circuit similar to the cable link referred to on p. 325. The space containing the coil is closed in at the top and connected with a pipe by which a rapid current of cold air can be drawn through to keep it cool when the furnace is working. The ends of the coil are connected by leads with the terminals of an alternator driven by a water turbine, and capable of supplying a current of from 80 to 90 amperes at a pressure of 3,000 volts. Fig. 84 shows the furnace in vertical section. To work the furnace sufficient molten pig iron is run into the hearth to form a molten ring of metal round it. The furnace is now a transformer, for the ring of metal forms the secondary circuit, and when the current is switched on the transforming commences. The number of loops in the primary coil is such that an induced current of 30,000 amperes at a pressure of 7 volts is set up in the molten circuit, and much heat is generated. The full charge is then made up by the addition of charcoal iron and scrap from time to time until the whole is melted. It is then kept in the furnace for a time for the temperature to rise sufficiently for tapping, when about two-thirds is run into the casting ladle, and cast into ingots. The remainder is left in the hearth to continue the transforming, and the full charge is made up and worked through in the same manner.

The process has been in use at Gysinge Bruk in Sweden since 1900 under the supervision of Mr. Kjellin, and is without doubt a success there; but it seems to be specially adapted to the treatment of the very pure materials peculiar to the district. Very little refining goes on, and except for the oxidation of a small portion of the carbon and iron, the action is a pure melting one. It is, therefore, possible to arrange a charge of pure pig iron, wrought iron, and scrap of known composition to produce steel of a given composition. Additions of ferro-manganese and other iron alloys

may be made for the production of special steels. Somewhat recently pig and ore have been used in place of pig and scrap, but this reduces the output, and very pure ore must be used if the product is to be high class. One of the recent furnaces is 12 feet in diameter, 8 feet high, and has a capacity of 35 cwt. The energy absorbed is about 240 h.p. and the output 5 to $5\frac{1}{2}$ tons per 24 hours. About 6 hours is required to work off a charge of 25 cwt. But

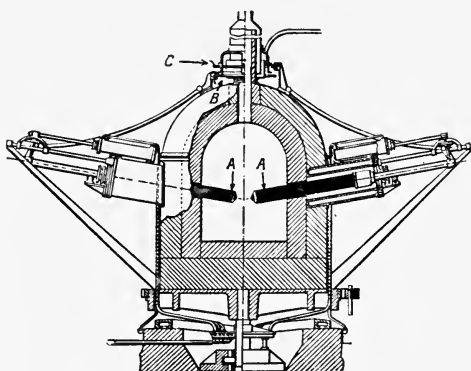

FIG. 85.—The Stassano Furnace.

two larger furnaces of 1,000 h.p., of which the dimensions are not to hand, are now at work.

The following analysis is given by Mr. Ritchie, of Glasgow, who saw the process in operation, and analysed samples of the steel:—

S = 0.012; P = 0.015; Si = 0.093; Mn = 0.044; C = 1.33.

The use of aluminium for the reduction of pure oxide of iron in a furnace of this type should solve the problem of obtaining carbonless iron for experimental purposes. A small induction furnace with a basic lined hearth of a few pounds capacity would furnish either the pure metal or

alloys of controlled composition, and the questionable method now in use of determining the influence of a particular element on the physical and mechanical properties of iron in the presence of other elements, would be avoided.

The Stassano Process.—The latest form of furnace, used by Major Stassano in carrying out his process, is of the arc type pure and simple. It consists of a circular chamber about 3 feet 3 inches in diameter and of the same height. It is lined with refractory brickwork, and has a dome roof. The carbon electrodes, *A*, which are about 9 inches in diameter, enter the chamber through openings midway between the floor and the roof. They are fitted with regulating gear by which they can be caused to meet in the centre of the chamber, or their free ends may be brought flush with the walls. There are tap holes for the metal and the slag, one near the bottom of the hearth, and the other midway between the bottom and the electrode openings. The parts of the electrodes outside the chamber are water jacketed to keep them cool. The furnace is iron clad, and is fixed at the bottom to a shaft slightly inclined to the vertical, by which it can be rotated on bearings at the rate of one to two revolutions per minute. In this way the charge may be set in motion and the tap hole brought to the lowest position when tapping. The charge is put into the furnace through an inclined shoot in the side.

As the furnace is revolving while the current is passing, the carbon electrodes are connected with the fixed leads from the generator by a rubbing contact at *C*. To effect this two fixed insulated rings are provided upon which contact pieces connected with the electrodes are pressed during the rotation of the furnace. The furnace that has given the greatest satisfaction is one of 200 h.p. and this absorbs about 140 kilowatts. The current is furnished by a water driven alternator. The form of the furnace is shown in vertical section in Fig. 85. A 200 h.p. furnace at work in

the Artillery Construction Works, Turin, for the Italian Government produces steel for artillery projectiles from the following materials in regulated proportions: (i.) pig iron turnings with sufficient ore and lime for refining the metal and slagging the impurities; (ii.) iron and steel turnings; (iii.) iron and steel scrap; (iv.) ferro-silicon and ferro-manganese for deoxidation and introduction of sufficient manganese into the finished steel. The product contains:—

$$P = 0.03 \text{ to } 0.04; C = 0.3 \text{ to } 0.4; Mn = 1.2 \text{ to } 1.5.$$

Very little loss of metal occurs, and the electrodes lose about 10 lb. per ton of steel. According to the inventor, it will make other varieties of steel either soft or hard just as readily by properly regulating the charge. There is no doubt that the furnace will make steel successfully. One of its advantages is that the electrodes are kept clear of the bath so that contamination of the metal from that source is not possible. One of its disadvantages is in the removal of the slag; but Stassano says that it can be completely removed in actual working.

The Stassano Electric Furnace Company of Turin have lately installed three furnaces, one of 1,000 h.p. with three pairs of electrodes, one of 200 h.p. and one of 100 h.p., but no details of their working are yet published.

The Electric Smelting of Iron Alloys.—The preparation of iron alloys in the electric furnace is of the most general importance, for in several cases they are either very difficult to produce or cannot be produced in an ordinary furnace. In fact, some of them owe their existence commercially to the electric furnace. Alloys of iron with silicon, manganese, aluminium, nickel, chromium, tungsten, titanium, molybdenum, and vanadium are now in common use; and although some of them are made extensively in the blast furnace, it is probable that eventually they will be almost entirely produced in the electric furnace. Many

inventors have applied their energies in this direction, and some so successfully that it would be somewhat invidious to select any one for first place, but M. Keller of the Keller, Leleux Company, Livet, France, has done much in this direction; and Mr. A. J. Rossi has been a most successful pioneer of the industry in America.

The production of ferro-alloys depends entirely upon the reduction of the oxide of the second element in the alloy by carbon in the presence of either metallic iron or its oxide, which is then reduced simultaneously. It is well known that when the reduction is effected by carbonaceous matter, or in the presence of the same, carbon itself is absorbed by the alloy. In this way as much as 8 per cent. of the element may be associated with the metals. This may or may not be a drawback, depending upon the purpose to which the alloy is to be put. It is possible, however, to considerably reduce the amount of carbon in the final product.

Mr. Rossi is especially interested in the production of ferro-titanium, the effects of which upon the transverse and tensile strength of cast iron and steel are remarkable. He claims an increase of 20 to 25 per cent. in the transverse and 20 to 30 per cent. to the tensile strength of cast iron by the addition of 0.1 per cent. of titanium to the bath of molten metal before casting. It also increases the elastic limit of steel. The effect is probably due to the expulsion of occluded gases, and the closing up of the grain of the metal.

Rossi's furnace, which is square in section, consists essentially of a graphite crucible with a tap hole leading from the bottom. The crucible itself is connected by a bus-bar with the electric supply, and thus forms one of the electrodes. The other electrode is a carbon block suspended within the crucible, so that it can be raised and lowered by mechanism above. Such a furnace $3\frac{1}{2}$ feet high and 4 feet

square will absorb 150 kilowatts at a pressure of from 20 to 100 volts. The shell of the furnace is made of iron plates, and is lined with graphitic material.

The smelting mixture for ferro-chromium consists of chrome iron ore and carbon, and is fed in at the top. The arc is struck by lowering the electrode to make contact and then raising it again. The charge is added at intervals, and when sufficient metal has collected it is tapped out. Any slag that may collect is run away by another opening, the charging is continued, and more metal collects. The process is practically a continuous one. The richness of the alloy depends upon the proportions of the mixture. Thus if chromium oxide only is used, chromium free from iron is obtained. Rossi makes ferro-chromium containing up to 78 per cent. of chromium, and from 6 to 7 per cent. of carbon; but he is able to remove the greater part of the carbon by the addition of oxides to the furnace before the metal is tapped. A very oxidising slag is thus formed, and much of the carbon is oxidised and removed. The lower limit, however, appears to be from 1 to 2 per cent. carbon.

But alloys practically free from carbon can be obtained by using a bath of aluminium for the reducing agent. Scrap aluminium is melted in the furnace, and the oxides added carefully on account of the great heat developed by the reduction. The whole of the aluminium may be oxidised, and thus prevented from contaminating the metal by the addition of sufficient oxide, and the judicious use of the current. The change is expressed thus:—

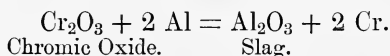

The metal is tapped in the usual manner, and is found to contain very little carbon, but is not free from that element, as it is in contact with the carbon walls of the crucible. A better method would be to use a furnace of the Kjellin

type. The aluminium could then be melted, and the oxides reduced without any risk of contamination with carbon.

The Keller Furnace is more complicated than the one described above, and for some purposes more efficient. It consists of a number of hearths connected together, and capable of being worked together. In the vertical section, Fig. 86, two vat-shaped hearths are shown connected together by a central well, in which the reduced metal or alloy collects together with any slag that may form.

The carbon electrodes A, B, which are connected with the alternator, serve for the passage of the current into and out of the furnace. The smelting mixture is fed into the top of each hearth, and gradually works down as it is reduced. The circuit is made by the two electrodes and the material between them, and the

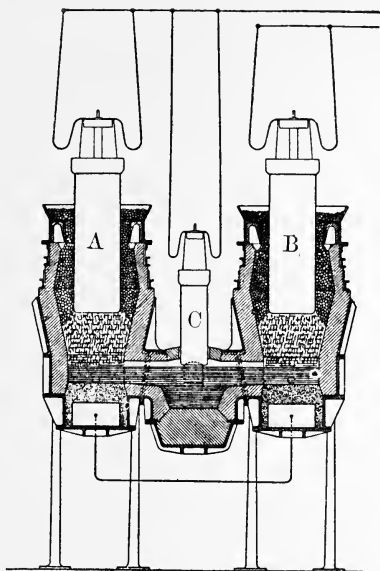

FIG. 86.—The Keller Furnace.

heat is furnished by the resistance of the latter as the current passes to and fro in it. The central electrode C is for heating the contents of the well should the temperature fall too low. It can be put into use at any time by lowering, and then raising it so as to form an arc with the contents of the well. When the metal is tapped the level falls, and the circuit is more or less broken. This interferes not only with the working of the furnace, but also with

that of the alternator, which is bad for both. To obviate this carbon blocks are built into the bottom of each hearth, and are connected together by copper rods, which gradually take up part of the load as the level of the metal sinks in the well. As the level of the metal rises again they are gradually put out of action, and the load taken on by the furnace charge.

One important feature of this furnace is that the products of reduction are removed from the zone of highest temperature as they form, and collect in the well. This proves very useful in the production of ferro-silicon.

Ferro-Silicon.—The melting charge used by Keller for the production of this useful alloy consists of crushed quartz, scrap iron, and coke. The silica is reduced by carbon in the presence of iron, and the silicon passes into the metal. In the reduction of silica by carbon there is a tendency for the reduced silicon to unite with carbon to form the carbide known as carborundum, and this tendency increases as the temperature rises, but it is found that the rapid removal of the silicon from the zone of highest temperature enables the nearly pure element to be obtained, and very little reaction with carbon takes place. Thus ferro-silicons containing up to 98 per cent. silicon are by no means rare, but the poorer varieties are mostly produced. There is a tendency for the rich alloys to disintegrate on exposure to the air, and this is not in their favour. Keller states that with electric energy equal to 10,000 h.p. he could produce 30 tons of 30 per cent. ferro-silicon per day.

The tungsten, molybdenum, vanadium alloys are prepared in a similar manner by smelting their oxides with iron oxide, or iron-producing material and carbon. The oxides are prepared in a fairly pure condition by taking advantage of the fact that they combine with the alkaline oxides, soda and potash, to form soluble compounds. The ores of the

metals are concentrated as far as possible by crushing and washing, and then roasted with free access of air to remove volatile bodies, such as sulphur and arsenic. The roasted product is then melted with carbonate of soda. The mass is crushed and treated with water to dissolve out the soluble matter, which contains the oxide of the metal under treatment. The solution is acidified with sulphuric acid, which takes up the soda and precipitates the oxide. This is then collected and dried, when it is ready for the electric furnace. When a reducible metal, such as lead in vanadate of lead, is present, coal is added in addition to the carbonate of soda for the smelting, and the lead is obtained in the metallic state. The alloys of these metals are of great importance, as they are used in the manufacture of special steels. (*See* Chap. XIV).

Electric smelting has been carried on in Canada, but is more or less in the experimental stage, although it is proved that the processes can be made commercially successful. It is largely the outcome of the visit of a Government Commission to Europe some three years ago to investigate these smelting processes generally.

In 1904 Mr. E. A. Sjöstedt, of Sault Ste. Marie, Ontario, conducted some very successful experiments for the production of ferro-nickel from a nickeliferous pyrites. The ore was roasted down to 3 per cent. of sulphur and then smelted in admixture with lime and ground coke in a rectangular furnace lined with magnesite bricks. The lower electrode consisted of a thick carbon rod running the full length of the bottom, and the upper electrode of a number of rods arranged in a row directly over the lower one. The furnace was worked with 1,350 amperes at a pressure of 80 volts, or 108 kilowatts, and had an output of 13 cwts. of the alloy per 24 hours. The slag notch and tap hole were at opposite ends of the furnace.

Dr. Haanel also conducted some experiments at Sault Ste.

Marie in 1906 under Government auspices. The chief object of these experiments was to prove whether the principal Canadian ore, magnetite, could be successfully treated in the electric furnace, and whether roasted iron pyrites could be smelted for the production of pig iron practically free from sulphur. The conditions are: abundance of ore, wood for charcoal, and water power.

The furnace used is circular in section, and consists of of an iron shell the bottom of which is lined with a thick hollowed-out block of compressed carbon to form the hearth, and the sides with firebricks. The internal dimensions are 3 feet 9 inches deep and 2 feet 9 inches wide. The hearth serves as the lower electrode, and the upper electrode consists of a carbon block so suspended that it can be raised or lowered in the furnace at will. The shell is made in two semi-circular parts which are joined together by copper strips. This prevents the formation of a magnetic circuit with its consequent loss of energy. The current is furnished by a water-driven alternator at 2,400 volts, and reduced to 50 volts by a transformer. The energy absorbed by the furnace when working is about 230 e.h.p. Accurate measuring instruments were used in the experimental runs, and every precaution taken to determine the actual cost of working.

The charge consisted of ore, charcoal, and flux, the nature of the latter depending upon the gangue to be removed. Limestone is the common flux, but sand is sometimes required.

The composition of samples of the pig iron and slag is shown by the table on the next page.

Carbon monoxide is formed during the reduction, and attempts were made to utilise it for pre-heating the charge in the furnace, but with indifferent success. There is no doubt, however, that it could be drawn off and used for heating purposes outside the furnace itself. The tests

were so satisfactory that a larger and more complete plant should have a successful career.

Smelting Ores.—In Brazil a high grade ore can be delivered near a water-power station at 10s. 6*d.* per ton, and mild steel can be produced from it at a cost of 6s. per ton for electrical energy. The price of coke in the district is 48s. per ton, and there is a prohibitive tariff on imported iron. A smelting plant at this place should clearly be a huge success.

There is not the slightest difficulty in the reduction of iron ores in the electric furnace. It is simply a matter of

Grey Pig Iron.	Slag.
Carbon 4.65	Silica 35.84
Silicon 1.41	Alumina 31.80
Phosphorus 0.012	Lime 14.39
Sulphur 0.024	Magnesia 16.22
	Sulphur 0.26
	Iron 0.35

cost, and it would appear that it is only in special cases that the electric furnace could possibly compete with the modern blast furnace. For refining processes on the large scale in the open hearth it is simply the question of price of electrical energy against the price of producer gas, for little difficulty would be encountered in the electrical heating of furnaces of 50 tons capacity and upwards. But it is in the use of blast furnace gas as a source of electrical energy for the production of high grade steel and ferro-alloys, that the first advances will be made away from the water power districts.

Hérault, Keller, Stassano, Gin, and others have proved the practicability of obtaining either pig or refined metal direct from the ore by electrical heating, but at present their

apparatus is more economically engaged in the production of high grade steel and ferro-alloys. Keller's experiments lead to the conclusion that the ore can be smelted, the pig refined, and the ingots reheated for the mill. For the carbon monoxide liberated during the reduction of the ore is sufficient to work a reheating furnace.

In districts where water power is not available, but where supplies of raw materials and fuel can be readily obtained, the ideal iron and steel works should be self-contained. Take a case with which the writer is acquainted. After the expenditure of much labour and capital, blast furnace gas is being used direct in gas engines, and about 4,000 h.p. is being so developed. Now, what is to prevent the installation of say the Hèroult and Keller processes for the production of high grade steel and ferro-alloys in this and similar works? It will come in time, and it is to be hoped that some at least of the pioneer work will be done in this country, and not left to Germany and America.

Electric welding forms part of the electrical treatment of metals, and may be effected by either "arc" or "resistance" heating. In welding by the arc the work is connected with the positive lead and thus forms the positive electrode, while the negative electrode, a carbon rod, is held by the workman. With a pressure of 110 volts and a good supply an arc two inches long is formed between the work and the carbon, so that the metal is rapidly softened, and can then be worked together by a former. Flanges are welded on to solid drawn steel tubes by this method. Resistance welding machines are transformers in principle, in which heavy alternating currents of low pressure pass through the junction of the pieces to be welded, and the heat generated there softens the metal, while the machine exerts the necessary pressure to effect the weld. Tramway rails are sometimes welded together in this way.

CHAPTER XIV.

SPECIAL STEELS.

THE rapid increase in the world's output of iron and steel and their very much extended use for a variety of purposes, evidently demanded more rapid methods of dealing with large pieces in the finishing processes. Both forgings and castings have to be turned, planed, and milled in a variety of ways, and an increase in the rate at which they can be dealt with on the lathe or machine is of considerable importance.

One of the principal difficulties in the way of rapid working with ordinary carbon steel tools, is due to the rapid conversion of mechanical energy into heat. This development of heat takes place near to the cutting edge where the work is being done, and if it goes on too rapidly the tool may be raised to a temperature above that at which its hardening carbon passes into the cement form. This would soon soften the tool, and put it out of action. The tool may be flooded with some cooling liquid while it is at work, but even then the speed limit appears to be only 30 to 50 feet per minute.

Self-hardening Steels.—The first step in the direction of increasing the speed of working was made by R. Mushet, in 1868, when he introduced the self-hardening steel known by his name. This steel is an iron-manganese-tungsten alloy, which did not receive the attention it deserved, as all its properties were not understood, even by Mushet himself. It should be mentioned, however, that Mr. Jacobs and Dr. Koeller, in 1855, drew attention to the effect of tungsten in

closing the grain of steel and rendering its fracture silky. The steel, as made by Mushet, has been largely used in the working of hard metals on account of its increased hardness and resistance to shearing stress. By self-hardening, it is meant that the steel may be made to sustain a cutting edge by proper heat treatment without the quenching necessary for carbon steel. Thus, if a tool is raised to a medium orange heat, and then allowed to cool naturally, it is ready for use. The important function of the tungsten is to keep the carbon in the hardening form at a comparatively high temperature, and so prevent softening, while the self-hardening property appears to be due almost entirely to the presence of sufficient manganese. In the absence of this element the tungsten-carbon-iron alloy has little or no self-hardening properties, but requires to be quenched in the ordinary way. Oil or water hardening, however, renders these steels excessively hard and brittle, so that even if they do not crack in the process, they are practically useless. The method of annealing them is to heat to a bright red heat for about 24 hours, and then cool slowly in hot sand or ashes. Some brands can be annealed by heating to a dull red heat, and then quenching in water. This is remarkable, but at the same time effective. The composition of some of these alloys is given in the following table :—

SELF-HARDENING OR MUSHET STEELS.

Carbon . . .	1·67	2·30	2·05	2·00	2·35
Silicon . . .	0·38	1·05	0·79	1·60	0·15
Manganese . . .	2·53	2·57	2·30	1·72	3·38
Tungsten . . .	5·47	6·12	8·04	8·22	11·02
Phosphorus . . .			0·04	0·04	
Sulphur . . .			0·04	0·02	

When the tungsten does not exceed 3·5 per cent., and the manganese 0·5 per cent., with low silicon, the steel can be

hardened by water-quenching in the usual manner. But such steels are expensive, and do not possess any particular advantage over good carbon steel. Chromium in small quantity is also found in some varieties of self-hardening steels.

The proper heat treatment of carbon steel is most important, for comparatively slight over-heating deteriorates the metal, and the higher the carbon the greater the care required. This was thought to be true also of the tungsten alloys, but Messrs. Taylor and White made a most important step forward when they proved that steel containing tungsten could be heated near its melting point and then quenched in a blast of air without deterioration. Further, that a tool treated in this way could be worked at a higher speed without softening. In fact, such a tool can be worked at a temperature that would render ordinary steel perfectly useless. It is said to be "red hard," that is, it retains its normal hardness at a red heat. The cutting speed can thus be increased up to 500 feet per minute if necessary, but the usual speeds are much less than this, or about 150 feet per minute. The Bethlehem Steel Company gave a demonstration of high speed turning at the Paris Exhibition of 1900, and since then many steel makers have turned their attention to this most important subject. Mr. J. M. Gledhill, of Messrs. Armstrong, Whitworth and Company, has investigated the composition and properties of these alloys, and the "A.W." high-speed steel, manufactured by the company, is justly celebrated. The elements so far used in the production of these steels are tungsten, chromium, molybdenum, and vanadium, together with the elements usually present in ordinary steel, and some of these alloys contain as much as 30 per cent. of matter other than iron. Mr. Gledhill states that the alloys are best made from cemented Swedish bar, and this is the orthodox method in this country for producing

the best brands. American authorities, however, are of opinion that any equally pure, uncemented bar can be used, and much of the American high speed steel is quite innocent of anything Swedish. The principal reason for the use of Swedish iron in this country is that much of our own marked bar is hardly pure enough for the purpose; but it is said that in spite of the demand for H.S. (high speed) steel the market for Swedish bar in Sheffield is not particularly brisk.

The ordinary crucible method of manufacture is used, and the necessary proportions of the ferro-alloys are added to the crucible charge of converted or unconverted bar. More care must be taken in the melting and a longer time is required in order to obtain the alloy in a perfectly homogeneous condition. Many of the imperfections of high speed steels of which users complain are due to imperfect alloying. The pure metals themselves could not very well be used, even if they could be produced cheaply, on account of their high melting points. As the ferro-alloys are made for the most part in electric furnaces, it is probable that H.S. steel will also be produced in them, and it is difficult to understand why this should not be, for excellent carbon steel is so made, and it would only be a matter of working the bath of steel down to the proper content of carbon, and then adding the necessary ferro-alloys. Both the Héroult and the Kjellin furnaces should give good results.

Most of the methods of making particular brands are supposed to be secret, but the following details of a process by which a high-class steel is made is a refutation of the statement that only Swedish bar can be used:—

70 lbs. of scrap tool steel, 9 lbs. ferro-chromium, and 14 lbs. of ferro-molybdenum are melted together in a crucible. When the charge is thoroughly molten 170 lbs. of molten steel from a Tropena converter is added to it, together with $\frac{1}{4}$ lb. of aluminium. The full charge, when ready, is

teemed into moulds and cast into ingots 4 inches square, ready for the usual mechanical treatment. The finished steel contains 3 per cent. of chromium and 3 per cent. of molybdenum, while the carbon varies from 0.75 to 0.9 per cent.

The ingots of H.S. steel are reheated to a temperature depending upon their composition, and are then clogged down under a steam hammer. When cold, the bars are examined to detect any defects, reheated, and tilted under small hammers, or rolled, into the required sections. These are then very carefully annealed to get the metal into the best condition for working up into tools, and to eliminate the internal strains set up during the tilting. The tools made from these steels should be annealed after they have been shaped, preparatory to being hardened. This is most necessary for complicated tools such as milling cutters, upon which much labour has been spent. The internal strains are thus relieved, and the tool has a much better chance of surviving the hardening process.

It may be thought that H.S. steel requires less skill in hardening than carbon steel from the fact that it can be raised to a much higher temperature without injury, but this is not so, for special precautions must be taken in the high heating and subsequent cooling. The prescribed treatment is to heat slowly up to 812° C. (a full cherry-red); to heat rapidly to just below the melting point (a full white); to cool rapidly to below 840° C.; and to cool slowly or rapidly to the temperature of the air. In the low heating, or tempering, the steel is raised slowly to 612° C. and kept at that temperature for five minutes; it is then cooled rapidly or slowly. A double muffle furnace, in which the upper chamber is kept at about 812° C., and the lower one at a full white heat, gives excellent results for the high heating. The tools are put on the top of the muffle to warm, transferred to the upper chamber to soak,

and then to the lower chamber for the final heating. The rapid cooling is usually effected in a blast of cold air; but a lead bath is also used for the same purpose. The low heating is best carried on in a lead bath kept at a temperature of 612° C.

Makers, however, usually issue instructions with their steels, and these should be faithfully followed if the metal is to have a fair chance of doing the work for which it is intended. Maltreatment of steel by the user is the steel maker's greatest source of trouble. High speed steels may be described as iron-chromium-tungsten alloys, but molybdenum and vanadium are also introduced. Professor Howe thinks that efforts should be made to utilise the more abundant elements in their manufacture, as the supply of these rare elements cannot be great, and may only last for a generation or so.

The following table contains a list of the elements found in various high speed steels:—

HIGH-SPEED STEELS.

	English.				American.	
Carbon, C.	1·00	0·98	1·85	0·75	0·674 ¹	1·13
Silicon, Si.	0·06	0·24	0·15	0·15	0·043	0·64
Manganese, Mn.	0·50		0·15	0·28	0·110	
Chromium, Cr.	3·00	3·10	2·00	3·00	5·470	3·40
Tungsten, W.		7·41	8·50		18·190	
Molybdenum, Mo.	6·00			3·00		3·90
Vanadium, V.					0·290	

Molybdenum has the same general effect as tungsten, but is more active. Two per cent. of the former is said to

¹ One of the latest, and, according to Taylor, one of the best, American H.S. steels.

be equal to 8 per cent. of the latter. Also, the steel only needs to be raised to a temperature of $1,000^{\circ}$ C. before being air quenched.

It will be seen from the above table that the alloys vary very much in composition, which is no doubt largely due to the endeavours of the various makers to produce alloys suitable for different purposes, and for undergoing varying treatment in preparing them for use.

The advantages due to the presence of tungsten and molybdenum are, however, quite evident, but it will be noticed that the influence of these elements is always exerted upon the iron in the presence of carbon. H.S. steels of any value contain sufficient carbon to harden the iron in the absence of the other elements. The influence of these elements during the heat treatment of the alloys has been studied by Le Chatelier, Carpenter and others, and appears to be of a moderately simple character. The temperature range in which martensite, the hard solid solution, is changed into pearlite, the soft eutectoid, is either split into parts, or extended downwards, so that the martensite is, in part at least, preserved down to the temperature of the air. The alloy is, therefore, hard, although it has not been quenched like a carbon steel. Also, according to Le Chatelier, on reheating hardened steel, the martensite begins to segregate at 200° C., and tempering takes place at that temperature; but with the H.S. steel the segregation does not commence until the temperature reaches nearly 600° C. The result is that this steel will preserve its hardness and "stand up" to its work even when it is red hot. When, however, the steel is raised to 700° C. it softens, that is, the carbon change takes place, and the softening goes on up to a temperature of 850 to 900° C., but this temperature must not be exceeded in annealing. Raised to $1,000^{\circ}$ C., or above, hardening again takes place. Ease in hardening and resistance to

tempering may be described as the characteristics of these alloys.

Many practical men still doubt the ability of H.S. steel to take finishing cuts at a high speed, but Gledhill states that an excellent finish can be obtained with proper tools suitably arranged. Thus a rolled bar can be finished with a good bright surface, and guaranteed to 0.002 inch at one cut.

The steel for chipping chisels has its wearing property much improved by the introduction of 0.25 per cent. of tungsten; and an excellent steel used for making permanent magnets contains from 5 to 6 per cent. of that element.

An important series of experiments were carried out during October, 1903, at the Manchester Technical School under the auspices of the Manchester Association of Engineers, and a detailed account of them published in "Engineering" for April 3rd and 16th, 1904. Makers were invited to send their special brands to be tested in the presence of their own representatives, and tools made from the best steels on the market were used in the trials. These comprised tests of endurance, speed, weight of metal removed, area machined, depth of cut, traverse per revolution, power absorbed, and condition of the tool at the end of the trial. The most important result of the investigation is that the same steel is not suitable for every purpose to which high speed steel can be put, and the user must trust to the maker to supply him with suitable steel for a particular tool. Large makers take every precaution, and have special shops fitted with the various means of testing the steels they supply. Such well known brands as Ajax, A.W., Novo, and Speedicut are guaranteed to do certain kinds of work, and can be depended upon.

A number of these steels were tested for drilling, boring, and turning by a Birmingham engineering firm noted for its accurate work, and it was proved that they were all

superior to carbon steel for the particular work they were put to do. The life of a drill was 10 times, of a borer 5 times, and of a turning tool 3 times that of the ordinary steel tool. Hard, medium and mild steels were all worked by the tools. As an example of possibilities, a punch $\frac{3}{4}$ inch diameter punched 56,000 holes in structural steel as against 5,600 punched by an ordinary steel punch of the same dimensions.

Manganese Steel.—Manganese in small quantity is always present in ingot steel, but seems to have no decided influence on the metal when under 1 per cent. This is probably due to its being engaged in neutralising the effects of impurities, and preventing red shortness. The general effect of larger quantities is to harden the alloy and make it brittle; but this is not a cumulative effect, for the brittleness increases until the alloy contains between 4 and 5 per cent. of manganese, and then decreases as the percentage of the metal increases up to 10 per cent. Alloys containing between 2.5 and 7.5 per cent. manganese are practically unworkable; while alloys containing about 20 per cent. of manganese resemble cast iron. The useful proportions seem to lie between 8 and 15 per cent. A peculiarity of these alloys is that when heated to about 1,000° C., and quenched in cold water, they are softened and toughened. They can be forged, but are so hard when cold that they can be machined only with great difficulty, which considerably reduces their usefulness. Most of the information regarding these alloys is due to Mr. Hadfield, of Sheffield, who has thoroughly investigated their properties. The well known Hadfield manganese steel contains about 13 per cent. manganese and 1 per cent. carbon, and has a tensile strength of upwards of 60 tons per square inch; while the elongation is nearly 50 per cent. The tensile strength and ductility of these alloys are increased by heating to a white heat, and quenching in cold water. Manganese steel cannot

be magnetised, and, unlike carbon steel, cools from a red heat without showing any sign of recalescence. It is used principally for rock crushing machinery, railway and tramway crossings, and safes, its great hardness and ductility rendering it most suitable for these purposes.

Nickel Steel.—The metal nickel is now put on the market in a nearly pure state, and is used for a variety of purposes, one of which is to alloy with iron in the manufacture of nickel steel. Either the metal itself or the rich alloy of ferro-nickel may be employed, and must be added to the charge in the furnace on account of its high melting point. Also it is necessary to add ferro-manganese at the end of the process, as nickel is much the same as iron in requiring a deoxidising agent. The alloy is cast into ingots in the usual manner. For special purposes this open hearth product may be re-melted in crucibles, and thus rendered more uniform.

The general effect of nickel on the steel is to harden it, but not to the same extent that carbon does; it also increases the tensile strength and elastic limit of the alloy without seriously reducing its elongation under tensile stress. Such a steel possesses properties well suited for making forgings for engine parts that require great tenacity and high elastic limit combined with sufficient ductility to prevent them giving way under dynamic stresses. By using this alloy the weight of metal in the parts may be reduced with safety, which is sometimes of more importance than the mere cost of the metal when lightness combined with strength is required. About 12 per cent. of nickel appears to be the limit for useful work, but the actual proportion of nickel depends upon the purpose to which the alloy is to be put.

The following table is abbreviated from the table recording Hadfield's experiments with a series of nickel steels:—

Carbon.	Manganese.	Nickel.	Breaking stress in tons per square inch.		Elastic limit in tons per square inch.		Elongation per cent. on 2 inches.		Reduction of area per cent.	
			Unannealed.	Annealed.	Unannealed.	Annealed.	Unannealed.	Annealed.	Unannealed.	Annealed.
0·14	0·75	0·27	31	28	19	20	35	37	56	52
0·13	0·72	0·95	33	27	25	20	31	41	53	63
0·19	0·65	3·82	37	33	28	25	30	35	54	55
0·17	0·68	7·65	49	45	31	30	26	26	42	41
0·18	0·93	11·39	94	89	65	45	12	12	24	26
0·19	0·93	19·64	91	87	47	45	7	5	6	4
0·14	0·80	29·07	38	37	25	16	33	48	44	51

It is seen from the table that the breaking stress and the elastic limit increase with the content of nickel up to 11·39 per cent., and then decrease. Also that these two factors increase in greater proportion than the elongation and reduction of area decrease. Now, since the percentage elongation and the reduction in area, particularly the latter, are the measure of tensile ductility, it is clear that greater strength is obtained without any serious sacrifice of toughness; and these are the principal properties of a metal suitable for resisting comparatively small but alternating stresses such as occur in the moving parts of a machine. Thus it is largely used for shafting, connecting rods, crank pins, piston rods, railway axles, and tyres.

Nickel steel used for gun forgings and small arms barrels contains about 0·2 per cent. of carbon and 3 per cent. of nickel. Reference to the table will show the value of such an alloy for this purpose.

Steel containing about 2 per cent. nickel, 1 per cent. chromium, and 0·4 per cent. carbon is being largely used for armour plates and armour-piercing projectiles. Nickel steel containing less than 1 per cent. of nickel can be

welded as readily as ordinary steel, but with higher percentages the welding properties decrease, and great care is required even with the 3 per cent. alloy. The probable cause of this is the tenacity with which the mixed oxides seem to cling to the heated surface, so that they are not completely removed by the fluxes. According to some authorities the presence of nickel in the higher carbon steels causes a lowering of the recalescence point, so that such steels can be both annealed and hardened at lower temperatures than the corresponding carbon steels.

Vanadium Steels.—As already mentioned, vanadium is sometimes used in the composition of H.S. steels, but it does not appear to be of much importance in this connection. Although, like other elements, it may be widely distributed, it does not occur in sufficient quantity to bear any great drain on its supplies. Its usefulness seems to lie more in the marked influence it exerts upon ordinary open hearth steel when introduced in small quantities, together with chromium. The effects of this combination on the physical and mechanical properties of constructional steel have been under careful investigation for several years by Captain Sankey, Mr. J. Kent Smith, and others, and their tests point to the very great importance of vanadium-chromium steels for constructive material that is to be exposed to dynamic stresses. The following tensile tests, in which open hearth steel with and without vanadium are compared, are given by Mr. Kent Smith:—

	Tenacity in tons per square inch.	Elastic limit in tons per square inch.	Elongation per cent. on 2 inches.	Reduction of area per cent.
Open hearth steel .	32·2	17·7	34	52·6
Open hearth steel, with 1 per cent. chromium and 0·15 per cent. vanadium	52·6	34·4	25	55·5

The results of these tests show clearly the reason for the great improvement in the mechanical properties of the steel claimed by the makers. Mr. Smith is of opinion that the reduction of area is a more reliable test of ductility than the elongation, and in this case it is seen that with a large increase in the breaking stress and elastic limit the ductility is also increased. This is very remarkable, and if it will stand the test of experience, an alloy unrivalled for a variety of purposes is at hand. The largest makers in this country at present are Messrs. Willans and Robinson, and they are said to be exporting their products, which are almost entirely used in the motor-car industry. The alloy is also found to give excellent results when case-hardened, for with care a glass hard surface on a tough core can be obtained.

GLOSSARY

ACIDS.—The name given to a class of compounds which, when soluble in water, furnish solutions having a sour taste, and capable of turning vegetable colours red. They react with bases to form salts by which their acid properties are neutralised. Some acid-forming oxides are insoluble in water, but may be neutralised by fusion with basic oxides, as in the case of silica.

AFTERBLOW.—The term used in basic Bessemer practice to indicate the part of the blow after the removal of the silicon and carbon, during which the greater part of the phosphorus is oxidised and passes into the slag.

ALLOTROPY is the capability of some elements to possess different physical properties while existing in the same physical state. This is due to variations in the number or arrangement of the atoms in the molecules of the element, or of the grouping of the molecules themselves, by which the internal energy is increased or decreased. When an allotropic change occurs it is always accompanied by a change in the internal energy, and takes place at a critical temperature.

ALLOY.—A mixture of metals which is homogeneous when fluid, and when solid possesses the physical and mechanical properties of a metal. Rich iron alloys are often prepared direct from materials containing their constituent metals, and these products are used in making alloys for industrial

purposes. The term is sometimes applied to the combinations of iron with carbon and other non-metals when a large excess of iron is present.

ARREST.—This term is used to denote a stoppage in the cooling or heating of a body, which is due to an internal change taking place by which sufficient heat is developed or absorbed to counterbalance that lost by radiation from the body, or gained from the source of heat. The duration of the arrest depends upon the magnitude of the internal change. In the heat treatment of iron and steel Ar. denotes arrest of cooling, and Ac. denotes that of heating. These arrests do not take place at the same temperature for a given internal change on account of the “lag” or disinclination of the metal to change its state. Thus Ar. is always below and Ac. above the critical point.

ATOMIC THEORY.—This conception in its modern form was enunciated by Dalton in 1808. It has since been modified to include the idea of molecules, and has rendered great service in the development of theoretical chemistry. Recent investigations in physical chemistry seem to indicate that atoms are not the smallest possible particles of elements, but are built up of still smaller particles called “electrons” when charged with electricity, or simply corpuscles when not charged.

AUSTENITE.—The name given to a constituent of hardened steel in honour of the late Sir W. Roberts-Austen.

BASIC.—This term refers principally to the chemical properties of the lower oxides and hydroxides of the metals, by which they are able to react with acids, or acid-forming oxides, to form salts. The properties of both are merged into those of the salt, which has distinctive properties of its own. Basic oxides soluble in water give solutions that turn red litmus blue, and have a caustic action on the skin. Basic materials contain an excess of basic oxides.

CEMENTITE is the name given by Howe to the carbide of iron

Fe_3C , present in steel and cast iron, either in the free state or in the eutectoid pearlite. It furnishes the combined carbon in any of the normal forms of iron and steel containing that element.

CHEMICAL EQUIVALENTS are experimental numbers obtained by determining the weights of the various elements which unite with a fixed weight of one element. The numbers are sometimes obtained indirectly, and all are compared with $\text{H} = 1$.

COLD SHORT is applied to iron and steel which cannot be hammered or rolled cold without cracking. Phosphorus is the most hurtful impurity in this respect.

CRITICAL POINT or **CRITICAL TEMPERATURE**.—This is for a given change a definite temperature or range of temperature at which or within which the change takes place. When the range extends over several degrees of temperature it is sometimes called a zone.

CRYSTAL GRAINS.—Fragments of crystals with their faces and angles either absent or but imperfectly developed.

CRYSTALS.—A fully developed crystal is a solid of definite geometrical form usually bounded by planes which join each other and form solid angles. These angles are invariable for a particular crystalline form which enables crystals to be recognised, and classified into systems. Iron in common with other metals crystallises in cubes, and so belongs to the cubic system. Ferrite grains are more or less cuboidal in form.

CURVES.—When there are two variables connected with a change, and they can be measured as the change proceeds, the change may be represented by a diagram. The variables are measured on two reference lines or co-ordinates, which are usually at right angles, and cut each other in a point called the origin, see Fig. 73. Thus if the variables are time and temperature, as in cooling, the temperature, at a given moment, can be indicated by a point on the

vertical reference line, or on any line parallel to it, and the time on the horizontal line, or any line parallel to it. Therefore the temperature of the body at any given time will be represented by a point on the surface where these lines cut. Thus by noting the temperature of a cooling body at equal intervals of time, plotting the points on the diagram and joining them, a continuous line is obtained. If the fall in temperature is strictly proportional to the time the line will be straight, but if not it will be curved. Cooling, stress and strain, etc., may be represented graphically in this way, and the greater the number of points determined the more accurate the curve will be.

DYNAMICS.—The branch of mechanical science that deals with bodies in motion.

ENDOTHERMIC as applied to chemical change denotes that as the change takes place heat is absorbed into the reacting system, and unless heat is supplied from outside the temperature of the system will fall below that at which the change is possible. The temperature must therefore be maintained above this critical point if the change is to go on.

ETCHING.—The name given to the differential action of a solvent liquid, or other agent, on a surface not perfectly homogeneous.

EUTECTIC is the general term used by Guthrie to denote a mixture of two substances having a lower melting point than any other mixture of the same two bodies. Among the mixtures of two metals the one containing the eutectic proportions is the eutectic alloy. When solid it is called the eutectic mixture, and when liquid the eutectic solution. If the melting points of a series of the alloys of two metals are plotted on a diagram the lowest point on the curve indicates the melting point of the eutectic alloy, and a horizontal line drawn through this point is termed the eutectic line. See Fig. 74.

EXOTHERMIC.—The large majority of chemical changes are such that heat is developed as they proceed. When once in progress the change goes on as long as the reacting bodies are present in the system. As heat is constantly leaving the system the change is regarded as a source of heat, or exothermic.

FERRITE.—The name given to pure iron as it is seen in cuboidal grains under the microscope, and to carbonless iron, which may contain silicon, manganese, etc., in solid solution. In the case of silicon it may be called silico-ferrite.

FLUX is the general term used to denote the solid material added to a smelting mixture to remove the earthy matter as a fluid slag. A basic flux is required for an acid gangue, and *vice versá*. Lime, magnesia, alumina, and oxide of iron are the common basic fluxes used on the large scale; but soda and potash, as carbonates, are used for assays. Silica or siliceous matter is the acid flux, but borax is often used on the small scale.

FUSIBILITY expresses the fact that a body can pass from the solid to the liquid state when heated, and the more readily it fuses the more fusible it is said to be. Some bodies have definite fusing points, that is, the temperature range within which they are both solid and liquid is a comparatively short one. The metals are good examples of such bodies. On the other hand, slags and similar bodies have no definite fusing points, for they pass through a long range of temperature without any decided arrest, such as is present in the heating curve of a metal.

HARDENITE.—A term used by Charpy and Howe to denote the solid solution of iron and carbide containing 0.9 per cent. of carbon.

HELICAL (from *helix*, a spiral).—This is usually applied to pinions that come into action gradually with a sliding motion. The teeth are so formed that when one pair of teeth are parting company the next pair are just coming

- into contact, and the motion is uniform throughout. The bumping inseparable from heavy cog-wheels with few teeth is thus avoided.
- HYPEREUTECTIC** is used to designate steels containing more than 0.9 per cent. of carbon.
- HYPOEUTECTIC** is used to designate steels containing less than 0.9 per cent. of carbon.
- INTERPENETRATION** is a kind of mutual filtration of one substance into another. It is usually applied to the mingling of the particles of two solid masses in contact, to the passage of solid particles into a plastic mass, and of molten matter between the faces of crystals.
- METASTABLE** indicates the condition of a substance when its temperature is below or above that at which it should pass into another form, but is prevented from so doing by its own molecular inertia. In the case of allotropic change the metastable body is either above or below the transition point.
- NEUTRAL**, as applied to oxy-salts, means that the acid and basic properties of their constituent oxides have been completely merged into the properties of the salts. In the case of fire-resisting materials it means that they resist the fluxing action of acid and basic oxides.
- OCCCLUSION**.—When metals absorb gases and retain them in the solid state they are said to occlude the gases. As this gaseous matter is capable of reappearing with its original tension, it may considerably affect the mechanical properties of the metals, and is a constant source of blow-holes. Iron is capable of absorbing carbon monoxide, hydrogen, nitrogen, etc.
- PEARLITE**.—The name given by Howe to the pearly constituent of steel discovered by Sorby. It is the eutectoid of ferrite and cementite present in annealed steel, white cast iron, etc.
- RED SHORT**, as applied to iron and steel, means that the metal

is unworkable at a red heat. Copper, sulphur, and oxide of iron render the metal red short or hot short when present in sufficient quantity.

REGENERATION.—A term applied by Siemens to the restoration of heat carried away from a furnace by the gases on their way to the chimney. The heat is absorbed by refractory brickwork, reabsorbed by the entering gases, and so carried back to the furnace.

REVERBERATION is the beating back of the flame and products of combustion by a properly constructed roof to heat materials placed on the bed of the furnace. Radiation from the low roof also plays an important part in the heating.

RUSTING.—A term now generally applied to the surface changes taking place when a metal is exposed to the atmosphere. The change taking place is an oxidising one, and iron among the common metals is most prone to it. The protection of iron and steel from rusting when it is to be exposed to the air is of great importance. In most cases the film of oxide first formed protects the metal underneath from further action, but this is not so with iron, for the rusting eats right to the heart of the metal, so that the air must be entirely excluded for the protection to be effective. The means adopted depend upon what the metal is to be used for. The coating of tin on ordinary tin plate is very effective. To do this the iron sheets are carefully cleansed from scale by pickling in dilute sulphuric acid and scouring. They are dried by immersion in molten tallow, and are then passed through a series of pots containing molten tin, by which they are coated uniformly with a thin layer of the metal. In some cases the surface of the sheets is improved by passing them through rolls after immersion in the last tin pot. The zincing of sheets and pipes is also largely carried on for the production of galvanised iron. The operation is somewhat similar to the

process of tinning, for the surface to be coated is thoroughly cleansed from scale and the sheet plunged into a bath of molten zinc covered with sal-ammoniac. The zinc alloys with the iron and forms a good coherent coating, which is very effective unless the iron becomes exposed in any part. In that case the rusting is even more rapid than usual, due, probably, to electrical action. Iron coated with zinc by electro-deposition is now being put on the market under the name of Sherradised iron. In the Bower-Barff process the iron is first heated in the flame of producer gas, and then exposed to the action of superheated steam, by which a coating of the black oxide is formed on the surface and effectively protects it from rust. Painting, varnishing, and greasing are also resorted to for the prevention of rusting.

SEGREGATION.—The more fusible portions of alloys are driven inwards as the mass solidifies, and tend to accumulate in the part which solidifies last.

SOLID SOLUTION.—According to Van-t-Hoff a solid solution is a homogeneous mixture in the solid state, and may be either crystalline or non-crystalline in character.

SOLUTION.—A solution is a homogeneous mixture of two or more bodies in the liquid state which do not separate from each other under normal conditions.

STATICS.—The branch of mechanical science which deals with the action of forces on bodies at rest.

SURFUSION.—The condition of a liquid which has passed through its normal freezing point without becoming solid.

TEMPERATURE.—The condition of a body with regard to the tendency of heat to escape from it. The greater this tendency the higher the temperature is said to be. Solids and liquids that will withstand a high temperature become incandescent as their temperature increases, thus giving out light as well as heat, and the appearance

of a solid gives a rough indication of its temperature. Thus an incipient red heat is about 500; red, 700; bright red, 800—1,000; white, 1,300; dazzling white, 1,500° C.

THE EGGERTZ' TEST is a colour method for determining the percentage of combined carbon in iron and steel. The metal is dissolved in dilute nitric acid, and a solution having a brown colour is obtained. This is then compared with a similar solution in which the same weight of a standard steel has been dissolved. The standard solution is poured into a measuring tube and diluted with water to a known volume; the solution under examination is treated in the same manner, and diluted until the depth of colour in the two tubes is exactly the same. The volumes are then noted, and the assay is finished. The volumes are directly proportional to the percentages of combined carbon in the standard and in the sample, and since the one is known the other is easily calculated.

TRANSITION POINT.—The point through which a body passes on changing from one form or state to another as it is heated or cooled.

INDEX

A.

ABEL, Sir F., 277
Acid-forming oxides, 8
Acids, 8, 357
Afterblow, 74, 357
Air, variations in the, 92
Allen, 231
Allotropy, 286
Alloy, 357
Alloys, iron, 103
Alternator, 321
Aluminium in iron, 230
Ampere, the, 322
Annealing, 307
Anthracite, 24
Arnold, J. O., 230, 267, 272, 278
Arrest, 286, 358
Arsenic in iron, 283
Atmosphere, the, 11
 ,, composition of, 12
Atom, 4
Atomic theory, 4, 358
 ,, weight, 4
Austenite, 279

B.

BASIC, 358
 ,, bottom, 173

Basic lining, 172
 ,, materials, 46
 ,, oxides, 8
Batho furnace, 199
Bauxite, 48
Bedson, 248
Belgian mill, 247
Bell, Sir I. L., 63
Bellamy, C. V., 63
Bergman, 140
Bertrand-Thiel process, 211
Bessemer process, acid, 159
 ,, ,, basic, 170
 ,, slag, acid, 169
 ,, ,, basic, 177
 ,, steel, uses of, 181
Best tap, 133
Billet, 244
Black heart castings, 310
Blair process, 62
Blast furnace changes, 85
 ,, ,, charging, 91, 101
 ,, ,, gas, 91
 ,, ,, modern, 74
 ,, ,, plant, 85
 ,, ,, practice, 100
 ,, ,, slags, 89
 ,, ,, the, 68
 ,, hot, 93
 ,, pressure of, 96

- Blast stove, modern, 80
 ,, temperature of, 96
 ,, the, 79
 Blister bar, 143
 Bloom, 244
 Bloomery, American, 57
 ,, high, 58
 Blooming shears, 243
 Blooms, treatment of, 214
 Blowing cylinder, 83
 ,, engines, 83, 163
 Blue billy, 132
 Boilings, 131
 Breaking stress, 254
 Brinell, 307
 Bull dog, 132
- C.
- CALCINATION, 69
 ,, in kilns, 71
 ,, in stalls, 71
 Calcining kiln, 72
 Calcium chloride, 204
 ,, fluoride, 204
 Calorific intensity, 29
 ,, power, 24
 ,, ,, table of, 29
 Calorimeter, Berthelot - Mahler,
 27
 ,, Thompson's, 25
 Campbell tilting furnace, 205
 Carbon, allotropic modifications
 of, 286
 ,, dioxide, 7
 ,, monoxide, 7
 ,, solution of, in iron, 291
 Carbonate ores, 17
 Carpenter, 349
 Case hardening, 153
 Casting ladle, 178
- Castings, black heart, 310
 ,, malleable, 112
 Catalan process, 55
 Cementation process, 142
 Cementite, 276
 Charcoal, 31
 Charger, electric, 207
 Charging, cup and cone, 91
 Chemical equation, 6
 ,, equivalents, 4, 359
 Chenot process, The, 61
 Chocks, 238
 Chrome iron ore, 49
 Cinder, iron, 52, 57, 117, 131
 ,, notch, 77, 123
 ,, pig, 106
 Clay, 144
 ,, wheel forge, 216
 Clough, 134
 Coal, 22
 ,, sulphur in, 31
 ,, testing of, 24
 Cogging, 244
 Coke, 32
 ,, average composition of, 32
 ,, oven, 33
 Cold blast iron, 107
 ,, short, 359
 Combining proportions, 4
 Concentration, 73
 Converter, Bessemer, 159
 ,, bottom, 160
 ,, concentric, 161
 ,, eccentric, 162
 ,, Robert, the, 180
 ,, small, 178
 Cooling curves, copper and iron,
 285
 ,, ,, iron-carbon, 297
 ,, ,, lead-tin, 289
 ,, ,, salt solution, 291

Copper in iron, 288
 Cort, 119
 Cowper, 80
 Critical point, 359
 Crucible steel, 141, 145
 „ „ melting, 146
 „ „ uses of, 155
 Crucibles for steel melting, 146
 Crushing, resistance to, 261
 Crystal grains, 268
 Cup and cone, 91
 Cupola, foundry, the, 113
 Curves, 359
 Cylinder, the blowing, 83

D.

DALTON, atomic theory of, 4, 358
 Danks' furnace, 135
 Darby, 67
 Dellwik, 42
 Deoxidisers, 230
 Despretz, 324
 Dewar, 285
 Dick, 200
 Dolomite, 47
 Drop test, 265
 Ductility, 256
 Dud Dudley, 67
 Duff-Whitfield producer, 40
 Dust catcher, 76
 Dynamics, 360
 Dynamo, 319

E.

EASTWOOD, 134
 Eggertz test, 197, 365
 Ekman, 237
 Elasticity, 255
 „ modulus of, 256
 Elastic limit, 255

Electric furnace, steel making in,
 326
 Elements, table of, 13
 Endothermic, 37, 360
 Equalisers, 97
 Equation, chemical, 6
 Equivalents, chemical, 4, 359
 Etching, 271
 „ solutions for, 271
 Eutectic, 288
 „ alloy, 289
 Eutectoid, 298
 Exothermic, 361
 Eye, furnace, 78

F.

FERRITE, 275, 361
 Ferro-chromium, 103
 „ manganese, 103, 336
 „ silicon, 103, 338
 Féry, 318
 Fettleing, 124
 Firth, Messrs., 251
 Fleischer, 42
 Fluor spar, 204
 Fluxes, 85, 104, 361
 Foster, W. J., 95
 Foundry irons, analyses of, 108,
 109, 110
 „ practice, 110
 Fore plate, 123, 239
 Forge hardening, 304
 „ pig, 131
 „ rolls, 221
 Fuel, 21
 „ gaseous, 35
 Furnace, blast, 68
 „ charge, 88
 „ Danks, the, 135
 „ electric, 324

- Furnace eye, 78
 „ Hèroult, the, 327, 329
 „ Husgafvel, the, 59
 „ Keller, the, 337
 „ Kjellin, the, 330
 „ Muffle, 306
 „ obstructions, 99
 „ Osmund, the, 58
 „ Pernot, 136
 „ puddling, 123
 „ reheating, 222
 „ reverberatory, 119
 „ revolving, 135
 „ Stassano, the, 332
 „ tapping the, 97
 „ tilting, 205
 Fusibility, 361
 „ of silicates, 44
- G.
- GANGUE, 16
 Gannister, 46
 Gaseous fuel, 35
 Gases, occlusion of, 228
 Gas furnaces for puddling, 138
 „ Mond, 38
 „ producers, 37
 „ suction, 42
 „ waste, 80
 „ water, 38
 Gibbs, 295
 Gjers, 72
 „ soaking pits, 233
 Gledhill, J. M., 345
 Grant, Colonel, 63
 Graphite, 48, 279
 Gooseneck, 78
 Guides, 239
 Gysinge Bruk, 331
- H.
- HAANEL, Dr., 339
 Hadfield, 351 252,
 Haematite, brown, 17
 „ red, 17
 Hall, J., 122
 Hammer, helve, 214
 „ refining, 309
 „ scale, 133
 „ slag, 132
 „ steam, 218
 „ tilt, 215
 Harbord, 211, 235
 Hardening, 300
 Hardenite, 279, 361
 Harnet, M., 232
 Harrison, 97
 Harvey process, the, 154
 Hearth, Swedish Lancashire, 116
 Heat, dissipation of, 301
 „ refining, 309
 „ tinting, 273
 Helical pinion, 240, 361
 Hèroult process, 326
 Heyn, 281
 Hiorns, A. H., 275, 280
 Hot blast, 93
 „ „ theory of, 94
 Housing, 239
 Howe, 57, 167, 284, 298, 309, 348
 Huntsman, 145
 Husgafvel process, 59
 Hypereutectic, 362
 Hypoeutectic, 362
- I.
- INGOT metal, treatment of, 226
 „ moulds, 166
 Interpenetration, 362

- Iron, allotropic modifications of, 288
 ,, chloride of, 18
 ,, cold blast, 107
 ,, for the foundry, 108
 ,, making in Africa, 63
 ,, ,, ,, India, 52
 ,, mill, 216
 ,, ores, 16
 ,, ,, concentration of, 73
 ,, ,, distribution of, 19
 ,, ,, occurrence of, 16
 ,, ,, preparation of, 69
 ,, ,, table of, 21
 ,, pig, 104
 ,, pure, 1
 ,, pyrites, 17
 ,, red oxide of, 3
 ,, rusting of, 2
 ,, stone, blackband, 17
 ,, ,, clay, 17, 71
 ,, sulphides of, 17
- J.
- JOULE, 323
- K.
- KELLER furnace, the, 337
 Kent Smith, 354
 Kilowatt, the, 323
 Kjellin process, the, 329
- L.
- LA PRAZ, 328
 Ladle, casting, 164
 ,, tilting, 164
 Le Chatelier, 293, 314, 349
- Ledebur, 310
 Lens, 273
 Lester, I. E., 54
 Lignite, 23
 Limestone, 47
 Lining, basic, 172
 Loam moulding, 115
 Low Moor, 107
- M.
- MACHINE, casting, 102
 ,, slag, 98
 ,, tensile testing, 257
 ,, transverse ,, 262
- Magnesite, 47
 Magnetite, 16
 Malleable castings, 112
 Martin, E. P., 171
 Martensite, 278, 298
 Massel, 151
 Materials, refractory, 43
 Mechanical puddling, 134
 ,, treatment, 214
 Merchant bar, 221
 Metastable, 362
 Microscope, the, 273
 Mill, continuous, the, 242
 ,, furnace, the, 223
 ,, iron, the, 214
 ,, looping, 243
 ,, pull over, 240
 ,, reversing, 241
 ,, train, 225
 ,, three high, 242
- Miller, 68
 Molecule, 4
 Molybdenite, 49
 Mond gas, 38, 42
 Mould, ingot, 166
 Moulding, 114

Moissan, 285
 Molybdenum, 348
 Mushet, R., 157, 343

N.

NANIA BATHAN, 54
 Native, 16
 Neutral, 362
 .. materials, 48

O.

OCCCLUSION of gases, 228
 Ohm, the, 322
 Ohm's law, 322
 Oil baths, 306
 Open hearth process, 182
 pig, 196, 202
 practice, 198
 refining in, 195
 regenerative, 188
 slags, 196, 202
 steel, uses of, 213
 Styrian, 150
 tap hole, 184
 working a charge in,
 200
 Ore, non-phosphoric, 20
 .. phosphoric, 21
 .. winning the, 19
 Ores of rare metals, 49
 Osmond, 287, 293
 Osmund furnace, the, 58

P.

PEARLITE, 277
 Pernot furnace, the, 136

Peel, 190, 223
 Phase rule, the, 294
 Phosphoric oxide, 9
 Pickles, 134
 Pig bed, 98
 Pig iron, acid, 168, 196
 basic, 178, 202
 grading of, 106
 grey, 106
 hungry, 124
 mottled, 106
 Styrian, 152
 Swedish, 158
 white, 106
 world's output of, 107
 Pile, charcoal, 31
 Pinion, helical, 240
 Pipe, 227
 Plasticity, 45
 Plate rolling, 245
 Plumbago, 48
 Pottery mine, 133
 Press, forging the, 251
 .. Whitworth, the, 231
 Processes, Bertrand-Thiel, the, 211
 .. Bessemer, the, 156
 .. Blair, the, 62
 .. Catalan, the, 55
 .. open hearth, the, 182
 .. puddling, the, 119
 .. South Wales, the, 118
 .. Talbot, the, 209
 Producer, Duff-Whitfield, the, 40
 .. gas, 37
 .. Siemens, the, 39
 .. Wilson, the, 39
 Puddled balls, treatment of, 216
 .. bar, 221
 Puddling furnace, 123
 .. mechanical, 134
 .. process, 119

- Puddling process, changes in, 125
 " " modern, 122
 Pull-over mill, 240
 Pyrometer, radiation, the, 316
 " resistance, the, 312
 " thermo-electric, the,
 313
- Q.
- QUENCHING liquids, 300
- R.
- RAIL rolling, 245
 Recalescence, 288
 Red short, 362
 Reduction, 10
 Refining in the open hearth, 195
 Refractory materials, 43
 " " acid, 46
 " " basic, 46
 " " neutral, 48
 " " table of, 46
 Regeneration, 363
 Reheating furnace, 234
 " " gas fired, 235
 Reverberation, 363
 Reversing mill, 241
 Revolving furnace, 135
 Richards, W., 93, 171
 Riley, 200
 Robert converter, the, 180
 Roberts-Austen, 299, 314, 324
 Rod rolling, 247
 Rogers, J., 120
 Rolling mill, 237, 253
 Rolls, 222
 " two high, 237
 Roozeboom, 299
- Rotator, Siemens, the, 138
 Running out fire, 120
 Rusting, 363
- S.
- SANKEY, Captain, 267
 Sauveur, 298, 300
 Scaffold, 100
 Segregation, 228, 364
 Sexton, H., 90
 Shackles, 261
 Siemens, Sir W., 324
 " process, 189
 " rotator, 62
 Silica, 8
 Silicates, table of, 44
 Silicon, 8
 " in iron, 281
 Skids, 241
 Slag, acid Bessemer, 169
 " basic " 177
 " acid open hearth, 196
 " basic " " 202
 " blast furnace, 89
 " pocket, 189
 " scouring, 89
 " wool, 98
 Slab, 244
 Slip, 100
 Smelting of pig iron, 74
 Snelus, 127, 170
 Soaking pits, 233
 Solution, solid, 291
 Sorby, 277
 Sorbite, 300
 South Wales process, 118
 Specific heat, 311
 Spiegeleisen, 103
 Squeezers, 220

Stalls, calcination in, 71
 Stassano process, the, 333
 Stead, J. E., 171, 267, 276, 277, 308
 Steel, forging, 250
 „ high speed, 348
 „ manganese, 351
 „ Mushet, 344
 „ nickel, 352
 „ rolling, 245
 „ self-hardening, 343
 „ special, 343
 „ Styrian, 150
 „ Vanadium, 344
 Stopper hole, 123
 Stove, hot blast, the, 81
 Strength, tensile, 257
 „ transverse, 262
 Stresses, alternating, 266
 Sulphur, 9
 „ allotropic modifications of, 287
 „ in coal, 31
 Symbol, 4

T.

TABLE of acid materials, 46
 „ „ basic „ 48
 „ „ blast furnace charges, 90
 „ „ calorific power, 29
 „ „ clay ironstone, 71
 „ „ elements, 13
 „ „ iron ores, 21
 „ „ oxides, 13
 „ „ puddling furnace charges, 133
 „ „ silicates, 44
 „ „ tempering temperatures, 305

Talbot process, 209
 „ continuous furnace, 237
 Tap hole, 77, 184
 Tapping, 97, 131, 193
 Teeming, 147
 Temper carbon, 310
 Temperature, measurement of, 311
 „ table of, 305
 Tempering, 300, 305
 Tenacity, 254
 Test bars, 260
 Testing dynamic, 264
 „ machine, Wickstead's, 258
 Tilters, 241
 Tilting furnace, 205
 „ ladle, 164
 Tin, allotropic modifications of, 287
 Torsion, resistance to, 261
 Transition point, 287, 365
 Transverse strength, 262
 Treatment of ingot metal, 226
 „ „ puddled balls, 216
 Tucker, A., 235
 Turner, Prof., 93, 131, 133
 Twyer, blast furnace, 78
 Tymptone, 77

U.

UEHLING, 102
 Ulverstone, 68

V.

VANADIUM steel, 354
 Vanadinite, 50

Vein stuff, 16
 Volt, the, 322

W.

WATER, 10
 .. gas, 38, 42
 .. twyer, 78
 Walloon process, 118
 Walrand-Legenissel process, 180
 Washed metal, 137
 Watt, the, 323
 Weathering, 73
 Weld iron, 118, 141
 .. steel, 141, 145
 Welding, 253
 .. electric, 342
 Wellman furnace, 206

Whitworth, Sir J., 232
 .. press, 231
 Wicksteed, 258
 Wild heat, 230
 .. metal, 230
 Wire drawing, 248
 Wolframite, 49

Y.

YIELD point, 257
 Yorkshire bar iron, 138
 Young's modulus, 256

Z.

ZINCING, 364
 Zone of combustion, 86



D. VAN NOSTRAND COMPANY

Publish the following Catalogues which
will be sent gratis on Application. . . .

CHEMICAL.

144 Page Alphabetical and Classified List of
Books on Chemistry, Chemical Technology and
Physics. Arranged by subjects and authors.

ELECTRICAL.

112 Page Classified Catalogue of Electrical
Books. Indexed. 8 page list of Electrical
Books issued in 1907.

TECHNICAL.

122 Page List arranged by Authors.

48 Page List of Scientific Books recently issued
and in preparation.

8 Page Supplemental List of Books on Manu-
factures and Industries.

8 Page List of Books just issued.

MONTHLY RECORD.

16 Page Monthly Record of Scientific Litera-
ture Sent regularly to any address, on request.

23 Murray and 27 Warren Streets, New York.

D. Van Nostrand Company

Announce the early issue of the

WESTMINSTER SERIES.

8vo, cloth, fully illustrated, - Each, \$2.00 net.

Much of the information forthcoming in these volumes is either not available to the general public, or if available, is widely scattered. These volumes will be issued at short intervals.

NOW READY.

INDIA-RUBBER AND ITS MANUFACTURE, with Chapters on Gutta-Percha and Balata. By H. L. Terry, F.I.C., Assoc. Inst. M.M.

ELECTRIC POWER AND TRACTION. By F. H. Davies, A.M.I.E.E.

LIQUID AND GASEOUS FUELS, AND THE PART THEY play in Modern Power Production. By Professor Vivian B. Lewes, F.I.C., F.C.S.

COAL. By James Tonge, M.I.M.E., F.G.S., etc. (Lecturer on Mining at Victo University, Manchester).

THE BOOK: Its History and Development. By Cyril Davenport, V.D., F.S.A.

IRON AND STEEL. By J. H. Stansbie, B.Sc., F.I.C.

TOWN GAS FOR LIGHTING AND HEATING. By W. H. Y. Webber, C. E.

GLASS. By Walter Rosenhain, Superintendent of the Department of Metallurgy in the National Physical Laboratory, late Scientific Adviser in the Glass Works of Messrs. Chance Bros. & Co.

IN PREPARATION.

PATENTS. Trade Marks and Designs. By Kenneth R. Swan (Oxon.), of the Inner Temple, Barrister-at-Law.

THE MANUFACTURE OF PAPER. By R. W. Sindall, F.C.S.

WOOD PULP AND ITS APPLICATIONS. By C. F. Cross, E. J. Bevan, and R. W. Sindall.

STEAM ENGINES. By J. T. Rossiter, M.I.E.E., A.M.I.M.E.

PRECIOUS STONES. With a Chapter on Artificial Stones. By W. Goodchild, M.B., B.Ch.

ELECTRIC LAMPS. By Maurice Solomon, A.C.G.I., A.M.I.E.E.

STEAM LOCOMOTIVES. By Vaughan Pendred, M.I.Mech.E.

GOLD AND PRECIOUS METALS. By Thomas K. Rose, D.Sc., of the Royal Mint.

ELECTRO-METALLURGY. By J. B. C. Kershaw, F.I.C.

PHOTOGRAPHY. By Alfred Watkins, President-Elect of the Photographic Convention, 1907.

COMMERCIAL PAINTS AND PAINTING. By A. S. Jennings, Hon. Consulting Examiner, City and Guilds of London Institute.

BREWING AND DISTILLING. By James Grant, F.S.C.

Publishers and Booksellers,

23 Murray and 27 Warren Streets, NEW YORK.

YCNW
Y50 ndl w

YC 19008



TN705
S75

206435

Stansbie

