

From the collection of the

o P^zreⁿL^minger^a
v Library
t p

San Francisco, California
2007

REFERENCE USE

7-11-5m-P

1
2
3
4
5
6
7
8
9
10
11
12
13
14
15
16
17
18
19
20
21
22
23
24
25
26
27
28
29
30
31
32
33
34
35
36
37
38
39
40
41
42
43
44
45
46
47
48
49
50
51
52
53
54
55
56
57
58
59
60
61
62
63
64
65
66
67
68
69
70
71
72
73
74
75
76
77
78
79
80
81
82
83
84
85
86
87
88
89
90
91
92
93
94
95
96
97
98
99
100

1
2
3
4
5
6
7
8
9
10
11
12
13
14
15
16
17
18
19
20
21
22
23
24
25
26
27
28
29
30
31
32
33
34
35
36
37
38
39
40
41
42
43
44
45
46
47
48
49
50
51
52
53
54
55
56
57
58
59
60
61
62
63
64
65
66
67
68
69
70
71
72
73
74
75
76
77
78
79
80
81
82
83
84
85
86
87
88
89
90
91
92
93
94
95
96
97
98
99
100

1
2
3
4
5
6
7
8
9
10
11
12
13
14
15
16
17
18
19
20
21
22
23
24
25
26
27
28
29
30
31
32
33
34
35
36
37
38
39
40
41
42
43
44
45
46
47
48
49
50
51
52
53
54
55
56
57
58
59
60
61
62
63
64
65
66
67
68
69
70
71
72
73
74
75
76
77
78
79
80
81
82
83
84
85
86
87
88
89
90
91
92
93
94
95
96
97
98
99
100

WORLD BANK
WASHINGTON, D.C.
20547

0

THE IRRIGATION AGE

With Which Is Merged

CHICAGO, ILLINOIS

**National
Land and Irrigation
Journal**

NOVEMBER, 1913

Vol. XXIX

TITLE REGISTERED U.S. PATENT OFFICE

No. 1

The ability of Austin Excavators to dig perfect ditches has never been equalled



An Austin Drainage Excavator Ditch is dug with sides sloped to templet and in one operation. The method is described in Catalogue "S"

They dig ditches that deepen most in the exact center—ditches with perfect slope and berm—ditches that, no matter what the soil, defy caving and deterioration from frost or erosion. They duplicate your plans at lowest cost.

F. C. Austin Drainage Excavator Company

Agents wanted in open territory

Railway Exchange, Chicago, Ill.

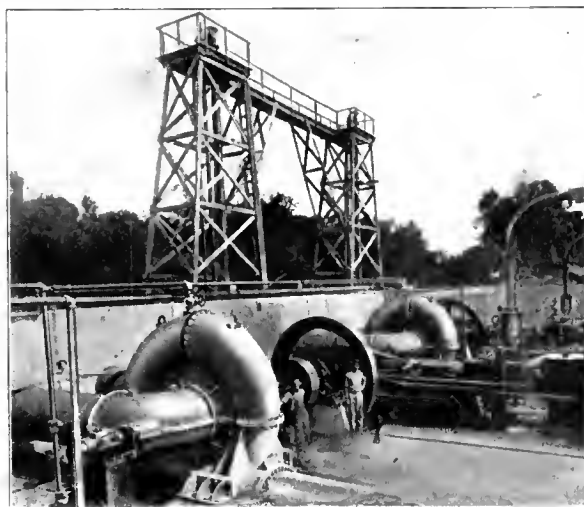

Morris Machine Works

BALDWINVILLE, N. Y.

Centrifugal Pumping Machinery, designed for any irrigating or dredging proposition. Send details or specifications of what is wanted and we will recommend a pumping outfit to supply the need.

New York Office, 39-41 Cortlandt Street
HENION & HUBBELL - - General Agents
223-231 North Jefferson St., Chicago

HARRON, RICKARD & McCOMB - - Agents
San Francisco and Los Angeles, California

H. A. PAINE, Agent - - - Houston, Texas

SPECIAL FEATURES

Governor Haines
Answers Bohm

Along the
Northern Pacific

Conservation and
Co-operation

Twenty-Nine
Years Old

Myers Power Pumps

Working Heads, Pumping Jacks, Cylinders, Etc.

PATENTED

The Myers
Bulldozer Power
Working Heads
For Deep Wells

Length of Stroke
5 to 24 inches

Size of Discharge
Up to 6 inches

PATENTED

The Myers
Bulldozer
Power Pumps
For
Shallow Wells

Double Acting
Length of
Stroke
5 to 20 inches

Size of
Cylinders
2½ to 6 inches

Size of
Discharge
Up to 4 inches

Capacities
600 to 7200 Gallons
per Hour

PATENTED
APRIL 30TH, 1901,
No. 673,282.
JULY 13TH, 1909,
No. 928,234
AUGUST 10TH, 1909,
No. 930,405.
AUGUST 10TH, 1909,
No. 930,981.

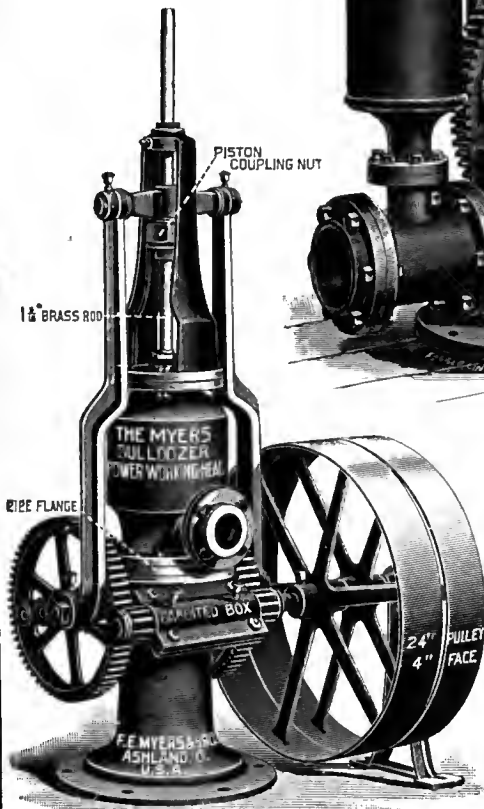
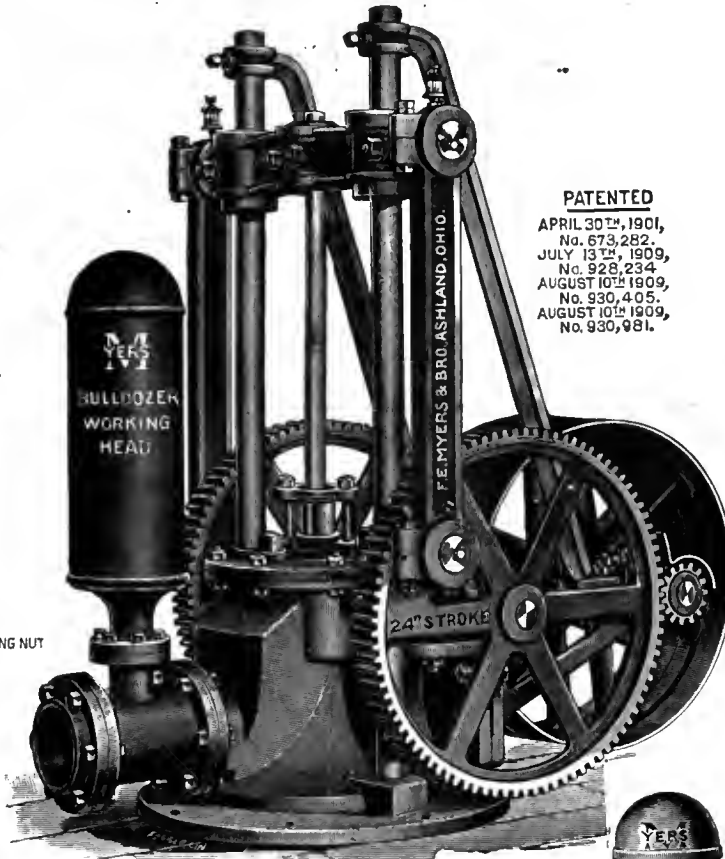

The construction of these pumps permits a double gearing which transmits the power in two lines—one from each end of the same shaft, thus insuring perfect alignment and reducing all friction and side strain to a minimum.

Write
for
Catalogue
and
Prices

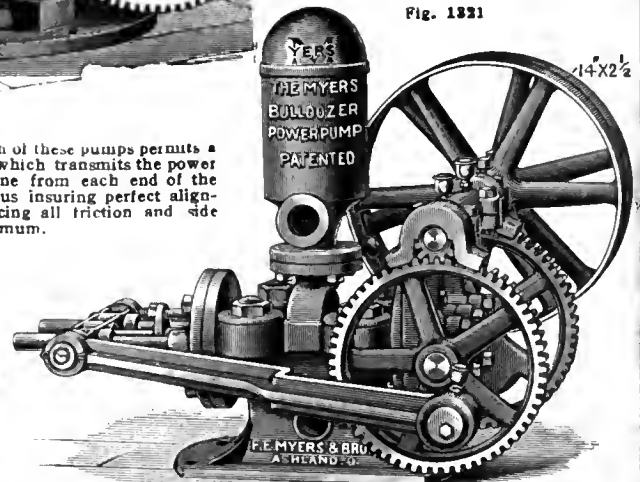

Fig. 1321

F. E. MYERS & BRO., ASHLAND, OHIO
ASHLAND PUMP AND HAY TOOL WORKS

Come Up Into the Northern Pacific Country

This northern tier of states offers a HEALTHFUL and INVIGORATING CLIMATE, SPLENDID CROP RECORDS, and in every respect unexcelled opportunities.

Northwestern Crops

are BUMPER this year. Wisconsin and Minnesota lead the United States in condition of the Corn Crop. The rest of the Northern Pacific country is at the very height of prosperity.

Low Round-Trip Homeseekers' Excursions

on numerous dates this Fall to practically all points in the northwestern United States and Canada. Low One-Way Spring Colonist Fares will be in effect daily March 15 to April 15, 1914. Send for free illustrated literature and information today and plan a trip of investigation into this fertile territory.

. J. BRICKER, General Immigration Agent

Northern Pacific Building

ST. PAUL, MINN.

Northern Pacific Ry.





WE SHALL be glad to mail anyone who wishes same, our free catalog. We sell our product through dealers and jobbers entirely and solicit inquiries from all dealers. Our goods are well and favorably known. They are standards in the United States Army and several other departments of the government.

Gold Medal Camp Furniture Mfg. Co.
Racine, Wis., U. S. A.

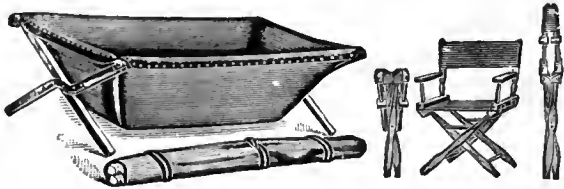

MAKE MONEY MAKING CEMENT TILES

The field is unlimited and uncrowded; marketing the product in competition with the clay interests and at clay tile prices produces a great profit and a glance at the future spells only success for the factory or business started today.

No existing proposition offers such flattering inducements or such a field of opportunity for the man looking for a vocation or for the man looking for an investment. No other business can net you such profits on the amount of capital involved, and no other business has such an unlimited future.

Just think of a business paying from 30% to 50% on the investment the very first season, and subsequently from 50% to 150%, then ask yourself the question—Is it worthy of investigation?

Our literature gives you all the details regarding the merits of cement tile, the cost of manufacture, the amount of capital required to embark in the business; how to build your factory and last, but not least, it tells you how we aid the manufacturer using our machinery and gives you our full and complete proposition. A short letter telling that you are interested will bring complete data.

The Cement Tile Machinery Co.

172 Rath St., Waterloo, Iowa.



Can You Afford to Support Horses?

THOMAS A. EDISON, the wizard of inventors, says, "The horse is the poorest motor ever built." When you stop to think of it, the horse is about the most costly and wasteful thing at work for a farmer. At best his working time averages only about six hours a day, eighteen hours he rests, yet he eats all year round, working or idle. He eats ten pounds for every hour he works. One acre out of every five plowed goes to feed the horse. The best horse may get sick; when, besides losing his work, you have veterinary bills to pay. When he dies, you have a heavy loss. Since McCormick built his first binder, the tendency of all farming has been away from slow man- and horse-power and toward time- and money-saving machines. Thus far, wherever an

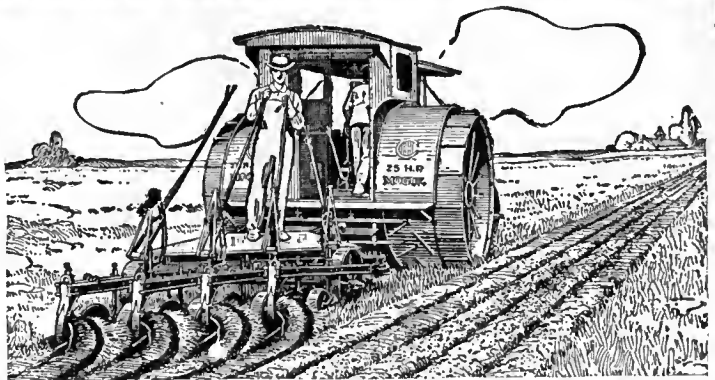

IHC Oil Tractor

has been set to work on a farm, no machine has taken the place of so many horses, or done so much laborious work with so large a saving of time and money. IHC tractors have revolutionized farming. If the owner desires, his tractor will plow nearly as much in a day of twenty-four hours as a team of horses plows in a month. There is efficiency for you!

Whether you use it for pulling field machines,

hauling your produce, threshing, cutting ensilage, baling hay, or anything else, the IHC tractor will stand up to the work. In simplicity and strength of construction, ease of operation, durability, and all-around economy, you cannot find the equal of IHC tractors. They are made in all styles and in 6-12, 7-15, 10-20, 12-25, 15-30, 25-45, and 30-60-horse power. The IHC engine line also includes general purpose engines, ranging from 1 to 50-horse power and operating on various fuels.

It will be to your advantage to get acquainted with the IHC tractor. See the local dealer, and write for facts and information to the nearest branch house.

WESTERN BRANCH HOUSES: Denver, Col.; Helena, Mont.; Portland, Ore.; Spokane, Wash.; Salt Lake City, Utah; San Francisco, Cal.

International Harvester Company of America
(Incorporated)

Chicago

U S A



When writing to advertisers please mention The Irrigation Age.



This splendid 70 gallon vertical suction, centrifugal Buffalo Pump for only

\$28.50

Larger Sizes in Proportion

"Buffalo" Vertical Suction Centrifugal Pump—the highest pump value ever offered at the price

We are prepared to make stock shipments from factory of this highly recommended and exceedingly popular irrigation pump, used for heads not exceeding over 50 feet. It belongs to the trade-marked "Buffalo" Class M family, which has won just recognition as the highest value obtainable in popular priced centrifugal pumps. The outfit includes pump, pulley, companion flanges and coupling for both suction and discharge, as shown. Only the finest white babbitt metal is used in the extra long bearings, which are furnished with brass compression grease cups. Thrust bearing is of ball bearing type. It may be installed by attaching the suction flange directly to the well casing, the pump itself being set between two vertical timbers, which also carry the shafting, bearings, etc., and is driven by pulley located above the ground at top of the well. Bearings, shaft collars, and steel shafting can be supplied at a slight extra cost to suit your individual requirements. Being accurately made and fitted, all parts of the pump are interchangeable and can be promptly duplicated at any time. Couplings are bored same size as shaft and bearings. Larger sizes also made. The price quoted is f. o. b. our factory.

Send us your order now.

Ask for Catalog No. 237-C.

BUFFALO STEAM PUMP CO.
Buffalo, N. Y.

Agents Wanted for our complete line of pumps for every purpose

SAMSON TURBINE

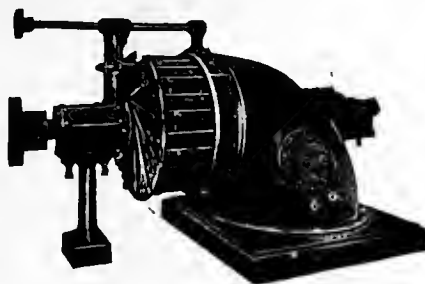

When the PUMP cannot be direct connected to the turbine shaft, the power is usually transmitted by gears, shafting, etc. On account of the HIGH SPEED of the SAMSON, for a given power, lighter and consequently CHEAPER transmission machinery can be used.

JAMES LEFFEL & CO.
Springfield, Ohio, U. S. A.
316 Lagonda Street

IRRIGATION DITCHES

Cheaply and Properly Made with a

Rural Road Grader and Ditcher



Cutting V-Bottom ditch on Slope of 1½ to 1.

The successful irrigation ditch or lateral must be cut clean, with slopes smooth and undisturbed. This machine was especially designed to meet these requirements. One horse and wheel traveling in point of ditch, the other outside the bank of earth. Operated by one or two men and two or four horses.

If you have an irrigation problem to solve, do not fail to write for full information concerning this Combined Grader and Irrigation Ditcher.

Address

C. D. EDWARDS, Albert Lea, Minn.

This Book Shows How to Plan a Private Irrigation Pumping Plant



It also shows all of the various types of pumps to meet the conditions found in different localities, tells how to select the proper pump for your conditions, how to determine the amount of power you

will need and all the other things the irrigator needs to know.

One will be sent free on request as long as they last. Write today

THE GOULDS MFG. CO.
LARGEST MFR. OF PUMPS FOR EVERY SERVICE

174 Fall Street, Seneca Falls, N. Y.
Branches in All Principal Cities

Blackmar Rotary Pump

(Interior View)

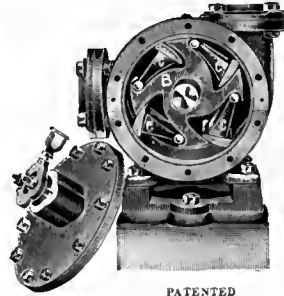

Large Capacity with Minimum of Power

One customer writes he pumped 21,000 gallons with a fuel consumption of 1 gallon of gasoline.

Runs quiet; is high in efficiency and durability. Wear automatically taken up. Few parts, no springs, no adjustments. Requires little or no attention.

One customer has 500 in use.

Capacity, 5 to 500 gallons per min.

Tell us about your pumping problems.

Blackmar Pump Power & Manufacturing Co.
PETOSKEY, MICH., U. S. A.

The Ditchwalker Knows the Red Ball

He knows that it stands for rubber footwear that lasts. He knows that when he buys "Ball-Band" rubber footwear he is saving money. And he is for the boots with the Red Ball that will give him bigger dividends in hard wear, dollar for dollar, than any other boot.

He knows that the boots with the Red Ball will keep his feet dry as he splashes through the laterals. The icy water in the ditches comes straight from the mountains and will send a chill through your whole system if your feet are not kept dry and warm.

"BALL BAND"
TRADE MARK (Red) BAND

"Ball - Band"
Boots will keep the water out and a short wool sock on the foot will keep the heat in.

Look for the boots with the Red Ball. You can buy them with the knowledge that they will give you more days' wear for each dollar invested than any other boot you can buy.

Ask your dealer for them. If he doesn't keep them, write us and we'll see that you are supplied. Write anyway for our free illustrated booklet on "Ball-Band" rubber footwear.

Mishawaka Woolen Mfg. Co.
346 Water Street, Mishawaka Ind.

"The House That Pays Millions for Quality"



SUPERIOR
THE NAME TELLS A TRUE STORY

No matter where you live or what your seeding conditions are, you can get a SUPERIOR GRAIN DRILL that will fill the bill and do your work in the best possible manner. Superior Drills are made in all sizes and every style. Every Superior Drill is sold under a warranty that absolutely protects the buyer. Send for catalogue. Read it and go to your local dealer and insist on seeing the Superior Drill.

AMERICAN SEEDING MACHINE CO., (Inc.)
Springfield, Ohio

GRAIN DRILLS

Twenty-Ninth Year

THE IRRIGATION AGE

VOL. XXIX

CHICAGO, NOVEMBER, 1913.

No. 1

THE IRRIGATION AGE

With which is Merged

The National Land and Irrigation Journal

MODERN IRRIGATION
THE IRRIGATION ERA
ARID AMERICA

THE DRAINAGE JOURNAL
MID-WEST

THE FARM HERALD
THE IRRIGATOR

D. H. ANDERSON
PUBLISHER,

30 No. Dearborn Street,
Old No. 112 Dearborn St.

CHICAGO

Entered as second-class matter October 3, 1897, at the
Postoffice at Chicago, Ill., under Act of March 3, 1879.

D. H. ANDERSON, Editor

ANNOUNCEMENT.

The "Primer of Hydraulics" is now ready; Price \$2.50.
If ordered in connection with subscription \$2.00.

SUBSCRIPTION PRICE

To United States Subscribers, Postage Paid, \$1.00
To Canada and Mexico, 1.50
All Other Foreign Countries, 1.50
In forwarding remittances please do not send checks on
local banks. Send either postoffice or express money order or
Chicago or New York draft.

Official organ Federation of Tree Growing Clubs of
America. D. H. Anderson, Secretary.

Official organ of the American Irrigation Federation.
Office of the Secretary, 212 Boyce Building, Chicago.

Interesting to Advertisers.

It may interest advertisers to know that *The Irrigation Age* is the only publication in the world having an actual paid in advance circulation among individual irrigators and large irrigation corporations. It is read regularly by all interested in this subject and has readers in all parts of the world. *The Irrigation Age* is 28 years old and is the pioneer publication of its class in the world.

Chief
Engineer
Davis
Talks

We are presenting in this issue a letter from A. P. Davis, Chief Engineer, United States Reclamation Service, concerning the complaints of the people of the North Platte Valley. Mr. Davis contends that

so far as they have any basis, they are founded on claims of riparian rights, which are directly antagonistic to irrigation and have long ago been set aside by the state laws and the state courts. Mr. Davis goes into the matter very thoroughly and it will be worth the while of our readers to go over his letter.

Elephant
Butte
Dam
New Mexico

We will present in a future issue an article on the Elephant Butte Dam, located in New Mexico, which is the largest project of the Reclamation Service. This will create the largest artificial lake of the kind in the

world; the project is now nearing completion. The Rio Grande Valley of New Mexico is the home of irrigation in the United States. The first white men who visited that section, as early in its history as 1536, found the country under a high state of cultivation. It is our plan to tell all about this great project in our December number.

Governor
Haines
Answers
Bohm

In a recent communication from Governor John M. Haines of the State of Idaho, addressed to the editor of *THE IRRIGATION AGE*, we are requested to publish an open letter addressed by the governor to Mr.

Edward Bohm, in reply to his open letter written for the October number of *THE AGE*. The governor takes exceptions to statements made by Mr. Bohm and we are very glad indeed to reproduce his letter in this issue.

It is only fair to allow Governor Haines space for his reply to Mr. Bohm and in this way we trust that the full facts concerning the Idaho situation may be placed before our readers. It may not be out of place to say here, however, that Mr. Bohm, in his studies of Western conditions, has gone over the various projects more carefully than any one in the knowledge of the editor of this publication. He has spent large sums of money in his investigations, without hope of return; in fact, is the only man in the knowledge of the writer who has spent much time and money in the study of this subject. Mr. Bohm is naturally a delver after facts! he has had some experience in governmental work in the Census Bureau studying irrigation conditions,

which no doubt fitted him for some of his later investigations. Governor Haines takes the attitude that Mr. Bohm's article is unjust to the officials of the State of Idaho, who, he states, are attempting to settle the important questions involved and to bring order out of chaos. Perhaps the publication of both sides of the case may be beneficial to all concerned, and we trust that there may be no desire on the part of either gentleman, other than for the best good to the greatest number. We shall be glad at any time in the future to publish other articles from the pen of either Governor Haines or Mr. Bohm.

**Important
Trespass
Suit
Pending**

The use to the government of \$1,000,000 to \$2,000,000 the next ten years are involved in the case of the United States against the Utah Power and Light Company, a \$40,000,000 merger. The appeal is a test case, charging the Power Corporation with trespass in constructing a reservoir in the Cache National Forest in Utah. Hundreds of similar instances in Mountain and Pacific Coast states await the determination. This case involves the whole question of State and Federal control of forests. THE IRRIGATION AGE hopes the case may be decided in favor of the United States Government, as it does not believe that the large power companies throughout the Inter Mountain and Pacific Coast territory should be allowed to step in and take over water power that rightfully belongs to the people. The AGE has always contended and does still contend that the Forestry Bureau was unfair in its treatment of small concerns; in fact, it is well known that the Forestry Bureau harassed and cramped small holders and took action against mining concerns with limited capital which hindered their development. The AGE is, however, heartily in accord with any move which will keep the heavy power companies from taking over what rightfully belongs to the people. We will watch the result of this case with much interest.

**American
Engineers
In
Demand**

Without announcement or ceremony of any kind, at 3 p. m., October 20th, the gates were dropped which closed the great dam of the Canadian-Pacific Railway on the Bow River at Bassano, Alberta, completing an irrigation system of two million acres, representing three years' work and many millions of investment.

The dam is exactly eight thousand feet long and raises the water fifty-one feet for diversion into the trunk canal.

There were present at the closing: J. S. Dennis, assistant to the president and head of the Department of National Resources; W. Nasmythe, land agent; A. S. Dawson, chief engineer; H. B. Muckleston, assistant engineer; H. Sidenius, resident engineer; and Mr. Fraunhofer, representing the railway company, and John R. Freeman, consulting engineer, of Providence, R. I.

The Ambursen Hydraulic Construction Company, of Boston and Montreal, designers and builders of the dam, were represented by W. L. Church, president; H. L. Coburn, chief engineer, and G. E. Heckle, chief engineer of the Canadian Ambursen Company.

The Ambursen Hydraulic Construction Company has entered largely into Canadian work and their success is mainly due to a fine organization of capable men. The fact that the Canadian Government and the leading railways of that country are employing construction heads and engineers from the United States speaks well for our schools and the training of their graduates.

The irrigation interests of the San Francisco's Joaquin Valley, California, have won a great victory in the stoppage of the Hetch-Hetchy bill in the Senate, where the ways were greased for its passage. This, as is generally known, is a San Francisco job pure and simple, engineered for the power rather than the irrigation or water rights. San Francisco, it is said, has plenty of water in sight through extensions of the Spring Valley Company that must in any event become a part of its system for the next twenty years. The real opposition is not the nature lovers; this is a blind; it is the irrigation interests of the Valley. There are 257,000 acres in the two districts, which San Francisco agrees to protect, and there is a big acreage outside which might be irrigated if the water is not diverted. That is the argument that no water should be taken from the valley. The citizens of that district want a special committee from Congress to go out there and make a personal inspection before any action is taken. They claim that the water users of the district are unanimous against this bill. It is well known that the great power interests of California and the Pacific coast generally, are trying to take over all of the water rights possible to strengthen their position, and they are doing this regardless of the protests of the various land holders and ranchmen. It is unreasonable to expect corporations of this character to respect the rights of the smaller land holders, but in the Hetch-Hetchy affair, the settlers are up in arms and are ready to fight for their rights and

fight to a finish. We will present an article in our December number from a well known authority on this subject.

**Improving
Conditions
For
Settlers**

Seventy million dollars have been expended so far by the Reclamation Service since the passage of the law in 1902. It is stated that \$48,000,000 additional is now available for use during the coming four years, every cent of which will in time be returned to the United States Treasury. The general supposition is that this money is to be returned to the Treasury within a period of ten years. Under recent rulings, however, that time has been extended to settlers who have found it difficult to keep up their payments on certain tracts, and it is hoped that a reasonable extension may be granted as per the suggestions of Secretary Lane, after his visit through the West. There are many farmers who have gone onto land under Federal projects in the West who have not clearly understood the situation, and who have gone west with insufficient funds to carry them during the first two or three years of development of their tracts. It is generally conceded that if these settlers were given two or three years without payment and allowed to begin their payments after their land has been put under cultivation and is producing that it would be much better for all concerned. This evidently is the view of Secretary Lane and if it is carried out on all of the tracts through the West, will meet with the approval of every one who clearly understands the situation. It would be much better to give a settler three years' time in which to get a good start and then insist on his payments being made regularly thereafter. A man who cannot put his farm in shape to produce enough to live on and make his payments at the end of three years, ought not to be encouraged to remain on the land and should make way for some one more capable.

**Doctor
Elwood
Mead
Returns**

Dr. Elwood Mead, the world's foremost irrigation authority, is to become a member of the University of California faculty, according to information received by us recently. Dr. Mead has been engaged as head of the irrigation and water divisions of the Victorian Government in Australia for the past eight or ten years. His work has been that of installing the great irrigation system there and he has made good with the Victorian Government. He left the position of Director of the Department of Irrigation Investigations at Washington, to take the position in Australia, and it is understood that the Victorian Government has made overtures to retain his serv-

ices, but as Dr. Mead's interests lie mainly in this country, he decided to accept this honorable position with the University of California, and will become active in irrigation affairs immediately upon his return from the land of the Southern Cross. He is the author of the World's Standard Volume on Irrigation, and was formerly connected with the State University of California and left there to take the position with the Federal Government at Washington. His title in the faculty in the University of California will be Professor of Rural Institutions, and he will assume his duties, which will deal with economic and legal aspects of irrigation projects and systems, as soon as he returns. It would be difficult to estimate the value of Dr. Mead's knowledge and ability to California and the world. There are other features about his coming back which should be especially pleasing to all of us who are familiar with irrigation history in the United States. The fact is Dr. Mead should have been the head of the Reclamation Service, and had it not been for the manipulations of such men as George H. Maxwell and a coterie of Bureau heads in Washington, some of whom have been raised to positions of great honor since that time, he would have been appointed as head of the Service. Every one who understands western conditions will be very glad indeed, to know that Dr. Mead is returning and will once more become one of us.

**Who
Is
To
Blame?**

General complaint comes to us from the West that ranchmen and fruit growers are not able to find a market, a suitable one, at least, for their products. This brought about an investigation by the editor, while at St. Paul recently, and a number of the commission men were visited and an effort made to learn why fruit raised in Washington, Montana and Idaho should be allowed to rot upon the ground when there is such a great demand for it in the central and eastern states. Commission men, as is usually the case, tried to place the blame upon the railroads, but it was explained to them that the railroads were using every effort to encourage the shipment of fruit and they are as much opposed to its waste and the fact that it rots upon the ground, as they possibly can be, as that naturally holds back freight and results in loss of money. Discussing the subject with several of the railway men who are interested, the fact was emphasized that the railroads are doing everything in their power, under the law, to encourage the shipments of apples and other fruit from the West to the East.

In Idaho it was found necessary to go into foreign countries and develop a market, and Mr.

Perine of Blue Lakes, Idaho, had a plan in mind, at one time, of organizing a company of fruit growers and raising a fund through them to send a man to the Argentine Republic and Brazil, where it was thought a fine market could be opened up for America apples. Whether this was ever carried out or not the writer is unable to say, but the fact remains that thousands of tons of fine apples rot on the ground every year throughout Idaho, Montana and Washington. Why this condition exists when the people in the middle and eastern states go hungry for fruit of this kind on account of high prices, is a question which has not yet been satisfactorily answered. If the fault lies with the commission men, the only salvation for the producer is to organize and ship into the eastern states and sell through local agents in the smaller towns. That is to say, ship in carload or trainload lots and distribute in towns of moderate size throughout the central states, and from there sell either direct to local merchants or to the individual purchaser. If the fault lies with the commission merchant and he is holding up the shipper so that he is not getting the cost of production from the sales, then the commission merchant is surely to blame and should be taught a lesson by the adoption of some method as suggested above. There has been general complaint for years that farmers living throughout northern Illinois and Iowa who ship to South Water street, Chicago, do not get fair treatment from the commission merchants. This has been a long continued and vigorous protest, but it seems that South Water street is as well filled with produce now as it was in the old days. If the farmers were regularly getting the worst of it from the commission merchants it would appear that the shipments would fall off and some other market found. THE IRRIGATION AGE intends soon to make a general canvas of commission merchants who handle Western fruit and learn the details of the business at least sufficiently well to discuss it and present their side of the case to the producers. It may then be learned where the fault lies and perhaps some suggestion may be offered to remedy present conditions.

**Twenty-
Nine
Years
Old**

With this, our November number, THE IRRIGATION AGE is entering upon the twenty-ninth year of its existence; in other words the November number is the twenty-ninth birthday of this publication, and we are glad to be able to say to our thousands of readers that the beginning of the twenty-ninth year shows better conditions in a business way, than the past several years. The irrigation age was established in 1885 by William E. Smythe and a man of the name Brit-

ton, who conducted it for a time with varied success and who subsequently turned it over to one of their assistants, who in turn sold it to J. E. Forrest, from whom the present publisher purchased it some fourteen years ago. Prior to that time the AGE had not been a success in a financial way, although it had regularly been conducted in a clean manner both in an editorial way and in its news columns.

The various ups and downs of the irrigation industry made it impossible to build the paper up to what was planned by its original publisher, namely, a circulation in the hundreds of thousands, and the present publisher has continued along the line of fighting for circulation with a view to bring it up if possible to the fifty thousand mark. He has never been able, in his fourteen years' work, to reach within thirty per cent of that figure, and judging from the growth during the past year, it may not be brought to that figure for many years to come. It is a remarkable fact, however, that the readers or subscribers to THE IRRIGATION AGE have been regularly loyal to it. There are very few discontinuances, and when a reader or subscriber is once obtained, the rule is to have them continue, so that we have many thousands of readers in our list who have been reading the paper regularly for over twenty-five years. This in itself speaks well for the editorial conduct of the publication, although from many directions, as is the case with all classes of publications, complaints are heard as to our editorial policy. This was particularly true concerning our attitude on the mistakes of the Reclamation Service and the high handed manner in which the affairs of the Forestry Bureau were conducted.

Naturally, a large number of our subscribers were connected with one or both of these bureaus, and did not feel that we were entitled to our opinion concerning them or if entitled to it, they apparently concluded that the opinion should not be publically expressed. By maintaining that attitude a large number of subscribers were lost. We were very sorry, of course, to have them withdraw their support from the publication, but this condition did not in any sense change the policy of our editorial columns. During the past several years these old readers who became disgruntled and withdrew their support, have returned to us, so that today we feel that we have the cream of the active operators under Government Bureaus, and it would appear that our attitude toward these bureaus materially strengthened us with our general field of subscribers. During the fourteen years that this publication has been controlled by the present publisher, he has purchased eight other journals, the combined circulation of which has been merged with that of the AGE. The last purchase of importance was that of the *National*

Land and Irrigation Journal of Chicago, and *The Irrigator* of North Yakima, Washington. The *National Land and Irrigation Journal* was by long odds our strongest competitor and the promoters of that publication spent about sixty thousand dollars to establish the paper in this field. Owing to the expense of putting out their publication the stockholders decided, however, to sell out in January of this year and the paper was purchased by the owner of THE IRRIGATION AGE and its circulation merged with that of the AGE. We are therefore, left entirely alone in the irrigation and drainage field in the world. Advertisers who are looking for trade in either of these fields cannot reach them through any other medium, and we urge upon the advertisers who peruse this issue to give consideration to these facts in contemplating the placing of their advertising appropriations. From present appearances the year beginning November, 1913, will be the best in point of earnings and circulation building in the history of the paper. We have at present ten high grade canvassers who make a house-to-house canvass through the farming districts of the West and who are sending in a large number of subscribers each day. In conclusion the publisher wishes to thank the thousands of readers who have proven loyal to THE AGE and who support its attitude on public questions.

ROADS BUILT FROM FOREST RECEIPTS

Over twelve thousand dollars, ten percent of national forest receipts in Wyoming during the past fiscal year, is available for expenditure by the secretary of agriculture on roads and trails within the state, according to the report of the U. S. forest service.

Such roads and trails are now being built on national forests in Wyoming, in accordance with the provision created by Congress for a "roads and trails fund," primarily to benefit local communities. The use of this ten per cent of all national forest receipts is in addition to the 25 per cent of gross income which goes by law to the states direct for schools and roads.

A new road just finished on the Wyoming national forest in western Wyoming is typical of those constructed by the forest service under the so-called "ten per cent road item." This road runs from the entrance of Cottonwood Creek Canyon, on the Wyoming national forest, to Cottonwood Lake, six miles distant.

Cottonwood Lake, three-quarters of a mile long and a quarter of a mile wide, is 15 miles from Afton, the chief town of Star Valley, and 6½ miles from Smoot. It is well stocked with trout, but has been hitherto inaccessible except to persons on horseback. The new road opens to the 1,800 residents of Upper Star Valley a delightful pleasure resort and auto parties from Kemmerer, Cokeville, or Montpelier can now reach the lake in a few hours.

GOVERNOR HAINES OF IDAHO REPLIES TO EDWARD BOHM.

The following is a letter from Governor Haines of Idaho relating to a communication which appeared in our October issue. Following the letter of Governor Haines appears his reply to Mr. Bohm.

State of Idaho, Governor's Office,

Boise, October 22, 1913.

Mr. D. H. Anderson,
Editor Irrigation Age,
Chicago, Ill.

Dear Sir: I am enclosing herewith a copy of an open letter addressed by me to Mr. Edward Bohm in reply to the open letter published by him in the October number of your magazine. It appears to me that Mr. Bohm's article is so unjust to the officials of the state of Idaho who are now attempting to settle the important questions involved and to bring order out of chaos, that you will perhaps be willing to publish my reply in order that those who have read this article may have an opportunity of seeing the other side.

Yours very respectfully,

JOHN M. HAINES,
GOVERNOR.

OPEN LETTER

October 21, 1913.

Mr. Edward Bohm,
Care THE IRRIGATION AGE, Chicago, Ill.
Sir:

It is evident from your open letter published in THE IRRIGATION AGE for October, as well as from the references you append to your signature, that you attempt to qualify as one having expert knowledge of Carey Act matters, but it is just as evident that you are entirely lacking in fairness in your treatment of the question which confronts the Land Board and the people of Idaho today. This question cannot be solved by bootless discussion of what might have been, or by railing at the State of Idaho or its officials, past or present.

Let it be admitted at the outset that serious mistakes were made in the financing and construction of a small percentage of our irrigation projects, and that these mistakes have been responsible for much loss and suffering to individuals and for the arrested development of our irrigation enterprises. The account you give of your relations to the Big Lost River Project is probably correct, except your statement that the Land Board announced that it would hold first payments on this tract in escrow. In this you are not borne out by the gentlemen to whom you refer, nor by the Land Board records. Your story does not differ materially from that of many others, nor does it help the present situation, nor bring us any nearer to the solution we are seeking.

Neither will it help at this time to seek to excuse or palliate admitted errors, nor to condemn the short-sighted, selfish policy of those who sought to make political capital out of an unfortunate business situation. Equally grave mistakes may be expected in any new enterprise, operated under untried and perhaps insufficient laws, administered by inexperienced officials pioneering a new field.

The great question now confronting us is how to proceed so as to carry these suspended projects to completion and to be substantially just to all concerned. As you well know, action not only by the State Land Board but by the Legislature has been rendered impossible by the litigation in which the Big Lost River Project is involved, but out of this legal maize we hope to emerge in the near future. We are daily expecting a decision by the Federal Circuit Court of Appeals which will, we hope, definitely settle questions of title so that negotiations looking to further construction can be proceeded with. Acting on the best legal advice obtainable, we have refrained from instituting suit to recover on the bond pending the decision of the Circuit Court of Appeals, but the papers have long since been prepared in the office of the Attorney-General and the State but awaits the expected decision before filing suit looking to the recovery of the \$175,000 bond.

The present Land Board has gone deeply into all questions affecting this and other projects and its members have made numerous personal investigations for the pur-

pose of acquainting themselves with the facts in preparation for definite action at the earliest possible moment. We feel that we have done everything that could have been done in the nine months we have been in office and we expect to work unremittingly in the future to bring about a just and satisfactory solution of Idaho's irrigation problems.

We need honest help, thoughtful suggestions, and constructive advice. We do not need sarcasm, inuendo or bitter reflections upon the mistakes of others.

If you are in position to give us any part of what we need, we shall be glad to hear further from you at any time. If your qualifications enable you to offer only what we do not need, it is perfectly evident not only that we can expect no help from you, but that we must continue in our efforts to bring about a proper solution of our difficulties in spite of you and others who are adepts at destruction but mere novices at construction.

Yours very respectfully,
(Signed) JOHN M. HAINES,
Governor.

BREEDING ARMY REMOUNTS.

The Bureau of Animal Industry has received reports from its officers in charge of the breeding of army remounts in co-operation with the War Department which show that the Government's plan is very popular with the owners of mares. At the close of business on August 16, 1913, 41 stallions were in service. These stallions have covered 1,452 mares during the season, an average of slightly over 35 mares per stallion. Twenty-seven of the stallions were five years old or over, and covered 1,097 mares, an average of a little over 40; ten were four-year-olds and covered 292 mares, an average of better than 29 per head; four were three-year-olds and covered 63 mares, an average of more than 15.

The number of mares covered in Vermont and New Hampshire was 241, an average of over 34 for seven stallions, including 3 four-year-olds, and one three-year-old; 583 mares were bred in Virginia, an average of over 31 for 18 stallions, including 4 four-year-olds and 3 three-year-olds; 208 mares were bred in West Virginia, an average of 52 for four stallions, including one four-year-old; 376 mares were bred in Kentucky, an average of better than 37 for ten stallions, including one four-year-old; in Tennessee, a mature stallion and a four-year-old covered 22 mares each.

The number of mares covered by mature stallions of different breeds were as follows: Three Morgans averaged 45 mares; ten Thoroughbreds averaged 38 mares; eight Standardbreds averaged 40 mares and six Saddle stallions averaged 42 mares. All ages by breeds are as follows: Seven Morgans (including 3 four-year-olds and one three-year-old) averaged 34 mares; 15 Thoroughbreds (including 3 four-year-olds and two three-year-olds) averaged 32 mares; ten Standardbreds (including 2 four-year-olds) averaged 39 mares; and 9 Saddle stallions (including 2 four-year-olds and one three-year-old) averaged 37 mares.

In placing these stallions, care was taken to select communities in which there was a scarcity of good stallions. Therefore, the mares bred during the past season, are, to a great extent, mares which would probably not have been bred in the absence of Government encouragement.

The number of mares bred in 1913 will be increased somewhat. In New England, breeding continues until October 1, and in Virginia the fall season is commonly used. Both conditions will operate to the advantage of the remount breeding work.

BELLE FOURCHE, SOUTH DAKOTA, IRRIGATED LANDS OFFER GREAT OPPORTUNITIES

The Belle Fourche irrigation project is located just north of the Black Hills district in South Dakota adjacent to the lines of the Chicago and North Western railway.

Over 65,000 acres of land is under water at the present time, about 60,000 acres of which has already been taken up. This leaves 15,000 acres still to be settled upon, and new land will be supplied with water privileges as rapidly as the work progresses until 100,000 acres of irrigable land in this valley is brought under cultivation.

Climate

The climate of the region is temperate and the rains occur principally in May and June. The summers are pleasant and the nights always cool. The atmosphere is very dry and the altitude of from 2,700 to 3,000 feet at which the valley is situated, makes it most healthful.

Soil

Government engineers hold the soil is exceedingly fertile—part clay and part sandy loam. The lands are free from rock, gravel or excessive sand, and vary from flat to quite rolling.

Crops

The crops that can be profitably grown are grain, hay, alfalfa, potatoes, sugar beets, hardy fruits and garden truck. Fifty to seventy-five bushels of grain may be easily grown on this irrigated land. Apples, plums, and small fruits may be grown, all of good quality. Sugar beets are exceedingly profitable. Wheat grass or the native hay also produces an abundant crop when watered and sells for a high price. The valley is a natural artesian basin, and flowing water of the finest quality is secured at a depth of from 500 to 1,500 feet.

Markets

Belle Fourche has the advantage over most districts in that it is quite near the principal markets of the West,

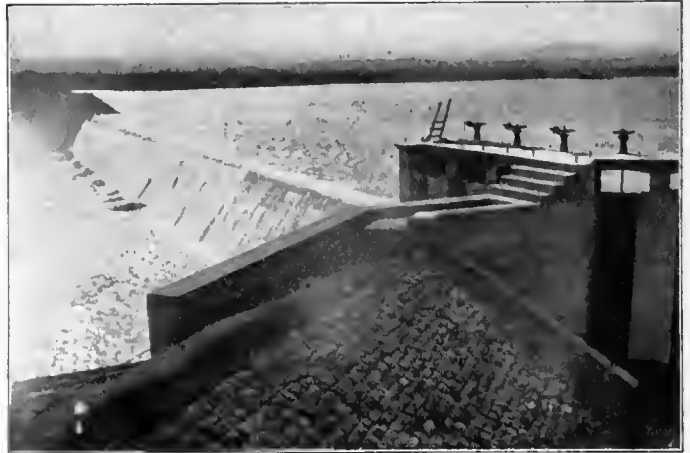

Diversion Dam in Belle Fourche River.

including Omaha, Council Bluffs, Sioux City, Des Moines, Peoria, Chicago, Milwaukee, St. Paul, Minneapolis, Duluth, Superior and Ashland. In addition the settler who comes here to establish his home finds particularly advantageous markets in Deadwood, Lead, Rapid City, Hot Springs, Belle Fourche, Whitewood, Sturgis, Pierre and other South Dakota points. All are reached via the direct train service of the Chicago and North Western railway.

How to Get Lands

Part of these lands belong to the public domain and part are deeded lands. The public land can be secured under the terms of the United States Homestead laws. The deeded or private lands must be purchased, the price varying according to location and improvements.

Cost

The cost of water for lands under this project is about \$30 per acre, divided into ten annual payments, or about \$3.00 per acre per year, without interest. This is exactly what the improvement costs the government. In addition a maintenance fee of 40 to 50 cents per acre per year is charged for its upkeep. The first payment becomes due in the fall after the water has been delivered for the crop. For further particulars call on or address A. C. Johnson, P. T. M., Chicago and Northwestern Ry., Chicago, Ill.

CONSERVATION AND CO-OPERATION

What Oregon and the Federal Government Are Doing—A New Policy of Joint Action—By Edward F. Bohm, Author of "The Carey Act Manual" and "Papers on Irrigation Finance."

Of the far western states, Oregon is, probably, in its entirety, the least traveled and the least known to the outside world. Of its eastern half, by far the greater part, in area approximating the state of Ohio, is still destitute of railroad facilities.

Into the western border of this domain there have, only recently, been extended branches of the Hill and Harriman systems, which, leaving the main lines on the Columbia river, proceed some 150 miles south to the towns of Deschutes and Bend, following the course of the Deschutes river and affording an outlet for the rich agricultural country of the "Deschutes basin," to whose partial development under irrigation these towns owe their present upbuilding. It is this region, lying just east of the Cascade range, which has been selected by state and national authorities as the theatre of the "co-operative investigation" of irrigation and power possibilities by virtue of an agreement recently entered into, and in which it is sought to apply the water of the Deschutes river and tributaries, draining the eastern slopes of the Cascades, to the highest measure of usefulness. Still farther to the east of this remarkable district lies the vast area of open range country—the interior "hinterland"—much-vaunted in "booster" literature as the "Nation's Last West," still to be traversed, if at all, by wagon or in the saddle and interesting in many ways, but outside the scope of this discussion.

The fact of Oregon's isolation has led, in the past, to a hazy condition of mind as to the state's natural resources. It has been known, for a long time and in a broad way, that vast possibilities of usefulness lay dormant in stream and forest, but as to the real extent and probable value of these assets no definite determination had been made until recently. The co-operative investigations conducted by the state and the United States Geological Survey during a number of years past have now fixed beyond all doubt the fact of the existence of irrigation and power possibilities which in their magnitude transcend anything heretofore ascertained as to still latent opportunities upon the public domain—truly a worthy field for the development of the new twin theory of conservation and co-operation. The result of the investigations of the state's timber resources conducted by the Conservation Commission are of an equally imposing character, the forested area being rated at twenty-five million acres, largely under national control and in private ownership, the timber alone being valued at \$680,000,000.

"Conservation" has come to be regarded as a well-meaning but much-abused term with its issues pretty well defined and understood. A discussion of the varying arguments pro and con cannot be entertained in an article such as this, devoted to a bare consideration of facts, but the attitude towards the subject, as evidenced in Oregon by recent legislative enactments, and by the recommendation of its Conservation Commission and Engineering Office, deserves emphatic notice as expressing the latest and most advanced thought and, in that sense, serving as powerful examples of what the term can be made to embrace. "Co-operation," however, in its present application, is a new term, charged with the expression a new ideal of thought and effort. In the last analysis, the working out of broad economic questions can be seen reflected in the enactment of these recent measures for "conservation and development of public resources" by the state which, fittingly enough, was among the pioneers of the initiative and referendum, and which, in a higher sense, has seen fit at the same time to go even further—to the extent of recognition of an ethical principle—a moral obligation. Reference is intended herein to the action of the Legislature in appropriating \$450,000 of state funds for the completion of the defunct Columbia Southern project "to save the good name of the state" and for the rescue of numerous settlers who had been led, upon the assumed honor of the state and by faith in its control, in this case im-

perfectly exercised, to enter lands under this project, and who, through its failure, were deprived of the anticipated supply of water. To make the full meaning of this measure clear it must be set forth that the state, by operation of its own laws, had distinctly disclaimed, in advance, all responsibility for possible failure of its contracting agents and that the settlers were deemed to be without legal recourse in this direction. Here are the recommendations submitted to the Legislature at its last session, by the Conservation Commission—not all of them enacted into law, viz.: State appropriation for forest perpetuation and protection; changes in taxation system to encourage private owners to hold their cut-over timber lands for a second crop; the acquisition of a state forest through exchange of school sections for solid tracts of timber lands; purchase by the state of cut-over and burned-over lands for reforestation purposes, and state financial assistance to settlers upon cut-over lands. This is certainly a far cry from the operations of the old "Timber and Stone Act" and a good measure of recognition of present-day and future needs.

In all the forested areas of the West the disposition of these cut-over lands presents one of the most serious problems of the times on account of the relatively high cost of stump clearing. To assist in reclaiming these large areas of otherwise fertile lands, thus burdened, a constitutional amendment authorizing the issuance of state bonds for "development of cut-over lands" is to be submitted to popular vote in November, 1914. The other recommendations offered have been deferred for future consideration.

To the student of western conditions the figures just published by John H. Lewis, State Engineer, bearing upon the water resources of the state, appear almost beyond belief, but upon the testimony of so highly recognized an authority they are bound to be accepted at their face. This competent and active official has been, in large measure, responsible both for the adoption of the advanced system of water administration now in force (The "Oregon system") and for the numerous conservation measures placed upon the statute books. A retrospective glance over the Oregon water situation will here prove of value. Prior to the year 1909 the state, in common with some of the other "arid-land" commonwealths, was almost innocent of control over its water resources. The doctrines of "riparian rights" and of "appropriation and beneficial use" held sway side by side with no state machinery for either definition or control of such "rights." Logically the chaotic condition resulting proved a serious impediment to bona-fide development and benefited most largely the speculative "water hog." Years of agitation culminated, finally, in the adoption in 1909 of the present famous code, which in its essentials places the control of the state's waters in the hands of an administrative board, with the state engineer at its head. The proposed utilization of these waters, up to that time, had been confined to a very slight use of water powers—in a large way to the irrigation of two tracts (Umatilla and Klamath projects) by the Federal government and to several Carey Act ventures, only one of which, the Central Oregon project, in the Deschutes Basin, having so far been completed. A large area of government lands under this last-named, and, because of its final success, unique, irrigation project, has only recently been made accessible to entry by the completion of the new railroad lines. The fate of the Columbia Southern project and its proposed redemption by the state have already been referred to.

It is now conservatively estimated that the unused, and unappropriated waters of the state are sufficient for the irrigation of two million acres of land, at a cost of from forty to sixty dollars per acre and that they are capable of producing, coincidentally with this irrigation, 3,300,000 horsepower of energy. This great national asset in its scope of ultimate usefulness is almost beyond the grasp of human thought. The development of only a fraction of this cheap power—whether by private capital or by the state—should make possible enormously productive manufacturing industries suitable to the conditions of the Pacific slope and render available the blessings of cheap electricity for every home, however humble. The influx of hundreds of thousands of people, deriving sustenance from these new-born industries, will create a prolific market for the product of forest and farm. The irrigation of two million acres, much of it free government land, will

provide ultimately 250,000 eighty-acre farms, each capable of sustaining in generous comfort a family. It remains only for wise forethought and legislative and administrative ability to make possible such a splendid drama of progress and home-building as will be comparable only with what has been accomplished in a lesser measure in the Snake river valley of Idaho and the Salt river valley of Arizona. That the state and Federal agencies which, owing to the "divided control" over land and water are both intimately concerned in this matter, are not derelict in their responsibility towards the future is evidenced by the "development program" just enacted and by the terms of the "co-operative agreement" executed on May 5, 1913, by the state authorities and Secretary Lane of the Federal Department of the Interior.

Aside from the measure referred to, for the rehabilitation of the Columbia Southern project, the new policies embrace: (1) Legislative appropriation of the sum of \$15,000 for the preparation of plans, specifications and estimates of cost for 536,000 horsepower development on the Columbia river near The Dalles, on the Oregon side, co-operation with the state of Washington and the United States being authorized in the execution of this and future work. The data procured through these means is to be made available for the use of private capital upon reimbursement of the amount spent in investigation, or for the use of the state, should it be deemed expedient for it to engage in construction work directly or should capital prove reluctant. (2) Submission to a vote of the people in November, 1914, of a constitutional amendment authorizing the issuance of state bonds for the construction of irrigation and power projects and for developing the cut-over timber lands, the money advanced to be repaid over a long term of years, and to constitute a lien upon the lands. (3) The state made a party to all water-rights litigation before the Water Board. (4) Provision for declaring forfeited and abandoned all waters for non-use during a period of five years or more. (5) Appropriation of \$10,000 annually for the work of the Water Board, in addition to a standing appropriation of like amount.

No change was made in the regular appropriation of \$25,000 for topographic and hydrographic work. Under the co-operative agreements heretofore existing between the United States Geological Survey and a large number of states, both east and west, the Federal agencies contribute dollar for dollar of this sum. This last-named work has heretofore marked the limits of co-operation between the Department of the Interior and the western states, but the present program has extended the limits of this work much further, State and Federal governments under their agreement each appropriating the sum of \$50,000 "for the joint investigation or irrigation and power projects." This is to be regarded as being as important a step as the adoption of the original "Reclamation Act," as it will result in vastly increasing the scope and efficiency of this measure.

The extent to which efforts under the Carey Act, under "irrigation districts" and by private capital, have thus far failed of their purpose is rapidly fostering the conviction that if the work of reclamation is to proceed upon a future stable basis and with a minimum of mistakes the measure of state and national control over these projects must needs be greatly augmented. Oregon, as well as the Federal government, it appears, has absorbed the lessons taught by ten years of struggle and experiment in wholesale reclamation and is preparing to inaugurate a new condition with the mistakes of the past to guide it. With the sole exception of Utah (through the operations of its "Reservoir Land Grant") and of spasmodic efforts in two other states, Oregon, in the radical departure of providing funds for direct construction of irrigation or power projects, is the first of the western states to embark upon a policy of self-executed effort, and the pioneer in the field of widened co-operation with the reclamation forces of the national government. That the idea of co-operation, however, is taking root is evidenced by the recent recommendations of S. G. Hopkins, State Land Commissioner of Wyoming, by the agitation for its adoption among property owners in the Sacramento valley of California and by the attitude of the new administration of the Department of the Interior evidenced by calling into conference at Washington last May the water users under Federal projects, for a free discussion of their problems. Justification for the new plan of co-operation with its suggested bene-

fits is readily to be found in the complexities involving many large schemes of reclamation. The diversity of ownership of land, of control of water, and of rights to its use, ownership of power sites, and control of rights of way over public lands by the Federal government, all tend to complicate the situation, at best beset with natural difficulties. A unique and favorable factor in the case of Oregon, however, exists in the fact that most of the power sites are still upon Federal domain, that the waters needed are still largely unappropriated, and that a great area of the land to be benefited is of a public character, the situation, therefore, being such as to lend itself readily to state and Federal control and to that extent offering a fair field. By the direct participation of the United States Reclamation Service there will be rendered available the services of an organization already perfectly equipped, familiar with varying conditions, and with a record of success. Cooperation with such an agency will eliminate at the outset the mistakes almost inseparable from a new department dealing with technical and complicated subjects. It will permit the execution of far-reaching plans regardless of political changes and operate, perhaps, to prevent many useless appropriations.

As stated the work under the "joint agreement" will at the outset, at least, be confined to investigations in the Deschutes Basin "to ascertain the feasibility of irrigation projects," etc., "to determine ways and means whereby the public waters, lakes and reservoir sites, state and public lands may be used, reserved, or disposed of in connection with such projects to the highest public advantage, also to determine what power may be developed incidentally to the construction of such projects and the value and possible use thereof."

The Secretary of the Interior is bound "to prevent the attachment of all right to public lands which would interfere with the development of the project," while the State Engineer is "to withdraw and withhold from appropriation all necessary unappropriated waters." When the investigation is completed its results are to be submitted as a report "with appropriate recommendations as to further policies to be adopted by state and nation for the reclamation and development of the areas investigated."

IRRIGATION PROJECT FOR SOUTH DAKOTA.

Within a short time the report on the preliminary work on the next big irrigation project for South Dakota, will be out, showing the practicability of irrigating 60,000 acres of Cheyenne river valley lands in Fall River county. The work so far as carried out shows that this project can be put in at a much less cost than was the Belle Fourche project, and will spread water over a large acreage of land, reducing the cost per acre on the land to be benefited. The proposition is for a stone and concrete dam 150 feet high, and at the place selected for this part of the project, the dam would need be but 980 feet long which would hold a water supply up to 165,000 acre feet per year. This is in strong contrast to the big Belle Fourche dam which is a mile and a half in length, and which impounds but little more water than would the much smaller dam on the southern fork of the Cheyenne. The appropriation of the state for the carrying on of preliminary work has been exhausted before the survey had been completed and business men of Fall River county donated \$1,000 to the work to get it carried through this fall, and in shape to present the matter in the coming congress for consideration, and the attempted preliminary steps toward making the project a reality.

The new \$6,000,000 dam at Bassano, Alberta, will be opened soon, according to official announcement coming from the Canadian Pacific railway in regard to the project of checking the Bow river, western Canada.

By the system of irrigation which the opening of the dam inaugurates, 1,000,000 more acres of land will be opened up and the settlers will be insured against all possibilities of a dry season, says the *Star*. At present 8,000 acres of the territory affected belongs to the estate of the late Duke of Sutherland.

Send \$1.00 for 1 year's subscription to the IRRIGATION AGE and bound copy of THE PRIMER OF IRRIGATION. If you desire a copy of The Primer of Hydraulics add \$2.50 to above price.

THE NORTHERN PACIFIC COUNTRY

Some Observations of That Territory

Discussing the northwest country traversed by the Northern Pacific recently with Mr. A. M. Cleland, general passenger agent, it was learned that conditions were all that could be asked in the way of crop production, satisfaction of settlers on the land, prices for the products sold and other features which go to make up the ranchman's life. It was stated, however, that there must be some arrangement made whereby the producers of large quantities of apples and other fruits may be able to market them at a profit in the middle and eastern states. When asked what was the cause of so much fruit going to waste in the west, Mr. Cleland was apparently reluctant to answer. He finally stated, however, that in the opinion of the producers the commission men throughout the middle and eastern states are largely to blame for the conditions which now exist. He stated that on a recent trip through the Northwest over the Northern Pacific lines which was taken with a train load of general passenger agents of the various railroads of the United States who were visiting Yellowstone Park and other points of interest along that line, large quantities of fruit were found upon the ground unpicked and unmarketed. He stated that some way of getting these fruits onto the market must be devised whereby, when they are marketed and sold the producer will obtain his share of the profits.

His idea is that the cider industry has not been properly developed and he believes much more may be made by turning all his apples into cider. His experiment may offer a suggestion to some of our Western producers. They of course are not as near the market centers but a half dozen or fifty of them could join together and ship their products to some central city in Illinois, Iowa, Wisconsin, Michigan or Indiana and distribute from there and rent a modest priced storeroom from which to retail the fruit.

The foregoing is preliminary to a general discussion of conditions along the line of the Northern Pacific Railway, and the following data was secured from officials of that system.

Prosperity and contentment are the words which best describe the recent marvelous achievements in the Northwest, where the pioneers and those who followed them have, seemingly, made something out of nothing. This one time sagebrush country only, long looked upon as an absolutely worthless desert, has become a crop-producing, home-supporting area of inexhaustible fertility, greater in extent than the cultivated lands in New England and capable of supporting a larger rural population.

Out of the old arid wastes have sprung wonderful orchards, vineyards, berry fields, truck gardens, and fields of golden grain and waving grasses. Towns and villages peopled with a happy, optimistic population, and comfortable homes in the country inhabited by a satisfied yet energetic husbandry, dot the landscape. Banks, liter-



A Barley Field in Lower Yellowstone Valley, Montana.

In discussing this matter later with commission men in Chicago the writer learned that they are exceedingly reluctant to express an opinion on the subject. They were inclined to criticize the railways and said the freight rates had to do with this condition. It had been learned previously, however, through investigation at other points that the railways are offering every inducement in the way of freight rates, and it may eventually simmer down to a condition where the fruit producers must open up their own market in the Eastern and Central States and have the product of their ranches handled by some competent man. This brings to mind the fact that a farmer in Southern Illinois who is interested in business in Chicago has adopted a method which could be adopted by Western ranchmen who are large producers. Mr. George B. Cogdal, a well known merchant of Chicago, owns three farms, two in Michigan and one in Southern Illinois. The Southern Illinois farm has on it an orchard of high grade apples, Jonathan and Ben Davis varieties, and he had adopted the system of renting stores in such towns in Illinois as Elgin, Aurora, Oak Park and elsewhere, and selling the product of his orchard at retail. He informed the writer recently that he is getting twice as much for the apples as he would have gotten through a commission house and in many instances, four times what he could have sold for when the apples were made into cider.

ally bulging with the wealth of their depositors, and railroads and commercial and industrial enterprises are convincing exponents of the march of progress in what was the desert wilds less than two decades ago.

This wonderful but actual transformation is due to irrigation, the bringing to the soil the waters from streams which, constantly eating away the mountains and foothills, supply new life principles in the form of rich alluvium from the decaying rocks and vegetation of the uplands.

Irrigation has been practiced from the very earliest days of Egyptian civilization to the present time. It is only, however, in comparatively recent years that any particular attention has been paid to it in this country. The reason for this is obvious. In the eastern and middle states it is not absolutely necessary. It was only when the pioneers, traveling west in search of unoccupied territory, reached a region where without the application of water to the soil nothing could be grown, that irrigating streams were turned upon the desert, which readily responding to the beneficent influence soon began to blossom like a veritable garden. From this period up to the present time the work has been spreading and increasing until now vast tracts of what was once known as the Great American Desert have been brought under cultivation.

Irrigation invariably means intensive cultivation. Many

a man today is making a far better living on ten acres of irrigated land, than can be secured by an equal amount of hard work on a quarter or even a half section of ordinary farming land, while, as a matter of fact, those best posted on the subject insist that twenty acres of irrigated land is about all that one family can properly look after, even with a reasonable amount of help.

The economic value of irrigation, whether by national projects or private enterprise, cannot be measured in dollars and cents. It is no longer an experiment in this growing western country; it is a confirmed success from commercial and financial viewpoints, and the influence of its far-flung horizons and its true perspective are potential in character-molding and building. There is inspiration in the vastness of this westernness, where men and women and children breathe optimism and grow mental breadth and strength in contemplating scenery, declared by seasoned travelers to have no counterpart in the world. The development of the country will provide a safety valve against the impending dangers of congestion in the cities of the east.

It has been demonstrated that under irrigation western land will produce paying crops of anything which grows in the temperate zone. The products are noted for their brilliant coloring, unusual size and excellent flavor, and they command the markets of the world. Vegetables in

Spokane county, while Yakima county planted 358,477 and Chelan county, which includes the Wenatchee district, planted 301,784.

Yakima county leads with 2,115,695 apple, 667,704 pear, 857,300 peach, 179,166 cherry and 24,081 plum and prune trees. Chelan county has 1,138,012 apple, 77,407 pear, 338,073 peach, 54,565 cherry and 18,212 plum trees, and Spokane county has 967,197 apple, 54,707 pear, 154,323 peach, 163,324 cherry and 40,943 plum trees. The distribution of apple trees in six other counties in eastern Washington is as follows: Asotin, 87,415; Benton, 188,187; Okanogan, 27,670; Stevens, 251,839; Walla Walla, 84,429; Whitman, 266,133.

In addition to the foregoing there are in eastern Washington approximately 2,500 acres of grapes, 2,400 acres of raspberries, 2,000 acres of blackberries, 9,000 acres of strawberries, 675 acres of currants and gooseberries, 350 acres of cranberries and thousands of acres of lands devoted to garden truck farming, besides 2,500,000 acres devoted to wheat and other grains, which do not require irrigation.

The extent of operations on irrigated lands in the Northwest will be better understood when it is known that the value of apple and other fruit crops in the Inland Empire amounted to \$14,000,000 in one year. It will be better than \$60,000,000 in 1914, by which time several



Second Year from Sagebrush. Huntley Project, Oats Yielded 120 Bushels an Acre.

almost endless variety and the choicest vine and tree fruits follow each other in rotation and fill out the seasons. There is courage born of conviction and fostered by hope in the superabundant life which springs from the broad desert when moisture is applied, and this gives a constant inspiration to industry and stimulus to greater things.

Five to ten acres of land in the irrigated districts will provide shelter, food and raiment for a family and enable its owner to put aside from \$500 to \$1,000 a year. Scores of hundreds of men and women, many of whom came from the crowded cities in the east and south, are doing that much or better in the Inland Empire today. The home making instinct, characteristic of the true American, won out and as a result they are independent and able to dictate the prices of their products.

Statistics compiled by the State Commissioner of Horticulture show that approximately 227,500 acres of lands in the state of Washington are devoted to fruit culture. A census of the trees shows 7,677,072 apple, 2,126,222 peach, 1,313,290 pear, 1,238,491 plum and prune, 938,744 cherry, and several million nectarine, quince, almond and English walnut trees. The plantings in one year amounted to 2,067,853 trees, as follows: Apple, 1,169,989; peach, 366,731; pear, 230,719; cherry, 190,535; plum and prune, 70,200; miscellaneous, 39,679. Of these 399,553 or 20 per cent of the grand total were planted in

million trees set out in the last two years will come into bearing.

This is only the beginning of the fruit industry in this part of the country, where millions of acres of land, now flecked with the dusty green of sage brush, are awaiting the refreshing moisture to make them blossom like the proverbial rose. Irrigation will supplement the rainfall and do much more for the growing crops than rain, as the natural element gives nothing except moisture, while the waters diverted from the mountain sides bring with them new fertility. Much of this land, now not worth more than a few dollars an acre, will then be readily salable at from \$250 to \$500 an acre, according to location and the character of the soil. That is the history of lands in the now famous Bitterroot, Yakima, Wenatchee, Lewiston-Clarkston and Spokane valleys, where the incomes from fruit range from \$450 to \$2,000 an acre.

Send \$1.00 for 1 year's subscription to the IRRIGATION AGE and bound copy of THE PRIMER OF IRRIGATION. If you desire a copy of The Primer of Hydraulics add \$2.50 to above price.

IRRIGATION AND DRAINAGE

To Be a Feature at Panama-International
Exposition.

Agriculture, that vast contributor to the support and wealth of nations, is to be one of the most important departments of the Panama-Pacific International Exposition, now in the making at San Francisco and whose gates will open in February, 1915. Two magnificent exhibit palaces, devoted to agriculture and to food products, are among the fourteen that are being erected by the exposition company, and a most comprehensive classification of exhibits has been prepared by Captain Asher Carter Baker, director of this important feature of the fair.

In Captain Baker's classification of agricultural exhibits the subject of irrigation has been given ample representation. In the grouping of farm equipment and methods of improving lands will be

and beverages, inedible agricultural products such as the textile plants, useful insects and their products, injurious insects and plant diseases. A complete exhibit of forestry and forest products is also included, as are numerous special features mentioned which space forbids.

In connection with the general agricultural exhibit there will be the most comprehensive exhibit of live stock ever made at any previous exposition. This department is under the supervision of D. O. Lively, organizer and manager of the Pacific Northwest Live Stock Association, and one of the foremost authorities in his line. He is assisted by Chas. F. Mills, of Springfield, Ill., who is chairman of the advisory committee to the live stock department. Prize cattle from all parts of the world will be on view, together with horses and mules, sheep, goats, swine, dogs, cats, ferrets, rabbits, birds and poultry. Methods of breeding and raising, breed milk contests, running and harness races and many other



Truck Garden, Huntley Project, Montana, Showing Potatoes, Corn, Cabbage, Tomatoes, Beans, Peas, Carrots, Melons and Cucumbers.

found a complete exposition of material and appliances used in agricultural engineering, for the reclaiming of marshes, for irrigation and drainage. Another important group is constituted by exhibits relating to the theory of agriculture—to studies bearing upon soil and water from an agricultural point of view. The up-to-date methods and appliances will afford an unequalled educational opportunity to the farmer from any part of the world.

In this educational connection, a determined effort is being made by the exposition authorities to secure the 1915 meeting of the National Irrigation Congress for San Francisco.

Besides the groups above mentioned, the departments of Agriculture will comprise detailed displays of agricultural implements and farm machinery, fertilizers, appliances and methods used in agricultural industries, agricultural statistics, animal and vegetable food products and vegetable seeds, appliances for gathering wild crops and the products obtained, equipment and methods employed in the preparation of foods

features will be embodied in the exhibits and displays of this department.

NOTES.

M. Z. King, of Oklahoma, wants to end drouths in the arid regions of the Southwest by daming the Grand Canyon of the Colorado with rock and concrete. He says that a lake of 4,000 square miles could be made and that this amount of water, distributed at will, would insure crops.

King has progressed so far in his scheme that he has had an oil painting made of the Grand Canyon as he proposes that it shall be. This painting was on exhibition at the fair at Oklahoma City and King lectured about it daily. He will take it to the Dry Farming Congress at Tulsa and after his lectures there will donate it to the historical society.

"Rhubarb king of Oklahoma" is the title by which J. W. LaGrange of Yukon is known. Even a casual visit to his farm would serve to establish the merit of the claim. It stood four and five feet high and was yielding from ten to fifteen tons an acre and selling for 6 to 12½ cents a pound. Mr. LaGrange leases the farm from A. S. Perry, who for years was a successful irrigation truck grower of central Oklahoma.

VARIOUS PROJECTS ALONG GREAT NORTHERN RAILWAY LINES

Valuable Information for Prospective Settlers

Montana, the third largest state in the Union, offers the landseeker an unlimited number of opportunities for home making. At the present time the homeseeker may acquire a tract of good farming land by purchase or by exercising his homestead right and commence to lay the foundation for a career of independence, comfort and perhaps wealth. Every day, knowledge of the opportunities which exist in this wonderful state is spreading and every day new settlers are moving into the state and establishing themselves on the fertile land. Land values are increasing rapidly, in fact, the last five years have witnessed an increase in value of land from \$5.00 to \$25.00 per acre. They who investigate and take advantage of the opportunities now will profit by the increase in land values as well as receive the benefit in the meantime of the productivity of the soil.

Montana Irrigation Projects

In addition to the free homestead land and land in private ownership, the homeseeker may acquire land on the irrigation projects in this state by complying with the homestead laws. The United States Reclamation Act of June 17, 1902, provides for the creation of a fund from each state in the so-called semi-arid belt for the construc-

thereof, to get water from the government project, must sell down his holdings to the unit acre prescribed by the government, and pay his share per acre of the cost of construction; also, be a bona-fide resident of the land.

An annual charge for maintenance is made, in addition to the cost of construction. This is usually about fifty cents per acre the first year, and may be reduced somewhat for subsequent years. The occupant of the land is required to cultivate at least one-half of the irrigable area in his farm, and the charges for maintenance are apportioned upon the actual amount of land in his holdings, irrespective of the acreage under cultivation.

To assist the landholder who is not familiar with irrigation, the government—and, in some cases, the Water-Users' Association—maintains experimental farms for the purpose of instructing the farmers in the best methods of treating the soil.

Water-Users' Association

Immediately upon the opening of an irrigated tract to settlement, a Water-Users' Association is formed. The Government Reclamation Service operates the irrigation system until the greater part of the cost of constructing the works is paid up by the settlers, after which title to same passes over to the association. Shares in the Water-Users' Association are issued to the members in amounts corresponding with the acres of land they own in the project. The water-rights are, of course, inseparably associated with the land.



Farm Home in Lower Yellowstone Valley, Montana.

tion of irrigation projects on a large scale within those states. The fund for prosecuting this great work is accumulated from the sale and disposal of public lands.

Methods of United States Reclamation Service

Briefly told, the United States Reclamation Act, of June 17, 1902, provides for the creation of a fund from each state in the so-called semi-arid belt for the construction of irrigation projects on a large scale within those states. The fund for prosecuting this great work is accumulated from the sale and disposal of public lands.

The United States Reclamation Service constructs the projects and puts the settlers on the land when it is ready for crops. The land is divided up into farm units, ranging from 40 to 160 acres in size. The settler files on the land in accordance with the homestead laws of the United States, paying the government his proportion of the actual cost of constructing the irrigation system. This construction cost varies, ranging from \$30.00 to \$35.00 per acre, and up. Ten years are granted the settler in which to pay this cost, payment being made in ten annual installments, the first installment being paid when filing on the land. No interest is charged on the unpaid cost. Frequently, some of the land under a government project is in private ownership, in which case, of course, none of the provisions of the homestead laws apply, except that the owner

Carey Act Projects

The Carey Act, passed by the United States Congress in 1894, is another potent factor in the irrigation and peopling of vast stretches of rich agricultural land in Montana. Its purpose was to induce the western states affected thereby to inaugurate systems of irrigation on unappropriated government land through contracts with private corporations or individuals. One million acres are available in Montana for this purpose. Practically, 500,000 acres are now being developed. The state has effective laws for the administration of this work, and its Carey Act Land Board has direct supervision of the projects. Not more than 160 acres of irrigated land can be taken up by a single settler under the Carey Act. Any citizen of the United States, or anyone who has declared his intention to become a citizen, is entitled to avail himself of this opportunity. Many decided advantages are enjoyed by the settler in the working out of this law.

The corporations constructing the projects contract with the state for the irrigation of a certain tract of land, the price to be charged to the settler by the company for his water-right being agreed upon between the state officials and the construction company. Upon the completion of the project, the government issues a patent to the state for the land as it is settled upon, and, in turn, patent is

issued to the settler by the state upon the payment of fifty cents per acre, and the filing of contract between the construction company and settler showing payment of first installment on the cost of the water-right of the company. Proof of residence and cultivation must also be made. Under the advantageous administration of this act in Montana, it is possible for the settler to secure patent from the state within thirty days from date of filing, provided one-eighth of the land taken is put under cultivation and other requirements are observed. After patent to the land is obtained by the settler, the matter of residence thereon is optional.

Lower Yellowstone Irrigation Project

The lower Yellowstone irrigation canal, constructed by the United States Reclamation Service, will reclaim about 40,000 acres of land along the west bank of the Yellowstone river, including a territory starting south of Mondak, on the main line of the Great Northern, to a few miles north of Glendive, about 55 miles long and from one to five miles wide, in eastern Dawson county.

The complete canals will irrigate about 40,000 acres, the water being supplied by the Yellowstone river, whose minimum discharge at the point of diversion is 1,000 second-feet, this minimum occurring during January and February.

There is some public land open to entry under the project, but the majority of farms are under private ownership. The public lands are divided into units of from 40 to 80 acres and may be homesteaded by any one who has not previously exercised his homestead right. At the time filing is made the homestead entryman must pay the first installment upon the cost of his water-right, which is \$6.50 for 40 acres and \$8.00 for 80 acres.

Land under private ownership ranges from \$20.00 to \$30.00 per acre, and the extra charge for water-right under the project is \$45.00 an acre, without interest payable as follows:

December 1, 1913.....	\$2.00 per acre
December 1, 1914.....	4.50 per acre
December 1, 1915.....	4.50 per acre
December 1, 1916.....	4.50 per acre
December 1, 1917.....	4.50 per acre
December 1, 1918.....	4.50 per acre
December 1, 1919.....	4.50 per acre
December 1, 1920.....	4.50 per acre
December 1, 1921.....	4.50 per acre
December 1, 1922.....	7.00 per acre

The cost of maintaining and operating the canals will be from \$1.00 to \$2.50 for each irrigable acre extra.

Considering the assurance of crops under this project and the opportunity for securing good land either by homesteading or by purchase at a low price, the ultimate cost of the land, including water-right, will amount to from \$65.00 to \$80.00 per acre.

The soil throughout the entire project possesses almost exhaustless fertility. It is of a loam, or clay loam, of a rich brown color due to a high percentage of organic matter.

The principal crops are oats, barley, flax, wheat, vegetables, sugar beets, alfalfa, etc. The average yield of alfalfa is five tons per acre. Oats have averaged as high as 120 bushels, potatoes 400 bushels, barley 60 bushels, flax 17 bushels to the acre, etc.

Stock raising, dairying, etc., are carried on extensively, netting profitable returns to the farmer.

With the construction of the new Great Northern line through Fairview, Sidney, Newton, etc., additional transportation facilities will be afforded, making the Yellowstone project one of the most attractive localities of the Northwest for the farmer desiring to secure an irrigated farm.

The Milk River Irrigation Project

The government has withdrawn from entry over 1,000,000 acres of fertile land in Teton, Hill, Blaine and Valley counties, with a view of establishing an enormous irrigation project, known as the Milk River project.

The magnitude of the work is shown by the extent of territory that is embraced within the plan of reclamation. The Great Northern follows the Milk river through this part of Montana and in addition to transportation numerous large and small towns are already established.

This project, which is about 16 per cent completed, consists of two large engineering schemes. First, the

storage of the water in St. Marys Lakes in the north-western part of Teton county, on the eastern slope of the Rocky Mountains, and the carrying of the water by means of a canal 27 miles to the north fork of the Milk river. Second, the utilization of these stored mountain waters on the irrigable lands of the lower Milk river valley, extending from Havre, in Hill county, to Glasgow in Valley county, a distance of 155 miles.

The Milk river has its source in Teton county, tributary to St. Marys lake, and its two forks flow northeast into Canada, where they unite, thence continuing as Milk river proper in an easterly direction for about 100 miles, re-entering into Montana in Hill county, finally emptying into the Missouri river in Valley county, east of Glasgow.

In the Milk river valley and vicinity at the present time there are close to 90,000 acres of land under irrigation, producing the usual bountiful yield of practically all crops. The soil throughout the entire valley is of sufficient depth and character to grow crops at present without irrigation; however, with the completion of this mammoth project, and in view of the fact that the land is near transportation, many settlers will, without doubt, quickly occupy the lands, build up thriving communities and add to the wealth and population of the state.

The Milk river project, as originally designated, contemplates the reclaiming of about 250,000 acres of land in two divisions. First, 100,000 acres near Dobson, Chinook, etc. Second, 150,000 acres extending from the Dobson diversion dam, eastward to Glasgow. The canal lines necessary for watering these lands will approximate 380 miles in length.

The first unit under the Dodson canal, near Dodson, on the Great Northern, is nearly completed. About 10,000 acres are contained under this unit and the water is being supplied on a rental basis at the price of about \$1.00 per acre foot. The land under the constructed canal is divided into 87 farm units of various sizes.

In 1908 the Lower Milk River Water-Users' Association was formed, and in 1910 it entered into a contract with the government guaranteeing the paying to the United States of the cost of the irrigation works as assessed by the Secretary of the Interior against the lands of the shareholders of the association.

With the agreement arranged with Canada as regards the use of water flowing across the boundary line and an appropriation for the Reclamation Service to carry on the work of the Milk river project, the same will, no doubt, be completed as rapidly as possible.

The Valier Irrigation Project

In October, 1909, the Carey Act Board of the State of Montana threw open for settlement 70,000 acres of irrigated land in Teton county, near the town of Conrad, on the Great Northern. Since then additional land has been acquired until at the present time there are about 116,000 acres of irrigable land under the project, about 40,000 acres of which are now under cultivation.

Any citizen of the United States can file upon 40, 80, 120 or 160 acres of land under this project, and own the land and perpetual water-rights by paying \$40.50 per acre on 14 years' time. The terms upon which the settler may enter a claim on these lands are, the payment of fifty cents per acre as an entrance fee to the State of Montana, and \$40.00 per acre, which pays back to the construction company the charge per acre for the installation of the irrigation system. The sum of \$5.50 per acre must accompany the application at the time filing is made. The balance is payable in 14 equal annual installments, with interest at six per cent on deferred payments, beginning with the delivery of water.

The land is covered with native grass, ready for the plow. The climate is very favorable, and coal is mined on the tract. Flax yields of 24 bushels per acre, 100 bushels of oats, 40 bushels of wheat, 40 bushels of barley and proportionate yields of other grains as well as vegetables are reported from the farmers on the project. The average yield of wheat for 1912 on the project was 38.5 bushels, 75.1 bushels of oats and 57 bushels of barley per acre. Potatoes yield well and sugar beets grow easily. Garden truck thrives under the long days of sunshine, and two or three cuttings of alfalfa are received each season. Timothy, clover and other cultivated grasses grow luxuriantly either for meadow or pasture.

The soil is uniform in character, running from a chocolate to a clay loam. The sod works up mellow and fine

after backsetting. The surface of the land is gently rolling, draining well, and the soil lends itself readily to irrigation.

Dairying and stock raising are carried on extensively by the farmers on the project, at a profit. The local consumption of Conrad and Valier, both thriving towns on the project, can hardly be met for butter, eggs, meats, etc., and considerable produce is also shipped to Great Falls. Valier has grown very rapidly since the establishment of the project, as has Conrad, on the eastern boundary of the tract, and connected by the Montana Western railroad with Valier. The Great Northern traverses the eastern and northern sections of the project, and Williams and Manson are new towns recently established and on the Montana Western railway.

The Sun River Irrigation Project

The irrigation plan for the Sun river project provides for the storage of water in the Warm Springs reservoir, of the north fork of the Sun river—in the Willow Creek reservoir on Willow creek—in Pishkun reservoir north of Sun river and in Benton Lake reservoir, near Great Falls. There are 13 reservoirs in all and it is estimated that 276,000 acres will be reclaimed in all.

The first portion of the project, viz.: The Fort Shaw unit, is completed and nearly all the irrigable land has been appropriated under this unit, although there are a few 40 and 80 tracts left. The charge per acre is \$30.00, including water-rights, payable in ten annual installments, without interest. The annual operation and maintenance charge is fifty cents per irrigable acre.

The new line of the Great Northern to Augusta furnishes transportation for this fertile and productive region and practically all crops, as well as small fruits, do well. Three cuttings of alfalfa per season is reported and yields about five tons to the acre.

The Fort Shaw unit consists of about 16,000 acres, and the Reclamation Service are working another unit at the present time, to be completed soon. As only about 9.5 per cent of the entire project is completed there will be available homes for thousands of farmers to secure fertile land when water is furnished the balance of the proposed project.

The Flathead Irrigation Project

The Flathead project has for its plan the irrigation of about 150,000 acres, in various parts of the former Flathead Indian Reservation, which was opened to white settlement in 1909.

The water is to be taken by simple diversion works from several rivers and creeks, having their source in the Mission Mountains near by. The stream flow is to be conserved by storage in twelve reservoirs, and is supplemented by pumping from the Flathead river by water power.

Irrigable tracts in Jocko and Mission valleys and near Polson have been selected for the first development, and the system is sufficiently advanced and is supplying water at present for several thousand acres.

All the cereals usually yield a big crop without irrigation, as the land is very fertile without being artificially watered, when properly farmed, but with irrigation, the crop will not only be a sure one but the yields increased. Alfalfa is becoming one of the principal crops; also vegetables, small fruits, etc., do exceptionally well.

The irrigated area in the Flathead project is lands which have been allotted to the Indians, and land filed on by those successful in receiving a lucky number when the reservation was opened. These farmers are not able to care for a large tract when irrigated, therefore they are disposing of a portion of their holdings at reasonable prices, and there are numerous opportunities for securing fertile irrigated farms in an ideal section for general farming.

The Fort Peck Irrigation Project

The Fort Peck project has for its purpose the irrigation of about 132,000 acres in the Fort Peck Reservation, as follows: 8,000 acres in the vicinity of Milk River station, with water supply from Big Porcupine creek conserved by storage; 2,000 acres in the vicinity of Frazier, with water supply from Little Porcupine creek by storage; 20,000 acres in the vicinity of Poplar and extending along the Poplar river 35 miles, with water supply from that river conserved by storage; 15,000 acres lying along the west side of Big Muddy creek, with water supply from that

creek conserved by storage at the mouth of Wolf creek; 50,000 acres of clear bench lands and approximately 25,000 acres of brush and timber land extending along the Missouri river with water supply from that river by a gravity canal. Two tracts of 6,000 acres each, adjacent to and above the gravity canal that can be irrigated by pumping from the Fort Peck canal with lifts of from 12 to 20 feet.

In July, 1908, investigations and surveys were begun by the government and in September, 1909, construction on the Little Porcupine unit was commenced, which is about 90 per cent completed at present.

The Poplar river unit is about 8.5 per cent completed and the entire project 5.1 per cent completed.

THE VIKING ROTARY PUMP

The accompanying illustration shows the principles of an interesting rotary pump manufactured by the Viking Pump Company of Cedar Falls, Iowa, which has recently been tested at the Engineering Experiment Station of the Iowa State College and is described in the *Iowa Engineer*. As will be seen in the illustration, the pump has but two moving parts, an outside annular gear, and an inside spur gear. The large gear has a shaft at the back which extends

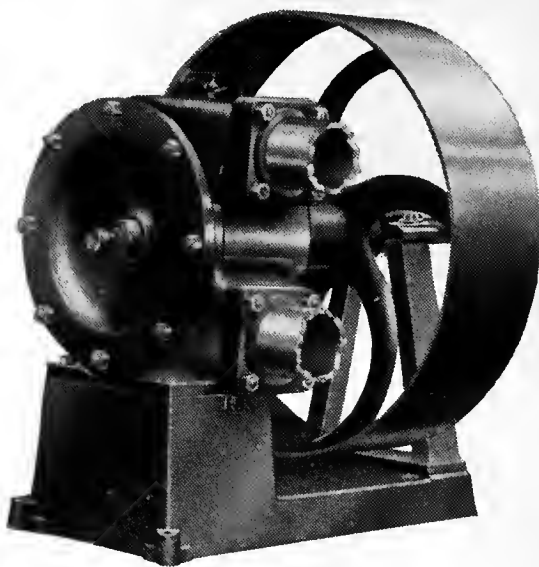

Viking Rotary Pump

through the pump casing and carries the driving pulley. The spur gear is mounted on a stud extending from the opposite side of casing, which also has a crescent shaped projection on one side, dividing the space between the two gears as shown. Either pipe may be used for the intake, depending upon the direction of rotation. The action of the pump is evident. After the water enters the pump, it is carried around in the pockets formed by the teeth in the large gear and the teeth of the spur gear and the crescent shaped projection. When the gears come into mesh on the opposite side, all water is forced into the outlet port.

Tests have been made with heads varying from 30 to 150 feet of water and at speeds from 200 to 450 R. P. M. At 215 R. P. M. the efficiency was 48.6 per cent. At 400 R. P. M. the efficiency was 76.3 per cent. The average efficiency of all tests was 64.8 per cent, the average speed being 360 R. P. M. At the higher velocities, the average efficiency was practically 70 per cent. The comparatively positive action of the pump is shown by the discharge per revolution. At the lowest efficiency this discharge was 0.209 gallon, and at the highest 0.235 gallon, which shows that even at the lowest efficiency the leakage was slight. The volume of water discharged per revolution, if there was no leakage, would be 0.259 gallon.

The advantage of the pump is that it requires no packing, it is said to have a positive force that can put water to a greater height than any other rotary or centrifugal single pump with less power. The speed being slow, there is less wear and each gear carries its own weight.—Adv't.

IRRIGATING THE SMALL FARMS

The unusual dry growing seasons the past two or three years followed by this summer's drought has helped to impress the fact in the mind of the average farmer located out of the irrigation districts, that supplemental irrigation is desirable and necessary in other places outside of the arid regions.

Many small farmers and orchardists who depend entirely upon the rainfall during the growing season find that a period of drought will often ruin their prospects, resulting in money losses which may often exceed the first cost of a simple gasoline or kerosene engine driven pumping equipment with its necessary distributing piping. Such a device will not only insure the safety of a crop but it has been demonstrated beyond question both by practical experience and by systematic experiment that growth and production can be profitably pushed by irrigation even when the natural moisture seems ample, and in this respect irrigation aligns itself with fertilization and cultivation as a factor in intensive culture.

The impression prevails that considerable capital and engineering skill are necessary to success, but as a matter of fact profitable irrigation is easily attainable by small effort and moderate expenditure. It is the ignorance of the ease and cheapness with which a farm water supply can be stored and distributed, that has debarred the average small farmer from the wonderful benefits derived from irrigation. With few exceptions water is readily available for pumping from perennial streams, brooks or lakes. Otherwise, wells either open or of the driven

acres will therefore require in 100 days (24x27150x50) equals 32,580,000 gallons or 325,800 gallons per day. Assuming that the gas engine driven pump will operate eleven hours per day, 325,800 divided (11x60) equals 494 gallons per minute. Allowing say twenty per cent for evaporation and seepage the pump must have a capacity of about 600 gallons per minute. Assuming that water must be raised say twenty feet from level of source of supply to point of discharge, we will have 600x20 equals 12,000 foot gallons, which, divided by the constant 4,000 will give three water horse power. Allowing an efficiency of fifty per cent for the pump, a six-horse power gasoline engine would be about right for the service. The initial cost of a six-horse power Ingeco engine and 600 gallon centrifugal pump with five-inch discharge will be approximately \$300. Such an engine would use about 13½ cents worth of gasoline or kerosene per hour based on a cost of 18 cents per gallon for gasoline or 7 cents for kerosene, which would cost \$40

A few words regarding the Ingeco engine may not be amiss. The engine is built vertical or horizontal in all sizes from 1½ to 350 horse power, suited for all kinds of light oils and gaseous fuels such as distillates, gasoline, kerosene, also artificial or natural gases. Large size engines are also running successfully with light and heavy crude oils, giving wonderful efficient service with low cost of maintenance.

The I. G. E. Co. are fully prepared and pleased to give full particulars of their engines and pumps and on receipt of detailed information will make up estimates and recommendations.

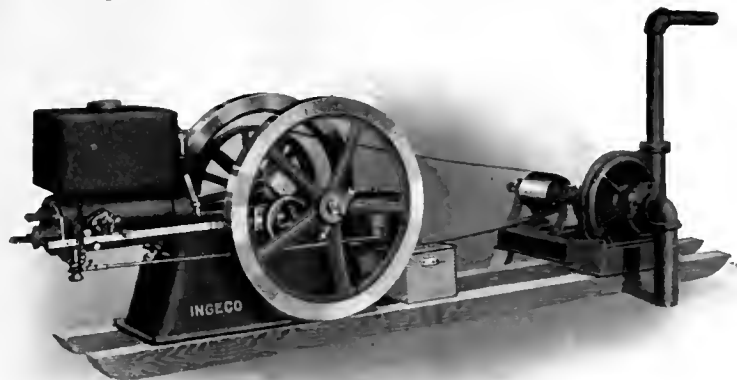

Deep Well Head Attached to Ingeco Gas Engine.

type can be used and fitted with moderate cost pumping apparatus direct belted to gasoline or kerosene engines.

The Ingeco Farm Engine operating a low lift Worthington centrifugal pump as illustrated herewith has been very successfully used on many small farms during the growing season. The apparatus is self-contained and runs continuously without the aid of a constant attendant. The economy of operation will appeal to the user, and also the fact that the portability permits its use for other farm usages, if desired.

Where water is obtained from wells this same engine is used in connection with belt driven deep well pumps which are furnished complete with the outfit. Naturally the lay of the land will determine the advisability of distributing the water either through earthenware tile, ditches, or open flumes.

The small farmer being impressed with the importance of irrigation will naturally be interested to know the size of pumping equipment, first cost, and also cost of operation. Therefore, assuming that water may be advantageously applied to the land when less than one inch of rain falls, say in a fifteen-day period of drought, we would advise an average of eight acre inches per month during the irrigating season of three months. This amount is considered very ample and is equivalent to a quantity of water which will cover one acre eight inches deep.

Let us therefore base our figures on irrigating a fifty-acre tract during the irrigation season lasting say 100 days and demanding twenty-four acre inches during this period. Now one acre inch equals 27,150 gallons. The fifty

GOLD MEDAL CAMP FURNITURE.

On another page of this issue will be found an advertisement of the Gold Medal Camp Furniture Manufacturing Company, of Racine, Wisconsin. The product of this firm is well known by all military men and by all campers throughout the United States; in fact, goods manufactured

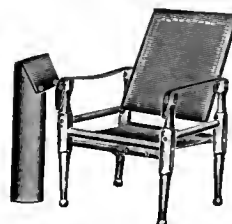

CAMP FIRE CHAIR.



CAMP BED.

by this firm are shipped all over the world in large quantities. They comprise a large variety of articles, many of

which are equally useful for the house and porch as well as for the camp.

Shortly after the Spanish-American War, many of the articles manufactured by the Gold Medal Camp Furniture Manufacturing Company were adopted as standards in the United States army and navy; namely, their cot, one of



CAMP CHAIR.



CAMP STOOL.

their chairs, one of their stools, and their mosquito bar frames and nettings, and even their portable bath tub is the standard of the United States Medical Department of the army.

This firm sells its product entirely, where possible, through dealers and jobbers in this line, and the demand for their goods is continually increasing.

Their catalogue is free to all who may request it.

CONCRETE CELLAR STEPS AND HATCHWAY.

Construction of Permanent Steps and Watertight Walls.

A damp cellar under a dwelling is frequently the unsuspected cause of many a case of sickness. Often this dampness is the fault of a poorly built entrance-way. If water gains access by means of leaky hatchway walls, the cellar becomes unsanitary and the health of the entire family is endangered. This peril can be dispelled by making the walls and steps of concrete.

The methods of building hatchways for either new or

and end walls one foot below the concrete of the steps. As forms choose two 1 by 12-inch boards and notch them as though they were to be used as "horses" to support wooden steps of the same dimensions as those of concrete. Place the notched edges down with the ends fixed at the top and bottom of the stairs. To mold the rise of the concrete steps, use 1 by 6-inch boards 3 feet 10 inches long, which are secured to the forms by means of nails and wooden cleats.

With the forms firmly fixed in position, fill the mold for the bottom step, and the space back of it, with concrete proportioned 1 bag of Portland cement to 2 cubic feet of sand to 4 cubic feet of crushed rock. If bank gravel is used, mix the concrete 1 part cement to 4 parts gravel. Bring the concrete in each step to the top of the riser and finish the surface with merely a wooden float. Continue the work upward until all the steps are finished. At the top of the stairs tie the apron foundation to the side walls by means of old iron rods imbedded in the concrete and extending around the corners. This will prevent possible heaving and cracking by frost.

The side forms of the six inch walls are then erected and are thoroughly cross-braced against each other. For these forms use 1-inch siding on 2 by 4-inch studding spaced two feet apart. The walls can be carried to any height desired so as to give the cellar doors sufficient slope for shedding rain-water. Above ground line, outside forms must be provided. Fill the walls with concrete mushy wet. Before the concrete sets, bolts are placed (heads down and washered) in the top of the side walls for holding the wooden sills to which the cellar doors are hinged. After two or four days the forms can be removed. Connect up the drain in the landing and lay the landing floor.

The eight cellar steps of the hatchway shown in the

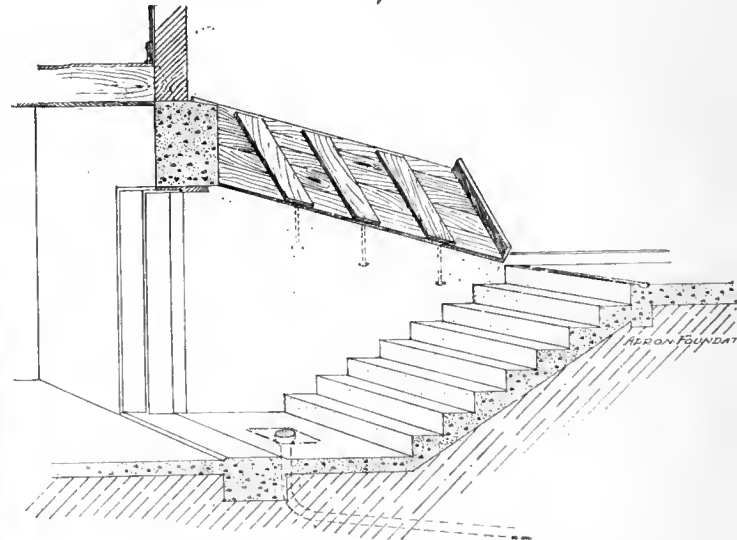

plan have a tread of nine inches, a rise of six inches and a length of four feet. The clear height of the door-way in the cellar wall is six feet six inches. The landing at the foot of the steps is three by four feet and has a four-inch concrete floor. This same thickness of concrete lies under the steps proper. The side walls were built as described above. For this improvement there were required the following materials:

Bill of Materials

Crushed Rock	2½ cubic yards
Sand	1¼ cubic yards
Portland Cement	12 bags

For improving old cellar hatchways it is frequently necessary to fill with earth and gravel so as to provide the earthen slope for the concrete steps. Such filling must be thoroughly tamped into place and should be water-soaked and allowed to settle before the steps are built.

Concrete steps, unlike other kinds, become stronger with age. They are perfectly safe under the heaviest of loads. Moreover, besides being water-tight, they keep out rats, mice and other obnoxious vermin.



old cellars are very similar. With an allowance for a three-foot landing at the bottom of the stairs, excavate the opening to the width of steps desired plus one foot. This extra width is for a six-inch thickness of concrete wall on each side. The steps themselves have a rise of six and a tread of nine inches. Beneath the steps proper is a four-inch thickness of concrete. Therefore provide for this thickness in sloping the ground upward from the landing to the top of the stairs. Extend the trenches for the side

CORRESPONDENCE

Washington, D. C., October 11, 1913.

Editor, IRRIGATION AGE, Chicago, Ill.

Dear Sir: I note in your last issue an article criticizing the operations of the Government on the North Platte project for constructing and using the Pathfinder reservoir. The statement is made that this is "apparently another illustration of the carelessness of the reclamation officials for the welfare of the old-time settler."

The water rights of the North Platte river have been adjudicated by the courts of the State of Nebraska. The reclamation service has rigidly respected all rights defined by the court, and these decrees have been accepted by the canals on the North Platte river which have recognized the insufficiency of the natural flow of the river in the months of July, August and September, and have to a considerable number made contracts with the United States to furnish from the Pathfinder reservoir water which is stored in the winter and spring and is to be turned down in the summer and fall to supply those rights when the river would be dry were it not for this reservoir. When numerous irrigation districts have entered into contracts, paying hundreds of thousands of dollars for such supplemental water rights, it can hardly be questioned that the need existed.

The North Platte river had been known to be dry at the Wyoming-Nebraska state line before the Pathfinder reservoir was constructed or any water diverted by the United States, and every normal year in that vicinity the river was very low during the months of August and September. The courts of Nebraska have adjudicated rights to the Tri-State canal amounting to 1,142 cubic feet per second and this is the second priority on the river. Other priorities antedating the advent of the government in the field bring this amount up to more than 3,000 cubic feet per second. Every one of these priorities, except No. 1, which is very small, is short of water every normal year during July, August and September. The Tri-State canal, heading just below the state line, has a prior right to far more water than the river normally carries during the months of July, August and September, so that if the reservoir had never been built the river would be dry during those months below the head of this canal. Obviously, the government could not make this condition any worse.

On the contrary, the government stores the water in the winter, spring and early summer, when the river is in flood, and during the later summer and fall allows as much water to flow through the reservoir, without storage, as flows in at the upper end, and in addition thereto releases stored water to an amount sufficient to supply the needs of its own canals, and of those canals with which it has contracts to furnish storage water. In addition to this, pains have always been taken to release an additional quantity of storage water beyond all legal requirements so as to utterly prevent any shadow of truthful claim that the United States has interfered with prior rights. There is considerable return seepage from the water used by the United States through the Interstate canal and from the storage water which it delivers to eight canals holding contracts for storage water. Such return waters, of course, increase the volume of the river above what it would be in the absence of the reservoir and are quickly diverted by the private canals needing the water. The distribution of the water in the State of Nebraska is supervised by the State Engineer, who doubtless makes this distribution in accordance with the court decree. If any criticism is in order it is upon the court and not upon the United States.

It is not believed that any responsible person acquainted with the facts will dispute any of the statements above. The complaint really is from people who claim riparian rights along the river and have no canals and no adjudicated water rights. The riparian doctrine requires that any one using water from the river must return it to the channel undiminished in quantity. This, of course, is directly antagonistic to irrigation uses, and has been set aside in all irrigation states. Will THE IRRIGATION AGE claim that the riparian doctrine should prevail and all

diversion of river water for irrigation should cease? Even if this claim is made, it cannot be said that the United States is a party guilty of overthrowing the riparian doctrine; this was done by the State Legislature, Board of Control, and the courts when the right to divert water for irrigation was granted and adjudicated. The United States is simply respecting the laws and decrees of the state government. If these are wrong, the campaign should be carried on against the legislature and the state courts and not against the reclamation service, which, as shown above, has positively benefited the late summer and fall condition in the North Platte valley.

Very respectfully,

A. P. DAVIS,
Chief Engineer.

Letter From the Editor of Financial World to Mr. Edward Bohm.

New York City, October 16, 1913.

Dear Mr. Bohm:

I am in receipt of recent copies of THE IRRIGATION AGE containing your correspondence and articles relating your reasons for the disasters which have overtaken so many irrigation enterprises. I thank you for forwarding these articles, as no doubt I shall find in them some valuable suggestion and ideas on which to comment in early issues of the *Financial World*.

It is, indeed, regrettable that the majority of these enterprises have found their way to failure rather than to success. Fundamentally, in my opinion, there is no class of enterprises having a sounder basis upon which to establish themselves solidly than irrigation projects, for when they are reduced to a simple conclusion the only requirements they needed to prosper were land, water and intelligent and conservative financing to develop them, and yet, through the operations of greedy finance and inexperienced engineering work, the majority of them have been forced to the wall—involving in their disaster losses upon the small investor and the homeseeker—persons who least of all could afford to jeopardize their savings.

As the different states through their Carey acts are more or less morally responsible for the prevailing demoralization of the irrigation development in their state, they should for the general good of their reputation, do something for the settlers and the bondholders, in repairing the damage.

The fight that you are putting up to awaken the conscience of the officials of these different states should, and I know will, bring to you the approval of all honest thinking people.

With kindest regards, I am

Very truly yours,

LOUIS GUENTHER.

Cleveland, Ohio, Oct. 17, 1913.

Editor IRRIGATION AGE,
Chicago.

Dear Sir: I am very much interested in the timely article appearing in the October AGE from the pen of Mr. C. J. Blanchard under caption "Cost of Water Per Acre."

The figures given are authentic, but the statement does not go far enough, nor does it do sufficient justice to the cause of government reclamation.

The important point omitted in Mr. Blanchard's discussion is as to the character of the "Water Rights" listed. I have always contended that the disputants in these matters failed to take cognizance, not only of the added element of 6 per cent interest charge upon "private," District and Carey Act Projects (which feature is emphasized in the article referred to), but of the tremendous chasm separating many of these from government projects when the element of safety is considered.

It would be interesting to have the history of some of these ventures set forth—how much has been lost by purchasers of lands, "ephemeral water rights" and still more visionary "securities." How about the Denver Reservoir & Irrigation Company and others in the list of Colorado projects, the failure of the "Conrad" project in Montana, the "French" project in New Mexico, of the Carey Act projects, the Colorado Land & Water Supply Company, the Toltes canal, the Big Lost river, the King Hill? I am mentioning only the most conspicuous failures. Many of the projects listed have never been built and some never will be.

It would be interesting to have the history of these ninety odd projects disclosed by some competent authority so that some fair basis for comparison could be arrived at. Such a discussion should include, also, the many "districts," defunct and otherwise.

Sincerely yours,

EDWARD BOHM.

Reclamation Notes

ARIZONA.

George H. Smalley, a business man of Phoenix, Ariz., has been telling Western newspaper men that before long the farmers in the Salt River valley will be raising large quantities of cotton. He states that 3,500 acres of land have already been planted with Egyptian cotton seed in an effort to see if cotton can be raised in that state, and from the present outlook it appears as though an encouraging crop will be reached when the time for picking arrives.

Andrew Kimball, president of the St. Joseph stake of the Mormon church, who resides at Thatcher, Ariz., stated recently that the present year has been one of prosperity for his state. Mr. Kimball is chairman of the Arizona commission of agriculture and horticulture and is at the present time at Tulsa, Okla., where he is attending the meeting of the International Dry Farm Congress. Mr. Kimball was one of the first Mormons to locate in Arizona and has been very successful in all his undertakings. He is a leader in the Mormon Church and is considered one of the best organizers and colonization men in the church.

C. M. Wells, special representative of the United States Land Office at Washington, has been in Arizona and made a thorough examination of the San Carlos dam and the Casa Grande Valley's irrigation project. Mr. Wells has made a careful study of the watersheds, dam sites and the diversion dam sites, the lands to be irrigated, the work of constructing a canal by the Casa Grande Water Users Association, into which the flood waters will be diverted prior to the construction of the San Carlos dam.

CALIFORNIA.

Congressman Raker, of California, recently took up a plan for a new California reclamation project with Secretary Lane and the Acting Secretary Davis of the Reclamation Service. The proposed project is located near Montague, Siskiyou county, and when in operation will irrigate 100,000 acres of semi-arid land. The plan has been favorably recommended by Supervising Engineer E. G. Hobson, and the Montague Commercial Club is pushing the project. Mr. Raker has been advised by the Interior Department and Reclamation Service that they are agreeable to the project, but the Reclamation Service has not the necessary funds at this time. Mr. Raker will endeavor to get the necessary appropriation at the December session of Congress.

The States of the West in which are located some of the largest Carey Act and private irrigation projects in the world in which are millions of acres of land awaiting the fructifying influence of the hand of the reclaimer, are particularly interested in the irrigation exhibit at the San Diego Exposition. A reclamation section will be a feature at the exposition. As land has been allotted for this exhibit, the Association is ready to do its full share in co-operation in order that the reclamation section shall be the one and only great exhibit of history.

Colonel W. H. Holabird, receiver of the California Development Company, returned to Los Angeles recently from Calexico, where he has been personally superintending the work being done by the Irrigation Company, and announced plans for extensive work of development on the great project to meet the increasing demands of the Imperial Valley district. The latest contemplated work of improvement is the building of a great dam over the New River in Mexican territory where the Encena flume carrying the supply of water from the main canal to the west side main crosses the great canyon. The estimated cost of the project is \$50,000, and Colonel Holabird states that he intends to go before the court and ask for an order, in the near future, permitting this expenditure.

The manager of the Cuyamaca water system has issued orders that no more water be used for irrigation purposes. There is a shortage of water in Cuyamaca Lake and suffering would result, it is feared, if the supply becomes much lower, hence the irrigationist will have to go without for the time being.

The third load of irrigation plants delivered since the first of the year for Valley Oaks, Cal., was recently received by Stine and Kendrick. These plants driven by electric motors are the centrifugal pump type with a capacity of 24,000 gallons an hour. About fifty plants have already been installed in this new farm land subdivision which joins Galt.

H. H. Whitmore, formerly secretary of the Madera County Chamber of Commerce, visited San Francisco recently from El Centro Imperial Valley, where he is establishing an up-to-date scientific dairy. He is in partnership with a gentleman of the name of Stearns of New York City.

One of the largest agricultural projects of the Clovis, Cal., district is the International Land Company. This concern superintended by W. T. Hamilton, introduced the proper cultivation of the fig industry. The consulting expert, George C. Roeding, is well known through that valley where stretching away through the foot hill belt, 5,920 acres flourish with figs, oranges and grapes. This land receives its irrigation through the pumping system. All this section is in the foot hill district and above the irrigation canal.

Secretary Lane has authorized the Reclamation Service to execute a contract with the Iron Canon Irrigation Association under which the Government will make surveys and a preliminary investigation to determine the feasibility of the project and prepare designs and estimates of cost. The lands embraced within the project are mainly below Red Bluff.

J. B. Hill is carrying on an experiment in the reclamation by drainage of alkali land lying near Fresno. He believes that the reclaiming of this character of land will be a success, and he bases his opinion on former efforts along that line.

W. E. Bush & Company have been awarded the contract for the colonization of the Kuhn, California, project, a tract of land consisting of 400 square miles or 260,000 acres of farm land in the north part of the Sacramento Valley.

An important business deal has been consummated whereby F. A. Cleveland becomes an equal partner with C. W. Gates in the development of 6,000 acres of lake land southwest of Corcoran, Cal.

The University of California has announced the establishment of a new Division of Rural Institutions. This new department will study and aid all the rural forces which have for their aim the making of life in the open country successful and satisfactory.

Elwood Mead has been called to the headship of this new division. He was formerly chief of the United States Bureau of Irrigation Investigations. He is now in Australia where, as chairman of the Rivers and Water Supply Commission of the state of Victoria and chief engineer thereof, he has demonstrated his high qualities of statesmanship. His work in the University of California will be to deal with questions of farm credits, irrigation and drainage institutions, co-operation, and all the varied political, economic, educational, social and religious institutions which affect rural life.

The establishment of this professorship of rural institutions was forecasted by Dean Thomas F. Hunt when he announced recently that the College of Agriculture of the university was ready to co-operate with any agency, federal, state or private, which had for its main purpose the creation of a successful family life.

COLORADO.

The Irrigation Committee of the Denver Chamber of Commerce will write a letter to Secretary of the Interior Lane asking him to define more clearly his attitude toward the appointment of a commission to settle contentions as to water supply and rights of way in this state between the federal government and the state and private irrigation projects.

Secretary Lane told State Engineer Field in Denver last week that he was willing to leave the facts in the cases in dispute to the decision of a commission constituted of experts. Thousands of acres of land in the state remain undeveloped and unproductive on account of existing differences.

J. C. Ulrich, the engineer who was engaged by the committee to inspect the proposed reservoir site on the Conejos river has returned from a trip to the site. He went carefully over the ground and formed conclusions from comparisons of the site with that of the Farmers' Union reservoir on the Rio Grande which enterprise he engineered. He made no tests to determine the character of the formation and consequently was not prepared to make a definite report but from surface observations he pronounced the proposition substantially the same as the Farmers' Union reservoir site, with the exception that it is much larger.

A farmer in this irrigation country has ten advantages for making money where the farmer of twenty-five years ago had one. It is no uncommon thing for a single acre of land with the present methods of cultivation and present markets and market prices to be made to produce net profits of from \$100 to \$200. The farmer of the passing generation never dreamed of such possibilities and it is difficult for eastern folks to believe that it can be done.—*Denver Field and Farm.*

A Montrose, Colo., paper says: According to a decision of H. C. Getty, irrigation engineer, the primary rights of the Government to water from one point in a stream hold good farther down the stream if any of the water originally taken is returned through ditches and canals to the stream. This, however, with the proviso that the Government must establish the actual amount flowing back into the stream, and retake that and no more. In other words, the primary rights to waters follow that water wherever it may be found.

The ruling came in the case of the Government's claim for return waters from the Gunnison river. A portion of the Gunnison is diverted into the Ironstone ditch. Farther down some of this water returns to the Gunnison, and the Government contended this flow could again be diverted, holding that if it was entitled to it once it was entitled to it for all time. The decision upholds the claim as against those holding decrees to the natural flow farther down the stream from the point where the irrigation waters return.

Action looking toward a reversal of the attitude of the Department of the Interior unfavorable to the withdrawal from public entry about 35,000 acres adjacent to Denver's mountain park system, is promised by John Truesdell of the national reclamation service, after being taken through the district by President Macbeth of the park board. An immediate decision is necessary, according to Macbeth.

"Now that good roads are assured, if these lands are left open they will soon fall into the hands of private individuals the wooded parts denuded of trees and 75 per cent of the attractiveness of the park system will be lost. Then much of our labor and money so far expended will have gone to naught," he says.

The interior department was asked to withdraw 35,000 acres deemed essential to the beauty of the parks.

Plans are under way for the erection of a big plant here to distill oil from the boulders around Kimball creek. Discoveries made by J. G. Harrington, a rancher, has demonstrated that that section is rich in both lubricating and illuminating oils.

In a preliminary opinion given by Judge Lewis of the Federal Court, who is hearing the suit of the Pioneer

Irrigation Company against State Engineer John E. Field to determine the right of Kansas irrigators to the water of the Republican river it was held that the state line should not determine the right of people to take water from a stream. If Judge Lewis should continue this holding in the final decision and if it should be upheld it would be quite a reverse to the position taken by the irrigators of Colorado.

Investigations with the intention of devising some means whereby thousands of acres in Montezuma county and the San Luis valley lying idle may be cultivated and brought to settlement are to be begun next week by John E. Field, state engineer, and Volney T. Hoggatt, register of the state land board. The two are to make a trip of inspection to see how water may be put on state land in the two sections.

Field says there are 250,000 acres idle. The register has particularly in mind 10,000 acres in Montezuma county and 9,000 in the San Luis valley affected by contracts with the state land board. Many persons are said to have purchased land and others to have leased it merely for the purpose of speculation.

A contract will be let in October for the construction of the Moffat irrigating system in Saguache county. The project will cost about \$400,000 and place under water more than 50,000 acres of excellent agricultural lands.

In addition to the many miles of laterals there will be built 100 miles of main canals. The country is nearly level and the dirt that will be excavated will be used for the rounding up and surfacing of highways to parallel the ditches. The water for the system will be developed from surface flow in the creeks and rivers and from pumping plants scattered over the district.

The plans, which have been prepared by Engineer Whiting of Denver, call for twenty electrical pumping plants. Wells will be dug at specified places and the pumping plants erected over them. The power will be supplied from the main power house to generate 400 horsepower. Seven sub-transformer stations will be built.

IDAHO.

The King Hill Irrigation Company controversy, which has dragged in courts of Idaho for years, is to be tried out on its merits in the Federal Court, Boise, before Judge Dietrich. Close to \$1,000,000 is involved, together with securities, including bonds and one of the important irrigation projects in the southern part of the state, now in the hands of a receiver.

The American Trust & Savings Bank of Chicago is trustee for the bondholders. The Continental & Commercial Trust & Savings Company of Chicago is financially interested in the outcome of the litigation, as is the Craster Farm & Orchard Company, the Pacific Coast Pipe Company, the Minneapolis Steel & Machinery Company, the C. R. Shaw Lumber Company of Boise and other concerns.

Governor Haines, in company with other members of the state land board, passed through Blackfoot, Idaho, recently, en route to Mackay and other points on the Big Lost River irrigation project, which they plan to give a thorough inspection. If possible, some effective solution to the problem will be settled upon.

The Secretary of the Interior has directed the reclamation service to execute a contract with the Minneapolis Steel and Machinery Company of Minneapolis, Minn., for furnishing semi-steel discharge pipe for balanced valves for the Arrowrock dam, Boise irrigation project. The contract price is \$19,420.42.

MONTANA.

One hundred thousand acres of arid land in the Milk river valley in Montana are to be turned into a garden spot by a vast irrigation project undertaken by the United States Government. The work has just commenced. Water from the continental watershed is to be stored in two reservoirs in Glacier National Park, which will be drained through canals into the Milk river during the dry summer months.

Upper and Lower St. Mary's lakes are to be made into a reservoir by a steel and concrete dam which will

raise the water level thirty feet. The two Sherburne lakes will be raised seventy-five feet.

From the reservoirs the water will be carried through a canal into the North Fork river and thence into the Milk river, a distance of 200 miles. The work will require at least two years for its completion.

The United States reclamation service will start shipments of cement to be used at the various reclamation projects next week and Montana cement will be used in all the Montana projects according to instructions of Supervising Engineer H. N. Savage, in Great Falls. The Trident Cement Company of Three Forks has been given a contract to start the shipment of 1,600 carloads of cement for use on the Huntley project, the Milk river project, the Flathead project and the Sun river project. The cement to be used on the latter project will not be started in large quantities yet because of the fact the work has not reached a stage when it is needed in large quantities.

A correspondent in Bozeman states that three real estate transfers, involved a total of \$114,000, were announced recently by the Buell Land Company, as having been just completed. Edward A. Knowles, a Gallatin Valley farmer, who came to the valley, it is said, only ten years ago, with a capital of \$300, purchased the 3,280 acre ranch of the Avalanche Land Company, on the Missouri river bench, near Helena. D. H. Patterson and Benton Norris of Bozeman, bought 640 acres on the Spokane bench near Hauser lake, adjoining a former purchase of 800 acres. A. Schlechten bought 480 acres in the same tract. Both the last purchases are under second unit of the Montana Reservoir and Irrigation Company's Helena valley irrigation project. The average price of the lands involved in these sales is \$26 per acre, and most of the land is under irrigation.

NEW MEXICO.

The Roswell Irrigated Land and Orchard Company, a Maine corporation, has entered the state, and has notified the state corporation commission that A. Seagrist, of Roswell is the agent for the concern. It is a \$400,000 corporation with \$35,000 paid in.

Sir L. M. Cockrell, representing English capitalists, and who is a member of the select Isthmian club, Piccadilly, London, has recently been looking into conditions in the Mimbres valley and making exhaustive research in the interest of himself and other capitalists. After seeing the big irrigation pumps at work, noting the mammoth crops and climatic conditions, he expressed himself as being very much pleased with the country, and agreed with Colonel Roosevelt that it is truly a marvelous region just coming into its own. Sir Cockrell was accompanied by C. H. Kearney, of San Antonio, Texas.

A. G. Spalding, of Point Loma, Cal., the multi-millionaire sporting goods man, and head of the Rio Mimbres Irrigation Company, has been at Deming conferring with General Manager Bickford and Colonization Agent E. P. York, who are developing the first 5,000 acre unit of their 100,000 acre tract northwest of Deming. The company will build an ideal village at Spalding.

OREGON.

A co-operative scheme for the development of the Willamette Valley in particular, but a movement that is certain to be of much benefit to the entire State of Oregon has been started.

President Strahorn, of the Willamette Valley line, has undertaken to finance an investigation of the various organizations and institutions of the states of Washington and California, through which the farmer and producer find markets for the products of the soil.

It is believed that methods will be found in use in adjoining states that may be adopted to the communities of Oregon to accomplish a profitable use of those products which are now allowed to waste and by which process hundreds of thousands of dollars are lost to the farmers of Oregon each season.

The investigation is in charge of Mark Woodruff, publicity agent for the Portland, Eugene & Eastern Rail-

way Company, who has gone to Tacoma and Puyallup, Wash. At the latter place, Senator W. H. Paulhamus will be interviewed as to the methods used in organizing the co-operative association, which has brought much profit to the growers of that section. Individuals will be hunted up to find out exactly in what degree they have profited or lost by the establishment of marketing organizations, and the truth will be told concerning organizations that have failed.

UTAH.

A movement is on foot in the state of Nevada to utilize the surplus waters of the Humboldt river for irrigation and power developments. The Humboldt river is one of the unique rivers of the arid west, and conditions along it are in a large measure parallel to those of the Sevier river in Utah. By constructing storage reservoirs on the headwater streams of the river system and securing the return waters from irrigation, a vast amount of arid lands can be cultivated, thereby making additional homes for several thousand people.

J. R. Murdock, head of the Utah Lake Irrigation Company, recently addressed the Utah Electric Club on "The Use of Electricity in the Reclamation of Arid Lands." The meeting was attended by a good representation of the Electric Club.

In his address Mr. Murdock called attention to the increased transportation facilities to the southern part of Utah county, because of the interurban line soon to be completed, and suggested that therefore Salt Lakers could easily and profitably become farmers in that part of the state. He mentioned the vast amount of reclamation work now being done by means of electric power and said that that power could be used to raise water to such a level as would largely increase the irrigated area of the Utah and Salt Lake valleys. Club members showed great interest in the address, as they were made aware of the possibilities for local widening of their field of achievement.

Notice has been received by the state land board of Utah from the Government land office of approval of the state's temporary withdrawal of 124,000 acres of the land under the Carey Act for the Desert Irrigation Company. The land is near the Millard-Juab county line, a short distance from Lynn.

WASHINGTON.

The Secretary of the Interior has announced a drawing for valuable farms under the Sunnyside unit of the Yakima irrigation project, Washington, applications for which may be filed on November 21, 1913.

All applications must be accompanied by payment of the first installment of the water right charges for building, operation and maintenance, amounting to \$6.15 per acre of irrigable land included in the farm unit selected, plus the land office fees and commissions. Full information and copies of the public notice may be obtained at the local land offices and at the office of the reclamation service at North Yakima, Wash.

A Bellingham paper says: The drouth which has prevailed in many parts of the east this season has caused a large demand on the Department of Agriculture for information as to the cost and possibilities of irrigation. The irrigation investigations of the office of experiment stations employs two men in the east, whose time is devoted to advising farmers and truckers as to the kind of equipment needed, the cost of installation and operation, and the methods of applying water to crops.

The supreme court has sent back for modification the case of Carl A. Sanders and wife against Charles Bull and others, appellants. The decision directs that testimony be taken relative to the land being irrigated by the waters of Wilson and Nanum creeks and also in regard to riparian right claims of the different parties and that then the waters of the two streams be apportioned among the different contestants all of whom live in the Kittitas valley, Washington. The case was appealed from the Kittitas county superior court.

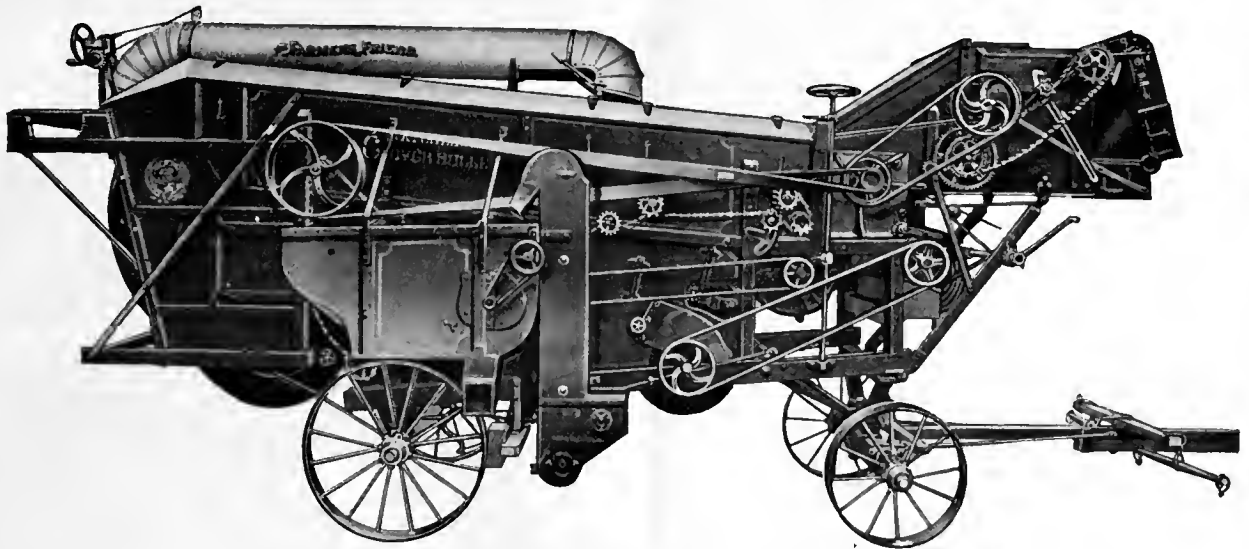

**HULL YOUR SEED QUICKLY, PERFECTLY and ECONOMICALLY With a
"MATCHLESS" CLOVER and ALFALFA HULLER**

That's just what you will do if you use a "Matchless" Huller on the job. It's the one huller that will hull all the Clover or Alfalfa you can get to it without sacrificing the quality of the work. **Here's the reason!** We use square steel brads in our hulling cylinder. This construction has every advantage over rasps of spikes, because no set of spikes will knock the seed out of the damp pods. Rasps gum up and are easily destroyed. Our system of separation is unique and effective. This consists of a series of rotating troughs with perforation in the bottom, with provision for adjustment to meet the various conditions of clover. The Patented Steel Scrapers attached to the bottom of these troughs thoroughly scrape the separator bottom and insure a steady and positive delivery of the pods to the hulling cylinder, regardless of the condition of the clover. This construction enables you to hull seed under conditions in which no other huller can operate; enables you to hull earlier in the morning and later in the evening than with any other—this insures a longer day, thus increasing your earning power. Give us an opportunity to prove to you right on your own farm that the "Matchless" is the speediest and cleanest huller on the market. WRITE FOR CATALOG TODAY, or call at our nearest Branch House.

THE AULTMAN & TAYLOR MACHINERY COMPANY, MANSFIELD, OHIO.
Sole Builders of Aultman-Taylor "Starved Rooster" Line of Machinery.
BRANCHES: Minneapolis, Minn.; Portland, Ore.; Lincoln, Nebr.; Kansas City, Mo.; Wichita, Kan.; Decatur, Ill.; Indianapolis, Ind.

**PEERLESS
POULTRY AND RABBIT FENCE
Some Extra Close Spaced Styles**

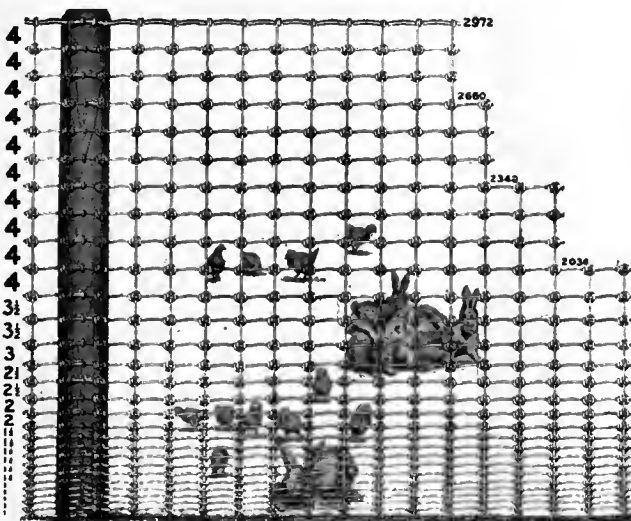

Four Heights: Three, Four, Five and Six Feet.

These styles are especially adapted to use in fruit growing countries where rabbits are numerous and troublesome. They are close spaced a considerable distance from the ground so they cannot crawl through when snow banks up along the fence line.

Made of the same heavily Galvanized Open Hearth Steel Wire as all Peerless Fences. The stiff one-piece cross-bars, placed 4 inches apart, are attached with Peerless Non-slip knot.

These fences, when properly stretched, will not sag or buckle down. They stand up straight and true, last for years and give satisfactory service.

Send for prices and complete Catalog.

PEERLESS WIRE FENCE CO.
Adrain, Mich.

UNDERFLOW IN ARKANSAS VALLEY.

The Arkansas Valley, from Hutchinson west to the Colorado state line, should be under irrigation, pumping water from the underflow, declared H. B. Walker, state irrigation engineer, who was in Hutchinson, Kansas, recently.

This water which, comparatively speaking, is right at the grass roots, is found at from 6 to 30 feet below the surface.

"There is no danger of exhausting the underflow by over-irrigating," said Mr. Walker. "Up to the present time neither the water plane nor the supply of ground water has been affected visibly by the numerous pumping plants which are now scattered throughout the shallow water area. The supply is inexhaustible."

Portable Folding Steel Dam



Simple in construction and easy to manufacture. Light, durable and easily carried about. Easily and quickly adjusted to any ditch. A four-foot dam will fit any ditch up to four feet wide. With one or more extensions will fit as wide a ditch as desired, or enable the irrigator to turn the water in different directions. Practical, efficient and convenient time and labor saver. Can be manufactured and sold at a low price and will last for many years. There is a large demand in irrigated States for this Dam. Thousands of irrigated tracts are being added annually to the large number already under irrigation. Parties interested in the manufacture and sale of this dam can secure U. S. or State Rights by writing the inventor.

W. A. LINKLETTER **BOULDER, COLORADO**

THE WINNER



THE machine that leads all eighth yard mixers for design, principle, cost of operation, convenience of operation, thoroughness of mix and low price. Get our catalog and learn *Why*.

The Cement Tile Machinery Co.
175 Rath Street, WATERLOO, IOWA



THINK what it means to you! To have at your service—day and night if desired—the combined power of 30 to 35 horses and 10 to 15 men—ready at a moment's notice to plow, disc, harrow, seed, harvest, build roads, irrigate, thresh and do numerous other power jobs, all at the minimum expense for fuel and maintenance. That's what you get when you buy a time-tried and time-proven

AULTMAN-TAYLOR 30-60 GAS TRACTOR

They're built with the complete knowledge of the requirements of a tractor of the first quality. They're built right here in our own shop, under our own supervision. We know they're right and we stand back of every tractor. The Aultman-Taylor 30-60 burns either gasoline, kerosene or

distillate with unequalled economy. The Aultman-Taylor 30-60 is not an experiment. Their real worth has been demonstrated on thousands of farms throughout North America. Let us explain to you why you should own and operate one of these money-making and labor-saving tractors. WRITE FOR CATALOG AND FURTHER INFORMATION TODAY.

We are also builders of the Famous "New Century" Separator, "Matchless" Clover and Alfalfa Huller, Steam Traction and Portable Engines, Bean Threshers and Saw Mills. Catalog free upon request.

THE AULTMAN & TAYLOR MACHINERY COMPANY

MANSFIELD, OHIO.

BRANCHES: Minneapolis, Minn. Portland, Ore. Lincoln, Nebr. Kansas City, Mo.
Wichita, Kan. Decatur, Ill. Indianapolis, Ind.

When writing to advertisers please mention The Irrigation Age.

Farmers Beware

Protect yourselves against drought next summer and insure your crops and orchards with an "INGECO" gas engine and pump.



We build and supply any size engine suited for all kinds of light oil fuels, such as distillates, gasolene, kerosene, also artificial or natural gases.

For the average small farm use the "INGECO" Kerosene Engine, operating with plain, everyday kerosene oil. Full line of sizes in stock.

Centrifugal pumps, deep well pumps and other types of irrigating pumps always on hand.

"INGECO" Line 1½-350 Horse Power
Vertical and Horizontal

Write for catalog.

International Gas Engine Co., 138 Holthoff Place, Cudahy, Wisconsin.
(Suburb of Milwaukee)

HOMESTEADS FREE

Your Choice of Twenty Million Acres Free in Montana

An exceptional opportunity for the homeseeker is open RIGHT NOW! Out in Montana are twenty million acres of government land awaiting the settler. Thousands of settlers have established homesteads in this wonderfully productive country and are reaping splendid profits.

These free homesteads will soon be a matter of history so investigate at once.

NEW HOMESTEAD LAW—Full Title to 320 Acres in Three Years

New Homestead Law gives you full title to 320 or 160 acres of this fertile land absolutely free in three years. Go and see this land. Low Round Trip Homeseekers Fares to Montana in effect on certain dates throughout the year.



MONTANA IRRIGATION PROJECTS

Lower Yellowstone Irrigation Project—Milk River Irrigation Project—Valier Irrigation Project—Flathead Irrigation Project—Fort Peck Irrigation Project—Blackfeet Irrigation Project—Sun River Irrigation Project, all located in the State of Montana, offer the homeseeker, or man of moderate means, a splendid opportunity for home-making. Land on some of these irrigation projects may be filed on in accordance with the U. S. Homestead Laws. Write for full particulars regarding requirements for taking up this land.

SEND THE COUPON FOR INFORMATION

Let us give you all the facts about these free homesteads and irrigation projects—let us tell you of the possibilities for home-making in Montana—the profits to be made. Fill out and mail coupon today and we will send you complete details free.

E. C. LEEDY

General Immigration Agent
Dept. I. A., Great Northern Ry., St. Paul, Minn.

..... FREE COUPON

E. C. LEEDY, General Immigration Agent,
Dept. I. A., Great Northern Ry., St. Paul, Minn.
Please send booklets and full information regarding Homeseeker's Fares, the New Homestead Law and opportunities in Montana, free.

Name

Address

*Panama-Pacific International Exposition
San Francisco, 1915*

Use KEROSENE Engine Free!

Amazing "DETROIT" Kerosene Engine shipped on 15 days' FREE Trial, proves Kerosene cheapest, safest, most powerful fuel. If satisfied, pay lowest price ever given on reliable farm engine; if not, pay nothing. No waste, no evaporation, no explosion from coal oil.

Gasoline Going Up!

Gasoline is 50 to 150% higher than coal oil. Still going up. Two pints of coal oil do work of three pints gasoline.

Amazing "DETROIT"

—only engine running on coal oil successfully, uses alcohol, gasoline and benzins, too. Starts without cranking. Only three moving parts—no cams—no sprockets—no gears—no valves—the utmost in simplicity, power and strength. Mounted on skids. All sizes, 2 to 20 h. p., in stock ready to ship. Engine tested before crating. Comes all ready to run. Pumps, saws, threshes, churns, separates milk, grinds feed, shells corn, runs home electric lighting plant. Prices (stripped), \$29.50 up. Sent any place on 15 days' Free Trial. Don't buy an engine till you investigate the money-saving, power-saving "DETROIT." Thousands in use. Costs only postal to find out. If you are first in your neighborhood to write, you get Special Extra-Low Introductory price. Write! (138)
Detroit Engine Works, 301 Bellevue Ave., Detroit, Mich.



FOR THE "LAND'S SAKE"

BUY A

BOSTROM IMPROVED



FARM LEVEL

Price \$15

which has TELESCOPE enabling you to read the Target over 400 yards away, and

TERRACE, DITCH, TILE DRAIN, IRRIGATE

your land properly, and save surveyor's fees. It is sold by up-to-date hardware and general merchants everywhere, and guaranteed to be the most

SIMPLE, ACCURATE, DURABLE AND COMPLETE

outfit ever made for all farm work. If your dealer hasn't one in stock, he will order for you from a nearby hardware jobber.

Write today for description of Level, and details of our MONEY BACK GUARANTEE.

BOSTROM-BRADY MANUFACTURING CO.

119 Madison Ave., Atlanta, Ga.

SEND \$1.00 FOR THE IRRIGATION AGE ONE YEAR AND THE PRIMER OF IRRIGATION, PAPER BOUND.

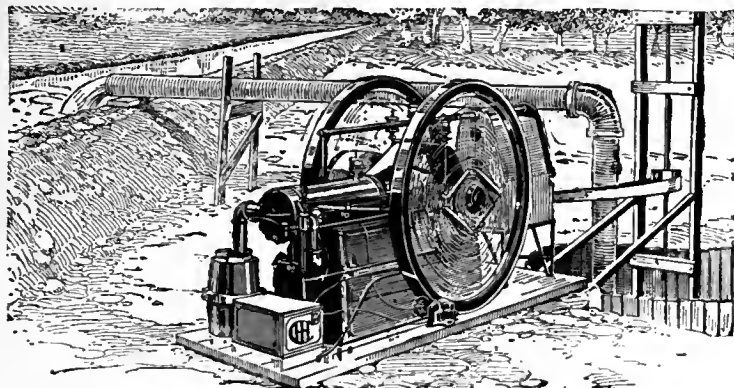

Don't Dread Droughts

WHEN you arrange to get rid of drought and to turn water on your thirsty soil whenever it needs it, the most important thing is that you get, for your power, an absolutely reliable and efficient engine. When the dry time comes you must have water. Make the very safest selection and buy an

I H C Oil and Gas Engine

An I H C outfit is the most reliable, and the most economical you can buy. It delivers the most power on the least fuel. Always ready to go when needed, it costs nothing when not in use.

Besides, an I H C engine can be used for all sorts of work about the yard and barns. In running a saw, cream separator, feed grinder, hay press, and many other machines, it will easily pay for itself. I H C engines are made in every style—air and water cooled; horizontal and vertical; stationary, portable and skidded; to operate on gas, gasoline, kerosene, naphtha, distillate or alcohol. Size 1 to 50-horse power. Tractors range from 6-12 to 30-60-horse power, for plowing, sawing, hauling, etc.

You will find your right I H C engine at the dealer's. Get catalogues from the dealer or write to the nearest branch house.

WESTERN BRANCH HOUSES: Denver, Col.; Helena, Mont.; Portland, Ore.; Spokane, Wash.; Salt Lake City, Utah; San Francisco, Cal.

International Harvester Company of America

Chicago

(Incorporated)

U S A



When writing to advertisers please mention The Irrigation Age.

Kerosene! Gasoline! Distillate!



Any Size You Want

The Genuine

Chilled Cylinder Engine
The Engine Sensation of 1913

The engine that, during the past few months, has revolutionized the engine industry. Pronounced by experts to be a marvel of reliability, simplicity and economy. Positively the only engine with the famous **Chilled Cylinder**, the strongest and most durable cylinder ever made. The best for farm, shop, and construction work. **The Ideal engine for the irrigation farmer.** Combined with this cylinder is the **multiple compression**, secured by use of four piston rings instead of three, and the patented **Never-Failing Lubricating Device**. **These remarkable engines are fully guaranteed for five years.** Every engine undergoes the severest tests before it is shipped. It gives full power and more.

Kerosene Attachment Now Ready!

Wonderful new device for using kerosene and distillate. Cuts your fuel bill in half. Runs your engine on common, ordinary kerosene such as you can get in any store, or distillate. More powerful than gasoline. A tremendous advance. Send coupon today for description of this great cheap fuel attachment.

\$15.50 And You Keep This Great Engine

An offer absolutely unparalleled in the engine industry. The superiority of the Chilled Cylinder Engine enables us to make it to you. Only \$15.50 as a first payment—then the rest in **Easy Monthly Installments**. You get the factory price. No go-between profits to pay. You deal direct with the manufacturer, not with an agent whose only idea is to sell you an engine.

30 Days Free Trial

We want to send you this great engine for a free trial of 30 days. We want to prove to you that it is the peer of all engines. We want you to be thoroughly convinced. If you are not satisfied with its performance send it back at our expense.

Free Book "How to Use Power"

A valuable book on engines which contains information which every up-to-date farmer and shop owner should have. It comes to you absolutely free and prepaid. It is written so that anyone can understand it. This edition is limited.

Send Free Coupon

Free Book
 or write today to Ben Schmidt, president of the Schmidt Bros. Engine Works. Just send this coupon today and the Free Book will reach you by return mail.
Schmidt Bros. Co. Engine Wks. Dpt. 3706 Davenport, Ia.
 Ben. L. Schmidt, Pres.
Schmidt Bros. Co. Engine Works Dapt. 3706 Davenport, Ia.
 With the understanding that I am not buying anything nor paying for anything you may send me your free book, "HOW TO USE POWER," and full details of your free trial offer, with easy payments, on your Chilled Cylinder Engine

Name.....
 Address.....

There are Five Great Irrigated Valleys in the country served by the Santa Fe, where men who know how can find Golden Opportunity

These valleys are, all of them, blessed with a soil of unusual fertility. The range of crops is wide and all have been demonstrated successes.

If you are looking for a farm for yourself, or a larger acreage to develop and subdivide, I can be of real service to you.

You are urged to use the facilities of this department to investigate any phase of the Santa Fe Southwest.

C. L. Seagraves, General Colonization Agent
A., T. & S. F. Ry. System, 1115 1 Railway Exchange
Chicago

CARBO FLEXIBLE STEEL POSTS
 Anchor direct in earth. Flexible line posts. Stiff corners. No concrete and no special tools.
CARBO STEEL POST COMPANY
 179 10th Street, Chicago Heights, Ill. **FREE Booklet**



AUSTRALIA
 Special Land Seekers' Excursion Next November to Victoria, Australia
 Early reservation of berths desired.
 Reduced steamship passages and free rail travel in Victoria for inspection. Government of Victoria wants settlers and offers unusual opportunities. Lands suitable all requirements exceptional terms. Free particulars from F. T. A. FRICKE, government Representative (from Victoria) 687 Market St., San Francisco, Cal.

Fairbanks-Morse Pumping Machinery
For Irrigation or Drainage
 600 to 600,000 Gallons per hour.
 Oil Engines
 Electric Motors
 Centrifugal Pumps

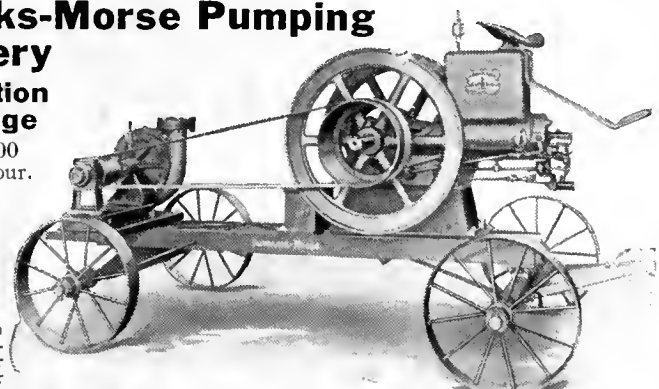

Let us figure on pumping equipment to meet your conditions. Send for Catalog 650.P10.

Fairbanks, Morse & Co., 900 S. Wabash Avenue **Chicago, Ill.**

GALVANIZED METAL IRRIGATION FLUME (Newcomb Patent)

Made entirely of rust-proof, galvanized iron. No bolts or rivets used in construction. This flume is considered by experts to be the most serviceable equipment for the purpose on the market. A careful examination of the construction as shown herewith will convince those who are acquainted with irrigation conditions of its lasting quality and the ease with which it may be put together. Complete information, with prices, will be furnished on application to the



Section of Flume

KLAUER MFG. COMPANY, Dubuque, Iowa

The Farm Burden Bearer

YOU and your farm wagon spend a great deal of time together. Of all farm tools it is your standby. Its wheels bear the burden of big loads—towering racks of hay and grain, sacks of produce, loads of sand and gravel, anything that needs moving, over miles of roads to market. It takes solid strength to stand up long under that. When next you ride on a load, listen to the constant racking, creaking, groaning sound of the wagon box, wheels and running gear as the load pitches back and forth over the road ruts. Not an unpleasant sound, but the strain that causes it is hard on the wagon. I H C wagons—



Weber Columbus

New Bettendorf Steel King

give the buyer the most he can get for his money because they defy hard usage for the longest time, and are easiest on the horses.

This makes I H C wagon reputation: Selection of the finest grades of lumber, oak, hickory and pine, and of the best quality steel and iron; many months of toughening air-drying for every piece of wood; skilled assembling of parts, fitting of bolts and rivets, and perfect shaping and ironing; application of the purest paint to act as wood preservative and to prevent shrinking and warping of the wood. When the wagon is ready for the farmer, it is practically perfect in every detail and thoroughly up to the I H C standard.

And there are many other reasons we have not room for here why I H C Wagons are the best to buy. Weber and Columbus wagons have wood gears; New Bettendorf and Steel King have steel gears. A visit and a talk at your local dealer's, where the wagons may be seen and studied, will soon convince you as to the wagon you want. Get catalogues from the dealer, or, write the nearest branch house.



WESTERN BRANCH HOUSES: Denver, Col.; Helena, Mont.; Portland, Ore.; Spokane, Wash.; Salt Lake City, Utah; San Francisco, Cal.

International Harvester Company of America
 (Incorporated)

CHICAGO

U S A



When writing to advertisers please mention The Irrigation Age.

UNION MACHINES WITH PUG MILLS COMBINED

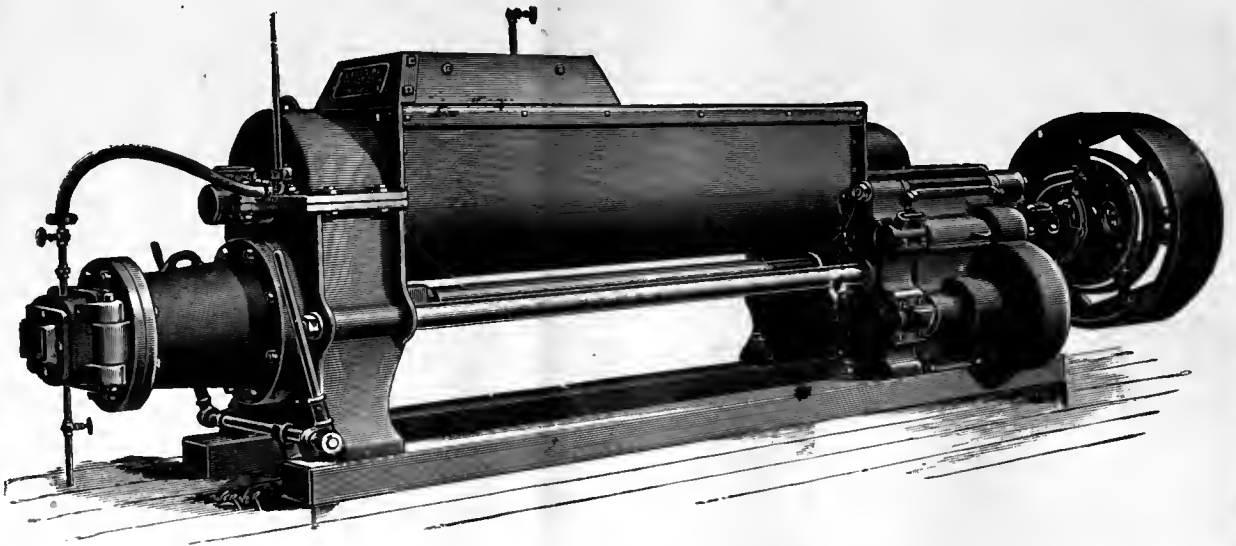

FIVE SIZES ALL CAPACITIES

Outfits for Drain Tile, Hollow Ware, Building
and Paving Brick and other Clay Products

If interested write us for particulars and estimates.

E. M. FREESE & CO.
GALION, OHIO

IRRIGATION FROM WELLS

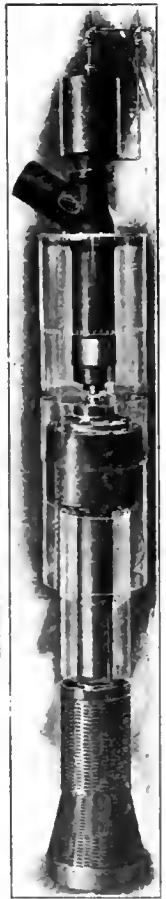

An Arkansas Installation. Layne Patent Screen and Patent Enclosed Line Shaft Centrifugal Pump.

With the twenty-three hundred successful working plants using our system of irrigation, which inoculates and energizes the dormant forces, there is now being produced in previously non-productive districts throughout the United States and in portions of Europe and Asia over eleven million dollars worth of FOOD PRODUCTS ANNUALLY. That our system is not an experiment is forcibly demonstrated by the fact that much of this production is from localities which were arid and barren previous to the introduction of our system.

Write for new catalog.

LAYNE & BOWLER COMPANY

Address nearest office.

The World's Largest Water Development Company

Houston, Texas

Memphis, Tennessee
Welsh, Louisiana

Stuttgart, Arkansas
Plainview, Texas

Jackson, Mississippi

Can You Afford to Support Horses?

THOMAS A. EDISON, the wizard of inventors, says, "The horse is the poorest motor ever built." When you stop to think of it, the horse is about the most costly and wasteful thing at work for a farmer. At best his working time averages only about six hours a day, eighteen hours he rests, yet he eats all year round, working or idle. He eats ten pounds for every hour he works. One acre out of every five plowed goes to feed the horse. The best horse may get sick; when, besides losing his work, you have veterinary bills to pay. When he dies, you have a heavy loss. Since McCormick built his first binder, the tendency of all farming has been away from slow man- and horse-power and toward time- and money-saving machines. Thus far, wherever an



I H C Oil Tractor

has been set to work on a farm, no machine has taken the place of so many horses, or done so much laborious work with so large a saving of time and money. I H C tractors have revolutionized farming. If the owner desires, his tractor will plow nearly as much in a day of twenty-four hours as a team of horses plows in a month. There is efficiency for you!

Whether you use it for pulling field machines,

hauling your produce, threshing, cutting ensilage, baling hay, or anything else, the I H C tractor will stand up to the work. In simplicity and strength of construction, ease of operation, durability, and all-around economy, you cannot find the equal of I H C tractors. They are made in all styles and in 6-12, 7-15, 10-20, 12-25, 15-30, 25-45, and 30-60-horse power. The I H C engine line also includes general purpose engines, ranging from 1 to 50-horse power and operating on various fuels.

It will be to your advantage to get acquainted with the I H C tractor. See the local dealer, and write for facts and information to the nearest branch house.

WESTERN BRANCH HOUSES: Denver, Col.; Helena, Mont.; Portland, Ore.; Spokane, Wash.; Salt Lake City, Utah; San Francisco, Cal.

International Harvester Company of America

(Incorporated)

Chicago

U S A



When writing to advertisers please mention The Irrigation Age.



WE SHALL be glad to mail anyone who wishes same, our free catalog. We sell our product through dealers and jobbers entirely and solicit inquiries from all dealers. Our goods are well and favorably known. They are standards in the United States Army and several other departments of the government.

Gold Medal Camp Furniture Mfg. Co.
Racine, Wis., U. S. A.

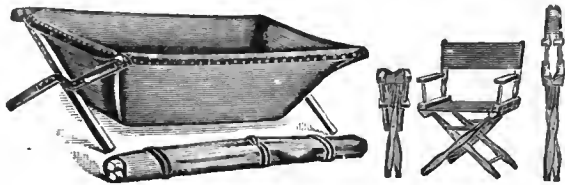

MAKE MONEY MAKING CEMENT TILES

The field is unlimited and uncrowded; marketing the product in competition with the clay interests and at clay tile prices produces a great profit and a glance at the future spells only success for the factory or business started today.

No existing proposition offers such flattering inducements or such a field of opportunity for the man looking for a vocation or for the man looking for an investment. No other business can net you such profits on the amount of capital involved, and no other business has such an unlimited future.

Just think of a business paying from 30% to 50% on the investment the very first season, and subsequently from 50% to 150%, then ask yourself the question—Is it worthy of investigation?

Our literature gives you all the details regarding the merits of cement tile, the cost of manufacture, the amount of capital required to embark in the business; how to build your factory and last, but not least, it tells you how we aid the manufacturer using our machinery and gives you our full and complete proposition. A short letter telling that you are interested will bring complete data.

The Cement Tile Machinery Co.

172 Rath St., Waterloo, Iowa.

The Lennon Metal Flume

(Patented)

Represents the last word in flume perfection. Every feature that tends to simplify, make more efficient and economize has been attended to. No cross bars in small and medium sizes, few on larger ones. Expansion and contraction at every joint the only practical method of taking care of such, and made from **Genuine American Ingot Iron** the purest metal ever used in metal flumes and high grade galvanized steel sheets.



Write for catalogs and other information

THE LENNON FLUME COMPANY

THE LENNON FLUME CO.
Colorado, Springs, Colo.

THE WESTERN METAL MFG. CO.
Houston, Tex.

THE CALIFORNIA CORRUGATED CULVERT CO.
Los Angeles, Cal., West Berkeley

SIoux FALLS METAL CULVERT CO.
Sioux Falls, South Dakota

NEBRASKA CULVERT & MFG. CO.
Wahoo, Nebr.

THE COAST CULVERT & FLUME CO.
Portland, Oregon

THE UTAH CULVERT CO.
Woods Cross, Utah

When writing to advertisers please mention **The Irrigation Age.**

\$39⁵⁰

For this large
270-Gallon
pump.

Other sizes in
proportion.

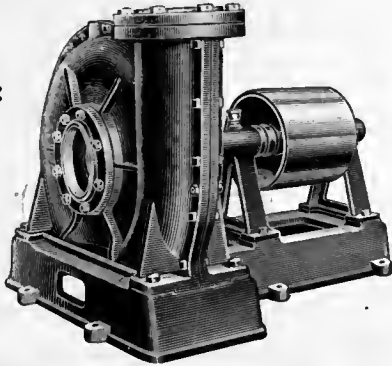

Without
comparison the biggest
pump value ever offered—the

“BUFFALO” CLASS M SIDE- SUCTION CENTRIFUGAL

For general drainage and irrigation purposes not exceeding 50 feet total head the Buffalo Class M Centrifugal Pumps represent the highest manufacturing achievement in producing, at a popular price, a pump of astonishing quality—low power consumption, smooth operation, extraordinary strength and freedom from repairs.

The large pulley is supported on either side by extra long bearings furnished with brass grease cups. The bearings are lined with genuine white babbitt metal only. To insure operation without attention, a very long packing gland is provided on the shaft. Companion flanges, both for suction and discharge opening, are furnished without extra charge. All parts of these pumps, being accurately made, are interchangeable and can be promptly duplicated at any time.

Our class M pumps are also furnished in vertical suction type and for submerged service. Ask for our catalog. Tight and loose pulleys, foot valves, flap valves, primers and other accessories can be furnished at a small extra cost.

The prices are f. o. b. works for iron pumps. Brass or brass-fitted pumps also furnished.

Ask for Catalog No. 237-C

BUFFALO STEAM PUMP CO.
BUFFALO, N. Y.

Agents Wanted for our complete line of pumps for every purpose.

SAMSON TURBINE

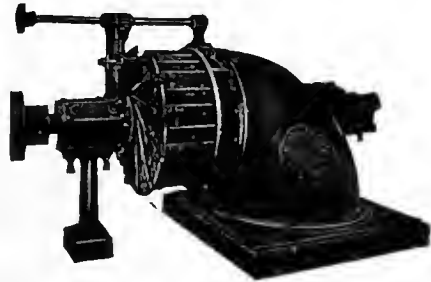

When the PUMP cannot be direct connected to the turbine shaft, the power is usually transmitted by gears, shafting, etc. On account of the HIGH SPEED of the SAMSON, for a given power, lighter and consequently CHEAPER transmission machinery can be used.

JAMES LEFFEL & CO.

Springfield, Ohio, U. S. A.

316 Lagonda Street

IRRIGATION DITCHES

Cheaply and Properly Made with a

Rural Road Grader and Ditcher



Cutting V-Bottom ditch on Slope of $1\frac{1}{2}$ to 1.

The successful irrigation ditch or lateral must be cut clean, with slopes smooth and undisturbed. This machine was especially designed to meet these requirements. One horse and wheel traveling in point of ditch, the other outside the bank of earth. Operated by one or two men and two or four horses.

If you have an irrigation problem to solve, do not fail to write for full information concerning this Combined Grader and Irrigation Ditcher.

Address

C. D. EDWARDS, Albert Lea, Minn.

This Book Shows How to Plan a Private Irrigation Pumping Plant



It also shows all of the various types of pumps to meet the conditions found in different localities, tells how to select the proper pump for your conditions, how to determine the amount of power you will need and all the other things the irrigator needs to know.

One will be sent free on request as long as they last. Write today

THE GOULDS MFG. CO.
LARGEST MFR. OF PUMPS FOR EVERY SERVICE

174 Fall Street, Seneca Falls, N. Y.
Branches in All Principal Cities

SUPERIOR



THE NAME TELLS A TRUE STORY

No matter where you live or what your seeding conditions are, you can get a SUPERIOR GRAIN DRILL that will fill the bill and do your work in the best possible manner. Superior Drills are made in all sizes and every style. Every Superior Drill is sold under a warranty that absolutely protects the buyer. Send for catalogue. Read it and go to your local dealer and insist on seeing the Superior Drill.

AMERICAN SEEDING MACHINE CO., (Inc.)
Springfield, Ohio

GRAIN DRILLS

The Red Ball on the Ranch is a Money Saver

When you wear "Ball-Band" rubber footwear, which always bears the Red Ball trade-mark, you are wearing the best rubber footwear money will buy. On the ranch, boots get the hardest kind of hard wear and a weak, slazy boot is a very poor investment.

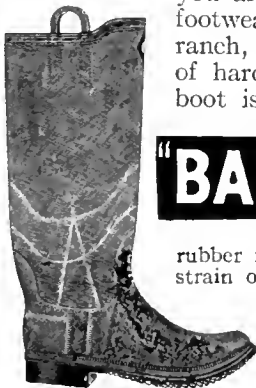

TRADE MARK
"BALL BAND"
Red

rubber footwear is built to stand the strain of the roughest kind of hard work. "Ball Band" boots are shaped over natural lasts and they offer foot-comfort. Wear a short wool sock in them and your feet will be kept warm as well as dry.

Look for the Red Ball Sign in your local store and ask for "Ball-Band" rubber footwear. If your dealer can't supply you, write to us and we will see that you get what you want. Write anyway for our Free Illustrated Booklet about "Ball-Band" rubber footwear.

Mishawaka Woolen Mfg. Co.
346 Water St., Mishawaka, Ind.

"The House That Pays Millions for Quality"

Blackmar Rotary Pump

(Interior View)

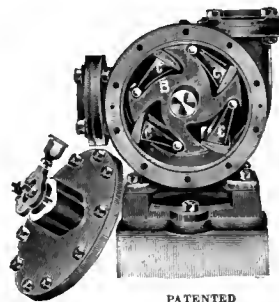

PATENTED

Large Capacity with Minimum of Power

One customer writes he pumped 21,000 gallons with a fuel consumption of 1 gallon of gasoline.

Runs quiet; is high in efficiency and durability. Wear automatically taken up. Few parts, no springs, no adjustments. Requires little or no attention.

One customer has 500 in use.

Capacity, 5 to 500 gallons per min.

Tell us about your pumping problems.

Blackmar Pump Power & Manufacturing Co.
PETOSKEY, MICH., U. S. A.

Twenty-Ninth Year

THE IRRIGATION AGE

Vol. XXIX

CHICAGO, DECEMBER, 1913.

No. 2

THE IRRIGATION AGE

With which is Merged

The National Land and Irrigation Journal

MODERN IRRIGATION
THE IRRIGATION ERA
ARID AMERICA

THE DRAINAGE JOURNAL
MID-WEST
THE FARM HERALD
THE IRRIGATOR

D. H. ANDERSON
PUBLISHER,

30 No. Dearborn Street, CHICAGO
Old No. 112 Dearborn St.

Entered as second-class matter October 3, 1897, at the Postoffice at Chicago, Ill., under Act of March 3, 1879.

D. H. ANDERSON, Editor

ANNOUNCEMENT.

The "Primer of Hydraulics" is now ready; Price \$2.50. If ordered in connection with subscription \$2.00.

SUBSCRIPTION PRICE

To United States Subscribers, Postage Paid, \$1.00
To Canada and Mexico, 1.50
All Other Foreign Countries, 1.50
In forwarding remittances please do not send checks on local banks. Send either postoffice or express money order or Chicago or New York draft.

Official organ Federation of Tree Growing Clubs of America. D. H. Anderson, Secretary.

Official organ of the American Irrigation Federation. Office of the Secretary, 212 Boyce Building, Chicago.

Interesting to Advertisers.

It may interest advertisers to know that *The Irrigation Age* is the only publication in the world having an actual paid in advance circulation among individual irrigators and large irrigation corporations. It is read regularly by all interested in this subject and has readers in all parts of the world. *The Irrigation Age* is 28 years old and is the pioneer publication of its class in the world.

Improved Method Fruit Distribution

We learn that the total amount of money remitted to growers in Idaho and the Northwest, by the North Pacific Fruit Distributers for the 1913 crop, passed the one million dollar mark with the close of October.

It is stated, however, that many of the growers who have shared in the one million dollar distribution for the year 1913 are still awaiting payment on their 1912 crop shipped under a different regime and before the organization of the North Pacific Fruit Distributers. It would appear therefore, that this organization will develop into a very good thing for the growers of fruit and other crops, and it should be supported by all of the substantial fruit-producers throughout the Northwest.

Graves on Federal Forest Service

We are presenting in this issue an article prepared by Henry S. Graves, forester in charge of the Federal Forest Service, which will be of interest to all of our readers. Much good work has been done in the Forestry Bureau since it has been under the control of Mr. Graves and we note that there is not as much friction throughout the West as existed during the Pinchot regime. It is presumed that Mr. Graves

is broader in his views than was Mr. Pinchot, at any rate, under the agitation which existed during the time Mr. Pinchot was in charge and for a time following his retirement, the criticism against his policy was extreme and this criticism no doubt resulted in bettering conditions. Mr. Graves has profited by the experience of Mr. Pinchot and by getting in closer contact with the people affected by the old time forest policy, has changed matters so that there is greater harmony and a better feeling all around.

"Bleeding Kansas" A Misnomer

The severe drought throughout Kansas during the summer of 1913 may prove a blessing in disguise. Reports from that state tell wonderful stories of crops raised under irrigation by pumping, details of which are given on another page in this issue.

Owing to the unreliability of the surface flow of the Arkansas river in Eastern Colorado and Western Kansas many of the stockmen and farmers found it necessary to sink wells to augment the supply of water for stock and domestic uses: it was soon demonstrated that an inexhaustible supply of water could be obtained at a moderate depth and cost from the underflow. This led to an

investigation of all of the lands carrying the underflow and resulted in the bringing in of experienced men to study conditions and the subsequent installation of numerous pumping plants that will eventually revolutionize the system of farming throughout the entire area where water bearing gravel is found.

Land on which plants have been erected that would not have sold two years ago for over \$25.00 per acre, produced crops of alfalfa during the season of 1913 that shows a gross value of \$105 per acre, over four times the former selling price of the land.

There would appear to be a great future ahead for the farmers in Central and Western Kansas and under the new system the term "Bleeding Kansas" will prove a misnomer. There is evidently a splendid field through this vast region for manufacturers of engines, pumping machinery and farm implements.

The farmer who can show a net earning of from \$80 to \$95 per acre each year is in our opinion a good man for the dealers in, and manufacturers of this class of machinery to cultivate.

**Dakota
Bankers
Assist
Farmers**

The Bankers of South Dakota have taken a long step ahead by voting a fund of \$7,000, to be used by the Better Farming Association of that State for the purchase of dry land alfalfa seed.

This seed is purchased from farmers living in the dry part of the State and will be sold at cost to the members of the Cooperative Farmers Association.

This action of the bankers will permit the farmers to get dry land seed at first cost. If bankers in other sections of the West would act along this line it would do much toward educating the farmers in the matter of securing high grade home grown seed.

The fact that southern grown seed has been purchased by seedsmen and sold to northern farmers, has led to many of the failures encountered by well meaning individuals who have known of the value of alfalfa as a fodder crop, but who have not been sufficiently careful to learn that southern grown seed is much more apt to winter kill than seed raised in the north. This fact has been repeatedly demonstrated in the dairy sections of Illinois, Wisconsin and Iowa, where southern seed has been planted.

The subject should have been more carefully studied by the seedsmen, as a failure where a hard winter, following the first seeding, has killed entire fields, discouraged the farmers and the result is that many will not make a second attempt.

Our advice to farmers in these states is to get in touch with some Association, similar to that organized in South Dakota, and secure northern grown seed for a new trial which would be likely to prove successful.

It may be well to state also that a study of soil conditions is as equally important as the seed, and for information in this direction the farmers should communicate with the Soil Division of the Department of Agriculture at Washington, or the head of the Agricultural Department of their State University.

**Save
Your
Heifer
Calves**

During a conversation recently with a leading dairyman of Northern Illinois, who has a herd of 65 cows, the subject was discussed of purchasing new milch cows to replenish the herd, when at a certain season a fair percentage of them "go dry," he stated that the present price for good cows ranges from \$100 upward and that he frequently paid as high as \$125.00 for a good animal.

This gentleman is conducting his farm of 205 acres on the old fashioned plan of leasing on shares, he furnishes the dairy herd, power to run all machinery for shredding, grinding and silo filling, while the tenant supplies all other machinery such as harvesters, harrows, plows, manure spreaders, also horses, wagons, etc.

The tenant gets one-half of the net profits from the milk and young stock, the major part of the products of the farm being used for feed. In the contract for a lease it is specified that the tenant is to pay one-half the cost of new cattle to replace those who die or become useless from age, or other causes; on the other hand he (the tenant) is given a half interest in all the young stock, half of what the calves bring when sold or an undivided one-half of all calves raised to replenish the herd.

In talking generally on this subject the writer suggested that this heavy outlay for milch cows could be obviated by raising the heifer calves and our informant stated that at the present prices for milk this was a rather expensive plan. He stated further, however, that if the tenant is a man with a good knowledge of dairying and stock raising, that the calves could be given the milk from the cow during the first week or ten days and then switched to some other food, thereby doing away with the loss entailed by feeding milk for a long period.

Our informant stated that the average tenant who works on a "half the profit plan base," rarely cares to go to the trouble of raising calves as his share of the selling price was a source of ready

money and that he does not take the interest in building up a herd such as does the owner who is located on and working the farm himself.

The fact remains, however, that with the increasing value of dairy cows, the owner will find it necessary to insist on the tenant raising the better heifer calves, in order to get the best returns from his investment. Thousands of calves are being sold in our central markets daily which would, if raised on the plan outlined, materially reduce the cost of dairy cattle and it is our impression that this plan would also tend to reduce the present price of beef.

Dynamite For Sub- Soiling

We are publishing in this issue an article on subsoiling with dynamite by J. M. Smith of Fort Gibson, Oklahoma, which contains some very good suggestions for farmers who are troubled with hard-pan and who have difficulty in breaking up the subsoil with the ordinary plow. Mr. Smith states that there is no question but that dynamite has solved the farmers' problem of how to plow deeply and get all the benefit therefrom while in time they escape the bad effect arising from the use of deep tilling machines, which he thinks, are the cause of blending the subsoil with the top soil and in that way prove ruinous to the field for years. We are inclined to take exception to this statement of Mr. Smith, in view of the experience of those who have used such machines as the Spalding Deep Tilling Machine and other plows of that character. It is a well known fact that wherever a plow such as the Spalding has been used, the crops have been materially increased and there has been much less trouble in the way of holding moisture in the lower soils for the plant roots during the dry season. While there is no doubt that plows, such as the Spalding, bring the subsoil to the surface, if the plowing is done before the Fall rains the hard-pan and other hard soils disintegrate and mingle with the soil in such proportions as not to prove deleterious to crops. It is, of course, acknowledged that where large quantities of hard-pan or the harder subsoils are brought to the surface, that unless this soil is fined by rain or atmospheric action, the seeds as they germinate find difficulty in taking root, but where the plowing is done prior to the Fall or Winter rains, this trouble would be almost if not entirely eliminated. We would like to have an expression of opinion from others who are acquainted with this subject, for publication. Any of our readers who are familiar with the use of deep tilling outfits and the results obtained therefrom, are asked to correspond with us so that we may give the information to our readers throughout the country.

Idaho In Lime Light

Our article on the Big Lost River project of Idaho by Mr. Bohm, and his open letter addressed to Governor Haines in our October number, which was replied to in our issue of November, by Governor Haines, stirred up much controversy throughout Idaho and the West, and has resulted in Governor Haines making a special trip over the Big Lost River Irrigation Company's project, accompanied by members of the State Land Board, when a research and study of the problem was made. We note by a Twin Falls exchange that Governor Haines has addressed a letter to J. E. Clinton, receiver of the Big Lost River Irrigation Company, and has made it clear to Mr. Clinton and others that it must now be apparent to all that further delay is not to be looked upon with favor from any source. The Governor states that the members of the present Land Board hope that the expected decision will be accepted as final by all concerned, and he states further that himself and the Board realize that because of the legal difficulties which have heretofore stood in the way, it has doubtless been impossible for the receiver or anyone else to effect a reorganization of the Company, and to proceed with the work of supplying water to the settlers on the project; this delay the Governor states has resulted in great suffering and hardships to many of the entrymen, particularly those who have moved to the project and begun the improvement of their entries, and it is stated that this condition must not be allowed to continue a moment longer than is absolutely necessary. The Land Board, the Governor states, stands ready to lend any reasonable and proper aid in the matter of the reorganization, which should be proceeded with at once.

In this connection our attention has been called to a publication under the title *The Carey Act Farmer*, with publication office at Jerome, Idaho. Officers of this organization are W. P. Stafford, president, Gooding; S. S. King, first vice president, Deitrich; A. R. Wells, second vice president, King Hill; and L. T. Alexander, secretary-treasurer, Jerome. Nothing appears in the editorial head of this publication to indicate which one of the gentlemen fills the position of editor, it is presumed, however, that Mr. Alexander of Jerome, the point from which the paper is issued, is the responsible party.

In an issue of this publication for October under the heading, *The Lost River Controversy*, it is stated that it has been decided to try *The Lost River* case in the newspapers instead of the courts. *The Farmer* goes on to say that "THE IRRIGATION AGE, a paper published in Chicago a thousand miles from the project, has taken it upon themselves to

apprise the people of Idaho as to their condition and to prescribe a remedy, and that in this process THE AGE has incidentally taken a fall out of the Land Board's past and present of that State"; continuing the editor says, "this discussion was brought on by the appointment of a Commission to look into the matter and report to the Governor. THE IRRIGATION AGE by virtue of its name, has seen fit to deal itself a hand, and there will be a merry war from now on. "We think," says the *Farmer*, "THE AGE has no talk coming unless they represent the bondholders, as they certainly do not represent the settlers."

The editor of THE AGE takes exception to these statements made by the *Carey Act Farmer*, and wishes to emphasize the fact that it has never at any period, during the 14 years it has been under his control taken sides with the bondholders. It has regularly and forcibly stood for the settler in every instance, and if the gentleman who edits the *Carey Act Farmer* had followed our columns carefully, statements of the character above quoted would not have been made. It may not be out of place to state here to the editor of the *Carey Act Farmer*, that the editor of THE IRRIGATION AGE covered the entire Twin Falls territory many, many times before the sage brush was removed from any of that land now so largely exploited throughout the United States. He visited that section as far back as 1891 and has gone into the territory several times a year since that time. Hence, the statement of the *Carey Act Farmer's* editor is unfair in so far as his statement goes that THE AGE "certainly does not represent the settler." We are inclined also to take exception to their statement that THE AGE certainly should, if it had any suggestions to make, have made them in private, and not through its columns. It appears to us that this is rather a peculiar position for the publisher of a paper to take, and places the editor of the *Carey Act Farmer* in a ridiculous light. It was our impression that the *Carey Act Farmer* was fair in its editorial conduct, but we are not inclined to take that view since going over the article mentioned. It is safe to say that the editor of THE IRRIGATION AGE has covered the Twin Falls tract as thoroughly as any man outside of old time settlers in the State, and perhaps it would not be a bad plan to learn the personnel of the publishers of the *Carey Act Farmer* and obtain, if possible, some definite knowledge as to their wide experience in irrigation affairs, locally or otherwise. It may be possible later on to learn something about the gentlemen whose names head the editorial column of this publication and give our readers some idea of their experience along irrigation and reclamation lines.

IRRIGATION IN OREGON.

By John H. Lewis, State Engineer.

In the State of Oregon, we have but recently passed from the pioneer stage of irrigation development into the more complicated stage of expensive works, shortage in water, and numerous controversies. With only seven people to the square mile (over 500 to the square mile in one county) it is apparent that there is yet much room for development. We expect in the near future to reach that stage of irrigation development where the ordinary summer flow of our streams will be augmented many fold through the release of stored water, as is the case in a number of the older irrigation states.

This transition from the pioneer period of unregulated diversions to that of strict public control of all diversions is not easy of accomplishment. The entire thought and life of the water user must be adjusted to the new order. He must abandon the indefinite miner's inch and think of water in second feet and acre feet. He must respect public and private rights to water and suffer the penalty for violating law. Until the water user, the courts, and public generally, understand the reasons for each feature of the new system and appreciate the general benefits to be derived from a strict enforcement of its provisions, it will be difficult for the administrative officers to attain the best results.

Irrigation is necessary in eastern and southern Oregon, but until recently has not been considered necessary in the northwestern, or more densely populated section of the state. The annual precipitation is unevenly distributed, as illustrated by the government record: at Glenora, 135 inches; Portland, 45 inches; Government Camp, 90 inches; The Dalles, 15 inches, and Umatilla, 8 inches; each point being approximately 50 miles east of the one preceding.

In the extensive and fertile Willamette Valley only three inches out of the 45 inches of annual precipitation falls during the summer months, while about 20 inches fall during the winter months. Already several irrigation projects are being constructed with a view to supplement this summer deficiency.

Throughout much of central Oregon, which ranges in elevation from three to four thousand feet above sea level, the precipitation varies from about eight to fifteen inches. This district which has long been famous as being the largest area in the United States without railway transportation, is now being rapidly settled, due in part to the active railway construction now under way, to the reduction of from five to three years' residence required for homestead entry, to the increase from 160 to 320 acres allowed to each entryman, on non-irrigable land, and primarily to the fact that the precipitation in this vast empire is believed to be ample for dry farming purposes.

With only 686,129 acres of land irrigated out of a total of 61,200,000 acres, and with about 4,000,000 acres susceptible of irrigation, the public has become aroused to the importance of irrigation development in Oregon. It is apparent that from six to ten times the population can be supported on

irrigated lands in comparison with an equal dry farming area. As the land to be irrigated is well scattered throughout the dry farming and grazing districts, it is also apparent that the value of such lands will be somewhat enhanced through the irrigation of adjoining tracts.

The courts are becoming educated to the value of water and are now less willing than formerly to grant extravagant claims in water adjudications. If twice the amount of water necessary to produce crops is allowed, it is readily apparent that the ultimate area to be irrigated will be reduced approximately one-half. For this reason the public is vitally concerned as to the duty of water. Public funds have accordingly been appropriated for the making of accurate stream measurements extending over long series of years, for the making of topographic surveys and river profiles, and for determining the quality of the public waters. There is thus a general awakening among all classes as to the importance of irrigation.

The value of dry farming lands ranges from about \$5 to \$30 per acre. Irrigated, this land would sell from \$40 to \$100 or more per acre. Improved irrigated land has been known to sell at from \$500 to \$1,000 per acre, and over. Water has, therefore, considerable value, and water rights and titles are now receiving careful consideration. In some sections one cubic foot per second of water, flowing continuously during the irrigation season is estimated to be worth approximately \$10,000.

The cost of irrigation works has increased from \$5 per acre in 1900 to an average of \$15 in 1910, according to the government census and systems are now planned or are under construction estimated to cost \$40 to \$100 per acre. The amount of water and record evidence of water titles are therefore important matters, which are now given serious consideration by the investor, the water user, and the public.

In 1909, Oregon adopted a water law which is similar in many respects to that now in force in the Province of British Columbia. It has in general been found satisfactory to both the water user and the prospective investor, and is not burdensome to the public, as the fees, collected and paid into the state treasury, have gone far towards meeting the appropriations for its maintenance.

The law deals primarily with (1) the adjudication and recording of rights to water which were initiated prior to its adoption; (2) the granting of new rights after proper application and record, and (3) the protection of all recorded rights, as well as of the public interest in unappropriated waters. Its administration is in the hands of the state engineer and the superintendents of the two water divisions into which the state has been divided, each of whom has special duties to perform. All important grants or decisions are made by these officers sitting as a board.

This law declares all water within the state to be the property of the public, and makes beneficial use the basis of rights to its use. In the water right certificate, which is record evidence of title, this basis is qualified by a definite statement as to (1) the priority, (2) the purpose, (3) the period, (4) and the place of use of water; also by (5) the maximum rate of flow or quantity of water. Such cer-

tificate gives also the name and address of the owner of the right, and the stream from which the water is diverted.

Owing to the peculiarities of climate and soil, and to the necessity for diverting water for irrigation and other uses, the strict common law doctrine of riparian rights established by early court decisions has been so modified in recent cases that only the faintest shadow of this conflicting doctrine remains to cloud the horizon of the investor in water projects. In some of our states the common law doctrine still prevails in modified form and is a serious handicap to the adoption of modern administrative water codes. The Canadian provinces should be congratulated upon the freedom with which they can adopt laws suited to their conditions, without a long period of turmoil and expensive litigation by those who wish for some personal or financial benefit, to have the streams flow undiminished to the ocean.

Although our water code has been in effect four years, we are just reaching the point where its practical operation can be observed by the irrigator. All rights to water on a number of streams have been adjudicated and recorded, and water masters have been in charge of distribution. These water masters are appointed by the water board, but are paid by the county court. They are thus not as responsive to orders of the superintendent and the board as if paid directly by such board, and subject to dismissal for cause. Another difficulty has been the requirement of law that water masters should be residents of the district from which they are appointed. This prevents the promotion of experienced men to the more complicated districts.

In defining water rights in Oregon, the water board has generally specified a particular rate of flow for a definite irrigation season. When the amount of water thus decreed was too small to furnish an adequate irrigation head, rotation was authorized. In this way each man could at any time ascertain whether or not his neighbor was taking more than his share. In case of rotation among a group of neighbors, the total quantity of water used by any one, should not exceed the sum of that allotted to each. Self interest will cause each man in such rotation group to see that he gets the total quantity of water his full share of the time. Such a decree is almost self-executing, as the average water user is honest and will not take more than he is entitled to, if he knows the water supply is not sufficient for all. In Wyoming, where they have had long experience in distributing water, it is the exception rather than the rule to call out the water master to administer such decrees.

For old rights, one cubic foot per second is usually allowed for 50 to 80 acres, depending upon local conditions. All new grants for irrigation purposes have been restricted to the rate of one cubic foot per second to 80 acres. The average irrigation season, or time between the last killing frost in the spring and first in the fall, has been carefully estimated from official records, at 120 days. The above rate of flow will deliver during such period three acre feet of water on each acre of land. This in general is sufficient for alfalfa, the ordinary crop requiring the greatest amounts of water.

Much difficulty is encountered in defining and

protecting rights on flood water streams. On such the floods run off early in the spring, leaving the stream practically dry during the summer months. Rather than build expensive reservoirs, the pioneer settlers flooded their lands by means of ditches or temporary diversion dams, thus storing water in the soil itself. In most cases but one crop of wild hay yielding about one ton to the acre is produced, but under favorable conditions one to two cuttings of alfalfa have been produced.

In such cases, a larger rate of flow is allowed and the total quantity of water for the irrigation season limited to 2.5 to 4 acre-feet per acre. The volume limitation in certain cases has been further qualified by defining the amount in acre feet which can be diverted within any period of, say, thirty days. Such a decree is difficult to enforce. No reliable and inexpensive instrument has yet been devised for automatically recording acre feet. The water master must be employed whether a controversy exists or not, and no water user will know whether or not he is getting the amount of water decreed him, unless he keep an independent record throughout the entire season.

Many water masters will thus have to be employed as each ditch will have to be measured one or more times each day. If the water master is not present when water is being run, his records will be incomplete.

Under such system it will be difficult to convict one of stealing water. It will also be difficult to convince each water user that he has received his full share of water. Such system of defining water in acre feet is more suited to large canal systems where numerous ditch riders are necessary to distribute the water, and where but little additional expense would be entailed in keeping accurate ditch records of the volume of water used each day.

Gravity irrigation under large ditch systems did not become a complete success until the common carrier canal was abolished, and water was made by law appurtenant to the land. Those planning to pump water have not forgotten the early experiences of the water user under such canals where the charge for water, after the expiration of the original short-time contract, was increased by the company in accordance with the settler's ability to pay. It is believed that pumping for irrigation purposes will not reach its fullest development until both the power and the water are made appurtenant to the land benefited, either through district or state ownership and distribution of power.

This question is of particular interest to Oregon for the reason that we have a considerable area which cannot be economically supplied by gravity canals, but which may be irrigated by pumping from adjoining streams, or from underground sources.

Along Snake River in eastern Oregon, a pumping plant was recently installed for the irrigation of 6,000 acres where the maximum lift was over 100 feet. An irrigation district has been formed for the irrigation of 20,000 acres adjoining the above project where the lift will be 200 to 300 feet, and the land about 2,300 feet above sea level.

In central Oregon there are great interior

basins, each containing several hundred thousand acres of level land, where the rainfall does not exceed the evaporation. In most of these basins a limited supply of water is found from 20 to 40 feet below the surface. With a permanent supply of cheap power this water could be pumped for at least partial irrigation of these districts.

It is the duty of the state engineer to refer to the state water board any application wherein the proposed use conflicts with determined rights, or is a menace to the safety or the welfare of the public. This board can direct the refusal of such application after full hearing, if public interest demands. This feature of the law has recently been upheld by our Supreme court (*Cookingham vs. Lewis*, 114 Pac. 88) and marks a distinct advance in water legislation.

In Oregon we have a number of large irrigation projects which can be developed at reasonable cost. Unfortunately, the early settlement in these districts has occurred along the streams, and there is a strong natural tendency to complicate and delay the construction of the larger projects through the construction of power plants in the stream channels, or the building of railway lines through available storage basins. If the entire stream basin were owned by an individual, he would compel the power plants to locate a few miles distant on some tributary of the stream, where the water could be used for irrigation after passing through the power wheels, although such construction would be perhaps a little more expensive. He would also compel the railroads to locate their lines around and above feasible power and reservoir sites, in order that the large projects which must be eventually built will not be unnecessarily encumbered, and their construction correspondingly delayed.

The state is endeavoring to look somewhat to the future in these matters as indicated by the above authority granted to its administrative officers for the protection of the public interest.

Recently a further step in this direction was taken by our legislators. The sum of \$50,000 was appropriated for the making of detailed plans and estimates of cost of a number of these projects, and authorizes cooperation with the United States. The Government has allotted an equal amount from the Reclamation fund and the investigations are now being carried on jointly. The necessary land and water rights are withdrawn so as to prevent further complications, and it is the intent to assign such plans, and rights to the people forming themselves as a district for the construction of the project, or to private capital, who will undertake to carry out the public plans on terms satisfactory to the people. Failing in this, the legislature has submitted a constitutional amendment for vote of the people in 1914, authorizing the issuance of bonds equal to two per cent of the assessed valuation of the state for the construction of irrigation and power projects, and for developing the cut-over timber and other lands of the state.

In other words, the state is now authorized to make water filings, and to gather all necessary information relative to these large irrigation and power projects, which may be necessary in promoting their construction by either private or public

funds. It has also taken the first step looking towards construction with public funds if such action is found necessary.

The "wild cat" irrigation project has seriously retarded development in the west. The financier has become skeptical of all irrigation projects, and the settler without the ability or means to investigate every feature of a complicated project, refuses to invest. Those who have purchased dry ditches write letters warning their friends against western investments. A few such failures can easily offset an expensive development campaign.

The western people are responsible for these conditions and not the administrative officers. Some of our states have not as yet undertaken public supervision of their water resources, others refuse to give their administrative officers the necessary power to deal with the situation effectively, and all refuse to make adequate appropriations for stream measurements and records of water supply, so that the situation could be handled if the laws were adequate.

If a public officer insists on delay while he is securing water supply records, he is accused of blocking progress by red tape methods. Not even the land owners in whose interest he is laboring will support his action. It is generally assumed that an engineer should be able to measure the water in a stream, and make a complicated water supply report in about the same time and for about the same cost as for a land survey.

For an expensive project where it is planned to utilize practically all the surplus waters of a stream, daily records for a period of ten years are sometimes insufficient as a basis for an accurate estimate of the available supply.

The remedy for the "wild cat" evil lies first in more liberal appropriations for stream gaging work; second, more authority for the administrative officers in passing upon questions of water supply, cost and financial ability, before allowing a large project to proceed; and third, stronger support by the people benefited, in case a project is turned down.

Water is of more value than land in the west. It is highly important that the people be aroused to the value of public water surveys, and the necessity of securing more complete information as to the duty of water.

SEEPAGE WATER

An interesting decision on the right to seepage water is that of Comstock vs. Ramsay (Colorado), 133 Pac., 1107. It appears that the natural flow of the stream had all been appropriated; that owing to the building of irrigation ditches and a reservoir some distance from the stream, certain waters seeped back into the stream through the gravel and sand underlying the soil sufficient to supply certain appropriations prior in time to upper appropriations which took the natural flow. On the basis that the seepage water was part of the supply of the stream which had been wholly appropriated by prior appropriators, the court reversed a judgment in favor of a claimant who had constructed a ditch, caught the seepage water before it reached the stream and sought to acquire a right to use the stream as a carrier of this seepage water so caught in his ditch.

AN ANALYSIS OF THE "BIG LOST RIVER" SITUATION

To the Editor of THE IRRIGATION AGE, Chicago.

Sir:—His Excellency, Governor John M. Haines, of Idaho, in the November number of your publication, replying to the "Open Letter" addressed to him by me, appearing in your October issue, has taken me to task upon the broad general grounds of "unfairness." In the issue containing the Governor's reply you have, editorially, extended to his Excellency and to myself, the courtesy of further use of your columns.

Since the point of ethics may be raised, permit me, in advance, to offer that in my opinion the Governor's communication calls for a reply as public as the previous correspondence—not because it is at all essential that your readers should be burdened with any attempted vindication of myself from the charges and insinuations of the Governor, but because the broad questions at stake appeal to me as transcending the limits of any personal controversy.

Of tremendous public importance is the correct solution of the Big Lost River—the issues presented within the project itself are grave enough, and I approach their discussion with a full measure of appreciation of the fact—but in its broader aspects, is it too much to say that the entire fundamental subject of reclamation under the "Carey Act," through the intervention of private capital is upon trial? There are not wanting critics—men whose utterances we listened to with respect, and who from their official connections, would be presumed to resent any reflections upon the ability of the states to cope with their problems—who are ready to pronounce the "Carey Act", measured by past achievements, a failure.

Under the circumstances, I feel justified in addressing this communication to yourself, and through you to the general public. I trust that in so doing, I will not appear to be acting in disregard of the conventions and that His Excellency will accept my explanation as sufficient grounds for so acting.

Although this question should be approached from the standpoint of public policy and interest, I find myself unable to frame an apparently fitting reply to the Governor's communication without a free intermingling of references of both "public" and private nature. I am loath to do this, but see no way to avoid it, as there is no time at my disposal for the production of a finished document. In the high esteem in which I hold the high office occupied by his Excellency, I yield to no man, and nothing is further from my intention than to make a public issue of a private controversy. The Governor, through his personal references, however, calls into question the sincerity not only of myself, but of practically all the great number who, from interest in the project or from the standpoint of principle, have protested against the apparent inertness of the state officials.

I would say to the Governor that I have a deep appreciation of the difficulties attaching to his official position as Governor and chairman of the State Board of Land Commissioners. I realize better than the average reader, perhaps, the difficulties

which have confronted "Land Boards" of the various "Carey Act" states generally—constituted as they are of already overworked officials, whose time is absorbed by the routine duties of their permanent offices. The intricate questions of water rights, construction and financing would constitute in themselves a sufficient burden for a corps of officials not otherwise engaged. These facts are not generally understood outside of the "Carey Act" states themselves, and should be mentioned in justice to their officials, but their mere recital does not furnish justification for the situation. In only one state, so far as my knowledge extends, has the land department been established upon a permanent and sound basis—in Colorado. Efforts in the same direction in other states have met with failure. In assuming to criticize the apathy of the states in this matter, it is only fair to say further, that I am one of those who have consistently protested, through the press and otherwise, against the injustice and inadequacy of the old system. I am aware that public officials are often—and unjustly—subjected to criticism. It is too often the case of being "damned if they do and damned if they don't"; but this condition is unfortunately one of the penalties of high office. If any remarks contained in my "Open Letter" can fairly be construed in the light of prejudice or as an intimation that I held the present state land board responsible for the "Big Lost River" failure, I assure you they were not offered with that intent, and can call forth only regret upon my part and a sincere desire to make reparation. Let us look at the matter from an unbiased standpoint, however, and will any one deny myself or any other entryman the right to utter public protest to the officials now clothed with responsibility, or can the unprejudiced observer find anything to justify the unwarranted reflections upon myself and others? Whatever view may prevail as to the merits of the contention or as to questions of good taste, it is my sincere belief that no public official is placed beyond the bounds of criticism—all the more so when the issue is one of such grievous wrongs as those of numerous settlers upon the Big Lost River segregation.

His Excellency, in his opening paragraph, conveys the idea that I am "attempting to qualify as one having expert knowledge," etc. Let us dispose of this contention in a few sentences: The issue presented has nothing to do with the subject; it is the conduct of "Big Lost River" that is upon trial. The editor of THE IRRIGATION AGE knows, and so do many others—at the national capital and at the seats of government of many "Western" states—that I have spent years of *my own time*, and as a corollary, some little of my substance, in a study of the subject of the reclamation of our arid lands. Some of these gentlemen, in tight places, have felt themselves justified, upon occasion, in expressing some measure of esteem for the writer, and these testimonials he cherishes highly, regarding them as some measure of compensation for what little public service he may have been permitted to render. In any event I have "paid the shot" for whatever "expert" knowledge I may possess and with its payment I assume, goes the right to be heard. His Excellency states that I am unfair in my treatment

of the case, "and, by implication, that all others, who, from time to time, have protested upon the same grounds, are unfair." I could borrow a few similes, more or less exaggerated, that might be fitting but do not care to indulge in persiflage, at this time. As to what is "fair" or "unfair," I dare say the Governor will agree with me, that the ultimate meaning of these terms hinge, largely, upon the point of view. However, lest anyone may, mistakenly, assume that I entertain any prejudice against the magnificent State of Idaho, its officials or its good citizens generally, permit me to offer that I have, since my first glimpse of Idaho, upon several occasions, repeated my visits to the State, attracted by its many features of interest, its "glorious" climate, its superb scenery, and delightful capital city. When I made entry upon the "Big Lost River" tract, I did so with the full intent of becoming a citizen of the State—need I say more? I have several good friends in Idaho whom I cherish highly—and I can not say too much in praise of the never-failing courtesy extended to me by the present Registrar and Assistant Registrar of the "Land Board." I recall, with gratification, the courtesy shown me by numerous State officials upon the occasion of my last visit some eighteen months ago. Upon purely personal grounds, there is every reason, therefore, why I should harbor a friendly feeling for the State of Idaho. Permit me to quote to the Governor from a lengthy article contributed by myself to the conservative *Idaho Statesman*, under date of June 24, 1912. The article opens with a eulogy of the State and of the Capital City which should satisfy the cravings of the most ardent "booster." After tribute to the "Land Board" and a brief discussion of the State's water problems I disposed of the Big Lost River matter with the following sentences—I challenge any "unfairness" in them—"As to the Big Lost River it would be improper at this juncture to say much (the case was then, as I recall it, being argued in the Federal District Court), but it is 'up to' the State to 'make good' to the entrymen—for, at least, the amount of their first payments. The State approved the project, threw the lands open to entry and allowed the company to retain all moneys, without any protection to the entrymen." The issue of the AGE in which appeared the Governor's letter contained, also, a contribution from myself in which I referred to the splendid work accomplished in the Snake River Valley, comparing it only with the achievements in the Salt River Valley of Arizona. Let the facts speak for themselves.

"It will not help, at this time, to seek to excuse or palliate admitted errors," as the Governor rightly says, "nor to condemn the selfish policy of those who sought to make political capital out of an *unfortunate business situation*" (the italics are mine). Quite right, but who are those "who sought to make political capital"? I do not assume to speak for anyone but myself, but I feel safe in saying that there are many entrymen—and small bondbuyers, as well, who would appreciate a more concrete reference. Are they the victims of the "admitted errors," who have sought, through such means as were permitted them, to protest and to secure the protection tacitly guaranteed by the State, in 1909,

and, which a federal court, by recent decision, has given them legal grounds to expect, or does the Governor intend his reference to those citizens of the State and to that portion of the press who, from motives of public policy or principle, have likewise condemned the "Lost River" fiasco and who have held up to the State its paramount duty to right the wrongs of the entrymen—at whatever cost? Personally, I know nothing of the "politics" of the State—as the word is generally understood, and would consider it bad taste to inject myself into such, but no entryman who takes an intelligent interest in the subject can be blind to the fact that the demand upon the part of the people and press of Idaho itself, for full reparation has been growing more insistent day by day. Lest anyone should be tempted to regard this as "poetic license" and to show that my own often-repeated views as to the State's moral liability—regardless of any "saving clause" in the statutes, were shared by both classes let me quote a few of numerous instances. The conservative *Idaho Statesman* (October 25, 1912), under caption "Big Lost River Settlers Get Attention" has this to say: Quoting a letter from Mr. Benjamin P. Shawhan of the Carey Act Land Department (in part): "There are a number of entrymen who desire such use" (of the water as previously discussed) "while the laws protect the State from responsibility, it can not, in my opinion, be relieved from the moral obligation to use every endeavor to protect those who have bought land from the State under the Carey Act and who relied upon it for a proper supervision which they had some reason, at least, to believe was a protection."

Lincoln County Times (November 13), referring to the Governor's letter of November 5 to the receiver (for which I wish to afford him full credit and approbation): "We are glad to see the Governor acknowledge that the State has, at least, a moral obligation to the settlers it has brought here, and upon the success of the settlers depends the ultimate success of every Carey Act project in the State. This has always been the contention of the *Times* and if former Land Boards had shown a little more interest in the settlers and less attention given to the appeals of the irrigation companies, Carey Act Projects of Idaho would not be looked upon with distrust as they are today by the people of the east." *Statesman* again commenting upon the Governor's letters (in part): "The responsibility of the contractor's bond would then be brought into question, raising a point that goes clear to the heart of our Carey Act plan and which many regard as one of its weakest features—inadequate protection to the settlers in case of failure after the first payment has been made." These cover the very points for which I have contended for years—publicly and privately; the legislators of the State can hardly plead lack of information upon this point. If the statement contained in the *Capital News* of August 21 (which journal appears to have taken the initiative in the present 'agitation') be correct, the Governor has expressed himself emphatically as being in accord with these views. It is needless to go further along these lines of argument. But what shall be said of the attitude of mind implied by the use of the term "unfortunate business situation?" Can the Governor reconcile this conception of the

matter with his public utterances indicating his adherence to a doctrine directly at variance with this thought? A "business situation." The events of recent years have brought about a newer and better conception of the relation of States and Nation towards public land and water resources. It is not occupying too advanced ground to say that the "business" conceptions, are responsible, almost entirely, for the lamentable crash of the irrigation campaign of a few short years ago—the reverberations of which still resound in the ears of the people. That reclamation, down to a certain point, is essentially a Government function, is becoming more evident daily, to how large an extent to be effected by the States, through Carey Act or "district" laws, will depend upon the alacrity of the States, themselves, to meet the demands of the situation. Truly, I must regard the Governor's characterization as a remarkably unfortunate one. The Governor sets forth, as ground for failure to bring suit against the "Construction Bond," the fact that the Federal Appellate Court had withheld its long-expected decision in the Corey Brothers' suit. Happily, as I write, this obstacle has been removed and nothing short of an appeal to the Federal Supreme Court should interfere in this direction now. I will not say that the contention of His Excellency, at the time of this writing, was not well founded, for I have no views as to the legal merits of that problem worth expounding. It is of interest to note, in this connection, however, that there has existed in Idaho, more than one view upon this matter and that the State did *not* put the question to the test by *bringing action*. Instead, it was left to one of the entrymen (a woman, in this case) to bring suit against the bond, upon her own initiative and the attorneys retained by her did not appear to entertain the views advanced by the Governor. This information was conveyed in the *Capital News* of October 23d. It is far from my desire to distort matters or to assume a prejudiced attitude, but the fact remains that the Governor, according to the files of the *Statesman* in my possession, did not address his famous "Get Busy or Get Out" letter (I am quoting the headlines of an Idaho paper) to Receiver Clinton until November 5th subsequent to action of Hazel Sauve (entrywoman) and some time prior to the decision of the Federal Appellate Court. I trust the Governor will advance a sufficient reason for failure to adopt this aggressive attitude sooner. It would be useless to refer to the subject at all, but since His Excellency has seen fit to charge me with "utter unfairness" I will be "fair" enough to call his attention to this matter of some importance, when viewed from this distance. Back of what may appear like a hair-splitting contention, what about the *ethics* of the entire matter? What can the State officials expect of entrymen who see their investment lost in a shadowy enterprise and from whom all information is withheld by their "Trustee" except as it may be gathered through unofficial channels or by imposing unnecessary burdens upon individual members of the Land Board in reply to letters of inquiry? Surely the Governor must be aware that the great majority of entrymen reside outside of his State—many of these thousands of miles distant—and that these are not only "out of touch" intimately with the affairs of the State, but are deprived of

all means of participating in them? I do not know what the experience of others may have been, but personally I have received, in the three years succeeding the "Big Lost River" failure, but one document bearing upon the situation—that one a letter from the receiver under date of February 1, 1912. For such information as I have received I am indebted to officials of the Land Board, in reply to personal letters of inquiry and to the press of Idaho. If the "Big Lost" is nothing more than a "business transaction"—of "caveat emptor" import—then let business ethics prevail and let the State, which has sold its land with the implied guarantee that its contractor would perform certain acts necessary to give this property value, assume (?) liability towards its vendee for its failure to enforce the provisions of its contract. Thus might one argue from the narrow standpoint.

It is my conception, however, that a broader view should prevail. The Governor asks for thoughtful suggestions and constructive advice and I firmly believe that every man interested should contribute his quota of helpfulness towards any constructive measures undertaken in the future. I cannot, along this line, do much more than offer the very general suggestions advanced in my letter of October.

As a broad proposition, every one in touch with irrigation development would be disposed to regard financing with private capital as a hopeless undertaking, at this time, but the affairs of "Big Lost River" are so involved and its problems so peculiarly its own that I feel incapable of more than a repetition of the admonition to collect on the construction bond to complete the project with State funds, directly, or to assist whatever private parties are finally awarded the equities left, with the State's credit, as suggested by Mr. Guenther in the *Financial World*. Barring these avenues, there is yet one other road to travel—cooperation with the Federal Government. The new policy has been adopted in the sister State of Oregon in the investigation of irrigation and power projects and Director Newell is quoted (*Capital News*, October 23), as saying that "Washington is doing the same thing to complete some of the projects in that State and California is to join with the "Service" in completing some of the projects."

There are not wanting advocates of the adoption of the "cooperative policy" in Idaho. In its issue of August 21, the *Capital News* makes a strong plea for its adoption. It has its advocates among land officials of other States as well. The recent agreement between the department of the interior and the administration of Oregon, was referred to at length in my article appearing in the November AGE entitled "Conservation and Cooperation." In that State (under chapter 87, laws of 1913) the sum of \$50,000 was appropriated by the State, and like amount allotted by the secretary of the interior for cooperative investigation. The sum of \$450,000.00 was appropriated (chapter 119, laws of 1913), for the construction of the aforementioned "Tumalo project" where water rights were sold by promoters under the Carey Act to 275 settlers "with the apparent backing of the State," and the supply found inade-

quate for even the thirty-five settlers who moved upon their land. The secretary of the interior, I am informed, has offered to contribute an equal amount, "which will be sufficient properly to care for all the land in this vicinity of this Carey Act Project." I commend the legislation upon this subject to the earnest attention of the Governor. In Washington, as I am advised, the legislature at its last session also adopted a law providing for cooperation with the Federal Government in the "Palouse" project.

To quote the Governor further, "equally grave mistakes may be expected in any new enterprise operated under untried and perhaps insufficient laws, administered by inexperienced officials pioneering a new field." All very true, and because of the demonstrated failure of some of the States to rise to the demands of the situation, the gospel of "cooperation" with the stable reclamation forces of the National Government is, everywhere, gaining ground. But let us analyze the Governor's apology for the sins of a former administration and with the prefatory remark that the present administration should be held responsible for the former failure only to the extent that its personnel are heirs-at-law, in the natural evolution of biennial changes, to the consequences of former mistakes and misdeeds and must live up to the obligations those imposed upon it. As to Carey Act operations, in 1909 being new enterprises, I cull from the third annual report of the State Land Department (1909) the following: (Page 1): "The last congress granted to Idaho an additional 2,000,000 acres of land under the Carey Act, making a total of 3,000,000 acres. Up to the time of passing said act, applications had been made to the land board for the segregation of 940,000 acres. Since its passage, additional applications have been filed, making a total of more than 2,300,000 acres. From present indications, balance of the land will be asked to be segregated soon. These projects *which have caused more immigration to the State than any other one thing* (the italics are mine) are located in the following counties." "Idaho is far ahead of any other State in the Union in the development of Carey Act lands." Follows the annual report, as required by statute, of twelve Carey Act companies; a list of 22 companies to whom segregations amounting to 1,155,056 acres were granted, a list of 7,857 "entries" of 3,316 "final proofs" and of 13 applications for segregation for a total of 1,117,190 acres. This report does not convey the idea of a "new field"—especially in view of the number of "entries" and "final proofs." The very "Big Lost River Irrigation Company" of 1909 was built upon the ruins of the "Big Lost River Land and Irrigation Company," which had contracted with the State in 1907 and had met financial shipwreck—all the more reason for safeguarding the *reorganized* enterprise. Is there any excuse in the face of long-preceding, overwhelming, "development" for either "untried and insufficient laws" or for the "inexperience of officials." The Federal "Carey Act" was adopted in 1894 and its two principal amendments in 1896 and 1901 respectively. The act whereby the State of Idaho adopted its provisions was passed in 1899. There was no lack of experience or of able counsel to point out legislative amendments prior to 1909.

Rather does the situation not argue for a considerable degree of recklessness in the handling of the problems attaching to the administration of the princely domain of 3,000,000 acres? What ground existed in 1909 for placing these tremendously important matters, involving the destinies of many people—even their very lives—into the hands of inexperienced officials? The Governor fails “to make a case.” One of the contributing factors to the “Big Lost River” failure was the faulty construction of the dam which jeopardized the property and lives of the people of Mackay. The reports rendered by eminent engineers, and accepted, are matters of record. If the Carey Act Code was “insufficient” the General Irrigation Code is specific enough. I refer to Political Code, chapter 10. Section 154a provides that “any person (etc.), desiring to construct any dam for storing water, more than 10 feet high, shall submit plans and drawings to the State Engineer, who shall examine them and, if approved, so indicate, or in case of disapproval return them for amendments—in case of works of *great importance* shall make test excavations, etc., and extends his authority still further. In view of the condemnation of both plans and construction of the dam, by the engineers who examined it, are apologies based upon the “inexperience” of officials, at this time, to be taken seriously? Here are the words of the engineering commission: “It, therefore, appears to us that the fatal defects in the work are due to plans and specifications, rather than to the construction.” “That the filled reservoir would in my opinion be a serious menace to the town of Mackay and to the Lost River Valley.” We are of the same opinion, but go further and believe that it would inevitably lead to disaster. (*Arco Advertiser*, September 15, 1910.)

Now, I have permitted myself only the briefest reference to the history of the project and only to the extent that the “incidents mentioned were germane to the discussion in hand. A volume of interest and pathos could no doubt, be worked out from the material at hand. The Federal Court of Appeals has, at last, been heard from and it is now squarely “up to” the Land Board to show its hand. I have dealt with the case entirely from the standpoint of the entryman—the plight of the bondholders is, no doubt, an unfortunate one, but these people are represented by able counsel and must find their own spokesman. The Governor has seen fit to characterize myself “and others” as “adepts at destruction, but mere novices at construction.” Such tirades mean nothing and, in the interests of harmony, I will overlook the remark, whatever its rather obscure meaning. I have attempted to “stick to the text” in full confidence of the inherent justice of my contentions. If any animus has crept into the discussion, I trust the gentlemen of the Land Board, from the Governor down, will accept my apology for such and beg them to consider that *four years*—not to complete but to *get ready* to complete—covers a considerable period of an average lifetime. I can assure His Excellency that, in any proper measure of rehabilitation, I shall, if called upon, attempt to do all that is possible to assist in the work of reconstruction.

Sincerely,

E. F. BOHM.

FOR THE GOOD OF IRRIGATION.

Movement to Induce Interested States to Finish Some of the Uncompleted Projects.

An earnest movement is in progress in the West which seeks to interest the states to complete irrigation projects which have gone to the wall. Most of these schemes failed through ignorance in construction work and faulty engineering and the greed of promoters, who sought all the profits.

Much of the capital raised throughout the country to finance these irrigation works was turned over by investors in the belief that they were fully protected under the Carey Act. It would have been impossible to have raised anywhere near the amount of money that was secured by promoters had the case been otherwise. Nearly every one who bought an irrigation bond did so under the impression that the states, through the authority vested in them by the Carey Act, were overseeing all work and that it was being done honestly. The many disasters in irrigation have proven this act to have been worthless as far as it safeguarded investors. It saved none of them.

The states are in a measure bound to give what legitimate aid they may extend to investors who have lost their money in these projects, and in addition to developing the resources of these states, state aid would prove a very good business stroke for the states which found it feasible to complete such projects.

State aid may be given without bringing any new debt upon the states, for we are quite sure that the bondholders would willingly subordinate their liens to whatever loans the state might grant in order to save these half-built properties. This money the states would eventually get back, with interest. More important would be the great profit which would come to these commonwealths through the increase in the prices of productive land and from the larger population which would be bound to come. Another asset would be found in the re-establishment of the states in public confidence.

Oregon has already taken a step in this direction by advancing \$400,000 to complete the Columbia Southern project. Idaho, Wyoming, the latter the mother of the Carey Act, and Montana and Colorado, however, are backward and have done little or nothing.

Under present conditions it is impossible to raise any capital for irrigation enterprises. So many persons have lost money in this class of securities that it is only necessary to mention them to an investor and he is frightened away. How could it be otherwise? Money must be obtained from somewhere.

This situation is to be deplored since fundamentally irrigation is an industry having vast possibilities for profitable investment. There are many communities in the West which have demonstrated that by irrigation springs of unhidden riches have been uncovered. Irrigation will eventually solve our agrarian problem, which is to find enough land to maintain our rapidly increasing population, since the greater part of our arable land is already under cultivation.—*Financial World*, N. Y.

THE NATIONAL LESSON AT TULSA.

The Dry Farming Congress Was Not a Congress of Dry Farmers.

By Douglas Malcolm of the I. H. C. Service Bureau.

Omitting the brass bands, the military display, the fireworks both pyrotechnical and verbal, the Eighth International Dry Farming Congress which was held at Tulsa, Okla., from October 22 to 31, inclusive, marked another milestone of that progress which should be the goal of every farmer and farmers' wife of the Northern Hemisphere. It was the most stupendous testimony to the modern theory of agriculture, that head work plus hand work means success, that the writer ever witnessed. From origins which as recently as ten years ago were considered leagues beyond the dead line came wheat weighing 62½ pounds to the bushel and 38 bushels to the acre, potatoes weighing over 5 pounds each, squashes over 3 feet long, alfalfa making 5 tons to the acre; and corn that would make the average corn belt farmer envious and sad.

Five large buildings were required to furnish sufficient room for the exhibits which poured in,

the long rows of soil products, was an indirect but deadly protest against American carelessness in farm methods. It was shown at Tulsa that to a man who is familiar with the general farming from Florida to the Dakotas, dry farming is nothing more nor less than applying, to land which suffers from lack of rain, principles which produce the best results when applied to land enjoying plenty of rain.

It was a nation-wide lesson on good farming. It proved that the successful rules of good farming were the good rules of successful farming. The pioneer settlers on practically desert land were left to demonstrate by practical results what farm journals, government schools and the service bureaus of the big machine companies have tried to teach, that the fundamentals of farming are deeper plowing, better cultivation, more animal fertilizer, and better seed selection. It was claimed by those who had experimented for years that in breaking up the sod it is more profitable to turn it under from 10 to 12 inches than from 4 to 8, which is the popular depth. By actual experiment between two acres in the same field, land treated by deep tillage yielded \$100 more in produce in 10 years than a similar acre plowed only 6 inches. In another case in

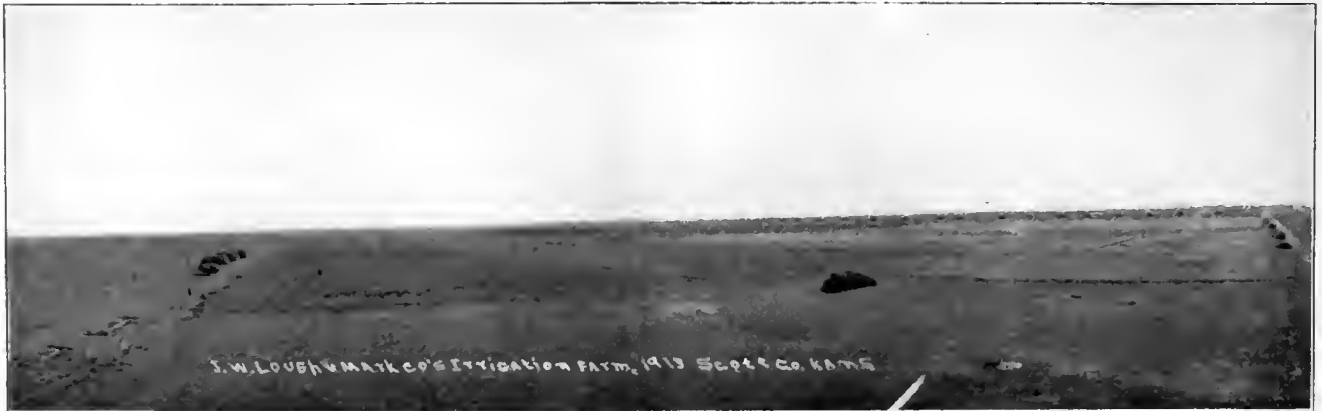

J. W. Lough & Mark Co.'s Irrigation Farm, Scott County, Kansas.
Land Sown to Alfalfa Shows a Clear Profit of \$80.78 per Acre.

Irrigated from Underflow by Layne & Bowler Pumps. Some of this This Land was Valued at \$25.00 per Acre before It was Irrigated.

not only from states and counties, but from individual farmers. Many thousand dollars, much farm machinery, and several cups were awarded as prizes to the various exhibitors. But these awards and prizes were merely symbols—badges of recognition. The real winners, as shown by the Congress, were the two nations, Canada and the United States—winners in that the food problem was being solved within their borders, and winners in the possession of a rural population with the spirit to brave unfriendly natural conditions and the brains to conquer them.

The American farmer, since first he stretched his hand out to McCormick for his reaper, has stood apart from other nations because of his progressiveness. He has stood apart, also, because of his ingratitude to the soil upon which he depended. Land which in England or France has been yielding bountifully for a thousand years would have been hopelessly depleted in a generation by the average methods followed in this country.

The Dry Farming Congress, from the speeches of the illustrious agriculturists who were there, to

bringing out the value of humus as a factor in increasing the water holding power of soils, it was found that in 100 pounds of ordinary sandy soil there was 19 pounds of water, while on the other hand, the same amount of garden soil, well filled with humus, contained 53 pounds of water, or nearly three times as much. By deep plowing before the rains, followed by good cultivation to save the stored water, the amount of water available for plants can be increased nearly fifty per cent. With such an increase there should never, even in the driest sections, be such a scarcity of water as to cause a loss of the crop. The best insurance against drouth next summer is deep plowing this winter and early spring. Turn the land, if possible, to a depth of at least eight inches, and then follow this plowing with some implement in each furrow that will stir the soil at least another four or six inches. With such preparation before the rains come, such soil should and will absorb enough water to insure a crop next summer.

Another significant event which characterized the Tulsa Congress was the assembling of the third

annual meeting of the International Congress of Farm Women. It was one of the strongest and best organized women's gatherings the country has ever seen. It was in session five days and many women of national note were present and addressed the delegates on matters of especial interest to the housewives on the farm. The keynote of this event was contained in an address by Mrs. Belle v'D Harbert, Manzanola, Colorado, who presented the life's duties of the home-building mother in a brilliant speech characterized by one of her auditors as "almost pathetic in its challenge and almost challenging in its pathos." She said:

"The International Congress of Farm Women organized at Colorado Springs in October, 1911, is a woman's movement toward the goal of social justice.

"The world has absolutely failed to appreciate the economic value of the farmer's wife, and she has now stepped upon the stage of social progress and offered to help in the solution of the world's great problems. Her experience as the keeper of the rural home from which so many great men of all nations have come, her knowledge of the burdens and care which have driven so many thousands of her sisters from the farm to take refuge in the cities, and her unselfish desire to be of real service to humanity, have prompted this organization. Results most important to the future of all nations are sure to follow.

"It is the beginning of a new era in country life. There is no doubt as to the responsibility for the wholesale movement toward the city during the past decade. Women become tired of the drudgery caused by lack of convenience in the rural homes, but which are furnished in the cities. In the city she has water in the house, fuel for cooking, lights, and often heat. The sewerage problem is solved and there are a thousand other conveniences which she could not have under present existing circumstances in the rural communities. She becomes tired of the monotony and isolation she has to endure and naturally turns to the city as a means of relief.

"Farm women have hitherto labored and died as individuals. They have never been recognized as a class or factor in the world's work. Other great industries have always had ample consideration at the hands of the government, the state and by the student of social problems; so have the wage earners, but she who has given to the world its recruits of brain and brawn has had no fitting recognition.

"Much has been said of late about the popularity of the 'Back to the Farm' movement on account of modern methods of soil tillage, up-to-date machinery and a better knowledge of farm management; but practically nothing has been said in regard to power for household use, best methods of securing a plentiful water supply for the house, the most sanitary methods of disposing of sewerage, and up-to-date methods of furnishing light and heat for the farm home.

"These household problems must be solved before the 'Back to the Farm' movement will ever be popular.

TO DETERMINE THE WATER REQUIRED BY VARIOUS STANDARD CROPS.

Practical Results of Cooperative Experiments in Irrigation at California University.

The office of experiment stations has been co-operating with the department of engineering of the State of California and the University of California for several years in irrigation investigations to determine the water required by various standard crops. Some of the practical results of this work are published in bulletin No. 10 of the United States Department of Agriculture, which shows at what stage of growth alfalfa should be irrigated, when irrigation of barley should pay, how Indian and Egyptian corn responded to irrigation, and the effect of irrigation on grain (wheat and oats) in rotation with alfalfa. The experiments were made at Davis in the Sacramento Valley, where the normal annual rainfall is about 16.5 inches, occurring mainly from December to March.

The results of the experiments with alfalfa point to the following facts:

(1) In the open, well-drained soil, typical of that found in the floor of the Sacramento Valley, the general tendency is toward an increase in yield of alfalfa with the increased amounts of water applied up to at least 48 inches.

(2) There is a limit beyond which the increase in yield will not pay for increased cost of applying the water, and for such conditions as are found on the University farm this limit is in the neighborhood of 30 inches applied as a total for the season.

In applying these conclusions to other localities, it is well to remember that local conditions are always the controlling factors. The character and condition of the soil, the climate, the rainfall, the length of the growing season, and the age of the alfalfa, all have their effect upon the yield, and each general locality will show different results and a different economic duty of water.

In the experiments with the small grains there was not one instance where the increase due to irrigation did not more than pay for the cost of the water that produced it, the yield increasing with the increased amounts of water applied. With sugar beets "in general the sugar percentage decreased with the increased amounts of water added, although in every case this decrease was overbalanced by the increase in yield." The results obtained, however, must not be interpreted as justifying an indefinite increase in the use of water in the case of small grains and sugar beets.

Regarding corn, one of the main conclusions reached was that the time of applying water is of as great importance as the quantity of water applied. These factors will always vary with the season, and the intelligence of the irrigator along these lines has much to do with his profit or loss, which is also true regarding the other crops experimented with.

LAYNE & BOWLER COMPANY EXPAND

A deal was consummated recently by which the Layne & Bowler Company of Houston, Texas, acquired possession of the property of the Allen Engineering Company.

The Layne & Bowler Company is recognized in the irrigation world as among the leaders in the



Herding Turkeys on J. W. Lough's Farm, Scott County, Kansas.

manufacture of irrigation pumps for deep and shallow wells and as irrigation well contractors. They operate large shops at Houston, Texas; Los Angeles, California; and Stuttgart, Arkansas, besides operating branch offices at Welsh, Louisiana, and Jackson, Mississippi. With the acquisition of the property of the Allen Engineering Company, they will be in better position to take care of the irrigation needs of Kansas, Colorado, and Northern Texas, where there is a very rapid development of irrigation work. The officials of the company have had their eyes on Memphis for some time, as a logical point for establishing a factory and, after a careful study of the transportation facilities and central location as compared with that of several other cities, they decided in favor of Memphis.



J. W. Lough's Fourth Crop of Alfalfa. Total Yield for 1913. Seven Tons per Acre. Scott County, Kansas.

The Houston factory will now devote their energies to supplying the export trade and local demands from the Gulf Coast fields. Besides the manufacture of water screen and pumps, the company is a large manufacturer of oil well strainers.

The property of the Allen Engineering Com-

pany consists of ten acres of ground located on the Memphis Belt Railroad, on which are located large foundry, machine shops, pattern shop, and warehouse. This is practically a new shop of the latest design, well equipped with late models, and direct motor-driven machines. It is valued at \$125,000.00 and will prove a valuable acquisition for this rapidly growing company. It is the intention of the company to erect modern dwelling houses for their machine men on the vacant acreage.

ALFALFA BIG EARNER

The past dry season, cheaper fuel oil and the discovery that an inexhaustible supply of water may be had throughout western Kansas from the underflow has stimulated great interest in irrigation in that section. Results for the past season show wonderful profits. The greatest progress is being made along the Arkansas Valley and in the shallow water districts in Scott and Meade counties.

An extensive irrigation pumping plant has been in operation for a year on the Laugh-Marks ranch in Scott county. On land which was not worth over \$25.00 an acre before the installation of the



Irrigation Well on Lough Ranch, Scott County, Kansas.

pumping plant a crop of alfalfa has been harvested this year that shows a net earning per acre of \$80.78, on a gross earning \$105.00 or over four times the value of the land before the pumping plant was put in.

On this ranch is a pump operated by fuel oil installed by the Layne & Bowler Company, Stuttgart, Arkansas, and Memphis, Tennessee, which lifts 1,600 gallons of water per minute. A recent test run was made, the pump flooding $4\frac{1}{2}$ acres of alfalfa in $3\frac{1}{4}$ hours. The pumping cost was \$305 for this run, including 40 gallons of fuel oil at $4\frac{1}{2}$ cents per gallon, one pint of lubricating oil, 20 cents per hour for engine man and 15 cents per hour for water distribution.

Another ranch man claims that he realized \$95.00 net an acre under the same system.

The accompanying half tones will give a fairly good idea of the crops and country.

Send \$1.00 for 1 year's subscription to the IRRIGATION AGE and bound copy of THE PRIMER OF IRRIGATION. If you desire a copy of The Primer of Hydraulics add \$2.50 to above price.

GOVERNOR HAINES SERVES NOTICE ON RECEIVER OF BIG LOST-RIVER PROJECT

The following is a letter addressed by Governor Haines of Idaho to J. E. Clinton, receiver of the Big Lost River Irrigation Company. This letter was written after Governor Haines and the State Land Board had visited the project when they interviewed a large number of the settlers and entrymen. Governor Haines is showing a disposition to go thoroughly into this matter and we look for good results from his recent visit to the project.

November 5, 1913.

J. E. Clinton, Receiver, Big Lost River Irrigation Company, Boise, Idaho.

Dear Sir:—

The members of the state land board have heretofore believed that they should await the decision of the circuit court of appeals in the case of the Corey Brothers Construction company vs. the Big Lost River Irrigation Company before taking any steps which would serve to indicate the attitude of the state in the settlement of this most important question. The time consumed in the settlement of the legal questions involved has been much greater than was anticipated, however, and it must now be apparent to all that further delay should not be looked upon with favor from any source.

The members of the present land board accordingly hope that the expected decision will be accepted as final by all concerned and we say this prior to the decision so that it may apply alike to both parties to the controversy.

We realize that because of the legal difficulties which have heretofore stood in the way it has doubtless been impossible for you or anyone else to effect a reorganization of the company and to proceed with the work of supplying water to the settlers on the project. This delay has resulted in great suffering and hardship to many of the entrymen, particularly those who have moved to the project and begun the improvement of their entries, and must not be allowed to continue a moment longer than absolutely necessary.

We have been given to understand by the attorneys for the several litigants that there is no likelihood of an appeal from the decision of the court of appeals. We propose, however, to forestall further appeal if within our power to do so, because such appeal can only result in delay in the reorganization of the company and still further delay in the doing of justice to the entrymen under the project. Our reasons for this conclusion must be sufficiently obvious to all who have given any thought to this matter and we desire you, as receiver of the company, to notify the different litigants that they cannot expect further inaction on the part of the state land board. Should further appeal be attempted we shall be compelled to at once bring action to cancel the contract existing between the company and the state.

On the other hand the land board will lend any reasonable and proper aid in the matter of the reorganization which should be proceeded with at once. Those who may have charge of the new

company must be made to realize the sufferings and hardships of the settlers and must so shape their plans as to fully protect them in the future. The moral obligation resting on the state in this matter, enjoins the members of the land board to insist upon: First, early reorganization of the company and actively looking to the resuscitation of the project, and, second, such reorganization as will provide primarily for the welfare of the settlers, upon whose success depends ultimately not only the physical and financial success of this project but of all other Carey act projects within the state.

Yours respectfully,

JOHN M. HAINES,
Governor.

SUBSOILING WITH DYNAMITE.

By J. M. Smith.

Although devoid of humus, practically all subsoils are rich in mineral plant foods necessary to promote the growth of vegetation. Many varieties of subsoils are so physically constituted that plants are unable to send their roots down into them to gather the mineral elements required for their growth. This is due to what is known as tight soil conditions, as hardpan beneath the top soil.

The advantage gained by subsoiling with dynamite is that the subsoil is not only fully broken up, thus releasing and making available for plant food the sustaining mineral elements contained in it, but this subsoil is not thrown on top of the ground with the exception of probably a shovelful from each hole that is tossed out by the blast. As subsoiling holes are spaced about fifteen feet apart, it is readily seen that the mixing of this very small quantity of subsoil will in no way injure the top soil.

By doing the subsoiling with dynamite at any time between harvest and the advent of hard freezes, the soil thus mellowed and made porous is put into prime condition for the storage of water, and in the spring is in the best possible condition for planting, because of the additional moisture stored in the soil from the fall rains and the thawing snows of winter and spring. Water thus conserved is where it is needed instead of on the surface, where it will speedily run off or evaporate, and in the spring the crops are likely to have the benefit of sufficient moisture to carry them through even an extraordinary dry growing season.

There is no question but that dynamite has solved the farmer's problem of how to plow deeply and get all the benefits therefrom, while at the same time escaping the deleterious effects arising from the use of the deep tilling machine which so conspicuously blended the subsoil with the topsoil and often proved ruinous to the field for years.

There is no necessity for a single crop failure where suitable cultivation is practiced on land that has been properly subsoiled with dynamite.

Send \$1.00 for 1 year's subscription to the IRRIGATION AGE and bound copy of THE PRIMER OF IRRIGATION. If you desire a copy of The Primer of Hydraulics, add \$2.50 to above price.

CONCRETE GARBAGE BURNERS.

An Effective and Durable Device for the Destruction of Trash and Debris.

The best way to get rid of garbage and all combustible trash is to burn it, and the most satisfactory way to burn it is to construct a concrete stove or trash burner of the type shown in the accompanying illustrations.

Concrete stoves of this character may be placed at any convenient location and if it is found necessary to build them in some conspicuous spot, they may be decorated with some simple design if constructed in the urn-like form shown in Fig. 1.

These concrete stoves may be used with open top and kettle for heating or cooking food for poultry and live stock as well as for burning garbage and other trash. They are most convenient to have about the home or on the farm.

To build a garbage burner of the type shown in Fig. 1, dig out the dirt to the depth of six inches. For forms choose two barrels, one of which will set within the other with a clearance on all sides of six inches. Adjust the height by cutting off their butts. Make an opening through which a metal ash box can be inserted or over which an iron door can be hung. Fill the foundation hole and the forms with 1:2:4 concrete. Remove the outside form after two weeks. The fire will later take care of the inner form. After three weeks the burner may be used. Briefly described, this furnace is a cone-shaped structure 5 feet in diameter, 4 feet high, with 8-inch walls and 24-inch screened openings. The fire-box or ash-box is 12 by 14 inches.

Another type of burner is shown in Fig. 2. This furnace, in a word, consists of an old grate, a second-hand iron door and a length of terra cotta drain pipe for a chimney or pipe. It is cheap and will last forever. In the case of the first burner described, it may be constructed with a flat top and opening therein for a large coking kettle. With the front door and grate at a higher level it would make an excellent outdoor grill for a permanent camp or country estate.

To the man of mechanical turn, working in concrete is play. Given a quantity of Portland cement, he merely adds thereto twice as much sand and four or five times as much crushed stone or gravel. When the mass is thoroughly mixed and wet to the consistency of mortar, or to the degree that it can be poured into a mold, he has a plastic material which becomes as hard as iron when it has thoroughly set and seasoned. As a humorist expressed it, "the tooth of time goes to the dentist when it tackles concrete," the latter being the name of the above mixture

To make anything of concrete, molds of wood, plaster or iron are used, the wet mixture being poured or tamped into the forms or molds.

As stated, this convenient device, with its water-shedding nature, is indestructible. Rain and frost do not affect it, and it will never rust, disintegrate or decay. It is so simple that any person of mechanical bent should be able to build one.



Figure 1.



Figure 2.

Reclamation Notes

ARIZONA.

The appointment of a survey board to outline the area of the Salt river reclamation project has been announced. A representative each from the United States reclamation service, Washington and the United States reclamation service at Phoenix and one from the Water Users' association, comprise the survey board. The work will begin at once.

There has been quite a little complaint this fall about road-flooding, and if there is any one evil in connection with irrigation that justifies almost any means of prevention, it is that one. The loss of water in this way is deplorable, while the damage to roads and to ditches is no small matter. All of us know that no farmer would intentionally waste water, let his ditches break, or flood a road. However, the frequent occurrence of flooding in certain districts indicates a most careless neglect and a failure to realize what a loss this entails, not only on the farms directly affected, but on the community generally.

The cost of proper upkeep of dirt ditches is, of course, quite an item, but is practically nothing compared with the benefits therefrom. The clean ditch, with banks in good condition, tends to greater velocity in the flow of water, helps to do away with the weed nuisance, and is not continually breaking out with a big loss of water and the resulting damage to roads and crops. Of course, the cement ditch will largely do away with this, but all ranchers, of course, cannot afford to install them now. All the more reason, then, for their giving greater care and attention to the upkeep of their dirt ditches.—Arizona Republican.

The Chandler-Walker syndicate who for the last two months have been seeking to obtain signatures of land owners in that section southeast of Chandler across the Consolidated canal on which they purposed to install an up-to-date system of pumping plants whereby they would reclaim about ten thousand acres of fine land have about obtained the required amount of land, work will begin in a short time. Only such lands as are signed up when the allotment of water is made will enjoy the benefits of the system to be installed as it would be impossible to allot water to the other lands that come in later as the amount developed will be one second foot per quarter section. It is the intention of the promoters to install a plant and then test the water supply and allot it as far as it will go and then put in another plant and so on. The average lift of water in the project is about 45 feet and it is not expected that the expense of pumping will be very much higher than the charges under the gravity system.

CALIFORNIA.

At the annual meeting of the Monte Vista Irrigation Company, held at the offices of Emil Firth, in Los Angeles recently, the land owners took over from Mr. Firth the water company interests, consisting of four high power pumping plants, ten miles of pipe line, supplies, and other property. The company, it is stated, has no bonded indebtedness and has money in its treasury. This is the final step in the organization on a working basis by Mr. Firth of another of several large co-operative water companies.

The following officers were elected: Frank Danks, president; C. A. Marks, vice-president and Perry R. Skeen, secretary and treasurer.

Plans for the formation of an extensive irrigation district in parts of Calaveras and San Joaquin counties in order to secure unity of action for the proposed impounding of the waters of the Calaveras river above Jenny Lind were threshed out at a meeting of those interested in the proposition at the Chamber of Commerce.

A motion providing for necessary steps toward the organization of a district was made by Mayor Reibenstein of Stockton, but it was decided that no vote be taken

until the next meeting in order that all phases of the matter might be thoroughly investigated. Congressman C. F. Curry, who is here familiarizing himself with the needs of his constituents, told what has been done and what is being done in the national capital in regard to the plan, and also gave his opinion on the best way to proceed.

Officers of the La Mesa, Lemon Grove and Spring Valley irrigation district were formally declared elected by the county supervisors at San Diego recently after a canvass of the votes had shown the formation of the irrigation district by a vote of 397 for the proposition to 3 against it.

The directors who were declared duly elected are Charles Samson, S. C. Grable, J. H. Halley, J. A. Thompson, J. H. Barry, Tax Collector T. P. Jenkins, Assessor R. A. Smith and Treasurer L. Sperbeck.

It is the declared purpose of the district to secure a water supply for the district from the San Diego river valley. But one other irrigation district has ever been formed in the county in the twenty years the law providing for such districts has been on the statute books. The first district was the San Ysidro.

Burton Smith recently tendered his resignation as engineer of the Turlock irrigation district, requesting the board of directors to take action on it before January 1, 1914. Smith states that his resignation is due to impaired health and also to the fact that most of the engineering in connection with construction and improvement of the Turlock irrigation district has been done.

Because not furnished with water for irrigation, P. H. Shirley of Fresno, who owns three farm lots in the Sycamore Ranch tract, has brought suit against the Fresno Canal and Irrigation Company, claiming damages for loss of this season's labor and outlay.

The ranch tract is held under a water right of the canal company with the Occidental Land and Improvement company to furnish water.

Relying upon the promise to be furnished water, Shirley says he planted vines and figs, and prepared and checked twenty acres for alfalfa, but that no water was provided, despite repeated demands. The vines and trees died and he could not sow alfalfa.

All his labor, he says, went for naught, and before he can again sow he will again have to cultivate, plow, harrow and check. He figures his total loss and cost at \$402.

COLORADO.

An aftermath of the crash of the George H. Paul Orchard company, an extensive horticultural undertaking near Pueblo, was recorded in the district court at Pueblo recently when suit was filed by the Arkansas Valley Construction company for \$4,112.65 which it claims is due on a construction contract by the orchard company.

Incidentally, the suit brings up an involved question. It asks for judgment in the form of a lien on the Teller reservoir which the plaintiff claims was in possession of the orchard company when the contract was signed and completed. The contract was to construct concrete conduits and laterals from the reservoir through the orchard company's property and to repair old laterals.

J. C. Ulrich, the engineer who was engaged by the committee to inspect the proposed reservoir site on the Conejos river has returned from a trip to the site. He went carefully over the ground and formed conclusions from comparisons of the site with that of the Farmers' Union reservoir on the Rio Grande which enterprise he engineered. He made no tests to determine the character of the formation and consequently was not prepared to make a definite report but from surface observations he pronounced the proposition substantially the same as the Farmers' Union reservoir site, with the exception that it is much larger. From what he could see he believes the site feasible and if the capacity of the reservoir should prove to be what certain previous estimates have placed it at he regards it as one of the comparatively least expensive storage propositions in the west. A former survey by other parties estimates that a dam 135 feet high

will impound 100,000 acre-feet of water and that the length of the dam would be 1,200 feet at the top. Providing these figures are correct, Mr. Ulrich is of the opinion that the structure would cost from \$750,000 to \$1,000,000 or from \$7.50 to \$10 per acre foot of water, impounded.

Test wells are being sunk by the Otero Canal company near Fowler, Colorado, and if the experiments prove successful a number of irrigation wells will be developed along the canal to supply the ditch with water when the river is low.

"We are making preliminary experiments at this time, hoping to develop wells of sufficient capacity to use five second feet of water," said J. D. Craighead of that company. "If this can be done we will develop as many as fifteen wells at points along the ditch and turn the water into the Otero canal for use on the several thousand acres under the ditch. The first test well was sunk at a point near the west gate just east of Fowler, and we were unfortunate when we struck shale at a depth of thirteen feet, a few days ago. We will probe the nearby ground for a more favorable location and sink another well immediately. We are hoping to have better luck next time."

Before the Colorado road builders' convention at Pueblo recently Prof. E. B. House, head of the irrigation engineering department of the State Agricultural college, amused the audience in prefacing his address with a touch of humor on the advantages of the engineer who is familiar with the irrigation terms, for instance the words, "dam" and "damsite," thereby enabling him to give vent to his perturbed feelings at times without violating any of the rules of etiquette.

He stated that an occasion of this sort came to him personally recently in corresponding with a very original sister-in-law. Mrs. House had not been maintaining her end of the correspondence with her sister, so the sister remitted a brief and businesslike letter in the form of so many questions, like this: Please answer the following questions in the enclosed stamped envelope. Are the children sick? If so what with? Are you sick? If so, what with?" etc.

Professor House was delegated the honor of making reply, and he did so in an equally technical manner. The sister-in-law returned the questions and answers, the only comment being at the bottom of the page, a conspicuous "Dam" then a parenthetical explanation: "An obstruction to bank up a stream."

The professor in reply informed the sister-in-law that she was mistaken and that bank wasn't an obstruction in a stream "by a dam site," but however, her "dam letter" had been received and contents noted.

"I may not be fully apprised as to the dam information you impart," came back the reply, "but I will admit that your abbreviated letter is a dam site better than none."

IDAHO.

Hazel Sauve of Iron River, Wis., an entrywoman on the Lost River irrigation project, has begun a suit against the Title Guaranty and Surety Company of Scranton, Pa., for \$23,160 damages due to the irrigation company's failure to supply water. The Scranton company is the surety for the irrigation company in a bond for \$175,000 and it is for that reason that the suit is against the surety, as the irrigation company is insolvent.

If Mrs. Sauve wins her suit there will be many others against the same company. Indeed other suits are preparing.

The state will probably have to intervene in these suits because it is morally and equitably if not legally bound to protect the entrymen who were deceived by the irrigation company to their heavy loss.

KANSAS.

Winston G. Churchill, who has invented an irrigation pump that will lift water to any desired height, at a minimum cost of operation, will give a demonstration at Modoc, Kan., which will be witnessed by a large number of people. His pump will lift 800 gallons of water per minute from a depth of 128 feet, using an 18-horse power engine. Mr. Churchill is one of the leaders in western Kansas for developing a pump for irrigation and will give

a talk on pump irrigation, showing how the farmers of western Kansas can irrigate at a normal cost. He claims that a system similar to that used by him is the only thing that will remedy the situation in the western part of Kansas. The cost of placing the Churchill pump is from \$12 to \$25 per acre for 160 acres, depending upon the depth necessary to go for a sufficient supply of water. Upon a basis of 160 acres the cost of a ditch and for its maintenance is from \$80 to \$160 per year. Figuring a lift of 35 feet with an 8-inch pump, a flow of 1,000 gallons per minute can be readily obtained.

At the forum last week there was demonstrated in Wichita a most unique system of irrigation. It is a seepage system and the inventor, Mr. Jas. A. Wilson of Arkansas City, says that it is just as near perfect as possible. The system consists of tile pipe laid underground, just deep enough to clear the plow, and the water seeps through the pipes. By peculiar construction of air chambers this system keeps the air underground, allowing the ground to remain sweet. The inventor claims that this system will irrigate ten times as much ground as other systems, with the same amount of water.

A great many people gave the system their hearty approval after investigating it and Mr. Mueller, the Wichita greenhouse man, is going to put the system in and give it a thorough tryout. Mr. Page House, just north of Wichita, now has the system in use and speaks very highly of it. It is probable that Mr. Wilson has figured out the principle that we have all been working for. If he has he deserves the support of all.

A local company has been formed at Plains, in Meade county, Kansas, to engage in sub-irrigation, as a demonstration. Fifteen acres have been leased adjoining the town of Plains for the purpose.

At Leoti the State Board of Irrigation accepted the irrigation plant from the contractors who have just installed it. The reservoir is 150x50 feet. It is filled by six windmills pumping from separate wells. If necessary more wells will be added.

The mills are twelve feet in diameter with a direct stroke and are of the latest pattern. This is the first plant to be installed under the irrigation act of the last legislature.

Work is starting this week at Dighton. This will be followed by the plants at Tribune and Sharon Springs. The ground will be irrigated this winter and sown to crops and trees in the spring. In Wichita county the settlers are taking considerable interest in windmill irrigation and a number of them are already installing private plants.

T. J. Crist, a Hamilton county, Kansas, farmer, is now harvesting a good crop as the result of one of the most unique and cheapest irrigating experiments used this year. Mr. Crist had a large field on a side hill, with a large pasture on the hill above it. He did his irrigating by conserving the storm water that fell on the side hill. He plowed furrows diagonally across the pasture land, having them terminate at a point at the upper entrance to the cultivated field. A deeper furrow through the middle of the field carried the water that was gathered by the ditches in the prairie land, and this water fed into the furrows on either side, which contained milo maize. There were few rains this summer, but one good one in the spring soaked up the entire field and gave Mr. Crist the most profitable milo crop in his county.

Five farmers near Great Bend, Kansas, are entering into a co-operative scheme whereby they will be able to irrigate some 750 acres of their farms in dry times. They propose to get water for this purpose by damming West Walnut creek, which flows through their land. Frank P. Wood, who is fathering the project, expects to irrigate 300 acres; W. S. Hill, 125 acres; Sam Dorfshaffer, 100 acres; John Wood, 150 acres, and E. B. Kellam, 100 acres. W. S. Gearhart, state engineer at the agricultural college, is preparing the plans for the dam.

Engineer M. K. Ellison of California irrigation districts, will survey the Lombard ranch near Syracuse, Kans., for irrigation purposes. He will install three stations equipped with a 30-horsepower gas engine and

pumps capable of watering 160 acres each. Capacity of each pump, 2,500 gallons per minute. Mr. Lombard and Mr. Ellison went to Kansas City this week to purchase the machinery. This ranch lies south of the river across from Kendall.

Wichita, Arkansas City, Hutchinson, Muskogee, Tulsa and other towns of the lower Arkansas Valley have gained in the formation of an Arkansas Valley irrigation association. Delegates from each of these cities met in Arkansas City recently to organize.

Wichita was represented by the following men who have either tried irrigation by the pump system or have made a study of the question: Schuyler Jones, C. S. Drake, Harry W. Stanley, T. H. Nimon and R. H. Faxon.

The establishment of several irrigation plants in the lower Arkansas Valley during the last two or three years has opened new possibilities to farmers who own lands within the underflow district of the valley. It is believed by those who have already put in pumping plants that thousands of them will be established within the next few years. The meeting at Arkansas City was for the purpose of stimulating work in the direction of irrigation and intensive farming.

MONTANA.

The reclamation service is asking for proposals for the construction work on the Pishkun reservoir supply canal and Sun river slope canal on the Sun river irrigation project. The work to be done is on the north side of the Sun river from 25 to 75 miles west of Great Falls.

The Sun River valley in Montana is now entering upon an era of electrical development which is to hasten the occupation of one of the government's huge irrigation projects.

Seventy miles of transmission line have been built, extending from the Rainbow falls hydro-electric plant of the Great Falls Power Company on the Missouri river westerly through the entire length of the valley to the base of the mountains where the principal diversion dam is now under construction across Sun River. The electrical energy, transmitted at a voltage of 110,000, is stepped down at three transformer stations, from which it will be distributed to the principal features of the work. It is now being used at the Sun river diversion dam operating pumps and air compressors, concrete mixers, derricks, and in lighting the construction camp and the site of the work. The government is constructing a distribution transmission line along the Pishkun reservoir and the Sun river slope canals, a distance of 4 miles.

Philip Mockel, who ranks as one of the largest individual farmers in Broadwater county, was over from his Warm Spring creek ranch the first of the week. Mr. Mockel, who is farming upwards of 1,200 acres of grain, both irrigated and dry land, has several hundred acres of alfalfa and feeds hundreds of head of stock, both cattle and hogs. He has a large ranch home with all modern conveniences, including a gas lighting system, water system and plumbing. Although himself and family live 12 miles from a railroad, Mr. Mockel believes in living.—Townsend (Mont.) Star.

Missoula county has decided to quit building plank bridges over irrigation ditches where they cross the public highways. Steel bridges will be used from now on, with concrete abutments. These structures are said to be practically indestructible, while the county has had to replace the wooden bridges every few years.

Supervising Engineer Savage has recently completed a tour of the reclamation work in progress in northern Montana and reports excellent conditions. The work will be continued this season as long as the frost will permit.

If the Sun river irrigation project is carried out in its entirety there will be 30,000 country people within a radius of 50 miles of Great Falls in twelve years.

I. D. O'Donnell of Billings has been asked by Secretary of the Interior Lane to accept a membership on the reclamation commission of five, which will supervise and

direct all work of the reclamation service. If Mr. O'Donnell accepts he will be made irrigation manager.

NEW MEXICO.

The Hope Community Irrigation Company filed a dissolution notice with the State Corporation Commission. This company organized about two years ago, but never commenced business.

Agua Negra grant, in Guadalupe county, recently changed hands at a price said to be in the neighborhood of \$50,000, J. O. Janes of Janes, Tex., being the purchaser, who will stock it with graded cattle and may place a portion under irrigation.

Secretary of the Interior Lane is enthusiastic for the development of the western states and says that ten million dollars a year can be used to advantage in irrigation and drainage projects during the next ten years.

It is fortunate for the country that we have a man like Mr. Lane, who understands the West and the needs of the whole country, at the head of the department which must deal with the public land problems. It is equally fortunate for the country that Mr. Lane has for his first assistant Hon. A. A. Jones, of New Mexico, who has put in most of his life studying the very questions with which the department must deal.

Properly handled, Secretary Lane is of opinion that enough land, now vacant in the western states, can be reclaimed to supply the grain and meat demands of the country.

OREGON.

Regarding a Washington dispatch in *The Oregonian* that Secretary of the Interior Lane favored state and federal co-operation in Carey irrigation projects, Governor West sent the Secretary the following telegram:

"Dispatch reports your favoring state and federal co-operation completion Carey act projects. Wish to congratulate you upon your stand. Oregon so anxious to complete these projects has declared willingness to go it alone till federal aid arrives. Our efforts meeting with success. Our showing will go far to support your contention."

It is probable that the Governor will communicate further with the Secretary of the Interior in regard to the proposition of state and federal co-operation.

During the past quarter 150 permits for the appropriation of water have been issued by the state engineer, of which number eleven are for the construction of reservoirs. According to these permits it is proposed to irrigate 18,690 acres, develop 21,716 horsepower, as well as for municipal and domestic purposes.

The construction of the works described in these permits would cost approximately \$2,300,000, of which amount \$550,000 is estimated the cost of constructing reservoirs.

Settlers on the Tumalo irrigation project in Crook county will be relieved of water payments to the amount

FOR SALE

8359 acres in Live Oak County, Texas—fenced—cross fenced, 5 wells and windmills, good ranch house, all improvements needed for stock ranch. This property will be sold at a bargain and on easy terms.

Address **DANIEL GELDER,**
Care Irrigation Age

of \$18,805 if they sign their land under the new state project within 30 days, because of the action taken by the desert land board at a meeting recently. This action was taken at the request of Vernon A. Forbes of Bend, who appeared before the board as a representative of the settlers, and upon the approval of Project Engineer O. Lauergaard. It will be a readjustment of the liens and will result in the \$18,805 being taken from the liens on the lands of old settlers and adding the amount to the unreclaimed land.

The federal government has set aside \$15,000 to be used with an equal sum appropriated by the 1913 Oregon legislature for a survey and study of Five Mile Rapids near The Dalles. The feasibility of developing a power project on this spot will be investigated thoroughly. The State Engineer has received word of the action of the federal government in a letter from Secretary of the Interior Lane.

Two army engineers and two from the reclamation service will act as United States representatives on the investigation commission. The Oregon members were named some time ago. They have organized and held a meeting in which the general features of the work were gone over.

Telegraphic instructions were received recently by Register McDonald, of the United States Land Office, that a special act of Congress is in effect for relief of desert land entrymen in Franklin and Grant counties. The act provides for further extensions of time in all cases where entrymen have been unable on account of "unavoidable delay in the construction and operation of irrigation works intended to convey water to the land" to reclaim the land within the time allowed by existing statutes. The act adds three years of life to practically every unperfected entry.

Private projects near Pasco also are benefited, as they are allowed additional time to fulfill agreements with entrymen to get water on the land.

The original desert entry act allowed four years for

reclaiming the land from date of entry. Later an act gave three additional years under certain conditions, and the latest act adds three more, or ten in all, in Franklin and Grant counties, where satisfactory showing is made.

An unusual freak in the way of an apple was brought into Hood River recently by F. C. Sexton of the Odell district. One half of the apple was a perfect Spitzenberg and the other half was a perfect Ortley in both color and flavor. One half was red and the other half was a golden yellow. The apple was grown on a Spitzenberg tree that stood beside an Ortley. The peculiar result is traced to the pollenization from the Ortley.

UTAH.

State Fish and Game Commissioner Fred W. Chambers of Utah has ordered the prosecution of the North Ogden Irrigation Company for its alleged failure to give five days' notice before letting the water out of its canal. It is said that thousands of trout in the stream were killed when the drawing out of the water left them lying on the banks and in the bed of the canal.

Articles of incorporation for the New Era Irrigation Company, composed of farmers residing in the northwest section of Weber county, were filed with County Clerk S. G. Dye at Ogden. The new company is incorporated for a period of 100 years, with a capitalization not to exceed \$10,000. The first officers are Lyman Skeen, president; James M. Wade, vice-president; W. J. Coy, secretary, and Joseph Skeen, treasurer.

The incorporators, together with their place of residence and number of \$10 shares of stock held by each, are as follows: Stephen Knight, Plain City, 5; James M. Wade, Warren, 25; W. J. Coy, Plain City, 10; Lyman Skeen, Plain City, 250; M. W. Wade, Warren, 10; Charles Skeen, Plain City, 25; Joseph Skeen, Warren, 100; D. A. Skeen, Salt Lake, 50.

FACTS ABOUT HENS AND EGGS.

Michael K. Boyer,
Hammonton, N. J.

While heavy laying is as a rule desirable, phenomenal egg records are not a guarantee of strong, rugged offspring. There must be a limit.

The hen that lays 150 eggs in a year is doing mighty good laying, and she is not so apt to break down early in life as is the one which is trying to "break the record."

Pullets and yearling hens that have done such remarkable work in their first season, are not so apt to do heavy work in the second year.

As a rule, hens that lay steadily during cold weather are indifferent hot weather layers.

Extreme cold and extreme hot weather affect hens alike.

The regular layers give the best sized eggs, while the spasmodic layers generally produce an assortment of sizes.

The size of the egg becomes smaller as the hen increases the number of her product. So also does the color gradually change from a dark brown to a light color towards the close of the litter.

The majority of eggs are laid between the hours of 9 o'clock in the morning and 3 o'clock in the afternoon.

There is not very strong fertility in the eggs laid by a hen that will produce from 30 to 50 eggs in succession.

The CROCODILE WRENCH

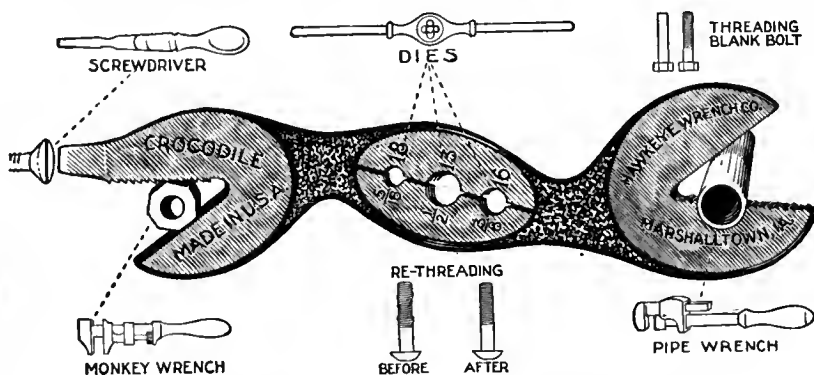

Six Handy Farm Tools in One

The Crocodile Wrench is drop forged from the finest tool steel and scientifically tempered. Every wrench guaranteed against breakage. It is 8½ inches long and weighs ten ounces.

A pipe wrench, a nut wrench, a screw driver and three dies for cleaning up and re-threading rusted and battered threads; also for cutting new threads on blank bolts. Dies will fit all bolts used on standard farm machinery.

Teeth and dies are case-hardened in bone-black, making them hard and keen.

The dies on this wrench alone would cost \$1.50, and would be worth more than that to every farmer, as they would often save valuable time, besides an extra trip to town for repairs.

Sent free with each order for Irrigation Age for one year—price for both \$1.00; also sent to old subscribers who renew their subscription for one year.

Address: IRRIGATION AGE, 30 No. Dearborn St., Chicago

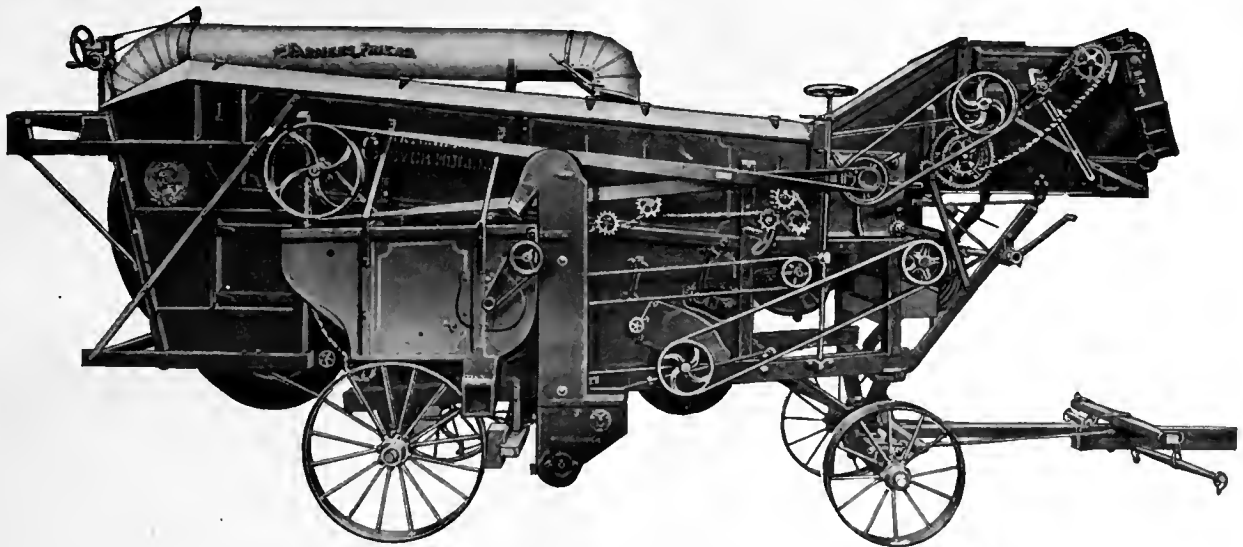

**HULL YOUR SEED QUICKLY, PERFECTLY and ECONOMICALLY With a
"MATCHLESS" CLOVER and ALFALFA HULLER**

That's just what you will do if you use a "Matchless" Huller on the job. It's the one huller that will hull all the Clover or Alfalfa you can get to it without sacrificing the quality of the work. Here's the reason! We use square steel brads in our hulling cylinder. This construction has every advantage over rasps of spikes, because no set of spikes will knock the seed out of the damp pods. Rasps gum up and are easily destroyed. Our system of separation is unique and effective. This consists of a series of rotating troughs with perforation in the bottom, with provision for adjustment to meet the various conditions of clover. The Patented Steel Scrapers attached to the bottom of these troughs thoroughly scrape the separator bottom and insure a steady and positive delivery of the pods to the hulling cylinder, regardless of the condition of the clover. This construction enables you to hull seed under conditions in which no other huller can operate; enables you to hull earlier in the morning and later in the evening than with any other—this insures a longer day, thus increasing your earning power. Give us an opportunity to prove to you right on your own farm that the "Matchless" is the speediest and cleanest huller on the market. WRITE FOR CATALOG TODAY, or call at our nearest Branch House.

THE AULTMAN & TAYLOR MACHINERY COMPANY, MANSFIELD, OHIO.
Sole Builders of Aultman-Taylor "Starved Rooster" Line of Machinery.

BRANCHES: Minneapolis, Minn.; Portland, Ore.; Lincoln, Nebr.; Kansas City, Mo.; Wichita, Kan.; Decatur, Ill.; Indianapolis, Ind.

\$60 a Week and Expenses



**YOU!
YES YOU
CAN GET IT**

That's the money you can get this year. I mean it. I want County Sales Managers quick, men or women who believe in the square deal, who will go into partnership with me. No capital or experience needed. My folding Bath Tub has taken the country by storm. Solves the bathing problem. No plumbing, no waterworks required. Full length bath in any room. Folds in small roll, handy as an umbrella. I tell you it's great! GREAT! Rivals \$100 bath room. Now listen! I want YOU to handle your county. I'll furnish demonstrating tub free. I'm positive—absolutely certain—you can get bigger money in a week with me than you ever made in a month before—I KNOW IT!

Two Sales a Day—\$300 a Month

That's what you get—every month. Needed in every home, badly wanted, eagerly bought. Modern bathing facilities for all the people. Take orders right and left. Quick sales, immense profits. Look at these men. Kunkle, Ohio, received \$240 first week; Mathias, Florida, \$120 in two days; Corrigan, New York, \$114 in 60 hours; Newton, California, \$60 in three days. You can do as well. **TWO SALES A DAY MEANS \$300 A MONTH.** The work is very easy, pleasant, permanent, fascinating. It means a business of your own.

I grant credit—
Furnish Sample—
Help you out,
Back you up—
Don't doubt—
Don't hesitate—
Don't hold back—
You cannot lose.
My othermen are
building homes,
bank accounts, so
can you. Act then,
quick. **SEND NO
MONEY.** Just
name on penny
postcard for free
tub offer. Hustle!



H. S. ROBINSON, President
518 Vance Street, TOLEDO, OHIO

**Sluiced Earth Dams and
Other Earth Emplacements**

The undersigned beg to announce an Agreement of Association under which the moving of earth by sluicing will be jointly undertaken in any part of the United States and Canada. This will cover not only

**HYDRAULIC FILLS FOR DAMS AND
EMBANKMENTS,**

but the cutting down of hills, filling of bad ground, tidal flats, etc., and all the applications of moving earth by the hydraulic process.

The established reputation of the Ambursen organization as Engineers, and the importance and magnitude of the work with which the Lewis organization has been connected—as for example, the regrading of Seattle, Washington, the Westover Terraces in Portland, Oregon, and others scarcely less important—assures to our clients the last word in engineering responsibility and practical experience.

Address at convenience.

Ambursen Hydraulic Construction Co.

88 Pearl St., Boston, Mass.
822 New Birks Bldg., Montreal, P. Q.
Colorado Bldg., Denver, Colo.

LEWIS, WILEY & MORSE, Inc., Seattle, Wash.

WASHINGTON.

Following the decision of Comptroller of the Treasury Downey that the reclamation service can not use United States funds for the resurvey of the Palouse irrigation project in Washington and accept repayment in part from the state of Washington, a new form of contract is being drawn to avoid delay in work.

The new contract is to follow the form already approved for the East Umatilla project made with the state of Oregon, and Acting Director Davis said today he hopes for a satisfactory conclusion within a few days.

"Secretary of the Interior Lane must have decided that the water rights of the Indians on the Yakima reservation is a matter for judicial settlement and to go ahead in spite of the fact that the matter is before Congress now," said United States Senator Jones, after receiving from Secretary Lane a telegram confirming the news dispatch that he had asked the judicial department to begin such a suit.

"The secretary does not need to threaten suit to bring about a compromise. It is all in his hands. He represents the Indians and the reclamation service. If he will say what he wants and what he thinks ought to be done I will get behind. If it meets the approval of the congressional committee, I have no doubt of its passage."

United States Senator Brady of Idaho has given a mortgage of \$275,000 to the Zion Savings and Trust Bank of Salt Lake to secure a loan of that amount, the mortgage covering practically all his personal property in this state, valued at several times that sum. The mortgage is made of record in the county and in several other counties in this state, including Kootenai, where Senator Brady has property.

The greatest part of the loan is believed to have gone into the former Great Western Beet Sugar Company's irrigation project at Mountain Home, after Senator Brady purchased it from the receiver. He is rapidly developing it into a high state of efficiency, reclaiming about 70,000 acres of rich sage brush land. The loan is also probably for developing other large business enterprises the junior senator has in this state.

The mortgage covers the American Falls electric light plant at American Falls, the Mountain Home project, securities held by Senator Brady in a local newspaper, local bank stock and other property.

The hearing before State Public Service Commissioner Arthur A. Lewis of Washington, in the complaint of Pinecroft ranchers against the Pinecroft Orchard Company, involving a water supply for the Pinecroft district, was terminated yesterday by a mutually satisfactory compromise, after the statements of both sides had been heard.

Mr. and Mrs. James Strang, Mr. and Mrs. J. W. Briggs, Mrs. J. J. Kelly, J. A. Woodbury, Mr. and Mrs. W. A. Reeves and O. U. Adams were the complainants.

The company agreed to make all water connections between its mains and users' mains free of charge by No-

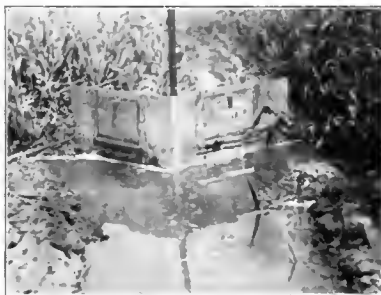
Portable Folding Steel Dam

Portable Steel Dam Is a Boon to Irrigators

last for many years. There is a large demand in irrigated States for this Dam. Thousands of irrigated tracts are being added annually to the large number already under irrigation. Parties interested in the manufacture and sale of this dam can secure U. S. or State Rights by writing the inventor.

W. A. LINKLETTER

BOULDER, COLORADO

Simple in construction and easy to manufacture.

Light, durable and easily carried about.

Easily and quickly adjusted to any ditch. A four-foot dam will fit any ditch up to four feet wide.

With one or more extensions will fit as wide a ditch as desired, or enable the irrigator to turn the water in different directions.

Practical, efficient and convenient time and labor saver.

Can be manufactured and sold at a low price and will

number 1, 1913, and waived all fines, fees and costs for restoring the severed pipes.

Governor Ernest Lister is now in central Washington making an inspection of the Quincy Valley irrigation project as provided for by a measure passed by the last session of the legislature and to which was attached a referendum clause that brings the bill before the people at the next general election one year from November. The governor is accompanied by State Geologist Henry Landes, who is to be a member of the board that will be appointed by the governor under the law if it is adopted by the people next fall.

The Secretary of the Interior has directed the reclamation service to prepare a form of excess land contract and trust deed to submit to certain landowners on the Sunnyside unit of the Yakima irrigation project in Washington.

The land affected lies above the gravity canals system and can be irrigated only by the installation of pumping plants to be located along the main canal. In order to insure an early subdivision and sale to bona fide settlers of all holdings in excess of 40 acres, a contract is to be entered into between the government and the landholders, under the terms of which the government will have power to force such subdivision and proposal.

Almost thirteen years of agitation are at an end and the reclamation of Sumas prairie is in sight if present indications of activity may be taken as conclusive. The L. M. Rice Company of Seattle, which has the contract for dyking the Fraser river, has called for bids on a sub-contract for dredging. If any of these bids are accepted, work, it is stated, will begin as soon as dredges can be placed on the land and in the streams.

SUBSCRIPTIONS.

No one interested in Irrigation can afford to be without THE IRRIGATION AGE: 480 pages of reading matter per year for only One Dollar. If you desire a copy of The Primer of Hydraulics, add \$2.50 to above price.

THE WINNER

THE machine that leads all eighth yard mixers for design, principle, cost of operation, convenience of operation, thorough of mix and low price. Get our catalog and learn *Why*.

The Cement Tile Machinery Co.

175 Rath Street,

WATERLOO, IOWA

ALFALFA SEED AND BANKERS.

H. F. Patterson, Superintendent Better Farming Association, Aberdeen, So. Dakota.

The bankers of Aberdeen, South Dakota, recently voted to set aside \$7,000 to be used by the Better Farming Association of South Dakota at Aberdeen in the purchase of dry land alfalfa seed. The seed was secured from farmers living in the dry part of the state, and will be sold at cost to the cooperative farmers of the association. The cooperation of the Aberdeen banks at this time will go a long way toward increasing the alfalfa acreage in that locality. It permits the farmers to get hardy dry land seed at first cost.

Last season the Better Farming Association was instrumental in putting in about 2,500 acres of alfalfa in Brown county, about 75 per cent of which made a successful catch. The plan that has been adopted for the coming season it is estimated will more than double this acreage. One car of the seed purchased by the Better Farming Association with money furnished by the Aberdeen banks was raised on dry land between the Bad and Cheyenne rivers fifty miles west of the Missouri. The field is between 20 and 25 years old and the original seed came from Russia. The flowers are variegated in color and the root system is spreading, which are indications of hardiness. This particular lot of seed has been recorded in the county and state record books as South Dakota Dry Land Alfalfa No. 1.

The second car was raised fifty miles further

west, and has been growing under arid conditions for about 20 years. This alfalfa has the spreading root system, and is recorded as South Dakota Dry Land Alfalfa No. 2. The recorded alfalfa enables farmers in the future to secure additional lots of seed from the same field.

If bankers in other localities would follow this lead it would have a tremendous bearing on the alfalfa acreage in the United States. The past season was especially good for alfalfa seed production and seed is plentiful for next year's planting. People everywhere are rapidly realizing the value of this most important crop and are planning upon increasing the acreage. The large seed supply is especially pleasing because it will materially assist farmers in securing seed.

Some of the southern states, too, have a big crop of alfalfa seed, even larger than was at first thought. The large supply will have a tendency to keep the prices down and there will be a temptation to send the southern seed north. In fact, much will be sold to a few northern seed men, and they will in turn pass it out to northern farmers. If southern seed is sown on northern soil many will be discouraged with alfalfa growing and both the north and the south will suffer. In view of this the southern alfalfa farmers should see that their seed is sold to the south rather than to the north of them, and northern farmers should know the source of their seed and secure only that which is grown under hardy conditions. Too much attention cannot be given to this fact if permanent success with alfalfa is wanted,



THINK what it means to you! To have at your service—day and night if desired—the combined power of 30 to 35 horses and 10 to 15 men—ready at a moment's notice to plow, disc, harrow, seed, harvest, build roads, irrigate, thresh and do numerous other power jobs, all at the minimum expense for fuel and maintenance. That's what you get when you buy a time-tried and time-proven

**AULTMAN-TAYLOR 30-60
GAS TRACTOR**

They're built with the complete knowledge of the requirements of a tractor of the first quality. They're built right here in our own shop, under our own supervision. We know they're right and we stand back of every tractor. The Aultman-Taylor 30-60 burns either gasoline, kerosene or

distillate with unequalled economy. The Aultman-Taylor 30-60 is not an experiment. Their real worth has been demonstrated on thousands of farms throughout North America. Let us explain to you why you should own and operate one of these money-making and labor-saving tractors. **WRITE FOR CATALOG AND FURTHER INFORMATION TODAY.**

We are also builders of the Famous "New Century" Separator, "Matchless" Clover and Alfalfa Huller, Steam Traction and Portable Engines, Bean Threshers and Saw Mills. Catalog free upon request.

THE AULTMAN & TAYLOR MACHINERY COMPANY
MANSFIELD, OHIO.

BRANCHES: Minneapolis, Minn.
Wichita, Kan.

Portland, Ore.
Decatur, Ill.

Lincoln, Nebr.

Kansas City, Mo.
Indianapolis, Ind.

When writing to advertisers please mention The Irrigation Age.

MISCELLANEOUS.

Ex-Governor W. J. Fitzgerald, of Kansas, is having a survey made on his ranch near Dodge City, for the purpose of establishing an irrigation plant, or plants, if the surveyor considers two plants a better investment. The Fitzgerald ranches already yield fine alfalfa, but increased tonnage is the thing sought by the owner and for that reason, the plants are to be installed.

Sam A. Johnson, of New York City, who has a lot of land in Ford county, Kansas, north of Bucklin, in the river valley, was in Hutchinson recently getting some pointers regarding irrigating from the underflow.

"We have a lot of alfalfa, and believe that by irrigating it will increase the yield," said Mr. Johnson. "I have been interested in what is being done in this part of the valley. We will install some such plant."

Pumping waters from wells 52 feet deep, Dennis Doty, of Finney county, Kansas, irrigated his seventy-acre alfalfa tract from the underflow this year, and sold \$4,000 worth of alfalfa, with another crop about ready to cut.

Mr. Doty cut four crops of alfalfa from his tract, each making more than a ton to the acre.

He has twelve wells 52 feet deep and the water stands within twelve feet of the surface. They are large wells and cost about \$2 a foot. The pump is driven by a 60 horse power tractor engine. With this plant he is able to cover an acre of land with four inches of water every hour.

H. E. Murdock, Government Engineer at Garden City, Kansas, who is conducting investigations into irrigation by pumping from the underflow of the Arkansas valley, says great progress is being made from Hutchinson to Coolidge.

"There is a great development of irrigation in the Arkansas valley in Finney and Kearny counties," said Mr. Murdock. "The sugar company is irrigating about 3,000 acres. Besides this there are 55 individual pumping plants operating supplying water to 6,000 acres more.

"In the bottom land the depth to water is from 10 to 20 feet, but wells in the upland go down 300 to 400 feet. Cheap fuel makes it possible to pump from these deep wells profitably.

"Take an average lift of 125 feet," said Mr. Murdock, "and the cost of the plant per acre served is \$39. The average cost of the plants in the shallow wells is \$20 per acre.

"The cost of irrigation itself, including the pumping cost ranges from \$6.25 on the bottom lands to \$11.50 per acre on the uplands in the Garden City country."

The Bowling Green, Kentucky, *Times-Journal* tells about irrigation in Warren county during the drouth season. Dr. E. D. Rose, of that county, began experimenting two years ago with irrigation of the crops on his farm. It was purely an experimental venture with him and he was also placed at a disadvantage by reason of the fact that he was practically ignorant as to what was really required in his new undertaking. He uses a six horse power gasoline engine for pumping water from a creek which runs alongside his land, and wooden sluices are used for distributing the water. He now has twelve acres well irrigated, and on these twelve acres he is certain of a fine crop of anything adapted to the soil. Drouths do not cause crop failure. The greatest expense was in preparing the land for the distribution of water, after which the cost of irrigation and maintenance is but little more than the cost of gasoline to operate the engine.

At a mass meeting of the farmers held at Harlington, Texas, recently, sufficient money was subscribed to defray all the expenses of forming an irrigation district under the new Texas law. It is the intention of the farmers to take over the holdings and plant of the Harlingen Land and Water Company. Considerable work has already been done in its formation.

Mission Canal Company, Mission, Tex., is having plans prepared to extend and improve irrigation system

at cost of \$150,000; will make available for cultivation 6,000 additional acres.

Owing to the water level being so near the surface, in San Joaquin county, California, it has been found very cheap to raise the water and use it for irrigation by means of electrically operated pumps.

As a result of this more than 300 pumping plants driven by electric motors have been installed in the adjacent territory.

The Reclamation Service is asking for proposals for earthwork and structures, Vandalia, South Canal, Milk River irrigation project, Montana. The work involves the excavation of about 480,000 cubic yards of material, 2,600 cubic yards of reinforced concrete, the placing of 250,000 pounds of steel reinforcement, the placing in wooden structures of about 130,000 feet board measure of lumber. The work is situated on the south side of Milk River adjacent to the main line of the Great Northern Railway in the vicinity of Vandalia, Tampico, and Glasgow. The bids will be opened on November 12th, in Malta, Montana.

The Secretary of the Interior has authorized the Reclamation Service to construct Tunnel No. 3 on the highline canal of the Grand Valley Irrigation Project, Colorado. Tunnel No. 1 is practically completed and the force and equipment will be transferred to Tunnel No. 3. This tunnel will be 7,280 feet in length, 11 feet, 6 inches wide, and 11 feet high. An allotment of \$445,000 has been made for the work.

From recent investigations in connection with the Minidoka irrigation project in Idaho it has been ascertained that certain lands that were temporarily withdrawn from all forms of disposition no longer appear necessary to the interests of the project. The Secretary of the Interior, therefore, has restored about 29,300 acres to the public domain to be subject to settlement and entry at such time as may be fixed by the Commissioner of the General Land Office. The lands lie between 43 and 47 N., ranges 113 and 117 W., sixth principal meridian, Wyoming. The lands were withdrawn in connection with storage works on the headwaters of the Snake river in Wyoming, and involve no power possibilities.

The Klamath Basin in Oregon is rapidly coming into its own. No better criterion of growth and progress is needed than the monthly statement of the railroad shipments for October. During that month, with the harvest only partly gathered, the outgoing freight was as follows:

Cattle, 97; sheep, 46; and horses, 3 carloads; wheat, 33; barley, 23; oats, 4; potatoes, 18, and mixed products, 2 cars, a total of 226 cars. Prevailing prices were as follows: Wheat, \$1.25 per cwt.; oats, \$1.10 per cwt.; barley, \$1 per cwt.; hay in stack, \$8 to \$10 per ton; potatoes, 80 cents per cwt.; cattle, 5½ and 6 cents, and hogs 7 cents per pound live weight.

The Klamath Falls creamery produced 14,000 pounds of butter during the month, which was marketed at 35 cents per pound. Klamath Falls is preparing to take care of all pork products through its local packing house, and this industry promises to prove very profitable, owing to the extremely favorable climate and freedom from disease.

The stock raiser will find conditions to his liking in this region with its abundance of water and forage crops.

Jackson lake dam, built on the headwaters of Snake river in Wyoming, will store 400,000 acre feet of water primarily for use on the Minidoka irrigation project in southern Idaho, assuring an ample supply at all times. By an arrangement with the Carey Act project at Twin Falls, water stored in this reservoir is now also used to supplement the original supply of that project.

Send \$1.00 for 1 year's subscription to the IRRIGATION AGE and bound copy of THE PRIMER OF IRRIGATION. If you desire a copy of The Primer of Hydraulics add \$2.50 to above price.

Use KEROSENE Engine Free!

Amazing "DETROIT" Kerosene Engine shipped on 15 days' FREE Trial, proves kerosene cheapest, safest, most powerful fuel. If satisfied, pay lowest price ever given on reliable farm engine; if not, pay nothing. No waste, no evaporation, no explosion from coal oil.

Gasoline Going Up!

Gasoline is 9c to 15c higher than coal oil. Still going up. Two pints of coal oil do work of three pints gasoline.

Amazing "DETROIT"

—only engine running on coal oil successfully, uses alcohol, gasoline and benzine, too. Starts without cranking. Only three moving parts—no cams—no sprockets—no gears—no valves—the simplest in simplicity, power and strength. Mounted on skids. All sizes, 2 to 20 h. p., in stock ready to ship. Engine tested before crating. Comes all ready to run. Pumps, saws, threshes, chorns, separates milk, grinds feed, shells corn, runs home electric lighting plant. Prices (stripped), \$29.50 up. Sent any place on 15 days' Free Trial. Don't buy an engine till you investigate the money-saving, power-saving "DETROIT." Thousands in use. Costs only postal to find out. If you are first in your neighborhood to write, you get Special Extra-Low Introductory price. Write! (1918) Detroit Engine Works, 301 Bellevue Ave., Detroit, Mich.



FOR THE "LAND'S SAKE"

BUY A

BOSTROM IMPROVED



SHIPPING WEIGHT 15 LBS.

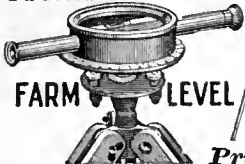

FARM LEVEL

Price \$15

which has TELESCOPE enabling you to read the Target over 400 yards away, and

TERRACE, DITCH, TILE DRAIN, IRRIGATE

your land properly, and save surveyor's fees. It is sold by up-to-date hardware and general merchants everywhere, and guaranteed to be the most

SIMPLE, ACCURATE, DURABLE AND COMPLETE

outfit ever made for all farm work. If your dealer hasn't one in stock, he will order for you from a nearby hardware jobber.

Write today for description of Level, and details of our MONEY BACK GUARANTEE.

BOSTROM-BRADY MANUFACTURING CO.

119 Madison Ave., Atlanta, Ga.

SEND \$1.00 FOR THE IRRIGATION AGE ONE YEAR AND THE PRIMER OF IRRIGATION, PAPER BOUND.

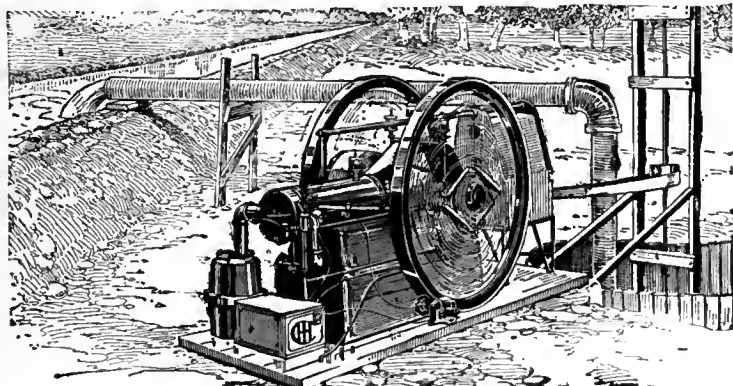

Don't Dread Droughts

WHEN you arrange to get rid of drought and to turn water on your thirsty soil whenever it needs it, the most important thing is that you get, for your power, an absolutely reliable and efficient engine. When the dry time comes you must have water. Make the very safest selection and buy an

I H C Oil and Gas Engine

An I H C outfit is the most reliable, and the most economical you can buy. It delivers the most power on the least fuel. Always ready to go when needed, it costs nothing when not in use.

Besides, an I H C engine can be used for all sorts of work about the yard and barns. In running a saw, cream separator, feed grinder, hay press, and many other machines, it will easily pay for itself. I H C engines are made in every style—air and water cooled; horizontal and vertical; stationary, portable and skidded; to operate on gas, gasoline, kerosene, naphtha, distillate or alcohol. Size 1 to 50-horse power. Tractors range from 6-12 to 30-60-horse power, for plowing, sawing, hauling, etc.

You will find your right I H C engine at the dealer's. Get catalogues from the dealer or write to the nearest branch house.

WESTERN BRANCH HOUSES: Denver, Col.; Helena, Mont.; Portland, Ore.; Spokane, Wash.; Salt Lake City, Utah; San Francisco, Cal.

International Harvester Company of America

(Incorporated)

Chicago

U S A



Kerosene! Gasoline! Distillate!



Any Size You Want

The Genuine

Chilled Cylinder Engine

The Engine Sensation of 1913

The engine that, during the past few months, has revolutionized the engine industry. Pronounced by experts to be a marvel of reliability, simplicity and economy. Positively the only engine with the famous **Chilled Cylinder**, the strongest and most durable cylinder ever made. The best for farm, shop, and construction work. **The ideal engine for the irrigation farmer.** Combined with this cylinder is the **multiple compression**, secured by use of four piston rings instead of three, and the patented **Never-Falling Lubricating Device.** **These remarkable engines are fully guaranteed for five years.** Every engine undergoes the severest tests before it is shipped. It gives full power and more.

Kerosene Attachment Now Ready!

Wonderful new device for using kerosene and distillate. Cuts your fuel bill in half. Runs your engine on common, ordinary kerosene such as you can get in any store, or distillate. More powerful than gasoline. A tremendous advance. Send coupon today for description of this great cheap fuel attachment.

\$15.50 And You Keep This Great Engine

An offer absolutely unparalleled in the engine industry. The superiority of the Chilled Cylinder Engine enables us to make it to you. Only \$15.50 as a first payment—then the rest in **Easy Monthly Installments.** You get the factory price. No go-between profits to pay. You deal direct with the manufacturer, not with an agent whose only idea is to sell you an engine.

30 Days Free Trial

We want to send you this great engine for a free trial of 30 days. We want to prove to you that it is the peer of all engines. We want you to be thoroughly convinced. If you are not satisfied with its performance send it back at our expense.

Free Book "How to Use Power"

A valuable book on engines which contains information which every up-to-date farmer and shop owner should have. It comes to you absolutely free and prepaid. It is written so that anyone can understand it. This edition is limited.

Send Free Coupon Book

or write today to Ben Schmidt, president of the Schmidt Bros. Engine Works. Just send this coupon today and the Free Book will reach you by return mail.

Schmidt Bros. Co. Engine Wks. Dpt. 3706 Davenport, Ia.

Name

Address

Don't Dread Drought!

Why depend upon the uncertainties of nature?

The prospect of rainfall is a gamble.

Your crops need water—a certain quantity of it. *BUT MORE*, they need it at certain particular periods; if they do not get it, *YOU LOSE!*



Take Out *Insurance* on Your Rainfall! "THE DEANE OF HOLYOKE" *Irrigation Pumping Equipment*

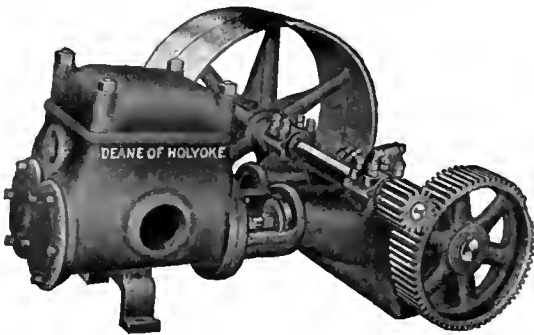

Will give you one less thing about which to worry—an unfailing water supply makes crops more sure.

Bulletin *D230-89* tells more about it.

Write us for a Copy.

The Deane Steam Pump Company

115 Broadway, New York

::

::

Works:—Holyoke, Mass.

Branch Offices in Principal Cities.

D 272-8

CARBO FLEXIBLE STEEL POSTS
 Anchor direct in earth. Flexible line posts. Stiff corners. No concrete and no special tools. **CARBO STEEL POST COMPANY.** **FREE Booklet**
 179 10th Street, Chicago Heights, Ill.



Send \$2.50 for The Irrigation Age 1 year, and the Primer of Irrigation

Fairbanks-Morse Pumping Machinery

For Irrigation or Drainage

600 to 600,000 Gallons per hour.

- Oil Engines
- Electric Motors
- Centrifugal Pumps

Let us figure on pumping equipment to meet your conditions. Send for Catalog 650 P10.

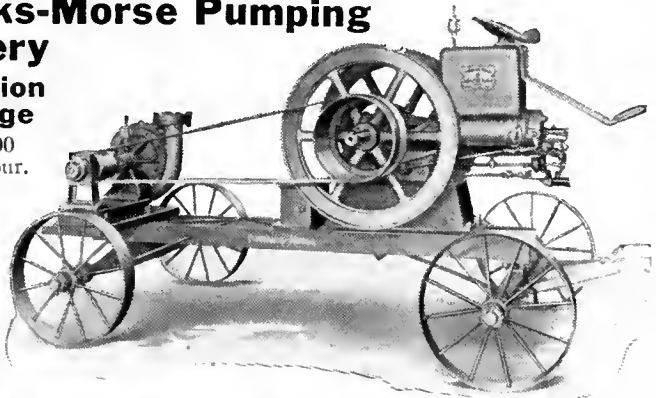

Fairbanks, Morse & Co., 900 S. Wabash Avenue **Chicago, Ill.**

GALVANIZED METAL IRRIGATION FLUME (Newcomb Patent)

Made entirely of rust-proof, galvanized iron. No bolts or rivets used in construction. This flume is considered by experts to be the most serviceable equipment for the purpose on the market. A careful examination of the construction as shown herewith will convince those who are acquainted with irrigation conditions of its lasting quality and the ease with which it may be put together. Complete information, with prices, will be furnished on application to the

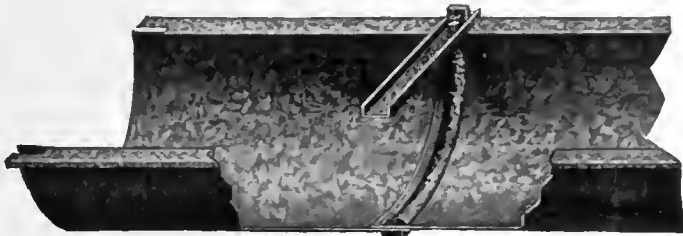

Section of Flume

KLAUER MFG. COMPANY, Dubuque, Iowa



strain that causes it is hard on the wagon. I H C wagons—

The Farm Burden Bearer

YOU and your farm wagon spend a great deal of time together. Of all farm tools it is your standby. Its wheels bear the burden of big loads—towering racks of hay and grain, sacks of produce, loads of sand and gravel, anything that needs moving, over miles of roads to market. It takes solid strength to stand up long under that. When next you ride on a load, listen to the constant racking, creaking, groaning sound of the wagon box, wheels and running gear as the load pitches back and forth over the road ruts. Not an unpleasant sound, but the

Weber Columbus

New Bettendorf Steel King

give the buyer the most he can get for his money because they defy hard usage for the longest time, and are easiest on the horses.

This makes I H C wagon reputation: Selection of the finest grades of lumber, oak, hickory and pine, and of the best quality steel and iron; many months of toughening air-drying for every piece of wood; skilled assembling of parts, fitting of bolts and rivets, and perfect shaping and ironing; application of the purest paint to act as wood preservative and to prevent shrinking and warping of the wood. When the wagon is ready for the farmer, it is practically perfect in every detail and thoroughly up to the I H C standard.

And there are many other reasons we have not room for here why I H C Wagons are the best to buy. Weber and Columbus wagons have wood gears; New Bettendorf and Steel King have steel gears. A visit and a talk at your local dealer's, where the wagons may be seen and studied, will soon convince you as to the wagon you want. Get catalogues from the dealer, or, write the nearest branch house.



WESTERN BRANCH HOUSES: Denver, Col.; Helena, Mont.; Portland, Ore.; Spokane, Wash.; Salt Lake City, Utah; San Francisco, Cal.

International Harvester Company of America

(Incorporated)

CHICAGO

U S A



When writing to advertisers please mention The Irrigation Age.

UNION MACHINES WITH PUG MILLS COMBINED

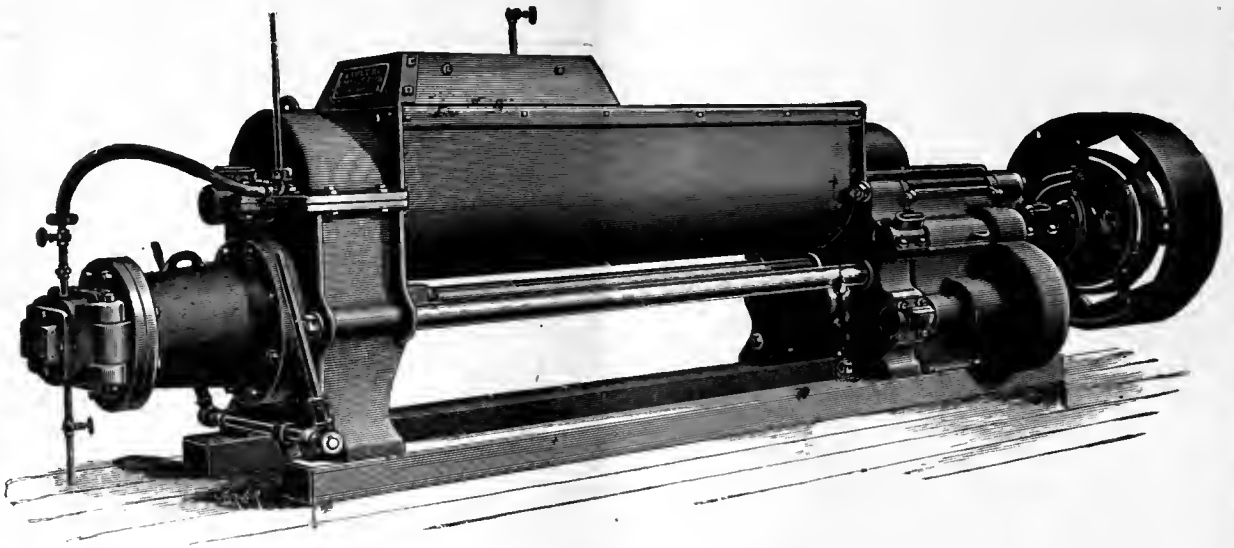

FIVE SIZES ALL CAPACITIES

Outfits for Drain Tile, Hollow Ware, Building
and Paving Brick and other Clay Products

If interested write us for particulars and estimates.

E. M. FREESE & CO.
GALION, OHIO

IRRIGATION FROM WELLS

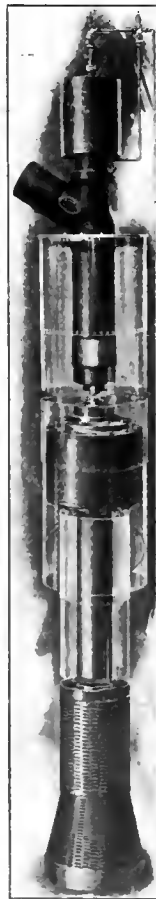

An Arkansas Installation. Layne Patent Screen and Patent Enclosed Line Shaft Centrifugal Pump.

With the twenty-three hundred successful working plants using our system of irrigation, which inoculates and energizes the dormant forces, there is now being produced in previously non-productive districts throughout the United States and in portions of Europe and Asia over eleven million dollars worth of FOOD PRODUCTS ANNUALLY. That our system is not an experiment is forcibly demonstrated by the fact that much of this production is from localities which were arid and barren previous to the introduction of our system.

Write for new catalog.

LAYNE & BOWLER COMPANY

Address nearest office.

The World's Largest Water Development Company

Houston, Texas

Memphis, Tennessee
Welsh, Louisiana

Stuttgart, Arkansas
Plainview, Texas

Jackson, Mississippi



Can You Afford to Support Horses?

THOMAS A. EDISON, the wizard of inventors, says, "The horse is the poorest motor ever built." When you stop to think of it, the horse is about the most costly and wasteful thing at work for a farmer. At best his working time averages only about six hours a day, eighteen hours he rests, yet he eats all year round, working or idle. He eats ten pounds for every hour he works. One acre out of every five plowed goes to feed the horse. The best horse may get sick; when, besides losing his work, you have veterinary bills to pay. When he dies, you have a heavy loss. Since McCormick built his first binder, the tendency of all farming has been away from slow man- and horse-power and toward time- and money-saving machines. Thus far, wherever an

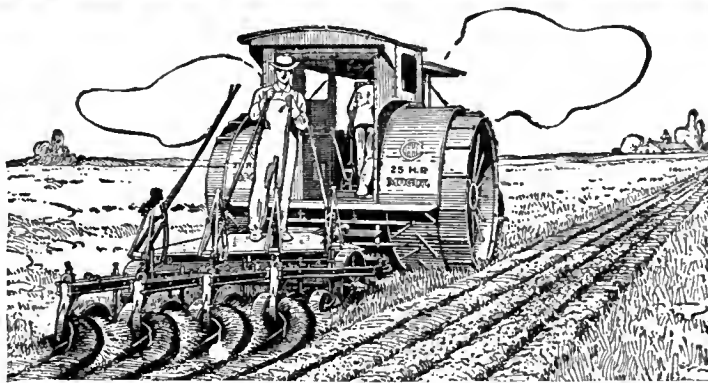

I H C Oil Tractor

has been set to work on a farm, no machine has taken the place of so many horses, or done so much laborious work with so large a saving of time and money. I H C tractors have revolutionized farming. If the owner desires, his tractor will plow nearly as much in a day of twenty-four hours as a team of horses plows in a month. There is efficiency for you!

Whether you use it for pulling field machines,

hauling your produce, threshing, cutting ensilage, baling hay, or anything else, the I H C tractor will stand up to the work. In simplicity and strength of construction, ease of operation, durability, and all-around economy, you cannot find the equal of I H C tractors. They are made in all styles and in 6-12, 7-15, 10-20, 12-25, 15-30, 25-45, and 30-60-horse power. The I H C engine line also includes general purpose engines, ranging from 1 to 50-horse power and operating on various fuels.

It will be to your advantage to get acquainted with the I H C tractor. See the local dealer, and write for facts and information to the nearest branch house.

WESTERN BRANCH HOUSES: Denver, Col.; Helena, Mont.; Portland, Ore.; Spokane, Wash.; Salt Lake City, Utah; San Francisco, Cal.

International Harvester Company of America
(Incorporated)

Chicago

U S A



When writing to advertisers please mention The Irrigation Age.



8 FT. 6 IN LONG
4 FT. 3 IN WIDE
GUARANTEED TO SUPPORT OVER HALF A TON
17 LBS. WEIGHT
4 IN X 5 IN X 2 FT 2 IN LONG

WE SHALL be glad to mail anyone who wishes same, our free catalog. We sell our product through dealers and jobbers entirely and solicit inquiries from all dealers. Our goods are well and favorably known. They are standards in the United States Army and several other departments of the government.

Gold Medal Camp Furniture Mfg. Co.
Racine, Wis., U. S. A.



SUPERIOR
THE NAME TELLS A TRUE STORY

No matter where you live or what your seeding conditions are, you can get a **SUPERIOR GRAIN DRILL** that will fill the bill and do your work in the best possible manner. Superior Drills are made in all sizes and every style. Every Superior Drill is sold under a warranty that absolutely protects the buyer. Send for catalogue. Read it and go to your local dealer and insist on seeing the Superior Drill.

AMERICAN SEEDING MACHINE CO., (Inc.)
Springfield, Ohio

GRAIN DRILLS

PAYS FOR ITSELF IN ONE MONTH

and Keeps on Saving You Money at the Same Rate Thereafter.

THE RECLAMATION DITCHER

Cuts Canals and Laterals for less than any other machinery—because it plows the dirt out with *One Continuous Sweeping Motion*.

We guarantee the cost per yard and prove it before you buy.

The J. D. Adams Mfg. Co.
Indianapolis, Ind.



Delays Pay No Dividends. Mail This Coupon Today.

The J. D. Adams Mfg. Co., Indianapolis, Ind.

Below are descriptions of our proposed ditches. What will it cost per cubic yard to make them with the Reclamation Ditcher?

Length	Width in Bottom	Average Depth	Maximum Depth	Minimum Depth	Slope of Sides	Character of Soil

Name _____ Address _____



Sluiced Earth Dams and Other Earth Emplacements

The undersigned beg to announce an Agreement of Association under which the moving of earth by sluicing will be jointly undertaken in any part of the United States and Canada. This will cover not only

HYDRAULIC FILLS FOR DAMS AND EMBANKMENTS,

but the cutting down of hills, filling of bad ground, tidal flats, etc., and all the applications of moving earth by the hydraulic process.

The established reputation of the Ambursen organization as Engineers, and the importance and magnitude of the work with which the Lewis organization has been connected—as for example, the regrading of Seattle, Washington, the Westover Terraces in Portland, Oregon, and others scarcely less important—assures to our clients the last word in engineering responsibility and practical experience.

Address at convenience.

Ambursen Hydraulic Construction Co.

88 Pearl St., Boston, Mass.
822 New Birks Bldg., Montreal, P. Q.
Colorado Bldg., Denver, Colo.

LEWIS, WILEY & MORSE, Inc., Seattle, Wash.

SAMSON TURBINE



When the PUMP cannot be direct connected to the turbine shaft, the power is usually transmitted by gears, shafting, etc. On account of the HIGH SPEED of the SAMSON, for a given power, lighter and consequently CHEAPER transmission machinery can be used.

JAMES LEFFEL & CO.

Springfield, Ohio, U. S. A.

316 Lagonda Street

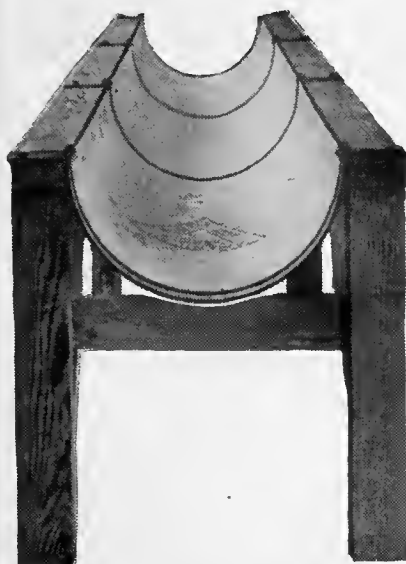

—THE— Lennon Metal Flume

(Patented)

MADE FROM

American Ingot Iron

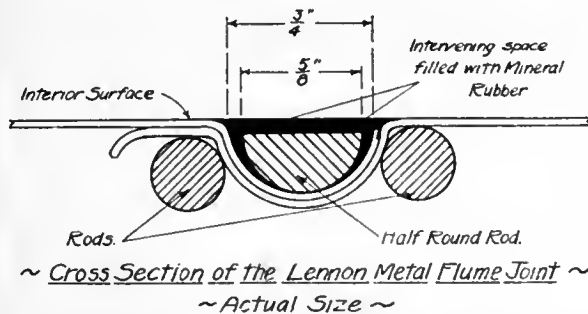

Is the Easiest and Quickest to Erect ¶ Perfectly Water-Tight and Efficient, and, by reason of the Unequaled Purity of its material, of the Longest Service Life. ¶ The illustrations give an idea of the perfect simplicity and effectiveness of the construction. ¶ No Cross Bars are necessary on the small and medium sizes, and but few on the larger.

Write for Full Information to

THE LENNON FLUME COMPANY

California—Los Angeles and West Berkeley
California Corrugated Culvert Co.

Colorado—Colorado Springs
Lennon Flume Company

Nebraska—Wahoo
Nebraska Culvert & Mfg. Co.

Oregon—Portland
Coast Culvert & Flume Co.

Montana—Missoula
Montana Culvert Co.

Texas—El Paso
Western Metal Mfg. Co.

Houston
Lone Star Culvert Co.

South Dakota—Sioux Falls
Sioux Falls Metal Culvert Co.

Utah—Woods Cross
Utah Culvert Co.

Washington—Spokane
Spokane Corrugated Culvert & Tank Co.

This Book Shows How to Plan a Private Irrigation Pumping Plant

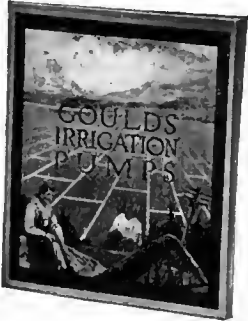

It also shows all of the various types of pumps to meet the conditions found in different localities, tells how to select the proper pump for your conditions, how to determine the amount of power you

will need and all the other things the irrigator needs to know.

One will be sent free on request as long as they last. Write today

THE GOULDS MFG. CO.
LARGEST MFR. OF PUMPS FOR EVERY SERVICE

174 Fall Street, Seneca Falls, N. Y.
Branches in All Principal Cities

IRRIGATION DITCHES

Cheaply and Properly Made with a

Rural Road Grader and Ditcher



Cutting V-Bottom ditch on Slope of $1\frac{1}{2}$ to 1.

The successful irrigation ditch or lateral must be cut clean, with slopes smooth and undisturbed. This machine was especially designed to meet these requirements. One horse and wheel traveling in point of ditch, the other outside the bank of earth. Operated by one or two men and two or four horses.

If you have an irrigation problem to solve, do not fail to write for full information concerning this Combined Grader and Irrigation Ditcher.

Address

C. D. EDWARDS, Albert Lea, Minn.

"BALL (Red) BAND"

The Only Way to Save Money on Rubber Footwear is to Buy the Best in the First Place

To find out what boots are the best, figure the number of days' wear you get out of a pair. Don't judge by price till you find out how much wear and service that price stands for.

Eight million men who wear rubber footwear buy

"Ball - Band" because it gives them more days' wear for dollars invested than they can get from any other make.

Look for the Red Ball on the knee of "Ball-Band" Boots. If the Red Ball is not there you are not getting "Ball-Band" Quality. 45,000 dealers sell "Ball-Band" Rubber Footwear.

Write for Free Illustrated Book about "Ball-Band" Rubber Footwear

Mishawaka Woolen Mfg. Company
346 Water St., Mishawaka, Indiana

"The House That Pays Millions for Quality"

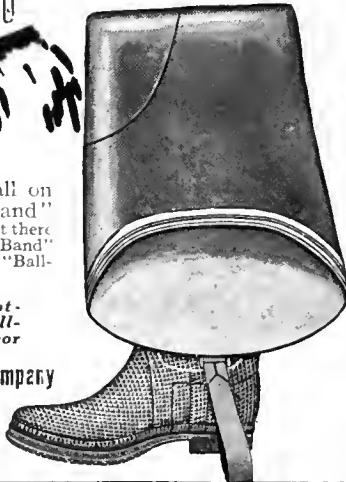

Blackmar Rotary Pump

(Interior View)

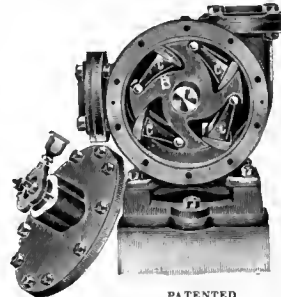

PATENTED

Large Capacity with Minimum of Power

One customer writes he pumped 21,000 gallons with a fuel consumption of 1 gallon of gasoline.

Runs quiet; is high in efficiency and durability. Wear automatically taken up. Few parts, no springs, no adjustments. Requires little or no attention.

One customer has 500 in use.

Capacity, 5 to 500 gallons per min.

Tell us about your pumping problems.

Blackmar Pump Power & Manufacturing Co.

PETOSKEY, MICH., U. S. A.

Twenty-Ninth Year

THE IRRIGATION AGE

VOL. XXIX

CHICAGO, JANUARY, 1914.

No. 3

THE IRRIGATION AGE

With which is Merged

The National Land and Irrigation Journal

MODERN IRRIGATION
THE IRRIGATION ERA
ARID AMERICA

THE DRAINAGE JOURNAL
MID-WEST
THE FARM HERALD
THE IRRIGATOR

D. H. ANDERSON
PUBLISHER,

30 No. Dearborn Street, CHICAGO
Old No. 112 Dearborn St.

Entered as second-class matter October 3, 1897, at the Postoffice at Chicago, Ill., under Act of March 3, 1879.

D. H. ANDERSON, Editor

ANNOUNCEMENT.

The "Primer of Hydraulics" is now ready; Price \$2.50. If ordered in connection with subscription \$2.00.

SUBSCRIPTION PRICE

To United States Subscribers, Postage Paid, \$1.00
To Canada and Mexico, 1.50
All Other Foreign Countries, 1.50
In forwarding remittances please do not send checks on local banks. Send either postoffice or express money order or Chicago or New York draft.

Official organ Federation of Tree Growing Clubs of America. D. H. Anderson, Secretary.

Official organ of the American Irrigation Federation. Office of the Secretary, 212 Boyce Building, Chicago.

Interesting to Advertisers.

It may interest advertisers to know that The Irrigation Age is the only publication in the world having an actual paid in advance circulation among individual irrigators and large irrigation corporations. It is read regularly by all interested in this subject and has readers in all parts of the world. The Irrigation Age is 28 years old and is the pioneer publication of its class in the world.

Beneficial Use Of Water

We are presenting below a copy of the resolution adopted at the Salt Lake Conference of Reclamation Engineers and members of the new Reclamation Commission, who met to discuss topics of general interest

to irrigators and others who are interested in the best means to bring about a clearer understanding of questions which daily confront the irrigator.

The laws of most of the Western states make beneficial use the "basis, the measure and the limit" of water rights, but do not define beneficial use, and this resolution is an effort on the part of the Reclamation Service to define it.

This meeting was held in Salt Lake City, November 12-15, and those present were the project managers of the U. S. Reclamation Service and representatives of the Department of Agriculture, who attended the meeting on the invitation of the director of the reclamation service. Mr. Newell presided, and Mr. I. D. O'Donnell, the new member of the Reclamation Commission, was present, and talked on numerous occasions, on the relations between the service and the settlers and on credit for the settlers. The meetings were entirely informal, and the subjects discussed were all of the questions which came in the management of irrigation proj-

ects, such as systems of distribution, continuous flow or rotation, measurement of water to consumers, qualifications of ditch-riders, collection of crop statistics, experimental and demonstration farms, agricultural advisers for settlers, collection of charges for water, extension of time payments, etc.

It is understood that Mr. Newell will send out an official report of the conference, and it is our intention to reproduce this in a future issue of THE IRRIGATION AGE, for the benefit of our readers.

Following is a copy of the resolution passed:

BENEFICIAL USE OF WATER—A water user with a vested right limited to beneficial use is entitled to that amount of water that will render him a reasonable maximum amount of good with a reasonably economic handling of the water. Since he has acquired his vested right from the laws of his state, he is entitled to protection of that right by the state; but it is his duty to the state, and the state has the right to demand of him that he use every reasonable method to reduce the amount of water required to a minimum. This demand requires the water user to make reasonable preparation of the ground surface for irrigation; to use good judgment in selecting appropriate methods of applying the water to the ground; to prepare reasonably efficient dikes, ditches and structures to get the water over the land in such a way as to reduce the underground losses to a minimum, to irrigate the ground with such a head and at such intervals as to require a minimum use of water for proper irrigation; to cultivate the irrigated ground when practicable to prevent undue losses from evaporation; in some cases possibly to govern the character of crops to be grown. It is evident that the reasonable degree of perfection of each

of these requirements will vary with the locality and with different and changing conditions in each locality, so that the beneficial use of water is variable.

ECONOMICAL USE OF WATER—Since the water supply available for irrigation in the western states is adequate for only a relatively small percentage of the entire irrigable acreage, the fundamental standard of economical use must be the financial results accomplished per acre-foot of water applied rather than the yield per acre irrigated. It, therefore, becomes both necessary and desirable to impress irrigators with the fact that in general the largest net profits per acre-foot of water applied are obtained, not from using excessive quantities, but from more careful use of relatively small quantities. In developing a more economical standard for the use of water, it should not be presumed that established rights can be limited to less water than they would carry under the accepted rule of beneficial use; yet by constantly bearing in mind that the ideal ultimately necessary must be the highest net profit per unit of water applied, irrigators may gradually be induced in many instances to obtain for themselves those results, and those undertaking the construction of new projects may be induced to so design their systems as to provide a liberal water supply during the development period with a view to ultimate development based on economic use.

In the history of irrigation in this country, there has been evident a gradual but very definite evolution in the ideas of what constitutes proper use of water. While the use of water for irrigation was at first a relatively unimportant one, its importance now overshadows all other uses, save that of domestic supply. In the course of this evolution, the doctrine of beneficial use has become established, but in future development this doctrine must in many cases merge into, or be supplemented by that of economic use. The doctrine of beneficial use looks to individual interest; that of economic use to the general welfare of society as a whole. So far as possible, water charges, systems of distribution, and regulations should be so adjusted as to make the interest of the individual water user coincide with this public interest.

Practical Suggestions To Irrigators

Professor F. K. Knorr, in charge of the demonstration farm on the North Platte project in Nebraska, is furnishing helpful hints to irrigators which will prove valuable to farmers on any project. He states that it is a common fallacy among farmers that grains should well shade the ground before the first irrigation is attempted, in order to prevent baking of the soil. His experience and experiments have shown that whenever the soil shows that it is getting dry, the crop should be irrigated, regardless of its stage of growth. When soil will not adhere in a lump when pressed in the hand, irrigation should be applied.

Professor Knorr says further, that barley should never be allowed to get dry, as it is a crop which shows the effect of drouth more quickly and has less power to recover, than any of the small grains; it should, therefore, be carefully watched for indications of lack of moisture. A few men like Professor Knorr scattered over the various Federal and Carey Act projects, would do much toward leading farmers in the right direction, and their suggestions would eventually prove of incalculable benefit to the West at large.

Graves' Article On Forestry

Owing to the crowded condition of our reading columns in the December number, it was found necessary to omit the article on Federal Forestry by Henry S. Graves, forester in charge of the federal forest service. This article is being given space in this issue and should be read by all who are interested in this important subject.

Alfalfa In Southern Saskatchewan

In this issue will be found an article by Dr. Allison Smith of Saskatchewan, on alfalfa culture in that north-west country. Dr. Smith gives many important facts concerning this well known stock food product, how to sow the seed, and other facts that cover the subjects of how to get a good strong growth, points about the nurse crop and inoculation, all of which is instructive and interesting.

Why Not A Creamery?

An Arizona exchange recently contained an article with the heading "Why Not a Creamery?" in which it is stated that the Florence-Casa Grande Valley in that state is placed in the peculiar position of having every condition favorable for a creamery and butter factory, while practically every pound of butter consumed in that district—which amounts to many tons each year—is imported. This necessitates the expenditure of thousands of dollars that could otherwise be kept at home.

This money finds its way to the pockets of outside manufacturers and dairymen of the central states.

Another feature that should be considered by these people is that of freight rates, which brings the price much higher than is paid in states nearer the dairy centers.

In this section of Arizona alfalfa, a wonderfully good dairy food, is raised in abundance, and under the new federal system of irrigation, good water is furnished in abundance; thus these people are ignoring two prime requisites to the successful development of an industry which would not only do away with the necessity of sending money away for dairy products, but if properly developed, would turn the tide of money in their direction, as there is a fine market for this class of goods in the great mining sections of Arizona, New Mexico and California.

This same lesson applies as forcibly to a hundred other sections throughout the irrigated West. Why not a creamery? and thereby bring money into your section, rather than send it away for food products which may be produced at a much less cost, near home.

**The
Question
Of
Monopoly**

The United States Government has shown great activity in its prosecution of so-called trusts, which has no doubt resulted in great good to the people generally, and under the sane, cautious guidance of our high-minded President, we may safely look for legislative action that will be far-reaching and beneficial to all.

The farmers of the country seem to be as free from the baneful influences of money combinations as any class, notwithstanding the cry that various combinations of manufacturers of agricultural implements is an ever growing menace.

There has been no time, in the recollection of the writer, when farmers and ranchmen were more prosperous or happy.

This brings to mind the litigation against the International Harvester Company of America, a large organization which has taken over many concerns in its line. Our observation leads to the belief that so far this centering of interests has been a benefit, rather than a detriment to those who use its products, not to the farmer alone, but to the dealers in implements and accessory lines as well.

If the harvester concern is a trust, it is assuredly a clean one, and very little has been brought out that would indicate that it is burdensome to the people. On the contrary, the general trend of evidence presented against it would indicate that the users and dealers in this class of goods have been treated with the utmost fairness, and in the majority of instances, the dealers have made larger profits and easier progress than under the old system when intense competition apparently compelled the slaughtering of prices and an attendant loss of profits.

The writer speaks on this subject with a fair knowledge of past conditions in the farm implement field, as he has been connected as an employe of, and later as publisher of an implement journal which covered that entire field. In this experience, dating back to the early eighties, it was possible to gain information from the three bends of this triangle, the farmer, the dealer and the manufacturer, hence in justice to the bend of the triangle against which the fight is being forced, it is only fair to state that there is one of the so-called trusts which has been of clearly defined benefit to farmers and dealers alike.

**The
New
Reclamation
Commission**

Affairs in the Interior Department and its subordinate branch, the Reclamation Service, appear to be moving along noiselessly, and so far as the general public is concerned, everything is apparently satisfactory. Since the appointment of a commission to

look after reclamation affairs, by Secretary Lane, we hear very little about Mr. Newell, director of the reclamation service, or his chief lieutenant, C. J. Blanchard, who is listed in the roster as "statistician."

It is difficult to judge, without being on the ground at Washington, the exact status of affairs, nor do we hear much from the outlying country concerning the movements of the new commission.

It is presumed from now on all complaints against the reclamation service will be investigated by the commission, hence the usefulness of our friend Blanchard, as a peacemaker, will diminish.

This brings to mind the fact that the reclamation service would often have been placed in difficult positions, had it not been for Mr. Blanchard. When any severe criticisms appeared in publications throughout the country, Charles Blanchard was usually on the ground to explain away the "seeming difficulty," and as Blanchard was cut out for the diplomatic service, he usually left the impression with the average publisher—who was not familiar with the inner workings of the service—that he (the publisher) had been "bunked" by some over zealous correspondent, and these interviews frequently resulted in making the editor a friend of the service, and precluded the possibility of further investigation of the subject, which in many instances would have placed the affair in an entirely different light.

It is hoped that under the new commission plan, a new era has dawned and that the settler may be given a fair hearing when complaints are registered.

It may be well to suggest here, however, for the benefit of Secretary Lane and members of the new commission, that a large number of western publishers are awake to the real situation, and if the "star chamber" method is adopted in connection with their work, they may keep a keen lookout for rocks ahead.

**Industrial
And
Financial
Outlook**

The year 1914 opens with the industrial and financial condition of the country not quite so buoyant as it was a year ago, yet far from being discouraging to those who look beyond the hour's perplexity. Indeed, when we consider that within the past six months there has been enacted by congress a new tariff law and a new currency law, both of which have compelled a country-wide adjustment of business to their requirements, the wonder is that so little real disturbance has resulted.

It is one of the most cheering aspects of the business conditions of the entire country that they

have weathered these revolutionary changes without a trace of panicky feeling. The effort in congress and out of it to create the impression, for partisan purposes, that the country is on the verge of a panic found no general response from the business interests, and proved futile. There has been a very noticeable slowing down in all the industries throughout the country, and there are more idle men in every state than there were at this time last year. But this would have been the case if neither of the important measures referred to had been passed, or if there had been no change of administration at Washington.

The fact is that we are entering upon a period of adjustment which prudent men two or three years ago foresaw must come inevitably before long. The high cost of living is but a phase or symptom of social and economic conditions that the rather extravagant pace at which the people have traveled for ten years has produced. An adjusting time was due. It had to come. It has come, and the country is meeting it sanely and calmly.

We shall all be the better for the adjustment, and though the process may chafe us a little we may cheer ourselves the while with the thought that we are ministering to the world's betterment. The world is growing better. Business is conducted upon a sounder basis than ever before. Men and women place a higher value upon life, and are seeking more and more to cultivate those finer human relations which alone make life worth the living. And so we may start the year with abundance of good cheer, and with increased faith and courage.

**Bohm
On
Irrigation
Situation**

Mr. Edward Bohm, a student of conditions surrounding irrigation development in the United States, presents his views in this issue, under the heading, "The Truth About the Irrigation Situation." In this article

Mr. Bohm offers pointed suggestions and asks questions which show him to be generally familiar with his subject.

As stated in previous issues, THE IRRIGATION AGE has much confidence in the opinions of this gentleman, and while the publisher agrees with his various attitudes on important questions, he is inclined to the belief that Mr. Bohm may now and then become over pessimistic, or in other words, attempt to convince his readers that irrigation affairs generally are going to the everlasting "bow-wows."

The latter position is surely not true, as our various sources of information lead us to the opinion that this industry is in much better condition than ever before: this is particularly true con-

cerning work of this character in such states as Kansas, Utah, Montana, Oregon and Washington. California has also made rapid strides in opening up new projects, each one having the appearance of a well planned and strongly financed organization.

It is safe to say that the drouth in Kansas in 1913, while disastrous to many, will result in wonderful development in the form of irrigation from wells which will tap the underflow; there will no doubt be a marked increase in acreage under cultivation by this system during 1914, and this will continue so long as the great underground stream—which, while slow, is distinct in its flow—may be profitably lifted to the surface.

If the movement started in Kansas is carried on, it will result in the reclamation of thousands of acres for which water could not have been obtained through any other means, and it will, moreover, do much to increase crops—perhaps double them—in territory where small crops have been the rule, where farmers have heretofore depended on the clouds for their supply.

Taken all in all, it is the impression of the writer that irrigation is again becoming a live subject, and the most gratifying feature of this new movement is the absence of wildcat schemes, and the tendency of capital to recenter the field.

So far as our information goes no well founded project is begging for money for its completion, as was the case a few years ago.

**Illinois'
New
Rate
Commission**

The new Public Utilities Commission of Illinois entered upon its duties January 1st, this year. This commission, which has a different name, is very similar in its purpose and similar in the character of the duties which the law imposes upon it, to the Wisconsin Railroad Commission. The latter was created in 1905, specifically as a railroad rate commission, but two years later its jurisdiction was enlarged to cover all forms of public utilities operating in the state, whether privately or municipally owned. This body now has under regulation nearly 1,200 corporations serving the public in one capacity or another. As the new Illinois law covers nearly the same field as the Wisconsin law, and the effect of its administration by the new commission will doubtless be similar, it will interest the readers of THE IRRIGATION AGE to learn something about what the Wisconsin law has done and is doing

As already stated, the Wisconsin commission has direct supervision over about 1,200 corporations, including telephone, telegraph, gas, electric light, water supply, heat, power, street and inter-

urban railway and railroad companies. Since it began its work it has considered and disposed of over 7,000 cases of complaints as to service, rates, etc. Thirty of its orders or rulings have been taken into the courts, but the commission has not once been reversed. It has reduced freight rates within the state to the amount of \$1,200,000 a year; passenger rates about \$800,000 a year; rates of water supply, gas and electric light companies over \$550,000 a year; telephones, street railways and interurban rates, several hundred thousand dollars more—making a total annual saving to the people of the state of nearly \$3,000,000. Besides this it has standardized service, so that in all lines the utilities companies are compelled in every city in the state to furnish a just standard of service. In the nearly nine years of its existence this commission has cost the state a total of about \$700,000, or an average of less than \$80,000 a year, so that the annual saving to the people of the state (to say nothing of the doing away with unjust discrimination and other unfair practices) is nearly forty times more than the commission with its big force of expert engineers, statisticians and accountants costs the state annually.

The Wisconsin commission does not now have to wait for complaints against utilities before it undertakes to regulate them. For example, it recently issued an order reducing the rates charged for electricity in the capital city of the state, about 20 per cent. It made the investigation on its own initiative and found that at the rates charged the company was making an unreasonable profit (something over 12 per cent on its investment), and so ordered the reduction. It cuts off about \$40,000 a year from the revenues of the company and saves the consumers of the capital city the same amount. The week in which the commission ordered the reduction in Madison, it gave permission to a gas company in one city in the northeastern part of the state, and an electric light company in a city in the southern part of the state to increase their rates. In both of the latter cases the companies were not getting enough to pay interest on their bonds.

The Wisconsin commission also has control of the capitalization of public utilities, and by this means prevents the exploiting of the public through padded capitalization. When it undertakes to make or change a rate, or increase the scope, or improve the standard of service, the first thing done is to make a scientific valuation of the particular utility. Its engineers, accountants and statisticians go to work upon it, and each department submits to the commission its findings. No matter whether the utility is capitalized for twice its actual value, the rates are determined upon the actual value of the

capital actually used or useful in furnishing the service. Thus the gas company spoken of above as having been given permission to increase its rates, was capitalized for \$450,000. The commission's experts, after two or three months' careful investigation and valuation of the plant, reported its actual value to be \$196,000. The increased rate permitted by the commission was what would bring a reasonable return upon the \$196,000, not a return upon the \$450,000. This illustrates briefly the method by which the commission protects the public from extortion.

A volume might be written about the work of the Wisconsin commission, but sufficient has been given to show what the people of Illinois may expect from the administration of the new public utilities law by the able and trustworthy men whom Governor Dunne has appointed upon the commission.

"THE MILLS OF THE GODS"

A single man will often have more power in working a reform than is accomplished by an association or a convention, and it is remarkable how such things work out when the ball is set in motion. Four years ago a farmer named E. Sundberg, of Kennedy, Michigan, received by express a casting for a piece of farm machinery. It was worth only \$2.50, but the express charges were \$32. The express company was ugly about it, and Sundberg got very little satisfaction. He started proceedings to have the Interstate Commerce Commission look into the matter of express rates. His lawyer lawyered around for awhile and the case was finally removed from Minneapolis, where it began, to New York. Ordinarily a change across the continent would have discouraged a litigant, but not Sundberg, who by this time was beginning to fight. He went east with his lawyer and saw Franklin K. Lane, then one of the members of the Interstate Commerce Commission, and things began to move when subpoenas were issued for the officials of the Wells Fargo, Adams, United States and other express companies. It was shown on examination, that the robber express companies had a community of interest, the directorates were interlocking, and the rates charged were confiscatory and unreasonable. The inquiry was pursued further by the commission, with the result that Mr. Sundberg's \$2.50 casting cost the three companies \$26,000,000 a year in reduced revenues. The commission has revised the tariffs of the companies and reduced them to the extent that the people will save this much annually. And here, too, is the parcel post. If the express companies had been less grasping for profits and more considerate of their patrons, the parcel post would still be slumbering among the dead archives of congress. As it is, the parcel post is of some benefit on small packages and for short distances and the people will not let it rest until we are getting the full rates such as European countries have had for years.—Ex.

ALFALFA CULTURE IN SOUTHERN SASKATCHEWAN.

Marking an Advance in Agricultural Development and Irrigation.

(Paper by Dr. Allison Smith of the Cypress Hills Water Users' Association, Maple Creek, Saskatchewan, read before the Seventh Western Canada Irrigation Convention at Lethbridge, August 7, 1913.)

Irrigation is a subject which has interested individuals in every nation where food and forage is produced. The Nile Delta might be cited as an irrigation classic, the records of which extend to remotest antiquity. Its fruitful soil saved the lives of the starving Israelites and was for years the granary from which Rome at the height of her power drew her supplies which were distributed free to her people.

Gibbon in his "Decline and Fall of the Roman Empire" mentions the fact that alfalfa was extensively grown on the plains of Greece and when that part of the Empire was overrun by barbarians, the latter brought with them their flocks and herds, and their prolonged stay was made possible by the alfalfa growing in that favored clime.

In order that we may have a prosperous and contented people we must have a generous supply of food. It must be of good quality and cheap enough to be within the reach of everyone in order to bring about the highest development of the race.

Foodstuffs are divided into three classes, proteids, carbo-hydrates and fats. Proteids are foodstuffs which contain from 15 per cent to 18 per cent of nitrogen and they enter largely into the development of the muscular, nerve and glandular tissues of the body as well as being present in force in the blood. Proteids also contain the same elements which enter into the formation of carbo-hydrates and fats but in different chemical combination.

As you are aware, it is impossible for an animal to take into itself substances such as nitrogen and lime salts in their inorganic state and digest and assimilate them. We must then of necessity look for some plant which has in its composition the elements necessary for the production of food that can be easily and cheaply grown and when fed to an animal be readily assimilated and digested. Alfalfa has proved to be such a plant and this plant is of vital importance to every man, woman and child in Canada today.

It has the power through bacteria attached to its roots to take into itself nitrogen from the air and also store it in the soil. But it can do more than that. Under the influence of solar light and heat it has the power to extract from the earth certain lime salts which enter into the formation of bone, so that we have a plant which when fed to an animal furnishes us with a bony framework besides giving us the necessary tissues wherewith to clothe it, and from which we derive our steak, chop, or cutlet, as the case may be. But before we can enjoy that steak we must have grown the alfalfa and feed it, and in order to do that your land must undergo certain preparation.

We assume that your land is of a quality which when sown to grain will, under ordinary circumstances, produce a crop, that it has been surveyed and leveled, and of sufficient slope that when water is applied the water will not lie on it and become stagnant and that any underlying water is not closer than five feet to the surface of the soil.

To get a good stand of alfalfa our method has been to summer-fallow, making sure that all grass and weeds have been disposed of and by frequent harrowing retain all the moisture possible. The following spring, when all danger of frost is over, we drill in one bushel of oats per acre as a nurse crop, inserting it about three inches deep, and on top of that we broadcast our alfalfa seed at the rate of twelve pounds per acre and harrow lightly. If conditions are favorable, the alfalfa should be six inches high; before overtaken by the alfalfa is a heavy clay loam, and a nurse crop does not hurt the alfalfa. The nurse crop, besides furnishing a quantity of green feed, can be cut with a binder, leaving a stiff stubble to act as a barrier to retain any snow that may fall and so prevent winter killing.

We have sown the seed with and without a nurse crop and both methods appeared to be successful until this year, that without a nurse crop winter killing very badly. The seed without a nurse crop was sown at the same time and under the same conditions as that with a nurse crop. We cut the crop when the weeds came strong, using a mower. After cutting twice a dry spell followed, and the growth of alfalfa was retarded. On this piece winter killing was much in evidence, the snow having blown off, leaving the alfalfa exposed to the elements.

The seed used came from four different places, namely: Colorado, Idaho, Nebraska, and some Turkistan seed from the seed house. They all appeared to do equally well.

If you have any foxtail near your alfalfa field get rid of it if possible, for once it gains a foothold it is almost impossible to get rid of, and eventually it will take possession of your field.

The question is often asked, "Is it necessary to inoculate alfalfa?" By all means, if alfalfa has not been grown in your neighborhood send to your department of agriculture for nitro-culture or your experimental farm for earth from an alfalfa field.

Our alfalfa existed for two years without inoculation. Each spring it would make a brave stand for a month or more, and after it has attained a height of six or eight inches it seemed to receive a setback. It lost its fresh, healthy green color and turned sickly and drooped. The following year we sent to Edmonton for nitro-culture and received sufficient for one acre. That nitro-culture worked a miracle. On the part that was treated the plants stood three feet high, strong and robust; the line of demarcation between it and the remainder of the field being as sharply defined as if cut out with a knife. The rest of the field we treated with earth taken from that acre, and the results were equally satisfactory.

By sowing twelve pounds per acre the output

(Continued on page 90)

THE TRUTH ABOUT THE IRRIGATION SITUATION.

Why Irrigation Investments Are at Low Ebb. Real, Instead of Perfunctory, Control, Demanded.

By Edward F. Bohm.

Everyone at all familiar with irrigation practice throughout the seventeen arid-land States is well, and, in many cases, painfully aware of the fact that irrigation "enterprises," so-called, have fallen into general disrepute. Not that the subject of irrigation, per se, is at all discredited—as well attempt to deny the value of rainfall—but that the laxity of the States in the administration of their water resources—with some exceptions—and in the control of the organized and capitalized irrigation enterprises—with *no* exceptions,—has led in the recent past to a veritable orgy of promotions and flotations which, when weighed in the balance, have been found wanting. Events identified with the wholesale disruption of these schemes are of occur-

irrigation administration, throughout the arid land States, the writer must confess that it is difficult to explain the attitude of some of the States, except upon the theory that "the nearer to Rome the further from the Pope." The bare fact of the matter is that the average man from the East and Middle West has heard so much of spurious irrigation ventures—so much of the troubles experienced by the purchaser of "paper water rights"—here with Carey Act Projects, there with irrigation districts, or "private" ventures—that the bottom has fallen out of the whole structure of confidence. It is only necessary to compare conditions of today with those of three or four years ago when the irrigation campaign had assumed the proportions of an acute mania.

Irrigation securities, as is well known, are today so thoroughly discredited that, to use the terms of a leading Chicago banker, "all that is necessary to insure ostracism in Chicago financial circles is to broach the subject of irrigation."

What is the Remedy? *Not more perfervid boosting or exploitation but a sane process of housecleaning.*



An Unusually Fine Section of Flume Work Erected by the Lennon Metal Flume Co., Colorado Springs, Colo.

rence so recent that they require no narrating. As a corollary, confidence upon the part of the investor in irrigation securities has been destroyed and the tide of immigration stemmed to an enormous degree.

The big question deals with problems that are not confined to any one State. The great majority of Western States is feeling the need of more liberal investment of capital—of more rapid influx of settlers.

The situation may well be characterized as acute when the director of the United States Reclamation Service finds it necessary, as has been the case in the past, to call into conference immigration officials of the arid-land States and colonization agents of the trans-continental railroads, to discuss ways and means to further the settlement of irrigated lands—whether under Federal projects or others—and to curb the operations of "wildcat" land and water promoters and dealers.

In view of the activities of "bureaus of immigration," it is pertinent to inquire "What are the States doing to safeguard the interests of the homeseeker after he arrives?" Speaking as one who has devoted a large part of his career, in an official, as well as a private capacity, to an intimate study of

Some of the States are seeing the light—Idaho, which has suffered much from Carey Act maladministration, has recently revised its entire system of Carey Act regulations to conform to modern requirements. Oregon in 1909 adopted a code of water laws based upon the "Wyoming System" and conceded, with its amendments, to be, in its practical results, the last word upon the subject. It has also revised its Carey Act laws with a consequent enormous increase in activity in this direction, and the subject of reclamation by the State, directly, with its own funds, being seriously considered. Wyoming has thrown additional safeguards around the Carey Act entrymen and is agitating for a better administration of irrigation districts.

A former State engineer of Wyoming hit the nail squarely upon the head when he recommended that "development cease unless it could proceed without scandal."

Nevada has adopted a Carey Act Code which goes so far as to provide for States' control of financing of these projects, while the legislature of California, in its last session, placed the control of irrigation districts in the hands of a commission to consist of the State engineer, the attorney general

and the State superintendent of banks, and made the bonds of districts approved by this commission legal investments for State funds. It is true that this measure has not been put into practical execution as yet, but not on account of any inherent defect of the law. These facts are cited as instances of what can and is being accomplished.

In Utah one project has been successfully executed with State funds—the so-called "Reserve Land Grant fund."

In Colorado there are still many who regard the—largely court-made—system of water administration as perfect, and who, in the language of the legislative committee of 1909, advise "hands off." The argument is advanced that "it is dangerous to vest judicial powers in administrative officials or boards."

To such people should be commended a study of the "Wyoming System"—so-called, as shown by its results. The State of Wyoming wisely incorporated its present effective system in its constitution about 20 years ago, with the result that, today, every "water right" in the State is well defined, and that without friction or litigation. Compare the effectiveness of this system as exemplified by the experiences of the Dakotas, Nebraska, Wyoming, Utah, New Mexico and Oregon, with that of Colorado or California.

Whether power be vested in one man or a board, the results are the same. Idaho has attempted an application of a mixture of the Colorado and Wyoming systems and has attempted to cure this defect by remedial legislation to be referred to later. To apply a remedy it is necessary to begin at the seat of the trouble—unrestricted filings. The experience of the States that have adopted the Wyoming doctrine demonstrates amply the superiority of a system permitting the State engineer or a State board of division engineers—under whatever name—to exercise discretionary powers as to the granting of permits to appropriate—with an appeal to the courts as in all other States. Work under this system must be initiated and completed within certain statutory limitations of time—proof of beneficial application, with issuance of certificate of license to follow—also within a prescribed period. This, with compulsory adjudication by the board of all old rights, may within a few years result in a complete record of all "rights" in the State and at once vastly simplify procedure and tend to restore a measure of confidence. The Colorado filing law of 1911 is a tremendous improvement over the old system, which was simply a pawn in the hands of unscrupulous promoters, but it still regards the primal resource of the State—its waters—as being free as air and as concerning the State only as controversies may arise. This theory may have been correct twenty-five years ago, but economic conditions have changed. A "water right"—in Colorado especially—is such an obtruse affair that the engineers can hardly "sense" it. It is a fundamental obligation of the States which are spending thousands to bring people upon their vacant lands, to spend a little time, money and thought, towards protecting these same people from the machinations of unscrupulous land and water promoters after their arrival.

The Colorado Carey Act administration as at present constituted is good because in this instance authority is vested in the State officials, the State engineer and the State land board, but what of her irrigation districts? To find out, go to Eastern financial centers. Colorado is the only State where irrigation districts "cut any figure," in which there is a complete absence of State's control.

Idaho has many such districts. They have been almost uniformly successful and that because there is a complete system of State supervision. The advanced legislation in California has already been referred to. It is not enough to go this far and no further.

All irrigation projects selling water rights should be brought under the supervision of State authorities—to the end that the purchaser of water rights—yes, even of irrigation securities, may know he is buying something possessing tangible value. This recommendation applies to *all* the States.

Idaho in 1909 adopted a law providing that no water right could be sold by any person or corporation, except upon approval of the State land board, based upon examination and approval by the State engineer; providing for a record of all transfers of this character and a stiff penalty for non-observance of the law.

It is true that this law was designed as a palliative for that part of the Colorado System providing for approval by the State engineer of *all* filings—even though obviously spurious—but it is a good law and a step in the right direction.

With reference to initiation and perfecting of so-called "rights," the States that still cling to the antiquated system of "posting and filing of notices" no doubt will in the near future adopt an orderly system of procedure based upon the "Wyoming system."

Of these States Texas, California and Washington have taken steps in the right direction by the appointment of commissions to study the subjects involved and to submit appropriate recommendations. In California some measures may be expected to engage the attention of the next legislature in Texas, likewise, in Montana and Arizona there have been, so far, no active steps in this direction in Washington, the model "code" suggested was rejected by the legislature in 1911; but efforts in this direction will not cease that account.

One thing, further, I wish to recommend to take appeals from the decisions of State officials to the Supreme Court, directly, thus obviating interminable delays.

At Pueblo in 1910 and at Chicago in 1911 at the irrigation congresses, resolutions calling for efficient States' control were unanimously carried.

At Salt Lake City in 1912, the congress adopted a resolution endorsing a procedure whereby the control of all irrigation projects would be placed in the hands of a commission consisting of experts in their lines—to pass upon water supply, engineering, soil conditions and financing and thus to introduce an element of stability, into these ventures. It is easy to see that the leaven is working and in which direction events are trending. Whether these matters be passed upon by the State engineers and State

(Continued on page 88)

FEDERAL FORESTRY.

Address Delivered by Henry S. Graves, Forester in Charge of the Federal Forest Service, at the Fifth National Conservation Congress, Washington, D. C., November 19, 1913.

The part played by the nation in forestry must always be large. Here as in all other countries, the real development of forestry began when the government took up its practice. Even today some persons would leave the forests entirely to private owners; others insist that the public phases of forestry are altogether a state function, and federal



No. 1—Bumper Crops Are Assured by This System for Truck Farms. Reproduced by Courtesy Henry R. Worthington Hydraulic Works, New York.

activities in this field uncalled for. Those who hold this view are usually either lukewarm concerning the need for forest conservation or opposed to restricting private activities.

National responsibility in forestry is perfectly clear-cut. There need be no confusion with an equally clear-cut responsibility of the states. And as to private forestry, little of value has so far been done that has not been an outcome of public action through state or federal agencies, or both. It was the work of the federal government in placing its own forests under administration, its demonstration of fire protection and of conservative lumbering, its experimental and educational work, and its stimulus to our educational institutions to train and turn out a large body of foresters, which created the present wide interest in forestry and brought the efforts of other agencies into successful play. I do not mean in any way to overlook the splendid work of certain individual states like Pennsylvania and New York, which dates back many years. But that was localized in a few states. It required the nation itself to set in motion a national movement. The national work will always be the backbone of American forestry, not trenching on or interfering with state work or individual efforts, but serving as a demonstration of forest management on its

own lands, a center of leadership, cooperation and assistance to state and private work, a means to handle interstate problems and coordinate the work of neighboring states, a guarantee that national needs which individual states can not meet will be provided for on a national scale.

Underlying the forestry problem are two fundamental considerations which should be emphasized and reiterated until thoroughly driven home. One is the public character of forestry. The public has a peculiar interest in the benefits of forestry. Both in the matter of a continued supply of forest products and in that of the conservation of water resources the public welfare is at stake. In

each case purposes vital to the prosperity of the country can be accomplished only with the direct participation of the public. Private owners will secure results only on a limited scale in the long run on their own initiative. It takes too long, 50 to 200 years, to grow a crop of timber trees. Most private owners in face of fire risk, bad tax laws, and uncertain future markets will not make the necessary investments. Most lumbermen have bought their lands either to log or to speculate in the standing timber, not to grow trees for later generations. Nor will private owners make investments for general public benefits, as in water-

shed protection. If the public is to secure the benefits of forestry it must take the measures necessary to guarantee these results, and it must bear the cost



No. 2—Main Check, Redwood Canal, Near Holtville, Imperial County, California. Courtesy Henry R. Worthington Hydraulic Works, New York.

of what it receives.

Closely related to the fact that forestry is in many aspects a public problem is the second of the fundamental considerations I wish to emphasize. Forestry requires stability of administrative policy and such permanence of ownership as will ensure

it. Herein lies the difficulty of private forestry on a large scale. Timber land owners are interested in the protection of their standing timber merely as insurance. Most of them are not interested in forest production, or in protecting cut-over lands if that involves substantial annual charges and is not necessary in order to protect their remaining standing timber. As yet the problem of cut-over private lands is unsolved. It is now devolving on the state to aid in their protection from fire in the interest of its own citizens. It will require the utmost resources of state and federal government together to handle this problem of getting reasonable protection of private forests and permanent production of timber on cut-over lands. Stability of policy and permanence of ownership are essential to any successful attack on this great conservation problem.

This principle of stability of policy of administration is a large factor in successful handling of public property and has been consistently considered in the national forest work. I am frequently asked as I travel about the country whether I am going to make important changes in the forestry policy. I was asked that very often in 1910, when I first took office. I am asked it often this year. My answer is that what we are seeking is not changes but the development of a permanent public enterprise with consistent and stable policies. The national forests were set aside in the recognition that the bulk of these lands should be handled permanently under public protection and control. Provision was made for the acquisition of agricultural lands that might best be developed under private ownership, and such areas are now being classified and segregated from the forests very rapidly. The successful handling of the national forests requires annual expenditures in administration and protection and in development of roads, trails, telephones, buildings, and other improvements necessary for proper administration. We seek, therefore, as fast as possible to develop through classification the permanent boundaries of the forest land, and the management of it according to definite far-sighted plans that will make for the best results of all expenditures in the long run. The result sought is an efficient business administration, a proper and adequate forestry practice, and development of the public property in the interests of the people who own it. These simple principles have been kept in mind since the first organization of the work by Mr. Pinchot, who was more than any other one man responsible for what has been accomplished in forestry in this country.

The national forests have now been under administration fifteen years, and under the Forest Service for eight years. The aim of the present administration is not to overturn, but to take every possible step to increase efficiency of the organization, to adjust difficulties, and advance as fast as possible the purposes for which the national forests were established. Secretary Houston recently said to me regarding the national forests:

"Establish permanent boundaries. Classify your lands; segregate the agricultural land and fix right limits for what is needed as protective and productive forests. Develop permanent policies

based on full recognition of lasting public interests, and settled forestry practice fitted to the individual needs of each forest and locality. Study efficiency; make any changes necessary for this purpose, but make no changes that are not clearly called for in the public interest. Carry out your plans for the development and increasing use of the forests, but above all, make each forest work for community upbuilding and local as well as general welfare. We must always have in mind the men and women who are building up a new country and laying the foundations for prosperous, thriving commonwealths. We must try to study their needs and see where and how the forests can help them. But we must not cease to guard effectively against the evils of private privilege and monopolistic control of resources now the property of the public."

The first important result of national forestry is a demonstration that the forests can be protected from fire. It was only a few years ago that many asserted this to be impossible. In the northwest the smoke season was as inevitable as the rainy season of winter, and this was not merely the result of clearing land, but from forest fires. It is only recently that our own forest officers have regarded lookout stations as feasible in certain places; for lookout stations are useless if smoke hides the view. This year has been the worst in many respects of all years in California because of the frequency of lightning fires. Yet the lookout stations on only two forests, and then only for a short time, were out of commission because of smoke; and the smoke came from fires on private lands. This year in California there were over 1,100 fires on the timbered areas. These were kept down to an average of a little over 20 acres per fire. This was done by an effective fire organization and through the means of the trails, telephones, and lookout system. In one storm lightning set over twenty fires on one forest. It takes swift and efficient work to handle such a situation. The results so far attained show that fires can be mastered. But it is necessary first to put the forest in a condition to enable the force to prevent fires, to detect those which start promptly, and to reach them quickly. The Forest Service is developing a system of lookout stations, fire lines, trails, and telephone lines that ultimately will make the forests secure. Already the force is able to save every year property valued at many million dollars through the improvements so far built, although as yet only a beginning has been made. This work is carried on according to a definite plan, already projected in detail. Each year's work adds 2,500 miles of trails, 3,500 miles of telephones, and many lookouts and other improvements, progressing toward the final scheme. Until that is completed the forests can not be made entirely secure. With that development the forest fires can be handled even in that exceptionally dry year that occasionally comes to every region.

This protection not only saves the trees from destruction or injury, but already the effect is shown in the restocking of many areas where the old fires had prevented reproduction. Personally, I had hardly expected that there would be so quick

(Continued on page 86)

THE FEDERAL WATER USERS

A Department Devoted to the Interests of the Farmers in the Government Irrigation Projects

Edited by Geo. J. Scharschug

Why I Have Created This Department.

Four years ago as a newspaper correspondent and an unbiased observer, I accompanied the Irrigation committee of the United States Senate on a trip of inspection of the Federal Reclamation projects. I had visited most of the projects prior to that time and have been on many of them since, but on that trip I had an opportunity to get in close touch with the real backbone of the projects—the settlers. I was permitted to attend the meetings of the Water Users' association; to hear the actual settlers' side of the government irrigation problem; to hear from his own lips his story of struggle to make desert sands bloom and produce; to learn at first hand of his treatment by and his dealings with the agents of Uncle Sam.

It was then that the idea of this department, devoted to the interests of the water users on the federal projects, for which the editor of THE IRRIGATION AGE has given me space, was born. It was then that I decided that I wanted to have a part in working out the great human problem, which confronts both the government and the settlers in making a success of the great engineering projects, on which the United States has already spent more than \$100,000,000. For unless the 1,000,000 persons, who now live in and are developing these projects, all of them clean, sturdy, honest, hardy men, women and children, born with the blood of pioneers and the desire to create homes from the breast of nature, itself, are not treated fairly, given all that was promised to them by our government and in turn they fulfilled all their obligations to the United States, the great monuments of irrigation engineering will be as naught—and more costly, too, this nation will have lost the confidence of a million of its best citizens.

Two years ago I had opportunity to help the water users of a number of projects organize their national body—the National Federation of Water Users' association. My part in the work was small, but its success has pleased me greatly. The benefits that the national organization have already obtained for the water users are manifold and are but new proof of the old saying: "In union there is strength."

There is much yet to be done. There has been government repudiation of contracts with the settlers, which in all fairness must be righted. There have been mistakes by government engineers, some innocent, some deliberate—yes, almost criminal—for which the homesteaders are now being asked to pay. This is not fair. There are other interests seeking, I think without any just grounds, to get a finger into the government funds, devoted by congressional act to irrigation. This vast fund came from the sale of public lands in the states where it is being used. The outside interests seeking it must be fought. There are other interests, credited by

some with being very high in administration councils, who threaten to overthrow the entire present organization of government reclamation as it concerns the settler. Such moves must be inquired into very carefully and scrutinized minutely before congress is permitted to act upon them favorably.

The most potent remedy is the light of publicity. Publicity will make the government officials respect the rights of the homesteader. Publicity will keep the homesteader from evading in any manner his obligations and his duties to the government. Such publicity cannot be hailed with anything but approval by any patriotic citizen.

To make this department of THE IRRIGATION AGE a success, I must have the co-operation of the water users. I want it. I want the aid of the country editors on the projects. They have been the backbone of the many fights which the settlers have already made and will be in the future. It is unfortunate that their circulation is not national. If it were, there would be no need for such a department as mine. Members of the executive committee of the Federation of Water Users have assured me of their aid. If the water users will also help, this department cannot but succeed and it will accomplish much good.

RECLAMATION REORGANIZATION.

What It Means to the Project Settlers.

Secretary of the Interior Lane's reorganization of the administrative organization of the Reclamation Service bears every indication of success.

Although it was late in December when the secretary issued his order formally creating the Reclamation Commission of five members, settlers on the various projects state they are already beginning to feel the benefits of the reorganization. They believe it will result in more attention in Washington and by the subordinate officers on the various projects to the human problems of developing the projects; in more business-like expenditure of the funds for construction and in greater justice to the claims of the homesteaders and water users.

It is certain that it has pretty thoroughly destroyed the bureaucracy of scientific gentlemen and their hangers-on, who long ruled with a hand of iron the Reclamation Service and the 1,000,000 persons, living on the government projects. And it has done so without destroying the efficiency or usefulness of the engineers, to whom great credit is due for the vast irrigation works they have constructed. These engineers can now continue their constructive work, for which they are fitted. Men better trained in business and human affairs will care for the other features of the reclamation work which the engineers have striven to do in the past,

no doubt to the best of their ability, but of which in many cases they made almost total failure.

Secretary Lane made this reorganization only after a very careful study of the entire situation. He is a western man and knows many of the problems of the pioneer. He gave a very extended hearing to the officers of the National Federation of Water Users' association, to representatives of the various project organizations, to individuals acquainted with irrigation and to the reclamation officials. When he had thoroughly digested all this information, he acted. He divided the Reclamation Service into five divisions, as follows:

Scientific, Statistical and Historical division, in charge of F. H. Newell, as director.

Engineering and Technical division, in charge of Arthur P. Davis, as chief engineer.

Law division, in charge of Will R. King, chief counsel.

Fiscal and Accounts division, in charge of W. A. Ryan, comptroller.

Operation and Maintenance division, in charge of I. D. O'Donnell, supervisor of irrigation.

The engineering and technical features of the service thus remain in the hands of Director Newell and Chief Engineer Davis. This is proper. While these two men have made mistakes and many enemies, they have long been the directing heads of the construction work of the irrigation projects and have done work that will stand for centuries as monuments to their engineering ability. There is still millions of dollars worth of work to be done and their supervision and counsel will be of vast value to the government and to the project settlers.

Although the five division chiefs will act as a board, the real business management of the projects and of new construction work falls on the shoulders of Comptroller Ryan, it is understood in Washington.

Mr. Ryan is the personal appointee and representative of Secretary Lane. He was employed on some big investigations for the Interstate Commerce Commission, when Mr. Lane was a member of that body, and the secretary thinks very highly of him.

Organizing ability and business acumen are declared to be prominent attributes of Mr. Ryan's make-up, and he has already shown something of these in the short time he has been on the Reclamation Commission. He has expressed some rather remarkable ideas about the reorganization of the water users. Some of these ideas will no doubt prove of value; others are so revolutionary that the settlers' interests might be jeopardized, should he succeed in carrying them out.

It is worth a great deal to the settlers to know that he has the full confidence of Secretary Lane and through the secretary, of the administration.

Supervisor O'Donnell comes from Billings, Mont., adjacent to the Huntley project. Secretary Lane is reported to have called him "the ideal man for the place."

The duties of Mr. O'Donnell, if carried out fully as outlined, may make him a man of immense value to the water users. He is the adviser of the Reclamation Commission on all matters concerning irrigated lands. He directs and conducts the manage-

ment of all the irrigation systems on the government projects. He will advise with water users and their associations concerning the best methods of irrigation and cultivation of their lands, the development of their markets and upon other problems affecting the welfare of the settlers and the projects. All project managers and maintenance employes are under Mr. O'Donnell's supervision.

One of the first acts of the new commission was to cause a reiteration by Secretary Lane of his order of June 23, 1913. And this time he spoke in language so plain that every project employe could understand it well enough to let the settlers know about it. Under this order, slightly modified, no action will be taken for the cancellation of entries for non-payment of building or operation and maintenance charges before March 1, 1914.

The Commission has also made a very important concession to the settlers, as the result of a request of the Elephant Butte Water Users' association on the Rio Grande project. This association has been given permission to employ an engineer, empowered to check all plans and specifications and estimates of cost prepared by engineers of the Reclamation Service. Secretary Lane directed the Commission to grant the same right to any other water users' association that may apply for it. This is an important reform and will, no doubt, prevent in the future many extravagances, useless expenditures and foolhardy pieces of engineering, such as have cropped out in the past on practically every project and cost the settlers millions of dollars. Some of these mistakes have been matters of public scandal and efforts are now being made by congressmen and others to work out some way by which the settlers, entirely innocent, can be relieved of paying for them, and yet not violate their solemn obligations to pay back to the government every cent put into the construction of the projects.

The new method of administering the projects will be considerably more expensive, so far as the payroll is concerned, and, of course, the settlers must ultimately pay these bills. All in all, however, the extra cost now looks like money well invested.

CORRECTION.

An explanation is necessary in item which appeared on page 54 of our December number, under the subhead, "Kansas" in Reclamation Notes, about a well near Modoc, Kan., in which it was stated that a Mr. Churchill had invented an irrigation pump that would lift 800 gallons of water per minute and from a depth of 128 feet. It should have read 300 gallons as per the copy prepared, which allows for a more reasonable efficiency. The fault was with the proofreader and not with the one who prepared the copy.

Send \$1.00 for 1 year's subscription to the IRRIGATION AGE and bound copy of THE PRIMER OF IRRIGATION. If you desire a copy of THE PRIMER OF HYDRAULICS add \$2.50 to above price.

SMALL FIREPROOF GARAGES

To keep the automobile safely and in the most efficient order and to preserve its appearance, there should be provided a permanent, fireproof garage. Concrete is the most suitable material for this purpose. A concrete building is warm in winter and cool in summer—very important considerations for the motorist who likes to “tinker” on his machine—and its fireproof qualities are self-evident and of the utmost importance where gasoline is so freely used.

The garage should not be planned of too small dimensions. It is desirable to provide space for a work bench fitted with a good machinist's vise and rack for tools, and allowance made for room to store oil, gasoline, extra tires and other supplies. For a single car a size of 18 feet long by 14 feet wide by 9 feet high (inside measurements) will be ample.

Method of Construction

The foundations should be 12 inches wide by 3 feet deep, and should extend 5 inches above ground level to provide for a concrete floor of this thickness. The concrete for the foundation should be made in the proportion of 1 part Portland cement to $2\frac{1}{2}$ parts sand to 5 parts screened gravel or



crushed rock. Upon the foundations the 6-inch wall will be placed. Make the walls of 1 to 2 to 4 concrete. The walls are reinforced with $\frac{3}{8}$ -inch round steel rods, spaced 14 inches apart, and running both horizontally and vertically. The forms for the walls can be built the full height, or movable forms of a height of about 3 feet can be used. Forms are made of 1-inch siding, well supported by 2x4 lumber to prevent bulging when concrete is placed. The movable forms are filled and raised each day until the entire 9 feet is completed. In order that the car can be easily run in and out of the garage, it is well to leave the entire entrance side open and fitted with large swinging doors. In the sides of the doorway imbed bolts with heads in the concrete. These bolts will be used later for fastening the wooden door jamb which carries the hinges for the doors. Provide a good sized window in each of the three walls so that there will be plenty of light on the car when it is to be repaired or washed.

The concrete floor will be 5 inches thick, made of 1 to $2\frac{1}{2}$ to 5 concrete, and rests directly on the ground. The ground should be scraped and well rolled or tamped to secure a good foundation for

the floor, which is laid after the walls are finished. Where the car will stand the floor should be sloped to a drain at the center to carry off the water used in washing. If running water is obtainable the pipes should be laid before the foundation and floor are started. It is a good plan to provide for an underground gasoline storage tank with a pump extending up through the concrete floor.

The roof can be made either peaked or flat. The flat form is much easier for the average person to build. Such a roof should be constructed with a slope of about 4 inches toward the back of the building to drain off water. Make the roof 6 inches thick, of 1:2:4 concrete, and reinforced with $\frac{3}{8}$ -inch round steel rods spaced 5 inches apart for the short lengths and 9 inches for the long lengths. These rods are located 1 inch from the bottom of the roof. Where the rods cross, wire them together to prevent shifting when the concrete is placed. Over the doorway, where there is no wall to support the roof, the weight is carried by a concrete beam 6 inches wide by 14 inches deep, including the thickness of the roof. Both beam and roof are built at the

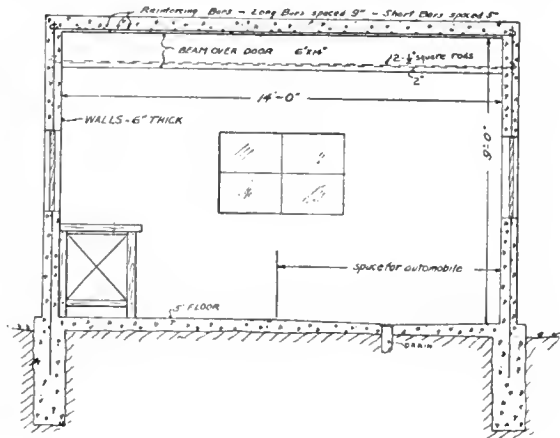

same time. Two inches from the bottom of the beam place two $\frac{1}{2}$ -inch square twisted steel rods. The form for the roof consists of a flat platform of 1-inch boards on joists supported by upright studding. Be sure that the forms are strongly made and well supported so as to safely hold the weight of the wet concrete. This form should remain in place for a week or two after placing the concrete.

Make provision through the roof for a concrete chimney or sheet iron smoke pipe for a small coal or gas stove. The garage should be heated in winter to prevent freezing of the water in the cylinders and radiator of the car.

Materials Needed

For a garage of the size given there will be required: $38\frac{1}{2}$ barrels of Portland cement, 12 cubic yards sand and 24 cubic yards stone or gravel.

Send \$1.00 for 1 year's subscription to the IRRIGATION AGE and bound copy of THE PRIMER OF IRRIGATION. If you desire a copy of The Primer of Hydraulics add \$2.50 to above price.

PRACTICAL AND INDEPENDENT IRRIGATION DEVELOPMENT

Progressive agriculturists are realizing that irrigation properly applied is as valuable an asset in New England and Florida as it is in the arid regions of the West. Irrigation in the so-called "wet belt" is beyond the experimental stage; New England is showing results almost marvelous in market garden, tobacco field and orchard. Reports are frequently made in Massachusetts and Connecticut of lands yielding under irrigation from three to four-fold greater than exactly similar areas dependent for moisture upon the vagaries of the weather.

The net work of electric power lines rapidly spreading over the country, the perfection of the internal combustion engine and the design of highly efficient and low-cost pumping machinery make practicable the independent irrigation development. In all parts of the country the land owner with his own pumping plant to supply irrigation for his acreage has an insurance on his crops against freezing and against a possible dry season that is infinitely more valuable than fire insurance on his buildings. No anxious watching of the sky for rain on the hot summer days of drought when other crops are drying up for lack of water. No rueful contemplation of a partial crop that is hardly sufficient to pay expenses. Sunshine, warmth and water are essential to plant growth, and to the man with an irrigation system the continuance of clear, hot days is most welcome. As when the ground is rich with moisture in the springtime the first bright warm days bring to life all vegetation, so the hot days of summer need but the assistance of moisture to bring the crops to sure and full fruition.

Although the farmer has a choice of several different methods of distributing water to the crops, a great deal has to be taken into consideration as to which is the most economical and satisfactory method. The topography of the land, the kind of soil, the character of the crop to be irrigated, the labor required and the ease of cultivation are among the factors which are instrumental in this determination. In the Western states it is usually found that surface irrigation can best be done by means of ditches, furrows or flooding.

In the East, however, surface irrigation is frequently impractical, as the necessary levelling of the land might destroy the productiveness of the shallow soil. Furthermore, most forms of surface irrigation would demand that regularly shaped fields with long rows be broken up into irregular ones to conform to the varying levels of the land. The system generally used is spraying from overhead pipes, parallel lines of pipe being suspended forty to sixty feet apart. The pipes are fitted with special nozzles every few feet, these nozzles throwing a fine stream which breaks into spray. Means are provided for turning the pipes so that the inclination of the streams varies and thus a practically even distribution of water over the whole field is obtained.

Among the large variety of pumping equipment used for supplying water for irrigation projects none has created such a great interest on the market as

that shown in the illustration herewith. This pump is a special horizontal double acting single cylinder power pump built by The Deane Steam Pump Company of Holyoke, Mass. It undoubtedly represents the most highly efficient piece of pumping machinery on the market designed especially to meet the needs of the individual irrigator.

The same care has been expended in the design of this type of pump to prevent the transgression of hydraulic laws as is usual in the layout of the plans of the most important large city water works pumping engines. In consequence, there is a total absence of air pockets to decrease the volumetric efficiency and cause pounding and valve troubles. The waterways are short, direct and of large area. The valves themselves are identically the same as are used in pumping engines, and the valve areas and flow velocities are computed on the same basis. Though obviously more costly than the up-flow type, the cylinder of the Deane "Model A" pump has been made of the submerged piston type to facilitate starting up without priming and after protracted periods of disuse. Every part of the pump, including the valve service, is accessible without disconnection of either the suction or the discharge pipe—which, in itself, is a material advantage where pipe tools are difficult to obtain. All gearing is accurately cut on automatic machinery from solid blanks, insuring high mechanical efficiency and smooth, quiet operation. A large number of these pumps are used in irrigation pumping from rivers, brooks, ditches or lakes to heights depending upon the particular farm on which they are used. Irrigation pumping is an especially severe service but these pumps are entirely suitable for driving by any power.

The Model "A" pump is exceptionally serviceable for operation from small internal-combustion engines. It is arranged for belt drive, both tight and loose pulleys being furnished. This arrangement is in general most satisfactory—being quiet, efficient and flexible. In this way gear noises are practically eliminated. The engine may be used either for pumping or for any of the other purposes for which it may be needed on the farm. The economy of the internal-combustion engine is so well known as to require little comment, yet it will be of interest to know that by the use of one of these model "A" pumps and a gasoline or kerosene engine (such as that manufactured by the International Gas Engine Company, Cudahy, Wis.), 20,000 gallons of water can be lifted approximately 50 feet by the use of about one gallon of gasoline or oil. In addition to this very economical operation, the whole outfit is so simple that it can easily be operated by ordinary labor.

Among the many points of superiority in the Model "A" pump can be mentioned the simplicity of design which involves the fewest possible number of parts consistent with efficient and successful operation. The base and the cylinders are of exceptionally heavy and rigid construction. The cylinder is brass-lined, thus preventing rusting, and this lining can be replaced in case of wear, making an inexpensive cylinder renewal. The crank and pinionshaft bearings are long, and perfect alignment is assured by heavily ribbing the casting containing them.

Reclamation Notes

CALIFORNIA.

The sale of approximately 47,000 acres of land in the Imperial Valley by the Southern Pacific Land Company to the California Land and Water Company at a price stated to be close to \$2,000,000 was announced recently. Irrigation canals from the main Imperial Valley system have been nearly completed, and it is expected that the deal will open up some 90,000 acres for reclamation, as the railroad held only alternate sections, government entrymen owning the rest.

The formation of an irrigation district near Oroville to comprise 60,000 acres is being pushed rapidly forward. It is planned to take water from the middle fork of Feather River and distribute it over the land by means of pipe lines and ditches. The acreage included in the district is all valuable orange and olive land.

Articles of incorporation have been filed by the Cudahy Mutual Water Company, with the principal office located at Los Angeles. The company is capitalized for \$75,000. The incorporators of the company are L. W. Sale, L. M. Cole, Marco H. Hellman, V. C. Kleinberger and F. H. Edwards.

The first steps looking to the organization of an irrigation district embracing 18,000 acres of land on the west side of the river between Redding and Cottonwood were taken at a meeting held recently in Anderson. J. C. Brown, of Cottonwood, presided, and W. C. Barklöö acted as secretary.

A company of Los Angeles capitalists, headed by Mrs. E. A. Wantworth, has purchased 400 acres of land in Santa Ana, Wash., on Church street, and will start an ostrich farm. There is a well 149 feet deep on the property and it is thought that 500 inches of water can be developed. A pump will soon be installed.

United States Collector of Internal Revenue Joseph J. Scott of San Francisco directed to the Secretary of the Treasury a request for an opinion as to whether or not the irrigation and reclamation sections of his district are liable to taxation. There is a clause in the tariff law that exempts the bonds of a state, or a political subdivision of a state, from taxation, and the question is if the irrigation and reclamation districts fall under this clause. As there are millions of acres of reclamation and irrigation lands in Collector Scott's district, the question is an important one.

A. D. Lewis, a member of the engineering corps of the English government engaged in irrigation work in South Africa, is investigating the system of management, the plan of water distribution and other matters connected with the operation of the Modesto irrigation district. He has made a study already of a number of other irrigation districts and will continue his study in the United States for some time before reporting to his government. Mr. Lewis has been in the United States since last July.

Plans for the creation of an American Holland, with an area 2,000 square miles greater than the Netherlands, by means of a system of irrigation canals, have been formed by A. L. Shinn, of San Francisco. He submitted them recently to the State Realty Federation at its meeting at Del Monte, telling in detail how the State and National Governments could combine to create a region of almost illimitable fertility in the Sacramento and San Joaquin Valleys, where 8,000,000 acres net might support a population greater than the 5,000,000 owing allegiance to Queen Wilhelmina. In the valley of the Sacramento alone the land could be increased in value to \$500,000,000 by canals along its sides, and these might be made to furnish immense electric power as well.

In describing his plans Mr. Shinn pointed out that more

water than would be required to irrigate all of northern California goes to waste through the floods of the Sacramento River. There are storage facilities in the mountains sufficient to meet the requirements, which can be economically employed. The principal and most economical reservoir sites lie at the comparatively high elevation, probably above 3,000 feet. By utilizing 2,000 feet of the drop for power purposes the water could be delivered at the head of the Sacramento Valley, near Redding, at an elevation of 1,000 feet, to be thence distributed for irrigation.

COLORADO.

The Reclamation Service is asking for proposals for furnishing 250,000 barrels of Portland cement, f. o. b. cars at the works of the bidder, for use in connection with government irrigation projects. The bids will be opened on January 15, at the office of the Reclamation Service, 408 Commonwealth building, Denver, Colo.

Almost 16,000 acres of land will be placed under irrigation next spring, twenty-four miles from Fort Morgan, by the San Arroya Irrigation District, which has recently completed its reservoir. The inauguration of the district's system will mean the active utilization of one of the largest irrigation projects in the eastern part of the state of Colorado. The reservoir covers 373 acres and will contain 22,000 acre feet of water.

Control of the Orchard Mesa Irrigation District was taken from the Magenheimer interests in the ditch election held early in December, 1913, and the largest land owners and heaviest tax payers on the Mesa are now cut off from all representation on the board. The election was of the highest importance because of the fight which was started some time ago against the Magenheimers over alleged extravagances in the construction of the million dollar ditch.

The Grand Valley Irrigation Company of Grand Junction went through the past year with smaller expenses than for five years previous, according to the recent report of its secretary, A. O. Peery. The expenditures for the year were \$29,382.59; resources reported as \$18,429.22, and liabilities \$5,352.42. In the twenty years that the company has been in existence the ditch has practically been rebuilt, and the total average expense has been a little less than 90 cents per acre. The company's original charter was for twenty years and it will be necessary to obtain a new one this year. It is expected that the organization will be the same as heretofore.

A number of enterprising farmers of the May Valley region are organizing a reclamation district. It will be one of the big projects of the near future for Lamar and vicinity. This district will reclaim twenty sections of land. As this land has already been developed under irrigation and its value established, the bonds of the district will find a ready sale, and it is expected that the preliminary work of organization will soon be completed, and the district ready for work.

The bondholders' committee of the North Sterling Irrigation District has cancelled the interest and taxes on the district bonds for a period of five years, i. e., they have eliminated the payment of a half million dollars interest. This action was taken recently at a meeting held in Chicago after a committee representing land owners under the district had informed them that the farmers were experiencing much difficulty in developing their land because of the lack of capital, inasmuch as they had no opportunity to mature crops, the water from the reservoir having only been placed on portions of the land last July.

The Secretary of the Interior has authorized the Reclamation Service to execute contract with the Orman Construction Company of Pueblo for excavating a portion of the Selig Extension Canal, a part of the Uncompahgre project. The work involves the excavation of 26,200 cubic yards of material and 4,000 cubic yards of overhaul. The contract price is \$7,199.

The great need for Colorado's agricultural development, in the opinion of many men most familiar with local conditions, is for a better class of tenants and owners of small ranches. Because of the superiority of Colorado's soil, climate, irrigation systems and other advantages, this state has not been forced into the measures of systematic development that have become established in other regions. The local promoters and others interested in development work are beginning to understand that they are being left behind in the march of progress, when they are really entitled to a foremost place at the head of the procession.

One of the biggest irrigation projects completed in Colorado in recent years is almost finished on the North fork of the Poudre river. The project involved the drilling of a tunnel, almost a mile long, through a mountain. The tunnel is the property of the North Poudre Irrigation company and was drilled to take the place of an old wooden flume; several miles in length, which heretofore has been used.

The two bores met recently and the big hole through the mountain was completed. The tunnel is 4,891 feet long, is eight and one-half feet high by six and one-half feet wide, and has an average grade of 16 feet to the mile. It has a carrying capacity of 400 cubic feet of water per second.

Just what has been done near Las Animas is what is needed throughout the Arkansas Valley. It is what is needed to a certain extent throughout the country if our agricultural production is to keep pace with the consumption.

A large tract of land there has been cut up into forty-acre tracts which are to be colonized by truck gardeners. The land lies in what is known as the bottoms, but it is underlaid with water-bearing sand and a pumping plant is to be installed and thus a large body of land reclaimed.

The farmers near La Junta are taking quite an interest in the dairy business, and are seeking a better breed of milch cows. Gay Ecton has a fine bred Guernsey cow which supplies milk and butter for a family of seven, and they sell about \$20 worth of milk every month.

Sam Hoeman who has just 17½ acres of land not far from Canon City has demonstrated this year that any man in this section of the west who will properly handle a small acreage can lay up money and enjoy the very best of living. In Park Center he has two small tracts totalling 17½ acres.

This land has just commenced to bear fruit yet this year he took off nearly 1,200 boxes of apples which averaged him \$1.12 a box, meaning about \$1,400 in real money.

One thousand baskets of grapes averaged around 27 cents, making \$270. This was an off year on grapes. Last year he got 1,500 baskets with about the same average price.

Five hundred crates of cherries brought an average of \$1.75, \$875 realized from cherries. Raspberries, both kinds, make a total of over 250 crates and brought at an average of \$2.00. That means \$500 for a little time and trouble. In all Mr. Hoeman pulled in over \$3,000 for the year's work.

Of course he had some expenses. But he did the greater share of the work himself and about all the money he was out was for his water tax and box and erating materials. One thousand dollars will easily cover these expenditures and it is plain to see the splendid profit.

IDAHO.

The Reclamation Service is asking for proposals for about 490,000 pounds of reinforcement bars for use on the Boise irrigation project. The bids will be opened at the office of the United States Reclamation Service at Boise, Idaho, January 20, 1914.

KANSAS.

During the Kansas Irrigation Congress held at Goodland late in December, Prof. E. Haworth, of the University of Kansas, made the statement that there is more water in western Kansas than the people can ever use. He states that inexhaustible underground streams that may be tapped for irrigation are to be found over a great

portion of the region where farmers heretofore have depended on irregular rainfall.

Five farmers near Great Bend have entered into a co-operative scheme whereby they will be able to irrigate some 750 acres of their farms in dry seasons. They propose to get water for this purpose by damming Wet Walnut Creek, which flows through their land. W. S. Gearhart, state engineer at the agricultural college, is preparing the plans for the dam.

The big irrigation wells and the reservoir being erected by the state board of irrigation, north of Tribune, are almost completed, and water will soon be turned into the reservoir for the purpose of irrigating eighty acres of land.

MONTANA.

The Secretary of the Interior has authorized award of contract to Messrs. R. P. and C. B. Murrill of Gilman, Mont., for performing freight hauling services in connection with the Sun River project. The total estimated quantity of material to be delivered embraces about 4,000,000 pounds of miscellaneous freight matter, the total cost of transporting which will be about \$13,500.

F. F. Lyon, an attorney of Butte, H. R. Albion of Custer and A. W. McConnell of Chicago, Ill., are interested in an irrigation project embracing some 25,000 acres of land lying on the north side of the Little Missouri River, about 12 miles below Alzada, Mont. The project is to be put under the provision of the Carey act. Bonds have been issued and offered for sale in the east, and it is expected that the initial amount raised will be about \$300,000, which will be available some time during the winter, and work on the project will start early in the spring.

Work on the Fort Peck irrigation project has been suspended for the season.

Six hundred thousand acres of land in Montana were thrown open to entry by the government on December 6. The land is known as the Lake Basin irrigation project, and ten years ago was withdrawn from entry by the Government Reclamation Service.

The United States Reclamation Service is asking for proposals for furnishing about 750,000 pounds of steel reinforcement bars for use on the Montana irrigation projects. The bids will be opened at the office of the United States Reclamation Service at Great Falls, Mont., on January 20, 1914.

The Secretary of the Interior has authorized the Reclamation Service to award contracts for the construction of earthwork and structures in connection with the Vandalia South Canal, Milk River irrigation project, Montana, as follows: To Tebbs, Taggart, Jurgens & Knipe, Glasgow, Mont., schedule 1, 2 and 3, involving the excavation of 470,180 cubic yards of material and 70,000 cubic yards of overhaul, contract price, \$74,093.80. To Threet Bros. & Jolley, of Lowell, Wyoming, schedule 4, consisting of 17,060 cubic yards of excavation, the placing of reinforcing steel, 250,000 pounds, laying 342 linear feet of corrugated iron pipe and 2,858 linear feet of vitrified pipe, erecting 1,085 linear feet of steel flumes, furnishing lumber for turnouts and bridges, etc., contract price, \$42,120.95.

A report has been submitted by the engineers of the Musselshell Valley irrigation project to the Board of Commissioners, outlining in a general way, the proposed work, and including a detailed estimate of the probable cost of the work. The district to be irrigated is located entirely in Musselshell County, extending along the Musselshell River valley from near the town of Barber on the west for a length of approximately 100 miles to Melstone on the east. The land along the proposed canal is practically all in private ownership in tracts of from 160 acres up to 1,200 acres. It is proposed to irrigate something over 19,000 acres, 60 per cent of which is at present under cultivation. A few miles from the

town of Barber is a natural reservoir site, called "Dead Man's Basin," which was reserved by the United States Reclamation Service a few years ago. This will be used in this project. It covers an area of about 2,000 acres and will hold 20 to 30 feet of water without additional diking on the edge. The estimated cost of the project is \$208,139. If a supply canal should be found necessary the cost will be increased by \$54,000.

John L. B. Mayer of Augusta has been awarded the contract for manufacturing 250,000 feet of lumber to be used on the structures of the Sun River irrigation project.

NEBRASKA.

The Secretary of the Interior has authorized the Reclamation Service to execute contract with the Pittsburgh Valve and Construction Company of Pittsburgh, for furnishing needle regulating valves for the Minitare dam, North Platte irrigation project, Nebraska. The contract price is \$4,528.

The irrigation plan of the North Platte project provides for the storage of the flood waters of North Platte River by the Pathfinder dam about three miles below the junction of the North Platte and Sweetwater rivers in Wyoming, and in smaller reservoirs along the canal lines. Minitare dam, which impounds the waters in one of these small reservoirs, is a structure 65 feet high, 3,370 feet long along its crest and will have a volume of 570,000 cubic yards. The North Platte project includes 129,270 acres of irrigable land, the greater part of which is in Nebraska.

C. N. Philbrick of Fullerton recently applied to the State Board of Irrigation for water rights for power purposes from the Cedar River at Belgrade. Patterson & Patterson, attorneys for the Hoard Cattle Company, protested against the granting of the petition on the grounds that the ditch will cut through the cattle yards of the company. The petition was denied.

The Lodge Pole Irrigation Company, combining several smaller irrigation projects in western Nebraska, have incorporated with a capitalization of \$250,000. The incorporators are M. M. Bennett, R. P. Fuller and Samuel Corson. The headquarters of the company will be at Kimball.

The Dawson County Irrigation Company, with a capital stock of \$30,000, has filed its articles of incorporation with the Secretary of State. The men behind the project are Roy Stuckey, F. L. Temple, C. G. Wallace, Roy Haas, P. J. Hewett. Headquarters of the company will be at Lexington.

NEW MEXICO.

The Secretary of the Interior has authorized the Elephant Butte Water Users' Association, Rio Grande irrigation project, New Mexico, to receive subscriptions to an amount not exceeding 110,000 acres of irrigable land, with the proviso that if a larger acreage offers, preference shall be given to that owned in the small holdings. The association is required to make the receipt of additional subscriptions conditional upon all excess holdings, entering into the usual contract to subdivide the tracts into holdings not exceeding 80 acres. Additional subscriptions will be conditional upon all assessments heretofore levied by the Elephant Butte Water Users' Association being paid by the lands subscribed.

When the Rio Grande project was taken up it was estimated that the water supply would be sufficient for 180,000 acres, 25,000 of which would be in Mexico under the provisions of the appropriation of Congress for this purpose, 45,000 in Texas and 110,000 in New Mexico.

The allotment of 110,000 acres was subscribed in New Mexico to the Elephant Butte Water Users' Association, but subsequent surveys have shown that a large amount of the land so subscribed is non-irrigable, either from its physical character, or by its location above gravity service, and this authorization to allow the association to receive additional subscriptions is to make up the original allotment of 110,000 acres of irrigable land.

The Secretary of the Interior has authorized the Reclamation Service to execute contract with the Coffin Valve Company of Neponset, Mass., for furnishing service gates for the Elephant Butte dam, Rio Grande irrigation project, New Mexico. The contract price is \$23,248.

The Elephant Butte dam is one of the largest structures of the Reclamation Service, having a height of 300 feet and a length on top of 1,600 feet. The reservoir created by this dam will cover 67½ square miles, an average depth of 66 feet, and will contain 860,000,000,000 gallons of water when full. It will be the largest storage reservoir in the world, with a storage capacity nearly a third greater than that of the Assuan dam in Egypt. The structure will cost nearly \$5,000,000 and will provide water for 180,000 acres of land in the Rio Grande Valley. A considerable portion of this land has been under irrigation for several hundred years, and some of the old ditches of the Pueblo Indians are still in use.

OREGON.

Articles of incorporation have been filed by the Northwest Company of Portland, Ore. The purpose of the company is to operate reservoirs for irrigation purposes and do a general irrigation business. The company is capitalized for \$200,000. A. F. Jones of Portland is president of the company, and T. L. Croetau of that city is the treasurer. The principal place of business is Portland.

The suit of the Maxwell Land and Irrigation Company against the Hermiston Bank and Trust Company to prevent the sale of plaintiff's lands under the Umatilla project, by which an injunction had been secured which was afterwards set aside on demurrer, has been appealed. The sale of the lands was fixed for December 27, 1913, but in view of the appeal of the case to the Oregon Supreme Court, which now has the matter under consideration, the sale did not take place on that date, as advertised, but must await the decision of the Supreme Court of the state relative to the validity of the deed of trust given by the Maxwell Company to the Hermiston Bank and Trust Company.

The Umatilla project in Northern Oregon is one of the smaller of the Government irrigation projects, but by reason of an extremely fortunate combination of soil, climate, and market facilities, it embraces land which would eventually take its place among the most valuable farm land in the United States. Already a large proportion of the area is devoted to fruit and truck, and the first shipment of peaches was made this year.

During the season just closed 4,994 acres were irrigated, and 3,033 acres cropped. The remainder was in young non-bearing orchards, new alfalfa, etc. The total crop yield was \$84,078, or an average of \$27.72 per acre. This is a most gratifying report in comparison with the yields in other sections, especially in view of the fact that five years ago the Umatilla project was raw desert land. In 1909 the value per acre for the United States of land irrigated and cropped was \$25.08.

Following is a record of some of the season's yield on the Umatilla project: Alfalfa hay, \$31.66 per acre; clover hay, \$12.50; Indian corn, \$16.32; Small fruits, \$55.33; garden, \$48.05; potatoes, \$58.12; and miscellaneous crops, \$64.71 per acre.

WASHINGTON.

The Secretary of the Interior has authorized award of contract to the Roslyn Fuel Company of North Yakima for furnishing approximately 3,000 tons of coal for the use of the Reclamation Service on the North Yakima storage project for a period ending November 30, 1914. The price of coal under the accepted bid is \$2.75 per ton.

Governor Lister recently signed for the state a contract with the federal government for the expenditure of the state's \$10,000 appropriation for the survey of the proposed Palouse irrigation project. This appropriation was made by the last session of the legislature, and the action of executing the contract is but a formal carrying out of the provision of the law, the state and the federal government to share alike in the expenses for the survey.

MISCELLANEOUS

The Sun River Valley in Montana is now entering upon an era of electrical development which is to hasten the completion of one of the government's huge irrigation projects.

Seventy miles of transmission line have been built, extending from the Rainbow Falls hydro-electric plant of the Great Falls Power Company on the Missouri river, westerly through the entire length of the valley to the base of the mountains where the principal diversion dam is now under construction across Sun River. The electrical energy, transmitted at a voltage of 110,000, is stepped down at three transformer stations, from which it will be distributed to the principal features of the work. It is now being used at the Sun River diversion dam, operating pumps and air compressors, concrete mixers, derricks, and in lighting the construction camp and the site of the work. The government is constructing a distribution transmission line along the Piehkon reservoir and the Sun River Slope canals, a distance of 44 miles.

The contract for the excavation of the main canals and laterals has been awarded and the contracting company is having special power shovels and drag line scrapers designed and constructed for the work. All power machinery on the work will be actuated by electrical energy, including the air compressors on the tunnel work.

The exclusive use of electrical energy in the construction of an irrigation project, including the excavating of the canals, marks a radical departure from the old order of things and a new epoch in construction work. It is believed that a considerable reduction of cost and time will be accomplished.

The power company is bound by the contract to extend the present trunk transmission line 30 miles when required by the United States, at right angles entirely across the project. This will make available at the outset electrical energy for each of the towns already projected along the three new lines of railway which are being constructed across the project, giving them cheap light and power for manufacturing and allied uses. They may also follow the example of the towns on the Minidoke project in southern Idaho, where many of the homes, business houses, and public buildings, are heated as well as lighted by electricity from the government power plant.

The Sun River project involves some of the largest features of construction work yet undertaken by the reclamation service, and the results obtained by settlers on the Fort Shaw unit justify the expectation that this will be one of the most satisfactory of the northern projects.

The Secretary of the Interior has authorized the expenditure of \$70,000 in the extension of the canal and lateral system, Yuma irrigation project, Arizona-California. This work will bring a considerable additional area under ditch for which the main canals have already been constructed. The land which will be served by the new ditches has all been filed upon.

The Secretary of the Interior has authorized the Reclamation Service to execute contract with the Hinman Hydraulic Mfg. Co., of Denver, Colorado, for furnishing regular gates for the Grand river dam in connection with the Grand Valley irrigation project, Colorado. The contract price is \$6,079.

Actual construction on this project commenced one year ago, and progress has been most satisfactory. A tunnel 3,725 feet in length has been completed, more than a thousand linear feet of the second tunnel has been excavated, and work has commenced on the third tunnel. Construction work on the high line canal itself is well under way and the diversion dam site in Grand river is progressing rapidly.

This dam will be unique in American engineering, the only other structure of its type in this country having been built in connection with the Boise irrigation project in southern Idaho. It will be provided with movable crest consisting of large steel rolls. During the low water period this rolling crest will be in place to force the water into the canals, but in times of flood it rolls up on the abutment, allowing the high water to pass. It is estimated that it will require two years for the construction of this dam, as work can be carried on only during the low water period.

(Continued from page 78)

a response. But the results are now apparent to even a casual observer. More specifically, while previously the forests were going backward because of fires, there is now an annual gain through growth. This increase translated into dollars and cents is much greater than the total cost of production and all other expenses of the forests.

The necessity to take immediate steps to prevent the public forests from being destroyed by fire has placed a large emphasis on the protective feature of the administration. The wise use of the forest resources in the development of industries and in building up the country is essentially the real aim of maintaining the forests. Protection from destruction is a first essential; otherwise there would be no resources to use. But the purpose of the administration is not merely protective, but constructive. It is a favorite theme of the opponents of the national forest system to represent the forests as a separate federal domain, held for the use of future generations or for persons other than those now living in the region in which the forests are situated. Such statements are not only contrary to the spirit of the administration of the forests, but are disproved by the results already being secured. The aim is to make the forests count in the highest possible measure in the industrial upbuilding of the local communities, at the same time that they serve their broader public functions. In classifying the agricultural lands the aim is to get people to make permanent homes in the forests. Every consideration in the development of the states and in the upbuilding of the forests themselves makes for the encouragement of a greater local population. When there are people to create a demand for the timber and other resources, the real development of the forest becomes possible, and the forest begins to render its greatest service.

To encourage this development the Forest Service is promoting the sale of its ripe timber to build up local lumber industries of a permanent character; it is opening to entry land chiefly adapted to agriculture; it is further helping the settler by providing free such timber as he needs and protecting him in the use of the range needed for his stock; and in every way it undertakes to make the forests of public service and the country in the long run a better place for men and women to live in.

That a long step has already been taken toward this end is indicated by the very extraordinary change in sentiment in the West in the last few years. I have this year been able to analyze in detail the sentiment on the individual forests and now know just where opposition in each case exists and the extent to which the work of the federal government is valued. I have been astonished at the overwhelming preponderance of sentiment among the local communities in favor of the forest system. Frequently there are objections to certain regulations, or difficulty and friction in specific transactions. But every year these local troubles are being adjusted on the ground. There is still definite opposition to the forest system and the principles of

our administration from certain groups, and certain interests. There are still certain water power interests which are carrying on a fight against the Forest Service. Many speculative interests oppose the forest system because the resources are not open to private acquisition under the general land laws. Certain men are opposed to the national forests because they can not secure privileges that would be possible if the forests were unprotected. For example, in the southwest I find a well defined opposition among those who desire to run herds of goats on the forests without restriction. The desire to secure valuable timber for speculation is now, and always will be, a source of opposition to the public control of our forests.

One proof of the present favorable sentiment

is the fact that there are now relatively few breaches of the regulations. For example, in the Fourth Administrative District which includes Utah, Nevada, northern Arizona, southern Idaho and southwestern Wyoming; over 11,000 permits were issued last year, each involving some regulation. There were only thirty-five cases of trespass, about half of which were innocent and the majority of the remainder not very important. Such a record would be absolutely impossible if the people themselves were not right behind the regulations. In other words, it was public sentiment that made it possible to carry out the procedure with such success.

In the national forest districts it is now seen that the aim is to make the national forests serviceable at present as well as in the future, and people

FORESTRY NOTES

Canada cuts about 2 million cords of pulp wood annually, about half of which is exported for manufacture in the United States.

It is claimed that some of the eucalypts of Australia are taller than the California redwoods, hitherto considered the highest trees in the world.

There are fifty-five oaks in the United States, about evenly divided between the east and the west. The eastern species and particularly white oaks are the most valuable.

The bureau of forestry of the Philippine Islands will send tropical timbers to the United States forest service so that their suitability for fine furniture veneers may be ascertained.

Wood block paving, tried and discarded in many cities of the United States thirty years ago, is now coming back into marked favor, due to improved methods of treating and handling the blocks.

German foresters are experimenting with Douglas fir from the United States trying to find a variety which will combine the fast-growing quality of the Pacific coast form and the hardiness of the Rocky mountain form.

There are about 37 pines native to the United States, of which 25 are western species, and 12 eastern.

Paraguay has valuable forest resources, the most important of which is quebracho, particularly rich in tannin.

Much of the cork used throughout the world comes from Portugal, which harvests about 50,000 tons a year.

Germany is said to have an over-supply of foresters; so that well-edicated men have hard work to secure even inferior positions.

One of the largest forest nurseries in the United States is conducted by the forest service near Haugen, Montana. It is known as the Savenac nursery and has a capacity of 4,000,000 young trees a year.



Resthaven—Elgin, Illinois

An ideal place for rest and complete relaxation, with modern appliances for treating Rheumatism, Nervous and Digestive Disorders. *Radiant Light, Neuheim, Steam, Vapor, Needle Baths, etc.* Electricity, Osteopathy, Hydrotherapy, Vibrassage, Massage, Medical Gymnastics, Diet.

This is a delightful place to recuperate from the nervous trouble resultant from long residence in high altitudes. Write for particulars and terms.

RESTHAVEN SANITARIUM

Villa and Liberty Sts.

ELGIN, ILLINOIS

are cooperating more and more with the government to make the local administration successful.

In the East the work of the federal government is today far more effective than ever before. The establishment of national forests under the provisions of the Weeks law is accomplishing many results not anticipated even by its most earnest advocates. The purchase of lands on important watersheds in the White Mountains and southern Appalachians is steadily progressing. Already contracts for over 700,000 acres have been approved by the National Forest Reservation Commission. These lands are located on the most important watersheds and have been secured at prices representing their actual value, the average being \$5.07 per acre. It has already been demonstrated that the building up of national forests by purchase and at reasonable prices is practicable.

The first effect of these purchases has been an educational one.

(Continued from page 76)

land boards or an entirely new tribunal is immaterial—although in some cases the official bodies named should be abundantly able to cope with the situation. Take the office of the State engineer out of politics, attach to it a decent salary and a respectable lease of life, restrict the practice of engineering to those qualified, as is done in Wyoming, introduce official censorship of all irrigation literature, as Colorado now censors that of Carey Act Companies—let the world know that the States stands back of their irrigated lands and irrigation securities,—let the local banks and financiers interest themselves in their irrigation schemes, institute a few wholesome prosecutions of "land and water sharks" and the abuses of the past will tend, in course of time, to be eliminated and to be forgotten.

Send \$1.00 for 1 year's subscription to the IRRIGATION AGE and bound copy of THE PRIMER OF IRRIGATION. If you desire a copy of The Primer of Hydraulics, add \$2.50 to above price.



THE attention of our readers is directed to the numerous premium offers in this issue. We will present to new subscribers, postage paid, who send in \$1.00 for 1 year's subscription to IRRIGATION AGE, either one paper bound copy of THE PRIMER OF IRRIGATION, or one Crocodile Wrench. (See advertisement elsewhere) This offer applies also to all old subscribers who pay for the current year and one year in advance.

THE IRRIGATION AGE

30 North Dearborn Street
CHICAGO

Clear Fir Silo at 40% to 60% Saving

Buy your silo of us, and you buy *direct*, not only from the *maker* but from the *lumber producer* as well.

We own forests, railroads and six big mills

There are thousands of acres of timber in our tracts. The fir is the finest in the land. Tall, straight and close of grain. Only the choicest goes into Seattle Silo Staves. They show no knots, sap or other defects. Do not warp, shrink or swell. The toughest, best wearing wood in existence. All the cutting, logging and manufacturing of this timber is handled by us. One continuous operation. One overhead expense. Hence the big saving that we effect in producing cost—and why we save you 40% to 60% on a silo of better quality. Mail the coupon for catalog.

Seattle Silos

have patented swinging doors

These are far the best silo doors ever devised.

Quick detachable with special iron cross-bar or hoop connection. The steel bars on the door provide a solid ladder from which hoops can be tightened—the result of a new invention. They close absolutely air-tight. Can not stick or bind—never have to be lifted. They swing in or out readily on their hinges.

Mail the coupon today

We are preparing to furnish you with seasoned red cedar for flume building purposes.

"Machine banded wood stave pipe for irrigation system."

Save 40% to 60% on Lumber and Millwork

Five middlemen come between the mill and you when you buy of your local lumber dealer. All get a fat profit; no wonder lumber is high. We put an end to this hold-up game. Sell you direct. Give you better materials at our mill price. Save you 40% to 60%.

We make shipments within 24 to 48 hours after receiving orders. Our shipments get to destination within an average of two weeks. Write today for price list. Better still, send your list of materials for our pre-paid prices. Money back unless satisfied.

Mail coupon today

HEWITT-LEA-FUNCK CO.

471 Crary Bldg., Seattle, Wash.

Kindly send the following, quoting prices delivered my station.

Catalog of lumber and millwork. Special silo folder.

Be sure to write plainly

Name _____

Address _____

Business _____

I am planning to build as follows: _____

FOREST NOTES.

The Automobile Club of America, through its bureau of tours, is urging automobilists to use care with fire in timbered regions.

Oils distilled from the needles of spruce and fir trees are being used to scent petroleum floor oils which are sometimes objectionable on account of their odor.

The governor of Iowa has set aside a fire-prevention day, urging that the citizens discuss conditions and create a sentiment against forest fires and other conflagrations.

The average area administered by a ranger on the federal forests of the United States is about 100,000 acres. In Germany the area administered by a man of equivalent rank is about 700 acres.

The republic of Colombia is said to have excellent regulations for its national forests. Lumbermen who take cedar and mahogany are required to plant young trees of the same species in the cut-over spaces.

The forests of Norway are mostly in private or municipal ownership, the nation owning 28.5 per cent of the total forest area. The national forests of the United States occupy only about twenty per cent of the total forest area of the country.

The CROCODILE WRENCH

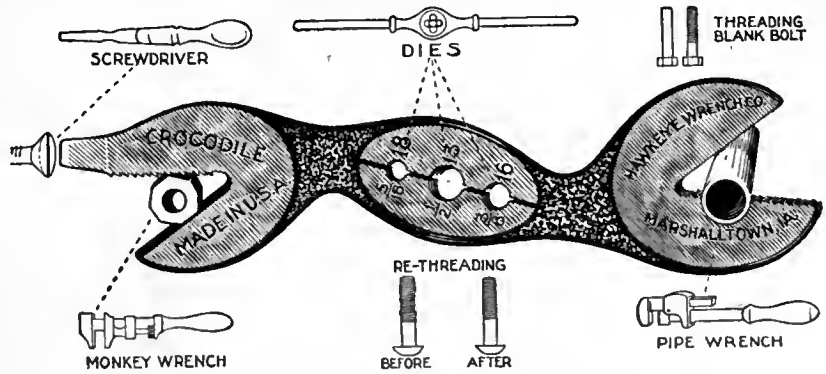

Six Handy Farm Tools in One

The Crocodile Wrench is drop forged from the finest tool steel and scientifically tempered. Every wrench guaranteed against breakage. It is 8½ inches long and weighs ten ounces.

A pipe wrench, a nut wrench, a screw driver and three dies for cleaning up and re-threading rusted and battered threads; also for cutting new threads on blank bolts. Dies will fit all bolts used on standard farm machinery.

Teeth and dies are case-hardened in bone-black, making them hard and keen.

The dies on this wrench alone would cost \$1.50, and would be worth more than that to every farmer, as they would often save valuable time, besides an extra trip to town for repairs.

Sent free with each order for Irrigation Age for one year—price for both \$1.00; also sent to old subscribers who renew their subscription for one year.

Address: IRRIGATION AGE, 30 No. Dearborn St., Chicago

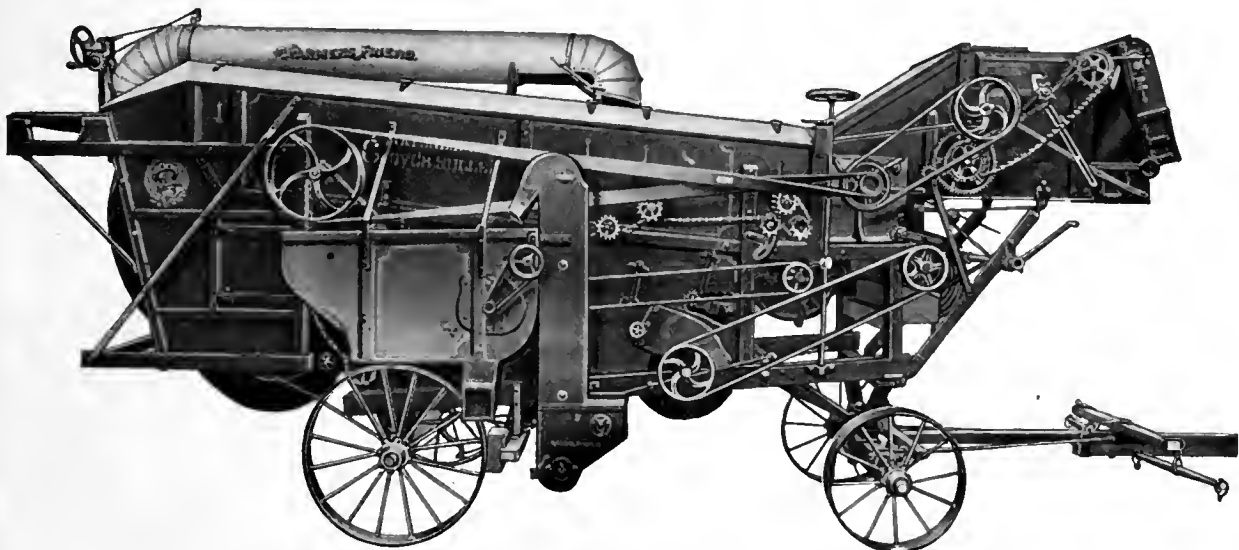

HULL YOUR SEED QUICKLY, PERFECTLY and ECONOMICALLY With a "MATCHLESS" CLOVER and ALFALFA HULLER

That's just what you will do if you use a "Matchless" Huller on the job. It's the one huller that will hull all the Clover or Alfalfa you can get to it without sacrificing the quality of the work. Here's the reason! We use square steel brads in our hulling cylinder. This construction has every advantage over rasps of spikes, because no set of spikes will knock the seed out of the damp pods. Rasps gum up and are easily destroyed. Our system of separation is unique and effective. This consists of a series of rotating troughs with perforation in the bottom, with provision for adjustment to meet the various conditions of clover. The Patented Steel Scrapers attached to the bottom of these troughs thoroughly scrape the separator bottom and insure a steady and positive delivery of the pods to the hulling cylinder, regardless of the condition of the clover. This construction enables you to hull seed under conditions in which no other huller can operate; enables you to hull earlier in the morning and later in the evening than with any other—this insures a longer day, thus increasing your earning power. Give us an opportunity to prove to you right on your own farm that the "Matchless" is the speediest and cleanest huller on the market. WRITE FOR CATALOG TODAY, or call at our nearest Branch House.

THE AULTMAN & TAYLOR MACHINERY COMPANY, MANSFIELD, OHIO.

Sole Builders of Aultman-Taylor "Starved Rooster" Line of Machinery.

BRANCHES: Minneapolis, Minn.; Portland, Ore.; Lincoln, Nebr.; Kansas City, Mo.; Wichita, Kan.; Decatur, Ill.; Indianapolis, Ind.

When writing to advertisers please mention The Irrigation Age.

(Continued from page 74)

may be lessened, but the hay is not so coarse as when a less quantity is used. A certain number of plants are killed every year by frost, mechanical means, etc., so that we prefer it thick rather than thin.

Alfalfa will grow and give a high return any ordinary year without irrigation, but it attains its greatest perfection when supplied with a liberal amount of water—water taken preferably from a reservoir, the contents of which have been warmed

by the genial rays of Old Sol. But we do not give it too much water, or you may overdo it. Let me illustrate. It is related in Japan that there is a spring which when bathed in, one sheds the years as one would shed a garment. A lady hearing of it was directed there by a passing shepherd. The next morning on passing the spring the shepherd found a young babe—she had overdone it. Do not put too much water on your alfalfa, otherwise you will retard the growth of your next cutting, and it will possibly kill some of the plants.

POULTRY NOTES

New York will take poultry either scalded or dry-picked. Boston wants only dry-picked stock. Chicago wants, for its own trade, only scalded stock in chickens, ducks and geese, but prefers turkeys dry-picked.

Frozen eggs are sold by weight, and are in demand in cities with the large bakers and cracker makers. In certain classes of restaurants frozen eggs are used for scrambled eggs and omelets.

In testing eggs by lamplight the object is to discern the size of the air space in the eggs. When the egg is perfectly fresh, the space is very small and can just be seen at the broad end. Each day this space increases in size, and when it becomes very large the egg is ranked second-class. Cloudy eggs, or those which rattle, are suitable only for cheap cookery or manufacturing purposes.

A very successful egg farmer once said that in winter he always had something in his coops for his hens to pick at—scattered grain, a cabbage hanging up, and even bones with a little meat on them, always something to find in order that his flock should not contract lazy habits. In this he was humoring the natural instinct of the animal. A hen let run at large is almost always hunting, picking and scratching—first at a blade of grass, then a bug, then a worm, and next a seed.

Experiments have proved that yarded hens are more prolific layers than those allowed free range. It costs more to keep them, but the returns in eggs are larger. Yarded hens are fed on food that will make eggs, and naturally this food is converted into the object for which it is intended. On the other hand, the same food fed to fowls that are on a range, is more apt to go to the making of flesh, bone and muscle, rather than to the making of eggs.

There is very little difference in weight of chicks of any of the breeds as compared with the others, for the first six weeks. This is so even in comparing the weight of Leghorn chicks with Brahma chicks. There is a gradual increase, however, after that time, although not so very much until after eight weeks of age. Naturally, from then on the heavier breed chicks show the greatest gain.



The Campbell Automatic Irrigation Sprinkler
Solves the "Irrigation Problem" and affords rain when you want it, and like you want it, at the minimum cost of installation and operation. Sample postpaid \$3.00. Money back if you want it. Descriptive literature on request.
J. P. CAMPBELL, Jacksonville, Fla.

**Saves Seed
Increases Yield
Improves Grade**

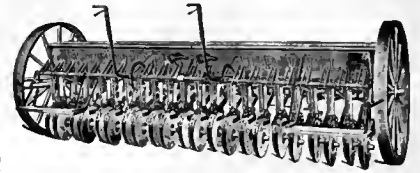

Monitor Double Disc Drill

"The Drill That Pays for Itself"

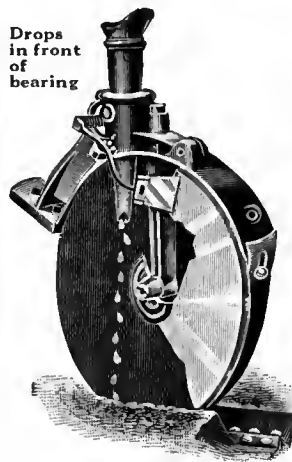

Drops
in front
of
bearing

Bigger Profits from Grain Crops. You are not making near all the money you can from your grain crops—if you are not using the Monitor Double Disc Drill. For example—with wheat it saves one-fifth the seed and increases the yield 3 to 7 bushels per acre. The increase with other grains is in the same proportion. Can you afford to lose that much on every acre every year?

Deposits Seed at an Even Depth. The Monitor sows in front of the bearing. Other drills sow behind the bearing. This particular feature of the Monitor gives it a very great advantage. The downward turn of the discs carries the grain into the ground and deposits it at the bottom of a clean, wide furrow, in two rows, one inch apart. Every grain is covered uniformly with moist soil.

Every Grain Grows. None of the seed is dragged to the surface to shrivel in the sun, or be eaten by the birds. Every seed germinates. Sow one-fifth less and still get a better stand than with the old style drills.

All Come Up at the Same Time. The proper placing of seed and uniform covering with moist soil causes the grain to come up and ripen evenly—increases the yield and improves the grade.

Write for Free Booklet containing Valuable Information on
Small Grain Crops and Monitor Drills



Moline Plow Company

Moline, Illinois

AND ALL BRANCH HOUSES



Do not let your land become flooded in the winter. Through an oversight the gate in our dam was left open, and a chinook happening at that time, snow water poured into the ditches and on to the land on which a coating of ice formed and killed every plant so covered.

Ordinarily two cuttings for the season may be had with an average of four tons per acre.

Alfalfa is relished by young stock of all kinds, and is especially good for cattle, sheep and pigs. If work horses are fed on it the oat ration should be cut down fully one-half. A convenient though somewhat wasteful way to feed it is to make a V-shaped feeder capable of holding two or three tons. If you have plenty of water and salt in addition to your hay, your stock will come through the winter in excellent condition and be ready for the block in the spring.

The burden of alfalfa growing should not fall altogether on the shoulders of the farmer. On the back part of the lot of the average householder, there is often an unsightly and unsanitary piece of ground which could be made to produce sufficient alfalfa when cured to cause the hens of that man to sing songs of praise, and in the winter add to his wealth eggs at the rate of 60 cents the dozen.

If every farmer and stockman in Canada would grow ten acres of alfalfa—and it will grow in every province from the Atlantic to the Pacific—in place of importers, we should be exporters of meats, and add thereby to the country's wealth, besides placing within the reach of everyone cheap and good food. What if there is considerable work in growing alfalfa, and one is tired after a day's work?

PATENTS FOR SALE!

AUSTRALIAN, MEXICAN and CANADIAN patents on a new principle of water measurement. Rivers or small pipe flows. Furnishes a record in gallons, cubic or acre feet. ¶ No machinery or moving parts. ¶ The principle covered is the only one in existence which furnishes a perfectly accurate record of flowing water, and when introduced, will become the universal method of measuring irrigation water throughout the world ¶ For particulars and price, apply to

W. H. TUCKER or W. H. GILMORE
VERNON, B. C., CANADA

Portable Folding Steel Dam

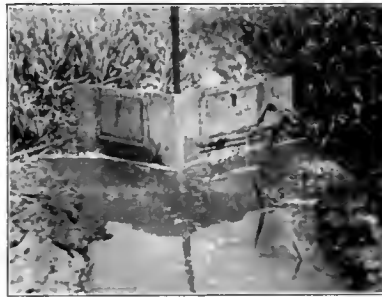

Simple in construction and easy to manufacture. Light, durable and easily carried about. Easily and quickly adjusted to any ditch. A four-foot dam will fit any ditch up to four feet wide. With one or more extensions will fit as wide a ditch as desired, or enable the irrigator to turn the water in different directions.

Practical, efficient and convenient time and labor saver.

Can be manufactured and sold at a low price and will last for many years. There is a large demand in irrigated States for this Dam. Thousands of irrigated tracts are being added annually to the large number already under irrigation. Parties interested in the manufacture and sale of this dam can secure U. S. or State Rights by writing the inventor.

W. A. LINKLETTER BOULDER, COLORADO



THINK what it means to you! To have at your service—day and night if desired—the combined power of 30 to 35 horses and 10 to 15 men—ready at a moment's notice to plow, disc, harrow, seed, harvest, build roads, irrigate, thresh and do numerous other power jobs, all at the minimum expense for fuel and maintenance. That's what you get when you buy a time-tried and time-proven

AULTMAN-TAYLOR 30-60 GAS TRACTOR

They're built with the complete knowledge of the requirements of a tractor of the first quality. They're built right here in our own shop, under our own supervision. We know they're right and we stand back of every tractor. The Aultman-Taylor 30-60 burns either gasoline, kerosene or

distillate with unequalled economy. The Aultman-Taylor 30-60 is not an experiment. Their real worth has been demonstrated on thousands of farms throughout North America. Let us explain to you why you should own and operate one of these money-making and labor-saving tractors. **WRITE FOR CATALOG AND FURTHER INFORMATION TODAY.**

We are also builders of the Famous "New Century" Separator, "Matchless" Clover and Alfalfa Huller, Steam Traction and Portable Engines, Bean Threshers and Saw Mills. Catalog free upon request.

THE AULTMAN & TAYLOR MACHINERY COMPANY

MANSFIELD, OHIO.

BRANCHES: Minneapolis, Minn. Portland, Ora. Lincoln, Nebr. Kansas City, Mo.
Wichita, Kan. Decatur, Ill. Indianapolis, Ind.

GIVE ME LAND

By Minnie C. D. Smith

Little care I just where my home may be
 But give me land.
 If not of rich, black loam; then give me sand;
 Land I demand.
 Droughts may destroy the crops on fertile loam
 Where rains should fall.
 Water to irrigate my desert land
 Comes at my call.
 Work must accompany the call, 'tis true;
 Rain must be stored;
 And ditches dug to carry to my land
 This precious hoard.
 This system once established, I'm equipped;
 The fight begun.
 Unconquered yet, he who can claim as aids,
 Water and sun.
 Winner I, in duel with fate, because I shall demand;
 That, as I have the choice of weapons, we
 Be given land.

POULTRY POINTERS

The price is not fixed by the commission merchant. He can only obtain what his customers will pay. When the market is well supplied the customers have a large stock from which to select, and they always choose the best, leaving the second-class stock to be sold at hazardous prices.

The most important egg foods—mixed with exercise—are grit, bran, charcoal, cornmeal, middlings, pure water, clover or alfalfa hay, vegetables, green cut bone, cracked oyster shell, ground oats, scalded oats, sprouted oats, linseed meal, meat scrap or meat meal.

Study conditions. Don't feed too rich a mash. Feed according to appetites. Active fowls are always hungry. It is just as important how you feed as what you feed. Wholesome food is always a source of economy. A very important point in feeding poultry for market is to feed regularly.

The hardest task in maintaining a constant and continuous egg yield is to keep the laying stock in prime condition, says Col. E. O. Roussle. This means such a condition of perfect health that the eggs will not only be laid regularly, but that they will be uniform in size, according to the breed laying them. Under such conditions we should have large eggs from Minorcas, White and Buff Leghorns, Plymouth Rocks and Brahmas. When such breeds lay small eggs, abnormally large eggs, with perhaps double yolks, or soft-shelled eggs, the stock is out of condition and usually overfat. The eggs will thus be laid irregularly, and many times laying will stop entirely. Layers should be kept active, and activity is induced by short feeding. A hungry hen is usually a good layer.

Use KEROSENE Engine Free!

Amazing "DETROIT" Kerosene Engine shipped on 15 days' FREE Trial, proves kerosene cheapest, safest, most powerful fuel. If satisfied, pay lowest price ever given on reliable farm engine; if not, pay nothing. No waste, no evaporation, no explosion from coal oil.

Gasoline Going Up!

Gasoline is 9c to 15c higher than coal oil. Still going up. Two pints of coal oil do work of three pints gasoline.

Amazing "DETROIT"

—only engine running on coal oil successfully, uses alcohol, gasoline and benzine, too. Starts without cranking. Only three moving parts—no cams—no sprockets—no gears—no valves—the utmost in simplicity, power and strength. Mounted on skids. All sizes, 2 to 20 h. p., in stock ready to ship. Engine tested before crating. Comes all ready to run. Pumps, saws, threshes, churns, separates milk, grinds feed, shells corn, runs home electric lighting plant. **Free** (stripped), \$29.50 up. Sent any place on 15 days' Free Trial. Don't buy an engine till you investigate the money-saving, power-saving "DETROIT." Thousands in use. Costs only postal to find out. If you are first in your neighborhood to write, you get Special Extra-Low Introductory price. Write! (138) Detroit Engine Works, 301 Bellevue Ave., Detroit, Mich.



FOR THE "LAND'S SAKE"

BUY A

BOSTROM IMPROVED



FARM LEVEL

Price \$15

which has TELESCOPE enabling you to read the Target over 400 yards away, and

TERRACE, DITCH, TILE DRAIN, IRRIGATE

your land properly, and save surveyor's fees. It is sold by up-to-date hardware and general merchants everywhere, and guaranteed to be the most

SIMPLE, ACCURATE, DURABLE AND COMPLETE

outfit ever made for all farm work. If your dealer hasn't one in stock, he will order for you from a nearby hardware jobber.

Write today for description of Level, and details of our MONEY BACK GUARANTEE.

BOSTROM-BRADY MANUFACTURING CO.

119 Madison Ave., Atlanta, Ga.

International Harvester Oil and Gas Engines

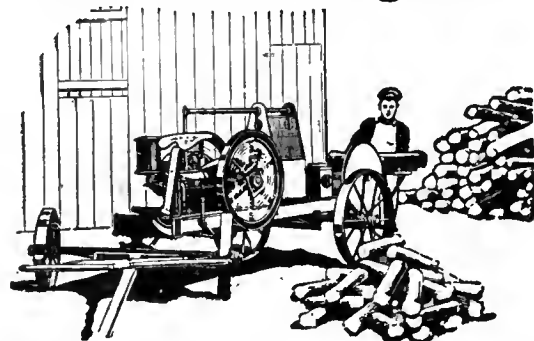

THE I H C LINE GRAIN AND HAY MACHINES

Binders, Reapers
 Headers, Mowers
 Rakes, Stackers
 Hay Loaders
 Hay Presses

CORN MACHINES

Planters, Pickers
 Bidders, Cultivators
 Ensilage Cutters
 Shellers, Shredders

TILLAGE

Combination
 Peg and Spring-Tooth,
 and Disk Harrows
 Cultivators

GENERAL LINE

Oil and Gas Engines
 Oil Tractors
 Manure Spreaders
 Cream Separators
 Farm Wagons
 Motor Trucks
 Threshers
 Grain Drills
 Feed Grinders
 Knife Grinders
 Binder Twine

HAVE you a washing machine and a churn at your house? Do you pump water, saw wood, grind feed, run a cream separator?

Do you work by hand? If so, you will be able to save yourself much time for other work by letting an International oil or gas engine do this drudgery for you.

An International engine will last many years working for you economically and without trouble because of such features as these: Accurately ground piston and lapped rings, offset cylinder head, large valves, detachable valve guides, fuel pump, etc. The engines are of all styles—vertical, horizontal, stationary and portable; air and water-cooled—sizes from 1 to 60-H. P. They operate on the cheapest or most convenient fuel.

Learn all about them at the local dealer's. If he does not sell International engines, write us for interesting catalogues and full information. Drop us a postal card to-day.

International Harvester Company of America

(Incorporated)

Denver Helena Portland Spokane Salt Lake City San Francisco
 Champion Deering McCormick Milwaukee Osborne Plano



When writing to advertisers please mention The Irrigation Age.



American Ingot Iron



Corrugated Culverts

And Inverted Siphons

are of immense assistance in the work of the Irrigation Engineer.

The development of irrigation projects very often includes the building and maintaining of streets and roads, and the unequalled Convenience, Effectiveness and Durability of this type of culvert make it the logical choice of energetic and far-seeing men.

In the form of the Inverted Siphon, Corrugated American Ingot Iron Pipe is ideal for the purpose of carrying the water of an irrigation canal or natural stream under a highway or railroad. The corrugations raise a ripple in running water which serves to keep silt in

suspension, and corrugated pipe is consequently more easily kept free from sediment than a smooth construction.

American Ingot Iron (Armco Brand) is the *Purest* and therefore the most *Durable* in all exposed situations.

Write the nearest manufacturer for particulars and prices on American Ingot Iron Culverts, Flumes, Sheets, Plates, Roofing and Formed Products:

- | | | | |
|-------------------------------------------------------------|------------------------------------------------------|---------------------------------------------------------|-----------------------------------------------------------|
| Arkansas—Little Rock
Dixie Culvert & Metal Co. | Iowa—Independence
Independence Cor. Culvert Co. | Montana—Missoula
Montana Culvert Co. | Oregon—Portland
Coast Culvert & Flume Co. |
| California—Los Angeles
California Cor. Culvert Co. | Kansas—Topeka
The Road Supply & Metal Co. | Nebraska—Lincoln
Lee Arnett Co. | Pennsylvania—Warren
Pennsylvania Metal Cul. Co. |
| California—West Berkeley
California Cor. Culvert Co. | Kentucky—Buechel
Kentucky Culvert Co. | Nebraska—Wahoo
Nebraska Culvert & Mfg. Co. | South Dakota—Sioux Falls
Sioux Falls Metal Culvert Co. |
| Colorado—Colorado Springs
Col. Ingot Iron Pipe & Fl. Co. | Louisiana—New Orleans
Dixie Culvert & Metal Co. | Nevada—Reno
Nevada Metal Mfg. Co. | Tennessee—Nashville
Tennessee Metal Culvert Co. |
| Delaware—Clayton
Delaware Metal Culvert Co. | Maryland—Havre de Grace
J. N. Spencer. | New Hampshire—Nashua
North East Metal Culvert Co. | Texas—Dallas
Atlas Metal Works. |
| Florida—Jacksonville
Dixie Culvert & Metal Co. | Massachusetts—Palmer
New England Metal Cul. Co. | New Jersey—Flemington
Pennsylvania Metal Cul. Co. | Texas—El Paso
Western Metal Mfg. Co. |
| Georgia—Atlanta
Dixie Culvert & Metal Co. | Michigan—Bark River
Bark River Bridge & Cul. Co. | New York—Auburn
Pennsylvania Metal Cul. Co. | Texas—Houston
Lone Star Culvert Co. |
| Illinois—Bloomington
Illinois Corrugated Metal Co. | Michigan—Lansing
Michigan Bridge & Pipe Co. | North Carolina—Greensboro
Dixie Culvert & Metal Co. | Utah—Woods Cross
Utah Culvert Co. |
| Indiana—Crawfordsville
W. Q. O'Neall Co. | Minnesota—Minneapolis
Lyle Corrugated Culvert Co. | North Dakota—Wahpeton
Northwestern Sheet & Iron Wks. | Virginia—Roanoke
Virginia Metal & Culvert Co. |
| Indiana—Princeton
W. Q. O'Neall Co. | Minnesota—Lyle
Lyle Corrugated Culvert Co. | Ohio—Middletown
American Rolling Mill Co. | Washington—Spokane
Spokane Cor. Cul. & Tank Co. |
| Iowa—Des Moines
Iowa Pure Iron Culvert Co. | Missouri—Moberly
Corrugated Culvert Co. | Ohio—Corrugated Culvert Co. | Wisconsin—Eau Claire
Bark River Bridge & Cul. Co. |
| | | Oklahoma—Shawnee
Dixie Culvert & Metal Co. | Wisconsin—Madison
Wisconsin Culvert Co. |

Don't Dread Drought!

Why depend upon the uncertainties of nature?

The prospect of rainfall is a gamble.

Your crops need water—a certain quantity of it. **BUT MORE**, they need it at certain particular periods; if they do not get it, **YOU LOSE!**



Take Out *Insurance* on Your Rainfall!

“THE DEANE OF HOLYOKE” *Irrigation Pumping Equipment*

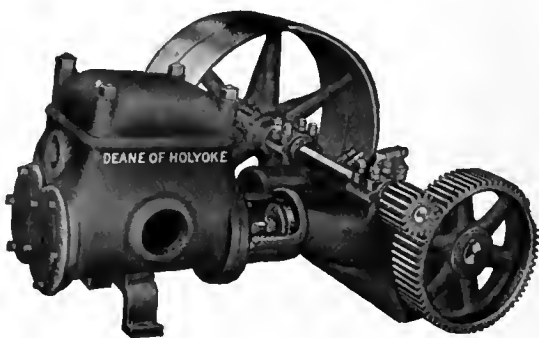

Will give you one less thing about which to worry—an unfailing water supply makes crops more sure.

Bulletin *D230-89* tells more about it.

Write us for a Copy.

The Deane Steam Pump Company

115 Broadway, New York

::

::

Works:—Holyoke, Mass.

Branch Offices in Principal Cities.

D 272-8

CARBO FLEXIBLE STEEL POSTS
 Anchor direct in earth. Flexible line posts. Stiff corners. No concrete and no special tools. **FREE Booklet**
CARBO STEEL POST COMPANY
 179 10th Street, Chicago Heights, Ill.



Fairbanks-Morse Irrigation Machinery

TO MEET ALL CONDITIONS

Oil Engines, Electric Motors, Windmills, Power Pumps, Centrifugal Pumps, Deep Well Pumping Outfits



Irrigating Alfalfa with an 8 H.P. Fairbanks-Morse Oil Engine and Centrifugal Pump

WRITE us fully stating size of track, kind of crops and depth at which water can be had. We will submit proposition and specifications on Outfit best adapted for the service. Irrigation Catalog No. IN650 will be sent on request.

FAIRBANKS, MORSE & CO.

NEW YORK

CHICAGO

SAN FRANCISCO

Send \$2.50 for The Irrigation Age 1 year, and the Primer of Irrigation

GALVANIZED METAL IRRIGATION FLUME (Newcomb Patent)

Made entirely of rust-proof, galvanized iron. No bolts or rivets used in construction. This flume is considered by experts to be the most serviceable equipment for the purpose on the market. A careful examination of the construction as shown herewith will convince those who are acquainted with irrigation conditions of its lasting quality and the ease with which it may be put together. Complete information, with prices, will be furnished on application to the



Section of Flume

KLAUER MFG. COMPANY, Dubuque, Iowa



The Farm Burden Bearer

YOU and your farm wagon spend a great deal of time together. Of all farm tools it is your standby. Its wheels bear the burden of big loads—towering racks of hay and grain, sacks of produce, loads of sand and gravel, anything that needs moving, over miles of roads to market. It takes solid strength to stand up long under that. When next you ride on a load, listen to the constant racking, creaking, groaning sound of the wagon box, wheels and running gear as the load pitches back and forth over the road ruts. Not an unpleasant sound, but the

strain that causes it is hard on the wagon. I H C wagons—

Weber Columbus

New Bettendorf Steel King

give the buyer the most he can get for his money because they defy hard usage for the longest time, and are easiest on the horses.

This makes I H C wagon reputation: Selection of the finest grades of lumber, oak, hickory and pine, and of the best quality steel and iron; many months of toughening air-drying for every piece of wood; skilled assembling of parts, fitting of bolts and rivets, and perfect shaping and ironing; application of the purest paint to act as wood preservative and to prevent shrinking and warping of the wood. When the wagon is ready for the farmer, it is practically perfect in every detail and thoroughly up to the I H C standard.

And there are many other reasons we have not room for here why I H C Wagons are the best to buy. Weber and Columbus wagons have wood gears; New Bettendorf and Steel King have steel gears. A visit and a talk at your local dealer's, where the wagons may be seen and studied, will soon convince you as to the wagon you want. Get catalogues from the dealer, or, write the nearest branch house.



WESTERN BRANCH HOUSES: Denver, Col.; Helena, Mont.; Portland, Ore.; Spokane, Wash.; Salt Lake City, Utah; San Francisco, Cal.

International Harvester Company of America

(Incorporated)

CHICAGO

U S A



When writing to advertisers please mention The Irrigation Age.

UNION MACHINES WITH PUG MILLS COMBINED

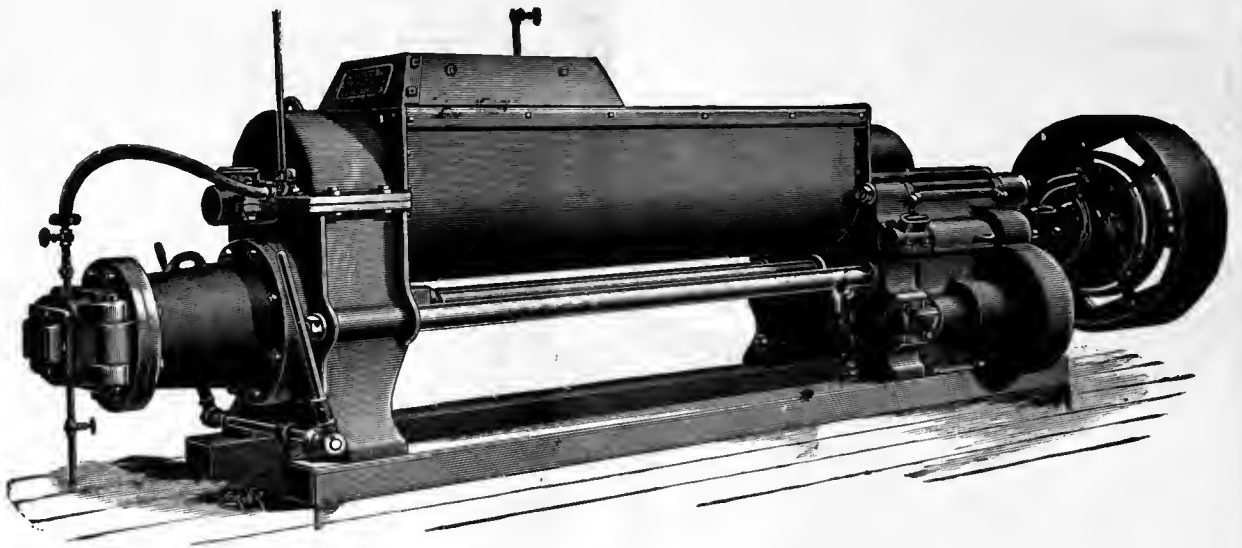

FIVE SIZES ALL CAPACITIES

Outfits for Drain Tile, Hollow Ware, Building
and Paving Brick and other Clay Products

If interested write us for particulars and estimates.

E. M. FREESE & CO.
GALION, OHIO

IRRIGATION FROM WELLS



An Arkansas Installation. Layne Patent Screen and Patent Enclosed Line Shaft Centrifugal Pump.

With the twenty-three hundred successful working plants using our system of irrigation, which inoculates and energizes the dormant forces, there is now being produced in previously non-productive districts throughout the United States and in portions of Europe and Asia over eleven million dollars worth of FOOD PRODUCTS ANNUALLY. That our system is not an experiment is forcibly demonstrated by the fact that much of this production is from localities which were arid and barren previous to the introduction of our system.

Write for new catalog.

LAYNE & BOWLER COMPANY

Address nearest office.

The World's Largest Water Development Company

Houston, Texas

Memphis, Tennessee
Welsh, Louisiana

Stuttgart, Arkansas
Plainview, Texas

Jackson, Mississippi

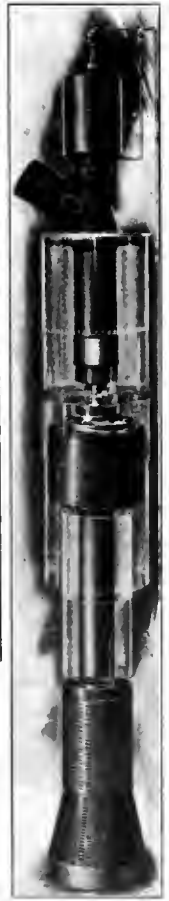

Can You Afford to Support Horses?

THOMAS A. EDISON, the wizard of inventors, says, "The horse is the poorest motor ever built." When you stop to think of it, the horse is about the most costly and wasteful thing at work for a farmer. At best his working time averages only about six hours a day, eighteen hours he rests, yet he eats all year round, working or idle. He eats ten pounds for every hour he works. One acre out of every five plowed goes to feed the horse. The best horse may get sick; when, besides losing his work, you have veterinary bills to pay. When he dies, you have a heavy loss. Since McCormick built his first binder, the tendency of all farming has been away from slow man- and horse-power and toward time- and money-saving machines. Thus far, wherever an

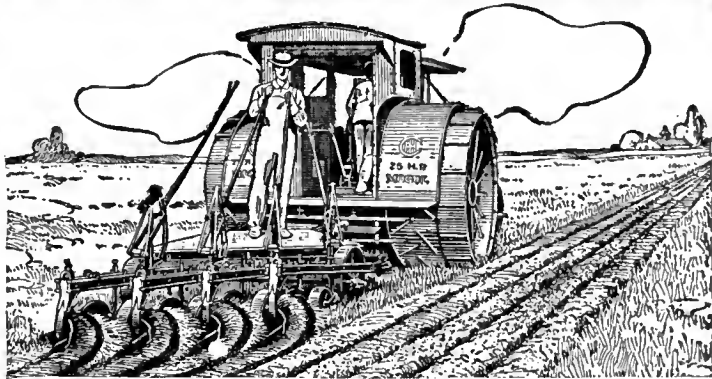

I H C Oil Tractor

has been set to work on a farm, no machine has taken the place of so many horses, or done so much laborious work with so large a saving of time and money. I H C tractors have revolutionized farming. If the owner desires, his tractor will plow nearly as much in a day of twenty-four hours as a team of horses plows in a month. There is efficiency for you!

Whether you use it for pulling field machines,

hauling your produce, threshing, cutting ensilage, baling hay, or anything else, the I H C tractor will stand up to the work. In simplicity and strength of construction, ease of operation, durability, and all-around economy, you cannot find the equal of I H C tractors. They are made in all styles and in 6-12, 7-15, 10-20, 12-25, 15-30, 25-45, and 30-60-horse power. The I H C engine line also includes general purpose engines, ranging from 1 to 50-horse power and operating on various fuels.

It will be to your advantage to get acquainted with the I H C tractor. See the local dealer, and write for facts and information to the nearest branch house.

WESTERN BRANCH HOUSES: Denver, Col.; Helena, Mont.; Portland, Ore.; Spokane, Wash.; Salt Lake City, Utah; San Francisco, Cal.

International Harvester Company of America

(Incorporated)

Chicago

U S A



When writing to advertisers please mention The Irrigation Age.



WE SHALL be glad to mail anyone who wishes same, our free catalog. We sell our product through dealers and jobbers entirely and solicit inquiries from all dealers. Our goods are well and favorably known. They are standards in the United States Army and several other departments of the government.

Gold Medal Camp Furniture Mfg. Co.
 Racine, Wis., U. S. A.

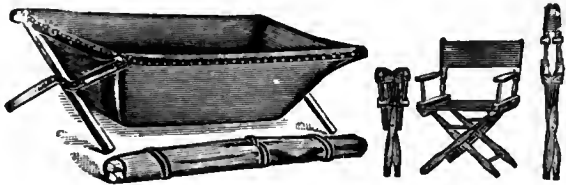

No matter where you live or what your seeding conditions are, you can get a SUPERIOR GRAIN DRILL that will fill the bill and do your work in the best possible manner. Superior Drills are made in all sizes and every style. Every Superior Drill is sold under a warranty that absolutely protects the buyer. Send for catalogue. Read it and go to your local dealer and insist on seeing the Superior Drill.

AMERICAN SEEDING MACHINE CO., (Inc.)
 Springfield, Ohio

GRAIN DRILLS

PAYS FOR ITSELF IN ONE MONTH



and Keeps on Saving You Money at the Same Rate Thereafter.

THE RECLAMATION DITCHER

Cuts Canals and Laterals for less than any other machinery—because it plows the dirt out with *One Continuous Sweeping Motion*.

We guarantee the cost per yard and prove it before you buy.

The J. D. Adams Mfg. Co.
 Indianapolis, Ind.



Delays Pay No Dividends. Mail This Coupon Today.

The J. D. Adams Mfg. Co., Indianapolis, Ind.

Below are descriptions of our proposed ditches. What will it cost per cubic yard to make them with the Reclamation Ditcher?

Length	Width in Bottom	Average Depth	Maximum Depth	Minimum Depth	Slope of Sides	Character of Soil

Name _____ Address _____

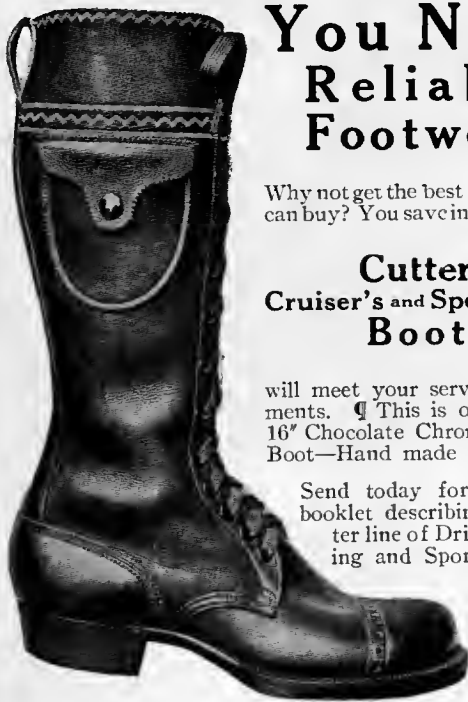

You Need Reliable Footwear

Why not get the best your money can buy? You save in the long run

Cutter's Cruiser's and Sportman's Boots

will meet your service requirements. ¶ This is our No. 106 16" Chocolate Chrome Sporting Boot—Hand made throughout.

Send today for illustrated booklet describing the Cutter line of Driving, Cruising and Sporting Boots.

*It
Will Pay
You*

A. A. Cutter Company

Eau Claire, Wisconsin

SAMSON TURBINE



When the PUMP cannot be direct connected to the turbine shaft, the power is usually transmitted by gears, shafting, etc. On account of the HIGH SPEED of the SAMSON, for a given power, lighter and consequently CHEAPER transmission machinery can be used.

JAMES LEFFEL & CO.

Springfield, Ohio, U. S. A.

316 Lagonda Street

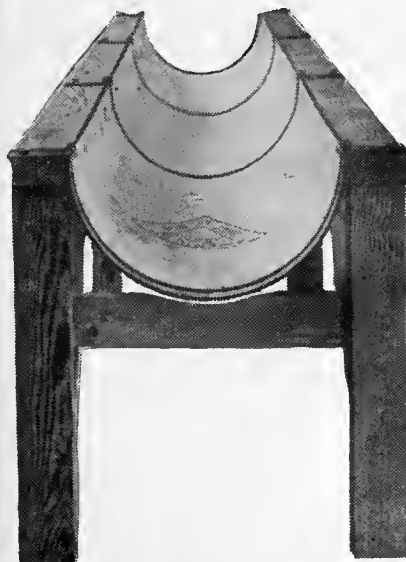

—THE— Lennon Metal Flume

(Patented)

MADE FROM

American Ingot Iron

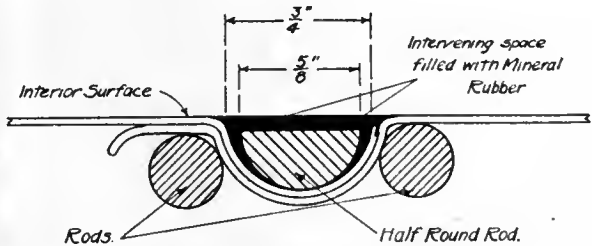

~ Cross Section of the Lennon Metal Flume Joint ~

~ Actual Size ~

Is the Easiest and Quickest to Erect ¶ Perfectly Water-Tight and Efficient, and, by reason of the Unequaled Purity of its material, of the Longest Service Life. ¶ The illustrations give an idea of the perfect simplicity and effectiveness of the construction. ¶ No Cross Bars are necessary on, the small and medium sizes, and but few on the larger.

Write for Full Information to

THE LENNON FLUME COMPANY

California—Los Angeles and West Berkeley
California Corrugated Culvert Co.

Colorado—Colorado Springs
Lennon Flume Company

Nebraska—Wahoo
Nebraska Culvert & Mfg. Co.

Oregon—Portland
Coast Culvert & Flume Co.

Montana—Missoula
Montana Culvert Co.

Texas—El Paso
Western Metal Mfg. Co.

Houston
Lone Star Culvert Co.

South Dakota—Sioux Falls
Sioux Falls Metal Culvert Co.

Utah—Woods Cross
Utah Culvert Co.

Washington—Spokane
Spokane Corrugated Culvert & Tank Co.

This Book Shows How to Plan a Private Irrigation Pumping Plant



It also shows all of the various types of pumps to meet the conditions found in different localities, tells how to select the proper pump for your conditions, how to determine the amount of power you

will need and all the other things the irrigator needs to know.

One will be sent free on request as long as they last. Write today

THE GOULDS MFG. CO.
LARGEST MFR. OF PUMPS FOR EVERY SERVICE

174 Fall Street, Seneca Falls, N. Y.
Branches in All Principal Cities

IRRIGATION DITCHES

Cheaply and Properly Made with a

Rural Road Grader and Ditcher



Cutting V-Bottom ditch on Slope of 1½ to 1.

The successful irrigation ditch or lateral must be cut clean, with slopes smooth and undisturbed. This machine was especially designed to meet these requirements. One horse and wheel traveling in point of ditch, the other outside the bank of earth. Operated by one or two men and two or four horses.

If you have an irrigation problem to solve, do not fail to write for full information concerning this Combined Grader and Irrigation Ditcher.

Address

C. D. EDWARDS, Albert Lea, Minn.

That Red Ball on the Knee of a Rubber Boot Means Dry Feet for Days and Days



Days' Wear — that's the way to judge the worth of Rubber Footwear. The number of days' wear and not the price is the true test of a boot.

We say this fearlessly because we know that "Ball-Band" Rubber Foot-

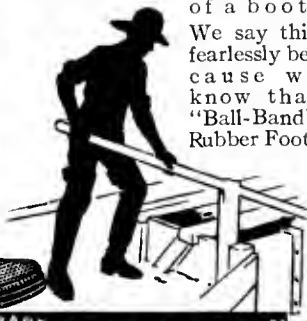

"BALL BAND" TRADE MARK

wear gives more days' wear for dollars invested. Eight million men wear "Ball-Band" Rubber Footwear. Look for the Red Ball in buying. If it is not on the goods you are not getting "Ball-Band" quality. 45,000 dealers sell "Ball-Band." If your dealer can't supply you, write us. Write anyway for Free Illustrated Booklet about "Ball-Band" Rubber Footwear.

Mishawaka Woolen Mfg. Co., 346 Water Street, Mishawaka, Ind.
"The House That Pays Millions for Quality"

The Faithful Friend

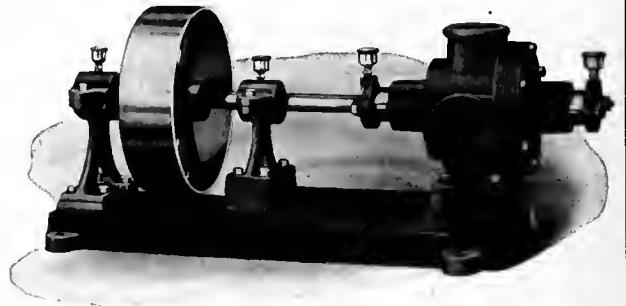

Do not be contented until you have the best, as these pumps have a good suction lift, with capacities of 12 to 500 gallons per minute, automatic take-up for wear, and free from springs or small parts that cause trouble.

SEND us your pumping proposition today, and let us quote you on the best pump made

Blackmer Rotary Pump Power & Mfg. Co.
PETOSKEY, MICHIGAN

THE IRRIGATION AGE

VOL. XXIX

CHICAGO, FEBRUARY, 1914.

No. 4

THE IRRIGATION AGE

With which is Merged

The National Land and Irrigation Journal

MODERN IRRIGATION
THE IRRIGATION ERA
ARID AMERICA

THE DRAINAGE JOURNAL
MID-WEST
THE FARM HERALD
THE IRRIGATOR

D. H. ANDERSON
PUBLISHER,

30 No. Dearborn Street, CHICAGO
Old No. 112 Dearborn St.

Entered as second-class matter October 3, 1897, at the Postoffice at Chicago, Ill., under Act of March 3, 1879.

D. H. ANDERSON, Editor

ANNOUNCEMENT.

The "Primer of Hydraulics" is now ready; Price \$2.50. If ordered in connection with subscription \$2.00.

The First Big Victory

The inauguration of the department of THE IRRIGATION AGE devoted to the interests of the Federal Water Users has already brought one very important result for the project farmers. The Reclamation Record will be delivered free of charge in the future to all Water Users who may apply for it.

This is just. It should have been done from the beginning. The Water Users have to pay for the publication of this document, and the bill is no small item at the end of each year; therefore they should obtain some benefit from it.

Statistician Blanchard, who has drawn a handsome salary for many years as publicity agent of the Reclamation Service, having failed to arouse much enthusiasm, the entire Reclamation Commission has now joined in trying to induce the Water Users' associations to become interested in this publication, for which they are forced to pay the bills. They have asked all the organizations to contribute news and views each month to the Record and have even created an "Open Forum." No personalities in the latter department, however, will be permitted. That is wise.

Except for highly enlightening boosts for F. H. Newell, A. P. Davis or some other prominent pay-

SUBSCRIPTION PRICE
To United States Subscribers, Postage Paid, \$1.00
To Canada and Mexico, 1.50
All Other Foreign Countries, 1.50
In forwarding remittances please do not send checks on local banks. Send either postoffice or express money order or Chicago or New York draft.

Official organ Federation of Tree Growing Clubs of America. D. H. Anderson, Secretary.

Official organ of the American Irrigation Federation. Office of the Secretary, 212 Boyce Building, Chicago.

Interesting to Advertisers.

It may interest advertisers to know that The Irrigation Age is the only publication in the world having an actual paid in advance circulation among individual irrigators and large irrigation corporations. It is read regularly by all interested in this subject and has readers in all parts of the world. The Irrigation Age is 28 years old and is the pioneer publication of its class in the world.

roller, the Record has long been our most popular publication for dry reading. Under the reformed editorial policy, Hints for the Lovesick, fashion notes and highly exciting continued stories may be expected in the campaign to make it popular with the farmers. We favor all this and more. If the project settlers have to pay the bills of this publication, why not make it a paper in which every member of the family can find something interesting.

Increasing Scarcity of Land

It is not surprising that out of the very general discussion of the past few years of the conservation of natural resources there has come to be a clear recognition on the part of the public that this is no longer a country with an unlimited supply of land. What is surprising is that the demand for land so heavy for thirty-five years or more, the growing scarcity of it should not have been earlier recognized. The fact is that there is no longer a large area of homestead land worth the taking, and there is no longer any very cheap land worth the buying. Land has finally come into its own.

More and more agricultural intelligence is being directed, not to the exploitation of new lands, but to the wise development of those now under cul-

tivation. In all the great agricultural colleges, and in the innumerable county agricultural schools that are springing up, especially in the middle west, teaching centers around the conservation of soil properties chiefly. In other words there seems now to be a general recognition of the fact that in the future agricultural development means intensive and scientific cultivation rather than increase in acreage.

This attitude of the country toward agriculture means more to those of us who are interested chiefly in irrigation than at first appears. It means among other things that irrigation having passed the speculative and promotive stage, is now to have the opportunity to make good. Because of the failure of several unworthy ventures, there has been a feeling among those away from the irrigated sections that there was something unreal and uncertain about a good many big irrigation enterprises, and the high values placed upon irrigated properties seemed unreasonable. But with land in the Illinois corn belt selling at \$250 an acre and many dairy farms in Southern Wisconsin bringing \$200 an acre, it is made clear to the average mind that land is land, if it can raise big crops.

There never has been a time when western irrigated lands, connected with reliable irrigation projects, could attract the attention of well-to-do and intelligent farmers in non-irrigated sections as effectively as they can now. The more men study intensive farming and soil possibilities the more clearly will they see that in the irrigated sections of this country these have been brought to their highest perfection.

Can Lane Swing Enough Votes

So far as the western members of Congress are concerned, it looks as if they are almost unanimously in favor of extending the payments for water on the Federal irrigation projects so as to cover a period of twenty years. Senator Wesley L. Jones, one of the real leaders of the Republican minority in the senate, declares in an interview in this issue of the AGE that he thinks such a bill can be passed, if Secretary of the Interior Lane and the Congressional committees can agree upon some measure.

The votes of the west will not, however, pass this bill, so important to the water users—a bill which if drawn in a fair and equitable manner assures almost to a certainty the success of the individual farmers and of the great projects, in which more than \$100,000,000 of government funds have already been invested. It is, therefore, up to Secretary Lane and the administration leaders to swing enough votes to pass this bill. Will Mr. Lane do

this? Will he offer arguments sufficiently convincing to induce the President to whip enough Eastern and Southern Democrats into line to pass a bill such as the settlers want? This will be no easy task, for in Washington today, the east and the south are aligned against the west. Witness the tariff bill. Upon careful analysis it is asserted that eighty percent of the products of New Jersey are still to be found on the dutiable list, whereas but nine percent of the products of Arizona and twelve percent of those of Nevada are so favored.

But no matter how hard the task, we do not believe Mr. Lane will falter. We believe he will staunchly and vigorously demand that justice be done to the Federal Water Users, and despite some ill-advised plans he is now advocating in the Smith bill, that he will win the relief measures for them. With the aid of such men as Senator Jones of the opposition party he should not fail.

Secretary Lane has already shown a far greater interest than some of his predecessors in the human side of this vast problem. He has shown strong inclinations to aid the settlers in every way possible and has already done so in many ways. He is a western man; he knows the difficulties of pioneering and his word should carry unusual weight with Congress.

And he has the backing and well wishes of every Federal Water User in this fight.

Federal Water Users' Department

THE IRRIGATION AGE has battled fearlessly for years for justice for the farmers on the Government irrigation projects. It has made some bitter enemies in high places in the Reclamation Service because it has dared to tell the truth and because it has vigorously demanded competent men to supervise and handle this great work. THE AGE intends to continue this policy with even more vigor. In the January issue of THE AGE we presented to our readers a department devoted exclusively to the interests of the Federal Water Users. This department is edited by George J. Scharschug, who for many years has been a close student of Federal reclamation matters. As a newspaper correspondent Mr. Scharschug has traveled over the West from end to end, visiting every Government project at least once, thus gaining at first hand knowledge of those matters of which he writes. He is already widely known as a writer on these topics, his articles having appeared in various magazines and newspapers. He was also formerly editor of the Country Land Department of the Chicago Record-Herald. Mr. Scharschug has been placed in charge of this department with but one admonition—tell the truth. We are confident

because of our long acquaintance and friendship with him and of our knowledge of his past work, that he will tell the truth and in good, plain English. He will permit no soft-tongued publicity man or statistician of the Reclamation Service to bunko him; he will not be bulldozed by any high and mighty official of Washington; he will not be swayed by those who throw discretion to the winds and demand foolish things of the United States Government, but he will write without fear and without favor, hoping only to benefit those hardy men and women who are struggling to build up homes for themselves out in the desert West, through the aid of Government irrigation. THE AGE believes this department will prove of real help to the Water Users.

**Secretary
Lane's
Difficult
Position**

The farmers and water users under reclamation projects, judging from a declaration of policy made by Secretary Lane during the hearing at Washington, also at the meeting of

governors in Colorado, and a reiteration on his return to Washington, following a visit to nearly all of the projects, were of the opinion that under this administration a plan would develop which would allow them such leniency in payments as to make it possible, with reasonable endeavor, for each settler to live comfortably and come "into the clear" before old age and its attendant infirmities precluded the possibility of the peaceful enjoyment of the results of his efforts. They expected that a fixed and definite policy would be adopted in the interpretation of the Reclamation Law whereby uncertainty, which is retarding the development of the projects, would be avoided.

The settlers expected also a curtailment of the large number of officials and office help employed, in many of the cities throughout the West, whose salaries eventually come from the labor of these settlers.

It was also hoped that there would be fewer of the bureaucratic red tape methods employed.

THE IRRIGATION AGE has fought for years in an effort to protect the settler, particularly in the matter of methods used in the organization of water users' associations, and its editor is heartily in sympathy with the effort of these associations to obtain the powers they seek, to have a defined purpose and to avoid being treated as a whole like departmental nuisances by that branch of the Government that compelled their organization.

It was the opinion of members that each association would be given power to make their collections for the Government not only for charges due the Government, but for its own expenses as well; it

was the opinion of the officers of each association that they would be given some voice in the operation and maintenance of their projects, and that their recommendations would have the weight to which they are entitled.

The settlers have believed that their Water Users' associations would be encouraged and given authority to operate and maintain marketing establishments, that they would in some way be enabled to utilize their almost perfect organization to carry out some scheme of farm credits, adopted after some of the European systems, Americanized to suit their particular conditions. They expected in this manner to be enabled to develop their water power and other public utilities, and have hoped that the Government, by doing these things, would be relieved of the unrest and criticism of bureaucratic rule, as it would place nearly all these matters of operation in the hands of those who are paying for the works, thus placing the burden upon the people, where it belongs.

They also expected a constructive administration in these matters, in so far as it was in the power of the secretary to grant, and when he did not have this power they had expected his aid and the aid of the administration in the enactment of such laws as would make these things possible.

When the settlers and land owners of Federal projects conveyed their lands to the Water Users' associations in trust to be sold in accordance with the terms of the act, and subscribed for stock, and when those corporations entered into solemn contracts, agreeing to guarantee the payment of the estimated cost of the project, and when the private land owners and entrymen made application for water and were issued water right certificates upon the payment of a specified sum, being their pro rata portion of the estimated cost, they had confidence in their Government, and believed that the people would see that its obligations were carried out.

Gradually it began to appear by public notices and orders issued by the successive secretaries of the interior that these contracts, obligations and representations on the part of the Government were considered as naught, and no order, public notice or the law itself has ever been interpreted, in the common acceptance of the meaning of the English language. Consequently it is not strange that the air has been charged with unrest and dissension in regard to the service, it being expressed in open declarations that engineers were not fit for operation after the works were completed.

With all these things in mind, the settlers have been patiently waiting, full of hope for the future, that in the new administration they would now realize the dreams expressed in the spirit of the

Reclamation Act; that it would be demonstrated that this class of constructive legislation was a success.

In this state of mind it can easily be imagined how the settlers will feel when they are asked to surrender their present contracts and consent to the payment of an uncertain sum for their water, which they know will be largely in excess of the present water charge. Secretary Lane, with great beauty of language, filled with sympathetic notes, has explained how he expects his plans to work out as shown in his letter, to be found in another portion of this issue. While at this time he has the unshaken confidence of all water users, and could he remain as secretary of the interior for all time there is no doubt that justice would eventually be done, it, however, is the general opinion that it will be long delayed. We fear he will have a hard time to explain the actual situation through sympathetic letters or otherwise.

Facts About Rural Credits

President Wilson has asked Congress to follow up the passage of the currency bill with early legislation on rural credits. The President seeks a law by which the farmers of the nation can obtain money with which to handle their crops more easily than at present. President Taft inaugurated along practical lines this movement for rural credits by the appointment of a special commission to investigate the various systems now in use in Europe, and congress will have a wealth of information upon which to work once it takes up the farmer's financing.

There is no legislation contemplated of more importance to the nation than the rural credit law, and it stands out as of utmost importance to the settlers on the national irrigation projects. One of the biggest handicaps of the homestead irrigators, nearly all of them men and women with little capital, has been inability to borrow money with which to carry on the development of their lands. The government project settlers are particularly handicapped because they cannot obtain title to their lands until they have paid in full to the government for their water rights. Therefore, their real estate is of no value as security for loans.

The executive committee of the National Federation of Water Users' Associations has devoted a great deal of time to the study of rural credits as means of helping the government project irrigators. There are several plans in operation in Europe, which are successful, but the one which now seems most feasible to some members of the executive committee is that of "farmers' banks."

Under this system, a national law provides for the organization of "farmers' banks" with five or more members in a community or district. The membership is upon a copartnership liability basis. That is, each member becomes responsible to the full extent of his property holdings for the acts of his fellow members. Such a bank can loan money,

under the law, only to its own members. All farmers in the district, which it serves, can, however, apply and under proper conditions obtain membership, thereby getting the right to borrow money. The rate of interest is limited and the conditions of each loan are stringent. Loans are made only for specific and creative purposes. The borrower must state fully in his application for a loan for what he desires to use the money—leveling a new piece of land, additional ditching, seeding, harvesting a crop or constructing new buildings. Any diversion of the borrowed money to any other purpose than that stated in the application for the loan makes the loan due immediately and its payment can be enforced by process of law.

The "farmers' banks" are authorized to receive deposits from any person. These deposits are secured by the partnership liability of the bank members and are backed by the government. Sectional government banks or depositories receive and care for the surplus deposits of "farmers' banks," and all are under the supervision and control of the national banking department.

Careful investigation has convinced the officials of the water users' federation that a plan along this line can be worked out on the government projects, if the "banks" are made a part of the various water users' associations. The various projects are rich in latent wealth. In addition to the vast bodies of land under cultivation and being brought into development annually, the water users of nearly every project own equities in valuable water power, telephone lines, roads, machinery and other improvements worth millions of dollars. The wealth, now unavailable as security for loans for the individuals of each project is sufficient to finance all the federal irrigation settlers many times over, once it can be put to work.

It is also figured that the note of the borrower, backed by the endorsements of the members of the farmers' bank, as it would be if offered in the market, would be a most salable security. If it was short-time paper, that is for six months or less, it would be of the highest class of security under the new federal currency law. If the note was for a long time, it, with other similar notes, would, say those who have studied the subject carefully, furnish proper and suitable backing for bond issues, paying a rate of interest which would make them attractive on the various exchanges.

When it is realized what has been accomplished toward creating easier loans for the farmers in other nations and when it is fully recognized that no farmers in the world are more certain of their crops each year than those on the government irrigation projects, a solution of this big problem seems quite easy. It will be easy, once congress is thoroughly aroused to its necessity and its possibilities.

It is a subject to which every water users' association should give closest attention. Several bills, including one introduced by Senator Fletcher of Florida, which may be the administration measure. The western congressmen must be stirred to action to a man. They should be thoroughly awakened so that the Federal project settler will be taken care of in this rural credit legislation.

THE FEDERAL WATER USERS

A Department Devoted to the Interests of the Farmers on the
Government Irrigation Projects

Edited by Geo. J. Scharschug

THE RECLAMATION EXTENSION BILL.

Every Federal Water User Should Study This Bill.

Secretary of the Interior Lane's new Reclamation bill has been introduced in Congress. It is known as H. R. 11906 and is sponsored by Representative William R. Smith of Texas.

The bill proposes to extend the period in which water right charges on the government irrigation projects may be paid to not less than twenty years. That is the only attempt to grant a request of the National Federation of Water Users' Associations, and of various individual associations, which it makes.

It, however, proposes to confer upon the Secretary of the Interior very extensive and drastic powers, under which he can carry out his plans for readjustment and regulation of the projects. These powers include the right to modify and abrogate contracts with the water users and their associations. The bill also provides various forms of penalties, which may be inflicted upon water users for failure to conform to rulings concerning the size of farm units and the handling of these farms, in the manner prescribed by the secretary, and for failure to pay water charges. It provides for a determination of the charges per acre for water on each project, legalizes the "renting system" under which several projects, not formally opened, have been operated, and offers a method, under which it is proposed that settlers shall dispose of holdings in excess of the prescribed farm unit.

These and other powers conferred by the bill are phrased in the most broad and general language.

As the bill proposes settlement for all time of the construction charges on the various projects, it becomes a matter of dollars and cents with the settlers. It is a bill which must of necessity touch the pocketbook of every federal project farmer.

Secretary Lane has written a letter to each Water User, explaining in detail what he hopes to accomplish under this bill. The letter shows far more thought than most documents concerning Government reclamation which have been issued by various Secretaries of the Interior. Secretary Lane shows himself at heart in sympathy with the Water Users and anxious to help them out of their difficulties.

We believe, however, that on several features of this bill, which will at least form the basis of any Reclamation legislation at this session of Congress, he has been very badly advised. We print the bill in full, as well as the secretary's letter, and urge every Federal Project Water User to study both documents with great care, comparing one with another.

Officials of the National Federation of Water Users' Associations have already asked Congress for hearing on this bill. It is right and just that this hearing should be granted, and we believe it will be.

The time has come to settle once and for all the never-ending question of project costs; the uncertainties concerning the size of farm units; the question of how long and to what extent the present vast bureaucracy of Federal employes, drawing salaries from the Water Users, shall be continued. All these matters are questions of dollars to the settlers. These problems should be settled by cool, careful deliberation, by fair and just adjudication or arbitration and with justice to both the Government and the settlers.

The Basis of 1914 Irrigation Legislation

Here is H. R. 11906, the bill introduced in the House by Representative Smith of Texas, which is to be at least the basis of legislation concerning Federal Irrigation Projects during the present session of Congress. Read it carefully. It is entitled, "A Bill for the Extension of Time under the Reclamation Act, and for other Purposes:

"Be it enacted by the Senate and House of Representatives of the United States of America in Congress assembled, That this Act may be referred to as the reclamation extension Act and that the term 'Reclamation law' as hereinafter used shall refer to the reclamation Act of June seventeenth, nineteen hundred and two (Thirty-second Statutes, page three hundred and eighty-eight), and acts amendatory thereof or supplementary thereto. The period of payment for water users under the reclamation law who continuously comply with the provisions thereof shall be a total of at least twenty years, including the years in which water was available for the land of each from irrigation works owned, controlled, or operated by the Reclamation Service under public notice, on a rental basis or otherwise. The Secretary of the Interior is hereby authorized, with the consent of the parties affected, to abrogate or modify any contract regarding water rights or any water-right application under the reclamation law, or any public notice issued under said reclamation law, and to proceed in all respects as if no such contract or water-right application had been made or no such notice issued.

"Sec. 2. That in order to secure the benefits of this Act, water-right applicants shall be subject to such regulations as the Secretary of the Interior may prescribe regarding the following matters and others heretofore authorized by the reclamation law:

"(a) Regarding the area per holding to be prepared for irrigation, planted, cultivated, and

THE CALL TO ARMS

THE following message was sent by Scott Etter of Carlsbad, N. M., secretary of the Pecos Water Users' Association, to all Water Users' associations, concerning the Smith Reclamation Extension bill:

Congressional bill on passage very vital to Water Users. Members of the National Federation of Water Users' Association will be in Washington next week to present amendments to the bill as drawn. The bill as it stands is fatally defective to all. Send representative if possible to assist Federation officials. If possible, telegraph F. H. Sears, National Life Building, Chicago, how much financial aid you can contribute to keep representatives in Washington to present our cause. Give the National Federation authority to act for you. Bill may be placed on final passage in House in about ten days unless we act.

irrigated each year. Failure to comply with any such regulation shall authorize an increase of all charges for building, operation, and maintenance, and drainage by way of penalty not exceeding ten per centum for each year of such failure;

"(b) Regarding prompt payment of all charges, the addition to each annual charge of not exceeding five per centum for collection, a rebate of such additional charge if paid on or before the due date, and a penalty not exceeding one per centum each month thereafter during which the charge remains unpaid;

"(c) Regarding credit for the amounts paid before becoming subject to this Act, on account of the building and drainage charges, and the adjustment of future payments, their amount, and the time when the first thereof shall become due;

"(d) Regarding an increase of each annual charge by not exceeding fifteen per centum if water-right application is not made within one year after public notice permitting the filing thereof, in the case of any private landowner or of any person whose entry is not subject to the reclamation law;

"(e) Regarding suspension of the requirement of residence prescribed by the reclamation law as to entrymen or private landowners for not exceeding five years, upon compliance with such extra reclamation requirements as the Secretary of the Interior may specify; and both the entrymen and private landowners shall after such suspension reside upon the land for three years. Failure to comply with such extra requirements and with the general residence and reclamation regulations shall render the water-right application and corresponding entry, if any, subject to cancellation with the forfeiture of all moneys paid;

"(f) Regarding the method of determining the charges per acre on the several projects so as to recover all expenditures which the Secretary of the Interior shall find to be necessary for the project.

Secretary of the Interior may open to temporary rental basis prior to the issuance of notice, any withdrawn lands for which water is available.

"Sec. 4. Entrymen under the reclamation law holding more than one farm unit who make

proof of residence, improvements, and cultivation may assign the excess in accordance with the farm-unit plat under the provisions of the Act of June twenty-third, nineteen hundred and ten (Thirty-sixth Statutes, page five hundred and ninety-two), within one year after such proof and prior to the issue of patent for one farm unit or within one year after the issue of farm-unit plat if the same issues subsequent to such proof. After such period of one year the right of assignment shall terminate and the entry shall be conformed to one farm unit. No person shall hold by assignment more than one farm unit prior to final payment of all charges for all the land held by him subject to the reclamation law, except operation and maintenance charges not then due."

SECRETARY LANE'S LETTER

Secretary Lane's letter to the various Water Users' Associations concerning what he hopes to accomplish under the Smith bill and other policies which he has adopted, is as follows:

I am sending you this letter in which I discuss various questions affecting all of our reclamation projects, that you may know the effort that is being made to meet your needs. This letter requires no answer. It covers what appears to me to be some of the more important problems confronting both yourself and the Government. The question always before us is, whether or not the United States can successfully conduct a large business enterprise upon business principles without injustice to its citizens and without imposing a too heavy burden upon those with whom it deals.

It may be true that hitherto the Government has expected too much of water users, and it may be equally true that water users have expected too much of the Government. However that may be, there is surely a safe middle ground where neither shall expect too much of the other and where each shall be ready to recognize the other's due on the safe and solid basis of the needs and possibilities of the one and the fair and just compensation of the other; and all this without thought or suggestion of largess or of imposition. I would deal with you as you would deal with another, yielding nothing as charity, but dealing together as men and

brothers on the basis of what is reasonable and just. Though there may be some among you who have hoped that eventually the Government would not collect its due, I believe that most of you have never entertained a thought of escape from your obligations to the Government.

I have given many months of close personal study to the problems involved. I have visited you in your homes, in your fields and in your meetings; I have taken counsel and advice of men long in the service, of representative water users, and what follows hereafter is the result of this study, advice and serious consideration.

After personal contact with thousands of settlers on our reclamation projects, I find that we have gathered together from all parts of the United States a class of men and farmers above the average in ability and intelligence; they are generally men of high purpose, resolute, self-dependent and determined. These men are companioned by superior women. I have no sympathy with that view which attributes to you, and to your shortcomings only, whatever in your present situation may be uncomfortable or unpromising.

With the admission that the past conduct of affairs has not been unqualifiedly without error and that future policies are subject to correction when found erroneous, I think we may fairly proceed upon common ground to reason together to the end that we may now agree as to what, in the light of present knowledge, appears to be just and equitable, as between you and the Government.

The Farm Unit—The most difficult duty imposed upon the Secretary of the Interior is that of determining the "area of land necessary for the support of a family." The law wisely requires this to be done, not only to prevent speculation in lands, but in order that there shall be farms for all who desire them. By law and by tradition, 160 acres have been considered necessary for the support of a family in the United States. But land was plentiful when this unit was established, transportation was difficult and conditions of farm life burdensome. Seldom in the pioneer days was a quarter of the 160 acres farmed. There was the woodlot, the pasture and the fallow ground. Even in humid regions good farm practice retired one-half the cultivated area each year for recuperation by summer fallowing. So that 160 acres of land even in the humid prairie regions was equivalent to an annually farmed area of only 80 acres. In wooded countries the labor and cost of clearing and subduing the land was greater than in the desert regions today under irrigation, nor could the acreage subdued in one average man's lifetime equal one-half his holdings. Even today in the states of Wisconsin, Oregon, Washington, California, Alabama, Louisiana, Mississippi and in other Southern states, the cost per acre of clearing and grubbing "logged-off" timber lands is greater than the cost of reclaiming desert lands by irrigation. Much of this land is lying idle and unproductive for that reason. Few men would take 160 acres of such land conditioned upon clearing 80 acres and subduing it by cultivation within 10 years' time. So that by every measure of comparison with which I am familiar I can find no justification for a farm unit greater than 80.

acres on any reclamation project, even under the least favorable of climatic conditions. There are hundreds of thousands of citizens willing to take up farm units of 80 acres or less. Every man to whom 160 acres is given deprives some other man of a home.

I must, therefore, decline to yield to the demand from many quarters to fix farm units at 160 acres of irrigable land. In no case will I approve greater than 80 acres, except where existing contracts with private land owners made previous to my incumbency have been made upon a larger basis. The 80-acre farm unit will be fixed only in those regions where climatic, soil and market conditions make so large an area appear to be necessary, and even in such regions 40-acre tracts lying near to towns or prospective towns are deemed ample for the support of a family.

One great need of agricultural regions is agricultural laborers and artisans. If possible, I would establish a few 5 and 10-acre homesteads for such to relieve them of the disadvantages of tenantry and to encourage them to settle in the vicinity of the larger farms. The cost of reclaiming 160 acres by irrigation is too heavy a burden for the average farm family to labor under. Thousands of farmers of modest means now renting eastern lands could be located on these small tracts and could, with their labor, earn enough to pay reclamation costs and at the same time acquire a home of from 5 to 10 acres, but would probably fail if they attempted to acquire an 80, a 40 or even a 20-acre tract. The man who undertakes to pay the cost of reclaiming 160 acres must needs be a man of large capital to start with. Less is required for 80 and less for 40 acres, so that as the size of the farm unit is reduced, the number of families on the land may be increased, so also is reduced the amount of the capital required of that family to start with, and through larger population making easier many of the problems of pioneering.

In those fertile and hospitable southern regions where the growing season is almost continuous, there is no defense whatever for farm units in excess of 40 acres. In California the Little Landers are demonstrating even an acre to be sometimes enough, long ago in the citrus belt men have shown the world that 10 acres is enough. In the Salt River Valley I have recently fixed the farm unit at 40 acres and I am now besieged with demands to reconsider and fix this at 160 or some other larger unit. I cannot concede the justice of these demands nor the force of the arguments submitted. Forty acres well tilled in the Salt River Valley is larger than I believe to be absolutely necessary for the support of a family. I have conceded 40 acres, but in doing this I feel that I have virtually deprived one or more other families of an opportunity for a home on each 40. If I were to name 160 acres it would virtually be letting one family have land I believe to be sufficient for the support of several families. I believe you would not have done otherwise had you been in my position.

Though I am convinced that the farm unit should not exceed 80 acres on any reclamation project, it does not appear to me to be just that entrymen who filed on government lands subject to the Reclamation Act should be compelled to surrender their holdings in excess of the established farm unit without compensation. These men are entitled to consideration on account of the hardships they have endured while waiting for the projects to be opened and for water to be delivered, and each such should be allowed to hold one farm unit and be permitted to dispose of the remainder in such way as to fully remunerate him. But it should be required that, within one year after making proof of residence, cultivation and improvements, as required by the homestead law, or within one year after the farm unit plats have been approved, the entryman should be compelled to sell the excess land in farm units as established, or in parcels of less area. By this means every man who now claims a quarter section could retain 160 acres for one year after

(Continued on page 118)

The Men on the Firing Line

The officers and Executive committee of the National Federation of Water Users' Associations

Earl B. Smith, Somerton, Ariz.
(Yuma Project), President.

O. E. Farnham, Belle Fourche,
S. D. (Belle Fourche Project),
Secretary.

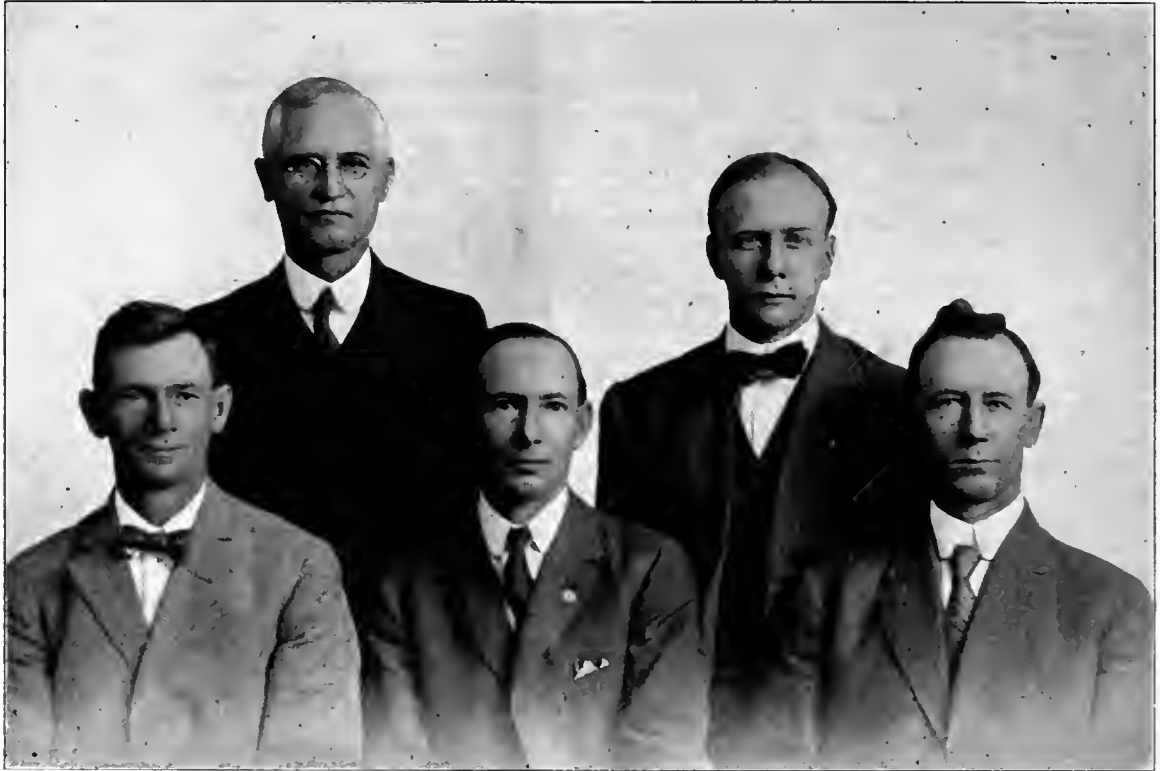

Fulton H. Sears, Fallon, Nev.
(Truckee-Carson Project).

Scott Etter, Carlsbad, N. M.
(Carlsbad project).

Geo. E. Rodman, Sunnyside,
Wash. (Sunnyside Project),
Treasurer.

FISCAL AGENTS

One of the Policies Which the National Federation is Pushing

"When requested by an association, the Secretary of the Interior should appoint such association as Fiscal Agent to collect all charges due, or to become due, the Government from entrymen and landowners and remit the same to the proper authorities under the act of Congress, approved August 9, 1912."

Around this recommendation made to Secretary of the Interior Lane by the National Federation of Water Users' Associations and representatives of other projects, not yet affiliated with the national organization, is being waged today a desperate battle to crush out the bureaucracy, called the Reclamation Service.

Upon this battle hinges the success of Secretary Lane's new Reclamation Commission. In granting or refusing this request, Water Users contend, Secretary Lane must either declare himself for democratic rule of the various Government irri-

gation projects, with the Water Users having a voice in the government, or he must place himself on record as favoring the present bureaucratic methods of governing the projects and the perpetuation of the present vast organization of high salaried men, whose salaries the settlers must pay, and who are law unto themselves.

Upon this battle hinges to a large degree the life of the Water Users' Associations, created by the government with specific purposes and duties, regularly incorporated, and to which every settler on the projects belongs. It was the announced intention and understood as the law, that these associations should, upon payment of a major part of the cost of the water rights, take over the management of the projects. F. H. Newell, chairman of the new Reclamation Commission, his numerous assistants, and various Secretaries of the Interior have spoken oft and frequently of these associations and of their importance in working out the ultimate success of Federal reclamation. These same associations are commonly styled among at least certain of those same officials today as "departmental nuisances."

Upon this battle also hangs the ultimate suc-

cess of the Federal projects, for as Mr. Newell has frequently said in the past, it is these associations which must take over the management of the completed projects, once the settlers get title to their lands and water. The Water Users insist that if they are to permit their associations to be robbed of all their functions and become mere empty shells, the associations will be in no condition to assume the management of enterprises involving the millions now invested in these great plants. If the associations are unable to do this, the projects must continue under the paternalistic management of the Government, a condition to which no independent, red-blooded American farmer can look with favor, and a condition which the project settlers declare means ultimate bankruptcy for them and failure of the projects.

The National Federation of Water Users' Associations made numerous other recommendations and suggestions for improving conditions on the projects at the suggestion of Secretary Lane. The executive committee has pushed the "fiscal agency" recommendation a little more vigorously perhaps than any of the others because while on its face it involves little money, its very heart-blood is the principle of home rule, of representation as well as taxation, and it strikes directly at the burden of the bureaucracy, from under which every settler is anxious to get.

Until late in 1912, the Water Users' associations on the various projects made all collections of annual payments and maintenance charges. These moneys were turned over to the receiver of public moneys of the land office in the district where a project was located. As a result the farmers attended the meetings of the Water Users' associations; knew their officers well; made their complaints to these men, and in turn, those complaints reached the Department of the Interior in such form as to demand and necessitate attention. The farmer's business and troubles were also those of his association, and as a result many wrongs were righted at Washington or by the local representatives of the Reclamation Service.

Then suddenly out of a clear sky, and apparently without any of the western representatives in Congress realizing its purport or far-reaching possibilities, came a new law, placing in the hands of the Reclamation Service the power to make the collections of water right and maintenance payments. No particular arguments as to the crying need for this change ever reached the ears of the water users.

Under this law, Fiscal Agents, drawing \$1,400 a year, were appointed for the various projects. On many of the projects, two of these men were installed. On others only one. The farmer must now make his payments to these agents. As with all other costs and expenses attached to a Government project, he also has to help pay their salaries.

As long as this money is to be paid out, the Water Users' associations ask Secretary Lane to name the associations as Fiscal Agents and turn the salaries, now paid to Federal employes, into the treasuries of the associations. The associations contend they are able to give sufficient bond, as they did in the past, and to handle these collections in a proper manner. With \$1,400 to \$2,800 a year, the

Water Users declare they can pay the salary of a competent secretary, who will devote his time to the interests of the settlers as well as make the collections, and thus they can keep their associations alive and prosperous and school their members in the duties which they must assume once the projects are turned over to the farmers, as provided by law.

THE BELLE FOURCHE SUIT

Commissioner O'Donnell Suggests a Plan to Adjust It

As the result of a conference between I. D. O'Donnell, Supervisor of Irrigation and member of the Reclamation Commission, and the directors of the Belle Fourche Valley Water Users' Association at Newell, S. D., at least part of the Belle Fourche suit may be adjusted out of court. Mr. O'Donnell promised to co-operate with the settlers in accomplishing this and the directors, in turn, adopted a resolution under which such negotiations may be taken up. The association will be represented by O. E. Farnham, secretary of the local organization, who is also secretary of the National Federation of Water Users' Associations. He will be assisted by K. H. Ely.

Mr. Farnham has been one of the attorneys in the suit of the Belle Fourche Water Users. This suit, begun originally in the state courts, is now in the United States District court. Mr. Farnham and his fellow attorney, Chambers Kellar, obtained an injunction from Federal Judge Elliot restraining the Reclamation officials from making any collections for water rights, betterment or operation and maintenance charges or recommending the cancellation of any homesteads for failure to pay such charges.

If permitted to go, in full, to final decision, this suit would bring definite ruling on many important questions now before the Federal Water Users. Violation of the contract between the Secretary of the Interior and the Belle Fourche association in the collection of building charges before the project is completed is charged in the complaint; extravagance in administration expenses, overhead charges, betterments and construction is also charged, and the bill of the plaintiffs further demands that the court rule on how the charges, piled up by the Reclamation office at Washington and its numerous branches, shall be apportioned.

ON THE FIRING LINE

To the five men who compose the Executive Committee of the National Federation of Water Users' Associations belongs a major portion of the credit for promised reforms and beneficial changes in the Reclamation Service. They have been on the job night and day, most of the time at their own expense, fighting for the rights and in the interests of the settlers. They have made official Washington see a "great light." Once every Federal Water Users' association becomes a member of this organization and all are contributing their pro rata share of its expenses, the settlers' interests will become of far more importance in Washington than they have in the past.

"IS NEWELL TRYING TO MAKE SERFS OUT OF THE WATER USERS?"

"Is Newell trying to make serfs out of the Water Users on the Federal irrigation projects? Are the great reclamation projects to be dedicated as temples to Mammon, god of the lust for gold? Is all the individuality of the men and women who are trying to create homes in the desert west to be destroyed in order that Newell and his army of retainers may go on selling us 'short' on water?"

It was Fulton H. Sears of Fallon, Nev., a homesteader on the Truckee-Carson project, who asked these questions. Sears had just finished a careful study of the doctrines of "Beneficial Use" and "Economic Use" as enunciated in resolutions, passed at a meeting of project managers and water masters in Salt Lake City. F. H. Newell, director, presided at this meeting, and I. D. O'Donnell, who was named as supervisor of irrigation, in the reorganization of the service, was an active participant. Both Newell and O'Donnell are members of the Reclamation Commission of five members, which now controls federal irrigation.

Sears is a tall, well knitted man, with face tanned by Nevada's sunshine and the square jaw of a fighter. He is typical of the men who are giving the best that is in them of brain and brawn in developing the "land that God forgot." For years he practiced law in Chicago. He was successful, but he was not satisfied. He wanted a piece of land, a place where his children could breathe clear, clean country air, have plenty of sunshine and learn the beauties and benefits of nature in nature's own school. He took up a homestead on the Truckee-

Resolutions adopted at a meeting of Federal project officials in Salt Lake City:

BENEFICIAL USE OF WATER—A water user with a vested right limited to beneficial use is entitled to that amount of water that will render him a reasonable maximum amount of good with a reasonably economic handling of the water. Since he has acquired his vested right from the laws of his state, he is entitled to protection of that right by the state; but it is his duty to the state, and the state has the right to demand of him that he use every reasonable method to reduce the amount of water required to a minimum. This demand requires the water user to make reasonable preparation of the ground surface for irrigation; to use good judgment in selecting appropriate methods of applying the water to the ground; to prepare reasonably efficient dikes, ditches and structures to get the water over the land in such a way as to reduce the underground losses to a minimum, to irrigate the ground with such a head and at such intervals as to require a minimum use of water for proper irrigation; to cultivate the irrigated ground when practicable to prevent undue losses from evaporation; in some cases possibly to govern the character of crops to be grown. It is evident that the reasonable degree of perfection of each of these requirements will vary with the locality and with different and changing conditions in each locality, so that the beneficial use of water is variable.

ECONOMICAL USE OF WATER—Since the water supply available for irrigation in the western states is adequate for only a relatively small percentage of the entire irrigable acreage, the fundamental standard of economical use must be the financial results accomplished per acre-foot of water applied rather than the yield per acre irrigated. It, therefore, becomes both necessary and desirable to impress irrigators with the fact that in general the largest net profits per acre-foot of water applied are obtained, not from using excessive quantities, but from more careful use of relatively small quantities. In developing a more economical standard for the use of water, it should not be presumed that established rights can be limited to less water than they would carry under the accepted rule of beneficial use; yet by constantly bearing in mind that the ideal ultimately necessary must be the highest net profit per unit of water applied, irrigators may gradually be induced in many instances to obtain for themselves those results, and those undertaking the construction of new projects may be induced to so design their systems as to provide a liberal water supply during the development period with a view to ultimate development based on economic use.

In the history of irrigation in this country, there has been evident a gradual but very definite evolution in the ideas of what constitutes proper use of water. While the use of water for irrigation was at first a relatively unimportant one, its importance now overshadows all other uses, save that of domestic supply. In the course of this evolution, the doctrine of beneficial use has become established, but in future development this doctrine must in many cases merge into, or be supplemented by that of economic use. The doctrine of beneficial use looks to individual interest; that of economic use to the general welfare of society as a whole. So far as possible, water charges, systems of distribution, and regulations should be so adjusted as to make the interest of the individual water user coincide with this public interest.

Carson project five years ago. He has one of the best developed farms in that district today, but he has still many struggles ahead of him, and the settlers about him, at least those who were not as well fixed financially as was Sears when they started in to homestead, have even greater struggles and problems.

These problems largely concern dealings with the United States government, and with the Federal Reclamation Service. That was why Sears entered heartily into the organization of the National Federation of Water Users' Associations; that was why he has since served as a member of its executive committee.

Sears turned again to the Irrigation Age, in which he had been reading the new water "doctrines" of the Federal reclamation officials.

"Those resolutions sound good on paper; no doubt they have cost the water users several thousands of dollars; you know the expenses of all such gatherings as this one of the water masters are charged to us fellows," continued Sears, "but they are wholly impracticable, if the interests of the settlers are to be at all considered.

"If it wasn't that we project settlers face the serious fact that the highly - theoretical and impractical men, sent out from Washington and other great centers of irrigation in the east,

will try to enforce these 'doctrines' as the law of the projects, the resolution would simply be exceedingly amusing. At least they aptly illustrate the problems which the real settlers meet in dealing with these civil-service-fortified high-brow gentlemen, who ride in automobiles for which we are paying.

And we're forced to pay the salaries of these gentlemen, too.

"These 'doctrines' mean simply that some young civil service employe shall be permitted to tell sturdy, clear-brained American citizens:

"What crops he shall raise.

"How he shall plant his crops.

"When and how he shall irrigate them.

"What kind of ditches and structures he shall build.

"And they also provide:

"That the supply of water given to the farmer shall be contingent entirely upon the theoretical money value of his crop.

"That in supplying the water, the general good of the whole nation shall be considered before that of the farmer, who is probably staking his all to create for himself a home.

"But let us analyze these resolutions. All of us, who know anything at all about irrigation, know that the several states in the semi-arid west have fixed by statute the law of 'beneficial use.' The decisions of the courts have upheld these acts, making them firmly settled doctrines of irrigation law—that is to say, the ownership of public waters is limited to a beneficial use.

"The Newell resolution on 'beneficial use' begins: 'A water user with a vested right, limited to beneficial use, is entitled to that amount of water that will render him a reasonable amount of good, with a reasonable economic handling of water.' Just why the word 'vested' is injected into the resolution is hard to understand, unless it is intended to inflict more stringent rules and conditions upon those who have only initiated a right to acquire water and have not made final payment.

"As I understand a vested right it is a right which has been determined and fixed by law, and therefore cannot be taken away from its owner. Therefore the 'laws' laid down by the water masters cannot affect those with vested rights, and therefore we have a right to suspect the motive behind the inclusion of this word 'vested' in these resolutions.

"Now let us see what an actual farmer on any of the United States projects has to contend with under this new doctrine of beneficial use.

"On each project we have a water master or superintendent of irrigation, who controls the supply of water let into the ditches for irrigation and designates when it shall be used. He is a civil service employe, generally direct from Washington, D. C. He is a most important personage, with an automobile and other accessories of his high office.

"On most projects, under recommendations of Newell and his engineers, the government has already sold far more water rights than there is water to supply, hence perhaps this new 'doctrine' to permit further selling 'short.' To illustrate, let me cite my own case on the Truckee-Carson project, where they have been carrying out these 'doctrines' now put down on paper.

"I have suffered a loss of more than \$2,000 during the past two years as a result of these theories. There comes a shortage of water, but my crops need irrigating. I order water. The water master comes around and says: 'You can't have water for that

piece of alfalfa, because it has not enough fall. It takes too much water to irrigate it. You will have to plow that up and relevel it before you can get water.'

"If he doesn't say that, he may insist that you should use the furrow system instead of the checking system or that your rows are too long, causing too much seepage, and you cannot have any water until you alter it.

"It is possible after my five years of experience that if I relevelled my homestead and put in a new irrigation system throughout, I would save some water. How many settlers on our project or any other one can afford to do this? Besides the United States is under contract to deliver me three acre-feet of water each year, and that contract doesn't say anything about the whims of a water master, or provide that he can deny me my water at will.

"I may order water turned on in the morning for a special patch of potatoes and figure it will take about twelve hours to irrigate them. The water master comes around and says: 'You'll have to irrigate those spuds at night, as there is too much evaporation during the day.'

"After waiting just as long as the crop will stand it, I order three second-feet of water for three days. The water master probably will insist that I take six-second feet for twenty-four hours, insisting this is a more economical method of irrigation. I tell him my ditches won't handle such a big head of water and then he replies that I should build them so that they can handle the larger amount.

"If after my potatoes are irrigated, I cultivate them to conserve the moisture, two to one I will have plenty of moisture still when the next rotation of water comes to my land. But under the high and mighty rulings of the water master I must take water then or wait another eight days or so. It is a case of losing my crop by flooding it out or risking drought and second growth.

"There you have the Newell theory of 'beneficial use' of water, as it has been practiced on the Truckee-Carson project and as now put into law and doctrine for us by these self-constituted legislators.

"But they have gone even further. They have now created an additional doctrine of 'economical use.'

"This theory is based purely upon the worship of the almighty dollar. It says in very plain English that in order to get water you must grow those crops which theoretically are most valuable in dollars and cents. Onions and beets pay more than alfalfa or grains, therefore if the man growing onions needs water, I must go without it for my alfalfa. This is unjust because it is necessary to get a stand of alfalfa in our project before anything else will grow on the land. Furthermore, in some parts of the project grains are especially adapted to the soil and wheat and barley are grown almost exclusively.

"The homesteader with eighty acres at the end of his third year on the land may have twenty acres of second crop alfalfa, twenty acres of grain and young alfalfa, three acres of potatoes, an acre of onions and three acres of sugar beets. When July comes around the water master sends out a circular

(Continued on page 119)

PRESS AGENT STILL BUSY

The press agent of the Reclamation Service is still a very busy young man, despite the "business reorganization" of the service by Secretary of the Interior Lane. Either he has opened a "boiler plate" factory and furnishes free cuts, or he is so high class that he can induce editors to print his headlines, as well as his cuts and reading matter. Such a press agent would be worth \$1,000 a week to any big circus. In the Milwaukee News, the Akron, Ohio, Beacon-Journal and many other papers in the east there has appeared recently a large cut of the Reclamation Commission, under these headlines in healthy, black type:

New Reclamation Commission, Composed of Experts, Makes Good; Settlers Who Were Dissatisfied Complain No More

Beneath the cut are the names of Secretary Lane and the members of the commission. Then this statement:

The new commission which presides over the reclamation service in place of a single administrative officer has so revolutionized and improved that branch of the interior department that serious complaints are comparatively few. The commission is composed of F. H. Newell, director of the reclamation service; A. P. Davis, chief engineer; William A. Ryan, comptroller; Will R. King, chief counsel, and I. D. O'Donnell, supervisor of irrigation.

What part of the bill for this kind of publicity are you paying, Mr. Federal Water User?

THE \$50,000,000 BILL

Debate in Senate Indicates How the Wind Blows

During the debate on the Alaska railroad bill, Senator Borah of Idaho introduced an amendment to the measure providing for the issuance of \$50,000,000 worth of Reclamation Certificates. These certificates were to be of the same nature as the issue of \$20,000,000 obtained from Congress by the late Senator Thomas H. Carter, and recently allotted to the various Government irrigation projects. Senator Borah urged that the money derived from the sale of the proposed \$50,000,000 issue be used in inaugurating new irrigation projects. A few days later, Senator Borah withdrew his amendment, fearing it would imperil the entire Alaska bill. The amendment, however, served a purpose, in that it showed by the debate upon it something of how the senate feels toward the Federal Water Users.

Western senators of all three parties expressed themselves as favorable to relief measures for the Water Users. Senator Gallinger, a Republican, was the only Eastern senator who spoke on the bill, and he, too, expressed sympathy and desire to aid the Water Users. The only expressions from Southern senators could hardly be called kindly.

Senator Borah also has his \$50,000,000 certificate plan before the senate in the form of a bill, and hopes to get it out of committee. While its passage at this session of Congress hardly seems prob-

able, Senator Wesley L. Jones, of Washington, believes other legislative relief for the Government irrigators may be obtained. He is particularly anxious to see the twenty-year water payment bill passed, providing a measure satisfactory to the Water Users can be obtained.

Senator Jones has served for years on the Senate Committee on Irrigation and Reclamation of Arid Lands. Since the death of Senator Thomas H. Carter of Montana, he has become recognized as probably the best informed man in either house of Congress on irrigation matters. He is a thorough student of this subject, besides being a practical irrigator—his home being at North Yakima, Wash., where one of the big Government projects is located. Senator Jones has made several trips over the Government projects, meeting the Water Users, and learning the conditions with which they have to cope. He therefore is in position to play an important part in the irrigation legislation of the present session.

"The Secretary of the Interior is especially interested just now in securing legislation extending the time for payment for the use of water," said Senator Jones. "He believes that it will be best probably to spread these payments over a period of twenty instead of ten years, and also provide either that no payments should be made for four or five years, or if any are made that they shall be small. I think this is very important and necessary legislation.

"Every project that has been put in has cost about twice what it was estimated it would cost. And the cost has been far greater than was thought when the bill was passed and the limit was placed at ten years.

"I think twenty-year payments would be wise, and that this would practically insure the success of the various projects.

"The Department of the Interior and the Congressional committees are trying to agree upon a bill along these lines, and if it is agreed upon I believe that we can pass it.

"Another important proposition is the securing of more money, not only for the projects that are now under way, but to be used in taking up new projects. Whether we will be able to get such legislation is a different question. The matter of economy and the size of the appropriation will, of course, have its influence upon the present Congress. An election comes off this fall and it will be the desire to keep appropriations down as low as possible. Especially will this be the desire of the administration. The appropriations are going to be large, anyway, and thus refute the charges of extravagance that they have made heretofore against the Republicans, and therefore new propositions like this will have a rocky road to travel."

PROJECT CITY GETS PARK

Montrose, Colo., in the heart of the Uncompahgre project, is to have a large public park. The lower house of Congress has already passed a bill, authorizing the grant of about 160 acres of land for the park, and the bill is well on its way in the senate. The proposed park is a beautiful piece of mountain land, too rough for agriculture.

DURABLE AND SANITARY FEEDING TROUGHS OF CONCRETE.

A simple, sanitary and economical use of concrete is shown in the accompanying picture of a feeding trough for hogs. Nothing could be easier than to make troughs of this character for swine or poultry. Old lumber free from splits and knot-holes may be used. To procure an everlasting receptacle of this character simply means the nailing together of two boards in the shape of an inverted V. These are placed on a board platform or other even surface and surrounded with a board frame or form, which is then filled with concrete. The concrete is struck off while fresh to insure an even bottom. No special finish is required and very rude work will answer the purpose. The dimensions of the trough will, of course, depend upon the length and size of the board forms. Small troughs for chickens or large troughs for hogs may be made with equal facility.

Another simple method of making a small trough is to substitute for boards half of a drain tile or terra cotta pipe for the inside form. Where the boards are used it would be well to oil the surface coming in contact with the concrete. This makes the removal of the forms easy. A mixture of 1 part Portland cement, 2 parts sand and 4 parts crushed stone or gravel will make a concrete suitable for this purpose.

To prevent hogs from crowding or getting into the trough, crosspieces should be used as shown. To provide for bolting the crosspieces, holes should be bored in the platform at required intervals and the bolts set in with the thread end down. The bolts should go into the platform to a depth that will insure sufficient projection for the strap iron crosspieces and the nut. The concrete should be a "sloppy wet" mix and thoroughly puddled in the form. It should be kept in the form several days and protected from hot sun and wind. When sufficiently hard on the exposed surface to resist indentation with the thumb nail, the forms may be removed. The concrete should then be sprinkled twice a day for the period of a week.

The strength of a trough of this character will increase with age. It may be easily cleaned and will resist the hardest usage. The longer it is exposed to the weather the more durable it will become.

CORRESPONDENCE

Mr. D. H. Anderson, Editor,
IRRIGATION AGE, Chicago, Ill.

MY DEAR SIR:

In the January issue of the IRRIGATION AGE you published certain comments offered by me, under the caption "The Truth About the Irrigation Situation." Inasmuch as an essential part of the contribution was omitted from publication, I will ask you, in keeping with your policy of fairness towards comments of contributors, to call the attention of your readers to the lapse referred to in the February issue of the AGE.

At the time I submitted this document to you, I enclosed with it a memorandum stating

that the article sent was a draft of an address delivered by me at Denver, in December, 1912—before the convening of the Legislative Assemblies of the seventeenth arid-land states, and that, in view of the advanced steps taken in many of these states, in 1913, to cure, by legislative enactment, many of the evils pointed out, the document was offered as being of value, at this time, primarily to fix in the public mind, by contrast, the great improvement in legislative conditions. Read as it is, with total disregard of the changes effected in 1913, the article is misleading, and unjust to many of the western states.

In the memorandum referred to, I also stated, very clearly, that it was my purpose to submit, from time to time, "Digests" of the more recent legislative enactments. Reference to this was also omitted. I would not have you, or your readers, placed in a state of doubt as to these grave matters, nor do I relish being placed in the attitude of being ignorant of the great things accomplished in 1913. I trust you will accord this letter as much publicity as was given the original article.

Very sincerely yours,

EDWARD BOHN.

[Part of the copy mentioned by Mr. Bohn was mislaid, hence cause for his complaint. We are glad to pub-

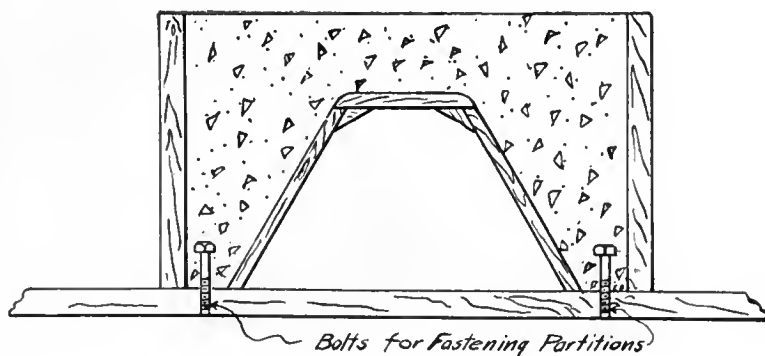

lish his letter so that his position may be made clear. The other articles mentioned will appear in future issues of IRRIGATION AGE.—EDITOR.]

More than 100 men have found employment as the result of the establishment of the sugar factory at Fallon on the Truckee-Carson project. The beet industry there for the first season is proving profitable, and has also routed out some worn-out or poorly developed alfalfa fields. When those fields are put back in alfalfa, they will be much bigger and better producers, due to the acquired knowledge and experience of the settlers.



HIGH EFFICIENCY PUMPING PLANTS

Although the question of efficiency does not receive much consideration when installing independent pumping plants for small farms, it is a very important feature when selecting pumping machinery for a large central plant. This is especially true when the pumps are required to operate against high heads. In such cases the excess cost of power resulting from a difference of 5 or 10 per cent in the efficiency of the pumping machinery is a deciding factor in the ultimate success of the irrigation system.

There are a number of points to bear in mind when designing a pumping plant for irrigation service. The most important are the following:

1. The location of the plant should be as close as possible to source of supply.
2. The number and size of units should be selected to give the best results throughout the entire range of pumping conditions.
3. The arrangement and size of pipe lines should be such that loss of head (which means increased power) is avoided as much as possible.
4. Last, but not least, the different sources of

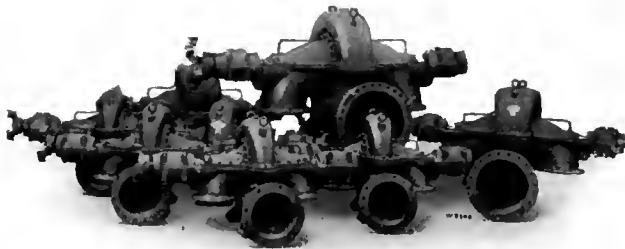

WORTHINGTON PUMP.

power should be very carefully studied before selecting the type of prime mover for driving the pumps.

The location of the pumping plant and the type of pumping machinery depend, of course, upon the nature of the source of supply. If the supply is taken from a river or lake of nearly constant water level, the horizontal shaft pump is the most suitable selection. If possible, the pumping plant should be located over the water with a suction lift not exceeding ten (10) feet. This arrangement eliminates bends in the suction line and results in increased efficiency.

If the level of water at the source of supply varies to such an extent that the suction lift at low water is excessive, the vertical shaft pump will give the best results. The pump should be placed in a watertight pit within easy suction lift at low water, and the prime mover located above the high water level.

The variation in both capacity and pumping head should be carefully determined before selecting the number and size of pumping units. For a wide fluctuation in capacity, the units should be of such size that the maximum efficiency can be obtained at all conditions. It is sometimes advisable to install large units to take care of the maximum flow and pumps of smaller size to operate during the

periods of lesser consumption. In other words, the smaller unit operating at maximum load will give a better over-all efficiency than the large unit pumping at greatly reduced capacity.

If the lay of the land is such that there is a wide variation in levels, much better results can be obtained by dividing the system into groups; and designing the pumps to best meet the conditions of each section, rather than attempt to irrigate the whole tract by pumping all the water to the highest level.

It must be remembered that the ultimate efficiency of a pumping plant depends not alone on the selection of high grade machinery. The friction loss through pipe lines is a very considerable factor, and in many plants considerable power is consumed to overcome friction which might better have been expended in pumping water. While the first cost of a large pipe line may appear excessive, the difference in the cost of operation should be carefully calculated before a final selection is made. The connections from the pumps to the suction and discharge mains should be as direct as possible and all useless valves and fittings eliminated. It is much cheaper in many cases to purchase a pump with special suction and discharge nozzles rather than attempt to meet the condition with a standard stock pump.

The great development of electrical energy from the vast natural sources of power has resulted in the extensive use of motor driven machinery not only for pumping water, but many other purposes around the farm. This condition naturally leads to the selection of the electric motor as the most popular prime mover for driving irrigation pumps. It must not be forgotten, however, that the combustion engine has now been developed to a very high degree of efficiency and reliability, and this type of prime mover makes a very satisfactory installation, and in many cases will show a saving in the cost of fuel over electrically driven pumps. Except for very large units such as are used for irrigation on the rice and sugar plantations of Louisiana and Texas, the steam engine with its necessary boiler plant and stand by losses is a rather expensive source of power.

The illustrations accompanying this article represent types of high efficiency centrifugal pumps, manufactured by Henry R. Worthington, 115 Broadway, New York. This concern has made a careful study of the irrigation problem and is prepared to make estimates and furnish complete data on the subject.

\$20,000,000 FOR MIDDLE WEST

An appropriation of \$20,000,000 for the construction of reservoirs and lakes to impound flood waters in western Kansas, Oklahoma, Nebraska, eastern Colorado and New Mexico is asked in a bill which Senator Bristow has introduced in the senate. An additional appropriation of \$1,000,000 for investigation of the feasibility of such projects is also asked. This latter appropriation, if granted, will permit the continuance of similar work begun in western Kansas and Oklahoma under an appropriation granted in 1912.

Reclamation Notes

ARIZONA.

After eight years in the reclamation service in the Salt River project as assistant irrigation manager of the South Side unit, Jas. E. Sprague has resigned to enter private business.

Project Engineer Francis L. Sellow of the U. S. Reclamation Service has received notice that \$370,000 has been set aside in Washington for river front protection work, in addition to other allotments which have been made for the Yuma project.

CALIFORNIA.

Notice of appropriation of 60,000 miners' inches of water of the Sacramento river, to be taken out above Middle Creek, near Redding, gives outline of an irrigation system to water 235,000 acres in Shasta, Tehama and Glenn counties, including all the territory between the foothills and the Sacramento river. It is proposed to divert the water to Stony creek, in Glenn county, by means of a canal 40 feet wide at the top, 20 feet wide at the bottom and 9 feet deep. Geo. L. Hoxie, a wealthy resident of Fresno county, is behind the plan.

It is reported that private capital is planning to take over the government's proposed reservoir and irrigation project on the Pit river, in Lassen and Shasta counties. A reservoir to save the water for irrigation and the production of electrical power is reported part of the project.

C. H. Horsley of the Waterford irrigation district has made filing on 250 second feet of the flow of the Tuolumne river and on two points of diversion, one at the La Grange dam of the Modesto-Turlock districts, and the other at a point several miles above, which is now being considered by the districts for the building of what is known as "Dam No. 2." Previous to beginning the organization of the Waterford district, about two years ago, filing was made on these same points and the same amount of water by J. L. Prouty, now president of the board of directors of the district. Mr. Prouty has willed his filings to the district. The district includes about 22,000 acres of land lying on the north side of the Tuolumne and east of the Modesto district.

Articles of incorporation have been filed by the Thermal Water Company; capitalization \$50,000. The principal place of business is San Francisco. The company is organized for the purpose of acquiring water rights, buying and selling land, etc., in Tulare county, the water to be sold exclusively to stockholders of the concern. Among the prominent men back of the undertaking are S. E. Keiffer and E. M. Dygert of Berkeley; H. L. Harhl of Palo Alto; C. S. Gilman of Oakland, and L. F. Laverty of Los Angeles.

Two of the largest irrigation pumping plants to be installed in California recently are under construction in the Woodville district for H. G. and Samuel Vincent, pioneer alfalfa and stock men of that section. Two reservoirs have been constructed, one covering 2 acres and the other 1½ acres of ground. They plan to irrigate a half-section of alfalfa from these outfalls.

The state reclamation board at Sacramento has approved the maps, contours and estimates for the reclamation of 100,000 acres along the Kings river, in Fresno county. This project, which involves an expenditure of only \$250,000, will add in value and productiveness more than \$15,000,000 to 100,000 acres of rich bottom land in the San Joaquin valley. These lands during a short period of the year have been flooded heretofore, resulting in a great loss of crop. The proposed project contemplates the elimination of the crooked, shallow and irregular

course of the Kings river and the formation of a permanent channel, 800 feet in width, extending to the point where the Kings river flows into the San Joaquin.

The secretary of the interior has withdrawn from all forms of disposition under the public land laws 111,360 acres of land in connection with the Iron Canyon irrigation project. The lands are withdrawn temporarily pending investigation of the project, which is being carried on under cooperative arrangements by the United States government and the state of California.

The Patterson Ranch Company has been granted a petition for the formation of a reclamation district near Patterson along the west side of the San Joaquin river. The proposed district will comprise about 1,400 acres of land lying in the river bottom. A portion of the river bottom has been reclaimed. Outside of the river bottom land included in this ranch practically the entire property has been disposed of to settlers and is now being highly improved for intensified farming.

COLORADO.

Thousands of acres of the school lands of Colorado that have been tied up for years, yielding no revenue to the school fund and absolutely unproductive, will be brought into production and added to the revenue yielders of the state as a result of the precedent established by the state board of land commissioners recently in canceling a gift of 640 acres, made in 1889, to promoters incorporated as the Naturita Ditch company. The action of the board in forcing the cancellation of the Naturita lease, while it affects directly only 640 acres, will result in the unlocking of 10,000 acres to which the Naturita tract is the key. The company that obtained the lease made no attempt to perfect the irrigation project and subsequently turned the lease over to the San Miguel Development Company, headed by Bulkeley Wells of Denver and Chaloner B. Schley and Duncan Chisholm of Colorado Springs. This company claims they have spent \$200,000 in the district, but they have not fulfilled the agreement with the state and have not supplied water to those who had the right to expect it. The settlers have now decided to build their own irrigation system.

Work will commence soon on the enlargement of Lake Henry, three miles north of Sugar City, which has been much needed to supply water enough to irrigate the land now under the ditches. By enlarging this lake the farmers will more than double the acreage the coming year.

The Water Users' Association and a number of land owners from the Palisade section held a meeting recently and a committee was appointed, consisting of W. Harrison, A. E. Johnson and Howard G. Fletcher, to confer with the directors of the Price and Stub ditches over water rights from the Grand Valley irrigation project, sufficient to water 2,000 acres.

Arthur and Potter and Clark and Hasselman of Pueblo have been awarded the contract for the construction of the reservoirs to be built for the irrigation of the Lewis tract in Crowley county, recently purchased by the Cudahy estate of Chicago. The contract price for this work is reported to be \$25,000.

Some 16,000 acres of land will be placed under irrigation this spring twenty-four miles from Fort Morgan by the San Arroya Irrigation district, which has recently completed its reservoir. The reservoir covers 373 acres and will contain 22,000 acre feet of water. The district has secured a right of easement from the state land board to the land covered by the reservoir. The board allowed the district to have the land at the minimum price of \$3.50 per acre.

Tentative withdrawal of 10,213 acres of land in Moffat and Routt counties has been made by the state land board on application of H. A. True, Jr., engineer of the Wyoming land board, who is interested in a Carey Act

project for the irrigation of these lands. Plans call for the construction of a reservoir to be known as Wolf Creek reservoir and to have a capacity of 5,000 acre feet.

The colonization of thousands of acres of semi-arid and newly irrigated lands bordering Denver on the east, has been given impetus by the purchase of 3,500 acres lying under the Antero project by a syndicate of Fort Worth, Texas, capitalists, for \$250,000. The tract occupies the central portion of the Antero irrigation system which was completed last year by the Henry L. Doherty interests. Three hundred acres of the tract lie just outside of the system, but they carry water rights.

The reclamation service has accepted the offer of the Grand Junction Mining and Fuel Company to furnish the power needed during the construction of the Grand river diversion dam and tunnel No. 3, units of the Grand Valley irrigation project, Colorado.

Under the terms of the contract to be entered into the government will pay approximately \$36,418 for the power service, an amount considerably less than the cost of installing a new plant.

The Secretary of the Interior has authorized the Reclamation Service to proceed at once to complete three important divisions of the Uncompahgre irrigation project in Colorado. These units of the work are as follows:

1st. Excavation of the East Canal system from the headworks to the junction with the Loutsenhizer canal, providing for the irrigation of 22,000 acres between the Selig and Garnet canal system; following this excavation headworks and lateral system will be completed.

2nd. Construction of headworks, enlargement of present Selig ditch, and construction of upper end of the Selig extension, a distance of 4 miles; construction of lower end of extension and of the Selig branch and the completion of the Peach Valley lateral.

3rd. Construction of Buttermilk, Poverty Mesa, and Roubidoux laterals and extension of Spring Creek and East Coal Creek laterals.

The total expenditures approved for the completion of the three canal systems is \$714,650, and the completed works will provide for the future irrigation of 78,000 acres.

MONTANA.

The completion for the excavation for the foundation of Sun River diversion dam marks an important step in the construction of the Sun River irrigation project, Montana, one of the largest projects so far undertaken by the Reclamation Service.

The dam site is in the narrow rock gorge through which Sun River flows, about 72 miles west from Great Falls. In excavating for the foundation the engineers encountered conditions similar to those in the Shoshone Canyon in northern Wyoming, where the Shoshone dam was constructed by the Service a few years ago. Huge boulders had ground great holes deep in the rocky bed, and the drills went down seventy feet before finding the solid foundation rock.

So narrow is the canyon that it is estimated one thousand cubic yards of masonry will bring the dam to an elevation well above the normal water level. This work will be performed immediately. The structure will have a height of 125 feet, and a length along its curved crest of 260 feet, but its length at water level will be only about 15 feet. Water stored in the mountains will be allowed to run down Sun River to this diversion dam when needed for irrigation, where it will be diverted into the supply canal for Pishkun reservoir, and later to a supply canal for the Willow Creek reservoir, which now stores the normal flow of Willow and Little Willow creeks for the Fort Shaw unit. The machinery used in constructing this dam will all be actuated by electric power.

Secretary of the Interior Lane has authorized the Reclamation Service to hold an auction sale of town lots in the government townsite of Ballantine on the Huntley irrigation project on April 1.

NEW MEXICO.

Col. Jas. of Des Moines, N. M., has given out the information that he will construct a diversion dam to cost \$50,000 early in the spring on the Cimarron river, for the purpose of supplying a reservoir with 3,000 acre feet of water, to be used for irrigating a large tract of land.

That the money necessary to proceed with the Red River irrigation project in Taos county, through which 30,000 acres of state land are to be reclaimed, has been secured, is the statement recently made to the state engineer by Messrs. John Oleson and J. F. Sanborn of Denver, who have submitted for approval a form of contract entered into with an insurance company for the necessary capital to finance this project. Several years ago this project was undertaken and extensive surveys made, but was later given up, owing to the depression in irrigation finances. Work on the first unit will be commenced on May 1 of this year, and 5,000 acres will be under cultivation by May 1, 1915, and two years thereafter the second unit of 25,000 acres must be under water, according to the contract. A bond of \$41,000 must be given by the purchasers, who will pay \$7.00 per acre, or \$4.00 more than the minimum price for the land, the payment to be made as land is disposed of to settlers.

The Secretary of the Interior has authorized the Reclamation Service to execute contract with the Best Manufacturing Company of Pittsburgh, Pa., for furnishing balanced valves for service conduits of the Elephant Butte dam in connection with the Rio Grande project in New Mexico. The contract price is \$24,980.

OREGON.

The Secretary of the Interior has approved the construction of the sixth unit of the Umatilla irrigation project, Oregon, known as the West Extension and embracing 10,000 acres of land. The Secretary's approval covers an allotment of \$800,000 for the work.

The Umatilla project embraces some of the most valuable fruit and truck land in the West, and the development already shown on the areas now under irrigation on the east side predicates a very substantial increase in the population and taxable wealth of the state as soon as the west side lands are brought under cultivation.

The allotment just made initiates the government upon a work which will call for a total investment of nearly \$4,000,000 and will provide for the reclamation of nearly 40,000 acres now almost wholly desert and unproductive.

TEXAS.

At a recent election held in Ward county irrigation district No. 1 the old directors and the assessor and collector were re-elected for a two-year term. The directors have had under way a survey of the reservoir site and intake and will soon have same completed, when an estimate will be made of the probable cost of the construction of the reservoir and canals necessary for the impounding of water for the district and an election will then be held for a bond issue.

The old "acequia" running through the southern part of El Paso and now known as the Franklin canal, will be improved at an early date. The work will be done by the U. S. Reclamation Service at a cost of \$200,000. This irrigation canal is 30 miles in length, and for 7,000 feet, through El Paso, the sides and bottom will be concreted, necessitating the excavation of 175,000 cubic yards of earth.

C. C. Lockwood, former auditor of the West Texas Telephone Company at Brownwood, has resigned his position and will engage in farming in San Saba county. Mr. Lockwood has purchased a tract of 700 acres on the Colorado river near the town of San Saba. The tract contains over 1,000 pecan trees and nearly all of the land is susceptible of irrigation.

Articles of incorporation have been filed by the United Land and Irrigation Company, with a capital stock of \$165,000. Principal office of the company is located at

Brownsville. The incorporators are Grover C. Singer, Ralph Howard and E. S. Hunt.

A certificate of dissolution has been filed by the Lake View Irrigation Company of Quanall.

WASHINGTON

In order to increase the water supply for the Okanogan irrigation project, the Secretary of the Interior has approved the recommendation of the Board of Reclamation Commissioners that plans be made immediately for the development of power to pump water to about 1,050 acres. Power will be developed at two drops in the main canal. The sum of \$82,000 has been allotted from the reclamation fund for the work. This plan will reduce the acreage to be served from Salmon river about 11 per cent. In ordinary years it will permit the holding of 2,000 to 3,000 acre feet in the reservoirs as a reserve for years of drouth, in addition to the reserve afforded by the original project and by increase in Salmon Lake capacity.

State Land Commissioner Clark V. Savidge has extended the period during which the waters of the Yakima water shed shall remain withdrawn from general appropriation, pending the completion of the Yakima reclamation project by the federal government. The extension is for two years from December 31, 1913, to which date commissioner Savidge extended the time last spring, following the failure of the legislature to act on the application for an extension of time. The first application of the government was made in 1905 pending the determination of the practicability of the project, which will water 500,000 acres of land and cost more than \$10,000,000 when completed.

Chelan county voters have petitioned for an election for the formation of an irrigation district to include 10,000 acres adjacent to Lake Chelan. Half of this land comprises the Wapato project and it is proposed to extend that system so as to cover 5,000 acres north of the town of Chelan. The cost of the extension is estimated at \$390,994.

Pursuant to the approval by the Secretary of the Interior of the contract between the State of Washington and the United States providing for the investigation of the Palouse irrigation project, Governor Lister, Mr. E. McCulloh, engineer in the Reclamation Service who will have charge of the work, and Supervising Engineer S. H. Swigart, in charge of the Washington irrigation projects, held a meeting to outline future work and discuss the steps necessary for handling the appropriation provided by the state.

The entire work of the survey will be under the control of the Reclamation Service. The problem is to find sufficient feasible reservoir sites to impound water for the irrigation of a smaller project than the one originally planned, as the Washtucna Coulee was considered infeasible by the board of engineers reporting on the Palouse project, and railroad construction has made the site at the diversion point on Palouse river infeasible.

The Secretary of the Interior has directed the Reclamation Service to prepare a form of Excess Land Contract and Trust Deed, and to submit same to certain land owners on the Sunnyside Unit of the Yakima irrigation project in Washington.

The lands affected lie above the gravity canal system and can be irrigated only by the installation of a number of pumping plants to be located along the main canal. In order to insure an early subdivision and sale to bona fide settlers of all holdings in excess of 40 acres, a contract is to be entered into between the government and the land owners, under the terms of which the government will have power to force such subdivision and disposal.

MISCELLANEOUS

More than 100,000 acres of high land in the vicinity of Milner, Jerome and the south side of Twin Falls project in Idaho are to be developed by the Kuhns this year. Jackson lake, Wyoming, will be used as a storage reservoir and the water supply will be 400,000 acre feet obtained from the government. The water will be carried

about 300 miles down the channel of the Snake river to the point of diversion near Milner. The Kuhns are paying for the dam at Jackson lake, although it is being built under the supervision of the Reclamation Service. It is estimated that the project will supply farms for 1,500 families.

Contract has been awarded to the East Jersey Pipe Company, No. 50 Church street, New York City, N. Y., for furnishing lock bar steel pipe for outlet conduits for the Minitare dam, North Platte project, Nebraska.

The material to be furnished consists of 536 feet of 48-inch pipe. The price f. o. b. cars, Patterson, N. J. is \$4,288.

ORGANIZE AT BARSTOW

Representative business men and farmers from Pecos, Barstow, Big Valley, Grand Falls, Balmorhea, Midland, Buena Vista and Arno met recently and organized the West Texas Reclamation Association.

The object of the organization is to secure the services of the United States Reclamation Service in making a topographic and hydrographic survey of the Pecos Valley of Texas and, possibly, of southern New Mexico, as well. This will be done with a view of discovering and exploiting the latent irrigation possibilities of this great valley, locating all feasible reservoir sites, and otherwise throwing open to development between 200,000 and 250,000 acres of rich land.

The association elected the following officers:

President, George E. Barstow, Barstow; vice-president, F. W. Johnson, Pecos; secretary, H. B. Link, Pecos; treasurer, Charles E. Nicholls, Barstow. The following were appointed members of the executive board: Burch Carson, Barstow; Taylor Black, Barstow; Vernon L. Sullivan, Buena Vista; J. H. Boogher, Grandfalls; J. E. Starley, Pecos; James F. Ross, Pecos; E. D. Balcom, Balmorhea; W. H. Dennis, Buena Vista; J. L. Farley, Big Valley; John T. Sweatt, Grandfalls, and S. B. Pugh, Arno.

ASKS AID FOR THE FLATHEAD

Congressman Evans of Montana has introduced a bill in the House extending the provisions of the act of June 25, 1910, authorizing the assignment of reclamation homesteads and the act of August 9, 1912, authorizing the issuance of patents on reclamation of homestead entries to lands in the Flathead project of Montana.

BUSY IN CASA GRANDE

The Casa Grande Valley Water Users' Association of Arizona has made plans for an earnest campaign in Washington to obtain the construction of the San Carlos reservoir. There is said to be vigorous railroad opposition to this project. There is a great deal of Indian land involved, but settlers declare thousands of acres of homestead lands could also be watered.

We are short of copies of issues of THE IRRIGATION AGE for September, October, November, December, 1913, and January, 1914. We will pay 10 cents per copy for any of these issues. Send to THE IRRIGATION AGE, 30 North Dearborn street, Chicago, Illinois.

SECRETARY LANE'S LETTER

(Continued from page 107)

successfully making final proof, but if the survey made four farm units of these 160 acres, he should be required within one year to sell three of those units. These irrigated lands are valued at \$20 to \$100 per acre. If sold at these prices the entryman will have from \$2,400 to \$12,000 to invest in improvements on the unit he retains. This should be a sufficient reward for the industry and sacrifice of those who have waited so long for the settlement of this vexed question. There seems to be no justice in the demand to permit patent to be issued for 160 acres. To do so would be to encourage speculation and the withholding of irrigable land from cultivation. Under the above plan patents would only issue to one person for the area embraced in one farm unit, as these are now or may hereafter be fixed. The assignees of the original entrymen would receive patent when the provisions of the law have been complied with. If it were possible, I would limit the delivery of water to one farm unit only for each owner. There appears to be no legal means of accomplishing this as to lands now in private ownership.

Costs of Operation and Maintenance.—This is a subject so vitally connected with size of farm units that it must be considered in connection therewith.

If authority shall be granted by Congress, I propose:

That hereafter no part of building costs nor betterment costs shall be charged to this account. Neither shall charges be assessed and collected in advance upon an estimate as to what may be the expense of a given year's service, except in case of default. Full and explicit monthly statements of the cost operation and maintenance shall be made monthly and posted in all the offices of the Reclamation Service on each project and in the office of the Water Users' Association. The totals shall be carried forward from month to month and on November 30th of each year the total cost as shown by such statements shall be increased by 5 percent to cover the cost of collection and the total thus obtained shall be assessed proportionately to the amount of water used upon each acre of irrigable land in the project.

The charge assessed upon each farm unit shall not be less than a reasonable minimum to be established by agreement with the Water Users' Association on each project. This minimum charge shall be assessed against the total irrigable area of each farm unit and shall be the same if the farm unit is uncultivated and uses no water as if it were cultivated and irrigated.

These charges shall fall due and be payable December 1st and if payment is made on or before December 15th the 5 percent added to maintenance and operation expenses to cover the cost of collection shall be rebated. If not paid by January 1st a penalty of 1 percent per month for each month of delinquency or for each fraction of a month shall be added.

The above provisions recommend themselves to me as being reasonable regulations and such as should be desired by the water users. Operation and maintenance charges must be paid. If farming operations are not sufficiently profitable to cover this service then irrigation is a failure. There can be no valid excuse for neglect to pay such charges and the very existence of the Reclamation Service and the water users' organizations as well depends upon prompt payment.

I trust that water users will soon be taking over the management and operation of the projects. There should be a well-ordered definite system as to such collections, and calculated to produce the best results. I am advised that the cost of collecting delinquent assessments amounts to more than 5 percent thereof. The water user who promptly pays his assessments should not be burdened with a share of this cost as he is at present. By providing a rebate or discount of 5 percent and not less than 5 cents per acre to the man who pays within 15 days, this burden is lifted from him. The delinquent, however, should be required to pay the full amount and 1 percent per month additional for each month, or fraction of a month, of his delinquency. It should also be provided that any water user who is delinquent for operation and maintenance charges for the year ending November 30th shall not be served with water for any ensuing season unless he shall

on or before May 1st pay the operation and maintenance charges for the then current year on an estimated basis of 25 percent increase over the charge for the preceding year, ended November 30th. It is believed that these provisions will encourage the thrifty to pay promptly and compel the unthrifty to pay eventually all that may be due. If water is not turned on May 1st for delinquents, unless charges are paid in advance for the coming season and at an increase of 25 percent over delinquent charges, it is believed the delinquent charges will be paid to escape the higher advance payment.

It must be apparent to you that if there is a large accumulation of unpaid charges due the Service there must be some adjustment made to recover the loss. In private business this loss is recouped by an arbitrary charge which rests upon the paying customer the burden of unpaid accounts. The government is not, perhaps, justified in adopting this business rule, but it is justified in adopting such restriction as will reduce such losses to a minimum.

I want you to think this over carefully and remember that sooner or later the burden of carrying delinquents will fall upon your shoulders, that you and not the impersonal government will have to deal with them. The question is, shall the government enforce a hard and fast rule, or shall it leave you heir to an unbusinesslike and inefficient system.

The man who tries to hold 160 acres and pay operation and maintenance charges has four times the burden of the man with 40 acres, and while it is true that he has four times as much land, it is also true that no 160-acre tract ever seems to produce as much per acre as 40 acres. The projects which conform most nearly to the 40-acre standard have the highest average yields. The margin of profit is much greater. It follows, therefore, that there will be fewer delinquents where the 40-acre tracts prevail than where the larger are. The total delinquencies for this account on Huntley project are less than 9 percent, the forfeitures less than 1 percent. Huntley has generally 40 acres of irrigable land in each farm unit. On Lower Yellowstone, where the land is chiefly in large holdings, the delinquencies are over 73 percent. I think it may be said to be axiomatic that land greed induces land poverty. You men who are making homes for yourselves and your families over-reach yourselves when you struggle under a burden to acquire title to a large tract. The small farm, the good farm, first; then out of its profits, the large farm; rather than the large farm, the large debt, the big failure, and the big regret.

Economy in the Use of Water.—Perhaps the most vital question confronting the water user today, and really of greater importance to his future welfare than the question of deferred payments for the water used, is the determination of what is the proper use to be made of the water which is available for use upon the land. The prevailing disposition appears to be to use more water than is absolutely necessary for the best results on plant growth. The experts of the Service and those outside of the Service who have been longest accustomed to irrigation and who have developed all that is known on that subject, as applied to agriculture in this country, are unanimous in recommending a system of rotation, payment to be made in proportion to increased quantity, and of measuring according to predetermined schedule the amount of water that shall be delivered to each user to be regulated in accordance with the character of the land and the nature of the crops. The deleterious effect of the use of too much water upon the land is becoming more evident with each year.

The accumulation of ground water with a resulting water-logging of large areas is but a reproduction of the natural conditions prevailing in humid countries where rainfall is excessive and the run-off limited.

If farmers will insist upon pouring water upon the higher lands in excessive quantities, not only will the plant food be leached from the soil, but the encroachments of the ground water will continue year by year and eventually will neutralize the benefits of irrigation by destroying more land than is reclaimed.

Not only does this bad result appear to be inevitable,

(Continued on page 120)

IS NEWELL TRYING TO MAKE SERFS OUT OF THE WATER USERS?

(Continued from Page 111.)

letter, announcing a shortage of water and stating that water will be furnished only for onions and beets. That leaves the farmer with only four acres of his crop for which he can get water. When he harvests his onions he finds everyone else has also raised onions and he cannot even get the cost of freight out of them if he ships them. Therefore he and many other farmers haul them to the slough to rot. This has actually happened on the Truckee-Carson project. It has been the same story with potatoes and other 'money crops,' while water has been refused for alfalfa and grains, those crops, which mean the very existence of the homesteader and his livestock. In their mad effort to get vast production in dollars per acre from the federal irrigated lands, Newell and his theorists have overlooked the practical side of this subject, and if they are permitted to go on much longer trying to enforce their theories, we settlers will all become just mere serfs, as well as bankrupt. We will be human sacrifices, placed on the altar in the temples of Mammon into which Newell and his retainers are trying to turn the government projects, through their theory of water only for the crops that—if they could be sold—would pay the most money.

"Then they go even further. Their whole doctrine resolves it into the proposition: Shall the farmer work for the whole of mankind or shall he look out for himself and his family? I do not believe the settler has sacrificed his individual rights in taking up an irrigated homestead; neither do I believe he has agreed to work for the general public first and himself and family second. This theory is un-American and Americans reared in the love of liberty and justice are not going to stand for it. No one except a band of theorists, such as has controlled the Federal projects, would have even thought of trying to put such ideas into force."

A National Oil Engine

Will keep your power cost down

Think what it means to you to have at your service an engine that will burn all the low grades of oils, even those costing but two cents per gallon. An engine that has eliminated ninety per cent of the small, delicate and complicated parts. An engine that is ready for service at a moment's notice. One that is perfectly simple and absolutely reliable.

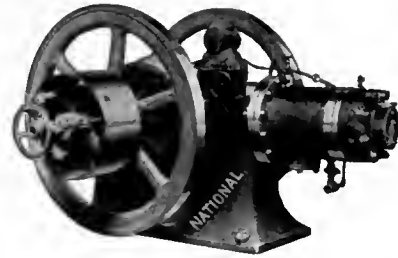

That is what you get when you buy a

NATIONAL

Our *Internal Igniter Ball* (patented) gives better combustion, more power and positively eliminates all danger from exploding hot balls.

Get our 1914 catalog

The National Steam Pump Company
UPPER SANDUSKY, OHIO

Look into the Irrigated Farms on the Lower Yellowstone Project now reached by New Extension of Great Northern Railway

40,000 acres are now ready for irrigation on Uncle Sam's Lower Yellowstone Project—on both banks of the Yellowstone River in western North Dakota and north-eastern Montana. The new extension of the Great Northern Railway up into the Yellowstone Valley, lately completed as far as Sidney, Montana, has now opened up this Project.

Here you can buy one of the 40 acre units, or one of the 80 acre units, for from \$20 to \$30 per acre. Uncle Sam charges you for the water right \$45 per acre, and gives you ten years in which to pay him. You pay for service, \$1.50 per acre per year. Then you have a fine little farm that will make money for you in grains, dairying, stock-raising and market-gardening.

You don't have to worry about the weather on one of these farms; every year is a *good year*.

The Great Northern's MONTANA BOOK tells about this Yellowstone Project; clip the coupon below, and send for it today.

E. C. LEEDY, General Immigration Agent, GREAT NORTHERN RY., ST. PAUL



E. C. LEEDY, General Immigration Agent
Dept. I. A., Great Northern Ry., St. Paul
Please send MONTANA BOOK to

Name

Address

When writing to advertisers please mention The Irrigation Age.

SECRETARY LANE'S LETTER

(Continued from page 118)

but in pursuing this practice you are drawing from the available supply for acres that do not require it and depriving acres which are much in need of it of their share of the available water supply. Reasonable restraint should be exercised by all and that economy practiced which will result in the most beneficial possible use of the water.

Building Charges.—This subject, of course, most intimately affects you and your prospects. If you are to win your home and your independence you must pay the cost, the whole cost, of reclaiming the land you hold, not only because the law requires it, but because it is right that you should do so. There may be differences of opinion as to what may be properly charged to that cost. I own to some doubts as to whether you may not have been charged with some items of cost that were more properly chargeable to some other account. I do not know this to be so, but I propose to find out and to let you know, to relieve you, if possible, of any charge that may be unjust and to issue public notices definitely and finally fixing the cost as soon as this may legally be done.

It is possible that Congress may grant power to the

Secretary of the Interior to extend the time for the repayment to the reclamation fund so that the whole sum may fall due at the end of 20 years instead of 10. I favor such an extension and have so advised Congress in my annual report.

It is my intention to determine this cost as accurately as possible by means of a board of review or a committee on each project to consist probably of an engineer of the Reclamation Service, an expert accountant representing the Secretary of the Interior and an engineer or accountant or other representative of the water users to be selected by the Water Users' Association. All items of cost assessed against each project shall be thoroughly reviewed and any items that may be objected to by the water users shall be thoroughly examined into and the justice or injustice of the charge determined at an open hearing. But this course must necessarily be dependent upon the agreement of the water users that the costs thus determined upon shall be final and binding upon them and shall form the basis of a new contract with the United States conditioned upon payments indicated as above or spread over a period of 20 years if so authorized by Congress.

At the same time and by the same board or committee there should be considered the question of additional construction costs made necessary by extension, betterments,

FOREST NOTES.

There are 36,500,000 young trees in the government's forest nurseries.

Two tons of cascara bark have just been sold from the Siuslaw national forest, Oregon, at one cent a pound.

The northernmost national forest is the Chugach in Alaska; the southernmost is the Luquillo in Porto Rico.

For shingles alone, 750 million feet of timber is cut in that part of the state of Washington which lies west of the Cascades.

California led last year in timber sold from national forests, though Montana had the largest number of sale transactions.

The American forestry association has just elected Henry S. Drinker, president of Lehigh University, and P. S. Ridsdale, as its president and secretary, respectively.

The biological survey and the forest service have been cooperating in the extermination of ground squirrels on national forests in California. The annual loss of range feed and grain crops from ground squirrels is enormous.

Twenty states have published reports of their wood-using industries.

A good grade of excelsior is being made from fire-killed Alpine fir and Engelmann spruce in Colorado.

It is predicted that western yellow pine will furnish an excellent source of turpentine as the southern pine becomes exhausted.

While there are five hemlocks in the United States, only two are of any commercial importance, common hemlock and western hemlock. Of these two western hemlock makes the better lumber.

(Continued on page 122)

Clear Fir Silo at 40% to 60% Saving

Buy your silo of us, and you buy *direct*, not only from the *maker* but from the *lumber producer* as well.

We own forests, railroads and six big mills

There are thousands of acres of timber in our tracts. The fir is the finest in the land. Tall, straight and close of grain. Only the choicest goes into Seattle Silo Staves. They show no knots, sap or other defects. Do not warp, shrink or swell. The toughest, best wearing wood in existence. All the cutting, logging and manufacturing of this timber is handled by us. One continuous operation. One overhead expense. Hence the big saving that we effect in producing cost—and why we save you 40% to 60% on a silo of better quality. Mail the coupon for catalog.

Seattle Silos

have patented swinging doors

These are far the best silo doors ever devised.

Quick detachable with special iron cross-bar or hoop connection. The steel bars on the door provide a solid ladder from which hoops can be tightened—the result of a new invention. They close absolutely air-tight. Can not stick or bind—never have to be lifted. They swing in or out readily on their hinges.

Mail the coupon today

We are preparing to furnish you with seasoned red cedar for flume building purposes.

"Machine banded wood stave pipe for irrigation system."

Save 40% to 60% on Lumber and Millwork

Five middlemen come between the mill and you when you buy of your local lumber dealer. All get a fat profit; no wonder lumber is high. We put an end to this hold-up game. Sell you direct. Give you better materials at our mill price. Save you 40% to 60%.

We make shipments within 24 to 48 hours after receiving orders. Our shipments get to destination within an average of two weeks. Write today for price list. Better still, send your list of materials for our pre-paid prices. Money back unless satisfied.

Mail coupon today

HEWITT-LEA-FUNCK CO. 471 Crary Bldg., Seattle, Wash.

Kindly send the following, quoting prices delivered my station.
[] Catalog of lumber and millwork. [] Special silo folder.

Be sure to write plainly

Name _____

Address _____

Business _____

am planning to build as follows: _____

improvements or drainage or power systems. The necessities of each project should be thoroughly entered into with a view to the final determination of a "completed cost" for each project the completion contemplated to include all necessary enlargements of the project works, particularly of drainage works.

Residence and Cultivation Requirements.—There is another important matter in which I think you will agree with me, namely that any reduction of existing terms of payment should be extended, if at all, with caution, to those land owners who are neither residing upon their lands nor cultivating them. There is, unfortunately, a class of investors, a few in number it is true, who are holding areas of considerable size including lands for which water has been provided at the cost of the project and who are living in cities or remote localities. Many of these are not cultivating the ground, or, if using it at all, only in the most perfunctory manner. With these are to be classed certain speculators or dealers in real estate who have purchased lands at low prices or have obtained relinquishments, due to the inability of the former owners to retain the land, and who are holding these lands out of use in the hope of obtaining a profit by raising the prices rather than by raising crops. The result is that in the midst of a tract of highly cultivated small farms, there is occasionally a section or quarter section of land which has been left untouched, or perhaps merely ploughed up at some time and which has now grown up to weeds and serves as a refuge for jack rabbits and various kinds of vermin; weed seeds are blown from these fields and infest the neighboring cultivated land; the presence of these deserted areas is not only an eye sore but a direct financial injury to all of the neighbors.

The owners of these lands are endeavoring to make a profit largely out of the labors of the owners of the surrounding lands who, through their toil in the field, are gradually increasing land values in the vicinity. In other words, they are not only freely enjoying the bounty of the government in providing water for the land, but in like way are indirectly levying a toll upon the labor and self-denial of their neighbors.

No one can argue that these men should have the

benefit of extension of time in making payment, as through such benefits it will enable them to hold these lands still longer out of cultivation, advance the prices, increase the load on the newcomer, and further delay the ultimate development of the community and its successful growth.

The injury to the community and to the state lies not wholly in keeping these lands out of profitable use, but also by not permitting the rapid growth of resident population. By keeping away many desirable citizens, the burden of pioneering laid upon the remainder is increased notably in the maintenance of roads and of schools, and of all the local institutions so necessary to a growing community.

Employment of Settlers in the Service.—I am convinced of the justice of the very general demand that preference shall be given in the employment of assistants on various projects to the settlers upon the lands watered. In all capacities for which a water user is capable of qualifying under the Civil Service rules and regulations, he should be given the preference, but his application for employment should have the endorsement of the Water Users Association, or of its Board of Directors.

I trust that we may have the hearty co-operation of all in bringing to a success these enterprises, and that this review of present problems may enable you to see more clearly the purpose of the Reclamation Act and the policy with which it is being administered.

Cordially yours,
FRANKLIN K. LANE.

MARTINEZ IS BACK

Felix Martinez, one of the most prominent men among the Water Users on the Rio Grande project, has just returned from a tour of South America, as one of the United States commissioners in behalf of the San Francisco-Panama Exposition. Mr. Martinez reports that all South America is greatly interested in the coast fair, and nearly all the nations south of the equator will have buildings and big exhibits.

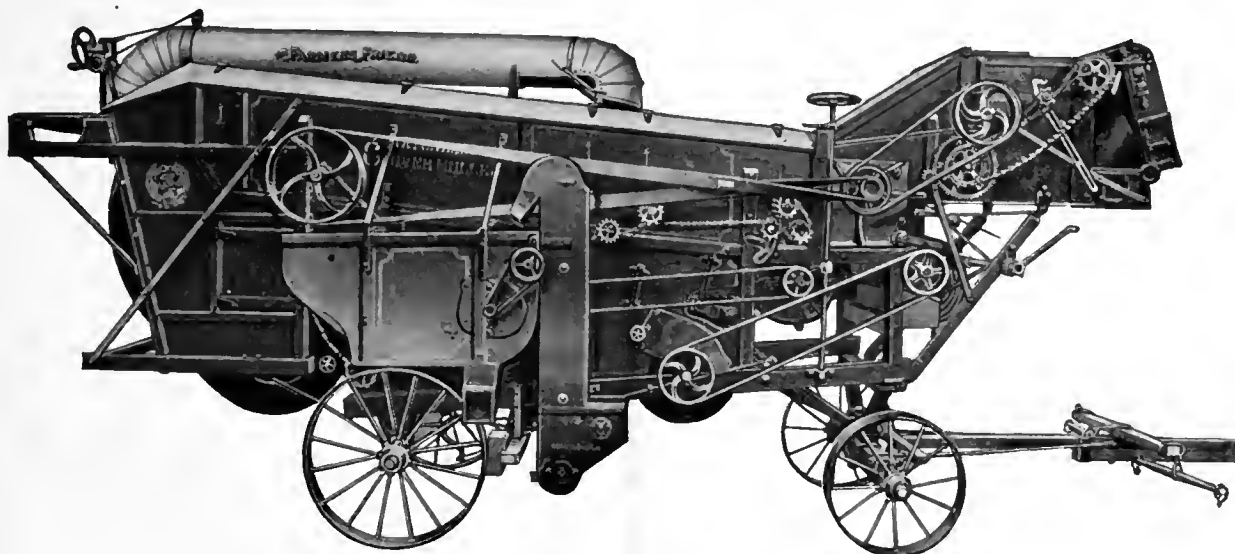

HULL YOUR SEED QUICKLY, PERFECTLY and ECONOMICALLY With a
"MATCHLESS" CLOVER and ALFALFA HULLER

That's just what you will do if you use a "Matchless" Huller on the job. It's the one huller that will hull all the Clover or Alfalfa you can get to it without sacrificing the quality of the work. Here's the reason! We use square steel huds in our hulling cylinder. This construction has every advantage over rasps of spikes, because no set of spikes will knock the seed out of the damp pods. Rasps gum up and are easily destroyed. Our system of separation is unique and effective. This consists of a series of rotating troughs with perforation in the bottom, with provision for adjustment to meet the various conditions of clover. The Patented Steel Scrapers attached to the bottom of these troughs thoroughly scrape the separator bottom and insure a steady and positive delivery of the pods to the hulling cylinder, regardless of the condition of the clover. This construction enables you to hull seed under conditions in which no other huller can operate; enables you to hull earlier in the morning and later in the evening than with any other—this insures a longer day, thus increasing your earning power. Give us an opportunity to prove to you right on your own farm that the "Matchless" is the speediest and cleanest huller on the market. WRITE FOR CATALOG TODAY, or call at our nearest Branch House.

THE AULTMAN & TAYLOR MACHINERY COMPANY, MANSFIELD, OHIO.

Sole Builders of Aultman-Taylor "Starved Rooster" Line of Machinery.

BRANCHES: Minneapolis, Minn.; Portland, Ore.; Lincoln, Nebr.; Kansas City, Mo.; Wichita, Kan.; Decatur, Ill.; Indianapolis, Ind.

Settlers on the Truckee-Carson project have had success this year in raising turkeys. The alfalfa fields and the grains and other products grown on the irrigated lands are ideal foods to make the gobblers large, fat, juicy, delectable.

Huntley project settlers are considering the establishment of model rural schools and demonstration farms. Under the Montana law, teaching of agriculture is now required in all rural schools.

FOREST NOTES

(Continued from page 120)

The Philippine bureau of forestry uses a launch for service between islands. The U. S. forest service employs several, both on inland lakes and in salt water, in Alaska and Florida.

Trunk manufacturers in Colorado are abandoning the usual basswood and cottonwood for the trunk box, and are turning to Engelmann spruce, which combines lightness, strength, and ease of working.

There are 703 bighorns or mountain sheep in the national forests of Nevada.

In 26 states there are state foresters who cooperate with private timberland owners in solving forest problems.

The forest service maintains nine experiment stations for studies in reforestation and similar subjects.

The bureau of entomology and the forest service, working together for the control of forest insects, last year covered more than 160,000 acres in their operations.

A national arboretum is being established in Rock Creek national park, District of Columbia. Eventually it will contain all American tree species which will thrive there.

The total amount of land purchased in the eastern states for federal forests is nearly 800,000 acres. So far the principal work on these areas has involved their protection against forest fires.

The forest service collected 40,000 pounds of tree seed last year for use in reforestation work. The total area reforested was about 30,000 acres.

There is promise of a large turpentine industry in the west and southwest, the raw product being supplied by the resinous gum of western yellow pine.

German pencil manufacturers are looking to California incense cedar for pencil wood. The establishment of a pencil factory in California is not improbable.

More than 120 million board feet of timber was given away free by the government last year to settlers and miners living in or near the national forests.

(Continued on page 124)

There is lots of privately owned land for sale on nearly all the government projects. Much of this is partly or fully ditched, leveled and otherwise developed. This land must be sold because the Government limits the acreage which each project farmer may hold. A limit of 40 acres on farms on the Salt River project was fixed recently, forcing much land in the country of ostriches and oranges upon the market.



The Campbell Automatic Irrigation Sprinkler

Solves the "Irrigation Problem" and affords rain when you want it, and like you want it, at the minimum cost of installation and operation. Sample postal \$3.00. Money back if you want it. Descriptive literature on request.

J. P. CAMPBELL, Jacksonville, Fla.

Saves Seed
Increases Yield
Improves Grade

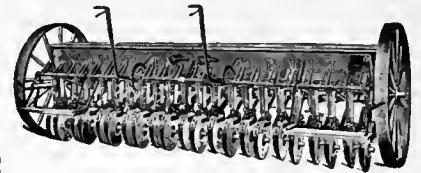

Monitor Double Disc Drill

"The Drill That Pays for Itself"



Bigger Profits from Grain Crops. You are not making near all the money you can from your grain crops—if you are not using the Monitor Double Disc Drill. For example—with wheat it saves one-fifth the seed and increases the yield 3 to 7 bushels per acre. The increase with other grains is in the same proportion. Can you afford to lose that much on every acre every year?

Deposits Seed at an Even Depth. The Monitor sows in front of the bearing. Other drills sow behind the bearing. This particular feature of the Monitor gives it a very great advantage. The downward turn of the discs carries the grain into the ground and deposits it at the bottom of a clean, wide furrow, in two rows, one inch apart. Every grain is covered uniformly with moist soil.

Every Grain Grows. None of the seed is dragged to the surface to shrivel in the sun, or be eaten by the birds. Every seed germinates. Sow one-fifth less and still get a better stand than with the old style drills.

All Come Up at the Same Time. The proper placing of seed and uniform covering with moist soil causes the grain to come up and ripen evenly—increases the yield and improves the grade.

Write for Free Booklet containing Valuable Information on Small Grain Crops and Monitor Drills



Moline Plow Company

Moline, Illinois

AND ALL BRANCH HOUSES



OREGON CONGRESS MEETS

Three Hundred Delegates To Attend Irrigation Meeting At Portland

More than three hundred delegates are expected to attend the third annual session of the Oregon Irrigation Congress, which convenes in Portland, Ore., February 13 and continues two days.

Nearly forty organizations, representing practically all the rich irrigation districts of Oregon, now hold memberships in the Congress, and at its last meeting, there were 200 accredited delegates.

The officers and committees in charge of the congress are:

President, Bill Hanley, Burns; first vice-president, Asa B. Thomson, Echo; second vice-president, C. C. Chapman, Portland; third vice-president, M. J. Lees, Canby.

Executive Committee—Chairman, J. W. Brewer, Redmond; W. S. Worden, Klamath Falls; Walter F. Burrell, Portland; Geo. B. Dukek, Condon; C. W. Mallett, Ontario; Guy Rice, Lakeview; E. E. Kidell, Island City.

Legislative Committee—Chairman, W. Lair Thompson, Lakeview; Leon J. Chapman, Ontario; J. C. Hoskins, Stanfield; Wm. King, Prineville; J. O. Hanaker, Bonanza.

Program Committee—Chairman, C. C. Chapman, Portland; Jimmy Donegan, Burns; J. T. Hinkle, Hermiston.

PATENTS FOR SALE!

AUSTRALIAN, MEXICAN and CANADIAN patents on a new principle of water measurement. Rivers or small pipe flows. Furnishes a record in gallons, cubic or acre feet. ¶ No machinery or moving parts. ¶ The principle covered is the only one in existence which furnishes a perfectly accurate record of flowing water, and when introduced, will become the universal method of measuring irrigation water throughout the world ¶ For particulars and price, apply to

W. H. TUCKER or W. H. GILMORE
VERNON, B. C., CANADA



**IRRIGATORS!
Stop Using Dams**

of dirt, sacks, canvas and others that are unreliable and expensive. An Irrigator offers you his practical and economical irrigating tool. The **PORTABLE FOLDING STEEL DAM**, which is light, durable, simple in construction, easy to operate and can be quickly adjusted to any ditch narrower than the dam. The **PORTABLE FOLDING STEEL DAM** saves ditch banks and fields; saves water; saves time and labor and will save you money. You will work less and worry less thru the irrigating season if you use this dem. ORDER NOW.

This Portable Folding Steel Dam Makes Irrigating Easier

PRICES NET F. O. B.

2-Foot Dam	\$2.00
3-Foot Dam	2.50
4-Foot Dam	3.00

W. A. LINKLETTER, Inventor and Manufacturer, Boulder, Colo.



THINK what it means to you! To have at your service—day and night if desired—the combined power of 30 to 35 horses and 10 to 15 men—ready at a moment's notice to plow, disc, harrow, seed, harvest, build roads, irrigate, thresh and do numerous other power jobs, all at the minimum expense for fuel and maintenance. That's what you get when you buy a time-tried and time-proven

**AULTMAN-TAYLOR 30-60
GAS TRACTOR**

They're built with the complete knowledge of the requirements of a tractor of the first quality. They're built right here in our own shop, under our own supervision. We know they're right and we stand back of every tractor. The Aultman-Taylor 30-60 burns either gasoline, kerosene or

distillate with unequalled economy. The Aultman-Taylor 30-60 is not an experiment. Their real worth has been demonstrated on thousands of farms throughout North America. Let us explain to you why you should own and operate one of these money-making and labor-saving tractors. **WRITE FOR CATALOG AND FURTHER INFORMATION TODAY.**

We are also builders of the Famous "New Century" Separator, "Matchless" Clover and Alfalfa Huller, Steam Traction and Portable Engines, Bean Threshers and Saw Mills. Catalog free upon request.

THE AULTMAN & TAYLOR MACHINERY COMPANY

MANSFIELD, OHIO.

BRANCHES: Minneapolis, Minn. Portland, Ore. Lincoln, Nebr. Kansas City, Mo.
Wichita, Kan. Decatur, Ill. Indianapolis, Ind.

FOREST NOTES

(Continued from page 122)

It has been demonstrated that over-grazed stock ranges on the national forests can be brought back to use under a system of regulated grazing faster than if they are left unused.

The American forestry association has members in every state in the union, in every province in Canada, and in every civilized and semi-civilized country in the world.

Makers of phonographs are aiming to use wood instead of metal in all parts of the instrument where this is possible, in order to increase the mellowness of the tone.

On the Pocatello forest, Idaho, 230,000 trees were planted during the past year, and almost half a million in the past three years, fully three-fourths of which are alive and doing well.

Experiments in the use of aspen for shingles show that the shingles do not check in seasoning, and that they turn water satisfactorily, but that they are too easily broken in handling.

There are somewhat more than 500 recognized tree species in the United States, of which about 100 are commercially important for timber. Of the 500 recognized species, 300 are represented in the government's newly acquired Appalachian forests. All American species, except a very few subtropical ones on the Florida keys and in extreme southern Texas, are to be found in one or another of the national forests.

A rancher has applied for the rental of 320 acres on the Pike national forest, Colorado, to be used in connection with other private land, for raising elk as a commercial venture.

The government has just sold 43,000 cords of cedar wood for shingles from the Washington national forest. The shingles manufactured from this wood, laid six inches to the weather, would cover 2½ square miles of roof.

The navy department has asked the forest service to investigate guijo, a Philippine wood, for possible use in decking boats and ships. Longleaf pine, sugar maple, and beech are the domestic woods most used for decks.

The state university lands in Arizona are to be lumbered under a cooperative agreement between the government and the state land commission. Arizona is the first state in the southwest and one of few in the country to cut its timbered lands on forestry principles.

The annual meeting of the American Forestry Association was held in Washington on January 14. A president, twenty-one vice-presidents, a treasurer, an auditor and five directors were elected and plans made for an active campaign for forest conservation during 1914. The association has 8,000 members.

Use KEROSENE Engine Free!

Amazing "DETROIT" Kerosene Engine shipped on 15 days' FREE Trial, proves kerosene cheapest, safest, most powerful fuel. If satisfied, pay lowest price ever given on reliable farm engine; if not, pay nothing. No waste, no evaporation, no explosion from coal oil.

Gasoline Going Up!

Gasoline is 9c to 15c higher than coal oil. Still going up. Two pints of coal oil do work of three pints gasoline.

Amazing "DETROIT"

—only engine running on coal oil successfully, uses alcohol, gasoline and benzine, too. Starts without cranking. Only three moving parts—no cams—no sprockets—no gears—no valves—the utmost in simplicity, power and strength. Mounted on skids. All sizes, 2 to 20 h. p., in stock ready to ship. Engine tested before crating. Comes all ready to run. Pumps, saws, threshes, churns, separates milk, grinds feed, shells corn, runs home electric lighting plant. Prices (stripped), \$29.50 up. Sent any place on 15 days' Free Trial. Don't buy an engine till you investigate the money-saving, power-saving "DETROIT." Thousands in use. Costs only postal to find out. If you are first in your neighborhood to write, you get Special Extra-Low Introductory price. Write! (1914) Detroit Engine Works, 301 Bellevue Ave., Detroit, Mich.



FOR THE "LAND'S SAKE"

BUY A

BOSTROM IMPROVED



FARM LEVEL

Price \$15



which has TELESCOPE enabling you to read the Target over 400 yards away, and TERRACE, DITCH, TILE DRAIN, IRRIGATE

your land properly, and save surveyor's fees. It is sold by up-to-date hardware and general merchants everywhere, and guaranteed to be the most

SIMPLE, ACCURATE, DURABLE AND COMPLETE outfit ever made for all farm work. If your dealer hasn't one in stock, he will order for you from a nearby hardware jobber.

Write today for description of Level, and details of our MONEY BACK GUARANTEE.

BOSTROM-BRADY MANUFACTURING CO.

119 Madison Ave., Atlanta, Ga.

SEND \$1.00 FOR THE IRRIGATION AGE ONE YEAR AND THE PRIMER OF IRRIGATION, PAPER BOUND.

International Harvester Oil and Gas Engines

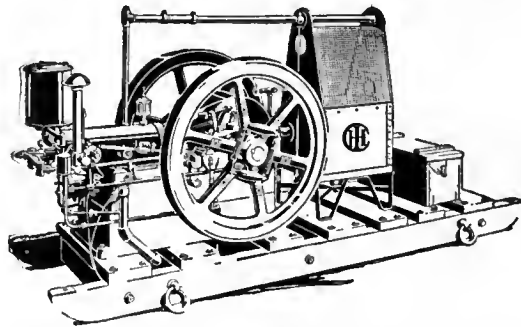

- THE I H C LINE GRAIN AND HAY MACHINES
- Binders, Reapers
- Headers, Mowers
- Rakes, Stackers
- Hay Loaders
- Hay Presses
- CORN MACHINES
- Planters, Pickers
- Binders, Cultivators
- Essilage Cutters
- Shellers, Shredders
- TILLAGE
- Combination, Peg and Spring-Tooth, and Disk Harrows
- Cultivators
- GENERAL LINE Oil and Gas Engines
- Oil Tractors
- Maconre Spreaders
- Cream Separators
- Farm Wagons
- Motor Trucks
- Threshers
- Grain Drills
- Feed Grinders
- Knife Grinders
- Binder Twine

SUCCESSFUL farmers are no longer asking, "Shall I buy an engine?" They have passed that point and now inquire, "Which engine shall I buy?"

A little careful observation will show that International Harvester engines are the most satisfactory. No doubt is left when features like the following are studied: Detachable valve guides, offset cylinder head, fuel pump, split-hub fly-wheels, extra large intake and exhaust valves, etc.

Ask the men who have used I H C engines. That is the best test. They will explain the excellence of I H C construction, simplicity, strength and durability.

Study the engines yourself at the nearest dealer's where International Harvester engines are sold. They are made in all styles, and range in size from 1 to 60-H. P. They operate on low and high grade fuels.

Write for our interesting and instructive catalogues, and when we send them we will tell you where the engines may be seen. A postal will do.

International Harvester Company of America

(Incorporated)

Denver—Helena—Portland—Spokane—Salt Lake City—San Francisco

Champion Deering McCormick Milwaukee Osborne Plano





American Ingot Iron



Corrugated Culverts

And Inverted Siphons

are of immense assistance in the work of the Irrigation Engineer.

The development of irrigation projects very often includes the building and maintaining of streets and roads, and the unequalled Convenience, Effectiveness and Durability of this type of culvert make it the logical choice of energetic and far-seeing men.

In the form of the Inverted Siphon, Corrugated American Ingot Iron Pipe is ideal for the purpose of carrying the water of an irrigation canal or natural stream under a highway or railroad. The corrugations raise a ripple in running water which serves to keep silt in

suspension, and corrugated pipe is consequently more easily kept free from sediment than a smooth construction.

American Ingot Iron (Armco Brand) is the *Purest* and therefore the most *Durable* in all exposed situations.

Write the nearest manufacturer for particulars and prices on American Ingot Iron Culverts, Flumes, Sheets, Plates, Roofing and Formed Products:

Arkansas—Little Rock
Dixie Culvert & Metal Co.
California—Los Angeles
California Cor. Culvert Co.
California—West Berkeley
California Cor. Culvert Co.
Colorado—Denver
R. Hardesty Mfg. Co.
Delaware—Clayton
Delaware Metal Culvert Co.
Florida—Jacksonville
Dixie Culvert & Metal Co.
Georgia—Atlanta
Dixie Culvert & Metal Co.
Illinois—Bloomington
Illinois Corrugated Metal Co.
Indiana—Crawfordsville
W. Q. O'Neill Co.
Indiana—Princeton
W. Q. O'Neill Co.
Iowa—Des Moines
Iowa Pure Iron Culvert Co.

Iowa—Independence
Independence Cor. Culvert Co.
Kansas—Topeka
The Road Supply & Metal Co.
Kentucky—Buechel
Kentucky Culvert Co.
Louisiana—New Orleans
Dixie Culvert & Metal Co.
Maryland—Havre de Grace
J. N. Spencer.
Massachusetts—Palmer
New England Metal Cul. Co.
Michigan—Bark River
Bark River Bridge & Cul. Co.
Michigan—Lansing
Michigan Bridge & Pipe Co.
Minnesota—Minneapolis
Lyle Corrugated Culvert Co.
Minnesota—Lyle
Lyle Corrugated Culvert Co.
Missouri—Moberly
Corrugated Culvert Co.

Montana—Missoula
Montana Culvert Co.
Nebraska—Lincoln
Lee Arnett Co.
Nebraska—Wahoo
Nebraska Culvert & Mfg. Co.
Nevada—Reno
Nevada Metal Mfg. Co.
New Hampshire—Nashua
North East Metal Culvert Co.
New Jersey—Flemington
Pennsylvania Metal Cul. Co.
New York—Auhurn
Pennsylvania Metal Cul. Co.
North Carolina—Greensboro
Dixie Culvert & Metal Co.
North Dakota—Wahpeton
Northwestern Sheet & Iron Wks.
Ohio—Middletown
American Rolling Mill Co.
Ohio Corrugated Culvert Co.
Oklahoma—Shawnee
Dixie Culvert & Metal Co.

Oregon—Portland
Coast Culvert & Flume Co.
Pennsylvania—Warren
Pennsylvania Metal Cul. Co.
South Dakota—Sioux Falls
Sioux Falls Metal Culvert Co.
Tennessee—Nashville
Tennessee Metal Culvert Co.
Texas—Dallas
Atlas Metal Works.
Texas—El Paso
Western Metal Mfg. Co.
Texas—Houston
Lone Star Culvert Co.
Utah—Woods Cross
Utah Culvert Co.
Virginia—Roanoke
Virginia Metal & Culvert Co.
Washington—Spokane
Spokane Cor. Cul. & Tank Co.
Wisconsin—Eau Claire
Bark River Bridge & Cul. Co.
Wisconsin—Madison
Wisconsin Culvert Co.

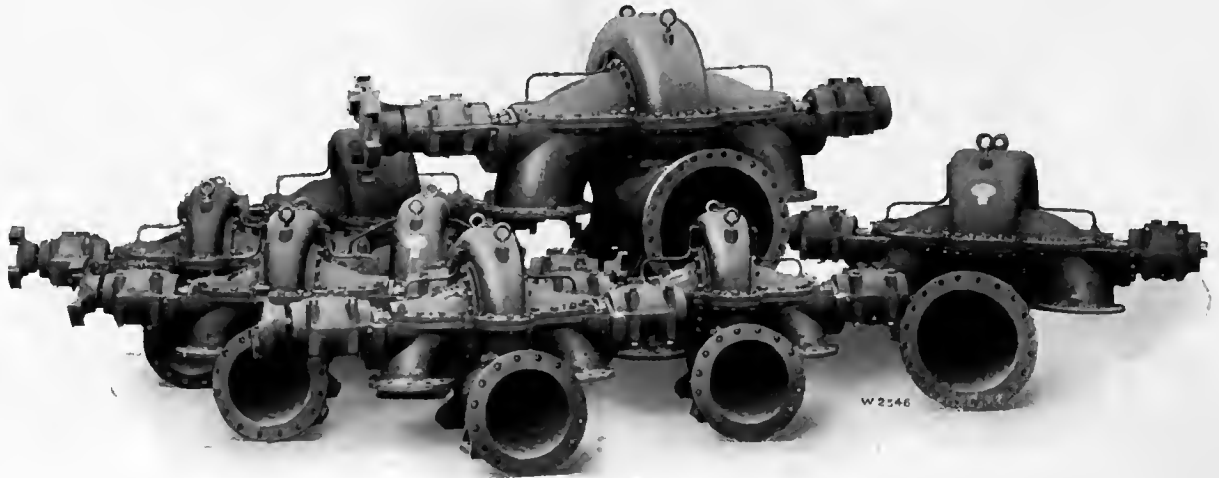

THE ABOVE GROUP ILLUSTRATES PART OF A SHIPMENT OF 25 CENTRIFUGAL PUMPS FOR THE BRENTWOOD IRRIGATION PLANT, BRENTWOOD, CALIFORNIA.

SUCCESS *or* FAILURE

OF AN IRRIGATION SYSTEM
DEPENDS UPON THE PROPER SELEC-
TION OF PUMPING EQUIPMENT

WORTHINGTON CENTRIFUGAL PUMPS

ARE BUILT BY ENGINEERS WHO HAVE MADE
A CAREFUL STUDY OF THE IRRIGATION
PROBLEM—THEY REPRESENT THE HIGHEST
DEVELOPMENT IN THE DESIGN OF PUMPING
MACHINERY FOR THIS CLASS OF SERVICE.

WE WILL BE PLEASED TO MAIL UPON APPLICATION, COPIES
OF OUR CATALOG W202-89 AND SPECIAL BOOKLET W204-89

HENRY R. WORTHINGTON

115 BROADWAY, NEW YORK

WORKS: HARRISON, NEW JERSEY

BRANCH OFFICES IN ALL PRINCIPAL CITIES

W 253.S

THE TECKTONIUS DRAW-BAND FASTENER

is the simplest, strongest, safest band-clamping device made. No rivets to rust, shear off or pull out. Put on and adjusted, by ordinary workmen. Insures no leaking or bursting tanks or flumes. Made of malleable iron—every Fastener hammer-tested. Cannot wear out, break or pull off. Makes

Irrigation Flumes—Water Tanks and Conduits—Strong and Durable as Steel

Send for free booklet, and learn all about this simple, scientific and effective band-fastener. Also we are manufacturers of other water-works and irrigation-iron appliances.



E. C. TECKTONIUS MFG. CO.
1220 13th Street Racine, Wis.

Fairbanks-Morse Oil Engines

develop full rated power on a multiplicity of fuels. Very easy to operate—no experienced attendant required. In sizes from 2 to 200 H. P.

Pumps of any desired capacity desired, to meet every irrigation requirement. Centrifugal and plunger type; direct connected or for belt drive. Thousands of acres are cheaply irrigated with Fairbanks-Morse equipment. Write for Catalog No. 5K650.

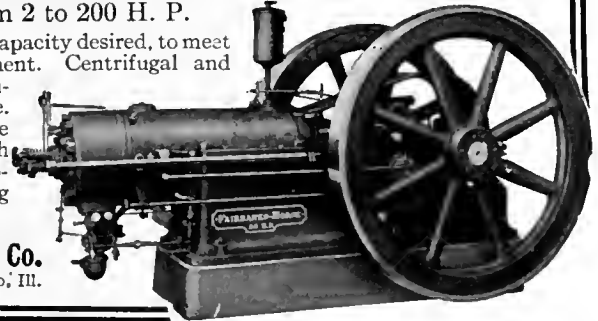

Fairbanks, Morse & Co.
900 S. Wabash Ave., Chicago, Ill.

GALVANIZED METAL IRRIGATION FLUME

(Newcomb Patent)

Made entirely of rust-proof, galvanized iron. No bolts or rivets used in construction. This flume is considered by experts to be the most serviceable equipment for the purpose on the market. A careful examination of the construction as shown herewith will convince those who are acquainted with irrigation conditions of its lasting quality and the ease with which it may be put together. Complete information, with prices, will be furnished on application to the



Section of Flume

KLAUER MFG. COMPANY, Dubuque, Iowa



strain that causes it is hard on the wagon. I H C wagons—

The Farm Burden Bearer

YOU and your farm wagon spend a great deal of time together. Of all farm tools it is your standby. Its wheels bear the burden of big loads—towering racks of hay and grain, sacks of produce, loads of sand and gravel, anything that needs moving, over miles of roads to market. It takes solid strength to stand up long under that. When next you ride on a load, listen to the constant racking, creaking, groaning sound of the wagon box, wheels and running gear as the load pitches back and forth over the road ruts. Not an unpleasant sound, but the

**Weber
Columbus**

**New Bettendorf
Steel King**

give the buyer the most he can get for his money because they defy hard usage for the longest time, and are easiest on the horses.

This makes I H C wagon reputation: Selection of the finest grades of lumber, oak, hickory and pine, and of the best quality steel and iron; many months of toughening air-drying for every piece of wood; skilled assembling of parts, fitting of bolts and rivets, and perfect shaping and ironing; application of the purest paint to act as wood preservative and to prevent shrinking and warping of the wood. When the wagon is ready for the farmer, it is practically perfect in every detail and thoroughly up to the I H C standard.

And there are many other reasons we have not room for here why I H C Wagons are the best to buy. Weber and Columbus wagons have wood gears; New Bettendorf and Steel King have steel gears. A visit and a talk at your local dealer's, where the wagons may be seen and studied, will soon convince you as to the wagon you want. Get catalogues from the dealer, or, write the nearest branch house.



WESTERN BRANCH HOUSES: Denver, Col.; Helena, Mont.; Portland, Ore.; Spokane, Wash.; Salt Lake City, Utah; San Francisco, Cal.

International Harvester Company of America

(Incorporated)

CHICAGO

U S A



When writing to advertisers please mention The Irrigation Age.

UNION MACHINES WITH PUG MILLS COMBINED

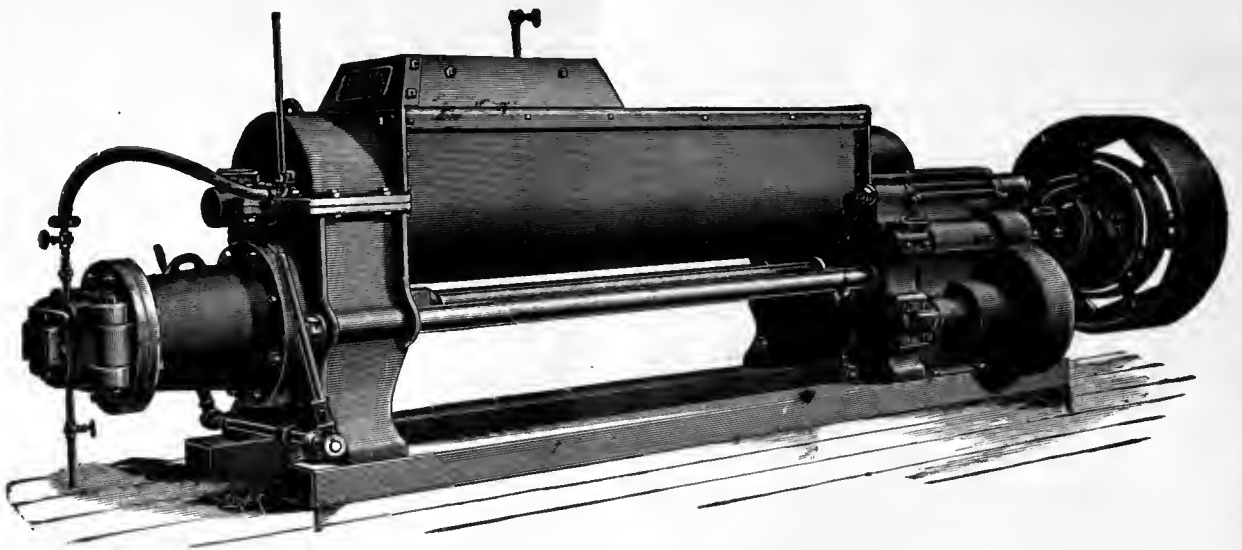

FIVE SIZES ALL CAPACITIES

Outfits for Drain Tile, Hollow Ware, Building
and Paving Brick and other Clay Products

If interested write us for particulars and estimates.

E. M. FREESE & CO.
GALION, OHIO

IRRIGATION FROM WELLS



An Arkansas Installation. Layne Patent Screen and Patent Enclosed Line Shaft Centrifugal Pump.

With the twenty-three hundred successful working plants using our system of irrigation, which inoculates and energizes the dormant forces, there is now being produced in previously non-productive districts throughout the United States and in portions of Europe and Asia over eleven million dollars worth of FOOD PRODUCTS ANNUALLY. That our system is not an experiment is forcibly demonstrated by the fact that much of this production is from localities which were arid and barren previous to the introduction of our system.

Write for new catalog.

LAYNE & BOWLER COMPANY

Address nearest office.

The World's Largest Water Development Company

Houston, Texas

Memphis, Tennessee
Welsh, Louisiana

Stuttgart, Arkansas
Plainview, Texas

Jackson, Mississippi



The Laursen Automatic Pump

IRRIGATION A SPECIALTY

Operated with
Water Pressure
secured by a
fall from a spring,
stream or
artesian well

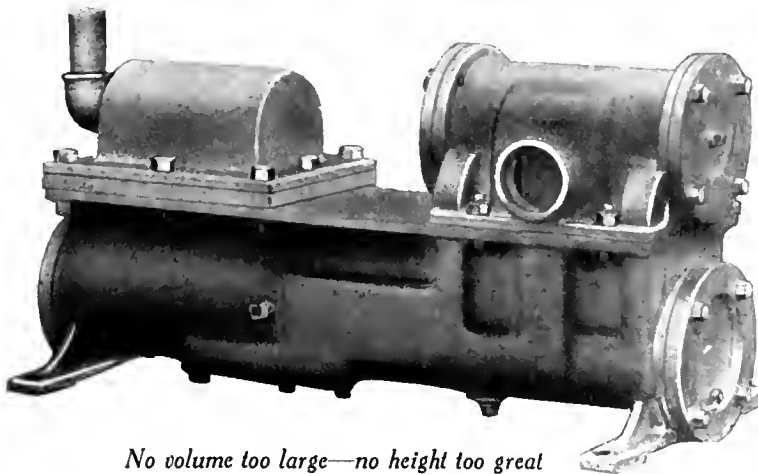

Self-Acting,
Self-Regulating,
Self-Lubricating,
and no
operating expense

No volume too large—no height too great

Depending on rainfall for irrigation is an uncertainty, for by so doing there is apt to be either a shortage or the rain does not come when most needed. Your water supply can be made a certainty by installing a Laursen Automatic Pump at low first cost and no operating expense. Try one of our pumps at our risk and be convinced. Write for our literature, including our signed guarantee protecting the purchaser. Pumps built of all sizes for Irrigation, Private and City Water Works.

Laursen Automatic Pump Co.

McGRATH BUILDING

EAU CLAIRE, WISCONSIN



WE SHALL be glad to mail anyone who wishes same, our free catalog. We sell our product through dealers and jobbers entirely and solicit inquiries from all dealers. Our goods are well and favorably known. They are standards in the United States Army and several other departments of the government.

Gold Medal Camp Furniture Mfg. Co.
Racine, Wis., U. S. A.

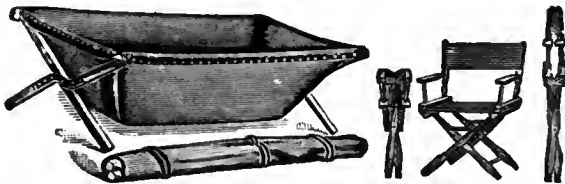

SUPERIOR



THE NAME TELLS A TRUE STORY

No matter where you live or what your seeding conditions are, you can get a **SUPERIOR GRAIN DRILL** that will fill the bill and do your work in the best possible manner. Superior Drills are made in all sizes and every style. Every Superior Drill is sold under a warranty that absolutely protects the buyer. Send for catalogue. Read it and go to your local dealer and insist on seeing the Superior Drill.

AMERICAN SEEDING MACHINE CO., (Inc.)
Springfield, Ohio

GRAIN DRILLS

PAYS FOR ITSELF IN ONE MONTH



and Keeps on Saving You Money at the Same Rate Thereafter.

THE RECLAMATION DITCHER

Cuts Canals and Laterals for less than any other machinery—because it plows the dirt out with *One Continuous Sweeping Motion*.

We guarantee the cost per yard and prove it before you buy.

The J. D. Adams Mfg. Co.
Indianapolis, Ind.



Delays Pay No Dividends. Mail This Coupon Today.

The J. D. Adams Mfg. Co., Indianapolis, Ind.

Below are descriptions of our proposed ditches. What will it cost per cubic yard to make them with the Reclamation Ditcher?

Length	Width in Bottom	Average Depth	Maximum Depth	Minimum Depth	Slope of Sides	Character of Soil

Name _____ Address _____

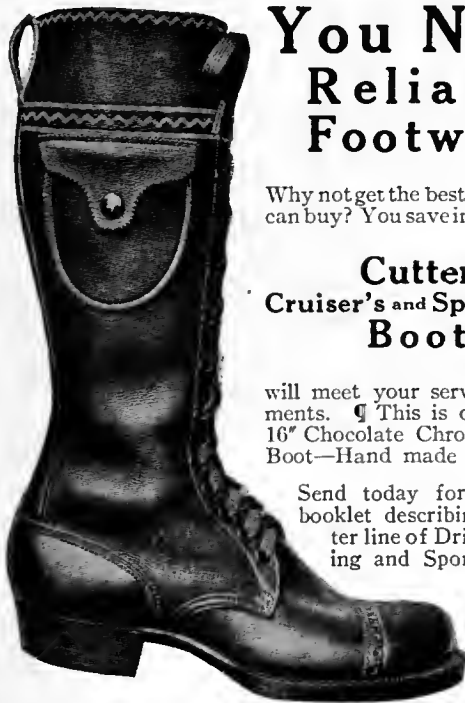

You Need Reliable Footwear

Why not get the best your money can buy? You save in the long run

Cutter's Cruiser's and Sportman's Boots

will meet your service requirements. ¶ This is our No. 106 16" Chocolate Chrome Sporting Boot—Hand made throughout.

Send today for illustrated booklet describing the Cutter line of Driving, Cruising and Sporting Boots.

*It
Will Pay
You*

A. A. Cutter Company

Eau Claire, Wisconsin

SAMSON TURBINE



When the PUMP cannot be direct connected to the turbine shaft, the power is usually transmitted by gears, shafting, etc. On account of the HIGH SPEED of the SAMSON, for a given power, lighter and consequently CHEAPER transmission machinery can be used.

JAMES LEFFEL & CO.

Springfield, Ohio, U. S. A.

316 Lagonda Street



THE LENNON METAL FLUME

Requires *no cross-bars* on the smaller and medium sizes, and but few on the larger

This, however, is only one of the reasons why it is easier and cheaper to erect than other types. The joint is simple, practical and water-tight; the accessory parts are few and very easily handled; special sheets for curves offer no difficulties. It is the construction which finds favor with the practical man.

Made from American Ingot Iron, the purest and most durable on the market, it constitutes

THE PERFECT CONDUIT

Write the nearest Manufacturer for full information

CALIFORNIA—Los Angeles and Berkeley
California Corrugated Culvert Co.

COLORADO—Colorado Springs
Lennon Flume Company

MONTANA—Missoula
Montana Culvert Company

NEBRASKA—Wahoo
Nebraska Culvert & Mfg. Co.

OREGON—Portland
Coast Culvert & Flume Co.

TEXAS—El Paso
Western Metal Mfg. Co.

TEXAS—Houston
Lone Star Culvert Co.

SOUTH DAKOTA—Sioux Falls
Sioux Falls Metal Culvert Co.

UTAH—Woods Cross
Utah Culvert Company

WASHINGTON—Spokane
Spokane Corrugated Culvert & Tank Company

This Book Shows How to Plan a Private Irrigation Pumping Plant



It also shows all of the various types of pumps to meet the conditions found in different localities, tells how to select the proper pump for your conditions, how to determine the amount of power you

will need and all the other things the irrigator needs to know.

One will be sent free on request as long as they last. Write today

THE GOULDS MFG. CO.
LARGEST MFR. OF PUMPS FOR EVERY SERVICE

174 Fall Street, Seneca Falls, N. Y.
Branches in All Principal Cities

IRRIGATION DITCHES

Cheaply and Properly Made with a

Rural Road Grader and Ditcher



Cutting V-Bottom ditch on Slope of 1½ to 1.

The successful irrigation ditch or lateral must be cut clean, with slopes smooth and undisturbed. This machine was especially designed to meet these requirements. One horse and wheel traveling in point of ditch, the other outside the bank of earth. Operated by one or two men and two or four horses.

If you have an irrigation problem to solve, do not fail to write for full information concerning this Combined Grader and Irrigation Ditcher.

Address

C. D. EDWARDS, Albert Lea, Minn.



"BALL BAND"



The Cost of Dry Feet Is Low When You Wear "Ball-Band" Boots

If your rubber footwear costs you too much money, maybe you are wearing the wrong kind. Eight million men wear "Ball-Band" Rubber Footwear and they are satisfied with "Ball-Band" wear and service.

Every day's wear that you get out of a pair of boots costs you so much. "Ball-Band" Boots give more days' wear and therefore cost less than others.

Look for the Red Ball on the knee—that's the trade-mark of "Ball-Band" Goods. If you don't see the Red Ball you are not getting "Ball-Band" Quality.

Ask your dealer about "Ball-Band" Footwear. If he doesn't sell it, write us and we'll see that you are supplied.

Write anyway for Free Illustrated Booklet about "Ball-Band" Rubber Footwear.

MISHAWAKA WOOLEN MANUFACTURING CO.
346 Water Street, Mishawaka, Indiana

"The House That Pays Millions for Quality"

The Faithful Friend

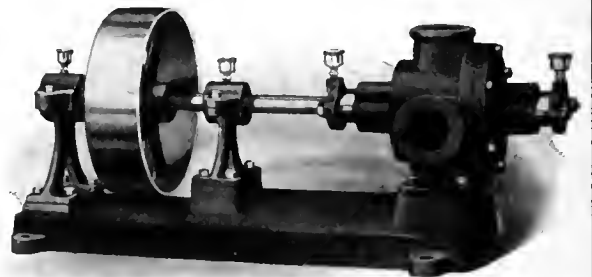

Do not be contented until you have the best, as these pumps have a good suction lift, with capacities of 12 to 500 gallons per minute, automatic take-up for wear, and free from springs or small parts that cause trouble.

SEND us your pumping proposition today, and let us quote you on the best pump made

Blackmer Rotary Pump Power & Mfg. Co.

PETOSKEY, MICHIGAN

Twenty-Ninth Year

THE IRRIGATION AGE

VOL. XXIX

CHICAGO, MARCH, 1914.

No. 5

THE IRRIGATION AGE

With which is Merged

The National Land and Irrigation Journal

MODERN IRRIGATION
THE IRRIGATION ERA
ARID AMERICA

THE DRAINAGE JOURNAL
MID-WEST

THE FARM HERALD
THE IRRIGATOR

D. H. ANDERSON
PUBLISHER,

30 No. Dearborn Street, CHICAGO
Old No. 112 Dearborn St.

Entered as second-class matter October 3, 1897, at the Postoffice at Chicago, Ill., under Act of March 3, 1879.

D. H. ANDERSON, Editor

ANNOUNCEMENT.

The "Primer of Hydraulics" is now ready; Price \$2.50. If ordered in connection with subscription \$2.00.

ANNOUNCEMENT

THE IRRIGATION AGE has absorbed the entire paid circulation of the Water Users' Bulletin, published until recently by the National Federation of Water Users' Associations. Each subscriber to the Bulletin will receive THE AGE for the full term, for which his unexpired subscription payment entitled him to receive the Bulletin. The subscribers to the Bulletin included Water Users on every government project and persons interested in irrigation affairs, living in all parts of the United States. The circulation of the Bulletin was transferred to THE AGE after the Executive Committee of the National Federation of Water Users' Associations had created THE IRRIGATION AGE its official organ.

**They're
Breathing
Hard;
Fight**

they are almost without hope. They have seen promises and contracts, made by the representatives of their government, broken at will so often that they now seem to think any effort to protect what rights they may still have or any action to win back those rights of which they have been robbed would be simply wasted. They have seen incompetency and

"It is almost impossible to get our water users together for any kind of a meeting. They have been burdened, down-trodden and enslaved by the rules and regulations of the Reclamation Service bureaucracy until

SUBSCRIPTION PRICE

To United States Subscribers, Postage Paid, \$1.00
To Canada and Mexico, 1.50
All Other Foreign Countries, 1.50
In forwarding remittances please do not send checks on local banks. Send either postoffice or express money order or Chicago or New York draft.

Official organ Federation of Tree Growing Clubs of America. D. H. Anderson, Secretary.

The Executive Committee of the National Federation of Water Users' Associations has taken action whereby the Irrigation Age is created the official organ of this vast organization, representing 1,000,000 persons on the government irrigation projects.

Interesting to Advertisers.

It may interest advertisers to know that The Irrigation Age is the only publication in the world having an actual paid in advance circulation among individual irrigators and large irrigation corporations. It is read regularly by all interested in this subject and has readers in all parts of the world. The Irrigation Age is 29 years old and is the pioneer publication of its class in the world.

gross and inexcusable errors of the Reclamation Service excused and condoned at Washington and the cost of the ignorance or mistakes piled upon the settlers, and when it is suggested to them that there is still justice in the United States and that they can get it if they will make a determined stand, they laugh—hollow-like, and slink back into their homes like frightened coyotes."

This is an excerpt from a letter from a prominent man on one of the Federal projects. Perhaps he drew his word picture too strongly. Perhaps his own feelings got the better of him, as he pictured conditions about him. But has he not told some truths about your project, Mr. Federal Water User, and about every government project?

You have had much to discourage you. You have had difficulties that would make almost any strong man wince. You have overcome many of nature's most serious obstacles. You have made the desert bloom, despite broken promises concerning the amount of water you were to receive; despite ignorance in construction of the main irrigating works, which wrought destruction or damage to your farm. You have made the beginnings of a home for yourself and your family in a country upon which the great Creator has bestowed some of the best of air, sunshine and soil. You have done real

pioneering—harder than did your ancestors, and you did not falter. Neither did your good wife nor your children.

Are you going to quit now, Mr. Federal Water User? Of course not. This is the time to fight, not to snivel or skulk away. You have shown the stuff you are made of by your courage in tackling the desert. You are not going to let a Reclamation Service, or a Department of the Interior, or a congress, or even the whole administration at Washington frighten you. You are going to fight and fight hard for the rights to which you are entitled; for the justice that belongs to you. And you are going to get it.

This government is founded upon justice. It has lived and thrived because its very life blood is justice. There is justice for you at Washington and you must get it. It cannot be withheld from you, once you unite with your brother water user; stand with him and with every other man on your project, shoulder to shoulder, and in common voice make known your demands. Don't waste your fire. Concentrate it. No battle was ever won by desultory firing. Go to the meetings of your local water users' association. Get your neighbor to go. Make it a live, red blooded organization that means something to the project; whose voice will be the voice of real votes, when it speaks to your congressman or senators or to the administration at Washington. See that your water users' association belongs to the National Federation of Water Users' Associations; see that it contributes its share of the funds needed to keep the national organization right up in front and fighting seven days a week.

The government census figures show 1,000,000 people in the zones of the Federal reclamation projects. Your water users' associations represent most of these. One million people. Present yourself, through your National Federation officials, in Washington as the true and thoroughly organized voice of this million of people, and the administration, no matter what may be its politics, will be only too glad to see that justice is done for you and yours. There will be no flimsy excuses of promises made by men, now mostly dead or gone, by which tremendous costs are assessed against you and your lands to pay for the mistakes of incompetent reclamation engineers. No one will dare to try to perpetuate for another generation the army of pay-rollers who are now ruling your project and adding each year to the cost of your farm. No one will have the audacity to stand up and declare you should go on paying the tremendous overhead charges now assessed against you to keep sleek, whiskered gentlemen on handsome salaries. No one will try to heal your wounds by honeyed words

or ask you to adjudicate your rights in a packed court.

The opportunity to clear the decks of all the burdens of Federal bureaucracy under which you have labored and struggled is here. Take off your coat. Roll up your sleeves. Fight! Somebody hit the smirking Reclamation Service an awful jolt when they let the Smith Reclamation Extension bill get into congress. The man who drew that bill ought to have a monument erected to him by the Water Users. The man who induced Secretary Lane to write his letter telling what he would do for the Water Users and to the Water Users if the Smith bill passed is also entitled to a monument.

Those two documents have spilled the beans and spilled them good. There is no longer any reason for not telling the truth and the whole truth about what you have been bumping into ever since you settled on a government project. Tell congress the whole truth about your own case; have your association tell congress about the struggles of every man on your project, and about their burdens; have your association, if it is not already a member, join the National Federation so your voice will be part of the united whole—a voice that will echo and re-echo in the halls of that old white marble capitol down there in Washington.

Do this and it won't be the dust shaking from the cobwebs in the dome of the capitol that you will see. No! brother, it will be the dust of the administration, of the senators and the congressmen racing to be first in giving you a square deal.

Get out and fight, Mr. Federal Water User. This is no time to quit. They've almost put themselves out by bumping their heads on the Smith bill and the Lane letter. Amid their gasps they have written the "Conference" bill. All that is needed now is one good, hard crack on the solar plexus by the united Water Users, and you'll get all you and your neighbors are entitled to in justice and equity from congress and the administration. Give it to 'em!

**Some
Real
Facts
Dodged**

Under title of "Reclaiming the Great American Desert," a number of newspapers have recently carried a half page story, with a handsome layout of pictures. The stories and picture-layouts are all alike, thus once more proclaiming to the world the tremendous ability of some man, whom P. T. Barnum overlooked, to put over press agent stories about the United States reclamation service. The identity of this press agent should be revealed.

This half page story relates among other things: "In a period of ten years of actual construc-

tion the service has dug 8,000 miles of canals, many of which carry whole rivers, like the Truckee river, in Nevada—.”

The remainder of the sad story about the Truckee river carrying canal is kept a deep, dark secret. The canal has been dug, and during flood water periods carries most of the river, but in the summer, when the farmers on the Truckee-Carson project need water for their crops, that canal is valuable for little else except as a monument to some one's lack of brains. Director Newell, Chief Engineer Davis, and some other high officials, have been on the Truckee-Carson project many times, but never yet have they been able to wave the magic wand that will make the canal carry the Truckee river when water is really needed. Instead, these estimable gentlemen discovered, after they had spent a fortune in digging the canal, that the settlers along the Truckee river, with prior rights, used up all the water, or practically all of it, before the mouth of the government canal and the diversion dam is reached.

The bottom of the canal did get a bit wet last summer because settlers on the Truckee-Carson project were able to induce their big-hearted neighbors along the Truckee river to let the government project farms have the Truckee's waters for two days a week. Being good citizens and anxious to help their fellow men, the Truckee river farmers did this to save at least part of the crops of the homesteaders, down in the government project.

It is possible that in time the Truckee-Carson project will be so rebuilt that a storage reservoir will be created to hold the flood waters of the Truckee for the benefit of the government project Water Users. Then this "river carrying canal" will be of value, and worthy, no doubt, of a press agent's laudations.

Meanwhile, perhaps, a wise congress will have relieved the Federal Water Users of paying the salaries and expenses of reclamation press agents as well as numerous other overhead charges, which on all other government works come out of the general fund.

**Federal
Water
User Is
Forgotten**

Careful study of the report of the Fletcher Commission on Rural Credits and the bill on this subject, generally credited to the administration, fails to reveal any help for the Federal Water Users.

Under the proposed legislation only lands that are unencumbered can be used as security for loans in the proposed Farmers' Banks. As the reclamation law is now construed by the Department of the Interior, the Federal Water User is denied right

to any benefits under the proposed measure. The water right applications have been so drawn as to make them nothing less than cut-throat mortgages. And now it is proposed to make these mortgages run twenty or twenty-five years more. If certain officials of the Reclamation Service accomplish their purpose of perpetuating the bureaucracy, which now rules the government projects and the settlers, these mortgages are liable to be made perpetual, a never ending security for operation and maintenance charges.

This must be changed. The economic fiction that the settlers' right to have water supplied from the government ditch to his land, is a liability, is wrong. This water right is a franchise, an asset of great value. It should be so considered. In cities, franchises to run street cars or string light, power or telephone wires are recognized as of tremendous value, despite their accompanying obligations to the government granting them, and are the basis for bond issues of vast amounts.

The right of a farmer on the federal project to have water delivered to his land is, in proportion to its producing power, of far greater value, and this value should be recognized, instead of being held as a constant impediment to his progress and welfare. If this is done, and there are able heads in congress who can do it, the federal projects will quickly become independent; the farmers will have the credit to which they are entitled and they will be able to get money at will.

We believe that the government has no moral right to exact a mortgage on the land of the settlers as security for the charges for water. The settler should be permitted to prove up on his land in accordance with the homestead laws and be given clean and clear title to his holdings.

The franchise to receive water which he owns, should be sufficient security for the water right charges.

**The Sad
Plight of
Director
Newell**

F. H. Newell is to the average Federal Water User like a red rag before the eyes of a bull. This is too bad, and yet Mr. Newell is himself largely to blame. No one but a remarkable dreamer; one who could spend millions without a thought as to where the millions to pay the bills might come from, would have conceived and dared construct the vast engineering monuments to be found upon the Federal Reclamation projects. If Mr. Newell had stuck strictly to engineering, the Water Users no doubt would have forgiven him and in the end might even have highly honored him, for it is the nature of us Americans to take pride in our great governmental works, even though we are aware

that they cost many times over the amount for which private capital could have constructed them. But no, Mr. Newell must have a part in the management of these projects; he must show the settlers how to run their farms; he must help Congress frame laws to make the Reclamation Act of 1902 read just the opposite to what is the commonly accepted meaning of the words and sentences of the English language, in which the bill is written. As a result, in the words of an old Helena, Mont., friend of ours, Mr. Newell "has got himself in the middle of a bad fix."

Change This Kind of Public Thought

Here is an editorial squib from the Norfolk, Va., *Virginia-Pilot*: "That million-dollar appropriation for investigating irrigation reservoirs in the middle west partakes, in a way, of the nature of throwing good money after bad. There has so far been no iota of occasion for the federal government to engage in reclamation work, and the sooner it gets out of it the better."

The Federal Water Users are not to blame for this sad condition of public thought in the east and south concerning government reclamation. Such editorial expressions are due to the incompetency with which vast portions of the \$81,000,000 or more of funds, derived from the sale of public lands in the arid states, have been spent. Once this incompetency is eliminated from the United States Reclamation Service and responsibility for the foolish mistakes and waste is fixed, confidence in Federal reclamation will be restored. Then the south and the east will again take pride in the government's efforts to reclaim the desert, and will give this great work the support it is entitled to, when done honestly and efficiently.

Hunting Source of False Information

We find that the Milwaukee Daily News, one of the newspapers which printed a three-column picture of the Reclamation Commission under the caption: "New Reclamation Commission, Composed of Experts, Makes Good: Settlers Who Were Dissatisfied, Complain No More," obtained this layout from the Central Press Association of Cleveland, O. We are now endeavoring to learn from this press association who in Washington was responsible for the information that all is peaceful and rosy on the Government irrigation projects and that the settlers have no complaints to offer.

We are determined, if possible, to reach the source of such information as this particular layout and others of its ilk carry to the citizens of the East. We believe in giving the Federal projects a boost

wherever and whenever possible, but we are against inducing any man to settle on one of these projects through false publicity or deception.

There is also a still greater peril in the spreading of false information concerning the conditions of the Federal Water Users. This lies in the impression it makes upon members of Congress not directly concerned with the affairs of the Water Users. Their votes are needed to pass any measure of relief that the Federal Water Users may obtain, and they will not consent to aid such measures until they are made fully aware of their real need.

One official of the Reclamation Service, who has much to do with its publicity work, promptly disclaimed any responsibility for the "Settlers Complain No More" layout.

They're Again at the Old Game

Watch out for the back firing!

Letters have begun already to come into the IRRIGATION AGE office, some of them honest, no doubt, and others plainly inspired, declaring that the February issue of the AGE, in which some plain truths were told about the difficulties of the Federal Water Users under the bureaucratic rule of the Reclamation Service, had "put a different color" on the story of living on a government project. There will be more of these letters. Out on the projects, too. Reclamation officials, in more or less diplomatic language, will preach of the great harm to Federal Reclamation and the projects the AGE is doing in telling the truth about conditions. It is an old, old method. The Reclamation Service has thrived by this sort of back-firing almost from its inception. It has on its payrolls one high-salaried man, who for years has done little else but visit the projects and bring pressure to bear to suppress the truth if it was thought that truth might aid the settlers and injure or weaken the bureaucracy.

"No one outside the projects must know that you or your fellow farmers are having any trouble making it go here, or Congress will stop all the work and never give us any more money to complete the projects," has been the plaint of the Reclamation Service emissaries. And the Water Users and even many Western senators and congressmen have accepted this as the truth. Meanwhile down in Washington the chains of bureaucratic rule have been welded more tightly by subterfuge legislation and departmental rulings.

These chains can only be broken by telling the truth. We believe there is no better or more beautiful country than those portions of the West in which the Federal projects are located. The soil of every one of them is rich and productive. The people living

on these projects are God's own. It is worth while to associate with them.

Once the Czar-like reign of the Reclamation bureaucracy is removed, once the settlers know just what their water is going to cost them and how much land they are to be permitted to retain, once the Water Users are permitted to run their own farms and their own projects and to derive the benefits from their pioneering, which was the original intent of the Reclamation Act, there will be no more pleasant and satisfactory place to live in these old United States than on a government project. When these reforms are obtained, a man will have to look a long ways to find more lucrative or delightful employment than will be found on the Federal project farms.

You Water Users will not suffer by using the truth as your weapon to break the chains which now bind you. And you know, as does the IRRIGATION AGE, you can't carry these chains much longer, however painful may be the truth to Reclamation Officials. So once more we say:

Watch out for the back-firing!

Landlordism and the Federal Projects Supervisor of Irrigation I. D. O'Donnell is quoted in a dispatch from Newell, S. D., on the Belle Fourche project, as stating that the laws governing occupancy of land under the Federal Reclamation projects will be changed so as to conform somewhat to the Irish landlord laws. We don't profess to know a whole lot about landlords in Ireland or the laws under which they operate, but our idea has always been that a man went out into the desert and attempted to create a home for himself and his family in order to get away from landlords. We believe that the men and women with strength and courage enough to homestead on a government irrigation project are also strong enough to boss themselves and are anxious to get rid of even dear, kindly old Uncle Sam as a landlord as soon as possible. The intent of the reclamation law of 1902 is very plain in providing for the ultimate independence of the Federal project settlers and for their control of the projects. Is it need of salaries or lack of confidence in the settlers—most virile of all Americans—that brings forth these landlord legislative plans and other paternalistic dreams?

Be Sure to Attend Lane's Conference The conference of Western governors and others interested in irrigation which Secretary Lane has called to meet in Denver April 9 should be fraught with big results for Reclamation in the West. Mr. Lane is fathering a big idea and a most patriotic one in suggesting

this meeting. The IRRIGATION AGE commends Secretary Lane for conceiving this plan. Practically all the Carey Act projects are on financial rocks. So are many privately constructed projects. New irrigation work is practically at a standstill. These conditions mean suffering to millions out on the projects and loss, and perhaps equal suffering to many of the bond holders. The National and state governments should act immediately to give irrigation securities stability, to restore confidence in irrigation project building and to provide funds to complete abandoned projects and to construct new ones. There will be little monetary profit for Federal or state government in this work, no doubt, but vast profits to the National government and to the states will result from the added values to the lands, once they are brought under intensive cultivation, and from the growth in population. The costly experience gained in Federal Reclamation will prove of value in this new work, and the mistakes made in the past offer no honest or valid argument against tackling this new and bigger job. Every arid state governor and as many delegates from these states as possible should attend this conference.

Abel Ady writes to us from Washington that Secretary Lane is anxious and ready to give the Federal Water Users everything they want, so far as Congress will permit. We have a great deal of respect for Mr. Ady's judgment and hope all he says proves true. Mr. Lane has the administration behind him, and the Administration can get from Congress almost anything it wants, as has been proven by the tariff and currency bills. We trust, therefore, that Mr. Lane's bashfulness or reluctance to ask favors will not prove greater than his generosity.

Forty million dollars or thereabouts, the cost of mistakes and incompetency, are involved in the Reclamation Extension legislation now before Congress. On all other government works, such expenses are charged off the books, or the parties responsible for the losses are made to suffer. Why not do the same with the Reclamation projects instead of trying by subterfuge to make innocent settlers pay for these mistakes?

A large part of "Official Washington" is still trying to solve the big mystery: "Who inspired Secretary Lane to write his now famous letter to Water Users?"

It has been suggested that some of our best little Reclamation officials might be indicted for running a confidence game.

"We have just begun to fight."

LANE CONFERENCE, APRIL 9

Western Governors and Others Will Meet to Stimulate Irrigation

Secretary of the Interior Lane's plans to stimulate the growth of new irrigation projects in the west and to place existing irrigation securities upon a sound basis is bearing fruit. At his suggestion, a conference to be attended by the Governors of the arid states, by delegates they may select, others interested in irrigation and by representatives of the Secretary will be held in Denver on April 9. The governors of Arizona, California, Colorado, Idaho, Montana, Nevada, New Mexico, Oregon, South Dakota, Utah, Washington and Wyoming have all practically agreed to be present. Many men prominent in irrigation affairs in these states will also attend.

In his letter to the arid state governors, Secretary Lane emphasized that irrigation development has reached a stage of stagnation in the West through faulty promotion, where future prosperity demands drawing upon state or national funds.

Mr. Lane's letter says in part:

"A review of the progress made in irrigation development during 1913 and of the relative stagnation both in the construction of new works and in the settlement and utilization of lands already irrigated in part by old works shows that it is important that well-conceived efforts be made toward remedying existing difficulties and stimulating growth by irrigation, so essential to continued prosperity in the West.

"It is now fairly well recognized that while some of the large irrigation enterprises have been successful agriculturally, nearly all, especially those requiring water storage or other extensive works, have been failures financially.

"Owing to this fact, there are large amounts of stocks and bonds held by Eastern and foreign investors upon which interest is defaulted. Thus there is at this time little hope of securing additional capital for similar developments.

"A study of the entire situation shows that expenditures in large irrigation works can hardly be made with a view of obtaining safe or adequate financial returns to the investors.

"It is true that large profits are reputed to have been made by promoters from time to time in the organization and floating of some of these large schemes, but the men who actually put in money and those who ultimately purchased the stocks and bonds to a large extent have lost their investment.

"It appears therefore that no further large development can now be expected unless it is (a) by the use of public funds, state or national, upon which no profit or interest is required, or (b) by the use of funds procured by taxation, as in the case of irrigation districts, and where, also, the question of profit and interest on the works themselves is the increased land values and productivity of the soil.

"These statements cover in a broad way the present irrigation situation. The commissioner of the general land office in a report recently has called attention to another phase of the subject, saying: "There seems to be a growing tendency among states to co-

operate to the end that there may be uniformity of procedure in this branch of the work (Carey Land and Irrigation act)."

"Three or four prominent persons authorized to speak in this connection have suggested that a Carey act convention or conference be arranged under the auspices of this department, to meet either in Washington or at some central point in the West, to take up and consider carefully the whole situation, especially as it may relate to the uniform practice along certain lines by the states.

"It is evident that there is a great need for a full understanding of the present situation, whether it pertains to the Carey act projects or to other large enterprises, such as those initiated under the terms of the Reclamation act.

"With this in view, I desire to suggest to you and to governors of other states containing arid lands the desirability of holding a conference in the near future at some convenient point at which may be present persons representing you, and also officials of the state land boards or other state officials having to do with the Carey act or related work.

"It may be also desirable to have present men who represent the contractors who have entered into arrangements with the state to build one or more of these Carey act projects and representatives from the Water Users themselves wherever there is an organization which can properly designate such persons.

"If such a meeting can be agreed on, persons representing myself can be present, together with officials from the bureaus under my charge, notably the General Land office, the Geological Survey and the Reclamation Service.

"It is believed that the outcome of a full, free discussion of some of the larger problems will be of very great advantage in the comprehension of these matters and will lead to beneficial results in the development of the West in irrigation."

IRRIGATE WITH WINDMILLS

The first experimental irrigation plant to be established in Kansas under the new provisions of the law enacted by the last legislature is in operation two and a half miles north of Leoti, Kan., in Wichita county. The plant is under the direction of the State Board of Irrigation. The legislature appropriated \$125,000 for experimental irrigation work.

The Wichita county plant is a windmill proposition. Six improved windmills furnish the power that pumps water from underground, lifts it 74 feet and throws it into a reservoir 100 by 150 feet in size and six feet deep.

The cost of the plant complete was only \$1,000. It will irrigate a farm of 160 acres which the state has leased for the experiment. The reservoir will be kept full of water all the time by the windmills. It is expected that the cost of the plant will be returned to the state in one season by the sale of crops from the irrigated land.

If this plant is successful it will result in thousands of such plants being built in Western Kansas, as the underground water exists almost everywhere.

THE FEDERAL WATER USERS

A Department Devoted to the Interests of the Farmers on the
Government Irrigation Projects

Edited by Geo. J. Scharschug

WHAT ACTUAL WATER USERS THINK ABOUT THE RECLAMATION EXTENSION LEGISLATION

RECLAMATION extension legislation has been a very live topic in Washington, since the introduction of the Smith bill in the house, accompanied by the issuance of Secretary Lane's letter, announcing his proposed policies in handling the Government irrigation projects. The proposed legislation has been an equally live topic among the water users and every representative in Congress from the Federal project states has heard from home concerning one or more of the bills, specially, and in no uncertain terms as to what legislation should be embodied in whichever bill is finally passed.

The storm raised by the introduction of the Smith bill was followed by the introduction in the senate of the Newlands bill, which took much of the sting out of the former measure. This was followed by a series of conferences between Secretary of the Interior Lane, Senator Mark Smith of Arizona and Representative W. R. Smith of Texas, chairmen, respectively, of the senate and house irrigation committees, other members of these committees and the Reclamation Commission. Federal Water Users, who were in Washington, also advised with Secretary Lane and members of congress. The results of these conferences is a bill, remarkable for its complicated verbiage and for a number of its features. Several of the objectionable features of the Smith bill have been eliminated. The National Federation of Water Users' Association is victorious, at least in part, under this bill, in its fight for the appointment of the Water Users' association as fiscal agents. The "conference" measure, however, is drastic in its "penalties" for failure to pay water charges, and in its provision for regulation of the projects and the Water Users by the Secretary of the Interior. The bill also provides that all forfeitures of water right or operation and maintenance payments and rentals for water on projects, not yet formally opened, shall go to the general reclamation fund, instead of accruing to the benefit of the individual projects from which these funds come and to the Water Users living on these projects.

Because all the measures providing for the extension of Water Right payments to cover twenty years are still very much alive, and all embody similar features, the appended symposium of opinions by men, prominent in the affairs of the Water Users, and all of them actual farmers on the Federal projects, is of great value. The "conference" bill is the one most likely to pass Congress, but no reclamation measure should be permitted to pass, until every Water User has had opportunity to study it carefully, and every Water Users' association has had a chance to voice the opinions of the farmers on the projects concerning it. The Water Users also should have a full public hearing either before the senate or the house committee on irrigation on this and the other extension bills being considered.

Read what these men say about the legislation proposed.

LOOK BENEATH MASK OF RELIEF

By **Fulton H. Sears**
(Fallon, Nev.)

Member of the Executive Committee of the National Federation of Water Users' Associations.

If the Water Users under the National Reclamation Act have heretofore been deceived in what they expected to get, by what they really did get, in the operation of this original law, which is, on its face, a plain, meritorious and just law; if uncertainty has existed under this, what can we expect from the new one now proposed, which is heralded everywhere as a relief measure?

The relationship between the Water User and government is first of all, one of debtor and creditor. All had a right to expect honest representations in law and in fact, and the keeping sacred all contract obligations. It is not necessary to describe what has been done in the past, as it is well known. The bills agreed upon by officials in Washington that count are known as Senate No. 4628, and H. R. No. 13921. The real meat and purpose of this legislation is contained in Sections 2 and 4, which read:

"Act Shall Apply to Existing Projects.

"Sec. 2. That any person whose land or entry has heretofore become subject to the terms and conditions of the Reclamation law shall pay the construction charge in twenty annual installments, the first of which shall become due and payable on December first of the year in which the public notice affecting his land is issued under this Act, and subsequent installments on December first of each year thereafter.

"Increase of Charges.

"Sec. 4. That no increase in the construction charges shall hereafter be made, after the same have been fixed by public notice, except by agreement between the Secretary of the Interior and a majority of the water-right applicants and entrymen to be affected by such increase, whereupon all water-right applicants and entrymen in the area proposed to be affected by the increased charge shall become subject thereto. Such increased charge shall be added to the construction charge and payment thereof distributed over the remaining unpaid installments of construction charges."

There can be no question but the fair interpretation of this means a new public notice shall be hereafter issued, covering all the actual cost of the project and not the estimated cost, as required in the original Act. When this is done they say it can not be changed again without consent. There is no question but what the Water User who is compelled to accept this relief will be required to consent to have his charges raised. Is this an honest transaction? Does it not resemble a loan shark deal, when extension is asked, to squeeze the very life out of the unfortunate homsteader? Can a loyal citizen respect his Government when such things are done under the guise of relief? If our Government feels that an extension of time of payment is just, why do they not say so in a clean-cut way, and not hoodwink the people into believing they are extending charity, when in fact they are demanding usury and adopting Shylock tactics against those who are helpless?



Fulton H. Sears

extension is asked, to squeeze the very life out of the unfortunate homsteader? Can a loyal citizen respect his Government when such things are done under the guise of relief? If our Government feels that an extension of time of payment is just, why do they not say so in a clean-cut way, and not hoodwink the people into believing they are extending charity, when in fact they are demanding usury and adopting Shylock tactics against those who are helpless?

MUST RESTORE CONFIDENCE

By **Scott Etter**
(Carlsbad, N. M.)

Member of the Executive Committee of the National Federation of Water Users' Associations.

The IRRIGATION AGE has asked me to say something about my recent visit to Washington in the interest of the Federal Water Users, and, although I am reluctant to speak just at this time concerning many matters of vital interest to so many individuals, I feel that possibly more people can be reached through the AGE just at this time than in any other way.

First of all, I found that the IRRIGATION AGE, in its recent campaign to establish the rights of the Federal Water Users, is becoming a power in Washington second only to the National Federation of Water Users' Association itself. Many congressmen have it upon their desks, and it will soon be read by all "official Washington."

From my observation while there, I am firmly convinced that House bill 11906 will never pass in its original form, and I believe this is the best news that I can convey to the Water Users. Better that we stay under our old contracts than to get this twenty-year extension with the drastic regulations and bureaucratic authority which went with it.

I find that both Houses of Congress, through their committees, are willing to give us the twenty-year extension, and they want to give us some of the freedom also to which we are entitled. I met the committee in both Houses and my criticisms of the bill in its original form was not only received with interest and courtesy, but a new draft was promptly printed to meet our suggestions as far as seemed possible at the time.

I believe that Secretary Lane is also with us at

heart, and if he would always remain Secretary, the great authority granted in the original draft of the bill might not be of detriment to any person; but if Mr. F. H. Newell's picture had been engraved at the top of the bill when it was printed, it would not have thrown any greater scare into all concerned than did the language it contained.

Right here I desire to say that I think the greatest mistake the National Water Users have ever made was in not demanding the removal of Mr. Newell last summer when they passed unanimous resolutions in the city of Washington, as everybody knows that the only reason this request was not made was for policy only, and the belief that he would go without it. The Secretary will never create the complete confidence in his administration which it deserves while Mr. Newell remains as head of the Commission. It makes no difference whether Mr. Newell is right or wrong in his policies, he has lost the confidence of the rank and file of the Water Users, and it will take much to recover it.

You ask me why I am such a strong advocate of the passage of an act to make the Water Users' Association the Fiscal Agent of the government in this matter.

I can best answer you by giving a concrete example on the Carlsbad Project.

On the Carlsbad Project there are 20,256 acres receiving or entitled to water. The maintenance assessed and collected for the past two years has been one dollar per acre or a total of \$20,256.

Under the management of the Reclamation Service the salaries paid in the Carlsbad office are: Project Manager, \$175 per month; Assistant Manager, \$125 per month; Fiscal Agent, \$110 per month; stenographer, \$75 per month; janitor, \$45 per month. This comprises the office force in Carlsbad alone, and does not account for the Project's proportion of the salaries of the District Engineer, the Supervising Engineer, the Commission, the Consulting Engineer to the Secretary and the field offices and men.



Scott Etter

This small item amounts to \$530 per month or \$6,360 per year.

In addition to this, the Project pays one ditch rider \$100 per month, three ditch riders \$90 per month, one ditch rider \$85 per month, one watchman \$70 per month, one watchman \$60 per month and one foreman \$115 per month. (Besides this there are several other foremen and bosses not enumerated, because their work is not permanent.)

This makes an additional salary list of \$700 per month or a total of \$8,400 per year.

It will be reasonable for this statement to allow for one more foreman only at \$100 per month, or \$1,200 for the year.

You now have upon this little project an annual salary account of \$15,960.

This immense sum, \$15,960, expended for salaries and bosses out of a total collection of \$20,256 for maintenance leaves the magnificent sum of \$4,296 for *ACTUAL MAINTENANCE* of the canals, laterals, ditches, etc., on this Project.

I do not believe this proportion would be successfully maintained in any private business, and if the Reclamation Service is to show the people that the government can successfully conduct this business it will have to change its methods.

An investigation of the records of the government for the same Project will disclose the fact that at the close of business in the year 1913 this same Project had a deficit of \$45,180 charged up against it for operation and maintenance. Do you wonder why? What will the innocent settlers on this Project think of the Reclamation Service some of these fine days, when they are called upon to meet this deficit? Do they think now that they are paying their maintenance in full? They do. Were they advised all of the time that their maintenance was actually about \$2.25 per acre, instead of \$1.00 per acre? They were not.

If the Water Users' Association was made Fiscal Agent, the people would then know the facts from year to year, and expenses might be cut.

This same Project was operated by private capital (the Pecos Irrigation Company) in the year 1903, prior to the time of the Reclamation Service, and under that management the total operation and maintenance expense was \$14,546.61, including salaries of all employes. Still, they say that the Water Users are not competent to operate a project. From this comparison, could they do worse than the Reclamation Service has done? The new bill must provide for the Water Users as Fiscal Agents and for the turning over of all the operation and maintenance possible, and thus do away with this bureaucratic control and mismanagement.

NEWELL IS TREMBLING

By Earl B. Smith
(Somerton, Ariz.)

President of the National Federation of Water Users' Associations.

I want to convey to the readers of the IRRIGATION AGE my analysis of the real situation. I state them as my final conclusions. I want your closest attention, and if you approve I want your help to disseminate the doctrine as widely as possible, for I know of no other argument that is likely to prevail, and I am compelled to admit that we have so far completely failed in our efforts with the secretary.

In the second annual report of the Reclamation Service Mr. Newell comments on the estimated cost provisions of the law. He says that the "estimated cost" provision is a wise one for the reason that it puts everything on a business basis, and leaves the impression that he interpreted it just as we interpret it today. That was along in 1903 or 1904. Then, in 1909, when he issued his booklet of questions and answers, he says:

90. Q. How are the water charges of the water rights determined?

A. These are fixed as *required by the law*, according to the estimated cost of construction of the works.

91. Q. When will the cost of the water rights be announced?

A. The public notice required by section 4 of the act will be issued before water is ready for delivery and *when the work is sufficiently advanced to make an accurate estimate of the cost*, etc.

This view of the matter, of course, changes the estimated cost into actual cost, but this doctrine was not announced until about five years after what he stated in his second annual report.

He was forced to resort to this doctrine after he had found out that his estimates were worthless. In no other way could he make his books balance, for he must show assets equal to expenditures, and he assessed the difference between the estimated and actual costs to the farmer.

He is now trembling in fear that his doctrine will not be accepted by the public or by congress, so he is resorting to a legislative construction measure in his so-called extension bill. He has worked this same scheme once before successfully and he expects to work it again. The first time he worked it was when he prepared and laid the foundation for annulling section 6 relating to the use of the fund for operation and maintenance until the works are turned over to the land owners. In the various acts for watering Yakima and other Indian lands he had incorporated in those acts the following clause: "Such payments shall be in addition to the charges for construction and maintenance of the irrigation system made payable into the reclamation fund by the *provisions of the Reclamation act.*" There were no such provisions in that act. Congress paid no close attention to the matter, supposing the department knew what it was about in the watering of those Indian lands and never knew, and don't know today, that they were imposed on in enacting a clause which was as false as could be. This same clause was inserted time and time again in the various Indian bills and no one questioned but what the Reclamation act did so provide. When the Baker vs. Swigart case came up the government pleaded that clause in those various Indian acts as being a congressional legislative construction of what congress meant, or, in other words, the intention of congress on the subject. The Supreme court heeded that plea in one of the most expert arguments I ever read. By this construction the meat of section six was annulled, but was not declared void for any reason, but simply made to read exactly the



Earl B. Smith

opposite from what it says. I claim that congress passed those Indian provisions entirely ignorant of the purpose of that particular provision and did not intend to pass a legislative construction act.

Now we come down to the estimated cost proposition again. The Smith bill provides as follows. "(f) Regarding the method of determining the charges per acre on the several projects so as to recover *all expenditures which the Secretary of the Interior shall find to have been made on account of the project.*" If Mr. Newell gets that provision through congress he has then got a legislative construction of what congress intended in providing for the estimated cost in the original act. That provision glosses over his whole ten years of maladministration and legalizes all the graft, incompetency, extravagance and inefficiency of ten years duration and at one fell swoop charges the whole thing to the homesteader and western landowner, the very men the act of 1902 intended to aid.

This sly legislative construction business is a new art in legislation, and for ways that are dark and vain, the Chinese are not in it. When we get into court on the estimated cost we will be met with this constructive measure of an act passed by a previous congress ten years back. But if congress passes this measure it will not know what it is doing, but will be made to think that it is providing for and conserving the fund against those who might be disposed to cheat the government out of its just due, whereas the real purposes is to let the Service get away with the swag without getting caught. Yes, and have it all charged to the farmer. A bigger bunco game was never pulled off in the days of '49.

I never believed very strongly in the extension plan. It would not have been necessary if the contract price had been kept with the farmer. It is only necessary because the government has not kept to its agreements and has not followed the law.

SIMPLY A "BIG STICK"

By O. E. Farnham
(Belle Fourche, S. D.)

Secretary of the National Federation of Waters Users' Associations.

To my mind the Smith bill is in no way a relief measure, except so far as the reclamation service is concerned. It is simply a "Big Stick" with which the Department of the Interior can force the individual Water Users into submitting to all the expenditures that the department may find to have been made on account of any project, regardless of the vested rights of the Water Users or landowners under the Reclamation act and the acts of the Secretary of the Interior in accordance therewith, and in total disregard also of whether such expenditures have been legitimately expended and properly charged. The enactment of the law as drawn, if put into operation as suggested by Mr. Lane in his communications to the Water Users, will result in confiscation of property rights in some projects. Its general plan is in full accord with Mr. Newell's cherished ideas—to prevent a congressional investigation of the Reclamation Service by placing the matter entirely

in the hands of the Department of the Interior, and thus save the heads of those responsible for many grievous wrongs committed. The government is entitled to know how the reclamation fund has been handled during the past decade, for the protection of the fund in the future, and these matters should be thoroughly investigated by a nonpartisan body. In the interest of the government as well as the Water Users I most earnestly protest against the passage of the measure in its present form.

AVOID HARSH PENALTIES

By Francis G. Tracy
(Carlsbad, N. M.)

Mr. Tracy's article is printed only in part, because of lack of space. His complete analysis of the proposed extension legislation and Mr. Lane's letter is one of the most able documents we have read on the subject of Federal irrigation.—
THE EDITOR.

In Secretary Lane's admirable letter of January 16th, addressed to each individual Water User, he says: "The question always before us is whether or not the United States can successfully conduct a large business enterprise upon business principles without injustice to its citizens and without imposing a too heavy burden upon those with whom it deals."

At the same time there comes to us copy of the proposed reclamation extension act introduced by the Irrigation commission, presumably to carry out Mr. Lane's ideas.

All of us who last spring attended the "illuminating conference" with the secretary in Washington came away thoroughly impressed by the breadth of vision, humanity and singleness of purpose of the new secretary, sobered by the stupendous difficulties of the problems involved, and with the conviction that at last the Water Users had found a friend and brother in authority. This conviction must be strengthened by the most remarkable letter ever received by a group of citizens from a government official. But, in weighing Mr. Lane's conclusions and judging his policies we must not permit our sympathies and our confidence in him unduly to sway our judgment. A secretary is in office a few years. We and our successors are Water Users forever. The office, not the man, is wholly with us. A wrong start now may carry us far astray before it can be corrected.

Multiplying restrictions, interference in details, harsh penalties, severe terms of payment must be avoided as far as practicable. Under present theories of government no direct liability is incurred for injuries once committed. There is therefore all the greater need to avoid injury and wrong doing and



Francis G. Tracy

to give greater freedom and opportunity at every point.

Mr. Lane's letter seems to admit at least in part these general principles; but we believe he fails adequately to appreciate them.

He appears to be unduly impressed by what we believe to be two dangerous fallacies long current in the old regime, namely the so-called duty of enforcing the impracticable farm unit, left entirely to his discretion and surely never intended by congress to be retro-active, and the vision, we might say nightmare, of the hordes of hungry homeseekers.

Would it not be wiser for the secretary to be relieved by congress from all responsibility regarding the farm unit? Is it not as purely an economic problem as free coinage of silver? It is, of course, perfectly proper for congress to limit the bounty of the government as is done in the homestead law. Is it not wholly impossible for congress or for any man to decide what is a proper living for a fellow citizen? When, hitherto, has such a problem been held to be a proper province of any government?

Is not such increased surrender of our personal liberties as proposed a startling doctrine to emanate from a democratic administration? Is it not both unnecessary and unsafe? Does it not give added force to the following statement made by the writer at the Washington meeting: "We believe the proper control for the benefit of all the people of the inevitably increasing concentration of the Federal power in the political government at Washington is a problem fully as serious to the nation as the proper control of industrial power. We believe that our condition offers an illuminating example of the dangerous abuse of this power under present bureaucratic methods. We feel, therefore, that the whole nation is interested in a full understanding of the conditions under which we live; conditions we believe absolutely at variance with the fundamental doctrine of our form of government."

THE SALT RIVER HOMESTEADER

By H. A. Bustrin

(R. F. D. No. 4, Phoenix, Ariz.)

The condition of the homesteader in this valley is a hard one. About seven years ago a party showed me a quarter section of as fine land as anyone could wish. I only had thirty acres and wanted more, but I was afraid there never would be water for the outlying land. I did not have the courage then that others have had since. About 16,000 acres have now been taken in and I believe that 19 out of every 20 farms are owned by real home makers. The balance are in the hands of land grabbers.

The home maker has had 3, 4, 5 and 6 years of hardships and disappointments which would discourage the best of us, but they toiled and held on, turning their faces toward success, which they finally partly realized last spring. To accomplish this they were compelled to make heavy sacrifices which added to their burdens. They borrowed money and built their own canal that the Reclamation Service could give them water. Here is where the injustice really begins. The Reclamation Service compelled

them to do business with them, also with the Water Users' association on the basis of 160 acres.

They formed the Western Canal Company for the purpose of building that canal and each man had to be in good standing with that company, also with the Water Users' association, or the Reclamation Service would not give them water. The dues of the water users were very large and a heavy burden. Some of these people had money and they spent thousands of dollars to make a home and many of those tilled one-half of their land (80 acres) to make final proof which many have done and have their receipts for the full amount (160 acres), and many a tract has since been sold and resold and is now held by innocent persons.

And now comes the Reclamation Service, through Mr. Lane, and says that you can't hold but 40 acres. You must relinquish your excess holdings or assign them to another, which I think is one of the blackest spots on the Reclamation Service pages, and they were already dirty enough. I have no fault to find with Mr. Lane, for he has confidence in Newell, Davis and L. C. Hill, and these three are the responsible ones, for they have recommended the 40 acre unit to him and he believes they are right and has acted, and it was held up for a while, but I do not think Mr. Lane will change unless the homesteaders show him that Newell was talking through his hat when he said that a man on 80 acres broke even and a 160 acre man lost money, and that 40 acres was enough for an Arizona farmer in the Salt River valley. Can we make a living on 40 acres? Yes, but if we have to pay every dollar the Reclamation Service has wasted here we will need more than a living, for we have many mouths (Reclamation Service) besides our own to feed.

WANT CONTRACTS PROTECTED

Water Users on the Truckee-Carson project adopted resolutions endorsing the Newlands bill in part, but demanding that it be amended so as to protect the rights of those settlers who now have contracts with the government, fixing the cost of their water rights at \$22 or \$30 per acre. The resolution says in part:

"Resolved, further, That we consider that section 6 of said bill, taken in connection with section 10, provides by implication at least for an increase in construction charges to be assessed against former entrymen who now hold contracts for the furnishing of water by the Reclamation Service at certain fixed construction charges per acre, and who may now wish to avail themselves of the provisions of the act. We, therefore, call upon our delegation in Congress, Senators Newlands and Pittman and Congressman Roberts, to use their utmost endeavor to have said sections 6 and 10 so amended that it may be clear that former entrymen may secure the benefits of this act without having imposed upon them additional charges for project construction except for betterments made in the future."

A resolution opposing the reduction of farm units to 40 acres on the Truckee-Carson project was also adopted.

CONGRESSIONAL INVESTIGATION ASKED

Officers of the Landowners Protective Association

Lewis T. Carpenter, Counsel

T. T. Powers, President

Sam Barrett, Asst. Secretary



H. A. Bustrin, Vice-President O. C. Thompson, Secretary Charles H. Akers

By Sam Barrett
(Phoenix, Ariz.)

At the inception of the Salt River Irrigation project, the first important preliminary step was the preparation by government engineers of an estimate, purporting to show the probable cost of the enterprise. The figure was placed at three and three-quarter millions of dollars, and with this as a basis, amounting to fifteen dollars per acre on the land proposed to be reclaimed, the settlers in the Salt River valley entered into a contract with the government for the prosecution of the project. Subsequently the scope of the work was enlarged to cover the distributing system and to that end the reclamation officials acting for the government, purchased various privately owned canals, paying therefor, in round numbers, something like a half a million dollars. It may be said here that with one or two minor exceptions, these canals, under the conditions existing at the date of purchase, were nearly valueless for their intended purposes. The Reclamation Service immediately instituted a system of improvements and extensions which are still being prosecuted.

The total cost of the project at this date is close to twelve million dollars and the officials estimate that at least one million more will be required before the work is finished. In addition to this, the water users themselves have paid in and expended nine hundred thousand dollars for the construction of a power plant, which is now nearing completion.

Very early in the prosecution of the work many evidences of incompetence and extravagance became manifest. The offices swarmed with clerks, book-

keepers, stenographers, draftsmen, engineers and assistants of high and low degree, while the outside work was literally clogged with foremen, straw-bosses, timekeepers and teamsters, whose principal duty seemed to be to lie under a wagon six hours a day. Many expensive structures were erected, only to be dynamited out—in some cases, this occurring three or four times with the same structure.

This continued for several years and engendered a widespread feeling among the settlers that the business was not being conducted along the lines of greatest efficiency. The board of governors is the official representative of the Water Users, and to inquiries propounded at different times by members, as to the accrued cost of the project, the inquirers were more or less politely informed by reclamation officials that it was none of their business.

This condition culminated in February, 1912, in the formation of the Land Owners Protective Association, a non-official body of between five hundred and six hundred Water Users, with T. T. Powers, president; H. A. Bustrin, vice-president; O. C. Thompson, secretary, and Sam Barrett, assistant secretary. Charles H. Akers, managing editor of the Arizona Gazette, and Lewis T. Carpenter, attorney for the association, aided greatly in organizing the association.

The object of this association was to ascertain, if possible, the exact status of the enterprise and to procure the abatement of such abuses as might be found to exist. In response to a petition from the association, a sub-committee from the House Com-

(Continued on page 152.)

How One Eastern Woman Views Federal "Landlordism"



Irrigating in Michigan

THE following letter is a remarkable document. It is a message of the true brotherhood of man.

F. H. Sears, member Executive Committee, National Federation of Water Users' Associations.

Chicago, Ill.

Dear Sir: I am enclosing \$2.00, a mite to be sure, to help you in your fight. I don't think the bill will affect me in any way, but nevertheless we should help to bear one another's burdens. I would not want anyone to tell me what crops I should raise as I cannot raise some crops to a profit. I also believe in a careful use of water and use less than anyone here and yet have better crops. Yours respectfully,

Mrs. Fred Osborn



Another View of Mrs. Osborn's Farm

AS ADY SEES THEM

Klamath Man's Observations of Secretary Lane and the Reclamation Commission



Abel Ady

Abel Ady, president of the Klamath Water Users' Association of Oregon, has been in Washington in behalf of his project for several months. He has been in almost constant touch with Secretary of the Interior Lane and the Reclamation Commission. In reply to a number of questions, he has the following to say:

Yes, the Reclamation Board, as a whole, bears every indication of success, and is beginning to bear some of the fruits of success.

Yes, Secretary Lane is measuring up to the high standard set for him in the West. He has set aside all the petty methods of the past and is devoting his energies to the success of irrigation from the standpoint of home building, regardless of the demands of special interests.

He is not a rich man, and will not leave the granite walls of his office decorated with costly paintings of himself, beside those of his predecessors, but he will leave his image immortalized in the hearts of the struggling home makers of the West and leave his work as a blessing to generations unborn.

Yes, Director Newell continues at his old tricks.

His head is too small to contain the principles of the brotherhood of man. He is a creature of the ideas of the divine rights of kings, and would make an excellent assistant for Rockefeller, Baer or Weyerhauser in their attempts to acquire ownership of all of God's resources in order that they might as "philanthropists" develop the resources for those who are sufficiently subservient.

Yes, I remember the bitter denunciations hurled at me by the published letters of A. P. Davis in an attempt to present an apparent justification of the Reclamation Service in some of the acts criticized in my efforts to protect the Klamath settlers, but those letters are not remembered with the feeling that your question indicates.

Mr. Davis has for years been the assistant of a dominating character that possessed neither mercy nor humanity and who required Mr. Davis to father all acts of defense that might react, while the dominating head took all the praise upon himself for any successful act of the Service.

Mr. Davis was the man of brains and ability and a convenient goat for the needs of his chief.

With the opportunity presented by the present administration, Chief Engineer A. P. Davis has a fair chance to prove his real worth, and no unfortunate circumstances of the past should be remembered against him.

Chief Counsel Will R. King is a power for equity and justice. His familiarity with irrigation farming and unsurpassed knowledge of water laws and his sympathies with those who work make him a power for good.

Comptroller W. A. Ryan has from boyhood been a friend and associate of Franklin K. Lane and is endowed with a full portion of humanness, but his life

(Continued on page 155)

ROAD CULVERTS AND SIPHONS.

By James Wharton Jones.

There are three essentials which go to make the ideal culvert: Strength, convenience, permanence; and a form of construction which gives one of these is sometimes lacking in the others.

A culvert must be strong enough to support the dead weight of deep fills, as well as to sustain the shocks and vibrations incident to heavy and rapidly moving traffic. The need for better roads is generally conceded, and projects for highway improvement are receiving popular support in all sections. The development of great irrigation projects nearly always involves the building of permanent roads. A good road must be perfectly drained. The most direct routes must be followed, and it is demanded that such natural obstacles as exist to



Installing Pure Iron Culvert Under Tracks of Interurban Railway.

make this difficult be overcome in the interest of more economical transportation. Road construction should conform to twentieth century conditions, and where heavy grades existed, cuts and fills must be made. Culverts placed beneath deep fills must be not only of sufficient strength to support them, but should possess a flexibility which will permit of their conforming to uncertain or shifting foundations.

Water courses previously accommodated by open swales or gutters must be so handled as to maintain a level or unbroken highway; the old time bumps and "thank-you-marms" are no longer tolerated. The culvert provided here must be one, not only giving the maximum of strength in proportion to the amount of material employed in its construction, but must possess also a degree of resiliency which will enable it to endure when subjected to the blows and crushing stress of swiftly moving auto trucks and other vehicles, even if protected by a minimum of covering.

Corrugated iron culverts possess all these requirements. Iron sheets when corrugated become immensely rigid, and, when formed into a circular shape, the increase of strength over that of plain sheets is enormous. In correct corrugated iron culvert construction large rivets, closely spaced, are used, and each sheet is interlocked one full corrugation at the joints. The joints being double thickness, are therefore the strongest points in the pipe.

The installation of culverts is at best no easy task. Locations are often remote from rail points, and the delivery of materials becomes of much im-

portance. Freight charges on certain forms of construction form a very considerable part of their ultimate cost. Hauling, handling and assembling of materials all help to run this cost up to a prohibitive point. Failure on the part of shippers to include all parts, not to mention damages or breakage en route, often prevent the ready execution of well laid plans, causing expensive and annoying delays.

The ideal culverts are those which can be cheaply and easily transported and handled; those which are complete within themselves and require the least amount of skill to place in position for service. Since corrugated pipe possesses all these advantages, it is not to be wondered at that it has achieved a considerable popularity with the builders of highways and railroads.

This material is also especially well adapted for use in the form of inverted siphons. It is a curious fact that a corrugated pipe is easier to keep free from mud and other obstructions than one made of smooth metal or masonry. The necessity for these depressed crossings arises very frequently in the irrigated regions, where it is very often the case that highway drainage must be carried underneath a canal or lateral or vice versa.

While the first essential requirement in culvert construction is strength, closely followed by need for convenience in handling and placing, the final requisite is that culverts shall be lasting. In considering this feature it should be borne in mind that other factors than the mere disintegration of materials often have to do with the life of a culvert. There are precious few culverts in existence which have served for a period of fifteen years. Wooden structures warp and either wear or rot out in a brief space of time, and their further use in culvert construction is almost universally discredited. Brittle materials crack and collapse with resulting expense of renewal or replacement. Breakage may result from shocks of travel or shifting foundation resulting from settling of earth or washouts. The action of alkali soil, frost and other conditions is often such as to ruin in a short period construction which was originally intended to last for all time.

Change of drainage frequently makes the removal of a culvert necessary in order that provision for increased flow may be made, and to accomplish this the original culvert, if not removable, must be destroyed. If a change of route occurs, such culverts as are built into place from materials which cannot be shifted, represent a total loss for further service, and the permanence originally hoped for, does not exist.

High-purity iron corrugated culverts represent a very permanent type of culvert construction. When built from the proper gauges they are not harmed by heavy or shallow fills, and because of their flexibility, will not crack or break down as a result of shifting foundations. They do not wash out because the earth in which they are placed packs into their corrugations, and prevents the beginning of trickling streams of water along their sides.

They are removable at will, and can be used again and again. Their permanence is therefore

(Continued on page 151.)

“HOME RULE” IS KEYNOTE

Shoshone Project Farmers Hold Referendum; Demand Economy

Water Users on the Shoshone project held a history-making referendum during the past month. The settlers met at Powell, Garland and Ralston, Wyo. The meetings were marked by enthusiasm and lively interest for the success of the project and for the settlers, who are building homes there.

Home Rule for the project and economy in its administration were the keynotes of the referendum vote. By a vote of 161 to 23, the Board of Directors of the Water Users' association was directed to concern itself with the matter of who should or should not be employed on the project by the Reclamation Service.

Immediate action by the Board to obtain the greatest reasonable economy in the administration of local Reclamation Service affairs was ordered by a vote of 179 to 3.

The Water Users voted to ask for the transfer to some other project of C. M. Jump, superintendent of irrigation; for the abolishment of the position of assistant superintendent of irrigation, and for the reduction of the number of engineers from five to three.

The settlers voted in favor of having the operation and maintenance of the project turned over to the Water Users as soon as the question of who shall pay for drainage is finally determined.

The vote showed disapproval of the rotation system of water delivery and of graduated operation and maintenance charges.

The farmers voted almost unanimously in favor of asking their Board of County Commissioners to appropriate sufficient funds to employ an agricultural expert, who will devote his entire time to promoting better farming on the project and neighboring lands.

CONCRETE HYDRAULIC RAM HOUSES.

Among all the small devices used for hoisting or pumping water, few have been more satisfactory than the hydraulic ram, especially where economy of operation has been a factor. To give the best results a ram should be properly installed. This means rigidity of foundation and absence of everything calculated to obstruct the machine while in operation. "Fixing the ram" is an old-time expression familiar to everybody who has had occasion to use this simple and ingenious device. Sometimes the necessity for "fixing" has been brought about by a dislodged stone in the wall, or some obstructing substance in the mechanism.

Concrete affords the best means of protection to the ram, as it is impervious, durable and economical. The accompanying illustration shows a satisfactory type of building. A structure of this character will not rot, even though in constant contact with moisture, which quickly destroys wood. There are no joints, which invariably become defects in ordinary masonry. Concrete means a clean, sanitary and satisfactory enclosure for the hydraulic ram, and will do much to eliminate bills for repairs due to improper installation or an unstable foundation.

To build a ram house of the type shown would not require great mechanical skill. Having prepared the pit or foundation and erected his forms, the farmer would need to observe the following precautions:

Good cement, clean materials and the latter used while absolutely fresh. A mixture of 1 part Portland cement, 2 parts sand and 4 parts stone would make a good concrete. The concrete should be a wet mixture and placed in alternate layers about 6 inches thick, which should be tamped



A Concrete Hydraulic Ram House on the Property of John F. Jelke, Dundee, Ill.

slightly until water comes to the surface. To obtain a smooth surface the mass should be spaded on the side next to the forms immediately after placing. This is done by working a thin wooden paddle to and fro and up and down between the concrete and the side of the form. A spade will answer where the space between forms is sufficiently wide to permit of its use. The forms should be left in place for at least a week.

The foundation for the ram can be made of the same mixture and if the work is properly done it will mean a rigid, non-vibrating and everlasting base. Time and moisture will only add to its strength and durability.

FEDERAL WATER USERS.

If you are satisfied with the fight The Irrigation Age is making in your behalf, fill out and mail this subscription blank, with one dollar for one year's subscription:

Irrigation Age, 30 N. Dearborn St., Chicago, Ill.

Enclosed find \$1.00 for subscription for one year beginning April, 1914.

Name

Town.....

County

State

Reclamation Notes

CALIFORNIA.

Private parties propose to take up the government plan for the reservoir and irrigation project on the Pit river in Shasta and Lassen counties. The Lassen Irrigation Company will soon have the dam ready to irrigate 20,000 acres of land near Susanville. The Yolo Water and Power Company announces that in addition to the \$1,500,000 expended for the dam and water rights, they will spend \$7,000,000 more for perfecting the system. This project includes two powerhouses, with a combined capacity of 5,000 horsepower. The directors of the irrigation district in the Imperial valley have finally concluded to accept the proposition of the Southern Pacific Company for \$2,000,000 for its interests. This includes a right of way through Mexico.

Claims to water rights amounting to 10,000 miner's inches in Carriso and other canyons near Mountain Springs have been filed by J. D. Sidener, W. H. Johns and R. C. Rutter. Water will be used for irrigation and domestic purposes. A concrete flume will be constructed to carry the water to irrigate the fields in that section.

The Supreme Court has handed down a decision granting a new trial in the case of the California Pastoral and Agricultural Company (Chowchilla Company) vs. the Madera Canal and Irrigation Company. The action was brought several years ago to determine defendant's right, if any, to divert waters into its canal and to fix the amount thereof and prevent defendant using an excess of same. The lower court held that 250 cubic feet of water flowing continuously per second would be sufficient to irrigate the lands which have been irrigated by the defendant. The Supreme Court held that evidence should be given and a finding made on the question of the precise amount of water flowing continuously that is necessary for the beneficial use of the riparian land that may be reasonably appropriated for irrigation under the system of the Madera Canal and Irrigation Company. Upon these grounds a new trial was granted.

At the annual meeting of the stockholders of the East Riverside Water Company the following directors were elected for the ensuing year: S. H. Herrick, John Meharg, Nelson H. Twogood, J. E. Brown, H. O. Reed and Oscar Ford. The report of the secretary of the company showed that a total of about 3,500 acres of land had been served by the company with irrigating water during 1913, 1,000 acres of which were served from the two reservoirs which the system supplies. The assessment on lands served by the company's zanjeros was \$2 per acre, and on the lands under the reservoirs, from which the water was distributed by the owners thereof, \$1.25 per acre.

The irrigationists of the Oakdale district have expressed their opposition to the proposed \$300,000 issue of bonds asked for by the directors for the completion of the system. At a recent mass meeting of the citizens, John Kaufman of Orange Blossom colony demanded the resignation of the present board of directors and threatened court proceedings for their removal. President John Patterson responded for the board, refusing to resign. The question of the bonds was brought before the meeting by a motion that it be the sense of the meeting that no more bonds be voted while the present board of directors remain in charge. Notice was served upon the meeting that a petition would be circulated, asking for an election to vote on the \$300,000 bond issue, as asked by the board. It is claimed that the money will be needed to complete laterals, in order to deliver water to ranchers.

Alleging that they have been damaged to the extent of \$25,000, W. R. Jacobs and C. L. Flack, Los Angeles capitalists, have filed a complaint charging that J. A. Aggeler, Ralph Cole and Ralph P. Lane, who control reclamation district No. 684, have been guilty of gross

negligence in the management of the district. The plaintiffs claim that they purchased and installed at great expense to themselves and other owners in the district, machinery, materials and reclamation equipment, and say that, owing to the slope in El Dorado canal in the district, water flowed over its banks, and has been doing so for about four years, and that now the lands of the plaintiffs have been submerged and water has seeped through the soil and brought the alkali to the surface.

Dam "H," the largest of several dams surrounding the new Davis reservoir of the Turlock irrigation system, has been completed at a cost of \$35,753. It has been constructed along the north side of the reservoir, near the outlet gate. The crest length of the dam is 857.8 feet; maximum height, 29.5 feet to top of parapet; height to water surface, 25 feet; height above water surface, 4.5 feet; height of concrete parapet above dam, 18 inches; yardage in dam, 43,319 cubic yards; concrete face area, 61,182.9 square feet. The reservoir will have a storage capacity of 48,740 square feet. The maximum depth of water will be 30 feet and the average depth 14.92 feet.

Representatives of reclamation district No. 1500, which is known as the Armour project, have submitted the formal plans for the reclamation of the district to the Yuba county supervisors, and have asked the board to appoint three commissioners for the purpose of making an assessment against the lands to be benefited, to defray expenses. The total cost is estimated at \$3,331,695, or an average of about \$50 per acre. It is estimated that the work will require two years of dredging.

J. J. and P. H. Mahoney of San Francisco have purchased 1,120 acres of land, known as the Siem tract, the consideration being \$100,000. The land lies nine miles south of Modesto, in the Turlock irrigation district. The land is partly planted to alfalfa.

At a meeting of the ranch owners who are interested in the new irrigation project affecting land in the vicinity of Byron, it was reported that owners of 60,000 acres of land in eastern Contra Costa county had signified their willingness to enter into the project, and it is believed that with this as a starter, many land owners will soon fall into line, until the entire farming district in and around Byron will be concerned with the organization of the irrigation system.

At the annual meeting of the stockholders of the Pereira Farms Corporation the following officers were elected for the ensuing year: E. F. Reichman of Fort Jones, president; E. V. Pereira, Fort Jones, vice-president; Arthur Simon of Montague, secretary and treasurer; K. Collier of Ureka and Joseph Pereira, directors. The company was organized a few months ago with a capital of \$250,000, of which \$15,000 was paid up. Fort Jones is the principal place of business. The purpose of the company is to irrigate large tracts of land in western Siskiyou county and to build ditches and reservoirs. It is the intention of the company to subdivide and sell land after the irrigation system is constructed.

COLORADO.

An experimental pumping plant to water two or three hundred acres on Virginia mesa, near De Beque, is to be installed on the Grand river by the National Motor Current Company, which has a device claimed to greatly increase the capacity of the ordinary water power plant. It is possible that experimental plants will be erected on Hunter mesa and other places in the valley.

The Farmers' Irrigation Company held its annual meeting at Silt recently, for the election and organization of the board of directors. The following were elected: Judge H. G. Lunt of Colorado Springs, C. C. Parks of Glenwood Springs, W. E. Tippet of Antlers, S. H. Coulter of Antlers and R. F. Bowles of Silt.

Farmers on the land surrounding Farmers Spur have succeeded in inducing the Northern Colorado Power Company to install a substation in that town, and work on same will commence at once. The current supplied

by the substation will be used almost entirely in running motors for pumping plants, and contracts are being signed up as fast as the company agent can reach the farmers. There will be at least twenty pumping plants installed in this section this year, and half a dozen that have already been in operation with gasoline engines as the motive power will be changed into electric current. The location of the substation will bring many more acres of land under irrigation than has been farmed heretofore.

The state land board has completed its docket of Carey act hearings. Beginning March 16, it will conduct hearings of companies operating under the Carey act. Companies that do not show financial ability to put water on the land will have their right canceled and the land will be turned over to the settlers to permit them to irrigate with their own resources. The dates of the hearings are as follows: March 16, Routt County Development Company; March 17, Great Northern Irrigation and Power Company; March 18, Colorado Land and Water Supply Company; March 19, Dolores Irrigation Company; March 20, Two Buttes Irrigation and Reservoir Company; March 21, Tolltec Canal Company and Stark-Haggerdorn Irrigation Company, March 23, White Rivers Trappers, Lake and Routt County Irrigation Company, Colorado Southern Irrigation Company; March 24, Pueblo and Northeastern Irrigation Company; March 25, Valley Investment Company and Jackson County Land and Irrigation Company. The land board issued this ultimatum following investigations by Register Volney T. Hoggatt, who discovered that thousands of acres of the best land in the state are and have been for years held by big corporations for speculation. Many of these have not fulfilled their contracts and are making no effort to do so.

The Tucker ranch, on the St. Charles river, six miles southwest of Pueblo, has been sold by the Standard Loan and Realty Company to J. I. Mihoover for a consideration of \$8,000. The ranch comprises 160 acres of land and is one of the pioneer ranches on the St. Charles. The new owner will make many improvements on the ranch, including extensions of the irrigation ditches.

Some intricate questions of law are involved in a petition filed recently in the district court, representative of a fight between two of the large irrigation enterprises operating near Pueblo. The outcome means much to the owners of 50,000 acres of land under the Twin Lakes and Lake Merideth reservoir projects. These two concerns, together with the Colorado canal, which are under the same ownership, obtained a temporary restraining order from Judge Rizer in the district court, to prevent the defendant company, the Fort Lyons Canal Company, from usurping their water rights in Lake Merideth.

Under authority of the Secretary of the Interior, contract has been awarded for furnishing roller dams to constitute a movable crest for the Grand river dam of the Grand Valley irrigation project, Colorado. The apparatus includes one steel roller 60 feet in length and six rollers 70 feet in length, complete with all operating devices except electric motors, the total cost being \$27,846 f. o. b. Antwerp. The roller dams covered by the patents under which this apparatus is to be manufactured are of the most satisfactory type available for movable crests of the length required in this case.

In 1912 a similar contract was executed for the manufacture of a roller weir for the diversion dam of the Boise project, Idaho, and the apparatus furnished has in every way met the expectations of the engineers and has given excellent service.

IDAHO.

That there is no cause for alarm regarding the condition of the Chesterfield dam of the Portneuf-March Irrigation Company, located about forty miles east of Pocatello, is indicated by a report recently issued by the state engineer of Idaho, a project engineer and an engineer of the railroad company. The investigation of the dam's condition followed a published report of rumors to the effect that the dam was in unsafe condition and that farmers

on the project were prepared to leave at a moment's notice, in case the dam broke. The engineers' report states that the investigation showed that there is no cause in any way for alarm as to the safety of the dam, and that the construction of the dam was handled in a first-class manner.

The Idaho Irrigation Company has filed suit against Adolph Pew and H. E. Cornell, settlers on land which is under the Big Wood river ditch, in which the plaintiff seeks to foreclose on the property now owned by Cornell, because of failure of Pew and Cornell to make any payments on stock subscribed in the Big Wood River Reservoir and Canal Company.

The A. H. Sonner Company, Ltd., has been organized at Bellevue, to conduct a general livestock, farming and irrigation business. A. H. Sonner and Rosa Sonner and J. G. Hedrick are the directors for the first year. The capital stock of the company is placed at \$25,000, in shares of \$25 each.

MONTANA.

The Secretary of the Interior has awarded contract to the Lehigh Portland Cement Company of Chicago, Ill., for 13,000 barrels of Portland cement, at \$1 per barrel, f. o. b. cars Mason City, Iowa. This cement is for use on the Fort Creek irrigation project and on the distribution system of the Milk River project in Montana.

With the purpose of carrying on the business of the farmers in general, especially with reference to their relation with the United States government, farmers in the Huntley project have organized the Huntley Water Users' Organization. It has power to practically conduct all the business of the farmers. It is incorporated for forty years at a capitalization of \$40,000.

Directors of the Flatwillow Creek project, north of Billings, have almost completed arrangements and work will be started in the spring. This project will be built under the Carey act and will include 20,000 acres. Water for irrigation will be stored in Pike creek, about two miles from Flatwillow creek, from which it is taken. A dam 50 feet high will be built across the smaller creek, and during the high waters in the spring the water will be diverted into Pike creek by means of a canal. One railroad has already surveyed through the project and another has secured right of way practically through and has its line surveyed part way.

The Hayden Bros. of Portland, Ore., have been awarded the contract for constructing the Pishkun reservoir supply canal and the Sun River slope canal on the Sun River irrigation project, at a contract price of \$242,973. Work is to be done on the north side of Sun river, from twenty-five to seventy miles west of Great Falls, near the Sun river branch of the Great Northern railroad.

The Reclamation Service is asking for proposals for the construction of a portion of the St. Mary canal, St. Mary storage unit, Milk River irrigation project, Montana. The work includes about 560,000 cubic yards of excavation, 7,750 cubic yards of concrete, 13,000 square yards of paving, 700 cubic yards of riprap and 8,500 cubic yards of puddling; the placing of about 485,000 pounds of steel reinforcement bars and 293,000 feet, board measure, of lumber in wooden structures, and the erection of about 105,000 pounds of miscellaneous metalwork. The work is situated in the Blackfoot Indian reservation, about forty miles northwest of Browning, Mont.

The bids will be opened at 2 o'clock p. m., April 15, 1914, at the office of the Reclamation Service, Great Falls, Mont.

The Reclamation Service is asking for proposals for earthwork and tunnel, Pablo canals, in connection with the Flathead irrigation project in Montana. The work is located about six miles southwest of Polson, Mont., and involves about 3,400 cubic yards of open-cut excavation and about 520 linear feet of tunnel.

Bids will be opened at 2 o'clock p. m., March 20,

1914, at the office of the Reclamation Service, St. Ignatius, Mont.

NEW MEXICO.

A survey of the water resources of the lower Mimbres valley is under way by Professor Fayette Jones, president of the New Mexico School of Mines at Socorro, who has been at Columbus, Luna county, making a preliminary geological reconnaissance, with a view of determining why irrigation water is more difficult to secure by pumping near Columbus than in the upper valley around Deming.

The Pajarita irrigation project has been given an extension of time for its completion. This extension has revived interest in the project which will do much for the farmers in Quay county.

Lester Gordon has just finished sinking an irrigation well for T. H. Lyons, who owns a large piece of land near Buckhorn. The well is 125 feet deep, 2 feet in diameter, and the water stands within 8 feet of the top. The pump is a turbine with a capacity of 2,500 gallons per minute. Motive power is a steam tractor of 110 horsepower.

TEXAS.

During the year 1913 there were fifty large irrigation wells put down in the Plainview territory, and with the number already contracted for and in contemplation, more than one hundred will be put down during the present year.

Albert V. Leonard, settlement agent of the United States Reclamation Service, has been appealed to by George R. L. Baron of El Paso, to aid in a campaign to encourage residents of Chicago to move to the acres of privately owned land which will be improved by the Rio Grande project when the Eagle dam is completed.

The Lone Star Canal Company is preparing to build an irrigation canal in Chambers county, six miles in length, which will irrigate 4,000 acres of land, which will be planted to rice. The office of the company is located at Beaumont.

The Southern Land Company, with offices at Brownsville, has purchased 10,000 acres of property near Brownsville for a consideration of more than \$900,000. The tract will be known as the Tacoma lands and will be cut up into small farms and colonized. The company is planning to sink several wells for irrigation purposes on the property, and will make other improvements.

UTAH.

Attorneys for the Provo Reservoir Company have filed suit against the cities of Provo and Heber, the towns of Midway and Charleston, about forty canal companies and corporations, including the Utah Light and Power Company and other interests holding power sites along the river, and about a thousand individuals. The outcome of the suit will affect the distribution of water along the entire Provo river system and may determine what is meant by "the beneficial use of water." The suit does not expressly ask that the court limit the use of water from the river to its beneficial use or set the duty of water on land in this section, but by complaining against wasteful diversion of waters and pointing out its effect in injuring the reservoir company and preventing development of other arid tracts, this matter is put before the courts. The prayer for relief carries requests which are aimed to enable the court to pass directly or indirectly on this matter. The suit is regarded as one of the most important filed in the history of this country. Two decrees have been entered by the courts of this district settling rights along the river, but the injection of the reservoir system into the situation, it is claimed, has upset the entire basis of settlement, and the effect will be to throw open some question or other with regard to almost all, if not all, riparian rights in the section.

Hydrographic surveys, by means of which water for irrigation purposes will be exactly measured, will be set

up in the Sevier river at several points between the river's source in Piute county and Sevier lake, near Delta. The work of installing the surveys will begin immediately. It was contemplated installing the surveys several months ago, but not until recently, however, was a satisfactory arrangement reached regarding the financing of the work. The cost of setting up the surveys will amount to several thousand dollars. Half of this amount will be contributed by the state and half by those who will use the water for irrigation.

Articles of incorporation have been filed by the Escalante Development Company. The purpose of the company is to redeem a large acreage in Iron county. The company is capitalized at \$1,000,000, with shares at \$100 each. The company has headquarters at Lund, Utah. The assets of the company consist of nine certificates of application for water. These certificates are valued at \$1,000,000.

WASHINGTON.

The Secretary of the Interior has awarded contract to the Inland Portland Cement Company of Spokane for furnishing 10,000 barrels of cement, at 98 cents per barrel, f. o. b. cars Metaline Falls, Wash. This cement is for use on the Okanogan project in Washington and the St. Mary storage unit of the Milk River project in Montana.

The receiver's sale of the canal and all assets of the Union Gap Irrigation Company to the Union Gap Water Users' Association for the sum of \$1,250 has been confirmed by the Supreme Court and the receiver discharged. This action closes the affairs of a company whose original stockholders became rich through the selling of 4,000 acres of land with water rights, but from whose assets creditors with claims aggregating more than \$120,000 cannot now collect a cent. The farmers, in order to secure water for the irrigation of their lands, formed an association and purchased the canal at a nominal figure. Its operation will cost three times the amount which, under the terms of the land contracts, can be collected from the land owners for maintenance, and within a few years upwards of \$100,000 will have been expended for permanent improvements.

FOREIGN.

China has named a special commission to arrange with the American Red Cross and the State Department details of a project for the reclamation from floods of the River Hwai valley, which will involve an expenditure of \$20,000,000.

Surveys have been made by the Russian government for a canal to irrigate an area of 177,660 acres of land on the right bank of the Kur river, near Karkar-tchaya, on the edge of the Milk steppe.

PORTABLE FOLDING STEEL DAM

We show herewith half-tone of a portable folding steel dam which is light, durable, simple in construction, easy to operate and can be quickly adjusted to any ditch narrower than the dam.



The inventor, who is a practical irrigator, states that it will protect ditch banks and fields, as well as save water, time, labor and money. For further information concerning this device write W. A. Linkletter, inventor and manufacturer, Boulder, Colorado.

ROAD CULVERTS AND SYPHONS.

(Continued from Page 146.)

wholly dependent on the life of the material from which they are made.

It is generally conceded that iron or steel rusts in proportion to the amount of impurities present. Iron produced by the painstaking and laborious methods of long ago has endured through many years of trying exposure. The links used in the construction of the Newburyport (Mass.) bridge in 1792 are today in an almost perfect state of preservation. The reason for this appears when an analysis of these old links shows them to have been made from remarkably pure iron.

Dating from the introduction of the Bessemer process of steel making, tonnage produced at the expense of quality covered the country with structures which have quickly rusted out when exposed to the elements. Analyses show that modern steel is high in impurities. When the United States government by its investigations established the fact that the rapid corrosion of iron or steel was caused by the impurities present, it remained for someone to devise a method for their elimination.

This problem has enlisted the services of some of the best minds in the iron and steel industry, with the result that it is now possible to procure in the open market material of a very high standard. Corrugated culverts have been rendered practically useful by the employment of pure iron. The rigid enforcement of specifications calling for the best which is practically obtainable will result in lasting installations of exposed iron work.

A National Oil Engine

Will keep your power cost down

Think what it means to you to have at your service an engine that will burn all the low grades of oils, even those costing but two cents per gallon. An engine that has eliminated ninety per cent of the small, delicate and complicated parts. An engine that is ready for service at a moment's notice. One that is perfectly simple and absolutely reliable.

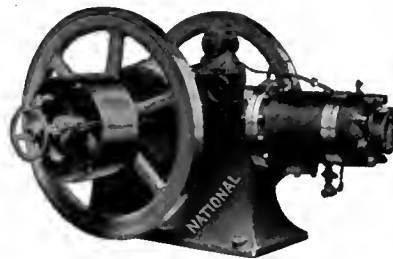

That is what you get when you buy a

NATIONAL

Our *Internal Igniter Ball* (patented) gives better combustion, more power and positively eliminates all danger from exploding hot balls.

Get our 1914 catalog

The National Steam Pump Company
UPPER SANDUSKY, OHIO

LOW FARES
to Northwest
Farm Lands

Come to Northwest farm lands while fares are low. One way Spring Colonist fares daily, March 15 to April 15.

\$25 from St. Paul, Minneapolis, Duluth, Omaha and Kansas City to many western Montana points. \$30 from those cities to Idaho, Washington, Oregon and British Columbia.

One way Settlers' fares on certain dates—\$16 from St. Paul, Minneapolis and Duluth to eastern Montana points. Round trip Homeseekers' fares on certain dates. Proportionately low fares from your home town.

Prosper With the Northwest

You will find greater opportunities *with your limited means* on the fertile, untilled lands of the Northwest than on worn-out eastern farms. Get a Free Homestead in Oregon or Montana. In three years it's absolutely yours. Buy a logged-off, fertile farm in Idaho, Washington or Oregon at very low cost. Easy payments.



Send for Facts and Fares

Send today for "Make-Good" books, 36 pages, each handsomely illustrated. Filled with letters from men, like you, who have made good in the Northwest. Get our Free Colonist Fare Folder. Fill out the coupon below and mail to

E. C. LEEDY

General Immigration Agent Great Northern Railway
St. Paul, Minn.

E. C. LEEDY, I.A.
Gen'l Immigration Agent, Great Northern
Railway, St. Paul, Minn.

Send me "Make-Good" hook on _____
and free Colonist Folder. Name of State

Name.....

Address.....

CONGRESSIONAL INVESTIGATION ASKED.*(Continued from Page 144.)*

mittee on Expenditures in the Interior Department, held a partial investigation in Phoenix in April, 1912.

When Franklin K. Lane was appointed Secretary of the Interior, the farmers of this valley thought he would adjust at least the above mentioned abuses; but, so far, one cannot see much change for the better. What the farmers of this valley hoped to see was the removal from office of F. H. Newell and L. C. Hill, who are considered the cause of the extravagance and waste on the project. It is generally believed in this valley that Senator Newlands and Mr. Newell have great influence over Secretary Lane.

It is the impression here that there has been grafting going on in this project, but little has been uncovered.

The small farmer is not getting a square deal. The Reclamation Service so far has been favoring

the large land owners and speculators. The small farms around Phoenix still have their old irrigating systems they had when the U. S. R. S. commenced work on the project. At their own expense they maintain their system.

The speculative lands have a complete, new and up-to-date system, in which their water is delivered to them and all pay the same for water. We have a very fine, productive Valley. The U. S. R. S. has run the price of the project so high that many land owners are discouraged and many prospective buyers of land coming into the Valley, find the cost of the project per acre so high that after paying the first cost of the land, they will not purchase, and leave, disgusted. I notice in some of his talks, Mr. Newell said people had ceased to come to Western projects. The above mentioned facts will readily give reasons. The people of this Valley would like to see a thorough Congressional investigation of the Reclamation Service.

MANY FOREST FIRES, BUT WELL CONTROLLED.

During 1913 the forces on the national forests fought 4,520 fires, or nearly twice as many as started in 1912, the best year the forests have ever had.

Notwithstanding the great increase in the number of fires, Forester Graves considers that the showing made by the forest service was quite as favorable as that in the preceding year, because the damage done and the costs of fire fighting were no greater, proportionately, than in 1912. In both years practically 50 per cent of all fires were detected and extinguished before they burned over a quarter of an acre, and 25 per cent of both years' fires were put out before they covered ten acres. Of last year's fires, 3,278, or considerably more than the whole number of fires in 1912, were confined to areas of less than ten acres, and in 1,080 additional fires less than \$100 damage was done by each. In only twenty-five fires did the damage amount to \$1,000.

The aggregate loss in timber is estimated at nearly 59,000,000 board feet, valued at about \$82,000, and the damage to young growth and forage is estimated at about \$110,000, making a total of about \$192,000. About 18 per cent of this loss, however, was incurred on private lands within the forests, where 16 per cent of the fires had their origin.

Care with Engines Increasing.

One encouraging feature is that the total number of fires set by railroad locomotives was scarcely more than in the preceding year, and represented only 12 per cent of all fires, as against nearly 19 per cent in 1912; also, the proportion set by sawmills and other engines in the woods was considerably less than in 1912. This indicates very plainly, Mr. Graves says, that the public is awakening to the need of spark arresters and care with engines in the woods.

Looking for the reason of the in-

(Continued on Page 154.)

Clear Fir Silo at 40% to 60% Saving

Buy your silo of us, and you buy *direct*, not only from the *maker* but from the *lumber producer* as well.

We own forests, railroads and six big mills

There are thousands of acres of timber in our tracts. The fir is the finest in the land. Tall, straight and close of grain. Only the choicest goes into Seattle Silo Staves. They show no knots, sap or other defects. Do not warp, shrink or swell. The toughest, best wearing wood in existence. All the cutting, logging and manufacturing of this timber is handled by us. One continuous operation. One overhead expense. Hence the big saving that we effect in producing cost—and why we save you 40% to 60% on a silo of better quality. Mail the coupon for catalog.

Seattle Silos

have patented swinging doors

These are far the best silo doors ever devised.

Quick detachable with special iron cross-bar or hoop connection. The steel bars on the door provide a solid ladder from which hoops can be tightened—the result of a new invention. They close absolutely air-tight. Can not stick or bind—never have to be lifted. They swing in or out readily on their hinges.

Mail the coupon today

We are preparing to furnish you with seasoned red cedar for flume building purposes.

"Machine banded wood stave pipe for irrigation system."

**Save 40% to 60%
on Lumber and Millwork**

Five middlemen come between the mill and you when you buy of your local lumber dealer. All get a fat profit; no wonder lumber is high. We put an end to this hold-up game. Sell you direct. Give you better materials at our mill price. Save you 40% to 60%.

We make shipments within 24 to 48 hours after receiving orders. Our shipments get to destination within an average of two weeks. Write today for price list. Better still, send your list of materials for our pre-paid prices. Money back unless satisfied.

Mail coupon today

HEWITT-LEA-FUNCK CO.

471 Cray Bldg., Seattle, Wash.

Kindly send the following, quoting prices delivered my station.
[] Catalog of lumber and millwork. [] Special silo folder.

Be sure to write plainly

Name _____

Address _____

Business _____

am planning to build as follows: _____

ENDORSE \$100,000,000 PLAN**Oregon Irrigation Congress Approves Federal and State Co-operation**

The Oregon Irrigation Congress, which met at Portland, Ore., during the past month endorsed the plan to issue \$100,000,000 in United States bonds to be used in the development of irrigation projects in the West. Secretary of the Interior Lane's proposal for co-operation between the Federal and state governments in building new projects and completing others was approved. The resolutions also endorsed the extension of water right payments on the Federal irrigation projects to cover a period of twenty years.

"Not a dollar of such aid will be lost," declared President William Hanley of the Congress, in speaking of the bond issue plan. "The states and nation will be amply repaid by increased valuation and greater population."

Other speakers were almost unanimous in declaring all future irrigation work in Oregon must be financed by bond issue and carried out with the aid of the Federal government.

John T. Lewis, state engineer for Oregon, put forth a plan to utilize the superior credit of the Federal government to issue the irrigation bonds, one-half of which would be secured by state 4 per cent bonds, and both issues to run for 50 years.

"We are going to get water on the land, if we have to send the militia to get it," declared Governor Oswald West. "We must do something without delay, and do it before there is a change of administra-

tion at Washington, for whenever there is a proposition on foot, each new administration wants to investigate it all over again."

Governor West advocated immediate relief for the irrigation projects of Oregon. He urged co-operation of Federal and state governments in expediting this relief and the use of school funds to be secured by mortgages on acreage embraced in the reclamation projects.

The Congress, which is composed of sixty state organizations, had a record attendance. Among outside guests were a party from British Columbia, including Duncan Marshall, minister of agriculture of Alberta, and F. H. Peters, dominion commissioner of irrigation.

Officers of the Congress were elected as follows: President, Asa B. Thompson of Echo; first vice-president, J. W. Brewer, Redmond; second vice-president, J. R. Blackaby, Ontario; third vice-president, W. Lair Thompson, Lakeview; secretary, Fred M. Wallace, Laidlaw.

Portland was chosen as the place for holding the next meeting.

MARRY; KEEP HOMESTEAD.

The house has passed Representative Kinkaid's bill, which removes the penalty for getting married, under which single homesteaders have labored. Under this bill men and women homesteaders may marry and then continue to prove up on their individual holdings providing each has complied with the law one year.

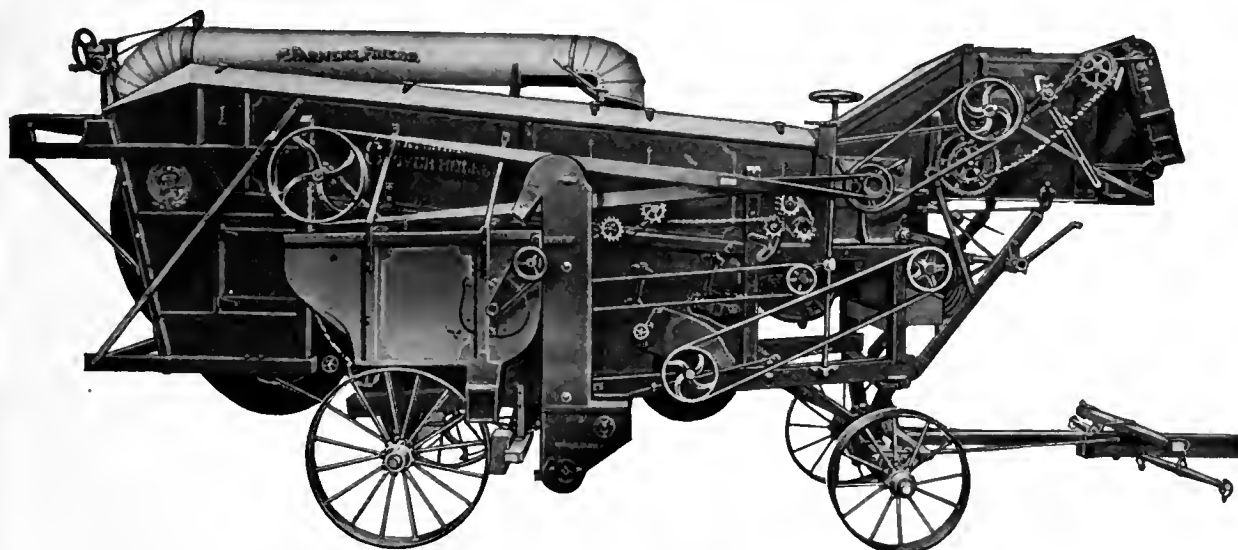

HULL YOUR SEED QUICKLY, PERFECTLY and ECONOMICALLY With a "MATCHLESS" CLOVER and ALFALFA HULLER

That's just what you will do if you use a "Matchless" Huller on the job. It's the one huller that will hull all the Clover or Alfalfa you can get to it without sacrificing the quality of the work. Here's the reason! We use square steel brads in our hulling cylinder. This construction has every advantage over rasps of spikes, because no set of spikes will knock the seed out of the damp pods. Rasps gum up and are easily destroyed. Our system of separation is unique and effective. This consists of a series of rotating troughs with perforation in the bottom, with provision for adjustment to meet the various conditions of clover. The Patented Steel Scrapers attached to the bottom of these troughs thoroughly scrape the separator bottom and insure a steady and positive delivery of the pods to the hulling cylinder, regardless of the condition of the clover. This construction enables you to hull seed under conditions in which no other huller can operate; enables you to hull earlier in the morning and later in the evening than with any other—this insures a longer day, thus increasing your earning power. Give us an opportunity to prove to you right on your own farm that the "Matchless" is the speediest and cleanest huller on the market. WRITE FOR CATALOG TODAY, or call at our nearest Branch House.

THE AULTMAN & TAYLOR MACHINERY COMPANY, MANSFIELD, OHIO.

Sole Builders of Aultman-Taylor "Starved Rooster" Line of Machinery.

BRANCHES: Minneapolis, Minn.; Portland, Ore.; Lincoln, Nebr.; Kansas City, Mo.; Wichita, Kan.; Decatur, Ill.; Indianapolis, Ind.

FARMERS SHOW INDEPENDENCE

Four hundred farmers on the Uncompahgre project voted recently to plant other crops than beets this spring. The Montrose Enterprise says:

"It is evident that the farmers are preparing to take the sugar company at its word and raise other crops. The sugar company says the average price paid for 1913 beets was \$5.50; that owing to the tariff reduction they can pay only \$4.75 for the 1914 crop. As the tariff reduces one-third for 1914, one-third for

1915 and one-third for 1916, upon the basis of their claim the 1915 beets will be worth \$4.00 per ton and the 1916 beets will be worth \$3.25 per ton and remain at this price until the tariff is changed."

Articles of incorporation have been filed by the Mills-Baker Company of Casper, Wyo., with a capital stock of \$10,000. The incorporators are Thomas Mills, L. C. Mills and A. C. Baker. The company will conduct a general business of contracting, grading, excavating, building irrigation ditches, water conduits, reservoirs, etc.

MANY FOREST FIRES.

(Continued from Page 152.)

crease in number of fires, the forester finds three main causes:

First of all, the unprecedented electric storms which swept the whole state of California at the end of a long dry season and set, almost simultaneously, about 700 fires. The 804 fires set by lightning in California formed nearly 50 per cent of the 1,628 fires on the national forests of the state from all causes, and were more than half of the 1,571 lightning-set fires in all of the twenty-one states reporting.

In the second place, there were 757 fires which started outside the forests, of which 644 were stopped by the government's fire fighters before they reached the forest boundaries, as against 424 which started on outside areas in 1912. However, the proportion of such fires to all those which the service battled with was about the same for 1912 and 1913.

Incendiary Fires.

The other increased cause of fires was incendiarism, but this increase was confined to three states—Arkansas, California and Oregon—all others showing a marked decrease. Of the 452 incendiary fires, 128 were in Arkansas, 133 in California and 142 in Oregon, where two brothers were known to have set seventy-two on one forest alone. These two and other incendiaries were, of course, severely dealt with by the law. On the Arkansas forest, too, it has been assumed that the 351 fires classed under the general heading of "origin unknown" were mainly incendiary. In California the incendiary fires are largely attributable to what is known as the "light-burning theory," which advances the argument that forests should be burned over frequently to prevent the accumulation of debris. The forest service considers this a pernicious theory because it scars the standing timber and thus reduces its value; it robs the forest soil of its ability to retain moisture, and effectually prevents the reproduction of the forest, since such fires destroy all tree seedlings before they have a chance to get a good start.

Lightning Caused Most Fires

In 1912 lightning caused more fires than any other agency, followed closely by railroads, campers and incendiaries, in the order given. In 1913, however, the fires caused by lightning outnumbered the next nearest cause by more than three to one but the order—railroads, campers and incendiaries—remained the same as in 1912. A considerable decrease in the

(Continued on page 156)



The Campbell Automatic Irrigation Sprinkler
Solves the "Irrigation Problem" and affords rain when you want it, and like you want it, at the minimum cost of installation and operation. Sample postpaid \$2.00. Money back if you want it. Descriptive literature on request.
J. P. CAMPBELL, Jacksonville, Fla.

Plows 15 Inches Deep

Forms Deep Moisture Reservoirs



Furnished with 5-Horse Evener

The Good Enough Heavy Deep Furrow Sulky

is a tremendously strong and powerful plow. It will plow any soil that is capable of being plowed and will turn a furrow from 6 to 15 inches deep.

The landing lever controls both the front furrow wheel and the hitch. The dial hitch can be adjusted to either side and up or down. The draft is applied directly to the beam through the heavy draft rod. The rear wheel is locked in place, but can be instantly released by means of the foot trip at the ends of the rows.

Regularly furnished with five-horse evener, rolling coulter and extra shares.

MOLINE PLOW CO.
Moline Illinois

MANY FOREST FIRES.

(Continued from Page 154.)

proportion set by railroads and campers indicates, according to forest officers, a growing carefulness on the part of the general public.

Last year, as in 1912, California led all others in number of fires, this lead being natural because California has such a long dry season. It was followed by Arkansas, Arizona and Oregon, in the order named. Kansas, which had only one fire in 1912, escaped without any in 1913. North Dakota repeated its record of 1912 and had no fires on its one small forest. Not a single severe fire occurred during the year in District 4, which includes Utah, Nevada and southern Idaho, and in which a large proportion of the forests reported no fires at all.

Losses on Private Lands

There was proportionately greater loss on private lands within the forest boundaries than on the public lands. It is pointed out by the forest officers that these lands cover approximately 11 per cent of the total area included within the forest boundaries, yet the area burned over on these private lands was more than 25 per cent of all. The forest service expended more than \$30,000 in protecting the private lands within the forests and lands adjacent to and outside of the forests. In addition to this cost, services and supplies to the value of more than \$17,000 were contributed by co-operators for fire-fighting on these areas.

Fires Came at End of Season

In the middle of the fire season, that is in July, the service had high hopes of small fire damage during 1913, and this hope kept up until the middle of September, when the fire season on the national forests ordinarily is about at an end. At that time there was less damage than had ever been recorded, and only 2,260 fires as against 2,470 in 1912, with about 60,000 acres burned as compared with 230,000 in 1912 and 780,000 in 1911. At the end of the month, however, the electric storms in California and one or two outbreaks of incendiarism changed the whole situation.

But even in the face of these difficulties the fire-fighting force, with its plans and experience from preceding years, was able to cope with the situation. In California, in particular, it was as if a military leader, represented by the district forester at San Francisco, was holding, with a comparatively small number of men or a mere skirmish force, a line of defense extending 750 miles in a north and south direction. This force received, as if from an attack by the heavy artillery of an opposing army, the electric storms, generally unaccompanied by rain, which played havoc all along the Sierras and the Coast Range. That the California force was able to cope with the situation was, according to Mr. Graves, an evidence of the efficiency of the men and the organiza-

Use KEROSENE Engine Free!

Amazing "DETROIT" Kerosene Engine shipped on 15 days' FREE Trial, proves kerosene cheapest, safest, most powerful fuel. If satisfied, pay lowest price ever given on reliable farm engine; if not, pay nothing. No waste, no evaporation, no explosion from coal oil.

Gasoline Going Up!

Gasoline is 9c to 15c higher than coal oil. Still going up. Two pints of coal oil do work of three pints gasoline.

Amazing "DETROIT"

—only engine running on coal oil successfully, uses alcohol, gasoline and benzina, too. Starts without cranking. Only three moving parts—no cams—no sprockets—no gears—no valves—the utmost in simplicity, power and strength. Mounted on skids. All sizes, 2 to 20 h. p., in stock ready to ship. Engine tested before crating. Comes all ready to run. Pumps, saws, threshes, churns, separates milk, grinds feed, shells corn, runs home electric lighting plant. Prices (stripped), \$29.50 up. Sent any place on 15 days' Free Trial. Don't buy an engine till you investigate the money-saving, power-saving "DETROIT." Thousands in use. Costs only postal to find out. If you are first in your neighborhood to write, you get Special Extra-Low Introductory price. Write! (13P) Detroit Engine Works, 301 Bellevue Ave., Detroit, Mich.



SEND \$1.00 FOR THE IRRIGATION AGE ONE YEAR AND THE PRIMER OF IRRIGATION, PAPER BOUND.

FOR THE "LAND'S SAKE"

BUY A

BOSTROM IMPROVED



FARM LEVEL

Price \$15

SHIPPING WEIGHT 15 LBS.

which has TELESCOPE enabling you to read the Target over 400 yards away, and

TERRACE, DITCH, TILE DRAIN, IRRIGATE

your land properly, and save surveyor's fees. It is sold by up-to-date hardware and general merchants everywhere, and guaranteed to be the most

SIMPLE, ACCURATE, DURABLE AND COMPLETE

outfit ever made for all farm work. If your dealer hasn't one in stock, he will order for you from a nearby hardware jobber.

Write today for description of Level, and details of our MONEY BACK GUARANTEE.

BOSTROM-BRADY MANUFACTURING CO.

119 Madison Ave., Atlanta, Ga.

International Harvester Oil and Gas Engines

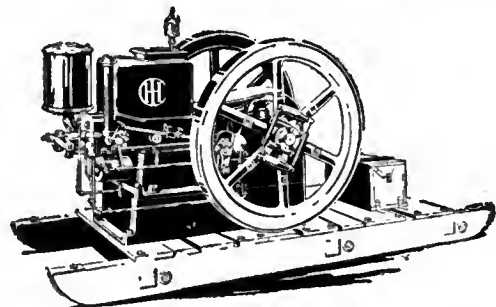

The IHC Line GRAY AND HAY MACHINES

Binders, Reapers
Headers, Mowers
Rakes, Stackers
Hay Loaders
Hay Presses

CORN MACHINES

Planters, Pickers
Binders, Cultivators
Ensilage Cutters
Shellers, Shredders

TILLAGE

Peg, Spring-Tooth,
and Disk Harrows
Cultivators

GENERAL LINE

Oil and Gas Engines
Oil Tractors
Maoure Spreaders
Cream Separators
Farm Wagons
Motive Trucks
Thrashers
Grain Drills
Feed Grinders
Kilfe Grinders
Binder Twine

SUCCESSFUL farmers are no longer asking, "Shall I buy an engine?" They have passed that point and now inquire, "Which engine shall I buy?"

A little careful observation will show that International Harvester engines are the most satisfactory. No doubt is left when features like the following are studied: Detachable valve guides, offset cylinder head, fuel pump, split-hub fly-wheels, extra large intake and exhaust valves, etc.

Ask the men who have used IHC engines. That is the best test. They will explain the excellence of IHC construction, simplicity, strength and durability.

Study the engines yourself at the nearest dealer's where International Harvester engines are sold. They are made in all styles, and range in size from 1 to 50-H. P. They operate on low and high grade fuels.

Write for our interesting and instructive catalogues, and when we send them we will tell you where the engines may be seen. A postal will do.

International Harvester Company of America

(Incorporated)

Denver—Helena—Portland—Spokane—Salt Lake City—San Francisco
Champion Deering McCormick Milwaukee Osborne Plano



IRON RESISTS CORROSION IN PROPORTION TO ITS PURITY

Very few people nowadays will attempt to dispute this statement.
THE PROOFS OF EXPERIENCE ARE OVERWHELMING.



The question to be decided in selecting material for **CORRUGATED CULVERTS** and other exposed iron installations is

HOW CAN WE BE SURE OF GETTING A PURE IRON?

Any of the Culvert Manufacturers listed below will furnish a bond, issued by a Surety Company, acceptable to the United States Government, guaranteeing that the base metal of all **American Ingot Iron Armco Culverts** will analyze 99.84% **Pure Iron**, taking into account all impurities, viz.: Carbon, Manganese, Copper, Sulphur, Phosphorus, Silicon, Oxygen, Hydrogen and Nitrogen. ¶ Anyone offering a material as being of equal merit, should, of course, be willing to do likewise.

Write the nearest manufacturer for particulars and prices on American Ingot Iron Culverts, Flumes, Sheets, Plates, Roofing and Formed Products:

- | | | | |
|-----------------------------------------------------------------|--------------------------------------------------------------|-----------------------------------------------------------------|-------------------------------------------------------------------|
| Arkansas —Little Rock
Dixie Culvert & Metal Co. | Iowa —Independence
Independence Cor. Culvert Co. | Montana —Missoula
Montana Culvert Co. | Oregon —Portland
Coast Culvert & Flume Co. |
| California —Los Angeles
California Cor. Culvert Co. | Kansas —Topeka
The Road Supply & Metal Co. | Nebraska —Lincoln
Lee Arnett Co. | Pennsylvania —Warren
Pennsylvania Metal Cul. Co. |
| California —West Berkeley
California Cor. Culvert Co. | Kentucky —Buechel
Kentucky Culvert Co. | Nebraska —Wahoo
Nebraska Culvert & Mfg. Co. | South Dakota —Sioux Falls
Sioux Falls Metal Culvert Co. |
| Colorado —Denver
R. Hardesty Mfg. Co. | Louisiana —New Orleans
Dixie Culvert & Metal Co. | Nevada —Reno
Nevada Metal Mfg. Co. | Tennessee —Nashville
Tennessee Metal Culvert Co. |
| Delaware —Clayton
Delaware Metal Culvert Co. | Maryland —Havre de Grace
J. N. Spencer. | New Hampshire —Nashua
North East Metal Culvert Co. | Texas —Dallas
Atlas Metal Works. |
| Florida —Jacksonville
Dixie Culvert & Metal Co. | Massachusetts —Palmer
New England Metal Cul. Co. | New Jersey —Flemington
Pennsylvania Metal Cul. Co. | Texas —El Paso
Western Metal Mfg. Co. |
| Georgia —Atlanta
Dixie Culvert & Metal Co. | Michigan —Bark River
Bark River Bridge & Cul. Co. | New York —Auburn
Pennsylvania Metal Cul. Co. | Texas —Houston
Lone Star Culvert Co. |
| Illinois —Bloomington
Illinois Corrugated Metal Co. | Michigan —Lansing
Michigan Bridge & Pipe Co. | North Carolina —Greensboro
Dixie Culvert & Metal Co. | Utah —Woods Cross
Utah Culvert Co. |
| Indiana —Crawfordsville
W. O. O'Neill Co. | Minnesota —Minneapolis
Lyle Corrugated Culvert Co. | North Dakota —Wahpeton
Northwestern Sheet & Iron Wks. | Virginia —Roanoke
Virginia Metal & Culvert Co. |
| Indiana —Princeton
W. O. O'Neill Co. | Minnesota —Lyle
Lyle Corrugated Culvert Co. | Ohio —Middletown
American Rolling Mill Co. | Washington —Spokane
Spokane Cor. Cul. & Tank Co. |
| Iowa —Des Moines
Iowa Pure Iron Culvert Co. | Missouri —Moberly
Corrugated Culvert Co. | Ohio —Corrugated Culvert Co. | Wisconsin —Eau Claire
Bark River Bridge & Cul Co. |
| | | Oklahoma —Shawnee
Dixie Culvert & Metal Co. | Wisconsin —Madison
Wisconsin Culvert Co. |

The Ambursen Hydraulic Construction Company

WM. L. CHURCH, President

Desires to make the following announcements:

The name of this company has been legally changed to the AMBURSEN COMPANY. This is in part for simplicity and in part to indicate the expansion of our business into other correlated fields, not necessarily hydraulic.

On or about March 10th, 1914, the Ambursen Company will remove its offices from Boston to New York, occupying a suite on the twentieth floor of the Adams Building, 61 Broadway.

Dating from January 1, 1914, Mr. Charles E. Parsons became President of the Ambursen Company, leaving the former incumbent, Mr. William L. Church, free to devote himself wholly to his professional duties as Consulting Engineer for the Ambursen Company and to his increasing private practice. Otherwise his connections with the Ambursen Company remain unchanged, his address being No. 61 Broadway, New York.

The Ambursen Company has entered into an Agreement of Association with Lewis, Wiley & Morse, Inc., of Seattle, Wash., whereby the moving of earth by sluicing, to wit: The building of Hydraulic Fills for Dams and Embankments, cutting down grades, filling bad ground, tidal flats, etc., will be jointly undertaken in any part of the United States and Canada.

Messrs. Lewis, Wiley & Morse are of world-wide reputation because of their great work in regrading the city of Seattle, the development of the Westover Terraces in Portland, Oregon, and other work involving the movement and emplacement of earth by the Hydraulic Process. Address either Company at convenience.

IT WILL GIVE US PLEASURE TO RECEIVE YOU IN OUR NEW QUARTERS.

AMBURSEN COMPANY

CHARLES E. PARSONS, President



International Harvester Tillage Implements

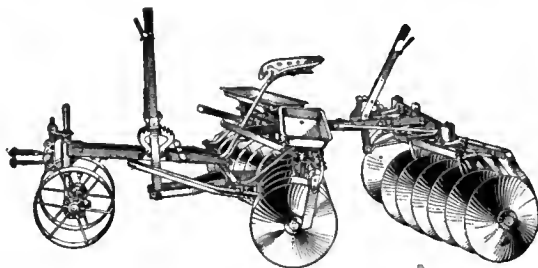

WITH an International Harvester disk harrow the ground is so prepared that it stores away and holds the moisture from snow and early rains, liberating it to the roots of your growing crops at the time when they need it most.

International Harvester disk harrows are built to do this work as it should be done. They are strong enough to stand up under meadow slicing and tilling hard ground. The disks are of steel that keeps an edge. The bearings are as nearly dust and dirt proof as disk bearings can be built.

The full line includes every style of disk and smoothing harrow and the best line of drills and cultivators built. See the I H C local dealer for full information about the line, or send to us for catalogues.

"The Disk Harrow," a book which illustrates and explains the proper preparation of seed bed, and gives examples of the value of disking—32 pages of valuable information—is yours for four cents to cover postage and packing. Write for it.

GRAIN AND HAY MACHINES
Binders, Respers
Headers, Mowers
Rakes, Stackers
Hay Loaders
Hay Presses

TILLAGE
Combination,
Peg and Spring-
Tooth, and Disk
Harrows
Cultivators

**THE I H C
LINE**

CORN MACHINES
Planters, Pickers
Binders
Cultivators
Ensilage Cutters
Shellers
Shredders

GENERAL LINE
Oil and Gas
Engines
Oil Tractors
Manure
Spreaders
Cream Separators
Farm Wagons
Motor Trucks
Thrashers
Grain Drills
Feed Grinders
Knife Grinders
Binder Twine

International Harvester Company of America

(Incorporated)

Denver—Helena—Portland—Spokane—Salt Lake City—San Francisco

Champion Deering McCormick Milwaukee Osborne Plano



THE TECKTONIUS DRAW-BAND FASTENER

is the simplest, strongest, safest band-clamping device made. No rivets to rust, shear off or pull out. Put on and adjusted, by ordinary workmen. Insures no leaking or bursting tanks or flumes. Made of malleable iron—every Fastener hammer-tested. Cannot wear out, break or pull off. Makes **Irrigation Flumes—Water Tanks and Conduits—Strong and Durable as Steel** Send for free booklet, and learn all about this simple, scientific and effective band-fastener. Also we are manufacturers of other water-works and irrigation-iron appliances.



E. C. TECKTONIUS MFG. CO.
1220 13th Street Racine, Wis.

Put This Engine

On That Pumping Job

Ready any time to be taken where needed. Kerosene engine starts easily—runs smoothly. Centrifugal pump will handle up to 750 gallons of water per minute.

Other pumps in any capacity for every need.

Write for Catalog 16N650

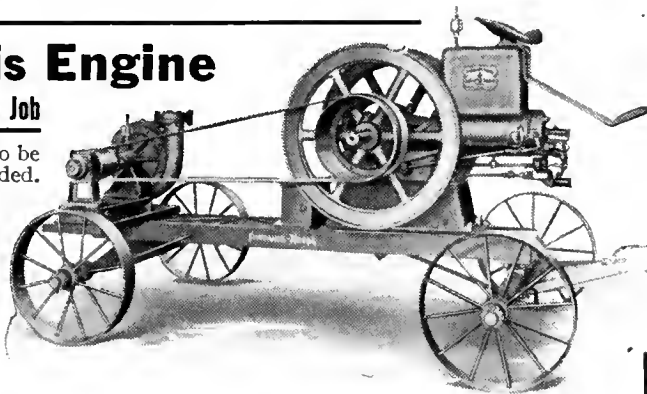

Fairbanks, Morse & Co., Chicago St. Paul Spokane Kansas City Denver Portland St. Louis Salt Lake City Seattle Omaha Los Angeles Atlanta

GALVANIZED METAL IRRIGATION FLUME (Newcomb Patent)

Made entirely of rust-proof, galvanized iron. No bolts or rivets used in construction. This flume is considered by experts to be the most serviceable equipment for the purpose on the market. A careful examination of the construction as shown herewith will convince those who are acquainted with irrigation conditions of its lasting quality and the ease with which it may be put together. Complete information, with prices, will be furnished on application to the



Section of Flume

KLAUER MFG. COMPANY, Dubuque, Iowa



International Harvester Motor Trucks

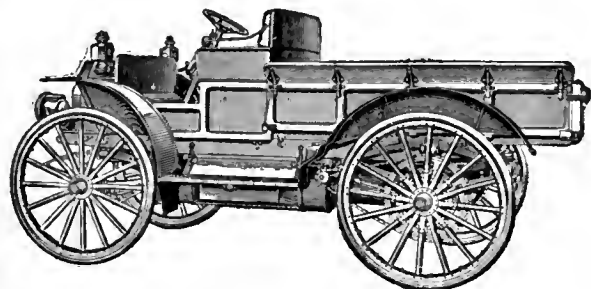

“I HAVE used your International motor truck daily over a route eighty miles long, through winter and summer, for the last four years, and have never missed a trip,” writes one man.

Service such as this man got would add much to the profits of your fruit business, by handling your fruits rapidly at the right moment, and cutting down your general hauling expenses. An International motor truck would give you such service. Many fruit growers, realizing the advantages and economies to be secured, have long been successfully using the light running, durable International motor truck.

The solid tires cut down tire troubles. The motor is simple and has plenty of power for emergencies. The brakes are safe on any hill. The ignition system is of the best. One lever controls the car. The International is built to save you money.

Let us show you all that an International motor truck will do for you. Drop a card today for catalogues and full information to the

GRAIN AND HAY MACHINES

Binders, Reapers Headers, Mowers Rakes, Stackers Hay Loaders Hay Presses

TILLAGE

Peg, Spring-Tooth and Disk Harrows Cultivators

THE I H C LINE

CORN MACHINES

Planters, Pickers Binders Cultivators Ensilage Cutters Shellers, Shredders

GENERAL LINE

Oil and Gas Engines Oil Tractors Manure Spreaders Cream Separators Farm Wagons Motor Trucks Thrashers Grain Drills Feed Grinders Knife Grinders Binder Twine

International Harvester Company of America

(Incorporated)

Denver—Helena—Portland—Spokane—Salt Lake City—San Francisco

Champion Deering McCormick Milwaukee Osborne Plano



“Ingeco” Oil Engines and Pumps

Your Protection Against Droughts

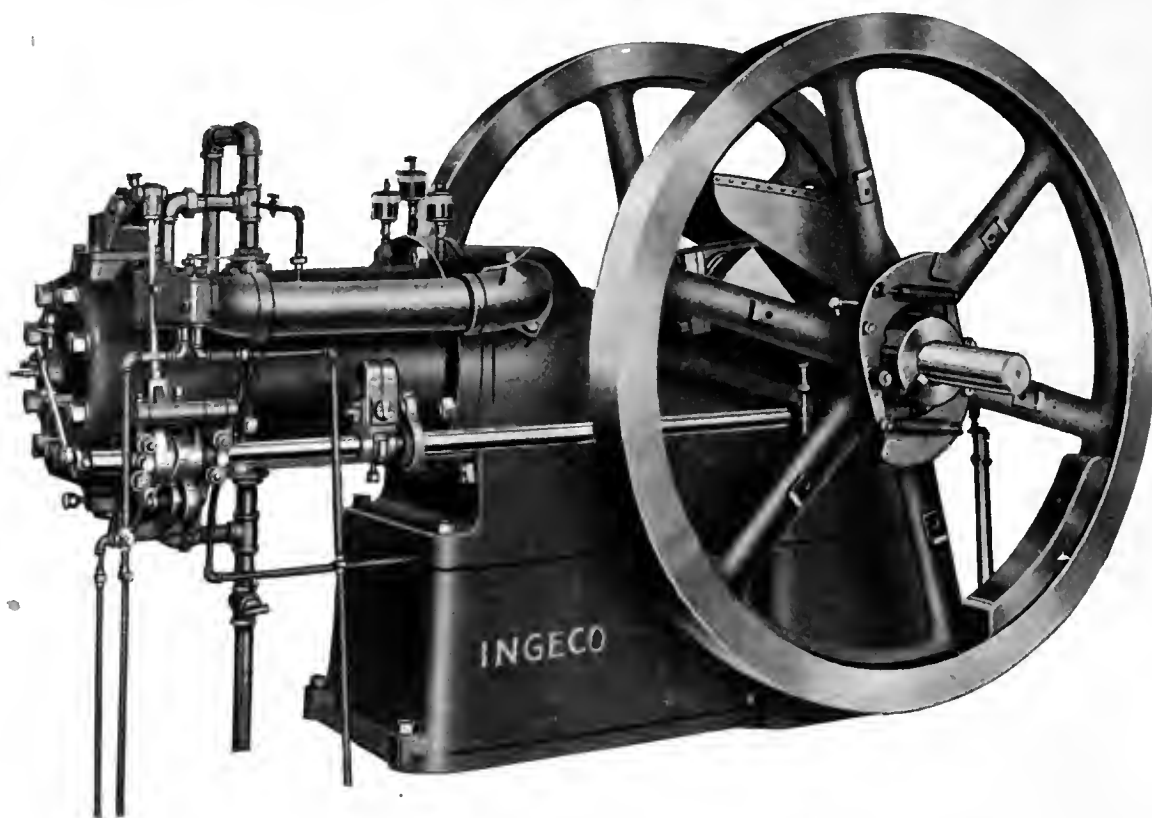

Right Now Is the Time to Order Your Irrigation Outfit

There is no longer any question about the big returns from this investment. The only question for you to decide is what equipment to buy. Let our engineers go into this matter with you in detail. The result of our years of experience in this work is at your command. Tell us how many acres you want to irrigate—the character of the soil—source of supply and total elevation that water must be lifted and we will quickly work out your problem and name you a proposition which we know will be interesting.

We are prepared to furnish complete plants, Engines and Pumps to meet all service, regardless of size or condition. Branch Sales Offices and stocks carried in all principal cities.

Write for catalog 29-B.

International Gas Engine Co.

General Sales Office and Factory:
112 Holthoff Place

CUDAHY, WISCONSIN
Suburb of Milwaukee

IRRIGATION FROM WELLS



An Arkansas Installation. Layne Patent Screen and Patent Enclosed Line Shaft Centrifugal Pump.

With the twenty-three hundred successful working plants using our system of irrigation, which inoculates and energizes the dormant forces, there is now being produced in previously non-productive districts throughout the United States and in portions of Europe and Asia over eleven million dollars worth of FOOD PRODUCTS ANNUALLY. That our system is not an experiment is forcibly demonstrated by the fact that much of this production is from localities which were arid and barren previous to the introduction of our system.

Write for new catalog.

LAYNE & BOWLER COMPANY

Address nearest office.

The World's Largest Water Development Company

Houston, Texas

Memphis, Tennessee
Welsh, Louisiana

Stuttgart, Arkansas
Plainview, Texas

Jackson, Mississippi



International Harvester Tillage Implements

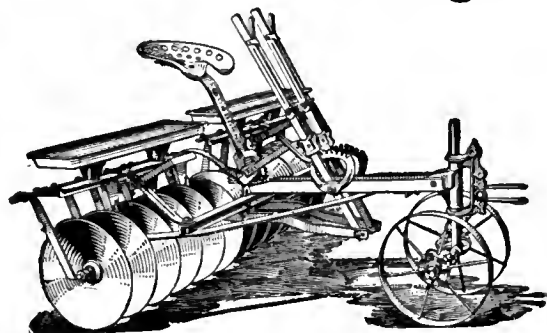

THIS year ten disk harrows will be sold where one was sold five years ago. Why? Because so many farmers have learned that the proper use of a disk harrow is the best guarantee of a successful crop.

Proper use of a disk harrow means the purchase of an I H C disk harrow, because they are the ones built to do the best work. The frames are strong, to stand the strain of following the binder or of slicing meadows. The set levers keep the gangs to their work at even depth. The bearings are the most durable that can be put on a disk harrow.

The full line includes disk, peg tooth, and smoothing harrows, drills and cultivators. See this line before you buy. We send catalogues on request.

"The Disk Harrow," a book which illustrates and explains the proper preparation of a seed bed, and gives examples of the value of disking—32 pages of valuable information—is yours for four cents to cover postage and packing.

GRAIN AND HAY MACHINES

Binders, Reapers
Headers, Mowers
Rakes, Stackers
Hay Loaders
Hay Presses

TILLAGE

Combination,
Peg and Spring-
Tooth, and Disk
Harrows
Cultivators

THE I H C LINE

CORN MACHINES

Planters, Pickers
Binders
Cultivators
Ensilage Cutters
Shellers
Shredders

GENERAL LINE

Oil and Gas
Engines
Oil Tractors
Manure
Spreaders
Cream Separators
Farm Wagons
Motor Trucks
Threshers
Grain Drills
Feed Grinders
Knife Grinders
Binder Twine

International Harvester Company of America

(Incorporated)

Denver—Helena—Portland—Spokane—Salt Lake City—San Francisco

Champion Deering McCormick Milwaukee Osborne Plano



When writing to advertisers please mention The Irrigation Age.

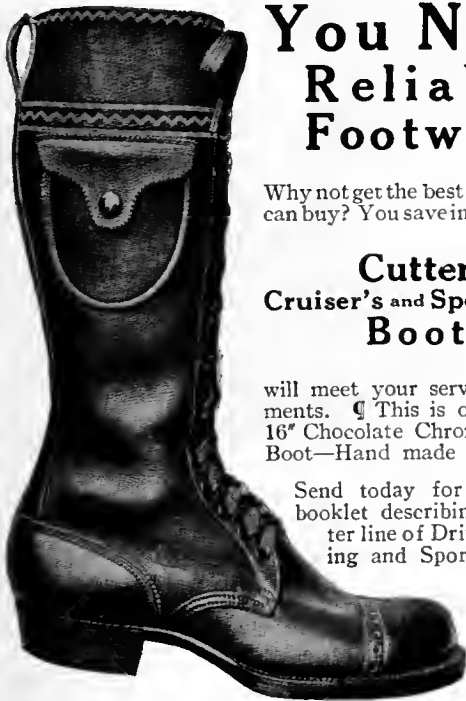

You Need Reliable Footwear

Why not get the best your money can buy? You save in the long run

Cutter's Cruiser's and Sportman's Boots

will meet your service requirements. ¶ This is our No. 106 16" Chocolate Chrome Sporting Boot—Hand made throughout.

Send today for illustrated booklet describing the Cutter line of Driving, Cruising and Sporting Boots.

*It
Will Pay
You*

A. A. Cutter Company
Eau Claire, Wisconsin

SAMSON TURBINE



When the PUMP cannot be direct connected to the turbine shaft, the power is usually transmitted by gears, shafting, etc. On account of the HIGH SPEED of the SAMSON, for a given power, lighter and consequently CHEAPER transmission machinery can be used.

JAMES LEFFEL & CO.
Springfield, Ohio, U. S. A.
316 Lagonda Street



The Lennon Metal Flume

(PATENTED)

made from

AMERICAN INGOT IRON

Is Convenient to Handle and Install, Absolutely Water-tight and Efficient, and *Lasting* because its material is the *purest iron on the market.*

WRITE FOR FULL INFORMATION TO

THE LENNON FLUME CO., Colorado Springs, Colo.

THE COAST CULVERT & FLUME CO., Portland, Ore.

SIOUX FALLS METAL CULVERT CO., Sioux Falls, South Dakota

UTAH CULVERT CO., Woods Cross, Utah

THE CALIFORNIA CORRUGATED CULVERT CO.
Los Angeles and West Berkeley, Cal.

THE WESTERN METAL MANUFACTURING CO.
El Paso, Texas

NEBRASKA CULVERT & MANUFACTURING CO.
Wahoo, Nebraska

This Book Shows How to Plan a Private Irrigation Pumping Plant



It also shows all of the various types of pumps to meet the conditions found in different localities, tells how to select the proper pump for your conditions, how to determine the amount of power you

will need and all the other things the irrigator needs to know.

One will be sent free on request as long as they last. Write today

THE GOULDS MFG. CO.
LARGEST MFR. OF PUMPS FOR EVERY SERVICE

174 Fall Street, Seneca Falls, N. Y.
Branches in All Principal Cities

IRRIGATION DITCHES

Cheaply and Properly Made with a

Rural Road Grader and Ditcher



Cutting V-Bottom ditch on Slope of 1½ to 1.

The successful irrigation ditch or lateral must be cut clean, with slopes smooth and undisturbed. This machine was especially designed to meet these requirements. One horse and wheel traveling in point of ditch, the other outside the bank of earth. Operated by one or two men and two or four horses.

If you have an irrigation problem to solve, do not fail to write for full information concerning this Combined Grader and Irrigation Ditcher.

Address

C. D. EDWARDS, Albert Lea, Minn.

National Oil Engines

Operate on Nearly All of the Lower Grades of Oils

When buying an oil engine look carefully into the plan of ignition. Successful and economical operation depends upon the ability of the engine to convert all of the fuel entering the cylinder into power.

It stands to reason that an igniter that extends into instead of out from the cylinder, thereby preventing the radiation and loss of power giving heat units, will be the most economical.

The Internal Igniter (patent applied for) is a distinctive feature of the NATIONAL. (See cut.)

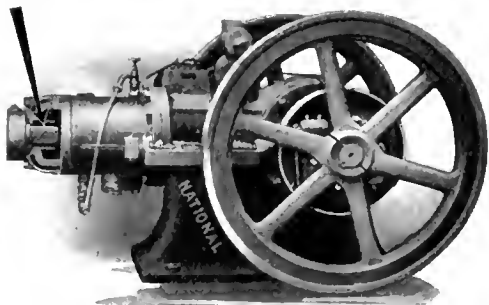

It is far superior to the usual type of external hot ball because:

It conserves the heat units, turning them into power.

It maintains a more even temperature.

It is easier to heat in starting.

It enables the engine to be run successfully under a greater variation of load.

IT IS ABSOLUTELY SAFE.

The external hot ball becomes brittle and frequently explodes. The NATIONAL INTERNAL IGNITER can not explode as it is subjected to a compressing instead of an expanding strain.

Reduce the expense and increase the efficiency of your power plant by installing a NATIONAL.

Write for Catalog and Prices

THE NATIONAL STEAM PUMP CO.
UPPER SANDUSKY, OHIO, U. S. A.

The Faithful Friend

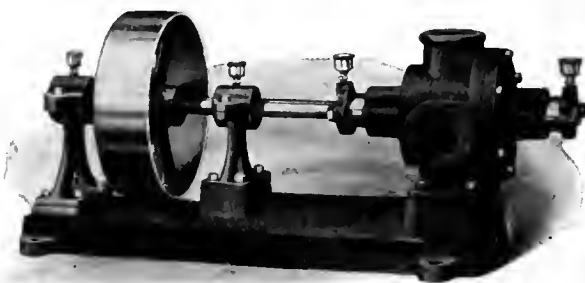

Do not be contented until you have the best, as these pumps have a good suction lift, with capacities of 12 to 500 gallons per minute, automatic take-up for wear, and free from springs or small parts that cause trouble.

SEND us your pumping proposition today, and let us quote you on the best pump made

Blackmer Rotary Pump Power & Mfg. Co.
PETOSKEY, MICHIGAN

THE IRRIGATION AGE

Vol. XXIX

CHICAGO, APRIL, 1914.

No. 6

THE IRRIGATION AGE

With which is Merged

The National Land and Irrigation Journal

MODERN IRRIGATION

THE IRRIGATION ERA

ARIO AMERICA

THE WATER USERS' BULLETIN

THE DRAINAGE JOURNAL

MID-WEST

THE FARM HERALD

THE IRRIGATOR

D. H. ANDERSON
PUBLISHER,

30 No. Dearborn Street,
Old No. 112 Dearborn St.

CHICAGO

Entered as second-class matter October 3, 1897, at the Postoffice at Chicago, Ill., under Act of March 3, 1879.

D. H. ANDERSON, Editor

ANNOUNCEMENT.

The "Primer of Hydraulics" is now ready; Price \$2.50. If ordered in connection with subscription \$2.00.

House
Cleaning
Demand Is
Widespread

It is not merely "disgruntled farmers or malcontents" who are demanding a general house cleaning by Secretary of the Interior Lane in the engineering department of the Reclamation Service. The demand for such action seems almost unanimous among the farmers on the Federal irrigation projects. A large part of the farmers have no confidence in Director F. H. Newell or Chief Engineer Davis, or anything they say. The engineering world stands aghast at the discrepancies between the estimated and the actual costs of the Federal projects, due to ignorance, incompetency, waste, or just pure downright foolishness.

Earl B. Smith, chairman of the Executive Committee of the National Federation of Water Users' Associations, recently sought an interview with Isham Randolph, an eminent engineer of national reputation. Here are three questions which Mr. Smith asked, and Mr. Randolph's answers:

1. Is it within the province of the engineering profession to attempt to make reliable estimates of the cost of projects such as the Reclamation Service has been constructing? Answer—Yes.

2. Do financiers, bankers and large business men rely on their engineers' estimates where works of such proportions are contemplated? Answer—

Yes, within 5 per cent, or in certain cases within 10 per cent, and any engineer whose estimates exceeded those limits would never get another important job in this country.

SUBSCRIPTION PRICE	
To United States Subscribers, Postage Paid,	\$1.00
To Canada and Mexico.	1.50
All Other Foreign Countries.	1.50

In forwarding remittances please do not send checks on local banks. Send either postoffice or express money order or Chicago or New York draft.

Official organ Federation of Tree Growing Clubs of America. D. H. Anderson, Secretary.

The Executive Committee of the National Federation of Water Users' Associations has taken action whereby THE IRRIGATION AGE is created the official organ of this vast organization, representing 1,000,000 persons on the government irrigation projects.

Interesting to Advertisers

It may interest advertisers to know that The Irrigation Age is the only publication in the world having an actual paid in advance circulation among individual irrigators and large irrigation corporations. It is read regularly by all interested in this subject and has readers in all parts of the world. The Irrigation Age is 29 years old and is the pioneer publication of its class in the world.

3. Is it reasonable for the landowners and entrymen to rely, in a financial way, on government engineers' estimates in the construction of reclamation projects? Answer—Yes, perfectly reasonable.

What do you think about those answers, Secretary Lane? Don't you think it about time to free your organization of barnacles and incompetents and give the Water Users a new deal?

Colonel Theodore Roosevelt has just published his autobiography. In it he makes the following statement:

Be Square just published his autobiography. **Col. Roosevelt!** In it he makes the following statement: **Apologize to**

The Settlers "The recent attacks on the Reclamation Service, and on Mr. Newell, arise in large part, if not altogether, from an organized effort to repudiate the obligation of the settlers to repay the Government for what it has expended to reclaim the land. The repudiation of any debt can always find supporters, and in this case it has attracted the support not only of certain men among the settlers who hope to be relieved of paying what they owe, but also of a variety of unscrupulous politicians, some highly placed. It is unlikely that their efforts to deprive the west of the revolving irrigation fund will succeed in doing any-

thing but discrediting these politicians in the sight of all honest men."

In writing that paragraph, Col. Roosevelt, we want to say to you that you have done every Water User on the Federal reclamation projects a grave injustice. You have done these people, many of whom have been your most ardent friends and supporters, and nearly all of whom have admired you, a wrong, which you can right only by public apology. You have deliberately insulted some of the most patriotic citizens in the United States. It is only due to them that you should apologize, and do so immediately.

"Repudiation."

That is a word never heard upon the Federal projects except when F. H. Newell, whom you laud so highly, or some of his subordinates, speak. It is a word which these pay-rollers like to bandy about in the committee rooms of Congress. They do it to serve their own selfish ends.

The settlers on the Federal projects never have thought of repudiation of their honest obligations to the United States Government. They have no intention of trying to repudiate these obligations. In fact, they most bitterly resent the slightest hint of such action, and, in the past, have in many instances accepted unfair Water Charges, rather than give any one a chance to say that they had any thought of repudiating their debt to the Government.

Apologize, Col. Roosevelt. Give these men and women a "square deal."

**The
Twenty
Year
Bill**

"I'll confess that if Secretary Lane died or left office before he has time to put his bill into effect, the Federal Water Users would be worse off than they are now."

These are the words of a man who has studied the Twenty-Year Reclamation Extension bill closely, who was in Washington during part of the time when it was being framed, and who is earnestly urging its passage. It is a pitiful commentary on this legislation for the relief of the Federal Water Users. Worse still, it is true.

The bill is so drawn that it is susceptible to numerous and various constructions. Five secretaries of the interior have already put five separate constructions on the original Reclamation Act of 1902, and law officers of the Government have added at least four more. Underground legislation in the shape of jokers in Indian irrigation bills have robbed the original act of many of the benefits it was expected to bestow. Indefinite laws have been one

of the most serious obstacles with which the settlers on the Federal irrigation projects have had to deal. It is time the powers-that-be recognized this and made the laws simple, straightforward, and devoid of subterfuge. As long as men more shrewd as politicians than skilled as engineers, who feel they have tracks to cover, are in at least partial control of the Reclamation Service, complicated, indefinite laws will probably be the order.

Our best information from Washington is that there was an agreement entered into among members of both houses of Congress to avoid substantial amendment of the bill. The passage of the bill in the senate seemed to bear out our information. The Secretary of the Interior is said to have been a party to this agreement, and he has approved the measure. President Wilson has also let it be known that he favors the bill as it now stands.

Under these conditions there is not anything for the Federal Water Users to do but to accept the bill, enjoy the benefits of the extension of payments and trust to Providence that they will escape injury from the dynamite in the measure.

THE IRRIGATION AGE believes sincerely that Secretary Lane wants to help the settlers, but we also believe he has been most badly advised. If he is able to carry out his plans and intentions, he may greatly alleviate the conditions of the Water Users. We hope so. We want to see him do all he has promised to do. We want to see him visit the projects again, and meet more of the settlers. We want his investigations to be much more thorough than those on his previous trips. We believe he will then change some of his present views and plans and adopt a much broader policy toward the Water Users.

The Water Users, in turn, should not stop with the passage by Congress of the extension bill. There are many other reforms which they have demanded, and to which they are entitled. Some of these must be obtained from Congress. Others must come from the Secretary of the Interior and his Reclamation Commission. Keep after these reforms. Clean up the Reclamation tangle. Oust the incompetents and the barnacles. Obliterate the bureaucracy, whose war cry is, "Rule or ruin." Get the projects on a clean, business basis. Settle for all time and in a just manner the size of the farms and their cost. Accomplish these things, and perhaps a few others, and life on a Federal project will be really worth while.

These things can be accomplished by increasing the membership and financial strength of the National Federation of Water Users' Association. It is the Water Users' best weapon.

**Protect
Settlers
and Honest
Investors**

The Governors' Conference, which will be held at Denver, Colo., April 9, is going to try to find some way to put Carey Act and private irrigation projects, bankrupted or abandoned by under-financed or blue-sky promoters, on their feet. It is to be regretted that Secretary of the Interior Lane has found it impossible to be present, but in calling the Conference, he made some suggestions, which will prove of value in guiding the deliberations of the body. It is, in turn, pleasing to note that most of the arid state governors will be present, and that nearly all of them have appointed as delegates men well acquainted with irrigation affairs.

If this Conference succeeds in devising methods of rejuvenating the defunct projects, it will go down into history as one of the most important meetings ever held in the United States. And there seems at this time, little reason why some plan should not be found. Secretary Lane has suggested cooperation of the United States Government and the states in re-financing the projects. We have little doubt, that when he offered this plan, he spoke with authority and for the administration at Washington. The Secretary is also on record as favoring the issuance of \$100,000,000 in some sort of irrigation bonds to continue reclamation of arid lands. Such a sum added to a similar sum, raised by state bonds, if used in a competent, honest and business-like manner, would complete all the present defunct projects and build many new ones, and the returns in increased wealth and better citizenship to the states and nation, would be many times that amount long before the due dates of the bonds.

Whatever is done, the rights of the settlers on the defunct projects should be given first consideration. Their rights should be fully protected.

The bondholders and stockholders, so far as their investment is legitimate and free from watering, should also receive consideration. Those who invested honestly are entitled to some return on their money. In practically every Carey Act project, the state governments were parties, at least by their silence, in inducing investors to purchase these securities. The states of the west are too big and too rich in latent as well as developed resources, to afford to permit themselves to totally repudiate their parts of the responsibilities for the failures. Their citizens are of a kind who would not knowingly allow such action.

If the treasuries and the credit of the United States and the states are drawn upon for these funds, proper safeguards should be afforded. This, no doubt, will have to be done by legislation both in congress and in the various legislatures, and it

should not be done in haphazard, fly-by-night manner.

The Conference can also accomplish much for uniformity of laws and procedure in regard to irrigation affairs.

The irrigation boom days of the West are over. The West is entering on a new era of substantial development. It offers a field for investment of hundreds of millions—investments that will pay big and honest returns. Now let the Governors and their confreres at this meeting set the wheels in motion for such legislation as will keep this development within the bounds of legitimate business, and the West will once more enjoy its full meed of prosperity.

**Alfalfa
Week
in the
Northwest**

Better methods of farming mean better land, better land more abundant crops, all of which lead directly to better homes, moral improvement and a more efficient people.

There is the keynote of the "better farming campaign," which is now being conducted in the states of Idaho, Oregon and Washington. It began with "Alfalfa Week," observed during the past month in every school house in the three states and by the Granges and other farmers' organizations. It will continue throughout the year, and with certainty of big results for the farmers are thoroughly aroused.

This year's campaign is a continuation on a much broader scale of one begun a year ago, when the Holden Improvement Committee was organized among the people of the Inland Empire. Professor Holden, director of the agricultural extension work of the International Harvester company, and his staff of lecturers emphasized these points:

The abandonment of the ruinous one-crop system.

Adoption of a diversified system of farming.

Increased production of alfalfa and corn.

More cattle, hogs, and dairy stock.

A silo for every barn.

The breaking up of the over-large wheat farms.

In addition to the educational campaign this year, many bushels of seed corn have been purchased and are being distributed to the farmers. The best home grown types have been selected.

These samples of corn are sent to those only who are willing to keep a record of the results obtained and report to the committee this fall.

It is the object of the committee to follow up this plan from year to year, collecting each year the most improved types with a view to establishing the best varieties for each locality.

This is a great work. Every farmer in the three states should enter into it. It might well be taken up by other states.

**Need of
Irrigation
Farm Banks
Recognized**

After months of constant work by the IRRIGATION AGE and by settlers on irrigation projects, the Fletcher Rural Credit Commission and the congressional committees, considering rural credit legislation, have finally recognized that the conditions of the majority of the farmers on irrigated lands of the West are different from those of the cultivators of soil in other sections of the country, and even the farmers on the dry lands of the West. As a result, some features may be incorporated in the final draft of the rural credit bill which will inure to the benefit of the irrigation farmers.

The Rural Credit Commission had failed wholly to recognize that on the Federal projects the Government held a first lien upon the farmer's land as security for water charges; that under Carey Act and privately constructed projects, Water Right charges not fully paid up, also represent liens in various forms. The law, as now proposed, provides only for first mortgages as security for long time loans to farmers by the Farm banks.

Secretary of the Interior Lane and the Reclamation Commission finally presented a letter a few days ago to the Fletcher conference, suggesting two possible plans to overcome these conditions, at least as far as the Federal projects were concerned.

One of these provided that the Farmers' banks should accept up to a certain percentage of valuation, and as first mortgage security, a lien on irrigated lands, but recognize as prior that lien of the Government for Water Right charges. Such a lien, no matter what the law might say, would be little else but a second mortgage.

The second recommendation provided for an appraisal of all lands on Federal projects, deduction of the amount of Government Water Right lien, and authorization to the banks to accept as security for loans, mortgages up to fifty per cent of the remaining values.

This latter plan is possibly the more feasible of the two in working out a fiction of credit, but with the present high charges for Water Rights and the small capital which the average irrigation farmer has had for the development of his farm, it really leaves very little security for him, on which to borrow.

THE IRRIGATION AGE has urged repeatedly that the present contracts with the Water Users on the Federal Projects, by which the Government takes a cut-throat first mortgage on the settler's land as

security for Water Right charges, were wrong. The Water Right is a franchise, which gives added value to the settler's land and helps increase the wealth of the nation as well as benefit its citizens. This franchise should therefore be recognized as an asset, and should be sufficient security for the Governments' charges. Without his water franchise, the settler could not do intensified farming. Recognize this water franchise as an asset; just reverse the fiction of credit, and at the end of three years the irrigation homesteader will have his land and his improvements as security, which will be acceptable in Farmers' banks or elsewhere.

**Watch Out
For the
Power
Trust Plot**

Keep an eye on the water power development on your projects, Federal Water Users. Years ago there was a plot hatched to ultimately turn the power plants over to the big power interests. This was done on many of the projects by charging a certain cost, supposed to represent that of the power plants, to the general fund of the Reclamation Service. Thus, it was proposed, to hold title to the power in the government and separate from the projects, which are ultimately to go to the settlers. This, according to the plan, would leave the Reclamation Service free to lease the power to whom it may please. The rest can be guessed. The big interests, who might use this power to great advantage, are not strange to Washington ways nor unacquainted with those who may have a part in the leasing of the power, if they finally get the chance.

It is now proposed under the revaluation of the projects, which Secretary Lane is planning, to charge off still further power sites and developments, that are appurtenant to the projects. This is part of the Reclamation Commission's scheme to hold down the Water Right charges to the settlers by placing the cost of the dams, reservoirs and main works on the projects in the general fund column of the Reclamation books. As the Reclamation law is now construed, reservoirs cannot be turned over to the settlers except by express authority of Congress.

The water power on the projects has always been considered the richest heritage of the settlers. It is worth millions in actual value and many millions more in profits, if it can be put to work for the farmers. It has been developed with Reclamation funds.

Keep your eyes open and keep them on the power development on your project. Watch every move in these revaluations closely. It may mean many dollars in your pocket.

REAL DEVELOPMENT FOLLOWS BURST BOOM

Irrigation Prospects for 1914 in West Are Very Bright—Lane Conference Helps

By GEO. J. SCHARSCHUG

THE irrigation projects of the West are on the eve of the most promising year of their existence, unless all signs fail. It is to be a year of real, constructive advancement; of stabilizing and rejuvenating finances of projects, looted, mismanaged or under-financed by promoters, anxious to make quick and big profits. It is to be a year in which a number of new projects will be put under way. It is to be a year of activity on the Federal projects, several of which should be well on the road to completion before 1914 ends. And better yet, it promises to be a year of greater crops and more prosperity for the farmers on the projects.

It will not be a boom year.

The boom days in the irrigation field are past. Irrigation has settled down into the straight and narrow path of clean, substantial business, and the development this year, the financing, the sale of property will all be on stable lines.

Booms are costly, and the West has had many of them, but from no boom has the West recovered so quickly and with such evidence of greater development on sane lines as it is doing from the irrigation boom. This is because irrigation is right to begin with; it means increased wealth to the nation as well as to the farmers; it means reclamation of that which otherwise would be of little or no value, and it is founded upon land values, the basis of all actual wealth.

There are many elements entering into this revival of irrigation affairs.

The greatest of these, perhaps, is the master stroke of Secretary of the Interior Franklin K. Lane in calling a Conference of Governors of the eleven arid states and delegates from the various irrigation projects at Denver, Colo., on April 9. Financiers and bankers throughout the nation who have had a hand in financing projects in the past have been invited to attend. Holders of irrigation stocks and bonds throughout the South and East have been urged to be there. Still other men of money, who may become interested in the future, have been notified of the meeting. Officials representing various branches of the United States Government will attend. The Secretary will be unable to be present, but will be represented per-



Grain Elevators at Sidney, Mont., in the Heart of the Lower Yellowstone Project

sonally by First Assistant Secretary of the Interior Jones.

The Secretary sizes up the problem with which this Conference must deal in this paragraph of his letter to the Governors:

"It appears, therefore, that no further large development can now be expected unless it is (a) by the use of public funds, state or national, upon which no profit or interest is required, or (b) by the use of funds procured by taxation, as in the case of irrigation districts, and where, also, the ques-

tion of profit and interest on the works themselves is the increased land values and productivity of the soil."

It is upon the first part of the Secretary's suggestion that the hopes of several western governors and other leaders for real material progress is based. It means Federal and state co-operative financing for the completion of Carey Act and private projects, now on financial rocks, and for the development of additional projects which are recognized as feasible but for which capital hitherto has not been available.

If Secretary Lane can have matters so whipped into shape at the Denver conference that he can put the whole situation before Congress, backed by a united West, he should have little difficulty in obtaining the \$100,000,000 which he believes is necessary, or three times that much, in order to carry on the government's share of the proposed co-operative financing.

In the past, Southern and Eastern members of Congress have had among their numbers many who were hostile to Federal reclamation of the Western states. If they are hostile to any demand the Secretary may make for money to help finance partially completed Carey Act and private projects, they will in almost every case be fighting their own people. They cannot afford to do this.

The majority of the stocks and bonds of the irrigation projects upon which interest has been defaulted are held in the East and the South. Wall Street holds large blocks. Millions are held in Chicago. The bankers and financiers do not want to lose all they have invested in these stocks and bonds, and will therefore be glad to urge their senators and representatives to support such a measure.

It is proposed to raise the money needed by an

issue of low interest-bearing Reclamation certificates or bonds, the money to be returned to the United States Treasury through the payments for land and water under the projects.

As Secretary Lane suggests, neither nation nor state can hope to make any monetary profit from such financing and both will lose considerable interest money, but the loss of the latter will more than be repaid to the nation and the states indirectly, it is true, through taxes on the increased value of the lands and through the benefits accruing from a prosperous and satisfied citizenship.

A system under which the money put into the co-operative financing will be handled is yet to be devised, and it is something which must require the best thought of the leaders in the Conference. It is generally agreed that the rights of the settlers should be protected most thoroughly. The settlers, no doubt, will demand and are entitled to a voice in the expenditure of public funds on their projects. Steps should also be taken to avoid falling into the pitfalls, from which the Federal Water Users are now trying to extricate themselves. Chief of these is the danger of bureaucratic rule by Federal and state departments, with their vast overhead expenses and the ever-growing desire of each one of the little rulers in the bureaucracy to make his job last as long as possible.

With the aid of Comptroller W. A. Ryan of the Reclamation Commission, who has had wide opportunity to observe financial methods and affairs, and with the knowledge he has gained in dealing with the Federal projects, Secretary Lane no doubt will be able to suggest a plan, when the time comes—a plan that will combine democracy in organization with business efficiency.

Refinancing of the projects is only one of the topics to be discussed at the Conference. It is expected to lead to more uniformity among the states in their laws and procedure concerning irrigation matters, a renovation of Federal policies in dealing with the natural resources of the Western states and other developments, which will add to the general welfare of the West and the nation.

The Governors of all the arid states are working enthusiastically for the success of the Conference. Several have already named fifty or more delegates and are planning to be present themselves.

"In the future," said Governor Ammons, of Colorado, who has done much to make the meeting a success, "we may seriously anticipate that matters touching our natural resources are to be constructive so far as the general government is concerned. I expect to see one of the largest gatherings of the influential men of the West that has ever come together in the history of the country. The fact that the convention of Western Governors is to assemble in Den-

CROP PROSPECTS ON THE COAST

THE following dispatch concerning conditions on the Pacific coast was received by the Irrigation Age on March 24:

Fifteen hundred miles of Pacific coast valleys and uplands, reaching from British Columbia to the harassed Mexican border, predicted today in expert reports, the mightiest harvest in the summer of 1914 that the extreme west has ever seen.

Seemingly, nearly every product of the temperate and torrid zones is likely to surpass itself. The Washington wheat crop is expected to jump the record of nearly 53,000,000 bushels made in 1912, while, barring unforeseen bad luck down in the Imperial valley, close to Mexico, planters predicted a yield of 85,000 bales of cotton—a bale to the acre.

Bountiful rains, besides going far to insure a great year in agriculture, encouraged the planting of extensive areas in new orchards. Lemons, oranges, raisin grapes, apricots, prunes, apples, and peaches all were reported "excellent."

ver the same week indicates that the attendance is going to be extra large. We hope to get results that cannot but help to develop the states of the West in the matter of natural resources."

John M. Haines, governor of Idaho, says in a letter to the IRRIGATION AGE:

"We, in Idaho, hope for great things to grow out of this Conference. We do not know, of course, just what recommendations will be made, but we trust that the outcome will be a practical working plan whereby the credit of the United

States and of the states may be used jointly in the construction and completion of irrigation enterprises in the West.

"I believe that the Carey Act projects, which have heretofore been partial failures, should be the first to receive attention, and that the rights of the settlers should be given first and foremost consideration. I should like, if possible, to see these projects handled in such manner that the people who honestly invested in irrigation bonds on the representation, even though made without authority, that the state stood ready to guarantee their investment, should receive some return on the money thus advanced by them to promote irrigation development."

But the Governors' Conference is not the only ray of sunshine on the horizon of irrigation affairs. Here are just a few others, indicative of the way the wind is blowing:

The financial program of the Federal Reclamation Service provides for the expenditure of \$23,460,-555.05 in sixteen states.

- San Francisco and Sacramento capitalists are ready to begin work on an extensive system of reservoirs to irrigate lands in El Dorado and Sacramento Counties, California.

The United States Sugar and Land Company is installing a million-dollar electrical power plant and irrigation system in the Arkansas valley, near Garden City, Kansas. Forty thousand acres of land will be placed under water.

The Kuhns, who financed the Twin Falls, Idaho, and other big projects, have let it be known that so far as the financial end of their irrigation companies is concerned, they are rapidly getting firmly upon their feet again.

The Department of Justice at Washington has overruled the Treasury Department and declared that incomes derived from bonds of irrigation districts are exempt under the income tax law. This means that this class of securities will find much more ready sale than they have for some time.

These items are just a few straws, picked from a day's stack of news of irrigation affairs. It might be greatly enlarged, but it is not necessary. All show that while irrigation financing has been dealt some

(Continued on page 187)

The Federal Water Users



A Department Devoted to the
Interests of the Farmers on the
Government Irrigation Projects

EDITED BY GEORGE J. SCHARSCHUG

O'DONNELL BARES PROJECT REVALUATION PLAN

A PLAN is on foot to hold the Water Right charges about where they are at present, and in some cases cut them. This is to be done by giving the Water Users less for their money than what it was generally understood they would get.

Supervisor of Irrigation I. D. O'Donnell let the cat out of the bag during a recent visit to the Uncompahgre project, when he stated that it was the plan of Secretary Lane to charge the tunnels, dams, reservoirs, power plants, main canals and other main works of the irrigation projects to the general fund of the Reclamation Service. This will permit the farmers to pay for and obtain possible title only to the subsidiary canals and laterals, incidental power in the minor drops and other minor works.

This juggling of the Reclamation books is to be done by Secretary Lane's proposed revaluations of the projects, plans for which were announced in his recent letter to Water Users. The "charging off" is expected to effectively stop forever the Water Users' complaints against the extravagance and mistakes of the Reclamation officials, because under this plan the department will be able to reply: "Well, you don't have to pay for these errors, these losses, this incompetency, and therefore you have no excuse to even talk about it."

This is a great scheme. It has merit in this one particular: it may serve to lighten the burden of the Water Users, or at least prevent increasing the already too heavy burden.

The plan may meet with opposition in some quarters because Water Users on several projects have made several Water Right payments, based on charges for the cost of their entire project. Therefore they feel they have an equity in the main works and the power development—the latter being worth millions of dollars in some instances.

It will also raise another question, in which Congress may become greatly interested. The Reclamation Act provides for a revolving fund; in other words, the cost of the projects are supposed to be returned to the Reclamation fund through the payments of the Water Users, and the money used for new projects. If \$40,000,000 to \$100,000,000 is charged to the general fund, the Reclamation fund is liable to stop revolving, is it not? Unless, of course, these main works are sold by the Government to private interests.

It is true, as the Reclamation Act is now construed, title to the reservoirs on the projects is vested in the Government and cannot be transferred except by special action by Congress. It was Chief Engineer Davis who revealed this feature of the

law, more than ten years after its passage, and after some settlers had made numerous payments, based on the total cost of their project.

The revaluations of the projects are not expected to be made until after the twenty-year extension bill becomes a law. Secretary Lane let it be known recently in Washington that he probably would abandon his plan to have the revaluations made by a board composed of three members, one to be named by him, one by the Reclamation Service and one by the Water Users. The Water Users generally resented this plan and told him plainly it was a "packed court." Instead, the Secretary is expected to name one member of each of these boards, let the local Water Users' association name one, and then these two pick the third member. This would be fair.

Senator Smith's report to the Senate on the twenty-years bill says:

"There is one important consideration that is not included in this measure, and that is the charges heretofore made against the Water Users for unnecessary expense in the construction of dams and other works incident to the project. The Water Users under any of these projects should not be required to pay more than the reasonable cost of the works. The man who has to pay for the work has had no voice. His protest against engineering mistakes were of no avail. He has been charged for every mistake of engineers over whom he had no control. He is taxed to pay, in many cases, the salaries of a lot of supernumeraries whose service was ornamental rather than helpful. These ornaments of the service have heretofore had houses built for them out of the farmers' pockets far more luxurious than any ordinary farmer could afford for his own family. There is at this time no danger of a repetition of this reckless extravagance. Justice will not be done until a fair and impartial tribunal of competent men shall be selected to find the reasonable and necessary cost of these works, and charge the people no more and no less than that figure."

The twenty-year bill which the Senate has passed, provides for a new public notice, fixing construction charges. After these notices are issued the charges cannot be raised except by consent of a majority of the Water Users on a project. The Senate bill also provides that the Secretary of the Interior may arrange for the payment of any additional charges agreed to by the Water Users, subsequent to the completion of the twenty years' payments. Perhaps this is expected to solve the general fund problem.

20 YEAR BILL MERRILY ROLLS THROUGH SENATE

THE United States Senate passed the Twenty-Year Reclamation Extension bill on March 18. It is not expected to come up in the House for passage for several weeks, and it may be late in the Spring before the measure reaches President Wilson for his signature. He has announced his approval of the bill, according to the report of the House Committee on Irrigation of Arid Lands.

The measure went through the Senate with little debate, considering its importance and far-reaching possibilities, and with few amendments. The wheels seemed well greased for its passage and the Senators pushed it through with rapidity that indicated a desire to quickly and thoroughly wash their hands of the whole affair.

The committee amendments to the bill were agreed upon without debate. Some of these are important, as they moderate some of the more drastic features of the original measure, framed in Secretary Lane's series of conferences.

Section 2 was amended so as to provide that payments by Water Users already on the projects shall begin on December 1, following the issuance of a new public notice by the Secretary of the Interior, and continue annually thereafter for a period of twenty years. The first four of these installments are fixed at 2 per cent, the next two 4 per cent, and the remaining fourteen 6 per cent of the construction charge. It is understood that the Secretary will issue the new public notices, fixing construction charges soon after his proposed revaluations of the projects are completed.

Section 4 was amended to provide that when a majority of the Water Users on a project agree to accept additional construction charges, following the issuance of the new public notices, the Secretary of the Interior may in his discretion, arrange for the payment of such increased charges by additional annual installments, each of which shall be at least equal to the largest annual installment fixed for the twenty-year payments.

The "landlord" feature of the bill, Section 8, was softened. As passed, it authorizes the Secretary to make rules and regulations governing irrigation of the lands in the projects, but limits the cultivation which he may require of each Water User to one-fourth of the settler's farm unit within three full irrigation seasons, instead of one-half as provided in the

Lane Conference bill, and the cultivation of one-half instead of three-fourths of the irrigable area within five years after filing of the Water-Right application.

Senator Sterling of South Dakota tried to obtain the passage of an amendment advocated by the Belle Fourche Valley Water Users' Association, which is now engaged in a suit to enjoin the Reclamation Service from shutting off water to those settlers who object to the abrogation of their original contracts with the United States government. This amendment, according to Senator Sterling, proposed to confer jurisdiction on the United States district courts in all cases instituted by the Government, by the Secretary of the Interior or Water Users' associations, growing

out of the Reclamation law or the enforcement of its provisions. The original amendment was defeated, but the following was finally accepted as Section 16 of the bill:

SEC. 16. That the district court of the United States for the district where the lands or some portion of the lands included within any reclamation project are situated shall have jurisdiction of all suits brought by the United States or the Secretary of the Interior for the enforcement of the provisions of this act, and jurisdiction of all suits now pending or which may be hereafter instituted by any legally organized Water Users' association or irrigation district in behalf of the Water Users and settlers thereon for the enforcement of the provisions of this act and of the provisions

of the reclamation law as referred to and defined in section 1 of this act.

Senator Borah of Idaho obtained an amendment, providing that the initial payment by new settlers shall be 2 per cent instead of 5 per cent of the construction charges.

The discussion of the bill prior to its passage is enlightening. Senator Marcus Smith of Arizona called it up in the midst of a heated debate on the Wilson Panama Canal tolls policy. After the committee amendments had been agreed upon, Senator Smith said:

"I do not wish to detain the Senate or to take its time further than to say that the purpose of the bill is merely to extend the time for payment of the charges on these reclamation projects that have gone far above any of the original proposals as to the amount that would be charged, coming sometimes to three or four times as much as those making the original investigation considered necessary. The bill extends the time and provides that all future reclamation projects shall come within the first provision, putting them all on an absolutely equal footing. The

A CONGRESSMAN'S VIEW

THIS comment was made to the writer by a prominent Congressman, who has played an important part in framing the twenty year extension bill:

So far as I can learn, the reclamation extension bill has met with hearty approval all over the United States. Every western congressman that I have seen tells me that his constituents have informed him that they are well satisfied with it. There has been some misapprehension as to Section 2 of the bill, but if this section is read in connection with Section 14, it is evident that there is nothing in the bill that compels any Water User to waive any right that he now possesses. If he is satisfied with his present contract and is willing to pay the construction charge in ten years, he is at liberty to do so, but if he desires to obtain the benefit of the act, he must accept all of its terms and conditions. In other words, he must enter into another contract with the government which will supersede all former contracts. Of course no law can be passed impairing any contract and we had that fundamental principle in view when Section 14 was drawn.

committee has not been able to see how any trouble whatever would be caused to the Government or to the Reclamation Service by the proposed change.

"There is another suggestion I wish to make. For a good many months the chairman of the Senate Committee on Irrigation and Reclamation of Arid Lands, the chairman of the House Committee, the Secretary of the Interior, and the Reclamation Service have had this bill under the most careful scrutiny and consideration. After all these labors we have agreed upon the present measure. I trust no amendment will be offered to it, for I am free to say there is not a line or a suggestion in it that has not had the most careful scrutiny of the committees of the two Houses and the other persons already suggested."

Then there was this about Senator Sterling's original court jurisdiction amendment from Senator Smith:

"I trust the amendment will not be agreed to. This very question itself was considered time and time again. By adopting the amendment we would intrude into this bill a condition that absolutely does away with the principle on which it is constructed.

"The bill now follows, and follows intentionally, in that particular the exact language of the original irrigation act. If we put on this bill the amendment suggested, any one gentleman who is strong enough to get up a dispute with a Water Users' Association can take and hold land that he never intends to use; but intends to keep in a monopolistic form until the unearned increment may possibly make him rich. He goes into court and puts up nothing; and after his dummies have held the land for two or three or four years under one of the provisions of this bill he comes in and buys from them at some particular price or they abandon the case.

"The matter is always left in this bill, as it was left in the other, in the discretion of the Secretary of the Interior. This matter of taking the case to court is a thing that naturally appeals to all of us, but it is changing a bill, the purpose of which is to do one thing only, and that is to extend the time. Now, it is proposed to ingraft on it new legislation that affects the whole irrigation system from the day it started up to this hour.

"I sincerely hope the senator from South Dakota will not press his amendment, and that the bill may pass in its present form."

Later Senator Smith added:

"I object to the provision for going into the Federal court for the purpose of suing on questions that can be and have been already settled whenever they arose."

And again after there had been suggestions made and accepted by Senator Sterling to strengthen the amendment, Senator Smith declared:

"It opens the question of the whole status of the present Reclamation Service under the present law and under this proposed statute. These are not conditions where an honest man is making an effort to establish a home; it is against those who are attempting to get into these enterprises and monopolize the lands and do nothing with them except to wait for an increase of value. It is a common practice; there are many cases in my own state. It is a very ordinary case for persons to hold as much as four or five thousand acres. This is to prevent the bringing of a suit

when they attempt to say you shall water this land or the water shall be carried from it to other lands. With that standing there it is a menace to the very enterprise itself."

This was Senator Smith's parting shot:

"I will say to the senator that it would be almost as well not to pass this bill at all as to pass it with all these proposed limitations. They will simply, in my judgment, destroy the chance of the money being returned to the Treasury."

Senator McCumber of North Dakota said:

"The experience of the American people who have had to deal with public lands has been that almost universally they would prefer to try these cases before a court; and the purpose of the amendment of the senator from South Dakota is that a court may determine the question after the party has had a hearing."

To this, Senator Works replied:

"It is a very difficult problem to determine just what ought to be done in these cases. The people who have taken up these lands in a great many instances have not been fairly dealt with by the Government. Contracts have been made with them upon the basis of \$30 an acre, for example, and before they have concluded the project the price has become \$40 an acre, and even more. In some cases the price has run up as high as \$60 and \$75, and I think in one case it has transpired that actual cost to the entryman will be \$100 an acre.

"That is one side of the proposition; but the other side is that it is an exceedingly difficult matter for the Government to collect the money that is actually and justly due from the people who take up these lands. My own judgment about it is that we should be extremely liberal in the way of time; give them every opportunity to make these payments and then insist upon them being made. The Government should be protected as well as the entryman, and the money that comes into the Treasury will be carried on to other projects for the benefit of other people. It is a very well-known fact that there has been very little of the money that has been expended by the Government repaid by the people who have taken up these lands. The intention of the committee was to give ample time within which to make the payments, and then make it compulsory upon the entrymen that they should make the payments, which will be very small in amount, extending over twenty years. It seems to me that the bill is extremely liberal toward them."

The penalties provision of the bill brought forth some interesting comments.

"I notice on page 3," said Senator McCumber, "the bill provides:

"Sec. 3. That if any water-right applicant or entryman shall fail to pay any installment of his construction charges when due there shall be added to the amount unpaid a penalty of 1 per cent thereof, and there shall be added a like penalty of 1 per cent of the amount unpaid on the first day of each month thereafter so long as such default shall continue.

"In other words, if a farmer gets behind in his payments, he is to be charged 13 per cent for not being able to fulfill his contract. The Government can get all the money it desires for 3 per cent; but if the farmer, by reason of the failure of crops or otherwise, does not keep up his end, he is to be charged a penalty of what amounts to a little over

13 per cent. First, there is a 1 per cent penalty, and then there is added 1 per cent a month as long as the default continues. Does the senator think that the necessities of the occasion demand such a heavy penalty as that?"

Senator Smith replied:

"That shocked me, as it did all the balance of the members of the committees of both Houses. They worked on it for about three months, however, and concluded that those hardships were not half so apt to occur as that there would be those who would intentionally avoid it. No man would permit his neighbor's property to go in default for lack of the payment of 1 per cent per month on \$3. One per cent on \$3 will be his first charge; and it keeps a percentage of that kind on so small a sum merely as a penalty for not doing it.

"The reason is to prevent thievery of public lands. The reason is to prevent a man coming into one of these irrigation enterprises and throwing the duties and obligations and burdens of, the great, costly enterprise on other people, holding his land without putting up a cent just as long as he can hold it, going to court, having a suit about it, and staying as long as he can. If you should add the amendment we are talking about, he would never put up a cent and the improvements and the annual charges of the other people would have to be borne in bulk and distributed among those who did pay. It was to keep out that class of people, who number five to one as against those who are in default because they can not pay, that the committee acted."

Senator McCumber proposed an amendment to cut the penalties in half. It was promptly rejected.

A FARMER'S REPLY TO MR. LANE'S LETTER

By J. E. McCUTCHEN
Huntley, Mont.

WHAT I shall attempt to write after reading the letter sent out by the Secretary of the Interior will, I believe, reflect the sentiment of a very large number of settlers on the Huntley project.

The most noticeable thing in the letter is the Secretary's failure to comprehend the homesteaders' position. Probably he thinks he knows full well what he is about, but the Water Users very generally doubt it.

The settler on the Huntley project does not expect any more of the Reclamation Service than it promised. We are asking—yea begging, for that much. But with all our begging the Reclamation Service is handing us more and more of misfortune. The Reclamation Service makes no fair effort to get the homesteaders' side of the situation.

The investigations are made through employes of the Reclamation Service, who are interested in giving a beautiful face to their business, without regard to our expense and almost wholly ignoring what we have to say. They are interested in winning approval for the plans of the Reclamation Service, while if they should give us a fair deal it would result in a very general condemnation of the Service.

We certainly do not want to be excused from paying all we contracted to pay so long as the Reclamation Service makes good its side of the contract, but when we are made to pay more and produce it from land not nearly as productive as was represented to us, and much of it so nearly worthless as to require a lifetime to put it into productive condition, we do ask for a little leniency in order that we may not have to sacrifice the time

and means already expended on the homestead. I can't believe the Department of the Interior is making any fair attempt to give the Huntley project a fair deal. What little it may know of this project has not been acquired from a source that considers the farmer.

If the Secretary and his assistants have attended no more meetings and talked with no more Water Users on other projects than they have with Water Users on the Huntley project, they have come in contact with fewer than "thousands." Taking the Huntley project as a basis, I think they have met fewer than five hundred in the whole reclamation area.

Mr. Lane's visits in our homes, fields and meetings are mostly fiction. We can consider it only as so much flattery when he says the farmers on these lands are above the average in ability and intelligence, and that they are generally of high purpose, resolute, self-dependent and determined. If he meant anything else, he certainly would give ear to our needs as we see them.

He proposes that we shall "reason together," but politely hints that we shall neither think nor speak, while he reasons and talks to us, when he states that his circular letter needs no reply. Be good, children, I know what you need. I'll get it for you, if I can.

We can hardly second the Secretary's request for a law to give him permission to follow out his plans, when we have no part in the reasoning. What the settler wants, and all red-blooded Americans want, is law that will permit him to live and to work with personal freedom.

Where, in any free government, is there such an anomaly as there is in the Reclamation Service?

There is no limit to the tax that the Reclamation Service may put upon us. We are aware that many of us are not doing the best under the circumstances, but there are good and sufficient reasons, and they lie at the door of the Reclamation Service. The conditions are not what the Service represented they would be, and they induced people to come here who had not the means to meet the conditions, and who prefer to do less drudgery than the conditions require.

Some don't know how to do better, but the



J. E. McCutchen



Irrigating a Fifty Acre Potato Field in the Huntley (Mont.) Project.

Reclamation Service permitted these to come, and then condemns them for what creation failed to do for them. And by the way, this class is not loud in its condemnation of the Service. They don't comprehend the conditions.

The Reclamation Service attempts to regulate our whole system of farming by saying when and how much we shall water. We can not plan our labor to advantage; neither can we water when it suits our plans, and sometimes, when the crop needs it.

As an example of the kind of experts in the Service, the following will illustrate: Mr. A. calls for water out of rotation, and says his crop is suffering. The Reclamation Service sends out two experts, who, with shovels dig into the soil to examine moisture content. They know all about irrigation, and farming, too. The farmer saw the crop wilting and the foliage burning in the fierce sun heat. But he has not yet learned much about irrigation, and less about farming. And it is a sure thing the Service will never concede he does know anything as long as it can get Congress to believe their side of the business and thus keep in existence a system

to give jobs to a host of boys, who are not half qualified for the work.

Our water service is costing much more than we were led to believe it would, but there is no effort being made to reduce it, and it is being increased without any regard to our ability to pay. We were told that maintenance and operation expenses would drop from sixty to forty cents per acre very

soon. We are now paying one dollar per acre, and I am informed that is much less than half of what the expense actually is.

The construction was never completed and much of it was cheaply done. The structures were generally wood. These are now being replaced by concrete. If they had been made of concrete in the first place we would have been saved a large expense. Some of this woodwork is good for one to three years yet, but it is being removed, causing us more expense.

Many, very many mistakes are made by the experts and we pay the bills with no power to dismiss them for carelessness and incompetency.

It seems that the Department of the Interior from the first has limited the size of the homestead to what will enable a family to exist and then concludes that is the proper size to support a family. Then in order to prevent the head of the family from getting above a mere existence, he may not buy an adjoining homestead until he pays all his water right charges on his land. How then are we to keep the boys and girls on the farm, milk cows and raise sugar beets? Intelligent boys and girls refuse to stand all day with their noses between their knees or crawl on hands and knees all day thinning sugar beets.

Still the farmer is expected to build modern houses and barns, put in furnace heat, light and water and labor saving machinery, and perhaps buy an automobile. Why shouldn't he? He has been buying autos for the Reclamation Service experts to ride in when they come to his place to dig for moisture content, and to do "joy riding."

One may not fully appreciate this condition until he attempts to farm a forty acre unit. When clearing and grading the surface, forty acres is enough to begin with. But when it is once in proper condition to irrigate properly, he discovers that his horse force and implements that will do his work to best advantage, could just as well operate another forty acre unit. This would give the older boy an opportunity to be a farmer, but the father may not buy another forty except under very onerous conditions.



Frederick J. Cox
President of the Huntley
Waters Users' Association



Grazing a Band of Sheep on the Public Range Surrounding the Huntley (Mont.) Project.

Two more horses with no more implements would enable the next boy to farm at home, but father is not permitted to buy the land.

Surely 160 acres is too much for most families to begin with on irrigated land, but there should be some arrangements whereby a farmer may justly acquire more than one forty. Else the family must be reduced to the condition of the European peasant.

The superintendent of irrigation recently appointed to draw a large salary out of our meagre earnings is permitted to own a 160-acre tract on the Huntley project, and to hold it only for pasture land, while we improve the country to enhance the value of his holdings. Neither does he pay construction charges nor maintenance and operation expenses.

Do you think such a person is in sympathy with you?

There is more land held in the same way here. It was Indian allotments. Parties have been permitted to buy this land and hold it out of cultivation. The ditches to supply these lands with water were built by the Reclamation Service, and are now generally abandoned, but we foot the bills.

Most people now owning such lands prefer not to buy water of the service, because the terms are so onerous and the charges so exorbitant. One man has built his own ditch at less than half what the Service charges.

Farming on some of the units on the Huntley project certainly is not good enough to pay M. and O. charges. The products from some of the units have not been sufficient to buy bread for a small family. Some have not returned even the seed. A paid-in-full water right and a patent would not induce many of the experienced farmers to accept some of these units as a free gift.

I don't wish to convey the idea that the lands are all poor. Some other of these lands are worth \$100 per acre on basis of yields.

Quite a number have rented their homes to Russian peasants and more want to rent and move away. They wish to find employment that affords more than a mere existence and to get from under the dictation

of the impractical Reclamation Service. Some of these have become so involved in debt because of conditions here as to be compelled to auction their personal effects and seek work for wages. They have borrowed money to pay M. and O. and other expenses.

The Reclamation Service points to its success with the Huntley project. If the service were not so notorious for blunders and exaggerations, one might believe it had made a success of Huntley. Whatever of success the Huntley project has had, has been obtained in spite of the Reclamation Service. The service makes pictures and publishes reports of the exceptional cases, not giving the average or any of the unfortunate instances.

If we could get congress to move out here and farm one season, we certainly would get better treatment. Every man who aspires to a position in the Reclamation Service, even the Secretary of Interior, should be compelled to live upon and farm a homestead on one of the government projects.

Perhaps the department could then tell us why homesteaders should water by a rotation system predetermined, prearranged, predestined and fore-ordained, while the government's experimental farm may have water on demand.

This experimental farm is another great blunder to charge to the western boomers. It was first called the Demonstration Farm. We are unable to tell why. It has never demonstrated anything except how to dissipate government funds. Settlers thought it would demonstrate to us how to farm these new lands. We have learned that in a large measure by our own experience and that before the experiment farm got into action.

The Secretary's reference to "the experts of the Service and those outside of the Service, who have been longest accustomed to irrigation and who have developed all that is known on that subject," would be ludicrous if the consequences were not so serious.

(Continued on page 183)

*Scenes on the Huntley and Lower Yellowstone government irrigation projects in this issue are from photographs made by the Northern Pacific Railway photographer.

PUT YOUR ASSOCIATION TO WORK

ARE you finding a market for all you raise on your farm?

Are you getting the best market prices for your products?

Why not?

These are questions which every settler on the Federal irrigation projects should ask himself. Some of them have already done so and answered the questions, at least in part, but there are still thousands who are taking whatever they can get for their products, and are dumping their surplus into the sloughs.

There is a market—and a good market—for every pound of produce raised on the Federal projects. None should have to go to waste. None should have to be sold for less than a fair price.

What is the answer?

Co-operation.

The absolute necessity of co-operation among the members of a farming community in the sale of produce is becoming evident to all students of living conditions in the United States. This co-operation can only be obtained through thorough organization.

In no section of America is there better opportunity for organized co-operation in marketing farm products than on the Federal projects. This is true because the foundation of the organization is already built. It is the Water Users' Association. On those projects, where the Reclamation Service has permitted the organization of the Water Users, the settlers are already bound together by constitution and by-laws which make it possible, with little change, to turn the association into a most effective business organization, which can market the produce of the project in bulk, in the best markets, at the opportune moment and at the best prices. This kind of marketing means the elimination of one or more middlemen and lower freight rates, because of the bulk shipped, and as a result more money to the farmers.

Put your Water Users' Association to work for you.

You buy in an organized market and you sell in an organized market. Meet organization with organization.

If the hens are laying an oversupply of eggs, you cannot tell them to wait until winter, when the prices will be up high. It is the same with all the other products on your farm.

There is always this element of risk entering into the handling of farm produce. As a result, we have



Hogs Are a Money Making Crop on Almost Any Irrigated Farm. This Photograph Was Taken in the Lower Yellowstone Valley of Montana.

boards of trade to buy your grains—butter and egg boards, fruit and vegetable commission men. They are and have been the risk-taking group. They do not intend to lose, if they can help it, so they fix the margin of profit, between the price they pay the farmer and the price they charge the ultimate consumer, big enough that if the market should take a downward move, they are on the safe side, and if it should rise, they are well off. This is the real explanation for high prices today.

The grower should carry the risk a little farther ahead and reap at least a fair share of the rewards that now go to the commission men.

This is possible if you put your Water Users' Association to work. And it is not such a big task.

To begin with, practically every government project offers conditions under which can be raised some of the best of any class of the orchard or farm products. Not only can these products be raised of better quality than in many other communities, but they can be made ready for the market at an earlier date. A high grade of produce and on the market early means good prices.

Put the products on the market through the Water Users' Association under some particular name or trademark that will become known. Make each box of such produce that you send out a forceful advertisement for your brand and your project. This can be done by educating your settlers to grade their produce. Keep out the culls—whether it is apples, chickens, onions, potatoes, or whatever you are marketing. Do this by rules of your association. Do this by thorough personal interest. Make the brands of your projects stand for quality. It means money to you.

On practically all the Federal projects there is power development. This means that at low cost, your Water Users' Association can construct and maintain refrigerating plants and warehouses in which to store your produce if the market is not favorable when the crops are harvested. The association can go still further and equip for the icing of cars, in which the produce is shipped. All this can be done at much less cost to the farmer than he now has to pay, because the power is right at hand.

The association can go even further and construct such additional elevators as may be needed on

the projects to hold the grains until the market is offering a fair price.

Now for the markets. Practically every big market in the United States is within reach of the farmers of the Federal projects, if the marketing of the produce is handled in a business-like manner. A competent market secretary, whose business it is to keep in close touch with all markets and to study them closely, backed by such an organization as any of the Federal Water Users' associations, properly awakened to its possibilities, will be, can sell and ship the project's produce at the psychological moment and to the markets paying the best prices, and he can develop new markets. Because the shipments will be in larger bulk, therefore, the carrying charges will be lower. The association will also be able to practically pick its own buyers, having both quality and bulk to offer, and this means more certainty of payment for produce.

The Water Users' associations were organized originally as representatives of the settlers in their dealings with the Secretary of the Interior, the Reclamation Service and other branches of the United States government. It was intended that ultimately these projects should take over ownership and operation of the projects. Various constructions of the Reclamation Act and rulings by Secretaries of the Interior have made the associations little more than empty shells, but they are shells with great, big, outstanding possibilities for benefit of the Water Users. They are nearly all incorporated bodies, with power to levy assessments and carry on various forms of business. Put these shells to work. They can be turned into gold mines by making them the marketing agents for the projects. It won't hurt the associations to do this. They will be much stronger and better equipped to handle the operation of the proj-

ects, should they be turned over to the settlers. It won't hurt the Water Users. Instead, it will promote better farming, more pride in the projects, and bring more money to the farmers.

The benefits of co-operative marketing on such a large scale as this may not be evident immediately, but it is bound to come. A farmer, nowadays, must not only figure on this year's market, but on next year's, and for many years ahead. You can do this best through your Water Users' Association.

Co-operative marketing associations on many of the private projects and in dairying communities go even further than just handling the sale of produce. They buy pure-bred sires to raise the grade of the live stock in their communities, and all farmers know there is no greater truism than this one—the sire is half the herd. They buy seed, machinery and other farm necessities in the wholesale markets for their members. They hire experts to help raise, pack, ship and market their produce. They copyright brands and labels under which their produce is sold, and some even go so far as to handle the care of farms or orchards for members who are sick and unable to do their own work.

The Water Users on the Federal projects all have well-established towns in their projects or near them, and will probably find it unnecessary to enter all these various fields, but there are some of them—and co-operative marketing is the biggest of them—which are essential to the success of the farmers.

This is not Socialism. This is business—big, organized business, the kind that makes profits. Your Water Users' Associations, on paper today, represent millions. Make these millions real. Make these millions pay profits, which only organized business can and does pay.

Put your Water Users' Association to work!

EXPERT ADVICE FOR THE FARMER

F. F. Everett, living two miles east of Scott's Bluff, Neb., had his potatoes hailed out just as they were starting to bloom. He thought by breaking off the bruised and battered vines, whatever strength the plants might have would go to producing tubers instead of sustaining worthless, crippled tops. He plowed the tops under, using a common cultivator, then with a hayrake broke off the ragged vines, the dirt holding down the ends. The stubs left, being two to six inches high, took on new foliage, and he raised 200 bushels per acre, while his neighbor, who gave his up as a bad job, did not harvest any. The salvage proved a good average crop, just because the man on the farm used his brains, and was not afraid to put some labor into the experiment.

LET THE PIGS FORAGE

Farmers and pig growers do not always appreciate the value of green feeds and succulent pastures for their animals. Too often the hog is considered a scavenger, and his ability to use waste is regarded as his chief value. However well he serves this purpose, he will pay well for good care, feed, and hous-

ing. Forage crops are especially beneficial to young, growing animals. It is possible to grow them much more profitably and successfully when a good green field of palatable and nutritious pasturage is provided. Experiments and practical farmers' experiences prove that gains in weight are made at less cost on forage than in the dry lot. Brood sows can be carried through the season on pasture at less cost than when grain fields are entirely depended upon. Foraging induces the animal to exercise and obtain fresh air, and these prevent diseases being contracted, and when the animals are put in the fattening pen their gains are unusually rapid and profitable. The green feeds eaten are of much value just to keep the pig's digestive system in good condition and the appetite keen.—The U. S. Department of Agriculture.

KILLING POULTRY FOR MARKET

Grasp the chicken, when killing, by the bony part of the skull. Do not let the fingers touch the neck. Make a small cut with a small, sharp pointed knife on the right side of the roof of the chicken's mouth, just where the bones of the skull end. Brain for dry picking by thrusting the knife through the groove which runs along the middle line of the roof of the

mouth until it touches the skull midway between the eyes. Use a knife which is not more than two inches long, one-fourth inch wide, with a thin, flat handle, a sharp point, and a straight cutting edge.—The U. S. Department of Agriculture.

STOP SAN JOSE SCALE

San Jose scale is one of the worst insect pests attacking orchard trees in this country. Undoubtedly the best remedy for this scale is a thorough treatment with lime-sulphur mixture late in the winter or early in the spring, before the buds begin to open, on the trees. If home-made lime-sulphur sprays are used, probably there is no better formula than the following:

Good lump lime, 15 pounds.
Flowers of sulphur, 15 pounds.
Water 50 gallons.

The lime should be slacked in warm water and, as soon as the slacking has been well started, the sulphur should be added and enough water kept in the receptacle to keep the mass thin and sloppy. Boil for at least forty-five minutes, or until the liquid is a deep brick red in color; then dilute to fifty gallons and apply at once.—C. P. Gillette, Colorado Agricultural College, Fort Collins, Colo.

FATTEN AND SELL OLD HENS

Any old hens that you suspect of being too aged for profitable egg production should be promptly marketed before the flock is fed up for winter laying. Old infirm roosters should be sent over the same route. But feed all of them a while before selling, confining them in a pen to themselves about 10 days prior to the time for marketing.

THE HOME CANNERY

A question of paramount importance to every farmer in Idaho today is whether the installation of a small cannery is a profitable undertaking. Can the by-products that go to waste at home annually be utilized and sold at a profit? The results of our experiments thus far seem to indicate that an undertaking of this kind would be profitable, especially for those not having access to commercial canneries.

As an illustration we will take the home canning of string beans. The overhead charge for canning a No. 2 can of beans this year was 7 1-3c per can. This included shipping, blanching, canning, soldering, tipping, processing, cost of can, etc. There are 56 pounds to the bushel and it takes approximately $\frac{3}{4}$ pound to fill one can, hence one bushel would fill 74 2-pound cans. Figuring 100 bu. per acre would give 740 2-pound cans per acre. At 7 1-3c per can it would cost \$532.70 per acre for canning. At 10c per can, our selling price, the amount would be \$740, or in other words, by running beans through a home cannery, the profit per acre would be \$207.30—C. C. Vincent, Acting Horticulturist, Idaho Experiment Stations.

DON'T RUSH THE GARDEN

It does not pay to be in too big a hurry to get the garden started. Manuring is of first importance, and all of the garden needs a good application. Then

TRESTLE AND FLUME AT TAOS, N. M.

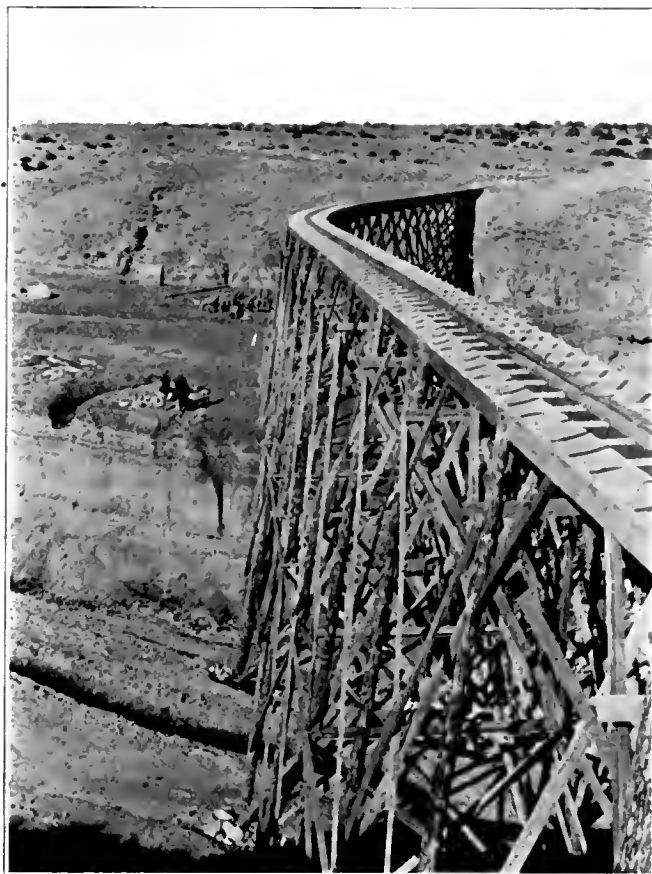

The above halftone shows a trestle erected by the Klauer Manufacturing Company, Dubuque, Iowa, over Hondo Canyon near Taos, New Mexico. The trestle is 80 feet high and attention is called to the curve of flume on trestle. Another feature of this flume is the use of steel crossbars supporting the running board, which is seen in illustration. This flume is used for carrying water to irrigate 6,000 acres of the best land in the Taos valley. Many difficulties have been encountered in securing water for this tract, all of which have been overcome.

it should be well plowed. Plant the seeds in long rows, as they are easier to cultivate in that way, particularly if the cultivation is done with a wheel hoe. With such a tool the rows can be closer together than where a horse-drawn cultivator is used.

STATEMENT TO GOVERNMENT

Statement of the ownership, management, circulation, etc., of Irrigation Age, published monthly at Chicago, Illinois, required by the act of August 24, 1912.

Note.—This statement is to be made in duplicate, both copies to be delivered by the publisher to the postmaster, who will send one copy to the Third Assistant Postmaster General (Division of Classification), Washington, D. C., and retain the other in the files of the post office.

Editor—D. H. Anderson, 30 N. Dearborn St., Chicago.
Managing Editor—George J. Scharschug.

Publisher—D. H. Anderson.

Owner—D. H. Anderson, 30 N. Dearborn St., Chicago
D. H. ANDERSON, Publisher.

Sworn to and subscribed before me this 31st day of March, 1914.

(Seal.)

MICHAEL J. O'MALLEY,
Notary Public.

(My commission expires March 8, 1916.)

LETTERS TO THE EDITOR

Newell, S. Dak., March 21, 1914.

Editor of THE IRRIGATION AGE:

I have just read the March issue of the AGE, and believe that I express the sentiments of a vast majority of the Federal Water Users when I say that its editorial columns, as well as the department devoted to the interests of the Water Users by Mr. Scharshug, present to Congress the most patriotic appeal ever made in behalf of a down-trodden constituency.

Not since December, 1911, when a number of the Federal Water Users' Associations met in Chicago and organized the "Federated Water Users' Association," from which has culminated the "National Federation of Water Users' Associations," have I felt so encouraged. Of course there are many rocks ahead, but certainly the Congress and Secretary Lane cannot help but recognize the rights of the Water Users and must realize that the success of the Government's reclamation policy is dependent upon the success and prosperity of the Federal Water Users.

From the homes of these Water Users and settlers emanate words of the highest praise and commendation for you and your able assistant, Mr. Scharschug. Theirs is a just and most deserving cause, and your fearless championship of their appeal for relief is strengthening them for another year's toil. May the April issue bring us some glad tidings from Congress is the hope that is uppermost in their minds. If a little encouragement is offered and confidence in their Government restored, these irrigated farms will bloom this coming year as never before, and the entire nation will benefit thereby. This is not a cause of section or faction; it is America's cause. Citizens from every state in the Union are settled on these projects. They are the gardens of these entire United States. The gardeners stand ready with the plow, the hoe and the shovel, waiting the offer as to their portion of the fruits of their labors. Will the Government take it all and a mortgage on their posterity, or will it leave them a winter's supply and the wherewith to begin another season's toil and hope? Spring is here. We are ready for the question. Congress can answer.

O. E. FARNHAM.

Orman, S. D., March 20th, 1914.

Editor of THE IRRIGATION AGE:

Have just finished reading the March issue of the AGE with greatest of interest and certainly appreciate your efforts in behalf of the Federal Water Users. I am a farmer, but as we are having blustery weather I have written a short article to contribute to your pages.

Hoping that you may see your way clear to publish same and wishing you success, I remain yours for the right.

C. L. GRISWELL.

Mr. Griswell's article reached THE AGE office too late for publication this month.

Phoenix, Ariz., March 20, 1914.

Editor of THE IRRIGATION AGE:

The March issue of the AGE is fine and reads good from a Water User's standpoint. I gave my copy to I. D. O'Donnell, government supervisor of irrigation. Please send me a half dozen more copies.

SAM BARRETT.

Phoenix, Ariz., March 20, 1914.

Editor of THE IRRIGATION AGE:

The March number of THE IRRIGATION AGE looks O. K. to me. Some hot stuff all right. We are under the impression here that the Reclamation Service will give almost anything we ask rather than have Congress investigate.

Yours very truly,

H. A. BUSTRIAN.

Orland, Cal., Feb. 28, 1914.

Editor of THE IRRIGATION AGE:

The sample copy of IRRIGATION AGE at hand and am well pleased with its make-up. I am in hearty accord with you, in regard to your attitude on the Federal irrigation situation.

I think the average settler needs assistance from some source, as it seems there is always a graft in everything.

There has been little complaint so far in this project in regard to the water supply, but there are several thousand acres to be improved yet.

I am well aware that it is a hard problem to keep every one pleased and satisfied, but it seems to me that if Secretary Lane really tries to do as he says he should have the support of every Water User in the land.

M. N. WILCOX.

Fallon, Nevada, March 3, 1914.

Editor of THE IRRIGATION AGE:

Enclosed find \$1.00 for a year's subscription to your publication. I wish to read the people's side of the question as well as the Government's (*The Reclamation Record*), and oblige.

F. M. MURCHISON.

Somerton, Yuma County, Ariz., March 20, 1914.

Editor of THE IRRIGATION AGE:

The March issue just received and carefully read. It is the signal of war to the finish until this confiscation business ceases, and sane government of the Service prevails instead of bureaucratic methods.

The March issue is going to create a furor; that you can depend on. You may expect a back fire from many sources, but the most dangerous sources will be from Water Users' associations whom the Service has got under their control, and the business interests in the towns who care nothing for the business interests of the farmers and know less about our interests. Commercial clubs will be organized against you as they have been organized against me. Do not mistake the power of the opposition that will show itself. This you must prepare for. Wise councils should prevail.

The Executive Committee of the Federation should have a meeting in Chicago to carefully lay before you many things that have not yet been touched upon, such as individual sufferings caused by the methods of the Service. These we have had to refrain from bringing out in the past as we believed we would succeed by a discussion of general principles. In this we have failed, and perhaps it is the individual conditions that will speak louder than general principles.

Our homesteaders are now slinking back into their holes discouraged, preparing for the reduction of their lands under Section 13 of the new bill, and they have not a dollar to spare, and they are unable to express themselves through their association for the reason that the Service and the commercial interests of the town have carried the election against the farmers by means of the large holdings of speculative lands held by the commercial men of the town.

EARL B. SMITH,

Chairman of the Executive Committee of the National Federation of Water Users' Associations.

ARTESIAN WELLS IN NEVADA

Many artesian wells are being drilled in Nevada for the irrigation of lands. Under a recent state law, each county is permitted to appropriate \$5,000 a year for the purchase of well drilling machinery and testing for water. The drilling machinery can be loaned or leased by the counties to ranchers who want to put down wells. Several wells, drilled in the Smith valley in Douglas county, produced big flows. One of these is giving a flow of 240 to 250 gallons of water per minute from a depth of 296 feet. The discovery of the artesian belt is resulting in rapid settlement of the districts.

REORGANIZE CHELAN PROJECT

A reorganization of the Chelan-Howard Flat irrigation project near Chelan, Wash., is under way. It is proposed to form a district, embracing these lands, for the purpose of bonding and installing a pumping plant and pipe line to deliver water from Lake Chelan for the irrigation of land within the district. The new district includes about 2,000 acres, much of which was included within the former proposed district.

BRIEF NOTES FROM IRRIGATION PROJECTS

California

The new owners of the Citizens Water Company of San Jacinto are making plans for extensive improvements to their plant. The system will be extended to irrigate several hundred acres of additional land and much work will be done in the way of water development at the Cienega, the source of the company's principal water supply. Improvements and expansion plans contemplated will mean the expenditure of \$100,000 or more during the current year.

Articles of incorporation have been filed by the Automatic Irrigating Machine Company, Inc., with a capital stock of \$250,000, of which sum \$500 has been paid in. The life of the corporation is fifty years. The office of the company is located at Oroville.

The jury in the case of S. E. Foster vs. Turlock Irrigation District, in which the plaintiff sought damages of \$1,000 from the district on the ground that he suffered the loss of his wheat crop because denied his pro-rata of water last spring, returned a verdict in favor of the irrigation district. The case was one of most importance as a decision against the district would have materially changed the water distribution in both the Modesto and Turlock districts.

All attachments filed against the property of the Solano Irrigated Farms have been lifted through the efforts of Patrick Calhoun, of San Francisco. Claims aggregating more than \$50,000 have thus been taken care of and the way paved for the continuance of the immense work started last year, but brought to a sudden termination when subscriptions to stock failed to materialize.

Work on the 14-inch well on the F. M. Hudelson ranch west of Hughson is being rapidly pushed to completion. This well will be developed to deliver 1,000 gallons or more per minute. The water will be used for irrigating the 45-acre nursery of Campin & Hobart, which will be set out this spring.

The U. S. Reclamation Service is asking for proposals for building and structures of the East Park Feed Canal in Colusa County, near Stonyford in connection with the Orland irrigation project. The work involves about 6,000 cubic yards of excavation; 4,000 cubic yards of concrete, the placing of about 49,300 pounds of reinforcing steel and 14,150 pounds of metal work and gate fixtures, and the placing in structures of about 30,500 feet B. M. of lumber. Bids will be opened at two o'clock p. m. April 21, at the office of the Reclamation Service at Orland.

Colorado

Bids for the excavation of 1,500,000 cubic yards of dirt in the thirty miles of High Line canal in the Grand Valley project have been asked for by Project Engineer J. H. Miner. The bids will be opened at the office of the Reclamation Service in Grand Junction on May 1. This is the largest excavation the Reclamation Service has ordered in any of its projects in seven years. More than 1,000 men will be employed.

Colorado's irrigation projects are doing well. Last year Colorado's yield of agricultural products was estimated to be worth \$80,000,000, and this year, with new land under irrigation, the total is estimated at \$100,000,000. The supply of water for irrigation purposes is more ample this year than it has ever been before.

This is the third year that the Riverside Irrigation Project has been in active operation. Thus far there has been plenty of water for all farmers who have plowed up their lands. There are at present about 5,000 acres under cultivation. The entire area under the ditches amounts to 30,000 acres. The project is safeguarded by the great Riverside reservoir, which holds 40,000 acre-feet of water when full. At the present time there are 30,000 acre-feet of water in the reservoir, and the spring run-off will increase this amount.

Nevada

Judgment in the sum of \$2,100 was awarded Pietro Cassinelli in the district court at Reno recently as the

result of damage done to his crops when Benj. Raggio interfered with a 41-inch flow of water on his property. The case was the first of three that have been filed against Raggio. He is accused of having stopped the flow of 150 inches of water on the Cassinelli ranch as a result of which the ground was flooded to a depth of several inches and the crops were damaged.

Fifteen thousand acres of land in Spring Valley near Ely are to be reclaimed by means of water supplied by a hydro-electric plant. Judge Benjamin W. Coleman of Ely is at the head of the enterprise. Right to use the water of Cleve Creek has been granted Judge Colman by the state engineer. Since securing the right he has had a preliminary survey made, which shows that water can be conveyed through a ditch for a distance of two miles where a 200-foot fall can be obtained. It is proposed to build a power plant here where 300 horsepower can be generated at a small cost. The cost of the plant is estimated at \$150,000.

Charges of unlawfully disposing of lands and water rights and of unlawfully obtaining property and large sums of money from homesteaders are contained in reports forwarded to the general land office by the commission of industry, agriculture and irrigation having charge of Carey Act projects in the state of Nevada, in relation to the operation of the Nevada Land, Water & Power Company and the First Mortgage & Real Estate Company, doing business in Los Angeles and San Diego, Cal. The companies' operations have been carried on outside the jurisdiction of the Nevada authorities, and for this reason the cases have been called to the attention of the federal authorities. The Carey Act withdrawal in question consists of 25,000 acres of land near Moapa, Nev.

Texas

The Llano River Irrigation & Milling Company of Junction, Kimble county, has filed with the state board of water engineers a certificate of appropriation of the waters of the Llano river for the irrigation of 10,000 acres of land in Kimble county.

Alexander Boynton has closed a contract with Kilgore & Stott of Uvadle, Texas, for the construction of a dam across the Nueces river near Crystal City and an irrigation system to cost about \$200,000. The dam will form a lake seventeen miles long, with an average depth of thirty-five feet. Seven miles of canals will be built. These will have an average depth of five feet and be eight feet in width at the bottom. About 2,000 acres of land have already been cleared and will be placed under irrigation as soon as the reservoir is completed.

A petition to create an irrigation district at Harlingen has been filed in the County Court at Brownsville. The farmers at Harlingen have decided to take over the holdings and system of the Harlingen Land & Water Company. The consideration is said to be \$400,000. Under the new district 40,000 acres will be taken in.

Utah

Articles of incorporation have been filed with the county clerk by the Down Ditch Water Company of Huntsville. The company is incorporated to conduct a general irrigation business. Under the articles of incorporation the company will be permitted to build dams, reservoirs and irrigation ditches, and to supply water for domestic purposes.

At the recent annual meeting of the stockholders of the Kaysville Irrigation Company, the proposition of building a reservoir to store enough water to furnish two irrigating streams for 45 days was passed upon favorably. The project will cost approximately \$25,000. The site of the reservoir will be on Simmons' ranch a mile northeast of Kaysville. The plan for financing the undertaking calls for the sale of 495 shares of stock in the company at the par value of \$25 per share, and the converting of 30 shares of secondary stock into primary shares at \$22.50 a share.

With the completion of the Uba dam on the Sevier river, 70,000 acres in eastern Millard county will be

brought under cultivation. The Sevier Land & Water Company has reinforced the dam and raised the crest 25 feet.

Miscellaneous

The Reclamation Service is asking for proposals for the construction of about five miles of the north canal and fourteen miles of laterals on the Belle Fourche Project, South Dakota. The work involves the excavation of about 199,200 cubic yards of material north and east of Newell. Bids will be opened at four o'clock, April 15, at the office of the Reclamation Service, Newell, S. D.

A. W. Lawrence is making preparations to put in an irrigation system on his fruit farm near Sturgeon Bay, Wis.

The Central Oregon Irrigation Company has been prohibited from making any more sales of land from its grant in eastern Oregon without previously taking the matter up with the State Land Board. The cause of the action is based on the claim that the company, because of seepage, is unable to irrigate all the lands which it had sold and held open for entry.

Despairing of any large concern undertaking reclamation of the settled lands of the ceded portion of the Wind River Indian Reservation, the settlers of the Lost Well Butte section of these lands have decided to apply to the state for a water-right covering 10,000 acres and to construct a system of their own. The plan calls for a main ditch about 30 miles in length, which, it is estimated, can be built for about \$120,000.

MEET FROST WITH HEAT

Be prepared for late spring frosts. A specialist of the United States Department of Agriculture, in discussing orchard heating, makes the following suggestions:

"It is better to have many sources of heat than few even though the total amount of heat is the same in both instances. The heaters should be placed from 20 to 22 feet apart each way in rows between the trees rather than near to or under the trees, and on the windward side of the orchard they should be about 10 feet apart in a row, perhaps 15 or 20 feet away from the first row of trees and outside of the orchard. This outside row thus has an extra number of heaters because it must protect the first row of trees and because the heat from it is so much scattered by the wind that fewer heaters could not give the necessary protection. The heaters are placed in rows to facilitate filling, lighting, and extinguishing them.

"The condition of the fruit buds whether partly open, or wide open, makes some little difference in the danger point of the temperature, but as soon as they first begin to open, 32° F. had better be accepted as meaning trouble. While the buds are still closed they will stand a lower temperature and heating is seldom or never done until they begin to open. Good judgment is necessary at this

(Continued on page 184)

GOOD ENOUGH Heavy Deep Furrow Sulky Plow

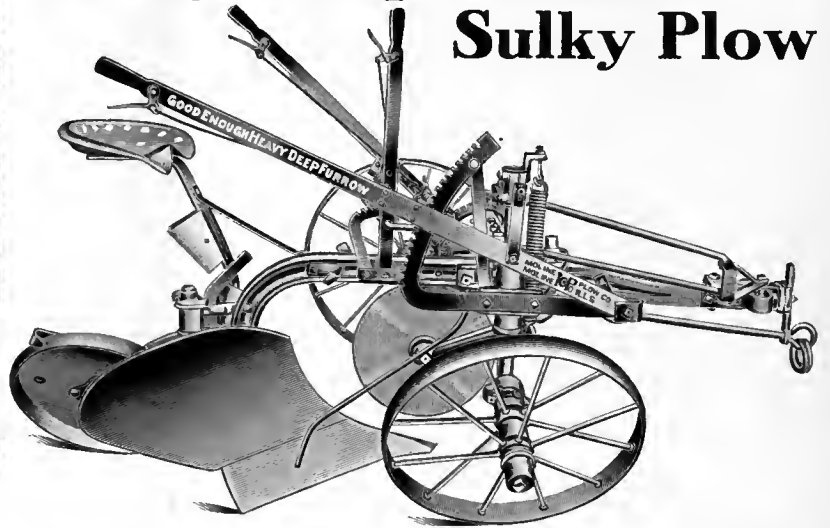

Save Moisture—Increase Yield

Plow deep—form deep moisture reservoirs—increase the feeding area of the plant roots—liberate more plant food. Do these things and your crops will be greatly increased. The Good Enough Heavy Deep Furrow Sulky is the most efficient plow for deep plowing on the market.

The Good Enough Heavy Deep Furrow Sulky is a tremendously strong and powerful plow. It will plow any soil that is capable of being plowed and will turn a furrow from 6 to 15 inches deep.

The landing lever controls both the front furrow wheel and the hitch. The dial hitch can be adjusted to either side and up or down. The draft is applied directly to the beam through the heavy draft rod. The rear wheel is locked in place, but can be instantly released by means of the foot trip at the ends of the rows.

Regularly furnished with five-horse evener, rolling coulter and extra shares.

**See Your Flying Dutchman Dealer
or Write for Information**



Moline Plow Co.

Dept. 3

MOLINE, ILL.



FARMER'S REPLY TO MR. LANE

(Continued from page 176)

We homesteaders wonder why the experimental farm doesn't abide by the rotation system, for surely a man is not qualified to do experimental farming, if he can't conduct his experiments under irrigation by rotation.

The experts of the Service farm on paper and irrigate on paper. This paper exercise has prevented the experts from acquiring a practical knowledge of farming under irrigation. Whatever of practical knowledge they have has been acquired by watching "ignorant farmers." I asked one of these experts how much water to put on a field of oats. Oh, just give it a good soaking, he replied. And he is still in the Service. It doesn't seem possible that the later irrigators can learn anything new or even what the "earlier"

irrigators learned as we are still assumed to be ignorant of how to irrigate. And the farmers on the Huntley project never will know until they cease to be "above the average in intelligence, etc." For it is only a degenerate class that can be willingly made to do the bidding of the Reclamation Service. We have been accused of using too much water on the Huntley project, thus causing seepage. That is true in isolated cases, but it is not true in general. Very few farmers run water for fun. We are glad to get the job done as soon as possible and as fast as we can get the surface graded, we run less water, but we have to "support a family" in the meantime and so can not do all the grading in the first year or two.

This leads to the subject of underground drainage. These experts in the Service knew (or they

THE TECKTONIUS DRAW-BAND FASTENER

is the simplest, strongest, safest hand-clamping device made. No rivets to rust, shear off or pull out. Put on and adjusted, by ordinary workmen. Insures no leaking or bursting tanks or flumes. Made of malleable iron—every Fastener hammer-tested. Cannot wear out, break or pull off. Makes Irrigation Flumes—Water Tanks and Conduits—Strong and Durable as Steel. Send for free booklet, and learn all about this simple, scientific and effective hand-fastener. Also we are manufacturers of other water-works and irrigation-iron appliances.



E. C. TECKTONIUS MFG. CO.
1220 13th Street Racine, Wis.

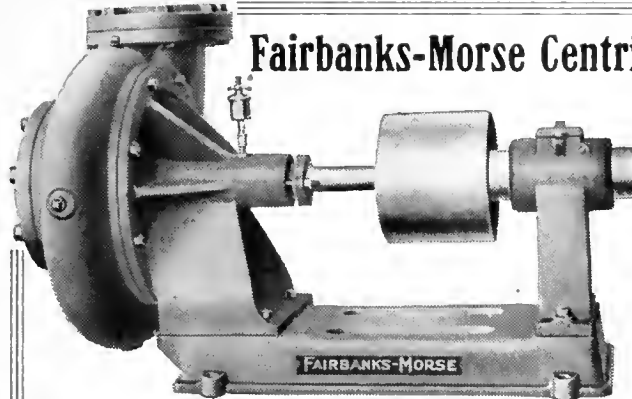

Fairbanks-Morse Centrifugal Pumps

Type illustrated—designed for pumping water against moderate heads. Other pumps, direct connected or belted to Fairbanks-Morse electric motor or oil engines for every irrigation requirement.

Write for Catalog 27N-650

Chicago	Portland
St. Paul	Seattle
Spokane	St. Louis
Salt Lake City	Omaha
Kansas City	Los Angeles
Denver	Atlanta

Fairbanks, Morse & Co.

LOW FARES
to Northwest
Farm Lands

Come to Northwest farm lands while fares are low. One way Spring Colonist fares daily, March 15 to April 15.

\$25 from St. Paul, Minneapolis, Duluth, Omaha and Kansas City to many western Montana points. \$30 from those cities to Idaho, Washington, Oregon and British Columbia.

One way Settlers' fares on certain dates—\$16 from St. Paul, Minneapolis and Duluth to eastern Montana points. Round trip Homeseekers' fares on certain dates. Proportionately low fares from your home town.



Prosper With the Northwest

You will find greater opportunities *with your limited means* on the fertile, untilled lands of the Northwest than on worn-out eastern farms. Get a Free Homestead in Oregon or Montana. In three years it's absolutely yours. Buy a logged-off, fertile farm in Idaho, Washington or Oregon at very low cost. Easy payments.

Send for Facts and Fares

Send today for "Make-Good" books, 36 pages, each handsomely illustrated. Filled with letters from men, like you, who have made good in the Northwest. Get our Free Colonist Fare Folder. Fill out the coupon below and mail to

E. C. LEEDY

General Immigration Agent Great Northern Railway
St. Paul, Minn.

E. C. LEEDY, I.A.
Gen'l Immigration Agent, Great Northern Railway, St. Paul, Minn.

Send me "Make-Good" book on _____ and free Colonist Folder. Name of State _____

Name.....

Address.....



were not qualified to be in the Service) that the Huntley project would be water logged in a short time, for the water table was only 12 to 30 feet below surface when the project was settled. The settler was not given this information before he applied for water. Had this been public knowledge, there would be a very different class of people here.

Now our lands will cost very much more than the service said they would—so much more that most of them will never be worth the money we shall be compelled to pay to the service.

When we come to the subject of building charges, we conclude that if Mr. Secretary has progressed only to the phase of doubt, he is not yet in such a mental state as would enable him to give us a fair deal. If he does not yet know to a certainty that we have been charged with great sums that are not just, he certainly needs to seek more information. He should come to the Water Users, not to the experts of the Service. They do not admit their blunders.

The proposition to extend payments to twenty years on the basis of a new contract is another open-

ing to take advantage of the farmer. He will have nothing to do with formulating the contract. It will be all arranged by the Service. And from our past experience, we want no more contracts made by the Reclamation Service. Under a new contract we would pay larger construction charges, more maintenance and get less water and less freedom.

We have an abundant supply of water, but the impractical service has not provided enough ditch capacity. The service claims it has, but the farmers think not.

Slaves are we? Not very different! Governments treat their subjugated half civilized dependencies with more consideration.

There would be a joyful exodus of a large number of settlers from the Huntley project, if the government would but repay them the money they brought here. They would be glad to surrender their claims with all the improvements and work done upon them. If anyone doubts these statements, let him come to Huntley project, and if he doesn't find it substantially as here written, his visit need not cost him a cent.

MEET FROST WITH HEAT

(Continued from page 182)

time in order not to burn fuel uselessly. Tested thermometers should be distributed throughout the orchard and also at a couple of places for comparison outside the orchard. If the temperature goes down slowly during the night and reaches 32° a short time before sunrise, it will not be necessary to light the heaters. If the temperature reaches 32° earlier in the night then every fourth heater should be lighted, and more if necessary to keep it at 32° or a little higher. The thermometers outside the orchard must be watched so as to know how cold it is away from the heated area.

"If the temperature drops rapidly toward the danger point in the evening or during the night then the fruit grower must be alert and get fires going before 32° is reached because it is easier to maintain a safe temperature than it is to raise an injurious one.

"There is much more danger on a clear night than on a cloudy one because the radiation of heat from the earth is more rapid. Clouds act as a blanket and check the radiation very considerably. Fruit growers, during the season when there is likelihood of frost damage, should maintain careful observation of weather conditions. They should also study the U. S. weather reports and whenever the forecast indicates likelihood of frost, make ready to light their heaters and thereafter keep especially close watch on local weather conditions."

HOW TO KILL PRAIRIE DOGS

The most successful way to exterminate prairie dogs is poisoning. Take shelled corn or wheat, soak it for twenty-four hours in strychnine water, cover with molasses, and by the aid of a long-handled spoon put it well down into the dog holes. In this way you will avoid poisoning other animals or the birds.

Clear Fir Silo at 40% to 60% Saving

Buy your silo of us, and you buy *direct*, not only from the *maker* but from the *lumber producer* as well.

We own forests, railroads and six big mills

There are thousands of acres of timber in our tracts. The fir is the finest in the land. Tall, straight and close of grain. Only the choicest goes into Seattle Silo Staves. They show no knots, sap or other defects. Do not warp, shrink or swell. The toughest, best wearing wood in existence. All the cutting, logging and manufacturing of this timber is handled by us. One continuous operation. One overhead expense. Hence the big saving that we effect in producing cost—and why we save you 40% to 60% on a silo of better quality. Mail the coupon for catalog.

Seattle Silos

have patented swinging doors

These are far the best silo doors ever devised.

Quick detachable with special iron cross-bar or hoop connection. The steel bars on the door provide a solid ladder from which hoops can be tightened—the result of a new invention. They close absolutely air-tight. Can not stick or bind—never have to be lifted. They swing in or out readily on their hinges.

Mail the coupon today

We are preparing to furnish you with seasoned red cedar for flume building purposes.

"Machine banded wood stave pipe for irrigation system."

Save 40% to 60% on Lumber and Millwork

Five middlemen come between the mill and you when you buy of your local lumber dealer. All get a fat profit; no wonder lumber is high. We put an end to this hold-up game. Sell you direct. Give you better materials at our mill price. Save you 40% to 60%.

We make shipments within 24 to 48 hours after receiving orders. Our shipments get to destination within an average of two weeks. Write today for price list. Better still, send your list of materials for our pre-paid prices. Money back unless satisfied.

Mail coupon today

HEWITT-LEA-FUNCK CO. 471 Crary Bldg., Seattle, Wash.

Kindly send the following, quoting prices delivered my station.
[] Catalog of lumber and millwork. [] Special silo folder.

Be sure to write plainly

Name _____

Address _____

Business _____

am planning to build as follows: _____

IRRIGATION LAW IN PLAIN ENGLISH

By **Fulton H. Sears**

THE IRRIGATION AGE:

What is the real meaning of this order by the Secretary of the Interior in connection with the Milk River irrigation project in Montana?



Fulton H. Sears

"In order to provide for the relief of these settlers who have made homestead entries for lands withdrawn under the provisions of Sec. 3 of the Reclamation Act of June 17, 1902 (32 Stat., 388), situated in what is known as the Chinook Division, Milk River project, Montana, west of Dodson dam, it is hereby ordered:

"For all such lands covered by existing uncompleted homestead entries the withdrawal under the Reclamation Act will be revoked as to lands held to be susceptible of irrigation to the end that patent may issue upon proper compliance with the general homestead laws; provided, that the reclamation withdrawal will not be revoked as to any

such land until the entryman has become a member of the Water Users' Association, and has executed stock subscription and contract with the association covering the land, which has been recorded; and provided further, that when water is made available for the irrigation of the land the area for which any one entryman or his successor in interest may hold a water right under the project prior to full payment will be limited to 80 acres of irrigable land."

This order means that those lands described, which no doubt have been filed upon in 160-acre tracts before farm unit was established, are now withdrawn from the operation of the Reclamation Act of June 17, 1902. This will permit the entryman to make proof under the terms of the Homestead Act, and thereby acquire title to the full 160 acres. The proviso is that the entryman must join the Water Users' Association and through this means, payments for construction, operation and maintenance may be collected.

"Provided further, that water right can only be acquired for 80 acres of irrigable land, for each entry."

This would allow entryman to acquire title to 80 acres upon which no water could be had until after final payment or through assignment to some other person.

How this can be done in law is a serious problem, as stockholders, in most Water Users' Associations are limited to Water Users located within the project. When this withdrawal is in effect, they are without the project, and may acquire

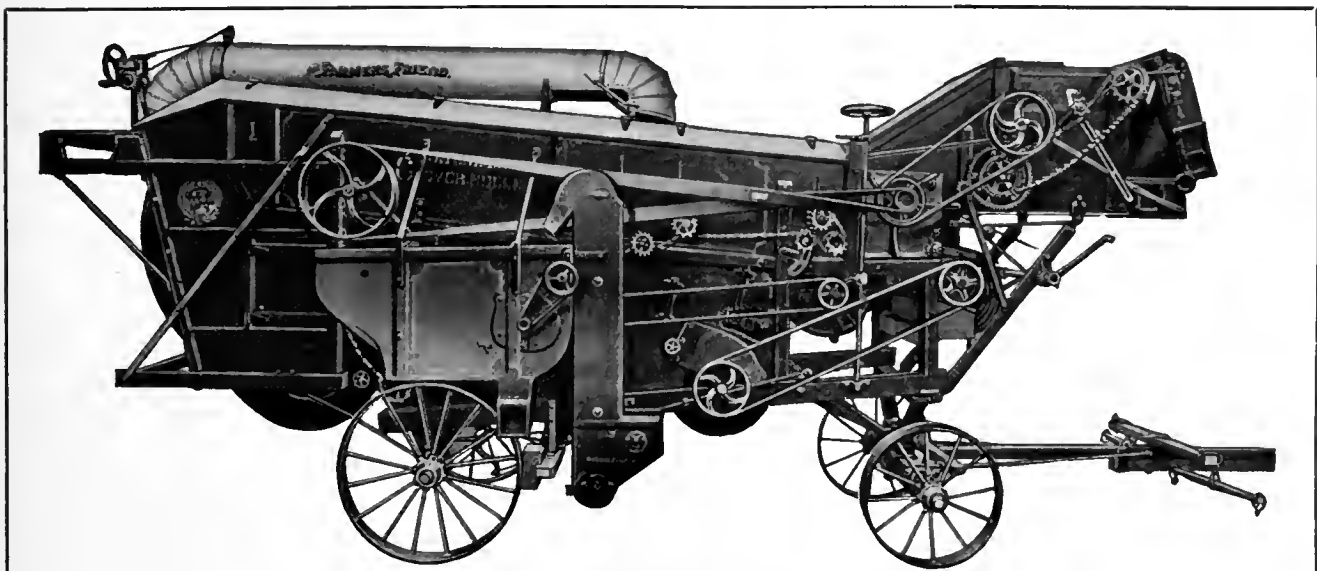

HULL YOUR SEED QUICKLY, PERFECTLY and ECONOMICALLY With a "MATCHLESS" CLOVER and ALFALFA HULLER

That's just what you will do if you use a "Matchless" Huller on the job. It's the one huller that will hull all the Clover or Alfalfa you can get to it without sacrificing the quality of the work. Here's the reason! We use square steel brads in our hulling cylinder. This construction has every advantage over rasps of spikes, because no set of spikes will knock the seed out of the damp pods. Rasps gum up and are easily destroyed. Our system of separation is unique and effective. This consists of a series of rotating troughs with perforation in the bottom, with provision for adjustment to meet the various conditions of clover. The Patented Steel Scrapers attached to the bottom of these troughs thoroughly scrape the separator bottom and insure a steady and positive delivery of the pods to the hulling cylinder, regardless of the condition of the clover. This construction enables you to hull seed under conditions in which no other huller can operate; enables you to hull earlier in the morning and later in the evening than with any other—this insures a longer day, thus increasing your earning power. Give us an opportunity to prove to you right on your own farm that the "Matchless" is the speediest and cleanest huller on the market. WRITE FOR CATALOG TODAY, or call at our nearest Branch House.

THE AULTMAN & TAYLOR MACHINERY COMPANY, MANSFIELD, OHIO.

Sole Builders of Aultman-Taylor "Starved Rooster" Line of Machinery.

BRANCHES: Minneapolis, Minn.; Portland, Ore.; Lincoln, Nebr.; Kansas City, Mo.; Wichita, Kan.; Decatur, Ill.; Indianapolis, Ind.

When writing to advertisers please mention The Irrigation Age.

vested rights while being in this position. Therefore, should it ever be desired to bring them in again or even to put them out, should they refuse, it would raise a serious question. Just what right the Secretary has to put a man out of the project without his consent is hard to see.

This order establishes a precedent that may be far-reaching, as under it the Secretary has the right to set aside the entire withdrawal of any project and the settlers would possibly have the mere right to get water and the Government would have the works.

KLAMATH FIGHTS MYSTERIOUS ORDER

By some indirect, mysterious route, J. G. Camp, project engineer on the Klamath project in Oregon, has received an order to include in his expense bills for the project the overhead charges of Pacific Division headquarters' office at Portland, Ore. The Water Users are aroused by this action.

When Camp was placed in charge of the project, following the removal of W. W. Patch, the Reclamation Service announced he would deal directly with Washington, and for a time no overhead charges for the Portland office were assessed against the Klamath Water Users.

"It appears, according to the word received here, that the order was issued without consideration by the whole Commission," says the *Merrill* (Ore.) *Record*. "Not only has Mr. Camp received orders of this nature, but it is claimed that individual Water Users have had matters sent to them

over Director Newell's signature only, that it is not believed were ordered by the Reclamation Commission. These matters will be taken up through proper channels and presented to the Reclamation Commission for its rejection or endorsement.

"While the settlers have the fullest confidence in Mr. Camp, it is the intention of those who will fight the Portland overhead charge to ask the Reclamation Commission to either give Mr. Camp full charge of the operation of this project or else replace him with a man whom the Commission feels is able to handle the project without assistance from Portland."

IDAHO OWNS KING HILL

The State of Idaho is now the owner of the King Hill irrigation project. The state land board bid in the property for \$30,000 in order to protect the state's equity. Under the court's order, there is no right of redemption of the property.

The land board's plans for the project this year contemplate the expenditure of from \$10,000 to \$15,000 in improving the project under the plans submitted by State Engineer F. P. King. This in addition to the cost of maintenance this season.

UPHOLDS CAREY ACT CONTRACT

Carey Act irrigation companies have the power to enforce the terms of their water contracts with settlers, even when the title to the land is still in the United States, and the United States cannot be made a party to the suit, according to a decision handed down in the Idaho state supreme court.

The Two Leading Magazines of Their Kind in the World

IRRIGATION AGE
CHICAGO, ILL.

The pioneer and only publication of its class in the world. Published monthly. Special articles each month by authorities on irrigation. Invaluable to the home-seeker, engineer, expert, colonist and irrigation farmer, and all those in any way interested in irrigation.

The publisher of *Irrigation Age* has recently purchased the *National Land and Irrigation Journal of Chicago* and the *Irrigator of North Yakima, Wash.*, and their combined circulation has been merged with that of the *Age*.

One Dollar Per Year

**Irrigation
Age**

30 N. Dearborn St.
CHICAGO

BETTER FRUIT
HOOD RIVER, ORE.

A beautifully illustrated monthly magazine, published in the interest of modern and progressive fruit growing and marketing. The editorials are strong features. *Better Fruit* is edited by a practical fruit grower, who has been in the business for many years. Consequently, *Better Fruit* contains just what the fruit grower wants to know.

One Dollar Per Year

**Better Fruit
Pub. Co.**

Hood River
OREGON

COMBINATION OFFER

IRRIGATION AGE
30 North Dearborn Street, CHICAGO

Enclosed herewith find \$1.50 for which please send me THE IRRIGATION AGE and "BETTER FRUIT" for one year.

Name.....
Street No.....City or Town.....
County.....State.....

FORESTRY NOTES

Connecticut has one and a half million acres of timberland, mainly in farmers' woodlots.

Canada has a society of forest engineers. Dr. B. E. Fernow, of Toronto, is president, and Mr. F. W. H. Jacombe, of Ottawa, is secretary.

Of the three Pacific coast states, Oregon and Washington far outstrip California in the work done by private owners for forest protection.

The development of quicksilver mines promises to make large demands for cordwood and construction timbers on the Tonto national forest, Arizona.

Manufacturers of greenhouses and makers of boxes are getting in touch so that the latter may use for box cleats the cypress waste from the greenhouses.

Only one wood, Spanish cedar, (*Cedrela odorata*), is commonly used for cigar boxes. Sometimes a cheaper wood may form the basis of the box, with paper-thin veneers of the tropical cedar over it.

It has been suggested that certain kinds of timber on the national forests be reserved for the needs of the navy. This recalls the fact that the first forest reservations in this country were made for naval material.

A California firm is selling eucalyptus charcoal at \$24 a ton, as against \$20 a ton for oak charcoal. Since most of the California-grown eucalyptus does not make good lumber, uses for other products of the tree are being sought.

Lodgepole pine seed sown broadcast on the snow in southern Idaho last spring germinated when the snow melted, and as many as 60 little trees were counted to the square foot. The summer was so dry, however, that most of the plants died, except where sheltered by brush or logs.

Fifteen small sawmills are cutting timber from the Powell national forest in southern Utah, more than 100 miles from the nearest railroad. They are run by settlers during time that can be spared from the crops, and supply local needs since there is no opportunity to ship timber in or out.

The department of agriculture is trying to eliminate the danger to cattle from poisonous plants on national forest ranges. Of these plants, larkspur, loco weed, death camas, and water hemlock are the most poisonous. Larkspur does the most harm, because it is so widely distributed and is particularly bad for cattle. Ordinarily, horses will not eat larkspur, and sheep can eat it without apparent injury.

Use KEROSENE Engine Free!

Amazing "DETROIT" Kerosene Engine shipped on 15 days' FREE Trial, proves kerosene cheapest, safest, most powerful fuel. If satisfied, pay lowest price ever given on reliable farm engine; if not, pay nothing. No waste, no evaporation, no explosion from coal oil.

Gasoline Going Up!

Gasoline is 9c to 15c higher than coal oil. Still going up. Two pints of coal oil do work of three pints gasoline.

Amazing "DETROIT"

—only engine running on coal oil successfully, uses alcohol, gasoline and benzine, too. Starts without cranking. Only three moving parts—no cams—no sprockets—no gears—no valves—the utmost simplicity, power and strength. Mounted on skids. All sizes, 2 to 20 h. p., in stock ready to ship. Engine tested before crating. Comes all ready to run. Pumps, saws, threshes, churns, separates milk, grinds feed, shells corn, runs home electric lighting plant. Prices (stripped), \$29.50 up. Sent any place on 15 days' Free Trial. Don't buy an engine till you investigate the money-saving, power-saving "DETROIT." Thousands in use. Costs only postal to find out. If you are first in your neighborhood to write, you get Special Extra-Low Introductory price. Write! (1928) Detroit Engine Works, 301 Bellevue Ave., Detroit, Mich.



SEND \$1.00 FOR THE IRRIGATION AGE ONE YEAR AND THE PRIMER OF IRRIGATION, PAPER BOUND.

FOR THE "LAND'S SAKE"

BUY A BOSTROM IMPROVED

FARM LEVEL



Price \$15

which has TELESCOPE enabling you to read the Target over 400 yards away, and

TERRACE, DITCH, TILE DRAIN, IRRIGATE

your land properly, and save surveyor's fees. It is sold by up-to-date hardware and general merchants everywhere, and guaranteed to be the most

SIMPLE, ACCURATE, DURABLE AND COMPLETE

outfit ever made for all farm work. If your dealer hasn't one in stock, he will order for you from a nearby hardware jobber.

Write today for description of Level, and details of our MONEY BACK GUARANTEE.

BOSTROM-BRADY MANUFACTURING CO.

119 Madison Ave., Atlanta, Ga.

International Harvester Oil and Gas Engines

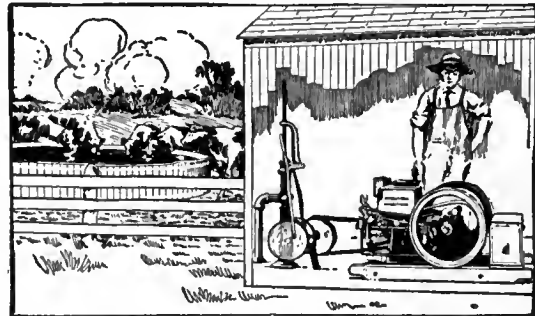

The IHC Line GRAIN AND HAY MACHINES

Binders, Reapers Headers, Mowers Rakes, Stackers Hay Loaders Hay Presses

CORN MACHINES

Planters, Pickers Binders, Cultivators Ensilage Cutters Shellers, Shredders

TILLAGE

Peg, Spring-Tooth, and Disk Harrows Cultivators

GENERAL LINE

Oil and Gas Engines Oil Tractors Manure Spreaders Cream Separators Farm Wagons Motor Trucks Threshers Grain Drills Feed Grinders Knife Grinders Binder Twine

EVERY wise farmer does what he can to save money, time, unnecessary hard work, and to have as pleasant a life as is possible.

Therefore, wise farmers buy International Harvester engines, engines of standard construction with features like the offset cylinder head, accurately ground piston and rings, extra large valves, detachable valve guides, split-hub fly-wheels—features that make them last by far the longest and save the most money in the end.

Be sure when you buy your engine that it is an I H C engine, and you will be sure of best material and best construction. They are made portable, stationary, or skidded; vertical or horizontal; air or water-cooled. Sizes range from 1 to 50-H. P. They operate on both low and high grade fuels.

Not every local dealer can show you International Harvester engines. Write us for interesting catalogues and full information, and we will tell you the name of the local dealer who handles our engines.

International Harvester Company of America (Incorporated)

Denver—Helena—Portland—Spokane—Salt Lake City—San Francisco
Champion Deering McCormick Milwaukee Osborne Plano



METAL CULVERTS



Department of Highways

State of Oklahoma

BULLETIN No. 2

(EXCERPT)

From the investigation made by this department and the evidence gathered from experience of other states, we are forced to the conclusion that purity is an essential factor in metal culverts; and under the standard of purity recommended by the government and by all state departments which have given the matter serious consideration, we find American Ingot Iron is the only metal used in the manufacture of culverts in Oklahoma and submitted for test which reaches the standard of purity suggested by the government and the various states, and specified by this department. Ingot Iron is undoubtedly much superior to steel for this purpose.

Write the nearest manufacturer for particulars and prices on American Ingot Iron Culverts, Flumes, Sheets, Plates, Roofing and Formed Products:

- | | | | |
|----------------------------------------------------------------|-------------------------------------------------------------|---------------------------------------------------------------|------------------------------------------------------------------|
| Arkansas—Little Rock
Dixie Culvert & Metal Co. | Iowa—Independence
Independence Cor. Culvert Co. | Montana—Missoula
Montana Culvert Co. | Oregon—Portland
Coast Culvert & Flume Co. |
| California—Los Angeles
California Cor. Culvert Co. | Kansas—Topeka
The Road Supply & Metal Co. | Nebraska—Lincoln
Lee Arnett Co. | Pennsylvania—Warren
Pennsylvania Metal Cul. Co. |
| California—West Berkeley
California Cor. Culvert Co. | Kentucky—Buechel
Kentucky Culvert Co. | Nebraska—Wahoo
Nebraska Culvert & Mfg. Co. | South Dakota—Sioux Falls
Sioux Falls Metal Culvert Co. |
| Colorado—Denver
R. Hardesty Mfg. Co. | Louisiana—New Orleans
Dixie Culvert & Metal Co. | Nevada—Reno
Nevada Metal Mfg. Co. | Tennessee—Nashville
Tennessee Metal Culvert Co. |
| Delaware—Clayton
Delaware Metal Culvert Co. | Maryland—Havre de Grace
J. N. Spencer. | New Hampshire—Nashua
North East Metal Culvert Co. | Texas—Dallas
Atlas Metal Works. |
| Florida—Jacksonville
Dixie Culvert & Metal Co. | Massachusetts—Palmer
New England Metal Cul. Co. | New Jersey—Flemington
Pennsylvania Metal Cul. Co. | Texas—El Paso
Western Metal Mfg. Co. |
| Georgia—Atlanta
Dixie Culvert & Metal Co. | Michigan—Bark River
Bark River Bridge & Cul. Co. | New York—Auburn
Pennsylvania Metal Cul. Co. | Texas—Houston
Lone Star Culvert Co. |
| Illinois—Bloomington
Illinois Corrugated Metal Co. | Michigan—Lansing
Michigan Bridge & Pipe Co. | North Carolina—Greensboro
Dixie Culvert & Metal Co. | Utah—Woods Cross
Utah Culvert Co. |
| Indiana—Crawfordsville
W. Q. O'Neall Co. | Minnesota—Minneapolis
Lyle Corrugated Culvert Co. | North Dakota—Wahpeton
Dixie Culvert & Metal Co. | Virginia—Roanoke
Virginia Metal & Culvert Co. |
| Indiana—Princeton
W. Q. O'Neall Co. | Minnesota—Lyle
Lyle Corrugated Culvert Co. | Ohio—Middletown
American Rolling Mill Co. | Washington—Spokane
Spokane Cor. Cul. & Tank Co. |
| Iowa—Des Moines
Iowa Pure Iron Culvert Co. | Missouri—Moberly
Corrugated Culvert Co. | Ohio—Cincinnati
Ohio Corrugated Culvert Co. | Wisconsin—Eau Claire
Bark River Bridge & Cul. Co. |
| | | Oklahoma—Shawnee
Dixie Culvert & Metal Co. | Wisconsin—Madison
Wisconsin Culvert Co. |

When writing to advertisers please mention The Irrigation Age.

Put the right engine behind your pumps

NO matter how large your irrigation system or how small, the efficiency and consistent performance of the engine that drives the pumps is a matter of the utmost importance. Abundant power, ready control, freedom from breakdowns and economy of fuel consumption are points that count big in results and satisfaction. Install a Gilson Engine and you can be sure of reliable service with minimum attention and minimum fuel cost. On irrigation work it has proved itself beyond question **the engine that more than makes good.**

Gilson "Goes Like Sixty" Engines

GAS AND GASOLINE

The strongest and simplest built engines in the field. Easy to operate, work without watching. No unnecessary pounding or wear. Last a lifetime. They do not need constant tinkering for they are designed on practical lines and have no weak spots. Built for hard service from tested materials. Nickel steel valves. Extra large high test babbitt bearings. Forged steel shafts of marvelous strength and finish. Exact workmanship throughout and perfect balance. Many special features and improvements that increase efficiency.



100% Service

60% Speed

GILSON ENGINES are built in sizes from 1 to 15 H. P., each size guaranteed to develop its full rated power. Patented devices give you the right speed for every job about the farm, ranch or irrigation plant. Built-in Sumter magnetos make it possible to start the engine without cranking and do away with batteries.

Mail the Coupon Whatever your requirements, whether for irrigation use or farming operations, there's a Gilson Engine that will give you the right service. Our prices will save you money at the start and the small fuel consumption of Gilson Engines will keep cost of operation down to a surprisingly low figure. Clip off the coupon and mail it back today and we will give you valuable information about the type of engine best suited to your particular needs.

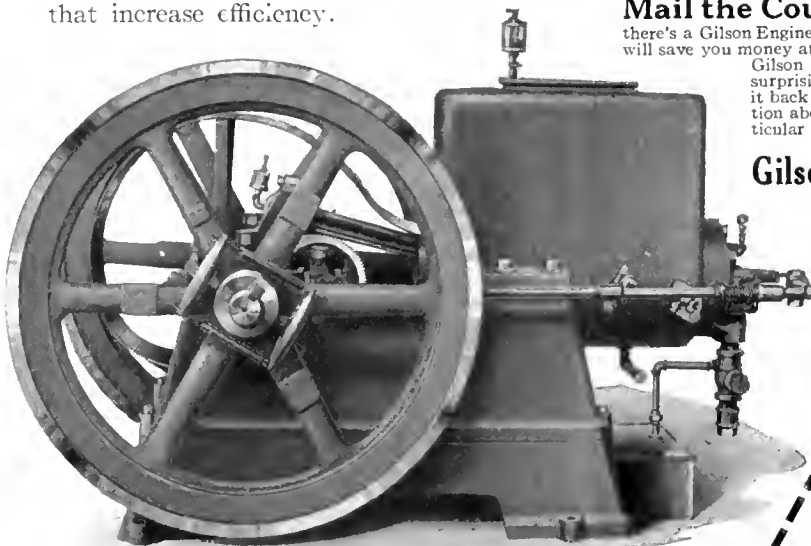

Gilson Manufacturing Company

76 Park Street Port Washington, Wis.

MAIL THIS COUPON

Gilson Manufacturing Company
76 Park St., Port Washington, Wis.

I am interested in a Gasoline Engine
of.....Horse Power

Portable or Stationary

Name

Post Office

State

R. F. D. No.

Send me your Free Catalog and full particulars.

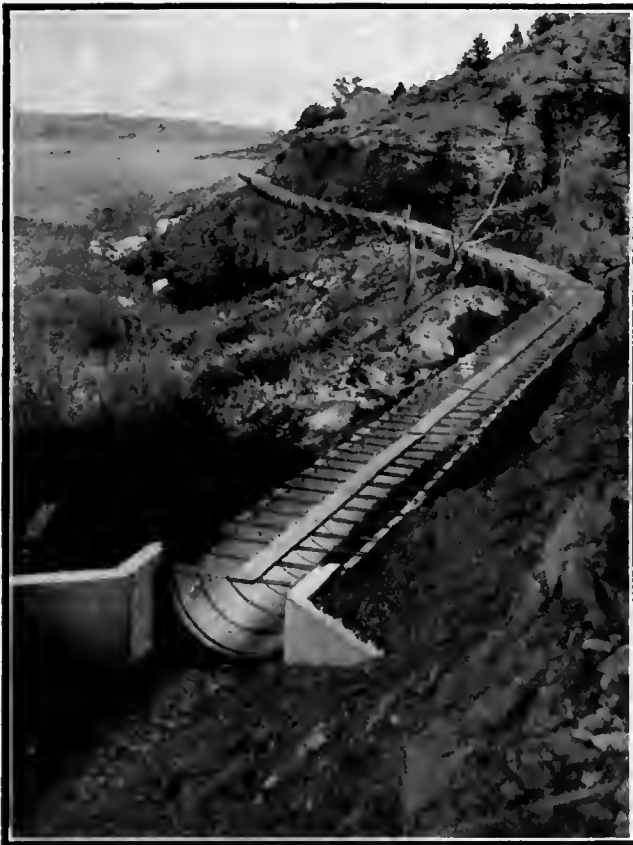

SECTION OF NEWCOMB FLUME ON UNITED STATES GOVERNMENT RECLAMATION PROJECT, NEAR HUNTLEY, MONT.

THE KLAUER GALVANIZED METAL FLUMES

ALL parts made entirely of
RUST RESISTING GALVANIZED IRON

NO WOOD
NO RIVETS
NO BOLTS
NO SOLDER

The most practical, simple and easiest
of all flumes to erect.

No Special Rolled Sheets
required for curves

Send us your inquiries

KLAUER MANUFACTURING
COMPANY
DUBUQUE, IOWA



International Harvester Motor Trucks

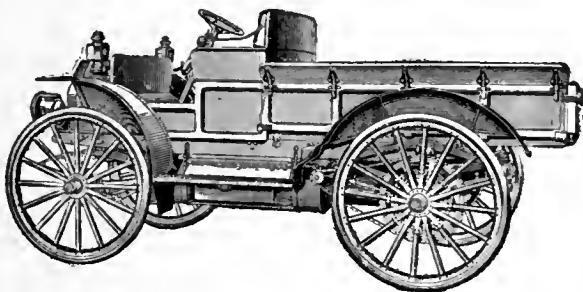

GRAIN AND HAY MACHINES

Binders, Reapers
Headers, Mowers
Rakes, Stackers
Hay Loaders
Hay Presses

TILLAGE

Peg, Spring-Tooth
and Disk Harrows
Cultivators

THE IHC LINE

CORN MACHINES

Planters, Pickers
Binders
Cultivators
Ensilage Cutters
Shellers, Shredders

GENERAL LINE

Oil and Gas
Engines
Oil Tractors
Manure Spreaders
Cream Separators
Farm Wagons
Motor Trucks
Threshers
Grain Drills
Feed Grinders
Knife Grinders
Binder Twine

"I HAVE used your International motor truck daily over a route eighty miles long, through winter and summer, for the last four years, and have never missed a trip," writes one man.

Service such as this man got would add much to the profits of your fruit business, by handling your fruits rapidly at the right moment, and cutting down your general hauling expenses. An International motor truck would give you such service. Many fruit growers, realizing the advantages and economies to be secured, have long been successfully using the light running, durable International motor truck.

The solid tires cut down tire troubles. The motor is simple and has plenty of power for emergencies. The brakes are safe on any hill. The ignition system is of the best. One lever controls the car. The International is built to save you money.

Let us show you all that an International motor truck will do for you. Drop a card today for catalogues and full information to the

International Harvester Company of America

(Incorporated)

Denver—Helena—Portland—Spokane—Salt Lake City—San Francisco
Champion Deering McCormick Milwaukee Osborne Plano



When writing to advertisers please mention The Irrigation Age.

“Ingeco” Oil Engines and Pumps

Your Protection Against Droughts

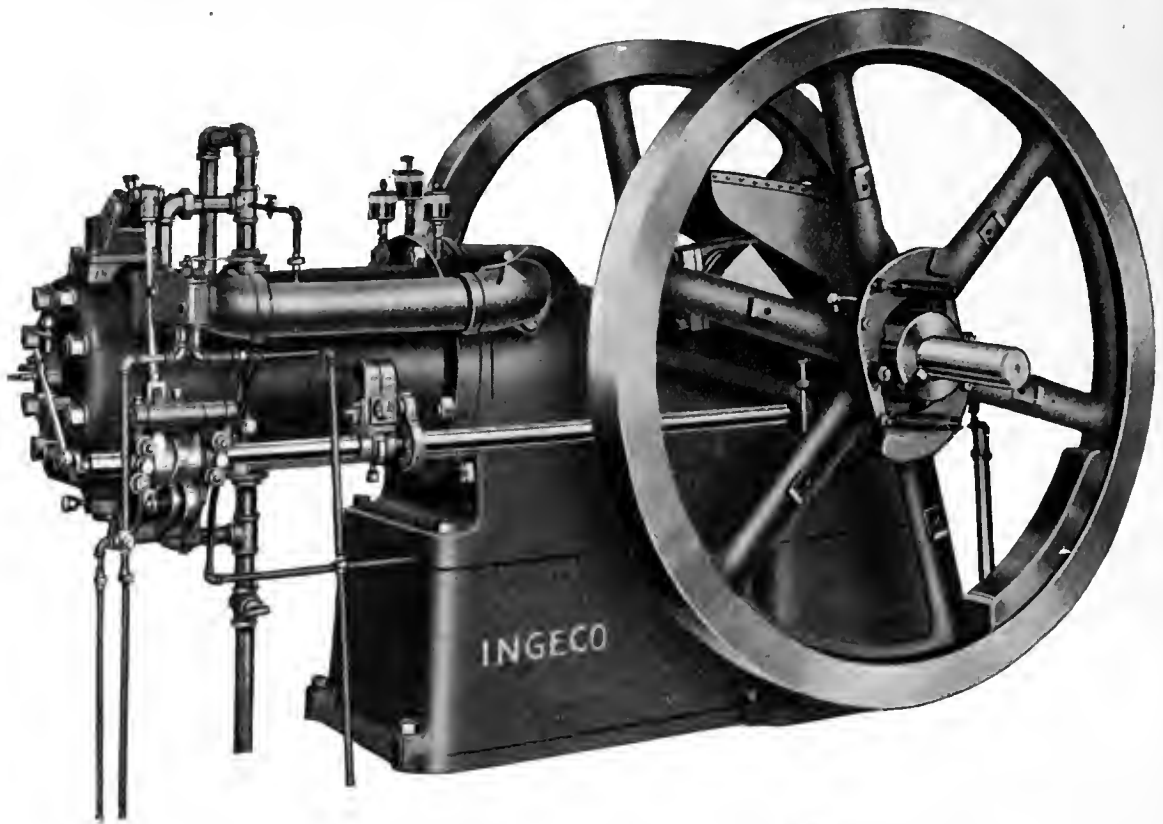

Right Now Is the Time to Order Your Irrigation Outfit

There is no longer any question about the big returns from this investment. The only question for you to decide is what equipment to buy. Let our engineers go into this matter with you in detail. The result of our years of experience in this work is at your command. Tell us how many acres you want to irrigate—the character of the soil—source of supply and total elevation that water must be lifted and we will quickly work out your problem and name you a proposition which we know will be interesting.

We are prepared to furnish complete plants, Engines and Pumps to meet all service, regardless of size or condition. Branch Sales Offices and stocks carried in all principal cities.

Write for catalog 29-B-89

International Gas Engine Co.

General Sales Office and Factory:
112 Holthoff Place

CUDAHY, WISCONSIN
Suburb of Milwaukee

G 105-8

IRRIGATION FROM WELLS



An Arkansas Installation. Layne Patent Screen and Patent Enclosed Line Shaft Centrifugal Pump.

With the twenty-three hundred successful working plants using our system of irrigation, which inoculates and energizes the dormant forces, there is now being produced in previously non-productive districts throughout the United States and in portions of Europe and Asia over eleven million dollars worth of FOOD PRODUCTS ANNUALLY. That our system is not an experiment is forcibly demonstrated by the fact that much of this production is from localities which were arid and barren previous to the introduction of our system.

Write for new catalog.

LAYNE & BOWLER COMPANY

Address nearest office.

The World's Largest Water Development Company

Houston, Texas

Memphis, Tennessee
Welsh, Louisiana

Stuttgart, Arkansas
Plainview, Texas

Jackson, Mississippi



International Harvester Tillage Implements

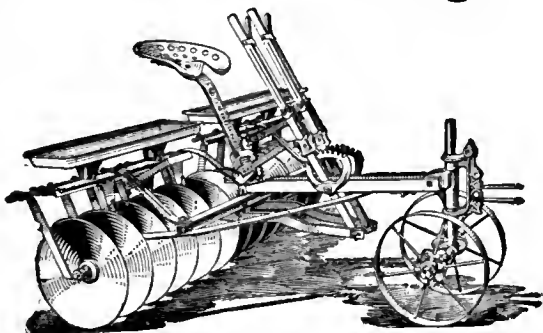

THIS year ten disk harrows will be sold where one was sold five years ago. Why? Because so many farmers have learned that the proper use of a disk harrow is the best guarantee of a successful crop.

Proper use of a disk harrow means the purchase of an I H C disk harrow, because they are the ones built to do the best work. The frames are strong, to stand the strain of following the binder or of slicing meadows. The set levers keep the gangs to their work at even depth. The bearings are the most durable that can be put on a disk harrow.

The full line includes disk, peg tooth, and smoothing harrows, drills and cultivators. See this line before you buy. We send catalogues on request.

"The Disk Harrow," a book which illustrates and explains the proper preparation of a seed bed, and gives examples of the value of disking—32 pages of valuable information—is yours for four cents to cover postage and packing.

GRAIN AND HAY MACHINES

- Binders, Reapers
- Headers, Mowers
- Rakes, Stackers
- Hay Loaders
- Hay Presses

TILLAGE

- Combination, Peg and Spring-Tooth, and Disk Harrows
- Cultivators

THE I H C LINE

CORN MACHINES

- Planters, Pickers
- Binders
- Cultivators
- Ensilage Cutters
- Shellers
- Shredders

GENERAL LINE

- Oil and Gas Engines
- Oil Tractors
- Manure Spreaders
- Cream Separators
- Farm Wagons
- Motor Trucks
- Threshers
- Grain Drills
- Feed Grinders
- Knife Grinders
- Binder Twine

International Harvester Company of America

(Incorporated)

Denver—Helena—Portland—Spokane—Salt Lake City—San Francisco

Champion Deering McCormick Milwaukee Osborne Plano



When writing to advertisers please mention The Irrigation Age.



WE SHALL be glad to mail anyone who wishes same, our free catalog. We sell our product through dealers and jobbers entirely and solicit inquiries from all dealers. Our goods are well and favorably known. They are standards in the United States Army and several other departments of the government.

Gold Medal Camp Furniture Mfg. Co.
 Racine, Wis., U. S. A.



No matter where you live or what your seeding conditions are, you can get a **SUPERIOR GRAIN DRILL** that will fill the bill and do your work in the best possible manner. Superior Drills are made in all sizes and every style. Every Superior Drill is sold under a warranty that absolutely protects the buyer. Send for catalogue. Read it and go to your local dealer and insist on seeing the Superior Drill.

AMERICAN SEEDING MACHINE CO., (Inc.)
 Springfield, Ohio

GRAIN DRILLS

PAYS FOR ITSELF IN ONE MONTH

and Keeps on Saving You Money at the Same Rate Thereafter.

THE RECLAMATION DITCHER

Cuts Canals and Laterals for less than any other machinery—because it plows the dirt out with *One Continuous Sweeping Motion*.

We guarantee the cost per yard and prove it before you buy.

The J. D. Adams Mfg. Co.
 Indianapolis, Ind.



Delays Pay No Dividends. Mail This Coupon Today.

The J. D. Adams Mfg. Co., Indianapolis, Ind.

Below are descriptions of our proposed ditches. What will it cost per cubic yard to make them with the Reclamation Ditcher?

Length	Width in Bottom	Average Depth	Maximum Depth	Minimum Depth	Slope of Sides	Character of Soil

Name _____ Address _____



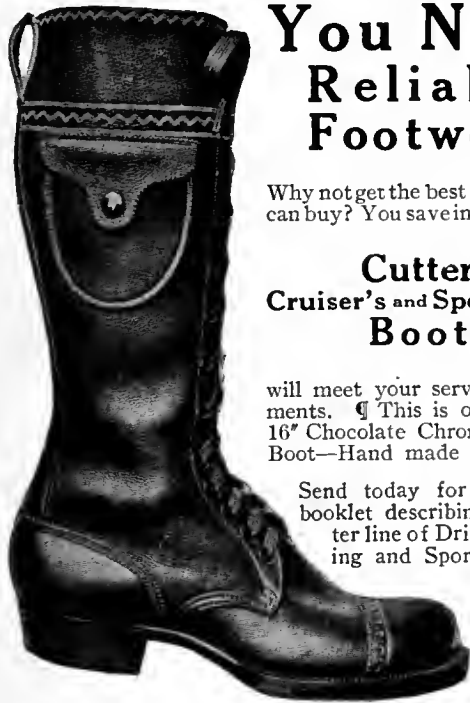

You Need Reliable Footwear

Why not get the best your money can buy? You save in the long run

Cutter's Cruiser's and Sportman's Boots

will meet your service requirements. ¶ This is our No. 106 16" Chocolate Chrome Sporting Boot—Hand made throughout.

Send today for illustrated booklet describing the Cutter line of Driving, Cruising and Sporting Boots.

*It
Will Pay
You*

A. A. Cutter Company

Eau Claire, Wisconsin

SAMSON TURBINE



When the PUMP cannot be direct connected to the turbine shaft, the power is usually transmitted by gears, shafting, etc. On account of the HIGH SPEED of the SAMSON, for a given power, lighter and consequently CHEAPER transmission machinery can be used.

JAMES LEFFEL & CO.

Springfield, Ohio, U. S. A.

316 Lagonda Street



THE LENNON METAL FLUME

being constructed with an ideally smooth interior, has the greatest carrying capacity of any on the market. ¶ Recent careful tests by the Colorado Experiment Station have established an average value of n for Kutter's Formula at .011. ¶ Made from

AMERICAN INGOT IRON

the purest and most durable to be had. It is Efficient, Economical and of

THE LONGEST SERVICE LIFE!

Write the nearest manufacturer for full information.

List of Manufacturers

California—Los Angeles and West Berkeley
California Corrugated Culvert Co.
Colorado—Colorado Springs
Lennon Metal Flume Company
Colorado—Manitou
Lennon Flume Co.

Nebraska—Wahoo
Nebraska Culvert & Mfg. Co.

Oregon—Portland
Coast Culvert & Flume Co.

Texas—El Paso
Western Metal Mfg. Co.

Houston
Lone Star Culvert Co.
Montana—Missoula
Montana Culvert Co.

Utah—Woods Cross
Utah Culvert Co.

Washington—Spokane
Spokane Corrugated Culvert & Tank Co.
South Dakota—Sioux Falls
Sioux Falls Metal Culvert Co.

When writing to advertisers please mention The Irrigation Age.

This Book Shows How to Plan a Private Irrigation Pumping Plant



It also shows all of the various types of pumps to meet the conditions found in different localities, tells how to select the proper pump for your conditions, how to determine the amount of power you

will need and all the other things the irrigator needs to know.

One will be sent free on request as long as they last. Write today

THE GOULDS MFG. CO.
LARGEST MFR. OF PUMPS FOR EVERY SERVICE

174 Fall Street, Seneca Falls, N. Y.
Branches in All Principal Cities

EDWARDS REVERSIBLE 4 HORSE ROAD GRADER

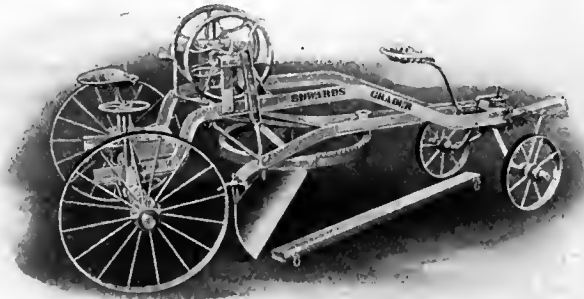

AN UP TO DATE MACHINE FOR BUILDING AND MAINTAINING ROADS

Having a complete line of adjustments it is equally well adapted for making ditches, both for dry land irrigation and rice field work.

I also manufacture THE RURAL ROAD GRADER and IRRIGATION DITCHER, STUMP PULLERS and other machines.

Write for descriptive catalog and prices.

C. D. EDWARDS, Albert Lea, Minn.

LOOK

For the Double Page advertisement of The Grimes Irrigation Pump Co., which will appear in the June issue of Irrigation Age

The Grimes Irrigation Pump Co.

First National Bank Building

DENVER

COLORADO

The Faithful Friend

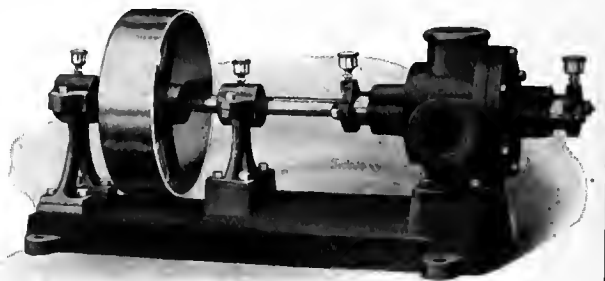

Do not be contented until you have the best, as these pumps have a good suction lift, with capacities of 12 to 500 gallons per minute, automatic take-up for wear, and free from springs or small parts that cause trouble.

SEND us your pumping proposition today, and let us quote you on the best pump made

Blackmer Rotary Pump Power & Mfg. Co.

PETOSKEY, MICHIGAN

THE IRRIGATION AGE

Vol. XXIX

CHICAGO, MAY, 1914.

No. 7

THE IRRIGATION AGE

With which is Merged

The National Land and Irrigation Journal

MODERN IRRIGATION

THE IRRIGATION ERA

ARID AMERICA

THE WATER USERS' BULLETIN

THE DRAINAGE JOURNAL

MID-WEST

THE FARM HERALD

THE IRRIGATOR

D. H. ANDERSON

PUBLISHER,

30 No. Dearborn Street,

Old No. 112 Dearborn St.

CHICAGO

Entered as second-class matter October 3, 1897, at the Postoffice at Chicago, Ill., under Act of March 3, 1879.

D. H. ANDERSON, Editor

ANNOUNCEMENT.

The "Primer of Hydraulics" is now ready; Price \$2.50. If ordered in connection with subscription \$2.00.

Stop the Sale of the Irrigation Congress

to Canada.

And they bought it cheap—\$10,000.

True friends of the West, who founded this Congress, the men who, through its twenty years or more of existence have fought year in and year out to keep it from control of sinister interests, must stand aside and see an alien country reap the benefits of all their building.

Calgary, Alberta, in the heart of a district which the Canadian railroad interests are attempting to settle up with American farmers, bought the Congress. Even its name was changed to suit the Britishers. They now call it the International Irrigation Congress.

And young Mr. Hooker, the secretary, is busy riding about the United States telling of the virtues of Canadian lands and other British inducements to settlers. Nice, isn't it, of a young American citizen, who was placed in a position of high honor by an organization of American citizens?

Of course young Mr. Hooker is pleased. Once

For a job and a jaunt and paltry gold.

There you have the disgraceful story of the sale of the National Irrigation Congress, body and soul,

SUBSCRIPTION PRICE
To United States Subscribers, Postage Paid, \$1.00
To Canada and Mexico, 1.50
All Other Foreign Countries, 1.50
In forwarding remittances please do not send checks on local banks. Send either postoffice or express money order or Chicago or New York draft.

Official organ Federation of Tree Growing Clubs of America. D. H. Anderson, Secretary.

The Executive Committee of the National Federation of Water Users' Associations has taken action whereby THE IRRIGATION AGE is created the official organ of this vast organization, representing 1,000,000 persons on the government irrigation projects.

Interesting to Advertisers

It may interest advertisers to know that The Irrigation Age is the only publication in the world having an actual paid in advance circulation among individual irrigators and large irrigation corporations. It is read regularly by all interested in this subject and has readers in all parts of the world. The Irrigation Age is 29 years old and is the pioneer publication of its class in the world.

more he is drawing a handsome salary and has stenographers and office assistants, and is called Mr. Secretary. And then he gets this nice little trip about the United States in order that he may boost Canada lands. Then there are certain members of the Board of Governors, who peremptorily, without consulting the executive committee of the Congress, and, unless we are misinformed, in violation of the constitution of the Congress, accepted the offer of the crafty Canadians. They, no doubt, can enjoy a short jaunt or two in the Canadian Rockies out of that \$10,000. Surely the wily Canadians will not be so stingy as to deny certain "governors" that pleasure.

The sale of the Irrigation Congress to these Canadians is an outrage. If there is any way by which the officers and executive committee of the Irrigation Congress can overrule this infamous deal of the Board of Governors and Secretary Hooker, they should do so at once. United States Senator Francis G. Newlands of Nevada, is president of the Congress. As a patriotic American and a Westerner, he should act quickly, calling together the executive committee to deal summarily with this Board of Governors who made this sordid, un-American deal. Give back to Canada any of its

tainted money which Hooker or interested members of the Board of Governors may have already spent. Better the Congress should die than that it should be sold into slavery of the land boomers across the border.

**The
Fall of
George H.
Maxwell**

George H. Maxwell was refused a twenty-dollar subscription to a fund to further the Newlands-Broussard bill in Kansas City the other day. This man, who has eaten well, dressed like a millionaire and lived without hard labor for the past fifteen years through his ability to collect funds, will meet with many other refusals of twenty-dollar contributions. He seems to be at the end of his rope. Think of it—twenty-dollar contributions today. Once he picked up \$5,000 at a crack.

Maxwell and his methods were thoroughly exposed at the Denver irrigation conference. Governor Carey of Wyoming and his fellow governors did it so dramatically that the press wires fairly burned in scattering the story over the country.

The lobbyist for the Newlands-Broussard bill fumed and foamed and stormed. It did no good. Thumbs are down in the West for all men of his brand.

**"We Pay-
rollers Must
Stand
Together"**

The Reclamation Service bureaucracy is beginning to totter. Several cogs in the wonderful political machine, which F. H. Newell and his aids built up and foisted upon the settlers, who are paying their salaries, have been jarred loose. The National Federation of Water Users' Associations has succeeded in tossing monkey wrenches into several portions of the well oiled machine. THE IRRIGATION AGE has added some telling blows.

The self-confident, impudent attitude of the machine, we are told, is beginning to get on the nerves of Secretary of the Interior Lane and there may be some further shake-ups, and something more than heads of minor officials may fall before he gets through. The Secretary finds this machine bulwarked behind Civil Service and bound together by an unholy loyalty, born of desire to stay on the payroll, no matter how big a bill may be piled up for the Water Users to pay.

This bureaucracy has been built on the principle: "Blame no individual. If blame must be laid, blame the whole system. Then when the blame is divided among the thousands who make up the bureaucracy no one will be very badly hurt."

This is a most excellent system for the construction of such a pay-roll machine as the Reclama-

tion Service. Whether Director Newell, who is without doubt one of the shrewdest politicians in Washington, was the creator of the main principle of the bureaucracy, we cannot say, but we do know that over his own signature, he has endorsed it.

He did so when the Water Users on the Belle Fourche, S. D., project complained because of a stupid piece of work which robbed them of an entire season's crops, and demanded the removal of R. F. Walters, supervising engineer. Gates had just been installed in the storage dam, when the Service decided that they should be replaced by a more up-to-date variety. The gates were torn out in the Autumn, and all the Winter and flood waters were lost. The following Spring, the new gates were put in.

Under date of August 22, 1911, Director Newell wrote the following letter concerning this serious situation:

Supervising Engineer,
Denver, Colorado.

Dear Sir:

Your letter of August 16 has been received regarding conditions on Belle Fourche Project. I am greatly pleased to know that the recent rains have helped matters. However, there will probably be more or less attack and discussion of the subject and it is very important that we have accurate facts concerning the condition of crop production, particularly as to the farmers on Indian Creek Flat and elsewhere, who have practically no crop.

In this connection also I should like to have some estimate as to how much water would have been available had we not attempted to install the gates, but had saved all of the 20,000 acre-feet, which I understand was turned out of the reservoir last fall, together with the total flow of the river during the winter, making deductions for losses by evaporation, etc.

In other words, I should like to know exactly how much worse the conditions were than they might have been had we held all of the water.

In this connection, I am taking the stand that if any mistake of judgment was made, it was not one of any individual, but of the entire organization, having to do with the determination of the proper course of procedure. Whether any mistake was made or not, the condition must be accepted by the Reclamation Service, but we should know as near as possible what were the conditions.

Very truly yours,

F. H. Newell, Director.

What would a private employer of high-priced, skilled men do with a man who took such an attitude as does Mr. Newell in this letter? How long would he stay on the payroll?

What redress did the Water Users obtain? Although their crops had failed during the preceding season, they were granted the deferment of only one year's building charges. They were forced to pay the operation and maintenance charges for both years.

But the bureaucracy must live. The pay-roll must not decrease. So blame the Service. It won't hurt the Service, as long as none of its big or little cogs are removed.

Such a condition as this is undemocratic. It is dangerous. The Secretary of the Interior should act immediately to break up this bureaucracy. He can do it best by removing its most important cogs.

Wield your axe, Mr. Secretary Lane. Let the keynote of the Reclamation Service be COMPE- TENCY, instead of its present motto:

"We payrollers must stand together."

**Here's a
Little Story
With a
Moral**

A member of the Reclamation Commission, whose word we believe is as good as gold, told us the other day that the original bills, which he had drawn for the relief of the settlers on the Federal irrigation projects met practically all the demands of the National Federation of Water Users' Associations, and in some respects were even "more radical." He added—and let us say right here, his name is neither Newell nor Davis—that Secretary Lane favored his proposals, but the Twenty-Year Extension bill as it is now before the House for passage was the best measure to which the Congressional leaders would agree. This bill grants the extension of payments on a graduated basis and provides for the designation of the Water Users' Associations as fiscal agencies. These are its only features, which are representative of the sentiment and recommendations of the National Federation. The House committee on irrigation eliminated the "court jurisdiction" section, added by the senate during the bill's passage in the upper house, and also restored the more drastic cultivation regulations in the "landlord" section of the measure. In this condition, the bill will, no doubt, go to the President for his signature.

The member of the Reclamation Commission hastily added that even though the Water Users had been most adequately represented in Washington during the formulation of the bill, Congress would have granted no more.

Here we disagree with him most vigorously. We have never been a lobbyist, but as a newspaperman, we know the fear that the average member of either House of Congress has of the public, if that public is at all organized. We firmly believe that if the Water Users had had their National Federation so thoroughly organized that it was in touch with every Water User; that every Water User was known to be paying his mite each month toward the expenses of the Federation, in order that its officers might be right on the ground looking after their

interests, the Extension bill would have read much different. It would have contained all the big features of the program of relief for the settlers, urged upon Secretary Lane by the National Federation a year ago, and for which the executive committeemen have fought as hard as they knew how with their meager resources, and largely at their own expense.

The present bill may do much to alleviate the burdens of the Water Users. We hope so. We believe Secretary Lane will stretch it to its limit to help the settlers, but under it, he cannot do all he would like to do.

The moral is—Organize. Every Water User should belong to the Water Users' association on his project. Every Water Users' association should be a member of the National Federation—not an honorary member as are some of the richer associations, but real live, active, due-paying members. The Federation cannot succeed without ammunition. This means probably less than a dollar a year from each Water User, but if this fund was available and in the hands of such men, as now make up the Executive Committee of the National Federation, Congress would be very glad—yes, delighted—to grant any requests a Secretary of the Interior might make for the relief of the settlers. And the Secretary, knowing that the organized Water Users stood behind him in his requests, would feel much more inclined to ask for needed reforms.

Organize. Concentrate your power. Make your Water Users' Association something more than an empty shell. Make the National Federation a real, live, powerful, dominant representative of the Water Users.

Get into action Mr. Federal Water User. Don't wait for your neighbor to do it. Don't wait for the leaders on your project to do it. Don't delay until a new crisis arises.

Do it yourself. Give a little time each day to putting life into your project association; to spreading the gospel of strong national organization. It's going to mean money as well as comforts for you in the end.

Remember you are on the eve of revaluation of your project. That's just one reason for need of real organization. You cannot afford to neglect this matter.

Organize.

The United States Senate has passed a bill authorizing the President to send a government engineer to China to aid the yellow men's republic in controlling its flood waters. Now, would not this be an ideal assignment for F. H. Newell?

**Scant
Courtesy
For Bond
Holders**

Although they had been invited to attend by Secretary of the Interior Lane, irrigation bond holders received scant courtesy at the Denver conference. The West is not to blame for this. The West bitterly resents by legislative acts and by individual action of its citizens any attempt to use the states and their rich resources for stock-watering, blue-sky promotions. The Western man, who has dug with his own pick in a prospect hole, has built laterals on an irrigated farm or has engaged in any of the other pursuits of the pioneer, knows the value of a dollar. While there are long chances involved in many of his enterprises, he seeks to interest no one in such investments, who can not afford to take these chances. Because of this spirit, the West has taken the lead in protecting widows and orphans and other innocent investors against nefarious financiers, who would take their money in return for beautifully gilded but valueless paper, bearing the word "stock" or "bond."

The West wants the irrigation bond holders to get back every dollar of honest investment, if there is any way to make this possible. The West cannot be expected to pay for all the water that was injected into many of these enterprises. It is the spirit of the West to strive constantly to keep its credit first class.

The blame for the treatment of the bond holders rests with certain persons with peculiar interests to serve, who deliberately set out to pack the convention.

**Make the
Water
Right
an Asset**

Judge Bell, of Montrose, Colo., a pioneer advocate of government irrigation of arid lands, advocated before the Denver conference the changing of the credit fiction, which makes the water right of the Federal Water User a liability, so as to make it an asset. The IRRIGATION AGE has long contended that these water franchises are of such value as to furnish ample security for the government claims against the settlers. If the water rights were so recognized, the Water User's land could be freed from the present cut-throat first mortgage, which the government now takes, and he would have a good security to offer, when he needed money to develop his farm. We are glad to see such men as Judge Bell join with us in the fight to bring about this needed change.

**"Prior
Leveling";
An Idea
Worth While**

In an article, which shows much careful study and thought, E. P. Osgood pleads in this issue of the IRRIGATION AGE for Congressional authority under which the Secretary of the Interior may direct "prior leveling" of all lands on government irrigation projects; the cost of such work to be added to the construction charges. This is a big idea which has been tried out in other countries and proven successful. It is an idea that should command the attention of Secretary Lane and the Reclamation officials. It is an idea, which also ought to be considered carefully in connection with future financing of private, state, or Federal and state co-operative projects.

From our own observations, there is no doubt that the settler tackles the biggest end of the reclaiming of the desert, when he begins to develop his farm. It is true also that many have had neither the strength nor the capital to win out against the obstacles encountered, and have quit the projects, bankrupt.

The United States government has undertaken this vast reclamation work and it is the duty of the government to do everything in its power to make it succeed and to help those settlers, who take up farms on the projects, become successful. On many of the projects, "prior leveling" will no doubt go a long way toward solving the serious problems, which now confront the settlers.

We do not agree with Mr. Osgood that further legislation is necessary to make "prior leveling" a reality. We believe that the Reclamation Act of 1902 gives the Secretary power to order such work done, if he believes it will be beneficial to a project. Secretaries of the Interior, including the present one, have authorized the use of funds for roads and other improvements, far less germane to the success of the projects. Therefore, Secretary Lane, we believe, can feel free to order the Reclamation engineers to place the desert lands in a condition that will make them advantageous to the Water User, entering upon them. Thousands of Water Users, already on the projects, no doubt would be glad also to avail themselves of the privilege of having their entire farm leveled.

Because of the condition of the land on the Truckee-Carson project, where Mr. Osgood is a homesteader and where he has put \$10,000 or more into developing his farm, "prior leveling," would prove of immense value and probably spell success for the project. The same is true of other projects, although we do not believe it is necessary on all those being constructed by the government.

THE WEST JOLTS DREAMERS AND BUREAUCRATS

THE Conference of Western States on irrigation problems, called by Secretary of the Interior Lane, demonstrated very forcibly during its three days' sessions at Denver last month:

FIRST—The West is through with blue sky dreamers and is seeking development only on clean, business-like, legitimate lines.

SECOND—The West is thoroughly tired of being used by Federal bureaucracies and their fund-soliciting henchmen to boost the pet ideas, legislation and propositions of these bands of payrollers.

THIRD—The West is quite willing to work out most of its own problems, if left alone by the blue-blooded, silk-stockinged, millionaire reformers from Pennsylvania and other states of the East.

FOURTH—The West will appreciate and wants government aid in working out its great Reclamation projects, but it wants this aid only on such terms as will be recognized in all quarters as good business terms.

FIFTH—The West resents the packing of its conventions of public-spirited men, seeking to help the nation, with large numbers of Federal supernumeraries.

The Conference also developed some ideas on financing crippled private and Carey Act projects and helping the settlers upon them, which may be rounded into beneficial legislation. Other movements were also set in motion, such as standardization of irrigation laws of the various states, and more liberal construction of the land laws and so-called conservation laws.

The governors of the Western states showed their displeasure at the manner in which the Conference had been packed by such astute Federal employes as F. H. Newell, director of the Reclamation Service; George H. Maxwell, widely known solicitor of funds for various propositions to aid the "poor, misguided West," and others of their ilk. So displeased were the governors that they practically withdrew from the Conference until the last day.

Then they discovered that the meeting, which had been named by many "The Governors' conference," had endorsed the Newlands-Broussard bill. The governors entered the meeting in white heat.



Governor J. M. Carey of Wyoming.

Governor Carey of Wyoming led off in the attack, and he did not mince words in his denunciation of Maxwell, of New Orleans, chief lecturer for the bill, who was there as a delegate from California. Maxwell's motives in working for an endorsement of the measure were questioned in no uncertain terms, and something of his past record was bared.

Boiling with rage, Maxwell replied, but with little or no effect. The endorsement of the bill, which Governor Carey characterized as a measure giving the West a little financial sop, while the treasury of the United States was thrown wide open to the South and the East, was quickly withdrawn.

Assistant Secretary of the Interior A. A. Jones, who presided at the Conference, offered a suggestion in regard to Carey Act project financing which was quickly grasped at as that of Secretary Lane and the administration. He said:

"We might do this: Provide a fund to start and finish a project; put the farmer on the land; give him water; look after his wants and earnings and then turn the whole thing over to a local association. With the project completed and with liens on your land you ought to be able to dispose of the bonds. But there should be nothing payable except interest for the first ten years, and the bonds should be long-term and guaranteed. There is \$100,000,000 in the Reclamation fund and Congress might be persuaded to use this to care for the defaults in interest payments. In that way the interest might be made as low as 3 or 4 per cent with the government practically standing behind the bonds."

PLAN MORE WINDMILL PLANTS

The Kansas Irrigation Commission expects to establish further windmill and pumping experimental plants in the western part of the state this spring. Irrigation plants have already been established at Dighton, Tribune, Syracuse and Leoti.

According to Bert Walker, of Osborne, Kans., the commission has spent less than \$20,000 of the \$125,000 appropriated by the 1913 legislature. The experimental plants are operated by windmills and water is supplied from wells sunk under direction of the commission.

SYSTEMATIC AID TO SETTLERS IS FIRST NEED

A Notable Address by Elwood Mead before the Governors' Conference at Denver

FOR the past seven years I have had the privilege of working for a government that has shown great wisdom and sagacity in its social and industrial legislation. Nowhere has this been more conspicuous than in its land and water laws and the policy followed in irrigation development. In this it has blazed trails which this country can follow to advantage. Recently I explained to Governor Johnson, of California, the methods by which Victoria, one of the Australian States, is securing settlers on its irrigated lands and aiding them to rapidly become self-supporting and prosperous. He was greatly interested and asked me to come to this convention as a delegate from California and explain what I had told him. Believing that a national policy of aid to settlers on irrigated lands will prove of immense value in the developing of this country and stop the drift of American farmers to other lands, I availed myself of the Governor's suggestion, and did this the more readily because of the opportunity of meeting many whom I had formerly known.

The absence of adequate financial help for settlers, during the first five years, is the main cause for the stagnation in irrigation development in this country, and for the calling of this conference. One only needs to put himself in the place of the settler to realize what a costly and serious venture it is to attempt to transform unimproved land into an irrigation farm and how much danger there is to the man of small capital that the attempt will prove a disaster. Before the settler can have any return from his land he must do many things not required in an unirrigated country. A house must be built, ditches dug, land cleared and graded, seed sown and the somewhat difficult art of irrigation mastered under untried conditions before he can have any return. While this is being done there is no income. His scanty capital is being swallowed up in living expenses. Often there is much hardship for himself and his family. Many a poor settler's wife has aged ten years in ten months. If money has to be bor-



ELWOOD MEAD

Former Chairman of the State Water Commission of Victoria, who will soon return to Australia to take up his former duties.

rowed, interest rates are excessive and all combine to discourage those to whom these conditions are strange and new.

To these have been added, in recent years, great increases in charges for land and water. Great dams and costly and permanent works mean much higher water charges than were paid by the earlier generation of irrigators, until in many cases the marvel is not that many fail, but that any endure. With water rights costing from \$40.00 to \$60.00 per acre, and with the present western interest rates, the chances are all against the success of the settler who has less than \$5,000 or \$6,000 capital, and the question which now needs to be decided is whether this nation is to restrict opportunities under national or private works to men with this or larger capital, or encourage poorer men by helping them to improve their farms.

Thus far in America we have almost entirely ignored the requirements of colonization and settlement. We have looked upon the building of irrigation works and the marketing of irrigation securities as the problems of irrigation development. We have not given enough thought to the obstacles which confront the farmer in completing the work of reclamation, and the risks and hardships imposed on himself and his family when they undertake the development of raw land, and the payment of high charges now imposed. Another mistake has been to regard irrigation enterprises as something which could be paid for quickly. We have taken it for granted that if they were once built the farmer would come forward and foot the bills. The actual facts are entirely different. Irrigation works do not create irrigated agriculture. The money spent on dams and canals must be followed by an equal or greater expenditure for houses, farm buildings, fences, grading and ditching fields before the water can be used and irrigation works have either revenue or productive value.

Owing to settlers not being able to obtain

financial aid many have not been able to complete the preparation of their land for irrigation in a reasonable time, and, as a result, have failed when through timely assistance they would have succeeded. These failures have deterred others from attempting settlement. Hence, a large part of the irrigable land is unoccupied.

Until this is changed the reclamation of irrigated land will continue to involve regrettable hardship and loss to many deserving settlers; development will be slow, and irrigation securities will have uncertain value; irrigation works will not fulfill their greatest purpose, which is to create opportunities for poor men, and American farmers will continue to emigrate to the ready made irrigated farms of Australia and Canada.

Adequate financial aid for settlers during the first five years is the greatest question before this Conference. It is also the one about which there is likely to be the greatest difference of opinion. No one, I think, doubts its need or value if wisely and honestly managed, but many do not regard it as feasible simply because it has not been attempted.

With respect to the latter, I have had during the past five years a most convincing and instructive experience. As Chairman of the State Water Commission of Victoria I have assisted in carrying out one of the most complete schemes of state aid to irrigated settlement ever attempted. Its success will, I hope, encourage this country to adopt a similar policy.

Seven years ago the situation under the irrigation schemes at Victoria was not unlike that under the Reclamation and Carey act projects today. The canals were built, the water was available, but the settlers were not there to use it and hence the works were unprofitable.

The State Government determined to change this by creating conditions which would enable anyone who had industry and thrift to secure an irrigated farm even if he had little or no money, and which would warrant its inviting settlement from distant countries.

It has succeeded in its purpose by requiring only small initial payments and giving adequate aid and direction. No charge is made for water rights and the annual payments are only intended to cover 4 per cent interest on the cost of works and the expenses of operation and maintenance. The cash payment on land is only 3 per cent of its cost and thirty-one and a half years is given in which to complete payments with interest at 4½ per cent. Houses are built for settlers on a cash payment of about one-fourth the cost, payments of the remainder may

MEAD'S COMMENT ON CONFERENCE

THE weakness of American irrigation development has been its exaltation of works and its neglect of the settler who uses and pays for them. Irrigation schemes have failed because the settler has been left to struggle unaided with a task beyond his means and strength.

The calling of the Denver conference by Secretary Lane, the sensible, patient appeal of Chairman Jones, for those present to cease chasing rainbows and deal with realities, and the interest of all the state governors in measures to aid settlers and lessen the losses and hardships which unaided development entail, marks, I believe, the turning point in the irrigation policies of this country, and that hereafter when money is provided to build dams, money will also be made available to help grade and plant fields and build homes.

When this is done it will mean such lessening in the time of development and increase in returns from cultivation as will solve the question of the value and stability of irrigation securities and end the hardships and losses which are now a reproach on this development.—ELWOOD MEAD.

extend over twenty years with 5 per cent interest. The State, when desired, grades and seeds a portion, up to one-fourth, of each farm, on the payment of one-fifth the estimated cost, and allows the payments of the remainder to extend over ten years. It employs disinterested expert advisors to help the settler select his farm, buy his horses and cows and do what is needed to get established on his farm.

The saving in money and time which this system effects can only be appreciated by those who have seen it in operation. Many settlers select their farm and arrange the erection of

their house before leaving Europe; are able to go directly from the ship to their new home and have a living income from a dairy herd within a month from their arrival.

The State follows up this initial assistance by loaning the settler 60 per cent of the value of any improvements he makes. This enables men with small capital to complete without delay the grading and seeding and improvement of their farms. It does not halt when the settler exhausts his own capital. When he has one field graded he can borrow money on that to grade another.

This generous aid and the thoughtful consideration of his welfare is a great encouragement and incentive to the ambitious and earnest beginners. I have never seen elsewhere men work as hard or achieve as much in the first two years as in those Victorian settlements. But all who come are not industrious or capable. Such a scheme is especially attractive to the visionary and incompetent. Some of the settlers seem to regard the house, the farm and the graded fields, as an endowment, and to believe that the State which has done so much to help them succeed will do the remainder.

To help the inexperienced and guard against being imposed upon by the idle or indifferent, the State employs in each district a tactful, practical farmer who is the friend, counselor and advisor of the working settler and a stimulator of others. When his efforts and influence fail the fact is reported to the head office.

The settler knows of this and also knows that such reports will have a controlling influence in determining whether or not he is to obtain loans or be given sympathetic treatment when payments are delayed. The law is so framed that the commission administering it has discretion to defer payments where settlers are unfortunate, but it also has authority to eliminate promptly any settler who fails to show earnestness, industry and thrift.

This scheme of comprehensive aid has now been in operation six years. The settlements that

are three years old are practically established and self supporting. It is the unanimous opinion of all those familiar with development that nowhere else have they seen such rapid progress in the cultivation of land or such large returns in the earlier years of settlement. One of the inspectors was formerly a successful farmer in the Imperial Valley, California. It is his belief that as much progress is made in these settlements in eighteen months as was made on an average in the Imperial Valley in five years.

One cannot help being inspired by the hope, the gratitude and the tremendous industry that is everywhere manifest. The government that inaugurated such measures understood what democracy should mean. While Australia and New Zealand have led in the movement to aid settlers, their example is now being followed in other developing countries. South Africa has adopted it, and the newspapers report that British Columbia intends to adopt it. The Canadian Pacific Railway is loaning each settler on its irrigated tracts up to \$2,000 in aid

of these initial improvements. Even the Argentine is beginning to consider making such aid a feature of its colonization policy.

The question for consideration by the United States is, first, whether it is right to subject the settler to the hardships he has now to endure, even if he were able to survive; and, what is more important, whether it can continue development unless it offers equal opportunities with other countries. The conditions for giving all the aid to settlers which Australia now furnishes are far more favorable in America than they are in Australia. The tenant farmers of the middle west furnish a large body of the very best class of settlers. The country does not have to look for them on the other side of the world. The lands are here, the works have been built. All that is needed is the inauguration of some business-like scheme which will provide the needed funds, and exercise the necessary direction and oversight over the settlers.

The greatest need in this country is the complete use of the works already built. Everywhere from Colorado to California are private and public works,

(Continued on Page 216.)

DAVIS MUST EXPLAIN COLORADO ATTACK

ARTHUR P. DAVIS, chief engineer of the Reclamation Service, faces an inquiry concerning his authorship of an article, which it is claimed was without basis of fact and which has done irreparable damage to the Greeley-Poudre irrigation project in Colorado. Charges in writing against Davis will be submitted to Secretary of the Interior Lane, following a hearing at Denver before W. A. Ryan, comptroller of the Reclamation Service. It was at Mr. Ryan's suggestion that the charges are being put in writing.

Dolph E. Carpenter, former state senator, author of the Carpenter irrigation bill, and at present representing Colorado with Attorney-General Farrar in the Colorado-Wyoming water dispute, hurled the charges.

Tolerance of such attacks as Davis had made, Carpenter said, threatens the progress of any state upon which they happen to fall.

"Mr. Ryan," said Attorney Carpenter, "I intend to demand of Mr. Davis a retraction for one of the most unfortunate falsehoods ever published by a public official concerning Colorado.

"It is not only a falsehood to which I refer, it is one which can be regarded as libelous, and Mr. Davis might be prosecuted on that score as a private citizen.

"Under his own signature, and I can say without fear of being contradicted, without taking even a reasonable precaution to ascertain the truth, Mr. Davis had published in *Engineering News* an article which has not only cast an odious reflection on some of Colorado's best-known citizens, but has placed the biggest individual irrigation project in the state in the process of utter deterioration and stagnation. Five million dollars' worth of bonds hang in the balance, and the Greeley-Poudre irrigation project, of which I speak, faces a crisis which absolutely threatens its completion.

"It is hard to understand how an official of the national government will go so far as to criticize an enterprise that means everything to a growing state

upon false statements, and declare, as in his article concerning the Greeley-Poudre project, that \$2,000,000 of its bonds were held by its directors as appropriated profits when there was absolutely no foundation for the statement.

"Irreparable injury has resulted. Innocent farmers who have relied upon the project for a promising future, with scores of holders of our securities, have become suspicious. It has destroyed the standing of the bonds of the project.

"We have utmost confidence in Mr. Lane at Washington, but I cannot see how we can derive any benefit from his constructive policy if such attacks, founded on irresponsible, flimsy information, are tolerated. It is destructive to a growing state."

"I am not acquainted with all facts," said Comptroller Ryan in reply. "To me there must be something wrong in your charges.

"Such an act of a government official would be reprehensible; it demands rectification and I would suggest that you place the matter in writing. As for Mr. Davis, I don't understand how he could have written anything except facts. He would have no reason to do so, and it is not like him."

"We, too," replied Carpenter, "have pondered over the cause or reasons and we have come to the conclusion that Mr. Davis, in his efforts to discredit the statements of State Engineer Field that private enterprises have done more for Colorado than the government, takes a roundabout route to flay us with unfounded statements."

LOST RIVER PROJECT SOLD

The Big Lost River irrigation project in Idaho, in which \$2,000,000 is said to have been invested, was sold April 8 at a receiver's sale to the Utah Construction Company, for \$35,000. It is understood the company will complete the project and protect the interests of the Corey Brothers' Construction Company, of Ogden, which holds liens aggregating \$650,000.

The Federal Water Users



A Department Devoted to the
Interests of the Farmers on the
Government Irrigation Projects

EDITED BY GEORGE J. SCHARSCHUG

PICK STRONG MEN TO GUARD YOUR PURSES

PRELIMINARY arrangements for the revaluation of the Federal Irrigation projects and the fixing of their final costs to the settlers are now being made. This important work is expected to start soon after the passage by congress of the Twenty-Year extension bill, which now may come any day. In an order to supervising engineers, project managers and other officials of the Reclamation Service, Director Newell says:

"It is expected that action will soon be taken by congress in the matter of proposed legislation extending the period of payment of charges under the Reclamation law, and a large amount of work will be involved in the revision of the public notices.

"This is called to your attention in order that the Project Managers may take up at once the preliminary steps for a revision of estimates of project costs by a board of three on which there shall be a Water Users' Association representative, to afford a basis for revision of the charges for building, operation and maintenance, to be incorporated in the new public notices to be issued after the enactment of the pending legislation."

Secretary Lane has decided to carry out his original plan of composition of the revaluation boards. One member will be selected by the local Water Users' Association, an engineer will represent the Reclamation Service and a third member will be named as personal representative of the Secretary of the Interior.

The Water Users, therefore, will have but one representative on each board and no voice in the selection of the other two members.

As the revaluations touch the pocketbook of every Water User, it behooves the various associations to use the greatest care in selecting their representatives on the revaluation boards. The selection of these men should have the careful study and thought of every Water User. The brainiest, most capable, most public spirited man on the project should be picked. The man selected should be a man of iron courage and one who has the interests of the Water Users thoroughly at heart. He should be a true representative of the actual Water Users, the men and women who are making and developing the projects.

There will be big questions before each of these boards. They will be called upon to delve into the innermost bookkeeping secrets of the Reclamation Service. They must consider all charges

against each project and decide which of those charges are proper for the Water Users to pay, which must be credited to the general fund and which must be accepted as dead loss to the Federal treasury. They must arrive at a total and final building charge for each project. They must investigate operation and maintenance charges. They must decide what is proper to be spent on the projects for additional constructions, extensions, betterments and drainage.

These boards should have the full and complete co-operation of every Water User in arriving at their conclusions. Water Users should make it their business to see that the boards are not hampered in any manner in obtaining the full truth concerning conditions surrounding the construction of the projects and the conditions, with which the settlers now have to cope. Make the investigations thorough and complete. If there is dirty linen to be washed, gross mistakes to be bared, incompetency to be uncovered, the Water Users should wade right in and see to it that these unpleasant tasks are done and done thoroughly.

Water Users have seen their neighbors persecuted by obsequious bureaucrats of the Reclamation Service, who denied settlers water and otherwise hampered their farming, because they had dared tell the truth or demand rights, such as American citizens are entitled to enjoy. These persecutions offer no excuse for any Water User to shirk his duties before the revaluation board. The persecutions of the Reclamation Service will be less this year than last year, and they will continue to grow fewer. The bureaucrats realize the extent to which the settlers have been aroused, and they are so badly scared that they will be too busy trying to hold their jobs for the next year or two to renew their methods of persecution.

True, the court looks packed to begin with, and each board will be hampered by the presence in its membership of a Reclamation Service engineer. The training of these engineers under the chief bureaucrat of them all, Newell, whose motto has been, "Protect the Service," will assert itself constantly. A high class representative of the Water Users, who will strive constantly to bear the whole truth and get at the real facts, can, no doubt, more than offset the influence of the representative of the Service. If the Water Users present their statements of facts fully and back up each statement

with all the corroborating evidence possible; if each association presents itself as a united body, the third and deciding member of each board—the representative of Secretary Lane—must prove a very narrow-minded person if he denies the Water Users full justice.

Besides, the writer believes, Secretary Lane will give much care in his selection of his representatives on these boards. If he picks high class, honest men, the Water Users may not have as much cause for complaint as was generally expected, when the Secretary first announced his plan.

The Secretary, it is understood, has practically decided to charge off all overhead expenses against the projects, such as those of the Washington office—a total of more than \$3,000,000. This will be assessed to the general fund instead of the projects.

The opportunity of the Water Users to obtain a complete settlement and, at least, a partially satisfactory settlement of the financial problems of their projects is at hand. It is the duty of every Water User to make the most of this opportunity and to work for full justice for himself and his fellow Water Users.

BUSINESS MEN MUST AID IRRIGATORS

By FRANCIS G. TRACY

(Carlsbad, N. M.)

EDITOR IRRIGATION AGE: I wish emphatically and heartily to congratulate you upon the April issue of the IRRIGATION AGE, and especially upon the two articles entitled "Real Development Follows Burst Boom" and "Put Your Association to Work." In these articles I believe you have struck right at the foundation which must be laid for future progress.

The conclusion I reached from careful attention to the proceedings of the Denver conference is that our own people have not yet begun to look close enough at home for the causes and effects of the bursting of the irrigation boom.



Francis G. Tracy

It is true that many blunders have been made both by eastern investors, private engineers, the Reclamation Service and by the irrigation and land investment promoters. It is also true that a certain proportion of these mistakes have been the

direct result of individual unscrupulousness.

But the irrigation problem is a stupendous one and at the time of the passage, both of the Carey act and the Reclamation act, was an entirely new one in all of its larger phases.

Small wonder that big blunders have been made in which the settlers have had their share. Let us admit that we have all blundered together and together take credit each for the other that the great majority of the blunders have been honest mistakes and have arisen from lack of experience and for want of precedent.

Experience has come now and there is no longer excuse for a repetition of past mistakes. We will make plenty of new ones. The problem before us now is to analyze as calmly as may be our present

conditions, and perfect as far as possible the foundation already laid before we proceed to build further. This cannot be effectively done in a spirit of suspicion or mutual recrimination.

Therefore I congratulate you heartily upon the broad view taken in the particular articles mentioned, but I congratulate you also and chiefly because these articles go further and point out to us duties close at home.

Are we ourselves in no way to blame for misfortunes about which we complain most bitterly?

It appeared to me, as I listened in Denver, to appeal after appeal for help for the settlers from both National and State government, and heard eloquent statements of the duty of cooperation between states and nation and between nation and settler and the insistent call for more credit and cheaper money, that any stranger sitting in that convention, or reading the press reports, would conclude that the irrigationists of the west were not only impoverished, but were a lot of helpless beggars waiting for a handout from whatever source, and utterly hopeless without it.

We all know that this is not the case and that the great majority of our farmers are greatly successful and those who are not ask nothing to which they are not entitled and that they would be the first to resent the actions of any mistaken friends which would justly give any other impression.

But are not we, especially the business men and the townspeople of the western communities, largely if not chiefly to blame for the "bursting of the irrigation boom?"

Have we ever sufficiently appreciated our own responsibilities for the guidance and control of the boom itself and for the proper reception and subsequent care of the new settlers brought among us with so many false impressions and impossible expectations?

Have we not entirely failed ourselves to see that back of all the other problems, engineering, financial, agricultural, has lain all the time the fundamental problem of all, without whose successful solution, failure is inevitable—the problem of marketing the products of the soil?

(Continued on Page 218.)

CALLS 'PRIOR LEVELING' KEY TO SUCCESS

By E. P. Osgood
Agricultural Engineer

Truckee-Carson Project, Fallon, Nev.

THERE is just one great, outstanding fault in Federal Reclamation of the arid lands today.

It is the under-financing of the settlers, who are trying to develop farms and homes on the vast projects which the government has built in the west.

Irrigation farming is a business that under ordinary conditions will return twenty-five per cent on the investment.

The main works of the Federal projects—the dams, the controlling works, the canals—have been well and capably constructed.

Soil and climate of these projects, when combined with the life-giving irrigating water, present most ideal conditions for farming.

The government has builded well so far as it has gone, but it has not gone far enough.

It has permitted settlers to come with their families on to wholly untamed and uncleared land, expecting to make a living almost from the day of their arrival.

It has invited and permitted men to tackle a job with \$1,000 capital, which cannot be financed nor handled with much less than \$5,000.

As a result, a grave situation confronts reclamation progress. No general improvement for years to come can be anticipated so long as the settler must come in underfinanced. Under such a condition, the aim of the Reclamation Act is being defeated.

What is the remedy?

PRIOR LEVELING of the land!

We have heard too much about aid for the Water Users and it is time we realized that some other aid is needed and that it is aid of the projects themselves. The Water User has done far more than his share in the battle with the desert and has gone to extremes of starving himself, his children and his stock and has sold off his equipment and stock in the effort to meet payments and still stay by the game. He has worked long hours and been a drudge animal in refusing to give up and he has found a one-sided contract. The offering made by the project is not feasible, so let it get aid for itself that it may come to the settler with a business proposition; let it present its lands leveled and then it can come to the settler offering opportunity instead of disasters.

To reclaim the land on the Federal projects, it is costing about \$60 per acre to construct necessary reservoirs, canals and drain ditches. It is costing \$60 and more to further reclaim by leveling, ditching and creation of farms, or a total of \$100 to \$125 per acre to convert waste to wealth.

An 80-acre unit is, on any but old, well established, intensified projects with certain markets established for its crops, necessary to support a family meeting water payments and trying to bring up children to become rugged valuable citizens of our country. This 80-acre unit will represent when developed from \$8,000 to \$10,000 of actual cost investment. In other words \$10,000 is going to be used to develop such a farm and the settler comes in, if very lucky,

mind you, with about \$1,000. He does not need \$10,000 or \$6,000 to start on but I say he positively does need \$3,000 to make even the slightest attempt, if he is to really help himself, or the project. Sixty dollars cash in your pocket to build reservoir and canal as against \$12.50 cash per acre to tackle a \$125 per acre job that calls for practically \$60 cash on the spot as the "ante" to get into the game is the comparison between the engineers' and the settlers' jobs.

Are we going to allow green, inexperienced of the world, agriculturally uneducated land seekers and home builders to continue to swarm over million dollar projects and attempt to conquer their \$125 per acre task with only \$12.50 per acre in their pockets?

I say it is time we came to the aid of our Federal Reclamation Projects and finished them to the point that is necessary to give them an opportunity to show their worth to the settler, and saved them from the utterly unmerited opprobrium that they are now falling into because of being offered in their present condition as opportunities for frugal, honest, hard-working home seekers. No fairer opportunity lies before us than can be found in these projects, for science and nature are one there, but let us be sure opportunity is there. "Twenty-five per cent net profit opportunity," and even better lies hidden away in them but woe betide him who seeks to pick the lock to it with copper pennies.

The criticism will come up that theory or no, the settler has been "proving up," even though starting with little capital. He has done anything to prove up, hoping to get some money that will let him do "something." Go look the project over and see the hopeless leveling that has too often been the basis of "proving up" and then don't wonder at inadequate returns; such leveling is all over our projects and land so leveled has a special name—"hogged in," they call it.

Prof. Fortier, Chief of the Experiment Stations, has commented again and again on the fact that returns from irrigated land are little better than from rain land; that the average alfalfa yield for southern Idaho is but 3.25 tons per acre per year where the experiment stations have shown yields of 6 to 10 tons. Now go back and look at land "hogged in" by your \$12.50 per acre capitalists and don't wonder any more why returns are so small. Pour \$100 of real gold investment into the ground, do the job right and you will then see that the arid lands, irrigated, are the store houses of untold wealth.

Let Congress amend the Reclamation Act, so as to authorize the Secretary of the Interior to have lands on the projects leveled, and also seeded if necessary, prior to acceptance of water applications, or to have the same done on such lands as have already applied for water, if requested by the Water User. Let the entire cost of such work become a part of the construction charges and be repaid in the same manner. Do this and you will give the projects a chance, and incidentally, the settler.

Now let us see what would happen, with such an amendment in force. Let us compare the possibilities

(Continued on Page 217.)



Hawaiian Cultivating Taro.



Hanohii River at Kaiwika near Hilo, Hawaii.



Cane Flume and Trestle Across Kawainui River near Pepeekeo, Hawaii.

CO-OPERATIVE THE SHADOW —A STORY OF

RISING up out of the placid waters of the western coast of the United States, the greensward peep the pudgy noses of the mouthing mortars, ready to hurl death and destruction. The ground resounds with martial music through their daily drill. Mine boats lie at anchorage. Torpedo boats are

And in the shadows of this Gibraltar camp, thousands of farmers are struggling with the ocean in the Western states. They, too, must organize and co-operate in order to survive.

The Hawaiian farmer is further handicapped. His transportation and marketing of his produce is largely of a perishable nature.

The difficulties have served only to emphasize the results which have been obtained in the past. One lesson. But the biggest of these lessons is the produce of the farms.

Soon after the United States annexed the Hawaiian Islands, the legislature has aided in this work by appropriating funds for devising better means for the farmers.

When the last territorial appropriation was made, the funds for devising better means for the farmers were exhausted.

It was generally agreed that in order to help the farmers on the islands was necessary in the different districts. Several organizations are being banded together in Honolulu to promote, create and handle the business of the farmers.

The annual report of the Hawaiian Agricultural Experiment Station, issued, names among the active co-operative organizations the Glenwood Creamery Co., the Hawaiian Dairy Association, the Kapaa Farmers' Association and the Hawaii Farmers' Association.

The story of the growth of the Glenwood Creamery under most adverse conditions. Although the difficulties of dairying, transportation and refrigeration of the creamery look almost hopeless. The dairymen on the demonstration farm, with the help of the dairymen were convinced of its feasibility. Within a few months the dairymen take over the creamery. Within a few months the co-operative company is organized in the surrounding territory and the dairymen turned their attention to helping to improve the industry by demonstrating better forage production and other methods.

Concerning co-operative marketing

"At present there seems to be no other way of getting their crops in the territory except by the co-operative way. In any way can a uniform supply of produce be obtained. If a uniform and constant supply, it is impossible for any given product is shipped from the islands to handle island produce, and make deliveries to San Francisco. The practical result of this plan for local butter and buttermilk from the islands effectively this plan obviates the great difficulty of the farmer who operates independently. Not only does he get a uniform supply and hold his trade, but he is under no obligation to pay a rate for small shipments than is the case with the members of a community who are occupied

MARKETING IN 14-INCH GUNS HAWAII

Pacific ocean stands Oahu, vigilant sentinel
From her gray, volcanic wastes and the
inch guns. Behind these are the gaping-
on far over the horizon upon an advancing
re than 7,000 of Uncle Sam's soldiers go
and out of Pearl harbor. A great warship

Pacific, greatest of all United States armed
problems like those of their brothers across
irrigate in order to grow full crops. They,
obtain profitable markets for their produce.
in the markets than are the Western farm-
are fewer and more unsatisfactory. His

Hawaiian farmers to greater effort, and
ation farmers of the West can find more than
the value of co-operation in marketing the

aii, the Department of Agriculture began
s on several of the islands. The territorial
ropriations.

made, specific provision for use of part of
ng farm produce was included in the bill.
make the plan successful, affiliation among
l co-operative associations are being organ-
ady in successful operation. The local asso-
al federation, with a central office in Hono-
g of the farmer's produce.

al Experiment Station, which has just been
ciations which have been formed recently
y Association, the Homestead Farmers' As-
Haiku Farmers' Association and the Waimea

Creamery Association is one of development
located in the heart of a territory best suited
blems were such as to make the establishment
, a small modern creamery was constructed
ling that as soon as a sufficient number of
should form a co-operative association to
ne output had reached 2,000 pounds of butter
nized. It is finding a market for all its out-
Meanwhile the government experts have

dairy stock of the neighborhood, demon-
assisting the homesteaders.

aii, the experiment station report says:

by v, which the farmers can economically market
tion of co-operative associations. In no other
hed to any particular market. Without a
o build up and hold a trade. Unless a sup-
to the Honolulu market, the dealers refuse
ngements for regular shipments by boats
wn in the rapid development of the market
ood Creamery Company show clearly how
ages under which the farmer must labor if
ole independently to maintain a uniform sup-
vantage of having to pay a higher freight
ere associations are formed among all mem-
ing the same crop."



Banana Plantation near Honolulu.



Sugar Cane and Irrigation Ditch, Oahu, Hawaiian Islands.

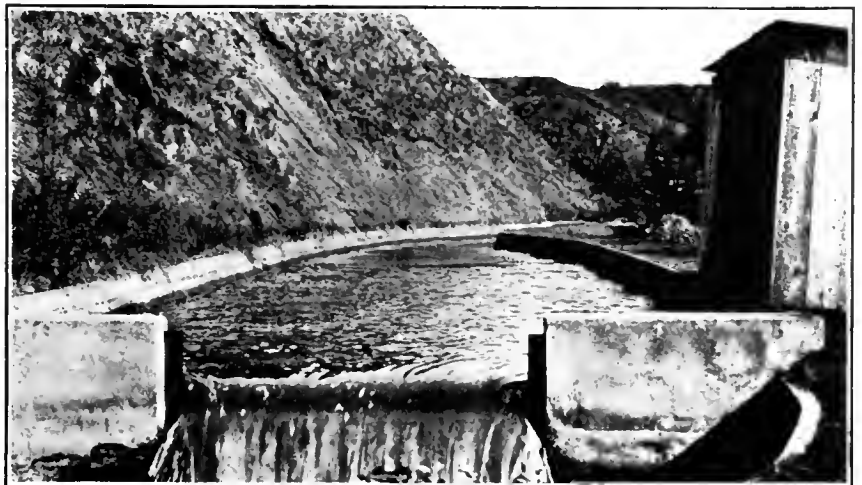

Weir Gauging Station, Wahiawa Reservoir Ditch, Oahu, Hawaiian Islands.

THE BATTLE AGAINST IRON CORROSION

By J. T. HAY

Metallurgist and Chemist

THE progress in the art of manufacturing iron and steel has been most remarkable in the last few years and of all the factors which have contributed towards it none has been more influential than the destructive forces of corrosion, which have challenged the best efforts of man to produce a permanent iron or steel product. It is a well-established fact that the processes of manufacture have much more to do with the final lasting quality of the material than was formerly supposed.

It is a recognized fact that the open-hearth furnace alone is suitable for the production of high-grade metal in large quantities. The electric furnaces are rapidly forging their way to the front, but they have not been long enough in the field for us to accurately determine their position. Therefore, we will deal with the open-hearth furnace and its production, and try to show some of the many factors in the process of manufacturing which have an influence on the corrosion of the finished products. To begin with, it is necessary that we have raw materials of good quality, pig iron, scrap and fluxes; the standard specifications of basic pig are suited for our requirements. Great care must be taken in the purchasing of scrap, as it requires but a small amount of impurities in the scrap to cause unlimited trouble in the finished product. Cast iron scrap of all kinds is to be avoided. Furnace operations are the next factor to be considered. The education of the men operating the open-hearth furnaces is of the utmost importance.

The proper regulation of the temperature of the furnace is a most important factor, influencing the quality of the product, and the ascertaining of the temperature with the eye, as it is customarily done, is an uncertain proposition at the best. After the metal has become thoroughly molten and the temperature has been carefully watched, a sample is then taken from the bath and carefully analyzed before the material is removed from the furnace. The old method of determining the amount of phosphorus and carbon in the metal by the visual appearance of a fractured test piece is being rapidly superseded by making preliminary chemical analyses before the material is tapped. Too much stress can not be laid upon this point, if quality in the material is aimed at. But even when these precautions are taken, many a heat is ruined by carelessness in tapping and handling the metal when in the ladle. The melter must have before him the conditions to which the metal was subjected during the three or four hours previous to the tapping, together with the preliminary analyses, to determine the necessary treatment in the ladle, as this is his last chance to add to or detract from the quality of the metal.

Many defects in steel can be traced to dirty molds or lack of care in pouring the molten metal therein.

When the ingot has been removed from the

mold it is usually placed in a reheating furnace or soaking pit before the ingot is cold. The heat of these pits should always be controlled by a pyrometer, because the temperature must be regulated according to the chemical analysis of the metal.

Let us outline now, but briefly, the theory and effects of corrosion. Corrosion, or the rapid rusting of iron and steel, may be considered as an effect of the combined action of water and oxygen, or, in a broad sense, of moisture and air. The most widely accepted theory of the cause of this rapid rusting, or corrosion, called the electrolytic, is based on the fact that when two substances, having different electrical potentials, are immersed in a suitable electrolyte, an electric current is set up and corrosion begins at once. In iron or steel the various impurities differ from the element iron in their electrical potentiality, and the moisture in the air contributes the electrolyte. It is also true that this action is of a chemical nature and that because of the very close connection between electrical and chemical action we are able to control this chemical action by stopping or accelerating the electrical action. The purity of iron has a marked influence on the rapidity of corrosion. The quantity of the impurities must not only be very minute, but those few elements which it is impossible to remove entirely must be absolutely homogeneously distributed. Because of the extreme sensitivity of iron, great care must be used at its physical treatment, or the work of having eliminated the impurities will be labor lost. The strains produced by excessive speed in rolling, unless removed by careful annealing, will generate active corrosion.

Some manufacturers have tried to offset their neglect to remove the objectionable impurities and their lack of careful physical treatment by the addition of copper. This doped steel, instead of being benefited thereby, has to undergo an increase of the total of its impurities, and thus the segregation of the latter is rendered easier, which two factors accelerate corrosion rather than retard it.

ASKS CAREY ACT REVISION

Congressman Carl Hayden, of Arizona, has introduced a bill (H. R. 15218) to revise and amend the Carey act. The original act was passed in 1894 and has been amended in a number of particulars since that time. The Hayden bill provides for a more strict supervision, both on behalf of the State and the United States with respect to the feasibility of proposed irrigation projects, thus protecting both the investor and the settler. The bill reduces the area that may be acquired by any one person from 160 to 80 acres, and requires actual residence on the land for two years and the cultivation of one-half of the irrigable area of the entry before patent can issue. The settler is protected by a provision which prohibits the sale or entry of land until water is available for its irrigation, and the time of payment is extended from ten to fifteen years.

GETTING WATER FROM MOTHER EARTH'S HEART

THE many difficulties encountered in pumping from deep bored wells or shafts has rendered this a fertile field for the inventor of pumping machinery. From the nature of the service it is invariably required to obtain the maximum possible capacity from a given size bore hole. Large capacity entails high pumping speeds, which in turn cause rapid deterioration of pumps. Rapid deterioration of pump parts is most serious, as, from their location, great difficulty and delay are encountered in making repairs.

In their triple-acting well pump, the Deane Steam Pump Company of Holyoke, Mass., believe they have a machine which overcomes several objections to other types of deep-well pumps. The Deane type of machine consists of three single-acting buckets, superimposed and operating in one cylinder. The buckets are independently reciprocated by means of individual coaxial working rods, which are in turn actuated at the ground level by means of the connecting rods and crossheads. The cranks are located at 120 degrees. Consequently, at least one plunger is constantly being raised and that plunger discharges while it is rising at maximum speed. This very simple and beautiful mechanical movement gives precisely that constant and continuous flow in the riser pipe most necessary to prevent inertia shocks. Further than this, the capacity, as compared with a single-acting bucket, is equal to approximately 2.6 times as much as the single-acting bucket, and the load is taken up by each plunger in turn as the preceding plunger slows down, with practically no jar or shock. This feature is almost as important as the large capacity and continuous flow, as it means few repairs or renewals of parts which are most expensive and difficult to make. Any arrangement which will minimize the wear on the buckets and working parts and prevent the necessity of renewal is of great value.

The successful application of this pump to very severe conditions of service during two years has proven the entire reliability of the mechanism. The continuous flow of water lessens the liability of sand sticking in the working parts and cutting. The continuous flow also tends to extremely high mechanical efficiency. In addition to the saving in operating cost, due to the high efficiency and consequently to the small amount of power consumed, the extreme evenness of the load permits the use of a smaller prime mover than will any other type of deep well pump of the same capacity, and as the load is constantly uniform a motor can be operated at full load and consequently with high power factor. The triple-acting pump, on account of its steady flow, the valve action and the mechanical construction, can be run at speeds higher than other reciprocating deep well pumps. Hence, from a

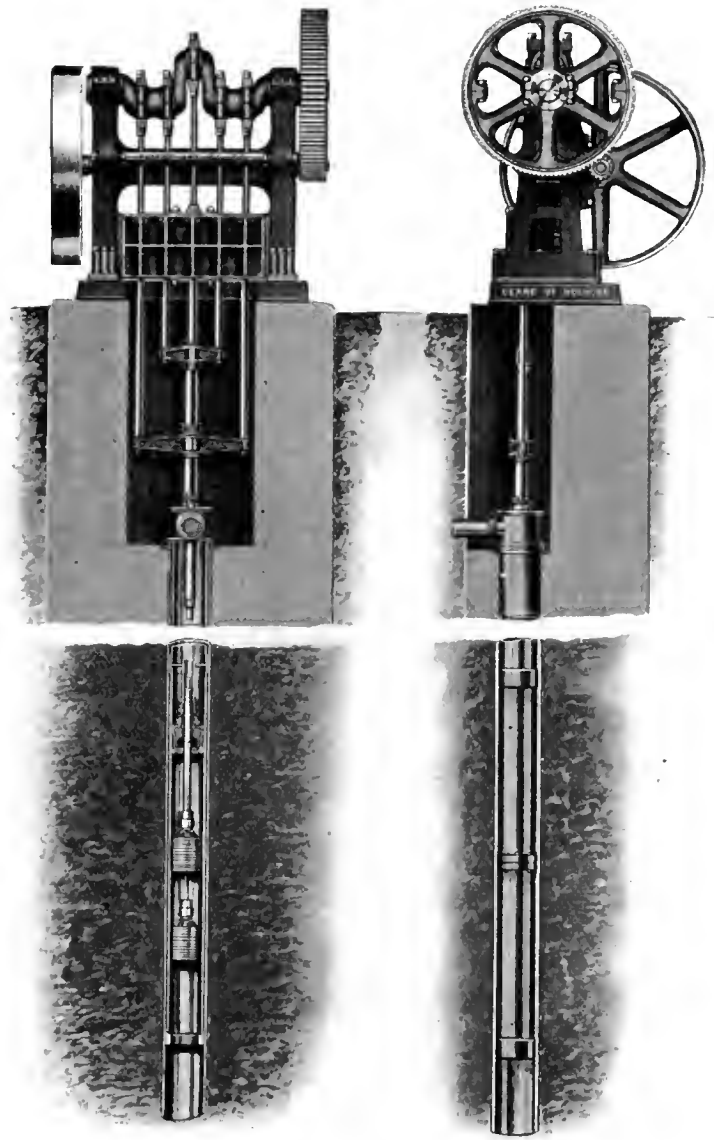

Two Views of the Deane Triple-Acting Pump.

given well a greater capacity can be obtained with a triple-plunger pump than with other types rated at the same piston speed.

Bored wells are becoming more and more important in furnishing a sufficient quantity of fresh water for every purpose. In a great many sections of the country the bored well is the only means of providing fresh water, since the greater quantity of pure water lies between strata at some distance below the surface of the earth. In the last few years the sizes of driven wells have increased considerably. It is, therefore, of tremendous importance that satisfactory pumping equipment be obtained for handling the large quantities of water required. The Deane pump is suitable for irrigation work, municipal supply, factories of all kinds and, in fact, wherever a large water supply is required.

CLEAN DITCHES AND GOOD ROADS MEAN WEALTH

"GOOD roads and clean, well built ditches are two elements which make for the success of the irrigation farmer," said C. D. Edwards, of Albert Lea, Minn., the other day. "The farmers have to do most of the road building themselves and therefore many of them are now investing in this class of machinery."

"I have striven to build for the western farmer a machine that will serve him in two ways—as a road grader and as a ditch constructor and cleaner. I have sought to build this machine strong but simple and suitable to meet with the conditions with which he must cope."

The grader, of which Mr. Edwards is perhaps most proud because of its utilitarian values, carries a blade with the proper adjustment for making V-bottom irrigation ditches on a slope of one and one-half to one. Any elevation can be given the blade that the banks will stand. Changing single-tree holes in the center, which places the near horse in the ditch, is the only change needed to adapt it to V-bottom ditches.



Making a V Bottom Irrigation Ditch Two Feet Deep on a Slope of One and One-Half to One. Two or Four Horses Are Used According to Requirements.

The wheels being wide apart, which best holds a grader to its work, lets one wheel travel in the point of the ditch and the other completely outside of the bank of earth thrown up, leaving the slope smooth and undisturbed.

O'DONNELL HEARS "FIRST NEWELL COMPLAINT"

By Sam Barrett

Assistant Secretary of the Landowners Protective Association in the Salt River Valley (Ariz.) Project.

CHIEF ENGINEER ARTHUR P. DAVIS, Supervising Engineer Hanna, of the Southwest Division, and I. D. O'Donnell, Supervisor of Irrigation of the United States Reclamation Service, have recently held hearings in Phoenix, Ariz., in conjunction with the Survey Board, which was appointed by the Salt River Valley Water Users' Association and the Secretary of the Interior to determine the irrigation area under the Roosevelt Project.

Arthur P. Davis only attended one hearing and he was severely criticized for the Reclamation Service not determining the irrigation area some years ago, and also for the favors that had been handed to the new lands in the way of a new irrigation system.

I also had an interesting conversation with Mr. O'Donnell. Because it is enlightening I submit it. I handed him a copy of THE IRRIGATION AGE.

BARRETT—"I do not know Mr. Anderson, personally, but I do know some of the persons who have articles in his paper, and I believe them to be

sincere and right in what they advocate. One article was written by Scott Etter, of the Carlsbad Project in New Mexico, in which he states that the Secretary of the Interior will never receive the confidence of the Water Users unless Newell is removed from the head of the Reclamation Commission. I, too, am certain Secretary Lane will not receive the proper confidence of the Water Users unless Mr. F. H. Newell is removed from the service."

O'DONNELL—"You are the first man I ever heard say it."

BARRETT—"If you will, take the time and come with me I will take you to hundreds of Water Users in this Valley who will say it. The Water Users of this project feel that Newell is responsible for the outrageously high cost of this project. What the Water Users of this Valley would like to see is a thorough Congressional investigation of the U. S. R. S."

O'DONNELL—"You don't want a Congressional investigation."

(Continued on Page 219.)

BRIEF NOTES FROM IRRIGATION PROJECTS

CALIFORNIA.

The Happy Valley Irrigation Company has commenced work on a storage reservoir twelve miles northeast of Cottonwood, which, when finished, will furnish water for many thousand acres.

Bonds totalling \$610,000 have been voted by the Modesto Irrigation District. Five hundred thousand dollars of this amount will be used for concrete flumes and fills and enlarging the main canal outside the district at the headworks, and \$110,000 will be used for canal repairs.

Two hundred land owners in Victor Valley recently passed resolutions demanding Government support for a reclamation project to irrigate 300,000 tillable acres in that district. The resolutions will be forwarded to Congress and to Secretary of the Interior Lane. The Government is asked to appropriate \$15,000 for survey work on the Mojave river, with a water shed of 350 square miles. By impounding the water from melting snows and the summer rains it is believed that the greater part of Victor Valley can be irrigated.

G. L. Clayton, president of the Honey Lake Valley Water Users'

Association, stated recently that he believed sufficient financial assistance has been promised to insure the irrigation of more than 200,000 acres of fertile land in the valley. Two years ago aid was promised by the Southern Pacific railroad, and it is thought that this promise has been kept. Irrigation of Honey Lake valley can be accomplished through several sources of water supply, including Eagle Lake.

The railroad commission has rendered a decision authorizing the Excelsior Water and Mining Company of Smartsville, serving water for irrigation purposes in Nevada and Yuba counties, to charge a minimum per annum of \$4 per acre for one acre foot of water, and an additional rate of \$1.25 for each additional half-acre foot.

A new irrigation project in Shasta county, called the Anderson Irrigation District, has been virtually organized. It is proposed to divert 300 second feet of water from the Sacramento river, at Turtle Bay, in the city limits of Redding and carry it by canals and laterals down the west side of the river, covering 27,000 acres of land in Shasta and Tehama counties. The estimated cost of the project is \$275,000, or \$12 per acre.

ARIZONA.

The Water Users' Association of the Salt River Valley has taken active stand against the proposal of the state game warden to plant wild rice on the sand bars of the Gila and Salt rivers for the use of the wild game birds. Wild rice grows very rank, spreads rapidly and would soon choke up the irrigation ditches.

The Tucson Farms Company has closed a contract for power to pump water for irrigating an additional 4,000 acres at Sahuarita. The company now has 10,000 acres under cultivation.

COLORADO.

A discovery of water that may have an important bearing on the future development of vacant land close to Colorado Springs has been made by the East Colorado Springs Land Company, composed of Irving Howbert, J. A. Hayes and H. McGarry. This company owns a large tract of unimproved land immediately east of Colorado Springs, stretching along Pike's Peak highway. The first well sunk developed a flow of water at a depth of 100 feet and the well now has 90 feet of water. It is apparently an inexhaustible supply. With a gas-

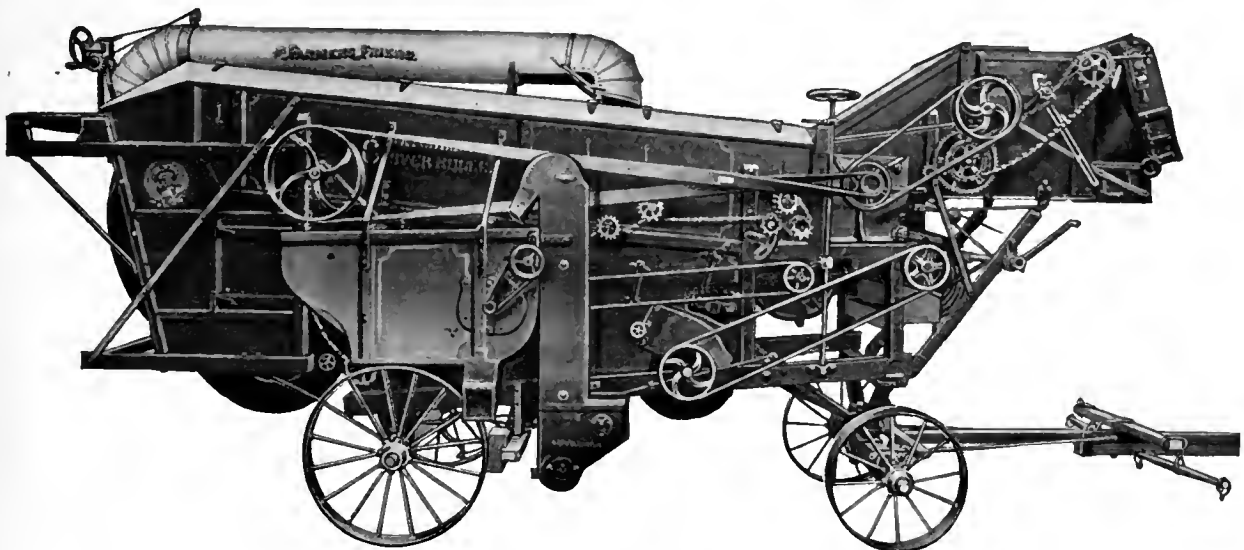

HULL YOUR SEED QUICKLY, PERFECTLY and ECONOMICALLY With a
"MATCHLESS" CLOVER and ALFALFA HULLER

That's just what you will do if you use a "Matchless" Huller on the job. It's the one huller that will hull all the Clover or Alfalfa you can get to it without sacrificing the quality of the work. Here's the reason! We use square steel brads in our hulling cylinder. This construction has every advantage over rasps of spikes, because no set of spikes will knock the seed out of the damp pods. Rasps gum up and are easily destroyed. Our system of separation is unique and effective. This consists of a series of rotating troughs with perforation in the bottom, with provision for adjustment to meet the various conditions of clover. The Patented Steel Scrapers attached to the bottom of these troughs thoroughly scrape the separator bottom and insure a steady and positive delivery of the pods to the hulling cylinder, regardless of the condition of the clover. This construction enables you to hull seed under conditions in which no other huller can operate; enables you to hull earlier in the morning and later in the evening than with any other—this insures a longer day, thus increasing your earning power. Give us an opportunity to prove to you right on your own farm that the "Matchless" is the speediest and cleanest huller on the market. WRITE FOR CATALOG TODAY, or call at our nearest Branch House.

THE AULTMAN & TAYLOR MACHINERY COMPANY, MANSFIELD, OHIO.

Sole Builders of Aultman-Taylor "Starved Rooster" Line of Machinery.

BRANCHES: Minneapolis, Minn.; Portland, Ore.; Lincoln, Nebr.; Kansas City, Mo.; Wichita, Kan.; Decatur, Ill.; Indianapolis, Ind.

When writing to advertisers please mention The Irrigation Age.

oline pumping engine, it will supply sufficient water for a large acreage.

Contract has been awarded under authority of the Secretary of the Interior to the Hess Flume Company of Denver, Colorado, for furnishing 7,357 linear feet of metal flume for use on the projects of the Reclamation Service in the Northern Division. The total bid for the material to be furnished was \$19,650.42.

A decision of great importance to ranches in all irrigated districts has been handed down by Judge Cavender in the district court, in which he holds that the mere fact of the use of a ditch for irrigation purposes gives no title to its user. In all irrigated sections in the state ranchers have been proceeding on the theory that when they once established either a waste ditch or a head ditch on anyone's land, they acquired title to the ditch through continued use of it. Judge Cavender held, however, in a case from Fruita of T. A. Topham vs. Morgan Williams that no such right existed in law. His opinion was that no matter how long a ditch may be used by a farmer, title remains in the original owner, even though permission had been granted for its construction. To obtain title to the ditch a conveyance must be made by deed or by condemnation proceedings, as the courts have held that ditches are real property which must be transferred as is other property.

The Twin Lakes irrigation project, one of the largest irrigation enterprises in the state of Colorado, recently passed into the hands of the farmers of the Arkansas Valley. The farmers have acquired control of the Twin lakes stock. There are 56,000 acres of land being operated under the project at this time. The Twin Lakes system takes its water largely from Twin Lakes, near Leadville. The water is taken to the Arkansas river and thence transported in the river channel to a diversion canal which starts near Boone.

MONTANA.

Articles of incorporation have been filed by the Billings Heights Irrigation Company. The office of the company is located at Billings.

Gen. Chas. S. Warren and other Butte men, who are interested in a Carey act irrigation project in southeastern Montana, have incorporated the Little Missouri Land and Irrigation Company with a capitalization of \$350,000. It is planned to start work on the project the coming summer, and the first unit, about 6,000 acres, will be opened next spring. The lands embraced within the project lie along the west side of the Little Missouri river, within the boundaries of Fallon county. The water supply requisite for the reclamation and irrigation of the lands is obtained from the Little Missouri river and Cottonwood Creek.

The U. S. Reclamation Service is

Oil Engines for Pumping

Develop full rated power on low priced fuels, as well as Kerosene or Gasoline. Greatly reduce fuel cost. Made in sizes from 2 to 200 H. P.

Fairbanks-Morse Irrigation Equipment

is used for the irrigation of thousands of acres in the Southwest. Pumps furnished direct connected to oil engine or electric motor—or for belt drive. Sizes and types for every requirement.

Write for Catalogue 31-N-650

Fairbanks, Morse & Co.

Chicago
Kansas City

St. Louis
Omaha

St. Paul
Denver

Salt Lake City
Los Angeles

Spokane
Portland

Seattle
Atlanta

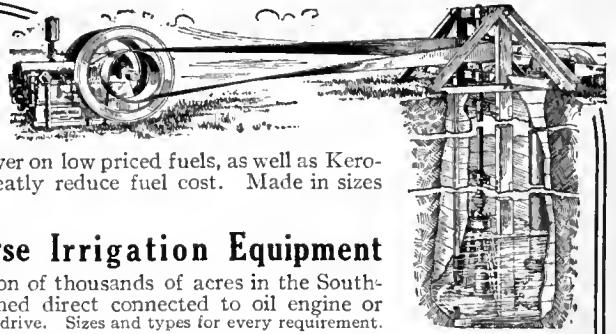

Farming Pays

on the

Northern Pacific Railway

*From the Great Lakes Clear
Through to the Pacific Ocean*

This northern tier of states—Minnesota, North Dakota, Montana, Idaho, Washington and Oregon—offers a healthful climate, the best crop records in America and in all respects the best opportunities in the West.

Every Northern Pacific State Produces Corn

THIS GROUP of states made a remarkable series of winnings at the NATIONAL CORN EXPOSITION, Dallas, Texas, in February, 1914.

THE NORTHERN PACIFIC—the Pioneer Line—will aid you in securing what you want, agriculturally or industrially. Desirable deeded land, improved and unimproved, on reasonable prices and terms.

ROUND TRIP Homeseekers tickets on sale FIRST and THIRD Tuesdays.

Write for literature. Mention State or section in which interested.



L. J. BRICKER, Gen'l Immig. Agt.
Northern Pacific Building
St. Paul, Minn.

asking for proposals for earthwork and structures on the Second Unit of Vanadlia South Canal on the Milk river project in Montana. The work involves about 145,000 cubic yards of excavation, 300 cubic yards of reinforced concrete, the placing of 18,000 pounds of steel reinforcements and the placing in wooden structures of 125,000 feet B. M. of lumber, and is situated on the south side of Milk river in the vicinity of Glasgow and Nashua, Montana. Bids will be opened at 2:00 P. M., May 20, 1914, at the office of the Reclamation Service, Malta, Mont.

The Reclamation Service is also asking for proposals for earthwork and structures, Vandalia Point, Vandalia South Canal, in connection with the Milk river irrigation project. The work involves about 68,000 cubic yards of excavation, 1,900 cubic yards of concrete, the placing of 160,000 pounds of steel reinforcement, the erecting of 1,550 linear feet of metal flume and the placing in wooden structures of about 125,000 feet B. M. of lumber. It is situated on the south side of Milk river, about 18 miles west of Glasgow and one mile west of Vandalia, and adjacent to the main line of the Great Northern Railway. Bids will be opened after 2 p. m., May 27, at Malta.

OREGON.

R. A. Rowley of Medford has been granted a permit to use the waters of Big Butte creek to irrigate 10,030 acres of land.

Bids are being asked for on the Horse Fly irrigation project. The main canal will be located about eight miles east of Bonanza and will be 13 miles in length.

Permit has been granted the Ontario Advancement Company of Ontario to use the waters of Snake river to irrigate 1576 acres of land.

Time of the preliminary contract for the Warner Valley irrigation company, which is investigating a proposed irrigation project in Warner Valley, has been extended by the Desert Land Board to December 1, 1914.

Project Engineer H. W. Hinks announces there is still \$100,000 available for construction work on Modoc Point reclamation project. This project is being built by the Indian Service for the Klamath Indians. It will irrigate 8745 acres of land.

The government will open approximately 400,000 acres of land in southern Crook county to homesteaders on June 7. The land is being eliminated from the Paulina and Deschutes National forest reserves. Settlers are now being allowed to pick their land, and the first man on hand at the land office with his witness will be given the parcel selected.

The Reclamation Service is asking for proposals for the construction of
(Continued on Page 216.)

GOOD ENOUGH Heavy Deep Furrow Sulky Plow

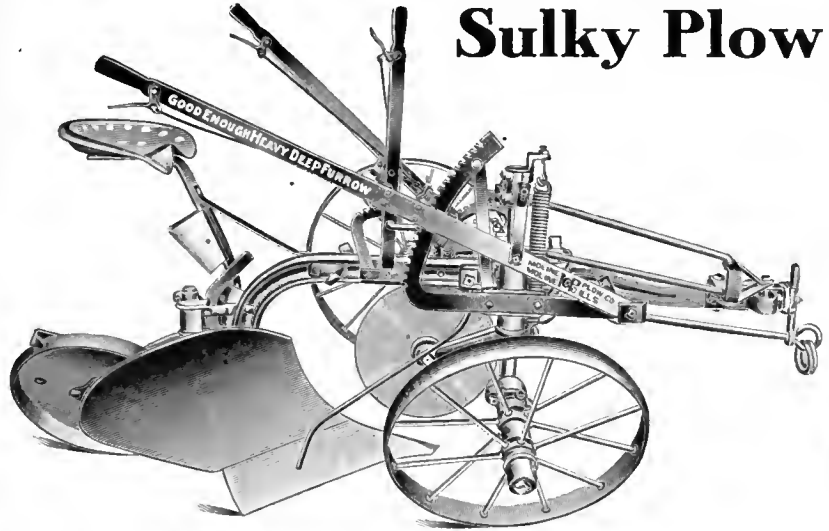

Save Moisture—Increase Yield

Plow deep—form deep moisture reservoirs—increase the feeding area of the plant roots—liberate more plant food. Do these things and your crops will be greatly increased. The Good Enough Heavy Deep Furrow Sulky is the most efficient plow for deep plowing on the market.

The Good Enough Heavy Deep Furrow Sulky is a tremendously strong and powerful plow. It will plow any soil that is capable of being plowed and will turn a furrow from 6 to 15 inches deep.

The landing lever controls both the front furrow wheel and the hitch. The dial hitch can be adjusted to either side and up or down. The draft is applied directly to the beam through the heavy draft rod. The rear wheel is locked in place, but can be instantly released by means of the foot trip at the ends of the rows.

Regularly furnished with five-horse evener, rolling coulter and extra shares.

**See Your Flying Dutchman Dealer
or Write for Information**



Moline Plow Co.

Dept. 3

MOLINE, ILL.



AID TO SETTLERS IS FIRST NEED

(Continued from Page 204.)

with less than half the land under cultivation, with inadequate revenues, and only needing the settler to completely change the situation. Under some of these schemes the conditions for extending this aid are altogether satisfactory, whilst in others, settlement, under present conditions, should be prevented. Either the water supply is inadequate, the land is unfit, or the charges for land and water are too high. To extend public aid in the settlement of such enterprises means inevitable disaster to all concerned, and the first step in all cases should be an investigation by some competent public authority, to weed out the sound from the unsound schemes. Starting with sound enterprises, there should, in each case, be an organization to meet and take charge of the settlers, and there must be some way by which large sums of money can be provided to give them the needed aid.

In the State of Victoria this money is provided in large measure by the State Savings Bank, which has

deposits of \$110,000,000, on which three and three and one-half per cent interest is paid. This money is loaned directly to the farmers at four and a half and five per cent. A remote country, with small accumulations, thus gives the farmers money at about half the interest rate prevailing in the western part of the United States. It has seemed to me that the Victorian policy might wisely be followed in the United States, and the funds deposited in the Postal Savings bank of the Nation loaned to farmers developing irrigated lands rather than to the banks, as at present. The experience of all of the Australian states and New Zealand shows that not only is this a safe use for these funds, but it can be made a great agency for national development. Safety could be further insured by an arrangement under which the states would guarantee the return of all funds loaned to settlers within their boundaries. In any event, the cost of improving land is as great as the expense of providing water for it, and if we are to have a humane and rounded out scheme of development, the settler's side must receive more consideration.

RECLAMATION NOTES

(Continued from Page 215.)

the Three Miles Falls Diversion Works, in connection with the Uma-tilla irrigation project. The work is located about three miles north and west of Hermiston, and consists in constructing a concrete diversion dam and concrete headworks involving about 2,600 cubic yards of concrete and 3,000 cubic yards of excavation and embankment. The bids will be opened after 3 p. m., May 28, 1914, at the office of the Reclamation Service at Portland.

TEXAS.

Articles of incorporation have been filed by the Rosita Irrigation Company; capital stock \$15,000, with offices at Eagle Pass. W. H. Evans, C. F. Carson and L. L. Schofield are the incorporators.

The State Board of Water Engineers has received certificates of prior appropriation of waters by A. J. Russell of Robert Lee for the irrigation of 1440 acres in Coke county, and of V. M. Sanderson of San Saba for irrigating 200 acres in San Saba county.

UTAH.

A plan is under consideration for converting Little Valley four miles east of Brigham City into a great reservoir to provide water for irrigating 10,000 acres.

The Secretary of the Interior has authorized the Reclamation Service to undertake the construction of the High Line Unit of the Strawberry Valley irrigation project as soon as certain conditions have been complied with. At least 18,000 acres of lands privately owned and irrigable by gravity flow must be pledged to return the cost of the project. Applicants owning irrigable land in excess of 80 acres must execute appropriate trust deeds for the disposal of such excess to qualified water right applicants

(Continued on Page 217.)

Write quick and save high as 60% on your Spring Building

Saved \$327

"The barn is a dandy and we feel greatly indebted to you. The same quality of lumber here would cost nearly one half more." J. D. Johnson, Spring Creek Ranch, Fallon, Mont. June 17, '13.

Saved \$200 to \$300

"My carpenter thinks my ear of lumber the best that ever came into Marion. I saved \$200 to \$300." Abraham Duerkson, Marion Junction, So. Dakota. May 21, '13.

Buy a Seattle Silo Direct from Maker

No wood stave silo service better than fir. We use Douglas fir—from Giant trees—straight-grained, tough, long-lasting. Seattle Silos have quick detachable swinging doors. Door bars form strong ladder from which hoops are tightened. Write for special folder today, and first farmer-in-a-town offer.

If you are going to build this spring, don't fail to send your bill of materials to Hewitt-Lea-Funck for prices. You can save high as 60% and get better lumber and millwork for your money.

Buy Direct From Our Six Mills

We control thousands of acres of choice timber in Pacific Coast States—all the cutting, logging and manufacturing of lumber and millwork takes place under one continuous operation, under one over-head expense, effecting a tremendous saving.

You Save Up to 60% and Get Better Material Send For Money-Saving Plan Book

It contains over 100 practical plans. Full of sensible full-value houses. We sold two big editions in seven weeks. Third edition now ready. Ten cents brings you this book, worth a thousand dimes to any home builder.

Quick Delivery—Satisfaction Guaranteed

We make shipments within 24 to 48 hours after order is received. Shipments reach destination within an average of two weeks. Write today for price list. Better still

Send Carpenter's List for Quick Price

Our estimate will show prices delivered your city. We guarantee our estimates to cover enough of everything. **NO EXTRAS.** Hurry your bill to us. You'll lose a lot of money if you don't get our figures.

Hewitt-Lea-Funck Co.,
471 Cray Bldg., Seattle, Washington

HEWITT-LEA-FUNCK CO., 471 Cray Building, Seattle, Wash.
Send following, quoting prices, delivered my station (Be sure to write plainly.)

<input type="checkbox"/> Catalog Lumber and Millwork	<input type="checkbox"/> Special Barn Folder (4c)
<input type="checkbox"/> Prize Plan Book, 10c.	<input type="checkbox"/> Special Silo Folder—

Name _____ Town _____
State _____

I am planning to build as follows: _____

CALLS 'PRIOR LEVELING' KEY TO SUCCESS

(Continued from Page 207.)

of a man entering the raw land at \$60 per acre and the other entering the leveled land at \$100 per acre, the \$40 cost of leveling the land having been added to the latter's construction costs. The expenses of each for the family, stock and farm combined will easily aggregate \$1,000 a year. For convenience assume a whole 80 to go under cultivation; admit \$10 net profit for land the first year it is put in and \$20 net profit per acre thereafter. Apply the terms of payments under the twenty-year Extension bill, with its graduated annual installments.

Now note what is the result. The raw land man can hardly get in more than five acres the first year and five acres annually thereafter and he finds it is ten years before he passes a deficit merely between ranch returns and ranch expenses and it is the fourteenth year before he gets the ranch to meeting all expenses. This means he has been drawing on capital or has been forced to work off his place year after year to earn sufficient money to meet his expenses

and payments and that is exactly what almost every single entryman has been forced to do up to the present and why the land has gone in so slow. The leveled land man gets his full 80 acres into crop, goes only \$200 in the hole the first year; will be carried over by his merchant and the next year he is on his feet with a surplus.

They both might be said to have had about \$3,000 of capital invested in plant and equipment at the start. The man on leveled land needs not more capital but the raw land man will need about \$6,700 more before he reaches his surplus in the fourteenth year. Of course what really happens is that he is forced off the ranch, if having only about \$3,000, and he has to hustle work and wages and so the farm goes in at only five acres a year. Yet let's look the matter square in the face and admit the wages earned off the place to support the family and payments must all be charged up to the capital account in final analysis. In reclaiming our farms in the years to come, which is going to pay, capitalizing the work with cash or trying to capitalize it with the farmer's sweat and toil?

RECLAMATION NOTES

(Continued from Page 216.)

within a reasonable time to be fixed hereafter. About 24,000 acres are included in the unit. The main high-line canal has its intake at the lower end of the power canal in Spanish Fork Canyon, about 3 miles south-east of Spanish Fork. It will extend southwest for about 17 miles, its capacity ranging from 200 to 250 second feet. Its cost will be about \$343,000 and the distribution system as planned will cost \$180,000.

WASHINGTON.

Contract has been awarded by the Reclamation Service to the Fairbanks Steam Shovel Company of Marion, Ohio, for furnishing a 1½ cubic yard dipper dredge for use in connection with the Keechelus Dam on the storage unit, Yakima irrigation project. The price for the dredge f. o. b. cars, Marion, is \$8,400.

Suit has been filed in the superior court of Kittitas county by Mrs. Olive Sanders to settle the title to the waters of Wilson and Nanum creeks. All property owners along the Nanum creek are made defendants to the suit, while the complainant states that she is acting for all land owners whose property is watered by Wilson creek. The water rights along each creek have previously been settled, but this suit is to decide which stream should have the most water beyond the forks.

VOTERS PASS ON PROJECT

Washington voters will pass upon a project for the irrigation of 400,000 acres of dry lands at the election in November. The estimated cost of the work is \$100 an acre, or \$40,000,000. The lands are in Douglas and Grant counties between the Spokane and Columbia rivers. The soil is volcanic ash and loam, and is especially suited to irrigation and diversified farming.

International Harvester Oil and Gas Engines

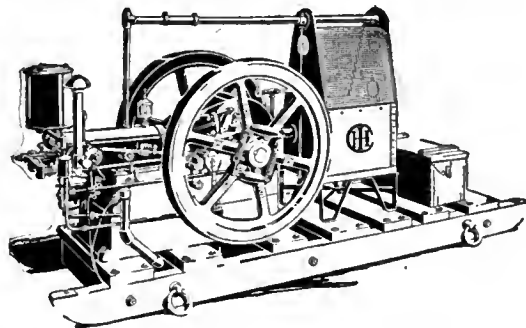

THE I H C LINE GRAIN AND HAY MACHINES

Binders, Reapers
Headers, Mowers
Rakes, Stackers
Hay Loaders
Hay Presses

CORN MACHINES

Planters, Pickers
Binders, Cultivators
Ensilago Cutters
Shellers, Shredders

TILLAGE

Combination,
Peg and Spring-Tooth,
and Disk Harrows
Cultivators

GENERAL LINE

Oil and Gas Engines
Oil Tractors
Manure Spreaders
Cream Separators
Farm Wagons
Motor Trucks
Threshers
Grain Drills
Feed Grinders
Knife Grinders
Binder Twine

SUCCESSFUL farmers are no longer asking, "Shall I buy an engine?" They have passed that point and now inquire, "Which engine shall I buy?"

A little careful observation will show that International Harvester engines are the most satisfactory. No doubt is left when features like the following are studied: Detachable valve guides, offset cylinder head, fuel pump, split-hub fly-wheels, extra large intake and exhaust valves, etc.

Ask the men who have used I H C engines. That is the best test. They will explain the excellence of I H C construction, simplicity, strength and durability.

Study the engines yourself at the nearest dealer's where International Harvester engines are sold. They are made in all styles, and range in size from 1 to 60-H. P. They operate on low and high grade fuels.

Write for our interesting and instructive catalogues, and when we send them we will tell you where the engines may be seen. A postal will do.

International Harvester Company of America

(Incorporated)

Denver—Helena—Portland—Spokane—Salt Lake City—San Francisco

Champion Deering McCormick Milwaukee Osborne Plano



BUSINESS MEN MUST AID IRRIGATORS

(Continued from Page 206.)

This is a problem of neighborhood cooperation. It is a problem with which the farmer in the older settled states has had very little to do. Its first principles were solved in suffering and sorrow long ago. It is the problem that first wrecked Kansas. It is one that the farmer himself has never solved and for years to come will never solve. He goes down before it every time, until finally it solves itself; but at a fearful cost to the individuals who have gradually worn it out with their lives and with their wives and families.

This is a business problem purely and must be solved by business men. The agricultural and irrigation problems are more than sufficient to absorb all the time, energy and brains of the farmer in a strange land. If he is to succeed someone must help him to get every dollar out of his produce that it is worth. Is this done?

Has he not rather been exploited all along the line? Have we not permitted, and even encouraged, fearfully expensive methods of immigration work under which he has often had to pay a ruinous cost for a big bunch of false expectations, and started in his new home doomed to a feeling of despair as soon as he realizes the actual facts?

How many of our business communities help him to hold his crops off a glutted market?

Have we business men not safely reaped large benefits from all expenditure for irrigation, whether wise or foolish, and from all the labors and investments of the farmers, whether productive or not to them, and have we shared commensurately, or in most instances at all, in the burdens or the risk?

Neighborhood cooperation for the solution of the farmers' problems must be the foundation of all permanent success in our irrigation districts. It must begin with seeing that he buys his land at a fair value, with a fairly comprehensive appreciation of the problems he has to face, and a reasonably safe relation between the size and price of his farm and his own working capital. It must make him feel that his success is the chief aim of his new community. It must end with assuring him adequate returns compared with other producers and competitors on the open markets.

This complete cooperation can be worked out only by the business men of each locality contributing a portion of their time and their knowledge to the common good.

The financial returns of such cooperation will remove it far from the region of gratuitous help, or inequality of labor, and will soon prove it to be the most profitable investment of time, and even of capital where such is needed, that the business community can make.

It is the sure and short road to prosperity for the west.



distillate with unequalled economy. The Aultman-Taylor 30-60 is not an experiment. Their real worth has been demonstrated on thousands of farms throughout North America. Let us explain to you why you should own and operate one of these money-making and labor-saving tractors. WRITE FOR CATALOG AND FURTHER INFORMATION TODAY.

We are also builders of the Famous "New Century" Separator, "Matchless" Clover and Alfalfa Huller, Steam Traction and Portable Engines, Bean Threshers and Saw Mills. Catalog free upon request.

THE AULTMAN & TAYLOR MACHINERY COMPANY

MANSFIELD, OHIO.

BRANCHES: Minneapolis, Minn.
Wichita, Kan.

Portland, Ore.
Decatur, Ill.

Lincoln, Nebr.
Indianapolis, Ind.

Kansas City, Mo.

THINK what it means to you! To have at your service—day and night if desired—the combined power of 30 to 35 horses and 10 to 15 men—ready at a moment's notice to plow, disc, harrow, seed, harvest, build roads, irrigate, thresh and do numerous other power jobs, all at the minimum expense for fuel and maintenance. That's what you get when you buy a time-tried and time-proven

AULTMAN-TAYLOR 30-60 GAS TRACTOR

They're built with the complete knowledge of the requirements of a tractor of the first quality. They're built right here in our own shop, under our own supervision. We know they're right and we stand back of every tractor. The Aultman-Taylor 30-60 burns either gasoline, kerosene or

HEARS FIRST NEWELL COMPLAINT

(Continued from Page 212.)

BARRETT—"What do we want?"

O'DONNELL—"You want an investigation from your Water Users' Association and the Secre-

tary of the Interior. What would a Congressional Committee know about the investigation of projects? I must go, they're waiting."

I believe this conversation illustrates the attitude Mr. O'Donnell takes concerning past management and expenditures in the Reclamation Service.

We planned this House and Saved Robert Zehntner \$375.00

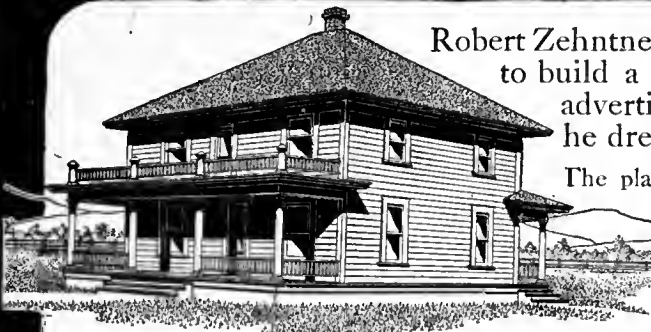

Home Designed for Robert Zehntner, White Sulphur Springs, Mont.

Robert Zehntner of White Sulphur Springs, Mont., wanted to build a home and answered a Hewitt-Lea-Funck advertisement. On the back of our question blank he drew a rough sketch of what he had in mind.

The plans you see at the left, and afterward, the house pictured, was the result. When it came to ordering the lumber, the local yard man asked for the chance to bid and got it, but he didn't get the business. Mr. Zehntner's letter to us tells why. "I unloaded the car," he says, "and found the material fine. The carpenters are well pleased, the finish being much better than I could have gotten here. The best local bid on the material was \$375 higher than yours and lacked quite a bit of being complete."

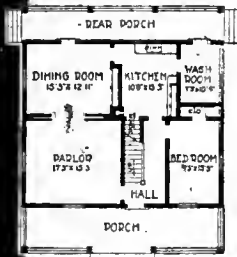

FIRST-FLOOR PLAN - DESIGN - HF - 610 -

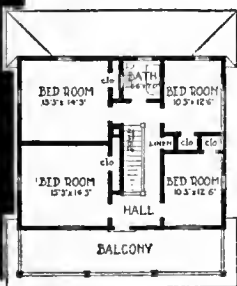

SECOND-FLOOR PLAN - DESIGN - HF - 610 -

Complete plans \$2

If you like this house, you can get the complete plans, specifications, guaranteed estimate of prices on lumber, millwork, hardware, paint and heating plant delivered at your station—all for \$2.

Send coupon for Prize Plan Book - 100 homes—all sizes—all prices

It's the most practical book of its kind ever published. Every plan is a good one—a lot of them will please you—one of them will doubtless just suit you. Our architects worked over a year on this book. It cost us \$30,000 to get it out. Books not nearly so good are sold at 50¢ to \$2.00. Yet, ten cents, merely to cover postage, will bring you this valuable book, if you use the coupon.

Special plans at small cost

If none of the plans in this book quite suit you, and you have your own ideas of what you want, you'll find it easy to show us what your ideas are, just as Robert Zehntner did. We have a Plan Sheet for this purpose, that makes it simple. Give us a rough sketch of what you have in mind—and we will complete the plan for you.

Save as high as 60% on lumber—buy direct from the producer

Too many middlemen come between the mill and the lumber dealer—that's why his prices are so high. We cut out every single

Our guaranteed price means no extras. We guarantee absolutely to provide sufficient materials to build the house, and guarantee grades equal or better, than required by standard rulings. Getting the plans does not obligate buying materials of us, if you do, you get your \$2 back. If this plan doesn't suit,

middleman and sell you direct at the mill price—a price that's way-down low, because the raw materials come from forests under our control. Our lumber is straight-grained, free from sap and large knots, doesn't warp or shrink. Makes a beautiful job.

Send for estimate—no obligation

Send us your carpenter's bill of materials for our prices, if you can. Do it even if you aren't ready to build. No charge or obligation. If we can be of any help to you in planning your building be sure to let us know. Our special plan sheet makes it easy to give us your ideas—ask for it. At any rate, mail the coupon today for catalog and general price list.

Silos at up to 60% Saving

Here's the biggest silo value you can get. Buy direct, at the mill price, a Seattle Silo of one-piece staves from durable Puget Sound fir. Seattle Silos have patented swinging doors. Door bars form strong ladder from which hoops are easily tightened.

Send the coupon for folder on Seattle Silos. Get our special one-farmer-in-a-town-offer. Write today.

HEWITT-LEA-FUNCK COMPANY
471 Crary Building Seattle, Wash.

Hewitt-Lea-Funck Plan Book

Hewitt-Lea-Funck Company
471 Crary Bldg., Seattle, Wash.

(Be sure to write plainly and if possible send bill of materials for estimate)

Please send me the following:

- Book of Plans (for which 10¢ in stamps or coin is enclosed).
- Catalog and General Price List of Lumber and Millwork, Free.
- Special Silo Folder, Free.
- Special Plan Sheet, Free.

Name _____

R. F. D. or Street No. _____

Post Office _____ State _____

Business _____

The Lauson Kerosene and Low Grade Distillate Engines

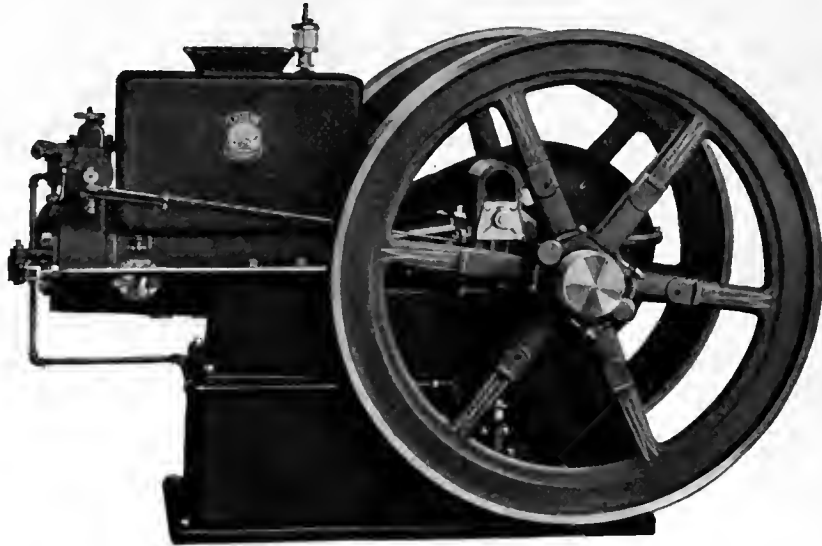

Insure Your Crops

Don't economize on Price when Reliability is at stake. Successful Irrigation depends upon **Heavy Continuous Power**.

You may be able to buy an Engine that is cheaper than the Lauson but the Reliability won't be there.

It won't have that Lasting Economy of Operation—that **Ability to stay on the job three hundred and sixty-five days in the year and twenty-four hours per day**, that characterizes the Lauson.

There is a reason behind Lauson Reliability and Low Cost of Operation, namely Design, Material and Workmanship. It is a question of a better Quality perhaps not noticeable at first, yet **Quality that shows in Years of Dependable Service**. It is worth the Difference.

Such Points as—No torch, no preheating, no carbon in cylinder, easy to start and operate, full rated horse power with one-half the cost of fuel, all wearing parts of steel case hardened and ground to size, drop forged unbreakable gears, cams and cam shaft drop forged in one piece, case hardened and ground to size, cams running in bath of oil, enclosed in dust proof case, special gear-driven Magneto, guaranteed for the life of the engine and No Batteries—are worthy of your most careful investigation.

Built in sizes from 6 to 100 HP. Hopper or Tank Cooled.

The closer you investigate, the Lauson Kerosene Engines, the surer you are to buy one. Our Large Catalog No. 15 tells the whole story. A reading of it, will convince you. Write for it today, and nearest branch and distributing point.

THE JOHN LAUSON MFG. CO.

GENERAL SALES OFFICE AND FACTORY

68 Monroe Street

NEW HOLSTEIN, WIS.

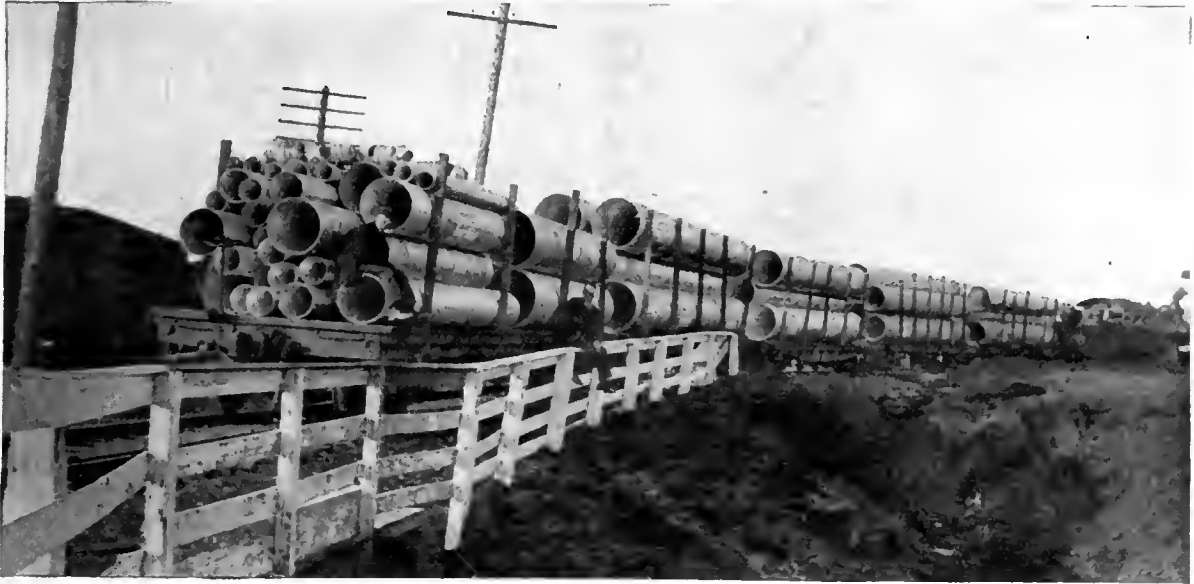

Purity

American Ingot Iron CULVERTS



Permanence

THE great irrigation companies have many places where corrugated iron pipe, gates and bulkheads can be used to advantage, the only difficulty being that the ordinary material in this form has a rather limited service life. This objection is overcome by the use of high-purity iron. See Engineering News, Jan. 22nd, 1914, **Corrugated Iron Installations of the Sacramento Valley Irrigation Project**, by E. C. Mills, Engineer.

The illustration shows part of a shipment of 26 cars of American Ingot Iron Culverts, made to the South San Joaquin Irrigation District, San Joaquin County, California.

Write the nearest manufacturer for particulars and prices on American Ingot Iron Armco Culverts, Siphons, Flumes, Plates, Sheets, Roofing and Formed Products:

- | | | | |
|-----------------------------------------------------------------|--------------------------------------------------------------|-----------------------------------------------------------------|-------------------------------------------------------------------|
| Arkansas —Little Rock
Dixie Culvert & Metal Co. | Iowa —Independence
Independence Cor. Culvert Co. | Montana —Missoula
Montana Culvert Co. | Oregon —Portland
Coast Culvert & Flume Co. |
| California —Los Angeles
California Cor. Culvert Co. | Kansas —Topeka
The Road Supply & Metal Co. | Nebraska —Lincoln
Lee Arnett Co. | Pennsylvania —Warren
Pennsylvania Metal Cul. Co. |
| California —West Berkeley
California Cor. Culvert Co. | Kentucky —Buechel
Kentucky Culvert Co. | Nebraska —Wahoo
Nebraska Culvert & Mfg. Co. | South Dakota —Sioux Falls
Sioux Falls Metal Culvert Co. |
| Colorado —Denver
R. Hardesty Mfg. Co. | Louisiana —New Orleans
Dixie Culvert & Metal Co. | Nevada —Reno
Nevada Metal Mfg. Co. | Tennessee —Nashville
Tennessee Metal Culvert Co. |
| Delaware —Clayton
Delaware Metal Culvert Co. | Maryland —Havre de Grace
J. N. Spencer. | New Hampshire —Nashua
North East Metal Culvert Co. | Texas —Dallas
Atlas Metal Works. |
| Florida —Jacksonville
Dixie Culvert & Metal Co. | Massachusetts —Palmer
New England Metal Cul. Co. | New Jersey —Flemington
Pennsylvania Metal Cul. Co. | Texas —El Paso
Western Metal Mfg. Co. |
| Georgia —Atlanta
Dixie Culvert & Metal Co. | Michigan —Bark River
Bark River Bridge & Cul. Co. | New York —Auburn
Pennsylvania Metal Cul. Co. | Texas —Houston
Lone Star Culvert Co. |
| Illinois —Bloomington
Illinois Corrugated Metal Co. | Michigan —Lansing
Michigan Bridge & Pipe Co. | North Carolina —Greensboro
Dixie Culvert & Metal Co. | Utah —Woods Cross
Utah Culvert Co. |
| Indiana —Crawfordsville
W. Q. O'Neill Co. | Minnesota —Minneapolis
Lyle Corrugated Culvert Co. | North Dakota —Wahpeton
Northwestern Sheet & Iron Wks. | Virginia —Roanoke
Virginia Metal & Culvert Co. |
| Iowa —Des Moines
Iowa Pure Iron Culvert Co. | Minnesota —Lyle
Lyle Corrugated Culvert Co. | Ohio —Middletown
American Rolling Mill Co. | Washington —Spokane
Spokane Cor. Cul. & Tank Co. |
| | Missouri —Moberly
Corrugated Culvert Co. | Oklahoma —Shawnee
Dixie Culvert & Metal Co. | Wisconsin —Eau Claire
Bark River Bridge & Cul. Co. |

Put the right engine behind your pumps

NO matter how large your irrigation system or how small, the efficiency and consistent performance of the engine that drives the pumps is a matter of the utmost importance. Abundant power, ready control, freedom from breakdowns and economy of fuel consumption are points that count big in results and satisfaction. Install a Gilson Engine and you can be sure of reliable service with minimum attention and minimum fuel cost. On irrigation work it has proved itself beyond question **the engine that more than makes good.**

Gilson "Goes Like Sixty" Engines

GAS AND GASOLINE

The strongest and simplest built engines in the field. Easy to operate, work without watching. No unnecessary pounding or wear. Last a lifetime. They do not need constant tinkering for they are designed on practical lines and have no weak spots. Built for hard service from tested materials. Nickel steel valves. Extra large high test babbitt bearings. Forged steel shafts of marvelous strength and finish. Exact workmanship throughout and perfect balance. Many special features and improvements that increase efficiency.



100% Service

60% Speed

GILSON ENGINES are built in sizes from 1 to 15 H. P., each size guaranteed to develop its full rated power. Patented devices give you the right speed for every job about the farm, ranch or irrigation plant. Built-in Sumter magnetos make it possible to start the engine without cranking and do away with batteries.

Mail the Coupon Whatever your requirements, whether for irrigation use or farming operations, there's a Gilson Engine that will give you the right service. Our prices will save you money at the start and the small fuel consumption of Gilson Engines will keep cost of operation down to a surprisingly low figure. Clip off the coupon and mail it back today and we will give you valuable information about the type of engine best suited to your particular needs.

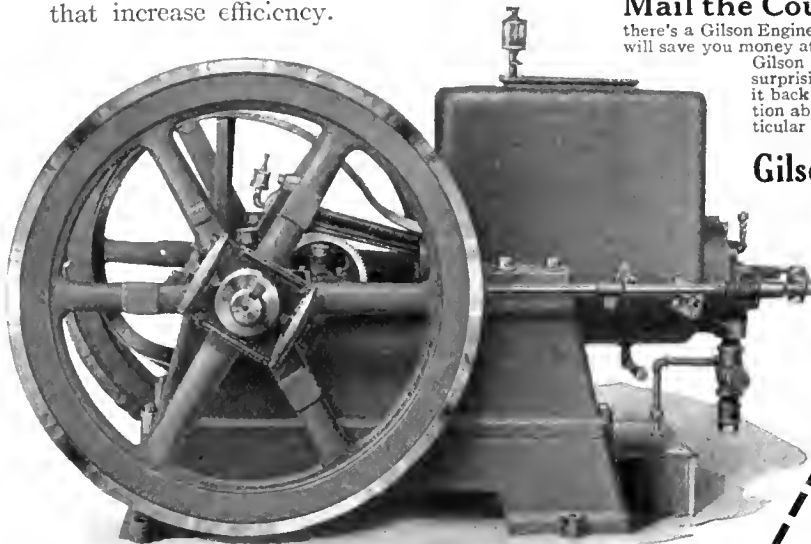

Gilson Manufacturing Company

76 Park Street

Port Washington, Wis.

MAIL THIS COUPON

Gilson Manufacturing Company
76 Park St., Port Washington, Wis.

I am interested in a Gasoline Engine
of.....Horse Power

Portable or Stationary

Name

Post Office

State

R. F. D. No.

Send me your Free Catalog and full particulars.



SECTION OF NEWCOMB FLUME ON UNITED STATES GOVERNMENT RECLAMATION PROJECT NEAR HUNTLEY MONT.

THE KLAUER GALVANIZED METAL FLUMES

ALL parts made entirely of
RUST RESISTING GALVANIZED IRON

NO WOOD
NO RIVETS
NO BOLTS
NO SOLDER



The most practical, simple and easiest
of all flumes to erect.

No Special Rolled Sheets
required for curves

Send us your inquiries

**KLAUER MANUFACTURING
COMPANY
DUBUQUE, IOWA**



International Harvester Oil Tractors

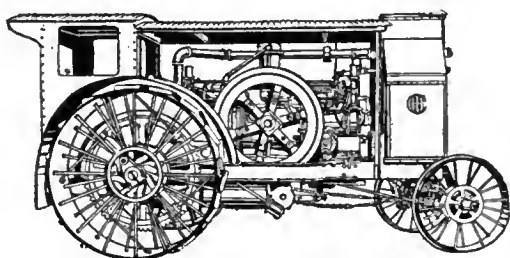

**GRAIN AND HAY
MACHINES**
Binders, Reapers
Headers, Mowers
Rakes, Stackers
Hay Loaders
Hay Presses
TILLAGE
Combination,
Peg and Spring-
Tooth, and Disk
Harrows
Cultivators

THE IHC LINE

**CORN
MACHINES**
Planters, Pickers
Binders
Cultivators
Ensilage Cutters
Shellers,
Shredders

GENERAL LINE
Oil and Gas
Engines
Oil Tractors
Manure Spreaders
Cream Separators
Farm Wagons
Motor Trucks
Threshers
Grain Drills
Feed Grinders
Knife Grinders
Binder Twine

THERE is work on your farm for an International Harvester tractor every week in the year. It will pull your plows, disks, drills, harrows, binders, haul your products and supplies, do road work, run your thresher, ensilage cutter, husker and shredder, concrete mixer, well drill, etc.

For best tractor service use an IHC oil tractor—Mogul or Titan. They are built to meet field difficulties. Their mechanism is simple. Moving parts are carefully protected. There is no unnecessary weight. They satisfy buyers.

IHC oil tractors—Mogul and Titan, are built in sizes for all farms, from 6-12 to 30-60 H. P., to operate on kerosene and gasoline.

Write for catalogues and other information on International tractors and oil engines and we will tell you where to see the machines.

International Harvester Company of America

(Incorporated)

Denver—Helena—Portland—Spokane—Salt Lake City—San Francisco

Champion Deering McCormick Milwaukee Osborne Plano



Be Independent! Why Not?

Install your own private pumping plant. Reduce your expense for delivering water to your land.

“The Deane of Holyoke” Pumps for Irrigation

are

An Insurance Against Failure of Rainfall

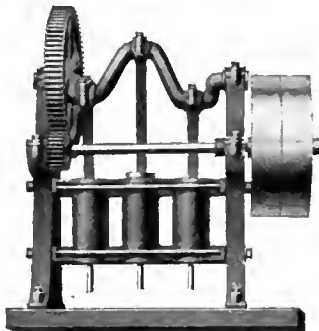

The type of pump illustrated (described in detail in Bulletin D228-89) is suitable for use in open wells where the water stands at considerable distance below the ground level. It is built in several sizes to fill the requirements of the farmer who is irrigating small plots, as well as the one operating on a larger scale.

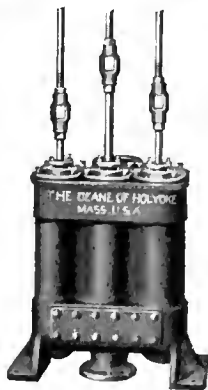

Fig. 2074

In construction it is simple, rugged and dependable—in design and material its quality is in keeping with its manufacturer's well-known high standards.

Write for Bulletin D228-89

Power Pumping Machinery

The Deane Steam Pump Co.

New York Office, 115 Broadway

Works, Holyoke, Mass.

Branch Offices in all Principal Cities

D278.8

IRRIGATION FROM WELLS



An Arkansas Installation. Layne Patent Screen and Patent Enclosed Line Shaft Centrifugal Pump.

With the twenty-three hundred successful working plants using our system of irrigation, which inoculates and energizes the dormant forces, there is now being produced in previously non-productive districts throughout the United States and in portions of Europe and Asia over eleven million dollars worth of FOOD PRODUCTS ANNUALLY. That our system is not an experiment is forcibly demonstrated by the fact that much of this production is from localities which were arid and barren previous to the introduction of our system.

Write for new catalog.

LAYNE & BOWLER COMPANY

Address nearest office.

The World's Largest Water Development Company

Houston, Texas

Memphis, Tennessee
Welsh, Louisiana

Stuttgart, Arkansas
Plainview, Texas

Jackson, Mississippi



International Harvester Tillage Implements

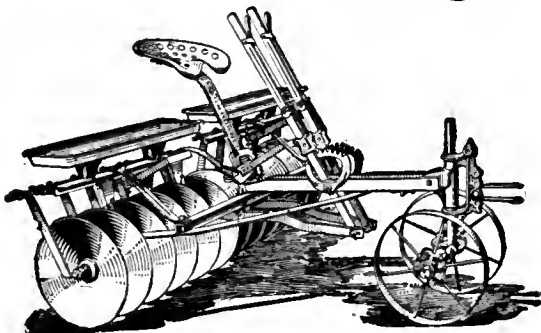

THIS year ten disk harrows will be sold where one was sold five years ago. Why? Because so many farmers have learned that the proper use of a disk harrow is the best guarantee of a successful crop.

Proper use of a disk harrow means the purchase of an I H C disk harrow, because they are the ones built to do the best work. The frames are strong, to stand the strain of following the binder or of slicing meadows. The set levers keep the gangs to their work at even depth. The bearings are the most durable that can be put on a disk harrow.

The full line includes disk, peg tooth, and smoothing harrows, drills and cultivators. See this line before you buy. We send catalogues on request.

"The Disk Harrow," a book which illustrates and explains the proper preparation of a seed bed, and gives examples of the value of disking—32 pages of valuable information—is yours for four cents to cover postage and packing.

GRAIN AND HAY MACHINES

Binders, Reapers
Headers, Mowers
Rakes, Stackers
Hay Loaders
Hay Presses

TILLAGE

Combination,
Peg and Spring-
Tooth, and Disk
Harrows
Cultivators

THE I H C LINE

CORN MACHINES

Planters, Pickers
Binders
Cultivators
Ensilage Cutters
Shellers
Shredders

GENERAL LINE

Oil and Gas
Engines
Oil Tractors
Manure
Spreaders
Cream Separators
Farm Wagons
Motor Trucks
Threshers
Grain Drills
Feed Grinders
Knife Grinders
Binder Twine

International Harvester Company of America

(Incorporated)

Denver—Helena—Portland—Spokane—Salt Lake City—San Francisco

Champion Deering McCormick Milwaukee Osborne Plano





WE SHALL be glad to mail anyone who wishes same, our free catalog. We sell our product through dealers and jobbers entirely and solicit inquiries from all dealers. Our goods are well and favorably known. They are standards in the United States Army and several other departments of the government.

Gold Medal Camp Furniture Mfg. Co.
 Racine, Wis., U. S. A.

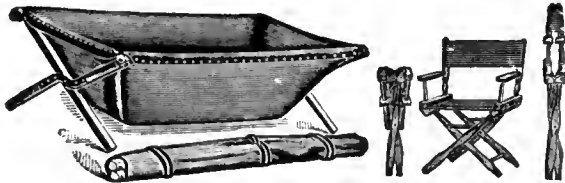

SUPERIOR



THE NAME TELLS A TRUE STORY

No matter where you live or what your seeding conditions are, you can get a SUPERIOR GRAIN DRILL that will fill the bill and do your work in the best possible manner. Superior Drills are made in all sizes and every style. Every Superior Drill is sold under a warranty that absolutely protects the buyer. Send for catalogue. Read it and go to your local dealer and insist on seeing the Superior Drill.

AMERICAN SEEDING MACHINE CO., (Inc.)
 Springfield, Ohio

GRAIN DRILLS

PAYS FOR ITSELF IN ONE MONTH



and Keeps on Saving You Money at the Same Rate Thereafter.

THE RECLAMATION DITCHER

Cuts Canals and Laterals for less than any other machinery—because it plows the dirt out with *One Continuous Sweeping Motion.*

We guarantee the cost per yard and prove it before you buy.

The J. D. Adams Mfg. Co.
 Indianapolis, Ind.



Delays Pay No Dividends. Mail This Coupon Today.

The J. D. Adams Mfg. Co., Indianapolis, Ind.

Below are descriptions of our proposed ditches. What will it cost per cubic yard to make them with the Reclamation Ditcher?

Length	Width in Bottom	Average Depth	Maximum Depth	Minimum Depth	Slope of Sides	Character of Soil

Name _____ Address _____



You Need Reliable Footwear

Why not get the best your money can buy? You save in the long run

Cutter's Cruiser's and Sportman's Boots

will meet your service requirements. This is our No. 106 16" Chocolate Chrome Sporting Boot—Hand made throughout.

Send today for illustrated booklet describing the Cutter line of Driving, Cruising and Sporting Boots.

*It
Will Pay
You*

A. A. Cutter Company

Eau Claire, Wisconsin

SAMSON TURBINE



When the PUMP cannot be direct connected to the turbine shaft, the power is usually transmitted by gears, shafting, etc. On account of the HIGH SPEED of the SAMSON, for a given power, lighter and consequently CHEAPER transmission machinery can be used.

JAMES LEFFEL & CO.

Springfield, Ohio, U. S. A.

316 Lagonda Street

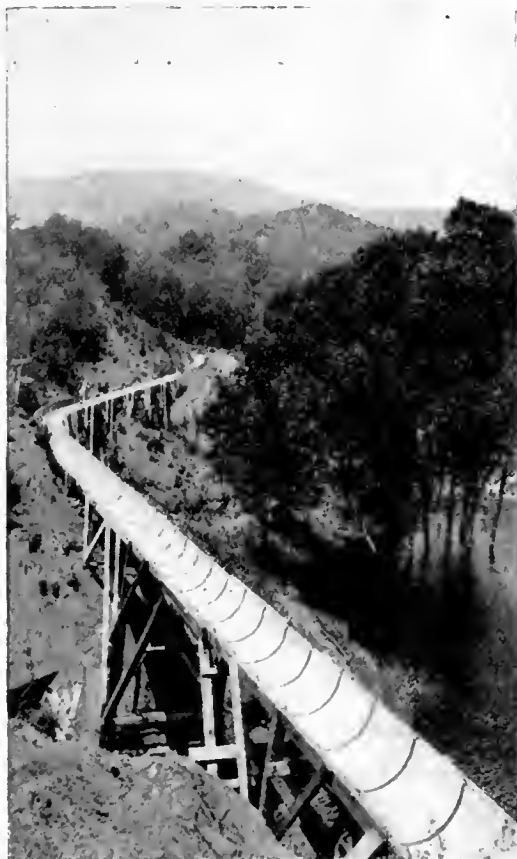

The Lennon Metal Flume

having the simplest and most practical of joints (requiring *no cross-bars* on the smaller and medium sizes, and but few on the larger) is

QUICKLY AND EASILY ERECTED

Its ideally smooth interior surface gives it the

GREATEST CARRYING CAPACITY

And when made from *American Ingot Iron* it has the

LONGEST SERVICE LIFE

For full information write the nearest manufacturer

List of manufacturers:

- | | |
|-----------------------------------------------------------------------------|-------------------------------------------------------------|
| California—Los Angeles & West Berkeley
California Corrugated Culvert Co. | Texas—El Paso
Western Metal Mfg. Co. |
| Colorado—Colorado Springs
Lennon Metal Flume Company | Texas—Houston
Lone Star Culvert Co. |
| Colorado—Manitou
Lennon Flume Co. | Montana—Missoula
Montana Culvert Co. |
| Nebraska—Wahoo
Nebraska Culvert and Mfg. Co. | Utah—Woods Cross
Utah Culvert Co. |
| Oregon—Portland
Coast Culvert and Flume Co. | Washington—Spokane
Spokane Corrugated Culvert & Tank Co. |
| | South Dakota—Sioux Falls
Sioux Falls Metal Culvert Co. |

This Book Shows How to Plan a Private Irrigation Pumping Plant

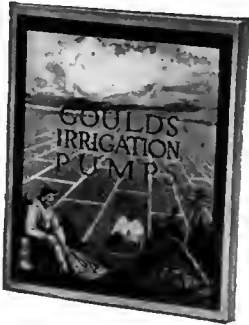

It also shows all of the various types of pumps to meet the conditions found in different localities, tells how to select the proper pump for your conditions, how to determine the amount of power you

will need and all the other things the irrigator needs to know.

One will be sent free on request as long as they last. Write today

THE GOULDS MFG. CO.
LARGEST MFR. OF PUMPS FOR EVERY SERVICE

174 Fall Street, Seneca Falls, N. Y.
Branches in All Principal Cities

EDWARDS REVERSIBLE 4 HORSE ROAD GRADER

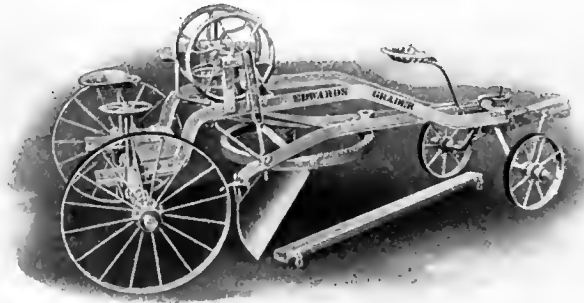

AN UP TO DATE MACHINE FOR BUILDING AND MAINTAINING ROADS

Having a complete line of adjustments it is equally well adapted for making ditches, both for dry land irrigation and rice field work.

I also manufacture THE RURAL ROAD GRADER and IRRIGATION DITCHER, STUMP PULLERS and other machines.

Write for descriptive catalog and prices.

C. D. EDWARDS, Albert Lea, Minn.

Our Radial Headgate



The best type of main headgate. Costs less by half than flat gates of equal area. Extremely rapid in operation. In use on the largest projects in this country.

We manufacture:

Main Headgates
Lateral Headgates
Gate Valves
Metal Flumes
Steel or Wood Pipe

We carry a complete stock of Wire Mesh and Steel Bars for Concrete reinforcement

Designs and estimates furnished on all irrigation structures and supplies.

Write us your requirements and full information will be sent.

Power Pumping Plants—Reasonable

Fitts-Kellihan Mach. & Const. Co.
Main Office, McPhee Bldg., Denver, Col.

The Faithful Friend

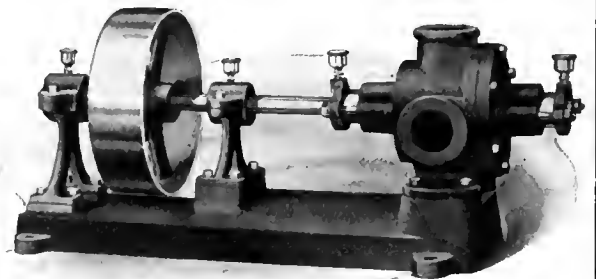

Do not be contented until you have the best, as these pumps have a good suction lift, with capacities of 12 to 500 gallons per minute, automatic take-up for wear, and free from springs or small parts that cause trouble.

SEND us your pumping proposition today, and let us quote you on the best pump made

Blackmer Rotary Pump Power & Mfg. Co.
PETOSKEY, MICHIGAN

Twenty-Ninth Year

THE IRRIGATION AGE

VOL. XXIX

CHICAGO, JUNE, 1914.

No. 8

THE IRRIGATION AGE

With which is Merged

The National Land and Irrigation Journal

MODERN IRRIGATION

THE IRRIGATION ERA

ARIZONA AMERICA

THE WATER USERS' BULLETIN

THE DRAINAGE JOURNAL

MID-WEST

THE FARM HERALD

THE IRRIGATOR

D. H. ANDERSON

PUBLISHER,

30 No. Dearborn Street,
Old No. 112 Dearborn St.

CHICAGO

Entered as second-class matter October 3, 1897, at the Postoffice at Chicago, Ill., under Act of March 3, 1879.

D. H. ANDERSON, Editor

ANNOUNCEMENT.

The "Primer of Hydraulics" is now ready; Price \$2.50. If ordered in connection with subscription \$2.00.

SUBSCRIPTION PRICE

To United States Subscribers, Postage Paid,	\$1.00
To Canada and Mexico.	1.50
All Other Foreign Countries,	1.50
In forwarding remittances please do not send checks on local banks. Send either postoffice or express money order or Chicago or New York draft.	

Official organ Federation of Tree Growing Clubs of America. D. H. Anderson, Secretary.

The Executive Committee of the National Federation of Water Users' Associations has taken action whereby THE IRRIGATION AGE is created the official organ of this vast organization, representing 1,000,000 persons on the government irrigation projects.

Interesting to Advertisers

It may interest advertisers to know that The Irrigation Age is the only publication in the world having an actual paid in advance circulation among individual irrigators and large irrigation corporations. It is read regularly by all interested in this subject and has readers in all parts of the world. The Irrigation Age is 29 years old and is the pioneer publication of its class in the world.

The Sale of the Irrigation Congress Must Be Stopped

On another page of this issue of THE IRRIGATION AGE, we print a letter from the secretary of the Western Canada Irrigation Association. He terms our protest against the sale of the Irrigation Congress to Canada as "feverish." He offers several reasons why the deal, which the Board of Governors of the Congress made with the Canadians, is proper. We print his letter because it is the policy of THE IRRIGATION AGE, no matter what may be its own views, to try to give both sides of any question.

The reasons offered by the Canadian letter writer present no valid excuse for the unpatriotic bargain which the Board of Governors made with the land boomers across the border.

The Irrigation Congress was organized to promote the interests of irrigation in the United States. It has been in the forefront of the development in the West. Its work is far from completed. It should be kept strictly as an institution of the United States and should go on with the noble work which it began.

We believe that through this Congress the United States should give to the world the best

thought of the nation on irrigation affairs. This the Congress has always done by inviting delegates from other nations to be its guests.

We believe the Congress should endeavor to obtain for the United States all the information concerning progress in irrigation affairs in other lands. This it has done in the past by inviting the irrigation experts of the world to appear on its programs.

There, we believe, its international work should end.

Because financiers and politicians in one American city, which had been awarded the Congress, quarreled among themselves over the expenses of entertaining the Congress, the Board of Governors and Secretary Hooker promptly danced across the border with this great organization. They were ready and anxious to dance to the Canadian's music because that music was the tinkle of dollars—a salary for Secretary Hooker, and plenty of expense money for "governors," whose "official" business might take them to the convention city frequently.

Nice for Secretary Hooker and the "governors." "Easy" for the Canadian land boomers, who have vast appropriations to spend to advertise their lands. Where could they buy cheaper publicity?

Where could they find better opportunity through which to carry on their insidious press campaign in the United States? The United States Congress exposed some of their methods of inducing United States citizens to settle on Canadian lands and invest their money in Canada. The Canadians needed a new method of access to the American press. The Irrigation Congress—a time-honored institution of the United States. And offered to them for \$10,000. Who wouldn't jump at the bargain?

THE IRRIGATION AGE does not blame the Canadians. They made a good business deal.

The odium of the deal is upon the American citizens, who sold the Congress.

It is not yet too late to stop this deal. It should be done without delay.

President Richard W. Young of the Congress, who lives in Salt Lake City, Utah, should call together the Executive Committee of the Congress at the earliest date possible, and proper steps should be taken to invalidate the contract made by the Board of Governors. If the expenses of the Irrigation Congress have become too heavy for the average western city of the United States, the Congress should return to its old organization with its public spirited non-salaried officials. Then almost any city will be able to entertain the Congress, and it can continue its great work under the United States flag, for United States people and in the interests of the great and still sparsely settled West of the United States.

The Irrigation Congress is an American institution and must be kept as such. If it cannot be, then once more we declare: "Better the Irrigation Congress die than be sold into slavery to the Canadian land boomers."

The Story of the Payette Homesteaders

It was shortly after the passage of the Reclamation Act in 1902 that they gave it a name—The Boise-Payette project. It was under that name that it was widely advertised by the Reclamation Service publicity department through newspapers and magazines, by glowingly written booklets and even picture shows. All these told of the vast possibilities which settlers would find on this wonderful government irrigation project in Idaho. Settlers began flocking in there in 1903, taking up land both under the Boise river portion and the Payette river section.

Then in true bureaucratic style the Reclamation Service rechristened the enterprise. They called it the Boise project. The Payette section was disowned. No money to build it was the excuse offered. Settlers on 95,000 acres of land

were left stranded—victims of a heartless bureau of their government.

Politicians obtained vast sums of government money to irrigate privately owned lands, but there was no money for the homesteaders on the Payette river. These homesteaders are real, red-blooded Americans and they did not quit. They have fought on. At the Denver irrigation conference recently, Comptroller Ryan of the Reclamation Service told representatives of the Payette homesteaders that if Secretary Lane could obtain from Congress a bill authorizing the issuance of \$100,000,000 in irrigation certificates—in other words a government loan—enough money would be allotted to complete the Payette project, now known as the Black Canyon Irrigation District.

The portion which the Payette folks would receive is admittedly small, but nevertheless it means life and realization of long deferred hopes for these homesteaders, and so every man and woman among them, fighting, patriotic, loyal citizens, have once more put their shoulders to the wheel to help Secretary Lane obtain this vast loan—a seemingly hopeless possibility in view of ever-increasing appropriations and Democratic promises of economy. Such a bond issue would mean development in the West that would be of lasting benefit to the whole nation. It would put millions of acres of idle, unproductive lands to work. THE IRRIGATION AGE would like to see this money made available. We believe it is the best investment this government could make. We also want to see it made available so that these sturdy folks in the Payette valley may come into their own.

These Payette homesteaders have proved themselves patriots under conditions that would make less strong-minded and courageous men and woman anarchists. Their story is a pathetic one, yet one to make every American thrill with pride.

One of these Payette country folks has written their story, which is printed on other pages of this issue of THE IRRIGATION AGE. In it is an appeal to all the nation to help the Payette homesteaders boost Secretary Lane's plea for a \$100,000,000 loan for Reclamation projects. Read this story by F. G. Burroughs. He calls it "A Story of a Hope Deferred." Then sit down and write to your Congressman. Tell him the story of these homesteaders. Urge him to help Secretary Lane obtain this vast loan, which he seeks. Tell him, too, to see to it that the Secretary is forced to so clean house in the Reclamation Service that no other American settlers will ever have to face such hardships because this bureaucracy may desire to serve some of its pet political interests.

**Put Your
Water Users'
Association
to Work**

The Federal Water Users on the Klamath project in Oregon are making plans for a co-operative bank, warehouses, refrigerating plant and grist mills. They are also discussing the idea of acting together in the sale of their produce and in the purchase of their supplies. They are putting their Water Users' association to work.

These undertakings of the Klamath settlers are tremendous in their possibilities and in their import. The farmers will have many obstacles with which to contend and some of their enterprises may meet with failure in the beginning, but they are bound to succeed in the end.

Co-operation has proven successful among farmers on privately constructed projects. It should prove even more successful on the government projects because of the splendid foundation on which the Water Users have to build. This foundation is the Water Users' association, to which if the government contracts are obeyed, every settler must belong. These associations have power of taxation. This is a big asset not enjoyed by the average organization of farmers. They have other comprehensive powers, which will aid greatly in the development of various methods of co-operation.

The settlers should have taken advantage long ago of the potentialities in their Water Users' associations. If they had, their financial condition would be much better today and they would be a happier lot of citizens. There is no question among economists but that communities so far removed from the markets as are the Federal irrigation projects must so organize as to be able to sell their produce in large bulk and when the markets are at their best if they expect to obtain fair profits.

The Water Users should not be buncoed by the latest cry of certain Reclamation Service officials, who fear the power of well organized Water Users' associations. These men, who desire to keep the associations empty, helpless shells, are now talking "neighborhood co-operation."

This is only another attempt to keep the settlers divided in little helpless cliques.

No small community of interests can accomplish such results in the development of markets, the handling in bulk of produce, the construction of warehouses, elevators, refrigerating plants and other equipment for marketing as can a co-operative body, such as a Water Users' association, made up of all the settlers on a Federal project. The interests of these farmers are not so diversified but that all can be served through the Water Users' association. The structure is ready. Put your Water Users' association to work.

**Pioneers
Are
Often
Forgotten**

Pioneers and leaders in great movements are often forgotten. Events move rapidly and the foundation work performed by sturdy and far-seeing men is covered up by the superstructure which fills the eye and blinds the sight to what it rests upon. For a little spell the Western Irrigation Congress at Denver gave recognition to two valiant workers in the cause of irrigation, two pioneers whose splendid achievements ante-dated Government action in the reclamation of desert lands. It was gratifying to those who know the true history of Western irrigation to have such recognition accorded to these men. H. L. Hollister of Chicago and I. B. Perrine of Idaho were at work in Southern Idaho when the idea of a large irrigation system had not been tried out. It was a new and bold conception to build a great dam that should divert a large river and with a canal a hundred miles long spread the water through a thousand miles of laterals over a dozen townships. Everybody acknowledged it was a grand idea, but those who were enthusiastic about it were not capitalists or bond buyers.

Messrs. Hollister and Perrine went about their work on the theory that somewhere the men with the money or means of getting it were waiting for them. No hunter ever beat the jungle with greater zest or more untiring spirit. Capital generally does not seek. It waits. It is the bride of enterprise. Not particularly blushing but coy, timorous, hesitating, ready at any moment to gather up her skirts and vanish like a puff of smoke, leaving her courtier not only astonished but nonplussed and in the direst extremity of not knowing what to do but seek another bride.

But, to shorten the story, Hollister and Perrine were money getters and they found the money for the magnificent development of the Twin Falls country which is now a reality and is their enduring monument. Not only irrigation but the large power interests were fathered and fostered by them. Fifty thousand people testify to their good judgment. Fifty millions of dollars could not now buy that country which a few years ago was an uninhabited desert. So many are the men who have made fortunes by the development of the Twin Falls region that it would be impossible to enumerate them. The towns that have been created, the homes that have been built, the farms and orchards that have been developed, the extensive hydro-electric power plants and transmission systems that have been constructed are objects of wonder and admiration. There has been grief—lots of it. There always is in large undertakings. But land values are going up all the time. Countless others are yet to make their

fortunes as a result of those first great ideas that had their incubation in the brains of Hollister and Perrine, nearly twenty years ago.

The least thought in the minds of these men when they began this work was to be given public credit for what they set out to do. It simply was in them to do big things and they did them, regardless of public applause. It was a very fitting thing, therefore, to have these two modest men given a bit of praise at the great irrigation conference in Denver, that they should be told that the public knows them and knows what they have done and are doing, and honors them for the great service to mankind and to the cause of irrigation and power development which they have performed.

"Me or Lane."

Secretary Lane Should Act Decisively "It is commonly reported about Washington that Mr. Lane will not be with the Service much longer." Director F. H. Newell left the above impressions with several men to whom he talked in the West recently.

What did he mean?

Does he believe that he is so firmly entrenched through his many years of political maneuverings and his dickerings with the Pinchot gang, that he is stronger today than the Secretary of the Interior, his superior?

Does it mean that he thinks he is strong enough to block any reforms in the Reclamation Service which Mr. Lane may try to make?

Does it mean that he has laid or is laying plans to take Mr. Lane's scalp, should the Secretary refuse to dance to his music?

Such a man is dangerous to any organization. He breeds insubordination, then anarchy.

Newell's disregard for the rights of the settlers is already well known. If his feelings for his superior, Secretary Lane, are of equal disdain, he should be removed immediately. The good of the Reclamation Service demands it.

Director Newell Opposes Section 16 F. H. Newell, director of the Reclamation Service, announced on at least two projects during his recent Western trip that he was opposed to the passage of the Reclamation Extension bill if it included Sec. 16.

This section, added to the bill in the Senate, gives the Water Users the right to ask the United States courts to decide whether the settlers must pay for the gross errors and incompetent work of the Reclamation Service, on many of the projects.

The best argument we have yet found in favor of Section 16 is the fact that Newell opposes it.

Doing an Injustice to Senator Newlands

The most recent letter received in this office from Secretary Arthur Hooker of the Irrigation Congress is written on a letter head bearing the name of Senator Francis G. Newlands of Nevada, as president of the organization. THE IRRIGATION AGE is informed that Richard W. Young, of Salt Lake City, Utah, qualified for the office of president of the Congress after the meeting in the Utah capital two years ago.

The use of stationery bearing Senator Newland's name as president in boosting the proposed session of the Congress in Canada is a great injustice to Mr. Newlands. It makes one of the most prominent senators in the West appear as an active party to the deal by which the Congress was turned over body and soul for a cash consideration to the Canadians. Senator Newlands, in justice to himself and to the great state of Nevada, should stop this at once. He cannot afford to be a party in any way to this nefarious deal.

Because of the appearance of the Senator's name on the Congress stationery THE AGE inadvertently mentioned Mr. Newlands' name in an editorial in the May issue. Many other publications which have protested against the Canadian deal have made a like error.

As one who has been president of the Congress and for many years one of its leading members THE AGE, however, once more urges Senator Newlands to take the leadership in the battle to keep the Congress an institution of the United States.

Federal Water Users on the Truckee-Carson project in Nevada were asked recently by the Reclamation Service to vote on the question of leasing the power developed by the Lahontan Dam. This action was taken after the bid of the Nevada Valleys Power Company had been rejected because of the low price offered. It is believed that a majority of the settlers will vote in favor of leasing the power, providing their interests are protected through provision in the contract that power shall be sold to the farmers at a reasonable profit above the cost to the bidder. The request for this referendum marks a big victory for THE IRRIGATION AGE, which has contended that the Water Users should have a voice in the affairs of their project.

Paris bankers have purchased \$500,000 worth of the million-dollar bond issue of the Brewster, Wash., Irrigation District. The balance of the issue will be placed in Europe, according to recent reports. Holland bankers recently took a big loan on fruit lands in the state of Washington. These deals indicate a return of confidence among European investors in irrigation securities of the United States.

BLACK CANYON—A STORY OF HOPE DEFERRED

By F. G. BURROUGHS, Caldwell, Idaho



James B. Newport, president of the Black Canyon Irrigation District.



Dr. F. M. Cole, President of the Caldwell (Ida.) Commercial Club.



Hon. J. M. Thompson, leader of Black Canyon campaign.

UNDER the name The Black Canyon Irrigation District it is probable that this project is but little known outside of Idaho. It is a legally organized District under Idaho laws, formed for the purpose of furnishing the machinery whereby irrigation of the lands within its boundaries may be undertaken under either Government or private auspices.

When the great Payette-Boise Project was undertaken by the Reclamation Service, the lands under the Black Canyon were included in the project and, in fact, it was generally expected that the construction works would be begun on the North Side, now called the Black Canyon, in which case the settlers on the other portion of the project, who are now enjoying the blessing of an abundance of water, would be in the position occupied today by the entrymen in the Black Canyon. The lands in the project, as originally laid out by the Government, embraced about 295,000 acres, divided 95,000 on the North Side and 200,000 on the South Side.

In 1903 the Government withdrew all the lands then embraced within the Payette-Boise Project. It was planned by the Reclamation engineers that the South Side section, now practically completed, should be watered from the Boise River and that the North Side, now the Black Canyon, should take from the waters of the Payette River.

Contrary to general expectation, the work was begun on the South Side, where the settlers have been receiving water for the past four years, and which, with the exception of the great Arrow Rock Dam, is completed, water being furnished under a rental system pending the completion of the dam and accurate knowledge on the part of the Govern-



M. H. Gibbons, Secretary of the Caldwell (Ida.) Commercial Club.

ment as to the actual cost of the great undertaking.

Naturally, as soon as the works were started, and it became known that construction work was being pushed by the Reclamation Service, settlers began to flock in. Quickly lands all over the whole project were entered, both on the north and south sections of the Project. These settlers came here because the Government had promised to furnish them with water. The lands on the whole project are very fertile and quickly all the best pieces were appropriated and the little two-room shacks of the homesteader began to dot the landscape.

Soon the big Deer Flat Reservoir was completed. Two big embankments cutting off the two outlets of the great natural basin were built and the water allowed to flow upon the land within the depression, making an immense reservoir with twenty-seven and three-quarters miles of shore line, from which the laterals are supplied today.

Meanwhile, the homesteaders on the North Side had been patiently waiting, fully believing that as soon as the works in hand were completed the Reclamation Service would turn its attention to those lands to be watered from the Payette River.

All of these people had a little money when they came, few have any now, but their sturdy American citizenship was evidenced by the courage and persistency with which they hung on to their homesteads and waited on Uncle Sam's pleasure. These home builders came here between the years 1903 and 1908, and many of them have endured hardships and privations that it would require the pen of a Dickens to adequately describe.

In that barren waste, where the sage-brush deserts, and the rolling hills only need the life-giving fluid to convert into beautiful and profitable farms, orchards and vineyards, the people have been denied all that makes life worth living. Only under the most strenuous conditions can the settlers and their little ones enjoy neighborly pleasures, schools or the comforts of religion. The savings of a lifetime, in many cases, have been expended in the erection of the little shelters they call home, and in clearing, improving and fencing their lands.

At the Denver Irrigation Conference, held recently at the call of Secretary Lane, the long-deferred promise of the Government to relieve these settlers was discussed, and conditions in the project were depicted. An instance was related which had been told by a Caldwell doctor, who had ushered a little one into the Black Canyon sage-brush world. The doctor told, with tears rolling down his cheeks, how the mother had sewn together a lot of rags, to cover the tiny body. Hon. J. M. Thompson, who described the incident, said: "Such unfavorable conditions for a little baby have never been known, unless it was the babe that was wrapped in swaddling clothes and cradled in a Bethlehem manger."

In 1909, Secretary Ballinger, at that time Secretary of the Interior, visited Idaho. The situation was explained to him by a delegation of the settlers themselves. Acknowledging the responsibility of the Government in the premises, he stated, however, that there were no funds in the possession of the Department to undertake the work. He said he saw no hope of getting the project under way for another five years and he advised that an Irrigation District be formed, so that if private capital could be secured to prosecute the work the settlers would be in position to make such a contract.

He assured the representatives at that time that such action would not in any way militate against



Settlers entering the meeting at Caldwell, Idaho, at which the Black Canyon campaign was opened.

large cost, formally asked the Government to make a contract with them, and proceed with the work. The answer came back that there were no funds available and that has been the reply to every effort made up to the present time.

These are the conditions under which the Government stands pledged to water the lands under the Black Canyon. Secretary Lane, Comptroller Ryan, and the Reclamation Commission as a body fully recognize the responsibility of the Government in the matter and have repeatedly stated that they favor the building of this project the moment that the funds are on hand.

During all these years the settlers have been waiting and hoping. Many of them are destitute, most of them are living from hand to mouth on the little they can raise by dry farming or from work they may be able to secure in the adjoining towns. In many cases conditions are pitiable, but faith in the implied pledges of the Government has never wavered. They are true Americans.

The Secretary of the Interior has asked for one hundred million dollars to be loaned to the Reclamation Fund by the Government. If the Congress of the United States concurs in this recommendation and the money is made available, the construction of this project is practically assured.

(Continued on Page 243.)



Governor Haynes of Idaho and state officials starting from Caldwell for a "booster" trip over the Black Canyon project.

ONE WAY TO REVIVE IRRIGATION BONDS

Excerpts from an Address Delivered at the Denver Conference by an Eastern Expert

By **EUGENE E. PRUSSING**

A Chicago Attorney.

MY presence here today, as I am a resident of Chicago and not of the State of Idaho, which I have the honor to represent in conjunction with the other members of a large delegation, is due first to the courtesy of Governor Haines, Secretary Jones and the managers of this Assembly, and second, to the fact that I have been for years and am now the legal adviser of two men who have perhaps done more for irrigation than any one in this generation, except that man whom we gratefully and affectionately acknowledge to be "the noblest Roman of them all," Governor Cary. The men I refer to are Ira B. Perrine, of Blue Lakes and Twin Falls, Idaho, the father of irrigation in that State, and Harry L. Hollister, of Chicago, his partner and friend. Between them, they brought twenty thousand or more of the best people in the world into the Twin Falls country in five years, established them in farm and city homes of the highest type and added \$25,000,000 to the taxable value of the State and ten per cent to its population and citizenship, by their faith in irrigation and sunshine and by hard work. To do this they advertised "Idaho and Sunshine" to the world, drew from it an army of sturdy pioneers, young, intelligent and well-to-do, and sold them \$18,000,000 worth of land.

The *moral responsibility* resting upon these two men to insure the future stability and success of the works upon which the great enterprises they launched are absolutely dependent—is my excuse for appearing before you—for "finally," as Carl Schurz tersely put it, "*every question is a moral question.*"

Now, if two men in private life, dealing with a highly successful project have so great a burden and so great a sense of moral responsibility, what must be the burden and responsibility of the Governors and other officers of the 15 States composing the Irrigated Empire, all of whom are inviting the immigration and investments of their Eastern fellow citizens to be made at the risk of faith and fortune, of happiness of wife and children and self, yes, in many cases, at the risk of life itself?

The source of these elements of immigration, and capital in money, energy and brains, is in the Eastern States and Europe, almost wholly. It must, therefore, be persuaded and brought, it cannot be driven into our States.

The necessities of the situation in our relations to the Federal Government, our need of financial help to complete the projects in hand and to create new ones are absolute and must likewise be solved with the help and sympathy, the votes and funds,



H. L. Hollister,
Chicago, Ill.



I. B. Perrine,
Twin Falls, Idaho.

and above all, the active friendly co-operation of the men and women of the East.

In dealing with our Eastern brethren, we must always remember that we are showing them not only our problems and troubles and seeking the solution of far off Western interests and policies, but that these problems are theirs as well, and their children's unto all the generations: that we propose to create a great field

for them, a market for their products and manufactures, for their capital and energy, and on that basis, namely, their interests, as well as their patriotism, and the glory of our common country—we are inviting and insisting upon their attention and help.

The resulting benefits, moral, political and financial to them and all of us, must be the basis and the only basis of our appeal. Let us not make the mistake of making sectional demands as local rights, if we hope to be successful with the nation. The good of all—should be our principle and hope, for we are appealing to those who comprise about 80% of the population and wealth of the country, and from whom we must draw not only immediate help, but our future population, and to whom we must sell 80% of our products. So they are our hope of salvation and success—and we must make them our friends and lovers.

Once we convince the intelligence of the country of the soundness of our plans and the rightfulness of our demands, then success is assured.

Persuade the thinking ten per cent and all the rest will follow. Let us, therefore, make a joint appeal to the judgment of those who can understand and will act upon their knowledge.

There is in the Eastern states a vast population of prosperous, ambitious and intelligent farmers and city people, the descendants of farmers, who have realized the need of a change in the policy of following ancient methods of farming and driving people to the cities. "Back to the Farm" is not only the call of the farmers, but the hope and the need of city people, and the Universities of the various States and their Agricultural schools, normal schools, vocational schools, farmers' institutes, with their thousand of yearly graduates, the Granges and the hundreds of other associations of farmers are preaching and praying in the new faith.

Let us address ourselves directly to these, our real constituents, and having convinced them and secured their favorable verdict, our cause will have become their cause and the rapid and complete remedy will follow.

For that remedy we need two more factors; Congress and Capital.

The chief reasons for favoring Congressional

legislation for irrigation by State and municipal agencies, as has been so well argued here by Governor Spry of Utah and others, are the effective supervision and keen interest of the people next to the land and their local officials. There is another, legislation recognizing State rights and co-operation in local matters is popular just now and easier to get.

There is a third reason; it is the right policy, and under proper restraints, it should prevail.

I pass now to the question of Capital.

There are probably \$25,000,000 of our irrigation securities, created within ten years, now in default; these are held by our brethren in the East or by insurance companies and banks who represent widows, orphans and poor, saving people. You would be amazed if you knew how many are owned by farmers. Behind these securities stand the investment bankers, who, so long as those securities remain in default, will return a firm, though polite NO! to every application for further loans, and the whole country East of the Missouri River is of the same mind. This is the first condition the Eastern people think should be remembered and remedied.

The present condition in this respect is the direct result of the debauch in irrigation projects which swept across the country and almost swamped the financial markets from 1904 to 1910. It resulted in many of the failures and losses of the last four years, precisely the experience of the canal and turnpike schemes of 1825 to 1840, and the railroads from 1840 to 1870, which largely contributed to the great panics of 1837 and 1873. We are fortunate in the fact that the country, now grown rich and great, has been able to swallow and digest the dose without a panic and this in spite of its increase caused by the great industrial expansion in the East and the war panic in Europe. The lesson to be gained is the knowledge and assurance that we are a financially great nation, though not yet independent.

This gives us the right to hope and expect the recovery of a market for our securities, but it must be under different conditions, and I hope and believe it will be on better terms.

Now what of the Hope.

One of the immediate and greatest results of the Irrigation slump was the organization of the Investment Bankers Association of America, composed now of nearly 500 of the best financial houses in the country, including the bond departments of all the great banks, as well as the true bond buyers and distributors.

It is this organization which we must reckon with and satisfy. Fortunately it is composed of intelligent, earnest and honest men, who are willing, yes anxious, to be convinced. This association, once convinced, is all that we need financially and it will be the greatest possible help not only financially, but in every direction in colonization, legislation and markets.

Now what is needed to persuade the Investment Bankers' Association?

Well, first of all, character. The present reputation of irrigation securities issued in most part by private enterprises but also by local municipalities,

is, as the result of many failures, utterly bad, and chiefly, though not wholly, because of the incompetent, reckless and dishonest nature of their promoters.

We must substitute a different class of promoters. In place of the private exploiters and incompetent and dishonest managers, we must bring forward public or publicly supervised and regulated enterprises, so guarded as to convince the bankers that the future will not be like the past. We must supplement this with legal safeguards, free from appeals or reversals by courts or local prejudice, or future political changes or economic changes, so that the investor who surrenders and risks his all for a small return that we may make all the profit, may be perfectly assured that not he, but we, take the risks of the investment, and that the community honestly, promptly and efficiently will yield him his return and enforce his rights.

What is necessary to this end?

First: The establishment of competent and efficient boards of engineering and farming ability under State control.

Second: The adoption of sound principles and policies, according to the needs of different localities and their establishment in permanent form.

Third: Co-operation, and the standardization of methods of financing and payment.

Fourth: The creation of State or municipal agencies to determine upon each improvement as a local matter and then the commitment to the State of the registration of the securities issued in such way, that they will be forever after free from attack, and secured by the power, the policy and disposition of the State to enforce the levy and collection of the taxes for their payment, both interest and principal, without requiring State or other guaranties—so that local jealousies and diversity of interests may be avoided.

The first and second conditions precedent which I have mentioned have received ample discussion in this conference, and I need not comment on them again.

First, then, I speak of co-operation in publicity and financing. The irrigation States constitute for this purpose one community and should recognize first of all this fact, and the permanent value of co-operation, the strength there is in unity of purpose, methods and effort. Establish an amply supported bureau, maintained in common by and for all the States to deal with the public and the bankers' organizations, and employ only the best advertising, legal and financial talent obtainable, scientific, non-partisan and able—and pay them well.

The States, co-operating through competent agents, must harmonize their own differences and plans and standardize and make uniform their proposed methods of finance. They must adopt general principles and forms, as to amount of bonds, forms of securities, sinking fund methods, length of time and rates of interest, so that there will be harmony of purpose and effort and no unfair competition of one with the other.

Assuming its practical value, the project should be a local enterprise, locally desired, conceived and

(Continued on Page 244.)

The Federal Water Users



A Department Devoted to the Interests of the Farmers on the Government Irrigation Projects

EDITED BY GEORGE J. SCHARSCHUG

MYSTERIOUS LOBBY FIGHTS THE 20-YEAR BILL

President Agrees to Help Bill; Another Vote June 15

WESTERN congressmen are confident the bill extending the water payments on the Federal Reclamation projects to cover a period of twenty years will pass at this session of Congress.

They are not discouraged by their failure in their first attempt to put it to a vote. Neither are they disheartened by their lack of success in trying to induce the Democratic caucus to place the measure on the "must be passed" list.

President Wilson's aid was sought. He promised Congressman Taylor of Colorado, and others, that he would urge the House leaders to force the bill to passage. Speaker Clark was induced to place the bill on the "suspension calendar" for Monday, June 15.

Under the rules of this calendar, it will require a two-thirds majority to pass. The introduction of amendments to the measure is not allowed. This means a fight, as Representative Borland of Missouri, is determined that the bill shall not pass unless it contains a clause providing for the submission of annual estimates of expenditures to Congress. He also demands the elimination of Section 14.

The opposition to unanimous consent for action on the bill caused grave fears for its success in the hearts of some of the officials of the Interior Department and Reclamation Service, who are anxious to see the bill passed. Hurried calls for aid were sent out. Many organizations in the West were also aroused to immediate action by the opposi-



"Just Spuds." This forty-acre field of potatoes near Carbondale, Colo., averaged close to 500 bushels per acre.

tion displayed toward the bill. Congress is once more being bombarded with insistent pleas for favorable action on the measure.

A very strong and somewhat mysterious influence is reported to be at work in the House to cause the defeat or abandonment of the bill. The exact cause of this has not yet been uncovered.

From one source comes word that the opposition is being fostered by big land holders on the Federal projects. The bill is considered far more drastic than the original Reclamation Act in the powers it confers upon the Secretary of the Interior for the removal of the speculative element in the projects and the cutting down of all individual holdings to the farm units designated for the projects.

Members of the House seem determined that the court jurisdiction amendment, known as Section 16, which was added in the Senate, shall be eliminated. Led by O. E. Farnham, of Newell, S. D., secretary of the National Federation of Water Users' Associations, the settlers on many of the projects have been making an active fight for this section. The campaign has been carried to all parts of the nation, and many promises of aid have been received. The Water Users generally feel that they should have some means by which they can ask the protection of the courts without resorting to the subterfuge of starting such suits as will force the government to intervene.

The House irrigation committee eliminated the section on the plea of the Reclamation Service. A. R. Honnold, local attorney for the Service at Den-

ver, Colo., made the argument against the court amendment.

Chairman Smith also presented these documents as a final clincher against the amendment:

"My Dear Mr. Smith: In relation to Senator Sterling's amendment to the reclamation extension bill (S. 4628), I inclose copy of memorandum from the chief counsel for the Reclamation Service.

"Personally I see no reason for the adoption of this amendment.

"Cordially, yours, Franklin K. Lane."

"Department of the Interior,
"United States Reclamation Service.

"Memorandum for the Secretary:

"The proposed amendment of Senator Sterling to the

reclamation extension bill (S. 4628) is objectionable in the following particulars:

"1. It will produce great confusion, as the United States district and appellate courts may make decisions wholly inconsistent, which must govern within their several jurisdictions until the Supreme Court has decided the specific question.

"2. Any water users' association or irrigation district may bring suit and delay the application of necessary rules and regulations. In many such cases the Secretary must either refuse to furnish water or furnish it without payment for an indefinite period.

"3. It confers no rights on the United States that it does not now enjoy. The water users and water users' associations have now the same rights of suit as other persons dealing with the department under the public-land laws.

"Will R. King, Chief Counsel."

CONGRESS PROBES RECLAMATION SERVICE

The Irrigation Age Wins Fight for Investigation; Newell's Job in Peril

The lid is off.

The Reclamation Service is under Congressional investigation.

The repeated demands of THE IRRIGATION AGE for a thorough house cleaning of the Service have borne results.

The sub-committee on Permanent Appropriations of the House Committee on Appropriations, of which Representative Borland of Missouri, a Democrat, is chairman, is making the inquiry. In opening the investigation before his committee, which, it develops, is the only one in Congress charged with the investigation and supervision of such permanent funds as the Reclamation Fund, Chairman Borland declared:

That the Reclamation Service is in a stage of stagnation.

That the intent of the Reclamation Law has been violated in many important respects.

That the Reclamation Service is sadly in need of reorganization.

That much of the land on the Federal projects is in the hands of speculators.

As a basis for the reorganization of the Service, Mr. Borland said it was important that Congress should be informed fully as to the expenditures which have been made on the project and the utility of these enterprises.

Hearings on alternate days were opened immediately, and Reclamation Service officials are being questioned as to the estimated and actual costs of each project.

Mr. Borland states that Federal Water Users will also be permitted to testify, if they are present when their project is taken up. As Water Users have had practically no notice of the inquiry, few, if any, have had an opportunity to present their side of the Reclamation problem.

Mr. Borland has been pledged the thorough support of Water Users on a number of projects, providing he leads a complete investigation of the Reclamation Service, and it is believed that he will arrange to give the Water Users a thorough hear-

ing. Pressure is being brought to bear upon him to prevent such a hearing.

The Missouri Congressman insists he is sincere, and is going to the bottom of the matter. In rather vague letters, he has invited the co-operation of all the Federal Water Users' associations in helping him obtain changes in the method of handling the Reclamation fund.

There is still a lot of mystery surrounding the investigation and Mr. Borland's exact purposes. There are some in Washington who pretend to see the hand of the administration behind it. They declare it is the first move by Secretary of the Interior Lane to clear the Service of F. H. Newell, director; A. P. Davis, chief engineer, and others who have been the head and front of the bureaucracy, whose reign has become insufferable to the settlers. They declare that the acts of the Reclamation engineers have cost the government more than \$40,000,000—expenditures from the Reclamation fund on the various projects, which the settlers under any rule of justice cannot be forced to pay back into the United States treasury. They declare Secretary Lane has come to realize that under his proposed revaluations, at least a very large proportion of this vast sum lost through errors, waste and incompetency must be charged off, if the revaluations are honest, and that he wants to be in position to place the blame for this enormous loss to the government.

Certain it is that Mr. Borland is a very prominent Democrat in the House and on very good terms with the administration. To this fact those who believe the administration is behind the inquiry, add these other pertinent and significant facts:

Sir William Willcocks, builder of the Assuan dam in Egypt, which stores water for the greatest irrigation project in the world, has been retained as consulting engineer for the Reclamation Service. Sir William is now in the West inspecting the projects. He is accompanied by W. A. Ryan, comptroller of the Reclamation Service. According to President Wilson's own announcement in appointing him, Mr. Ryan is the confidential man of Secretary Lane on the Reclamation Commission.

POINTS WEAK SPOT IN RYAN'S REASONING

BY EARL B. SMITH

Chairman of the Executive Committee of the National Federation of Water Users' Association.

HON. W. A. RYAN, one of the government Irrigation Commissioners, has a very finely written article in the April issue of the Reclamation Record on the extension bill, covering the point providing for the incurring of additional indebtedness by vote of majority of the landowners. He illustrates as follows:



Earl B. Smith
Sommerton, Ariz.

"A majority votes to incur a drainage debt of \$25 per acre provided it may be paid in added installments after the twenty-year period as provided in Section 4 of the bill."

Then he works out in detail how the payments are to fall due

on a certain tract of forty acres.

Mr. Ryan's illustration is clear, able and very satisfactory providing other conditions permitted his illustration to be carried out, and I think Mr. Ryan has inadvertently lost sight of the ruling of the department that will cause his illustration to utterly fail. Suppose we vote an additional expenditure of \$25 for drainage or other improvement. This must be based upon an estimate of the cost by government engineers. The ruling which kills the whole illustration is found in the answer to question 91 in the booklet of "Questions and Answers" which is that the estimate for the construction charge shall be made when the work is sufficiently advanced to make an accurate estimate of the cost instead of the estimate made in the beginning and upon which the *vote was obtained*. Yuma's vote to have the project constructed was based on the estimate of \$35 per acre. The amount expended so far is about two and one-half times \$35 and the work only about 65 per cent completed, and the Service claims we must pay the total expenditures regardless of the original estimate. Now, if we vote an additional \$25 for some improvement and the Service expends \$65 or \$75 per acre on such work, and the same rule of construction prevails, then we are obligated to pay \$65 or \$75 per acre instead of \$25. With this rule of construction what becomes of Mr. Ryan's illustration?

The above comment of course leads directly into the great question of "estimated cost" which I do not wish to discuss at this time or until the Commission makes some final determination of that matter, except to say that such rule of construction

of the words of the law that "*the charges shall be made with a view of returning to the fund the estimated cost,*" unsettles all land values, blocks all reasonable loans, puts a cloud on our titles and keeps everything in a condition of financial uncertainty. Is it any wonder that intelligent farmers are afraid of government projects? Is it impossible for the government to construct works of this character without financial irresponsibility to those who vote the indebtedness? Something must be wrong.

Because Mr. Ryan's article, in my estimation, fails, is no reason why I think he may not become a very useful member of the Commission and I do not wish him to understand that I am complaining of his work, but my motive is to give him the views of some Water Users for his assistance if such are acceptable. Will Mr. Ryan try again to explain the bill, in a way that will work out?

DAVIS BLAMES SUBORDINATE

Arthur P. Davis, chief engineer of the Reclamation Service, has apologized abjectly for his attack on the financing of the Greeley-Poudre Irrigation District in Colorado. He has retracted the statements he made concerning the project. He blames a subordinate for his misstatements and untruths.

The Davis retraction came after Delph E. Carpenter, attorney for the district, had announced that he would file charges with Secretary of the Interior Lane.

Just what class of Reclamation Service employe, this "subordinate" who misinformed Davis was or by what right Davis uses government officials, whose salaries are paid by the Water Users, to collect information for, his articles in magazines, neither Davis' official retraction nor a letter from Attorney Carpenter state.

454 U. S. PROJECT FARMS STILL OPEN

A census of the farm units on the several irrigation projects of the Government shows that in the twenty-five projects there are approximately 26,000 occupied farms, varying in size from 5 to 160 acres each, and 454 units of 40 to 80 acres each, still open to entry.

These farms are located as follows:

Idaho, Minidoka project, 58; Montana, Huntley project 42, Lower Yellowstone project 18. Sun River project 45; Nebraska, North Platte project, 23; South Dakota, Belle Fourche project, 65; Wyoming, Shoshone project, 203.

BEGIN NEW CAREY ACT PROJECT

Construction of the Leach irrigation project in Routt county, Colorado, has begun. It will cost more than \$1,000,000 and will water 60,000 acres.

KLAMATH WATER USERS PLAN FARM BANK

By **ABEL ADY**

(President of the Klamath Water Users' Association)

MEMBERS of the Klamath Water Users' Association have organized their first co-operative creamery. Others will be formed.

Sentiment is very strong among the Federal Water Users on the Klamath project for the organization of a co-operative farmers' bank.



ABEL ADY
Midland, Ore.

The Water Users are also considering the establishment of co-operative warehouses, flour and feed mills, a cold storage and warehouse and co-operative buying and selling of all commodities.

Most, if not all, of these activities will be handled through the Klamath Water Users' Association, one of the most active of the Fed-

eral project organizations.

The settlers on the Klamath project are awakening rapidly to the necessity of co-operation for mutual protection. They are especially interested in the creation of their own bank from which they can obtain money at a fair rate of interest.

Experience has demonstrated that twenty-five per cent of the deposits being held in reserve in the banks will take care of daily checks, resulting from business contingencies. The remaining seventy-five per cent of the deposits can be held in reserve for contingency loans to the farmers who have no deposits.

This can be accomplished by a fair system of private banks receiving farmers' deposits. When the farmers' deposits are withheld from loans to farmers who need temporary loans, the result becomes an outrage upon the entire farming community.

The deposits in private banks on the Klamath project aggregate one-half million dollars, of which a large percentage is farmers' money, and yet the farmers who have no deposits can not secure loans from these banks at less than ten per cent interest, and few farmers are able to secure loans at any rate or on any security.

The cattle and grain buyers and other middle men secure loans from the private banks up to the limit permitted by law, and the farmer, being unable to borrow money for his necessary uses, must sell his cattle, grain and farm produce to the middlemen at rates that are nothing short of legal robbery.

These conditions would not be so open to condemnation were it not for the fact that the middle-

men drive their usurious bargains through forced sales from farmers, with the use of farmers' money borrowed from private bankers, while farmers are unable to borrow money at any rate.

This combination of bankers and middlemen has exploited our settlers until many of them are lying awake nights reckoning the time when they will have to give up their farms.

The extension of time of payment of construction charges by the government will not save the farms for the farmers unless the grip of bankers and middlemen is torn from the farmers' throats by co-operation of the farmers in banking, marketing and buying together with co-operative packing houses, flour and feed mills, and other enterprises for preparing the farm products for delivery direct to the retailers.

The desperate struggle of the money sharks, middlemen and other exploiters to prevent the farmer from getting on his feet through co-operation is the best possible evidence that the farmers are making attempts along the right lines, and our settlers have sufficient horse sense and grit to continue the struggle and complete their needed self-protection by mutual co-operation in all their financial affairs.

The exploiters are thoroughly organized into banks, lumber companies, power companies and all manner of associations for successfully farming the farmers, and the farmers must organize for self-protection or become serfs.

The farmer is beginning to exercise the gray matter of his own brain in the administration of his own affairs instead of delegating such affairs to the most successful exploiter.

The farmer can more safely farm his own affairs than to delegate them to those, who have become rich by farming the farmers.

The organized exploiters do not use dynamite, but their subtle game is more successful than any dynamite method ever employed.

Our defense is co-operation in our own affairs.

INGOT IRON INVADES ENGLAND

The American Rolling Mill Co., of Middletown O., has invaded England. George H. Charls, director of sales, and R. B. Carnahan, vice-president and chief metallurgist, have succeeded in closing up two license contracts, under which the Shelton Iron, Steel & Coal Co., of Stoke-on-Trent, and Richard Johnson & Nephew, Ltd., of Manchester, secure the privilege of using the American Rolling Mill Company's method of producing Ingot Iron.

ASK STATE TO BUY IRRIGATION BONDS

The Irrigation District Association of California has begun the circulation of petitions to place before the voters next November an amendment to the state constitution, providing for the purchase of irrigation bonds by the state.

OGDEN OFFERED TO ENTERTAIN THE CONGRESS

THE Irrigation Congress was sold to Canada despite the fact that Ogden, Utah, stood ready to entertain it.

The plot to turn the Congress over to the Canadians was not revealed until after prominent Ogden men had pledged sufficient funds to finance the convention.

These two facts, which cannot be denied, stamp the statements of certain officials of the Congress as deliberate untruths. These officials gave as their excuse for sending the Congress to Canada their failure to find any city in the United States which would entertain the Congress.

The Ogden Examiner, in a recent editorial, says:

"There is no use crying over spilled milk and locking the stable after the horse is stolen does not bring back the horse but—

"By all means the Irrigation Congress should have been kept at home and by every right it should have been held in Ogden this year.

"It was revived by the men of this city through the persistent leadership of Fred J. Kiesel after Phoenix failed to make good and the officers made little effort to find another place to hold it. Ogden came to the rescue with an offer to entertain the congress and help to make it a permanent institution. The Examiner put the proposition squarely before the public—showed the value of the Irrigation Congress to the semi arid west and the absolute necessity of reviving it—the Weber club responded to the call and at the Logan Roundup the best men in Utah pledged their support to holding the Congress in Ogden this year. Then the officers who had been silent so long came out with the statement that it had been virtually promised to Canada."

After quoting in full an editorial from THE IRRIGATION AGE protesting against the sale of the Con-

gress, the Examiner continues:

"And the IRRIGATION AGE speaks the sentiments of many men of the West who have held their tongues in the face of this unfair deal. Utah is the home of irrigation. Here it was cradled and nurtured until stalwarts from every land came and knew that the desert was a valuable possession. There would be as much reason in holding the Panama-Pacific exposition in China as there is in sending the Irrigation Congress to Canada for a mess of pottage."

In another editorial the Examiner says:

"Why don't they publish the proceedings of the Irrigation Congress held in Salt Lake two years ago?"

"This question has been put before but each time it has been tabled or given an evasive reply. One answer has been that they did not have the money to pay for publication. This answer, however, is not satisfying enough to appear sincere.

"How much will it cost?"

"Would not it be possible to put Secretary Hooker on low gear and clip enough off his generous salary and joy riding expenses to pay for printing the report?"

"Wouldn't it?"

"When Salt Lake entertained the Congress she came to Ogden looking for funds to help defray the expense and this city donated \$3,000. From its birth we have been vitally interested in the Congress—yes, and financially interested—therefore we have a perfect right to ask these questions.

"Send the Irrigation Congress to Ogden and we will give you a bond that the proceedings will be published in full. Nor will you have to wait two years for the report either. The spirit of the West demands fair play and publicity in matters so vital to its growth and development.

"Ogden stands by the home of irrigation."

SOME CENTRIFUGAL PUMP POINTERS

SATISFACTORY results from pumping machinery for irrigation purposes depend to a great extent upon its careful installation and operation. The following are some of the important points to bear in mind:

Suitable foundations are necessary for satisfactory continuous operation. The foundation may consist of any material so long as it is stiff enough to support the bed-plate at all points and maintain proper alignment of the shafts if they are not otherwise properly supported.

If the pump and driving motor or engine are mounted upon the bed-plate and coupled together, they should be placed upon the foundation with suitable wedge under each end. The middle of the bed-plate should be raised or lowered as necessary,

until the edges and faces of couplings exactly agree. Both pump and motor should run freely when separate, and when coupled together with the bolts. The bed-plate should then be grouted into place, so that it is absolutely rigid. The suction and discharge piping can then be connected. These pipes should be a size or two larger than the suction and discharge opening of the pump if they are of any great length. Care should be taken to see that there are no air pockets in the suction well, as there is less trouble in priming the pump and less liability of air leakage in the suction pipe when the suction lift is small.

To prevent air leakage through the stuffing box on the suction head of pump, there should be provided a gland cage within the stuffing box, on each

side of which there should be placed about three rings of graphite packing. On the outside of the stuffing box should be a $\frac{1}{4}$ -inch pipe tap, which connects to this gland cage. There should be a pipe tap, thus making a water seal in the stuffing box and preventing all air leakage. The gland should be run just as loose as possible, as otherwise the packing is liable to cut the shaft. A small amount of leakage from the stuffing box does not harm, in fact is an advantage, as it prevents the packing from heating and at the same time keeps the shaft lubricated.

The pump should always be primed before

starting, as otherwise there is liability of injuring some of the interior parts of the pump which depends upon the presence of water for lubrication. The pump can be primed either by closing the discharge by means of a gate or check valve, and exhausting the air from the pump by means of an ejector or air pump, thus allowing the water to flow in from the suction well, or a foot valve can be provided on the suction pipe and pump filled with water, at the same time allowing the air to escape from the highest point of the pump.

(Continued on Page 250.)

HUNTING HIGH COSTS IN IRRIGATION PROJECTS

BY A. H. LONG

IF the users of water in the irrigation districts will give some thought as to why a material carrying premiums of \$16.00, or more, per ton is specified for irrigation work and road culverts, when not one of these premium metals has been on the market long enough to justify its adoption on the grounds of superior wearing qualities, regardless of price, they may find a suggestion of the cause of their disappointments in the matter of costs of irrigation projects, road building and other public improvements carried on under the supervision of not only the U. S. Government, but of state governments and other municipal bodies.

How much consideration would an individual, constructing a piece of work of any kind, who had to pay the bills for all material and labor from his own pocket, give to the claim of a metal the merits of which are based entirely upon its so-called purity, and citing as authority the purity of ancient irons which, by analysis, show anything but purity as understood by metallurgists, and which same ancient irons, when worked under modern processes, show no value whatever over the products that can be purchased on the open market today? Most men would not give consideration to such metal at an even price when they learn that the longest period of life that such metals have a record of is not more than one-third of that of thousands of examples of standard Galvanized and Black Open Hearth sheets which are still in good condition. They might give some consideration to these so-called "pure irons" if they could show a record uniformly good, but if they will take the trouble to make an investigation they will discover that actual tests of these so-called "pure irons"—even in the limited period they have been on the market—show no better results on the average under similar conditions of exposure than the ordinary standard Bessemer or Open Hearth Steels.

If the investigating bodies so numerous throughout the country, as well as the economic writers on the subject of the high cost of living, would give their attention to some of these causes for increased taxes all along the line, from county to federal, not only as to the material specified for, but as to the methods of conducting public works (honestly in

most cases, no doubt, but ineffective by reason of lack of expert knowledge), they will find at least a part of the solution of the problem that is interesting the whole world today.

As one having an indirect connection with a concern engaged in the construction of irrigation ditches, flumes, etc., the above thoughts have been suggested to me by an article in the March issue of THE IRRIGATION AGE, entitled, "Road Culverts and Siphons."

There is no disputing the logic of the claims made for Corrugated Metal Culverts, but the article referred to is, fundamentally at least, written in an effort to promote the use of the so-called "pure irons," and there is today no greater medium of extravagance—for want of a better name—than the use of these products of open hearth steel furnaces, called "pure irons."

I quote the following paragraph from page 151:

"It is generally conceded that iron or steel rusts in proportion to the amount of impurities present. Iron produced by the painstaking and laborious methods of long ago has endured through many years of trying exposure. The links used in the construction of the Newburyport (Mass.) bridge in 1792 are today in an almost perfect state of preservation. The reason for this appears when an analysis of these old links shows them to have been made from remarkably pure iron."

The Newburyport bridge links are not the only examples of ancient irons showing remarkable length of service without serious corrosion, but all of these, as can readily be ascertained upon investigation, are anything but pure from the standpoint of the advocates of these present-day so-called "pure irons." Their claims indicate that there is a close similarity in the composition of their metal to that of the Newburyport bridge chains, whereas the only similarity between them is in the low manganese which, in a strict sense, is not an impurity, but, on the contrary, a high-priced element deliberately introduced in varying quantities into all first-class mild steel, and the discovery of the properties of which was what gave to the world one of its greatest factors for progress, namely, "soft" or what is also known as "mild" steel, and to which the Germans originally applied the term "Ingot Iron." It was the discovery of the use that could be made of manganese which brought about the production of this soft, workable steel or ingot iron,

thereby giving to the world a product having 20 per cent greater strength and elasticity than the best of iron and did away with the old slow, hard labor of the puddling furnace.

These ancient irons, including the Newburyport bridge links, contain many elements that always have been, and are today, recognized as impurities. For instance, they show 30 or 40 times as high phosphorous as the so-called "pure iron" or open hearth steel of today; 20 or 30 times the percentage of silicon, and a high percentage of slag and cinder, of which there is practically none in the modern so-called "pure iron," yet these ancient irons have shown remarkable resistance to corrosion with all these impurities. But appealing to the feeling brought about by an occasional failure of soft steel to resist corrosion as long as it was expected (and in most of these cases the result has been due to lack of care or extraordinary conditions under which no metal other than copper or copper alloys which have shown any better results) they have claimed the purity of these old irons as being the cause of their remarkable records. Incidentally, they have obtained premiums for their material ranging from \$16.00 to \$23.00 per ton for material which, as a whole, is no more of the same composition of these ancient irons than is any of the thirty-one million tons of soft steel made in 1912. The production of steel ingots and castings has risen from seven million tons in 1897 to thirty-one million tons in 1912, and has anyone heard of any failures of the material for any cause whatsoever to justify the payment of such premium as is asked for so-called "pure iron?"

Referring again to the Newburyport bridge chains, to which so much prominence is given in the article referred to, even Dr. Cushman—who might be termed the "father" of the so-called "pure iron"—has told of taking one of these links and treating same as a sheet bar, heating in a reheating furnace in the mill and rolling same down to No. 16 gauge sheets, and that these sheets were then exposed to various corrosion tests and put out in the weather, and it was found that some of these samples were of no more resistance to corrosion than the regular run of modern samples with which they were exposed. This treatment did not change the manganese content of these samples, which would seem to be conclusive evidence that, contrary to claims of "pure iron" advocates, the absence of manganese did not prevent corrosion.

The true reason for the resistance to corrosion of these ancient irons will suggest itself to many as being due to the dense skin on the surface caused by the slow hand forging necessitating many reheatings and reforgings to bring the material to the required dimensions, all of which added to its density. An example of this may be seen in the modern product called "Patent Planished Iron," used principally for locomotive jackets exposed to all kinds of weather and yet does not corrode. The same base metal, before it is subjected to the hammering process which gives it the planished surface, shows by comparison with the finished product very rapid corrosion, yet this is the highest possible grade of charcoal iron obtainable.

And then I read the second paragraph on page 151, which states:

"Dating from the introduction of the Bessemer process of steel making, tonnage produced at the expense of quality covered the country with structures which have quickly rusted out when exposed to the elements. Analyses show that modern steel is high in impurities. When the U. S. Government by its investigations established the fact that the rapid corrosion of iron or steel was caused by the impurities present, it remained for someone to devise a method for their elimination."

When I compare this statement with my own experience and take into account that the U. S. Reclamation Service, in the Northern District at least, has specified material for the construction of flumes and pipe of such analysis as these so-called "pure irons" carrying excessive premiums, I can readily understand the indignation as expressed in some of the articles from users of water in these irrigation districts.

The paragraph quoted immediately above conveys, by inference at least, that all coverings of structures throughout the country made from Bessemer steel were failures and lasted but a few years, whereas I know, of my own knowledge, many structures with Bessemer and open hearth sheet steel coverings exposed to the elements that have lasted three and four times longer than the total span of life of these so-called "pure irons" and are in good condition today.

BLACK CANYON—A STORY OF HOPE DEFERRED

(Continued from Page 234.)

As soon as it became known that the Secretary of the Interior would ask for this loan, steps were taken to give him all the support possible in the request. Under the leadership of Hon. J. M. Thompson, an Idaho legislator and prominent attorney of Caldwell, meetings have been held all over this section and the conditions described and resolutions passed and forwarded to Washington. The Caldwell Commercial Club has taken up the fight and at the present writing Dr. Cole, president of the Club, is in Portland to enlist the co-operation of the Portland Chamber of Commerce.

It is under these conditions that we ask the support and co-operation of the people of the whole country. We want to show to the Congress that our cause is just, and, relying on the justice of our plea we expect that the Reclamation Service be furnished with the funds by which alone it is possible that the pledge of the Government to these people may be redeemed.

The settlers here endorse the broad and comprehensive policy of Secretary Lane. They believe that he is sincere in his efforts to assist the settler, and they ask the support of the people for his efforts to secure funds to enlarge the scope of operations of the service, not alone in the Black Canyon, but in other sections, where fertile lands only await the application of the life-giving water to render them capable of adding untold wealth to the country and make these United States more self-contained and less dependent upon foreign countries for the supplies necessary to support the population.

BRIEF NOTES FROM IRRIGATION PROJECTS

California

More than fifty wells for irrigation purposes have been sunk recently in the district around the new town of Orange Cove, Cal. An abundance of water is being produced by the wells.

Ranchers of Villa Park and El Modena, Cal., through their water companies, the Serrano Water Company and the John T. Carpenter Water Company, have launched a project for building a \$200,000 dam across the bottom of the Santiago Canyon for the purpose of impounding irrigation water.

The Pariso Valley Land & Irrigation Company, with a capital stock of

\$800,000, has been incorporated to develop a large tract of land in the Pariso valley, around Newberry, Cal. The directors are James O. Parker, Frank B. Apperson and Frank O. Little.

J. E. Law and W. F. Johnson of Los Angeles, Cal., have purchased 31,000 acres of land and will install pumping plants to irrigate it.

The Shasta County Promotion & Development Association will complete the Pit River irrigation project. Arrangements will be made at once for a survey for a distributing system to cover at least 600,000 acres in Shasta county and the Sacramento Valley in California.

An application has been filed with the California state railroad commission for permission to issue \$750,000 in bonds as the initial step in the plans of the Modoc County Irrigation Company. The new company has acquired the rights of the Surprise Valley Water Company, expects to pay off the \$85,000 obligation of that company and then construct a system for bringing water to the ten by fifty-mile basin in Surprise valley. The water rights permit the diversion of a supply from Cowhead lake, which is fed from the timbered slopes of the Warner mountains on the west of the valley. The estimated cost of construction is \$1,000,000. A. T. Currier is president of the Modoc County Irrigation Company and T. B. Wilde

REVIVING IRRIGATION BONDS

(Continued from Page 236.)

born, matured, managed, fostered and used by the local citizenship and not forced upon them against their consent—for consent is the basis of security which is to be enforced by taxation—as in this case it must be. Sound political wisdom dictates such a plan. But likewise sound practical wisdom dictates that there should be two names on the paper—that of the local community and that of the State. The name of the community will be on it, of course.

How shall we obtain the name of the State, without pledging its credit?

In this way: Every local security, when once issued, shall be registered by the State Auditor and certified under the great seal of the State, "This Bond is secured by taxation," and thereafter it shall be incontestable for any cause—and the State shall levy, collect and disburse the local tax necessary to pay promptly the interest and principal of the bonds at maturity.

In this way the security is removed from the realm of local influences, economic or political, and taken out of the domain of legal or accidental misfortune—while at the same time it is safely grounded upon the pledge and the power of State taxation, which is all it would have, if it were issued by the State as its own.

This simple plan requires no constitutional changes, no harmonizing of local differences and involves no financial liability on the part of the State, while it satisfies completely the just demands of the security holder, and at the same time saves and stimulates the political self-respect of the community, benefited by the improvement. It gives it the right to choose its destiny, its project, and to wisely safeguard its practical operation, for which it is best qualified.

By the adoption of this plan the last condition of financial success will be complied with, and then we can turn our thoughts to Congressional legislation, with the hearty and enthusiastic co-operation of the intelligent farmers and financiers of the East behind us. With these assured, how can we fail?

W. Scott Mathews, of the Illinois Food Commission and his assistant, John B. Newman are preparing a bulletin on eggs.

Sales Engineer A Chicago Contracting Concern has opening for a concrete and structural steel engineer, also power station engineer. Financial interest and evidence of best records required. Contract with salary, commission and expenses guaranteed.
Answer - INDUSTRIAL, care Irrigation Age.

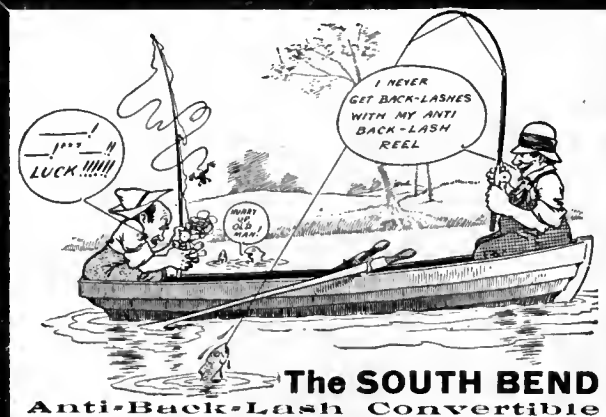

An Absolute
Anti-
Back-Lash
Casting Reel

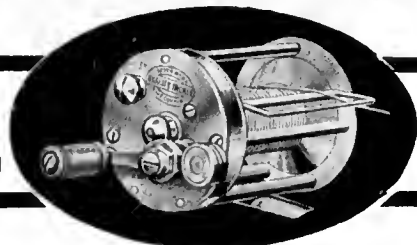

Guaranteed
to fulfill
all we
claim

This smooth running, jeweled, German silver Reel cannot back-lash. It does not interfere with the length of your cast and enables you to enjoy the pleasures of moonlight casting to their fullest extent. A few turns of the back-lash mechanism and you convert your Reel into a regular casting Reel; a few turns in the opposite direction and you adjust the back-lash preventer to exactly the desired strength. Therefore it is "TWO REELS IN ONE." Although the Reel is used largely by expert bait casters, who use its convertible feature for moonlight casting, it is also used by beginners, for with it they can become experts on their very first cast.

Now that the fishing season is here, ask your dealer to show you this wonderful Reel and his assortment of South Bend **QUALITY TACKLE**—the kind of bait that the big fish strike at—the kind of bait that hooks 'em and holds 'em. Descriptive literature on Reel and Tackle sent upon request.



SOUTH BEND BAIT CO., 540 Colfax Ave., South Bend, Ind.

vice-president and manager. Both live in Los Angeles.

Another irrigation district is to be formed near Cooperstown, Cal., in eastern Stanislaus county, where 20,000 acres will be taken into the Dry Creek district. The election will be held June 15. The water will be taken from Tuolumne river, three and a half miles above La Grange.

Colorado

The Umcompahgre Valley Water Users' Association of Colorado has recommended that the government pay \$800 per foot for the Loutsenhizer ditch water. The Reclamation Service has planned to include the land along this ditch in the Gunnison tunnel project.

The Two Buttes Carey act project in Colorado has applied to the secretary of the interior for patent to 22,000 acres of land. The application was made through the registrar of the state land board, who states that 30,000 acre feet of water for the land is now available in the company's reservoirs and ditches. There is considerable state land in the project, which was built by Chicago capital.

Government engineers have approved the water supply for three big irrigation districts close to Denver. The districts which include 263,000 acres of land, are known as the Henrylyn irrigation district, the

Farmers' Reservoir & Irrigation Company and the Denver-Greeley Valley irrigation district. The federal report makes it possible for all who have complied with the law to prove up their land and water rights.

The government says the three districts have enough water to irrigate every acre of land of the 263,000 acres from the rights they now possess on the Platte and Clear creek without regard to water they expect to get from the western slope streams through a tunnel already started.

The Pueblo & Northwestern Irrigation Company has been denied its application to the state of Colorado that request be made to the United States government for a further withdrawal of a 12,000 acre tract in Pueblo county, which was to have been developed under the Carey act. Present financial inability to carry out a contract and probably inadequacy of the water supply are cited by the state officials as cause for their decision.

The Reclamation Service is asking for proposals for earthwork on thirty miles of main canal, Grand Valley irrigation project, Colorado, involving the excavation of approximately 1,900,000 cubic yards of materials. The bids will be opened after 2 p. m., June 16, 1914, at the office of the Reclamation Service, Grand Junction, Colo.

Oklahoma

Irrigation by pumping has received great impetus in the district around Enid, Okla., as the result of a report by the United States geological survey, which shows an area of 100,000 acres, underlaid with a large water supply. The water bearing gravel is from 25 to 60 feet below the surface.

Montana

Work on the Little Missouri Carey act project in Montana will begin this month. Preliminary capital of \$250,000 has been raised and it is proposed to furnish water to the first unit of 6,000 acres early next year. The main dam will be located about ten miles below Alzada on the Little Missouri, the water of which will be diverted to Cottonwood creek, where it will be stored. The original project is designed to irrigate a district on the west side of the Little Missouri embracing an area of about 30,000 acres, but eventually it is expected that approximately 45,000 acres will be brought under the water. The officers of the company are: President, former Lieut. Governor W. R. Allen, Anaconda; vice-president, E. J. Anderson, White Sulphur Springs, banker; treasurer, A. T. Morgan, Butte; secretary, T. T. Lyon, Butte.

The Billings Heights Irrigation Company filed articles of incorporation with the secretary of state, with F. G. Bartholf, N. Algeo and R. L.

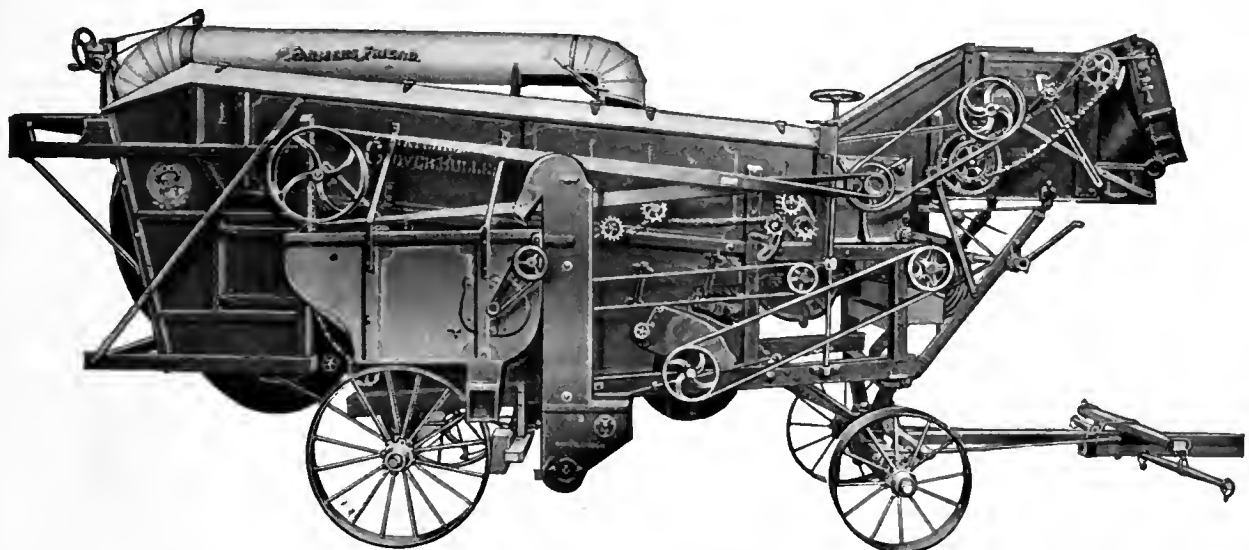

HULL YOUR SEED QUICKLY, PERFECTLY and ECONOMICALLY With a "MATCHLESS" CLOVER and ALFALFA HULLER

That's just what you will do if you use a "Matchless" Huller on the job. It's the one huller that will hull all the Clover or Alfalfa you can get to it without sacrificing the quality of the work. Here's the reason! We use square steel brads in our hulling cylinder. This construction has every advantage over rasps of spikes, because no set of spikes will knock the seed out of the damp pods. Rasps gum up and are easily destroyed. Our system of separation is unique and effective. This consists of a series of rotating troughs with perforation in the bottom, with provision for adjustment to meet the various conditions of clover. The Patented Steel Scrapers attached to the bottom of these troughs thoroughly scrape the separator bottom and insure a steady and positive delivery of the pods to the hulling cylinder, regardless of the condition of the clover. This construction enables you to hull seed under conditions in which no other huller can operate; enables you to hull earlier in the morning and later in the evening than with any other—this insures a longer day, thus increasing your earning power. Give us an opportunity to prove to you right on your own farm that the "Matchless" is the speediest and cleanest huller on the market. WRITE FOR CATALOG TODAY, or call at our nearest Branch House.

THE AULTMAN & TAYLOR MACHINERY COMPANY, MANSFIELD, OHIO.

Sole Builders of Aultman-Taylor "Starved Rooster" Line of Machinery.

BRANCHES: Minneapolis, Minn.; Portland, Ore.; Lincoln, Nebr.; Kansas City, Mo.; Wichita, Kan.; Decatur, Ill.; Indianapolis, Ind.

When writing to advertisers please mention The Irrigation Age.

Morris as directors. The new concern is capitalized at \$3,000.

Texas

The Fresno Land & Irrigation Company of Brownsville, Texas, has increased its capital stock from \$60,000 to \$100,000 and will make extensive improvements and additions to its irrigating system.

Plans and specifications have been completed for the construction of the large dam near Robert Lee, Texas. The dam will be built across the Colorado river.

Col. A. B. Robertson is putting down a big irrigation well near Slaton, Lubbock county, Texas. This is the first of a series of wells that will be drilled by Mr. Robertson on his 9,000-acre tract.

Certified water filings have been made with the Texas board of water engineers by the A. H. Pierce estate of Wharton, showing the appropriation of water for the irrigation of 30,000 acres of land in Wharton county.

The Rio Grande Canal Company, Brownsville, is planning to enlarge its irrigation system in the lower Rio Grande valley, and has increased its capital stock from \$60,000 to \$100,000.

The Secretary of the Interior has authorized the Reclamation Service to award contract to the Southwestern Portland Cement Company of El Paso, Texas, for furnishing 120,335 barrels of Portland cement, 21,000 barrels of which will be delivered at El Paso, and the remainder at Elephant Butte damsite. The contract price is \$1.40 per barrel f. o. b. cars at El Paso.

The Santa Fe Railroad has a bill before Congress which, if passed, will permit it to take a maximum of 30,000,000 gallons of water per month from the Elephant Butte reservoir on the big government project in Texas and New Mexico.

Nebraska

The Reclamation Service and the state soil survey are making surveys in Phelps and Kearney counties, Neb., preparatory to the construction of irrigation canals south of the Platte river.

Kansas

R. B. Herold of Ellinwood, Kan., has installed a centrifugal pump on his farm and is getting 1,800 gallons of water per minute. He will sink five more wells. A number of other pumps have been installed in the same district.

Farmers on the Garden City Federal project, which the Reclamation Service abandoned after spending many thousands of dollars, have obtained judgment against the United States in a suit to clear titles to their lands.

The Garden City Irrigation Power Company has been given authority to do business as a public utility by the Kansas Utilities Commission. This company promises to become one of the important irrigation projects of western Kansas. It is a subsidiary of the big sugar company operating in the Arkansas River Valley. The power company is to buy the surplus electric current of the sugar company's plant and supply it to the farmers who want to irrigate their farms. It is proposed to build transmission lines forty to fifty miles up and down the valley. The sale price of power is to be not more than 3¼ cents a kilowatt.

South Dakota

State Engineer Derr is investigating the Angostura irrigation project along the Cheyenne river in Pennington and Fall River counties, S. D. Federal aid for the construction of the project will be asked.

T. M. Riley of Omaha and the Owen Construction Company of Denver have secured contracts from the government for further construction on the Belle Fourche irrigation project in South Dakota. The north canal is to be extended six miles from its present terminus near Newell. This work will cost approximately \$80,000, while a system of laterals costing



Get Your Canadian Home from the Canadian Pacific





BUY an irrigated farm where you have insurance against drought and where you have just the moisture you need when you need it. You know the value of controlling the watering of your crops. In sunny Southern Alberta you are master of the moisture. The Canadian Pacific's great Irrigation Works insure your yield whenever rainfall is insufficient. Irrigation is not always a necessity—but it is yours at command. It means dependable crops, and wonderful crops every year. The Eastern section of the Canadian Pacific Irrigation Block East of Calgary is now open. Virgin soil of famous fertility—alfalfa, timothy and other fodders—raises all the grain and root crops, fine climate—great cattle country—good markets—unexcelled transportation.

We want the alert enterprising farmers who see this magnificent opportunity. So we make the most liberal terms. Take 20 years to pay. Call on us for long time loan of \$2000 for farm improvements if you want it. Investigate now. This block will soon be the most densely populated and intensely cultivated district in the west.

You Can Have 20 Years to Pay

We will sell you this rich, irrigated, Canadian land for \$35 to \$75 an acre. You need pay only one-twentieth down. Think of it—only one-twentieth down, and then the balance in 19 equal annual payments. Long before your final payment comes due, your farm will have paid for itself over and over again. Many good farmers in Western Canada have paid for their farms with one crop. Here are some of the startling features of the most remarkable land offer you have ever read:

We Lend You \$2,000 for Farm Improvements This offer of a loan up to \$2,000 is for farm development only, with no other security than the land itself, and shows our confidence in the fertility of the soil and in your ability to make it produce prosperity for you and traffic for our lines. This loan will help you in providing buildings, fencing, sinking well and breaking, and you are given twenty years in which to fully repay this loan. While enjoying the use of this money, you pay interest at only 6%.

Advance Live Stock on Loan Basis The Company, in case of the approved land purchaser who is in a position and has the ability to take care of his stock, will advance cattle, sheep and hogs up to the value of \$1,000 on the basis of the settler's note with interest at eight per cent, to enable him to develop more rapidly, on the right basis of mixed farming.

Farm Made Ready by Experts if Desired If you want a place all ready established, select one which our Department of Agricultural Experts has developed. On our improved farms, house and other buildings are up, well is dug, farm fenced, fields cultivated and in crop. All waiting for those who want an immediate start and quick results—all planned and completed by men who know—our own agricultural experts. Take twenty years to pay if you want to. We give free service—expert service—the valuable assistance of great demonstration farms, in charge of agricultural specialists employed by the Canadian Pacific for its own farms. This service is yours—free.

Water Rental Will Not Exceed \$1.25 per Acre And each water agreed. ment will have the approval of the Dominion Government. You are doubly protected.

The Canadian Pacific offers you the finest land on earth for grain growing, cattle, hog, sheep and horse raising, dairying, poultry, vegetables and general mixed farming—irrigated lands for intensive farming. Remember, these lands are located on or near established lines of railway, near established towns. You can start on an irrigated farm, improved or unimproved.

Here is the Last Best West—where your opportunity lies. Don't delay. Mail the coupon here at once. The best land will be taken first—so time is precious to you. Write today.

**R. O. THORNTON, Colonization Agent
Canadian Pacific Railway
Colonization Department
112 West Adams St., Chicago, Illinois**



IRRIGATION
FARMING
IN ALBERTA

**R. O. THORNTON, Colonization Agent,
Canadian Pacific Railway, Colonization
Department, 112 W. Adams St., Chicago**
 Please send me your book of information on
Irrigation Farming in Sunny Alberta.
 Name.....
 Address.....
 Town.....
 State.....

\$40,000 more will also be constructed. This will bring the water of Owl Creek reservoir to 30,000 acres not now irrigated.

New Mexico

The Mimbres river valley near Deming, New Mexico, is the latest irrigation field, according to an announcement by the United States geological survey. The survey has found that the deposits of sand and gravel underlying the region contain vast quantities of water. This is pumped to the surface by windmills.

A carload of pumps for irrigation pumping plants has reached Alamogordo, N. M. The pumping proposition has taken hold to stay in that district.

J. J. Scott of Chicago, Ill., is preparing to construct a pumping plant and system of irrigation on the Pecos river near Carlsbad, N. M.

United States Senator Albert B. Fall of Three Rivers, N. M., and associates will construct two large systems of irrigation for the purpose of reclaiming about 22,000 acres of land. The cost of the canal systems and pumping plants will be about \$135,000.

Washington

Engineers of the United States Indian Bureau on the Yakima (Wash.) reservation have commenced the survey of proposed reservoir sites at the head waters of Simcoe, Satus and Dry creeks for the purpose of determining the feasibility of impounding the flood waters of these streams for irrigating nearly 75,000 acres of land above the Wapato irrigation project.

Utah

The Secretary of the Interior has authorized the Reclamation Service to construct the Mapleton unit of the Strawberry Valley project, Utah, as soon as the land owners have complied with the conditions of the contract prepared by the department. The contract in part provides for the pledging of 3,600 acres to return the cost of the works. All owners of land in excess of 160 acres must execute appropriate trust deeds for the disposal of such excess lands in tracts of not more than 60 acres to any one qualified water right applicant. The Reclamation Service will build the main canal and structures, including turnouts from the point of diversion upon the power canal for a distance of six miles.

Wyoming

Preliminary to beginning the extension and enlargement of the Frannie Canal on the Shoshone project, Wyoming, a soil survey of the irrigable lands will be made this month. In view of the active operations of the Burlington Railway people in closing the gap between the Big Horn Basin in Wyoming and Denver, Colo., the Frannie Unit lands are soon to be made tributary to an important trunk line railroad and will therefore be desirable for homesteaders. If the report of the soil experts is favor-

GOOD ENOUGH Heavy Deep Furrow Sulky Plow

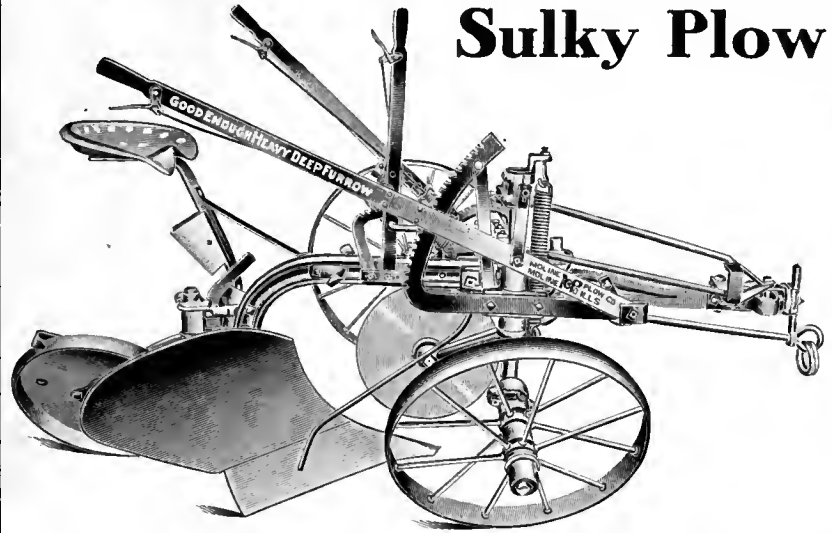

Save Moisture—Increase Yield

Plow deep—form deep moisture reservoirs—increase the feeding area of the plant roots—liberate more plant food. Do these things and your crops will be greatly increased. The Good Enough Heavy Deep Furrow Sulky is the most efficient plow for deep plowing on the market.

The Good Enough Heavy Deep Furrow Sulky is a tremendously strong and powerful plow. It will plow any soil that is capable of being plowed and will turn a furrow from 6 to 15 inches deep.

The landing lever controls both the front furrow wheel and the hitch. The dial hitch can be adjusted to either side and up or down. The draft is applied directly to the beam through the heavy draft rod. The rear wheel is locked in place, but can be instantly released by means of the foot trip at the ends of the rows.

Regularly furnished with five-horse evener, rolling coulter and extra shares.

**See Your Flying Dutchman Dealer
or Write for Information**



Moline Plow Co.

Dept. 3

MOLINE, ILL.



able and construction is approved by the department, the extension of the canal can be made in a comparatively short time. This project contains about 800 farms of which 500 are entered and the remaining 300 are ready for farmers.

Arizona

Construction work has begun on the second railway to be operated by the government in the United States. The new railroad is being laid on the top of the levees constructed by the Service to protect the Yuma valley lowlands from the floods of the Colorado river. Its purpose is mainly for the transportation of the rock and machinery which are required to repair and strengthen the levee system, but it will also be utilized by the farmers of the lower valley to market their products and bring in their supplies. The line will be about 21 miles long, connecting with the Southern Pacific at Yuma, and it will be operated exclusively by the Service. One other railway only in this country is exclusively owned and operated by the government. The Arrowrock Railway in Idaho, 19 miles in length, was built several years ago and is doing a regular freight and passenger business.

Idaho

The Secretary of the Interior has approved the form of contract between the United States and the Nampa Meridian Irrigation District, Idaho, which had previously been informally adopted and accepted by the board of directors of the district. The contract provides for the construction of certain drainage canals in that district as a part of the proposed drainage system of the Boise project, and in general is similar to the contract with the Pioneer Irrigation District.

In Other Lands

Water is now being delivered to a large part of the 3,000,000 acres under the Bassano irrigation system, which extends from Calgary, Alberta, to Medicine Hat. For the past three years the Canadian Pacific Railway has been busily engaged in completing this immense project, which was begun many years ago by the Dominion Government of Canada and was abandoned because of lack of funds. The system represents an expenditure of \$17,000,000, no little part of which is represented in the dam across the

Bow River at Bassano, 83 miles east of Calgary. With its 3,000 miles of canals and ditches, this irrigating project ranks second largest in the

world, being a close rival of the Assouan irrigation system in lower Egypt. It is the largest irrigation system on the Western Hemisphere.

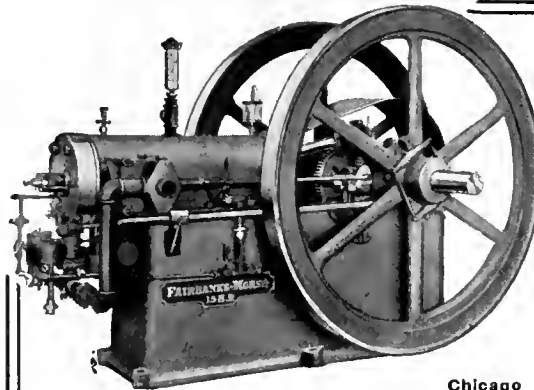

Sizes 5 to 80 H. P.
Other Types to 200 H. P.

Fairbanks-Morse Oil Engines

Operate equally well on Kerosene, Gasoline or low-grade Distillate. Delivers equal power on cheaper fuel.

Centrifugal and plunger type pumps, all sizes and capacities.

Write for Catalog 40N 650

Fairbanks Morse & Co.

- | | | |
|----------------|-------------|-------------|
| Chicago | Kansas City | St. Louis |
| St. Paul | Denver | Omaha |
| Spokane | Portland | Los Angeles |
| Salt Lake City | Seattle | Atlanta |

Save high as 60% On Lumber and Millwork

Don't Pay Profits to Five Middlemen

That's what you do when you buy of your local lumber dealer. Buy of us and you buy of the producer. We are one of the biggest independent lumber companies in America; own thousands upon thousands of acres of choice Western timber. Do our own cutting, logging, railroading; operate six huge mills, where we produce daily 20 to 30 carloads of lumber and millwork.

Buy Direct From Our Six Mills. Besides up to 60% saving in price we offer you better materials, efficient delivery service and guaranteed satisfaction.

Immediate Shipments. We carry immense stocks. Miles and miles of lumber piles, and warehouses groaning with millwork, await your order. Make all shipments within 24 to 48 hours.

Better Quality Guaranteed. Our timber tracts are in the famous Puget Sound region. Noted for big trees. Our lumber is straight, free from sap and knots. Exceedingly durable.



GET THIS MONEY-SAVING PLAN BOOK

If you haven't decided on your plan, you'll find just what you want in this book. It's prepared by practical people and packed full of sensible, full-value plans. Over 100 good plans in this book. Costs you 10 cents—worth a thousand times that.

Get Any Plan in This Book for \$2.00

For \$2 you can get complete blue prints, specifications and guaranteed estimate, covering complete materials of any plan in the book.

Send the Coupons

Send Carpenter's List for Quick Prices

Don't pay five profits for your lumber. Send your carpenter's list of lumber for delivered, freight-paid price. No extras guaranteed. We ship everything for building complete—lumber, sash, doors, shingles, millwork, hardware and paint. We have doubled our estimating force to give quick service to everybody.

BUY A SEATTLE SILO DIRECT FROM MAKER

No wood stands silo service better than fir. We use Douglas Fir, from giant trees, straight-grained tough, long-lasting. Seattle Silos have quick detachable swinging doors. Door bars form strong ladder from which hoops are tightened. Write for special folder today and first farmer-in-a-town offer.

HEWITT-LEA-FUNCK CO.

471 CRARY BLDG., SEATTLE, WASH.

HEWITT-LEA-FUNCK CO.,
471 Crary Bldg., Seattle, Wash

Kindly send the following, quoting prices delivered, my station.

Be Sure to Write Plainly

- () Catalog Lumber and Millwork
- () Prize Plan Book, 10c
- () Special Barn Folder (4c)
- () Special Silo Folder

Name.....

Town.....State.....

I am planning to build as follows.....

RAISE PIGEONS

They Pay Dollars while Chickens pay cents

The young 20 to 25 days old, sell from 40 to 60 cents each (according to the season). The city markets are always clamoring for them.

Each pair of Pigeons will raise 18 to 22 young a year.

They will clear you above expenses, \$5.00 a year per pair. They breed the entire year. Twenty minutes daily will care for 100 pairs.

Always penned up out of the way Very small space required.

All this is fully explained in this month's issue of our Journal; send for it; price 10 cts.

Reliable Squab Journal, Versailles, Mo.

A CANADIAN'S REPLY

Editor of THE IRRIGATION AGE:

This association has read with surprise your rather feverish editorial appearing in the May issue of THE IRRIGATION AGE—"Stop the Sale of the Irrigation Congress"—and as a subscriber to this paper and an association working in the interests of irrigation in general, must point out to you the following facts:

1. That Canada has nothing whatever to do with the changing of the name of the Irrigation Congress.
2. That it was not until after the National Irrigation Congress had become "International" that Canada extended an invitation to the Congress to hold its meeting in this country in conformity with its title.
3. That there is no international boundary where irrigation or agricultural interests are concerned on this continent, and this fact was recognized by the Board of Governors (which did not include a single Canadian) in accepting the invitation of the Canadians to meet in Calgary.

4. There was no Congress of the International Irrigation body held in the United States last year for lack, I understand, of necessary funds, and that therefore Canada is deserving of eulogy rather than condemnation for reviving the Irrigation Congress and so actively setting it on its feet again.

5. That the Irrigation Congress has not moved over into Canada to stay, but to hold one of its annual meetings, and that if energy, enterprise and enthusiasm in the cause of irrigation has in recent years been lacking in the United States, a very different status of affairs will be found in Canada.

6. That year after year representatives of this association have attended the Irrigation Congresses in the United States, and that the action of the International Congress in coming here is only following in the footsteps of the Oregon Irrigation and other congresses, who, both last year and this year, are sending delegations to this country to take part in irrigation deliberations.

7. That in conformity with the great peace centenary

GALVANIZED METAL IRRIGATION FLUME (Newcomb Patent)

Made entirely of rust-proof, galvanized iron. No bolts or rivets used in construction. This flume is considered by experts to be the most serviceable equipment for the purpose on the market.

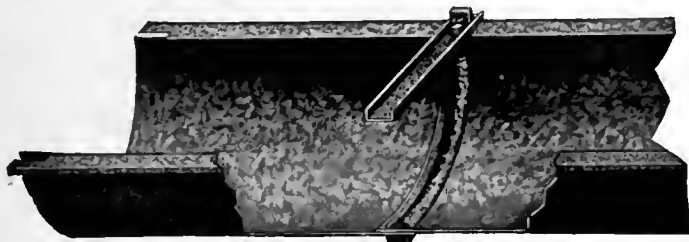

Section of Flume

A careful examination of the construction as shown herewith will convince those who are acquainted with irrigation conditions of its lasting quality and the ease with which it may be put together. Complete information, with prices, will be furnished on application to the

KLAUER MFG. COMPANY, Dubuque, Iowa

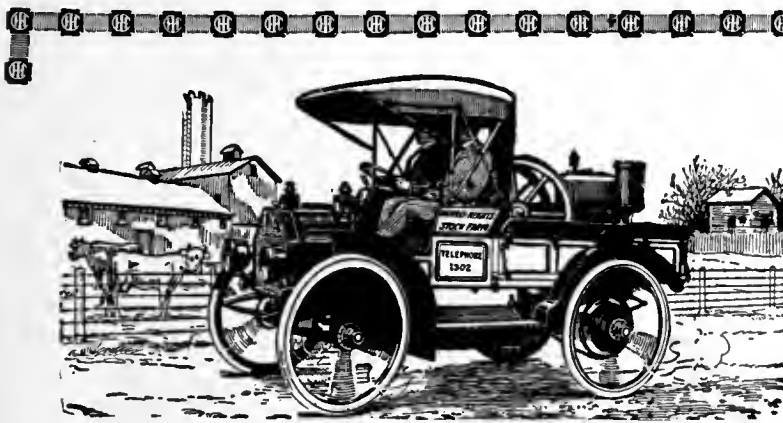

The Passing of an Aristocrat

YOUR horses demand much, need much—and get much. For instance—costly stable, rigs and sheds for them; harnesses; hay and oats, and its storage space; time spent each day in the year caring for them, feeding, watering, currying, harnessing, frequent blacksmith, harness, and vehicle repair bills; occasional veterinary bills.

All that an international Motor Truck asks for is a shed, and a small ration of gasoline and oil—that's all. And when it's not working it wants only the shed. For profit and economy buy an

International Motor Truck

You will find that it costs considerably less than horse and wagon keep, it goes four times as fast and as far as the horse, saves you many hours of time, and will run twenty-four hours in a day if necessary. In reliability, strength, and ease of management, it is best.

Solid tires eliminate common tire troubles. The wheels are high enough to give ample road clearance. The simple, sturdy motor has plenty of power. Brakes are powerful. A single lever controls the car.

It will pay you to find out all that an International Motor Truck will do for you. Write for catalogues, facts and figures to the



WESTERN BRANCH HOUSES: Denver, Col.; Helena, Mont.; Portland, Ore.; Spokane, Wash.; Salt Lake City Utah; San Francisco, Cal.

International Harvester Company of America

(Incorporated)

Chicago

USA



movement it is but natural and just in the promotion of this spirit that the International Irrigation Congress should hold a session in Canada, and finally, editorials of this description do not benefit the cause for which your journal is maintained or for which it *should be* maintained.

We shall be pleased if you will find space in your columns for this letter.

Yours very truly,

NORMAN S. RANKIN,

Secretary of Western Canada Irrigation Association.
Calgary, Alberta.

SOME CENTRIFUGAL PUMP POINTERS

(Continued from Page 242.)

Before starting for the first time it is advisable to clean out the bearings thoroughly, including the thrust bearing, by pouring in kerosene and allowing it to run out at the bottom, as dirt and other substances are liable to get into the bearings during shipment. The bearing should then be filled as full as possible with first-class lubricating oil similar to dynamo oil. After priming, the pump can be started up and brought up to speed with the discharge valve closed. The discharge valve can then be immediately opened until the desired quantity of water is obtained. If the total head is greater than that for which the pump was designed, the quantity of water discharged will be less than full capacity, and may even be nothing at all if the head is enough greater. The power will also be less than the power required for the head for which the pump was designed. If the total head is less than the head for which the pump is designed, the amount of

Two Thousand Acres

of Michigan Hardwood Stump Land for Sale

Land is adapted for fruit raising and general farming. In well developed section with splendid county roads intersecting. Close to railroad and good market. Will consider well located property in Central West in part exchange.

Also large and small orchard tracts in highly developed condition for sale

GRAND TRAVERSE ORCHARD CO.

TRAVERSE CITY, MICH.



THINK what it means to you! To have at your service—day and night if desired—the combined power of 30 to 35 horses and 10 to 15 men—ready at a moment's notice to plow, disc, harrow, seed, harvest, build roads, irrigate, thresh and do numerous other power jobs, all at the minimum expense for fuel and maintenance. That's what you get when you buy a time-tried and time-proven

AULTMAN-TAYLOR 30-60 GAS TRACTOR

They're built with the complete knowledge of the requirements of a tractor of the first quality. They're built right here in our own shop, under our own supervision. We know they're right and we stand back of every tractor. The Aultman-Taylor 30-60 burns either gasoline, kerosene or

distillate with unequaled economy. The Aultman-Taylor 30-60 is not an experiment. Their real worth has been demonstrated on thousands of farms throughout North America. Let us explain to you why you should own and operate one of these money-making and labor-saving tractors. **WRITE FOR CATALOG AND FURTHER INFORMATION TODAY.**

We are also builders of the Famous "New Century" Separator, "Matchless" Clover and Alfalfa Huller, Steam Traction and Portable Engines, Bean Threshers and Saw Mills. Catalog free upon request.

THE AULTMAN & TAYLOR MACHINERY COMPANY

MANSFIELD, OHIO.

BRANCHES: Minneapolis, Minn. Portland, Ore. Lincoln, Nebr. Kansas City, Mo.
Wichita, Kan. Decatur, Ill. Indianapolis, Ind.

When writing to advertisers please mention The Irrigation Age.

water will be greater than the normal capacity of the pump, and the power consumed will also be greater.

The pumps can always be run on reduced

heads by throttling the discharge until the desired quantity of water is obtained. This creates an artificial head and reduces the efficiency of pumping but will prevent overloading the motor.

We planned this House and Saved Robert Zehntner \$375.00

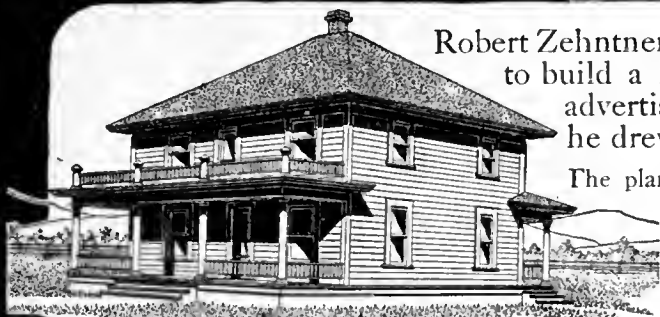

Home Designed for Robert Zehntner, White Sulphur Springs, Mont.

Robert Zehntner of White Sulphur Springs, Mont., wanted to build a home and answered a Hewitt-Lea-Funck advertisement. On the back of our question blank he drew a rough sketch of what he had in mind.

The plans you see at the left, and afterward, the house pictured, was the result. When it came to ordering the lumber, the local yard man asked for the chance to bid and got it, but he didn't get the business. Mr. Zehntner's letter to us tells why. "I unloaded the car," he says, "and found the material fine. The carpenters are well pleased, the finish being much better than I could have gotten here. The best local

bid on the material was \$375 higher than yours and lacked quite a bit of being complete."

Complete plans \$2

If you like this house, you can get the complete plans, specifications, guaranteed estimate of prices on lumber, millwork, hardware, paint and heating plant delivered at your station—all for \$2.

Our guaranteed price means *no extras*. We guarantee absolutely to provide sufficient materials to build the house, and guarantee grades equal or better, than required by standard rulings. Getting the plans does not obligate buying materials of us, if you do, you get your \$2 back. If this plan doesn't suit,

Send coupon for Prize Plan Book - 100 homes—all sizes—all prices

It's the *most practical* book of its kind ever published. Every plan is a good one—a lot of them will please you—one of them will doubtless *just suit you*. Our architects worked over a year on this book. It cost us \$30,000 to get it out. Books not nearly so good are sold at 50c to \$2.00. Yet, ten cents, merely to cover postage, will bring you this valuable book, if you use the coupon.

middleman and sell you direct at the *mill price*—a price that's way-down low, because the raw materials come from forests under our control. Our lumber is straight-grained, free from sap and large knots, doesn't warp or shrink. Makes a beautiful job.

Special plans at small cost

If none of the plans in this book quite suit you, and you have your own ideas of what you want, you'll find it easy to show us what your ideas are, just as Robert Zehntner did. We have a Plan Sheet for this purpose, that makes it simple. Give us a rough sketch of what you have in mind—and we will complete the plan for you.

Send for estimate—no obligation

Send us your carpenter's bill of materials for our prices, if you can. Do it even if you aren't ready to build. No charge or obligation. If we can be of any help to you in planning your building be sure to let us know. Our special plan sheet makes it easy to give us your ideas—ask for it. At any rate, mail the coupon today for catalog and general price list.

Save as high as 60% on lumber—buy direct from the producer

Too many middlemen come between the mill and the lumber dealer—that's why his prices are so high. We cut out every single

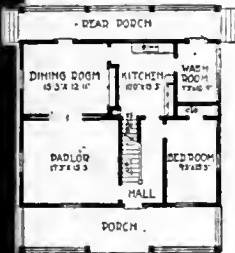

FIRST-FLOOR PLAN - DESIGN - HP - 610 -

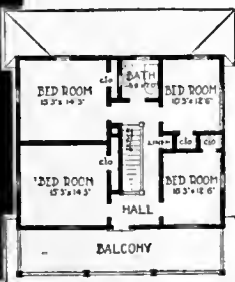

SECOND-FLOOR PLAN - DESIGN - HP - 610 -

Silos at up to 60% Saving

Here's the biggest silo value you can get. Buy direct, at the mill price, a Seattle Silo of one-piece staves from durable Puget Sound fir. Seattle Silos have patented swinging doors. Door bars form strong ladder from which hoops are easily tightened.

Send the coupon for folder on Seattle Silos. Get our special one-farmer-in-a-town-offer. Write today.

HEWITT-LEA-FUNCK COMPANY
471 Crary Building Seattle, Wash.

Hewitt-Lea-Funck Company
471 Crary Bldg., Seattle, Wash.

(Be sure to write plainly and if possible send bill of materials for estimate)

Please send me the following:

- Book of Plans (for which 10c in stamps or coin is enclosed).
- Catalog and General Price List of Lumber and Millwork, Free.
- Special Silo Folder, Free.
- Special Plan Sheet, Free.

Name _____

R. F. D. or Street No. _____

Post Office _____ State _____

Business _____

The Lauson Kerosene and Low Grade Distillate Engines

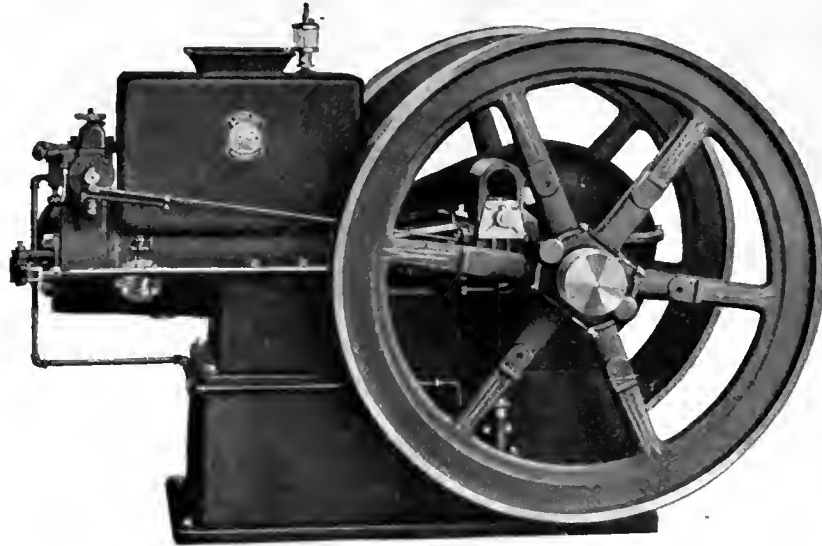

Insure Your Crops

Don't economize on Price when Reliability is at stake. Successful Irrigation depends upon **Heavy Continuous Power**.

You may be able to buy an Engine that is cheaper than the Lauson but the Reliability won't be there.

It won't have that Lasting Economy of Operation—that **Ability to stay on the job three hundred and sixty-five days in the year and twenty-four hours per day**, that characterizes the Lauson.

There is a reason behind Lauson Reliability and Low Cost of Operation, namely Design, Material and Workmanship. It is a question of a better Quality perhaps not noticeable at first, yet **Quality that shows in Years of Dependable Service**. It is worth the Difference.

Such Points as—No torch, no preheating, no carbon in cylinder, easy to start and operate, full rated horse power with one-half the cost of fuel, all wearing parts of steel case hardened and ground to size, drop forged unbreakable gears, cams and cam shaft drop forged in one piece, case hardened and ground to size, cams running in bath of oil, enclosed in dust proof case, special gear-driven Magneto, guaranteed for the life of the engine and No Batteries—are worthy of your most careful investigation.

Built in sizes from 6 to 100 HP. Hopper or Tank Cooled.

The closer you investigate, the Lauson Kerosene Engines, the surer you are to buy one. Our Large Catalog No. 15 tells the whole story. A reading of it, will convince you. Write for it today, and nearest branch and distributing point.

THE JOHN LAUSON MFG. CO.

GENERAL SALES OFFICE AND FACTORY

68 Monroe Street

NEW HOLSTEIN, WIS.



THE GOOD OLD TIMES

could not boast of airships or wireless telegraphy, but they had

IRON THAT WOULD LAST

Everyone knows how modern steel is destroyed by corrosion, but it will be news to some that the making of pure and lasting iron has not become a lost art.



THE TWENTIETH CENTURY

HAS DEVELOPED

AMERICAN INGOT IRON

→ 99.84% PURE ←

a standard never before attained, and experience is showing this to be even more durable than the iron used by our grandfathers



It is chosen by the men who emphasize

QUALITY



PURITY

PERMANENCE

WRITE THE NEAREST MANUFACTURER FOR PARTICULARS AND PRICES ON AMERICAN INGOT IRON CORRUGATED CULVERTS, SIPHONS, PLATES, SHEETS, ROOFING AND FORMED PRODUCTS

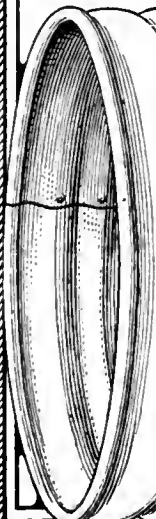

Arkansas, Little Rock
Dixie Culvert & Metal Co.
California, Los Angeles
California Corrugated Culvert Co.
California, West Berkeley
California Corrugated Culvert Co.
Colorado, Denver
R. Hardesty Mfg. Co.
Delaware, Clayton
Delaware Metal Culvert Co.
Florida, Jacksonville
Dixie Culvert & Metal Co.
Georgia, Atlanta
Dixie Culvert & Metal Co.
Illinois, Bloomington
Illinois Corrugated Metal Co.
Indiana, Crawfordsville
W. Q. O'Neill Co.
Iowa, Des Moines
Iowa Pure Iron Culvert Co.
Iowa, Independence
Independence Corr. Cul. Co.
Kansas, Topeka
The Road Sup. & Metal Co.
Kentucky, Louisville
Kentucky Culvert Co.
Louisiana, New Orleans
Dixie Culvert & Metal Co.

Maryland, Havre de Grace
J. N. Spencer.
Massachusetts, Palmer
New England Metal Cul. Co.
Michigan, Bark River
Bark River Bridge & Cul. Co.
Michigan, Lansing
Michigan Fridge & Pipe Co.
Minnesota, Minneapolis
Lyle Corrugated Cul. Co.
Minnesota, Lyle
Lyle Corrugated Cul. Co.
Missouri, Moberly
Corrugated Culvert Co.
Montana, Missoula
Montana Culvert Co.
Nebraska, Lincoln
Lee-Arnett Co.
Nebraska, Wahoo
Nebraska Cul. & Mfg. Co.
Nevada, Reno
Nevada Metal Mfg. Co.
New Hampshire, Nashua
North-East Metal Cul. Co.
New Jersey, Flemington
Pennsylvania Metal Cul. Co.
New York, Auburn
Pennsylvania Metal Cul. Co.
North Carolina, Greensboro
Dixie Culvert & Metal Co.

North Dakota, Wahpeton
Northwestern Sheet & Iron Works.
Ohio, Middletown
American Rolling Mill Co.
The Ohio Corrugated Cul. Co.
Oklahoma, Shawnee
Dixie Culvert & Metal Co.
Oregon, Portland
Coast Culvert & Flume Co.
Pennsylvania, Wrenn
Pennsylvania Metal Cul. Co.
South Dakota, Sioux Falls
Sioux Falls Metal Cul. Co.
Tennessee, Nashville
Tennessee Metal Culvert Co.
Texas, Dallas
Atlas Metal Works.
Texas, El Paso
Western Metal Mfg. Co.
Texas, Houston
Lune Star Culvert Co.
Utah, Woods Cross
Utah Culvert Co.
Virginia, Roanoke
Virginia Metal & Cul. Co.
Washington, Spokane
Spokane Corrugated Culvert & Tank Co.
Wisconsin, Eau Claire
Bark River Bridge & Cul. Co.



Put the right engine behind your pumps

NO matter how large your irrigation system or how small, the efficiency and consistent performance of the engine that drives the pumps is a matter of the utmost importance. Abundant power, ready control, freedom from breakdowns and economy of fuel consumption are points that count big in results and satisfaction. Install a Gilson Engine and you can be sure of reliable service with minimum attention and minimum fuel cost. On irrigation work it has proved itself beyond question **the engine that more than makes good.**

Gilson "Goes Like Sixty" Engines

GAS AND GASOLINE

The strongest and simplest built engines in the field. Easy to operate, work without watching. No unnecessary pounding or wear. Last a lifetime. They do not need constant tinkering for they are designed on practical lines and have no weak spots. Built for hard service from tested materials. Nickel steel valves. Extra large high test babbitt bearings. Forged steel shafts of marvelous strength and finish. Exact workmanship throughout and perfect balance. Many special features and improvements that increase efficiency.



100% Service

60% Speed

GILSON ENGINES are built in sizes from 1 to 15 H. P., each size guaranteed to develop its full rated power. Patented devices give you the right speed for every job about the farm, ranch or irrigation plant. Built-in Sumter magnetos make it possible to start the engine without cranking and do away with batteries.

Mail the Coupon Whatever your requirements, whether for irrigation use or farming operations, there's a Gilson Engine that will give you the right service. Our prices will save you money at the start and the small fuel consumption of Gilson Engines will keep cost of operation down to a surprisingly low figure. Clip off the coupon and mail it back today and we will give you valuable information about the type of engine best suited to your particular needs.

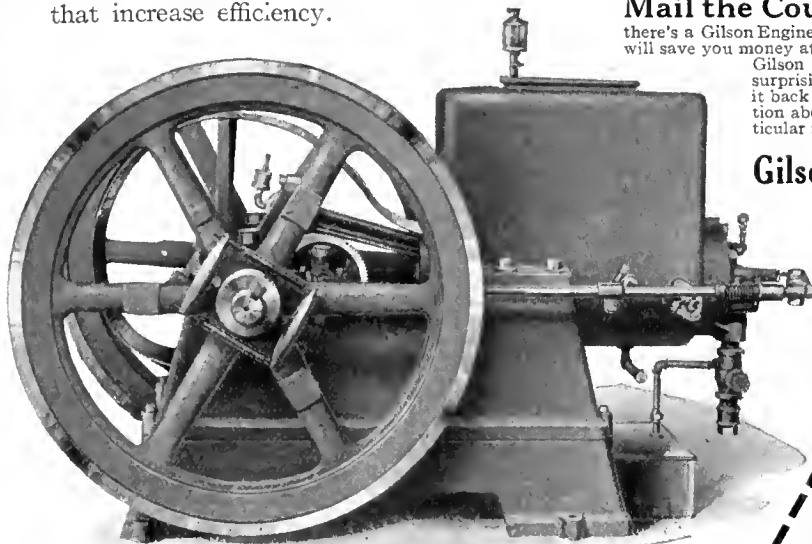

Gilson Manufacturing Company

76 Park Street Port Washington, Wis.

MAIL THIS COUPON

Gilson Manufacturing Company
76 Park St., Port Washington, Wis.

I am interested in a Gasoline Engine
of.....Horse Power

Portable or Stationary

Name

Post Office

State

R. F. D. No.

Send me your Free Catalog and full particulars.

THE GRIMES IRRIGATION PUMP

Especially designed for Irrigation Pumping from Lakes, Rivers, Canals and Shallow Water Wells.

Made to order in sizes and lengths to meet local conditions and requirements.

POINTS OF EXCELLENCE

1. Unsurpassed simplicity of action—Nothing to get out of order. Sand, gravel or mud conditions cannot interfere with constant operation of pump.
2. A solid, one-piece mechanism—Powerfully constructed out of most durable materials. No valves, plungers or cylinders.
3. Low speed—24 to 50 revolutions per minute—An assurance of long life.
4. Light power requirement—See specimen rating in 1000 g. p. m. sizes. No other type of pump to equal it.
5. Special adaptation to Irrigation Pumping.
6. Highest practical efficiency.
7. Most economical.

*Guaranteed Ratings. 1000 gallons per min.
52 inch diameter pump.*

Lift	Horse Power	Lift	Horse Power
6 ft.	1.8	20 ft.	6.0
8 "	2.4	22 "	6.6
10 "	3.0	24 "	7.2
12 "	3.6	26 "	7.8
14 "	4.2	18 "	8.4
16 "	4.8	30 "	9.0
18 "	5.4		

Write for booklet

The Grimes Irrigation Pump Co.

1022 First National Bank Building
Denver, Colorado.



Finish This Story

A WORKMAN in an IHC wagon factory was explaining the various stages of wagon construction to an interested visitor. He picked up two pieces of long leaf yellow pine, which to all appearances were sawed from the same board, and asked the visitor to notice the difference in the weight of the two pieces. The lighter piece, he explained, was kiln-dried. The heavier piece was air-dried and more thoroughly seasoned. It had retained the resinous sap which adds strength and toughness, while in the kiln-dried piece of lumber this sap had been drawn out by the too rapid application of heat.

Every Stick of Lumber Used in IHC Wagons is Carefully Selected, Air-Dried Stock

Here was something to think about. The visitor asked for a test as to the relative strength of the two pieces of wood. The air-dried piece held up under nearly double the weight under which the kiln-dried piece of lumber broke. The workman explained how the comparative life of air-dried and kiln-dried lumber has about as great a difference.

To the eye there was no difference between these two pieces of lumber, but when put to



the test there was a vast difference. So it is throughout the construction of IHC wagons—Weber, Columbus, New Bettendorf, Steel King. They are built for real strength, light draft, and satisfactory service.

After seeing the care used in the construction of every part of an IHC wagon, the visitor asked: "Why don't you let people know of the great care used in selecting material and in constructing IHC wagons?"

This is what we have been trying to do, but we cannot tell it all in one short advertisement.

Weber and Columbus wagons have wood gears. Steel King and New Bettendorf have steel gears. IHC local dealers handle the wagons best suited to your work. See them for literature and full information, or, write the nearest branch house.

WESTERN BRANCH HOUSES: Denver, Col.; Helena, Mont.; Portland, Ore.; Spokane, Wash.; Salt Lake City, Utah; San Francisco, Cal.

International Harvester Company of America

(Incorporated)

Chicago

U S A



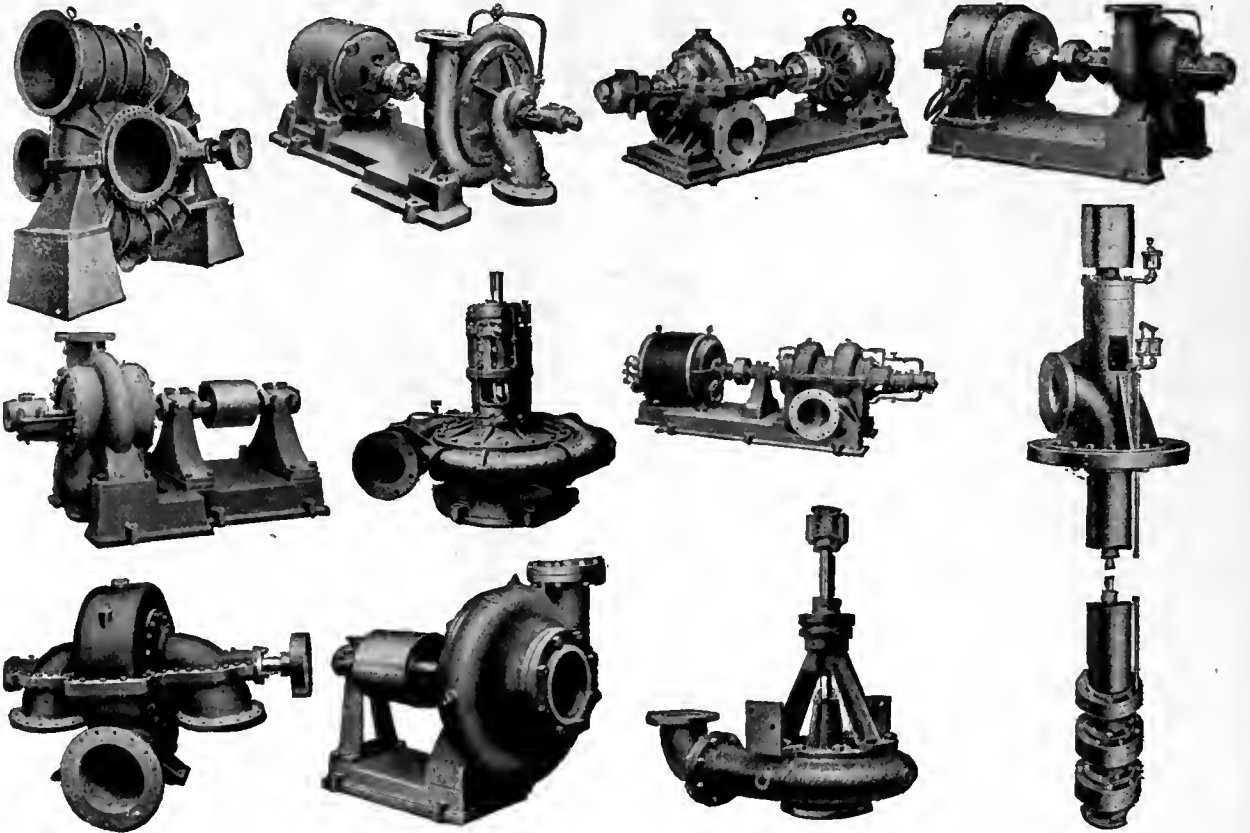

SUCCESS OR FAILURE

OF AN IRRIGATION SYSTEM
DEPENDS UPON THE PROPER SELEC-
TION OF PUMPING EQUIPMENT

WORTHINGTON CENTRIFUGAL PUMPS

ARE BUILT BY ENGINEERS WHO HAVE MADE
A CAREFUL STUDY OF THE IRRIGATION
PROBLEM—THEY REPRESENT THE HIGHEST
DEVELOPMENT IN THE DESIGN OF PUMPING
MACHINERY FOR THIS CLASS OF SERVICE.

WE WILL BE PLEASED TO MAIL UPON APPLICATION, COPIES
OF OUR CATALOGUE W202-89 AND SPECIAL BOOKLET W204-89

HENRY R. WORTHINGTON

115 BROADWAY, NEW YORK

WORKS: HARRISON, NEW JERSEY

BRANCH OFFICES IN ALL PRINCIPAL CITIES

W260.8

IRRIGATION FROM WELLS



An Arkansas Installation. Layne Patent Screen and Patent Enclosed Line Shaft Centrifugal Pump.

With the twenty-three hundred successful working plants using our system of irrigation, which inoculates and energizes the dormant forces, there is now being produced in previously non-productive districts throughout the UNITED STATES and in portions of Europe and Asia over eleven million dollars worth of FOOD PRODUCTS ANNUALLY. That our system is not an experiment is forcibly demonstrated by the fact that much of this production is from localities which were arid and barren previous to the introduction of our system.

Write for new catalog.

LAYNE & BOWLER COMPANY

Address nearest office.

The World's Largest Water Development Company

Houston, Texas

Memphis, Tennessee
Welsh, Louisiana

Stuttgart, Arkansas
Plainview, Texas

Jackson, Mississippi



International Harvester Tillage Implements

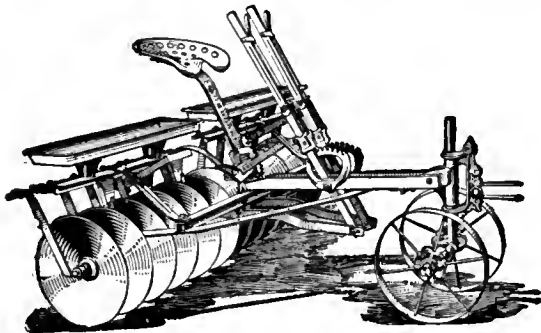

THIS year ten disk harrows will be sold where one was sold five years ago. Why? Because so many farmers have learned that the proper use of a disk harrow is the best guarantee of a successful crop.

Proper use of a disk harrow means the purchase of an I H C disk harrow, because they are the ones built to do the best work. The frames are strong, to stand the strain of following the binder or of slicing meadows. The set levers keep the gangs to their work at even depth. The bearings are the most durable that can be put on a disk harrow.

The full line includes disk, peg tooth, and smoothing harrows, drills and cultivators. See this line before you buy. We send catalogues on request.

"The Disk Harrow," a book which illustrates and explains the proper preparation of a seed bed, and gives examples of the value of disking—32 pages of valuable information—is yours for four cents to cover postage and packing.

GRAIN AND HAY MACHINES
Binders, Reapers
Headers, Mowers
Rekes, Stackers
Hay Loaders
Hay Presses

TILLAGE
Combination,
Peg and Spring-
Tooth, and Disk
Harrow
Cultivators

**THE I H C
LINE**

CORN MACHINES
Planters, Pickers
Binders
Cultivators
Ensilage Cutters
Shellers
Shredders

GENERAL LINE
Oil and Gas
Engines
Oil Tractors
Manure
Spreaders
Cream Separators
Farm Wagons
Motor Trucks
Threshers
Grain Drills
Feed Grinders
Knife Grinders
Binder Twine

International Harvester Company of America

(Incorporated)

Denver—Helena—Portland—Spokane—Salt Lake City—San Francisco

Champion Deering McCormick Milwaukee Osborne Plano





WE SHALL be glad to mail anyone who wishes same, our free catalog. We sell our product through dealers and jobbers entirely and solicit inquiries from all dealers. Our goods are well and favorably known. They are standards in the United States Army and several other departments of the government.

Gold Medal Camp Furniture Mfg. Co.
 Racine, Wis., U. S. A.

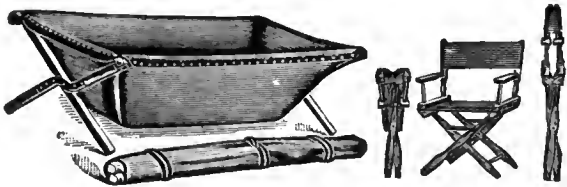

SAFETY FIRST

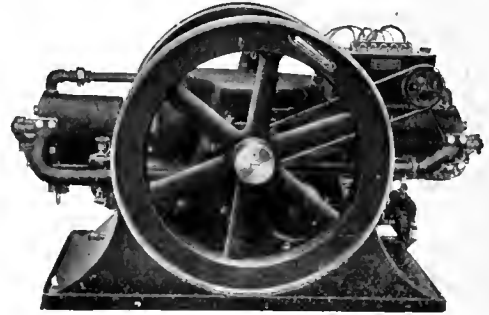

"Better be safe than sorry" is a maxim that applies to irrigation with greater force than to any other industry. Cheap, complicated, low-priced engines will cause sufficient damage and loss in repairs and delays during a single season to more than overcome the difference required to get a

HEER TWO CYLINDER OPPOSED ENGINE (Heavy Duty Type)

Simple, safe, sturdy, strong, steady-powered—they insure your success and guard you against failure by being always ready to pump your water when you want it. Practically perfect balance causes it to run without vibration, does away with lost motion, produces high efficiency, cuts down wear and tear on engine and pump, saves fuel, and insures crops against failure. Burns small amounts of cheap oils. Requires little attention. Has negligible repair cost. Total cost of delivering water on the ground less than others.

*Write for catalog of the HEER ENGINE
 "The reliable engine with the jerk left out"*

The Heer Engine Co. 207 E Street,
 Portsmouth, O.
 Also Builders of the Four Wheel Drive Oil Tractor.

PAYS FOR ITSELF IN ONE MONTH



and Keeps on Saving You Money at the Same Rate Thereafter.

THE RECLAMATION DITCHER

Cuts Canals and Laterals for less than any other machinery—because it plows the dirt out with *One Continuous Sweeping Motion*.

We guarantee the cost per yard and prove it before you buy.

The J. D. Adams Mfg. Co.
 Indianapolis, Ind.



Delays Pay No Dividends. Mail This Coupon Today.

The J. D. Adams Mfg. Co., Indianapolis, Ind.

Below are descriptions of our proposed ditches. What will it cost per cubic yard to make them with the Reclamation Ditcher?

Length	Width in Bottom	Average Depth	Maximum Depth	Minimum Depth	Slope of Sides	Character of Soil

Name _____ Address _____

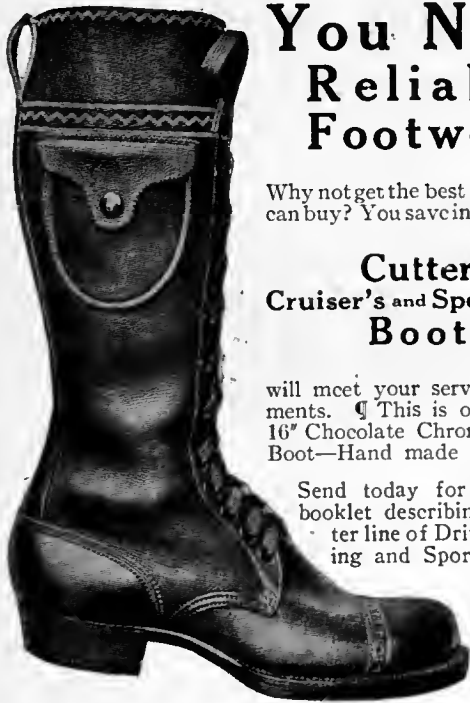

You Need Reliable Footwear

Why not get the best your money can buy? You save in the long run

Cutter's Cruiser's and Sportman's Boots

will meet your service requirements. ¶ This is our No. 106 16" Chocolate Chrome Sporting Boot—Hand made throughout.

Send today for illustrated booklet describing the Cutter line of Driving, Cruising and Sporting Boots.

*It
Will Pay
You*

A. A. Cutter Company
Eau Claire, Wisconsin

SAMSON TURBINE

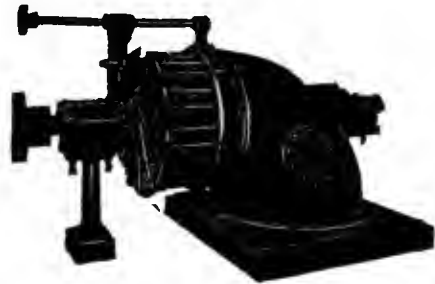

When the PUMP cannot be direct connected to the turbine shaft, the power is usually transmitted by gears, shafting, etc. On account of the HIGH SPEED of the SAMSON, for a given power, lighter and consequently CHEAPER transmission machinery can be used.

JAMES LEFFEL & CO.
Springfield, Ohio, U. S. A.
316 Lagonda Street



Perfect Service

at

Minimum Cost

in the long run is supplied by the

Lennon Metal Flume

Made from galvanized sheets of the purest and most durable iron on the market.

AMERICAN INGOT IRON

Write the Nearest Manufacturer for Full Information

CALIFORNIA—Los Angeles—West Berkeley,
California Corrugated Culvert Co.
COLORADO—Colorado Springs,
Lennon Metal Flume Co.
COLORADO—Manitou,
Lennon Flume Co.
MONTANA—Missoula,
Montana Culvert Co.

NEBRASKA—Wahoo,
Nebraska Culvert & Mfg. Co.
OREGON—Portland,
Coast Culvert & Flume Co.
SOUTH DAKOTA—Sioux Falls,
Sioux Falls Metal Culvert Co.

TEXAS—El Paso,
Western Metal Mfg. Co.
TEXAS—Houston,
Lone Star Culvert Co.
UTAH—Woods Cross,
Utah Culvert Co.
WASHINGTON—Spokane,
Spokane Corrugated Culvert & Tank Co.

When writing to advertisers please mention The Irrigation Age.

This Book Shows How to Plan a Private Irrigation Pumping Plant



It also shows all of the various types of pumps to meet the conditions found in different localities, tells how to select the proper pump for your conditions, how to determine the amount of power you

will need and all the other things the irrigator needs to know.

One will be sent free on request as long as they last. Write today

THE GOULDS MFG. CO.
LARGEST MFR. OF PUMPS FOR EVERY SERVICE

174 Fall Street, Seneca Falls, N. Y.
Branches in All Principal Cities

EDWARDS REVERSIBLE 4 HORSE ROAD GRADER



AN UP TO DATE MACHINE FOR BUILDING AND MAINTAINING ROADS

Having a complete line of adjustments it is equally well adapted for making ditches, both for dry land irrigation and rice field work.

I also manufacture THE RURAL ROAD GRADER and IRRIGATION DITCHER, STUMP PULLERS and other machines.

Write for descriptive catalog and prices.

C. D. EDWARDS, Albert Lea, Minn.

Gates and Flumes

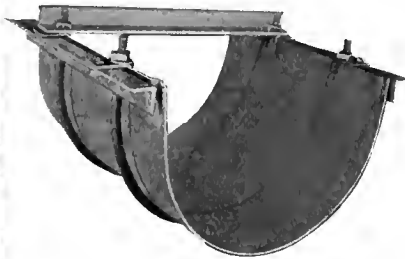

The simplest and quickest erected flume joint on the market, consequently lowest in initial and final cost. Can be fabricated in the field on large jobs, effecting a great saving in freight.

We manufacture:

- Main Headgates**
- Lateral Headgates**
- Gate Valves**
- Metal Flumes**
- Steel or Wood Pipe**

We carry a complete stock of Wire Mesh and Steel Bars for Concrete reinforcement

Designs and estimates furnished on all irrigation structures and supplies.

Write us your requirements and full information will be sent.

Power Pumping Plants—Reasonable

The Fitts Machinery & Construction Co.
Main Office, McPhee Bldg., Denver, Col.

The Faithful Friend

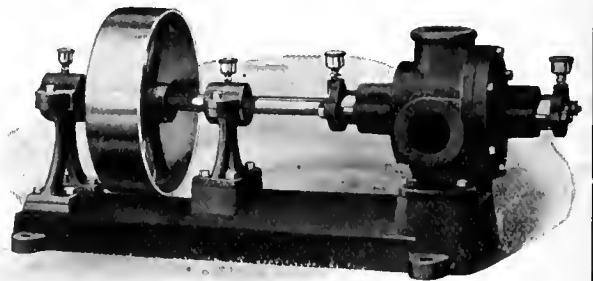

Do not be contented until you have the best, as these pumps have a good suction lift, with capacities of 12 to 500 gallons per minute, automatic take-up for wear, and free from springs or small parts that cause trouble.

SEND us your pumping proposition today, and let us quote you on the best pump made

Blackmer Rotary Pump Power & Mfg. Co.
PETOSKEY, MICHIGAN

THE IRRIGATION AGE

Vol. XXIX

CHICAGO, JULY, 1914.

No. 9

THE IRRIGATION AGE

With which is Merged

The National Land and Irrigation Journal

MODERN IRRIGATION

THE IRRIGATION ERA

ARIZONA AMERICA

THE WATER USERS' BULLETIN

THE DRAINAGE JOURNAL

MID-WEST

THE FARM HERALD

THE IRRIGATOR

D. H. ANDERSON

PUBLISHER,

CHICAGO

30 No. Dearborn Street,
Old No. 112 Dearborn St.

SUBSCRIPTION PRICE

To United States Subscribers, Postage Paid,	\$1.00
To Canada and Mexico.	1.50
All Other Foreign Countries,	1.50

In forwarding remittances please do not send checks on local banks. Send either postoffice or express money order or Chicago or New York draft.

Official organ Federation of Tree Growing Clubs of America. D. H. Anderson, Secretary.

The Executive Committee of the National Federation of Water Users' Associations has taken action whereby THE IRRIGATION AGE is created the official organ of this vast organization, representing 1,000,000 persons on the government irrigation projects.

Interesting to Advertisers

It may interest advertisers to know that The Irrigation Age is the only publication in the world having an actual paid in advance circulation among individual irrigators and large irrigation corporations. It is read regularly by all interested in this subject and has readers in all parts of the world. The Irrigation Age is 29 years old and is the pioneer publication of its class in the world.

D. H. ANDERSON, Editor

ANNOUNCEMENT.

The "Primer of Hydraulics" is now ready; Price \$2.50. If ordered in connection with subscription \$2.00.

The Irrigation Congress Must Be Saved

The Board of Governors of the Irrigation Congress has not yet taken any steps to rescind the despicable contract under which they sold the great organization to Canada. Preparations are going on merrily for the meeting across the border and the crafty Canadians are doing their best to obtain publicity for their lands by using the name of the Congress. A few newspapers are giving space to this publicity—but they are very few.

Among other documents which the Canadian boomers are again giving circulation in connection with the Congress, is a signed article by Frederick Haynes Newell, director of the United States Reclamation Service, in which he attempts to show the advantages of Canadian irrigated lands over those of the nation which pays him a salary.

Unless we are terribly misinformed, Secretary Hooker and the Board of Governors are not as well pleased now as they were when they had just completed the sale of the Congress. Their repeated "explanations" that the Congress had not been sold but just leased for a year, have met with little or no

favor among Americans. Papers throughout the West and many in the East have spoken in no uncertain words of condemnation of the "deal." Since THE IRRIGATION AGE revealed the fact that the Congress was sold despite the fact that Ogden, Utah, had offered to entertain it, the excoriations of the Board of Governors have grown even more vehement.

Meanwhile, the Canadians, having found that for their \$10,000 they had received little else but an opportunity to pay Secretary Hooker's magnificent salary, have become peeved. When the ruse of using the Congress in order to get their land boosting publicity into United States papers failed to work, they became even more peevish. As a result, Secretary Hooker, we are told, has been sat upon frequently and strenuously during the past month, and he is feeling not at all good. The Canadians have announced that they will do most if not all the junketing themselves, and this has not been pleasing to certain officials of the Congress, who expected to make a number of trips.

Some of the officials have even been so "impertinent" as to investigate the hurried summons

for Hooker to attend the recent Irrigation Conference at Denver.

Surely these men, who sold the Congress, are in a sad plight.

It would be no more than fitting to let Hooker and the Board of Governors continue to suffer humiliation at the hands of the purchasers of the Congress, if it did not mean peril for the Congress itself.

But the Irrigation Congress should be saved. It should not be prostituted to boom the lands of an alien nation. It was organized to aid in the development of the West of the United States. That is its one great purpose and mission.

If the Board of Governors and Secretary Hooker haven't enough red-blooded patriotism in their veins to undo the deal which they have made they should resign at once; the executive committee of the Congress should be called together and steps taken to restore the Congress to American soil and to the purposes for which it was originated and built up. The sale of the Congress must be stopped.

Better the Irrigation Congress die than be sold into slavery to the Canadian land boomers.

**Mr. Hill's
Indictment
of F. H.
Newell**

Louis W. Hill, president of the Great Northern Railway, had just completed a trip over the vast system which he controls. He was accompanied by a party of men, prominent in many walks of life—all of them hard-headed business men, with the interests of the West at heart. A Western town was banqueting Mr. Hill. He was asked to speak. His mind was filled with those things which he had just seen; with similar things which he had seen on many other trips through the West. He cited the Williston pumping project in North Dakota, and the Fort Peck and Milk River projects in Montana, all Federal government enterprises, and then he delivered this stinging indictment of F. H. Newell, director of the Reclamation Service:

"For fourteen years practically every man owning water rights under these projects has surrendered his rights to the Reclamation Service, and nothing has yet been done. These countries have been set back a generation through Newell's incompetency and prejudice. Newell has killed these countries, and it is felt that he has been a national calamity.

"If the rottenness and incompetency of Newell's administration should ever be brought to light the Eastern states would all be against any further reclamation activity."

Mr. Hill added that he hoped Newell would attempt to make him prove his indictment in the courts. Mr. Hill is a responsible citizen of considerable wealth. The press wires carried his state-

ment to all parts of the nation. There was no response from Newell. He has permitted the indictment to go unchallenged.

Newell's defense always has been that the complaints against his regime came only from a few disgruntled settlers here and there. He has succeeded in making official Washington believe this, and, aided by the powerful political interests to whom he has been able to show very substantial favors, he has hung on to his job and laughed and smirked at the suffering settlers.

The indictment brought against him by Mr. Hill is not that of a poor, defenseless settler. The charge is made by a man schooled in engineering affairs, a thorough student of business, big and little; by a man in constant touch with the men and women who live on Federal projects; by one who has opportunity to observe conditions on these projects and compare them with conditions elsewhere. The indictment is brought by a man who is recognized among his fellows as brainy, conservative and careful.

We believe Secretary of the Interior Lane is already fully informed of the observations of Mr. Hill and other big men of the West concerning Newell and his activities. Why has Secretary Lane not acted?

Surely he is not afraid of Newell and the powerful interests who are backing him. We believe Secretary Lane is too courageous to be frightened even by such great political power.

Or does Mr. Lane feel the same fear that is expressed in the last paragraph of Mr. Hill's indictment—that an exposure of Newell and his methods will mean an end to Federal reclamation. If that is the excuse for keeping Newell, THE IRRIGATION AGE contends that it is a very poor one.

The East is too great, too patriotic, and, if not these, too mercenary to halt a great work such as Federal reclamation just because it may be shown that more than one-third or one-half of a fund of \$100,000,000 has been lost or wasted or thrown away through incompetency. No, the East will not stop reclamation work, but instead, if told the truth, the East and the South and the North will be found working with the West to clean out this incompetency, to relieve the present burdensome conditions under which the settlers are struggling, to eliminate bureaucracy and bring about American rule, to furnish funds to correct the errors and waste of the past and to complete the projects, and to see to it that the settlers on the Federal projects are made to pay only for what they have actually received.

It is time to tell the truth, and the full truth, about Federal Reclamation. No threats by any

large or small Reclamation Service official of abandonment of work in any state should be permitted to halt a full revelation of conditions.

If the Borland inquiry does not dig deep enough to cause a thorough house-cleaning and the elimination of the bureaucracy in the Reclamation Service the settlers should demand another investigation at once. They should see to it that Congress grants it, and grants it without any strings by which the powerful interests behind the bureaucracy can control it.

Until the rotten spots are removed from the Reclamation Service, the Federal Water Users are going to be in hot water. They have been there long enough. It is time that they be given opportunity to live as befits an American citizen and that greatest of all American citizens, the American farmer.

The Warning of a Man Who Knows

Sir William Willcocks, the eminent British engineer, who was hired by Secretary of the Interior Lane to inspect the government irrigation projects, sounded a remarkable warning against extravagance in the use of irrigating water in a recent speech in Boise, Idaho. It is a warning that every irrigator should take to heart, for it applies not only to the district of which he was speaking on that particular day, but to the whole irrigable area of the United States.

Seepage means ruin—it should be guarded against constantly.

Here is what Sir William said:

"I feel as if I should say something about what I have seen in my visit here. I think I may say I know thoroughly the subject of irrigation. In fact, I know little else. Music, for instance, means nothing to me. I know nothing of politics and of general topics of interest. My father was an irrigation engineer in India and I began working with him at 12 years of age. I am now 62, and have worked and plodded on irrigation and nothing but irrigation for fifty years.

"I have been employed in India, Egypt, and am familiar with conditions in Turkey, in Arabia, in Italy, but never in my whole experience have I seen such a willful waste of water or seen water so injuriously applied as here.

"Let me tell you of the Boise valley that you have sufficient water flowing through your canyon of the Boise river to irrigate 400,000 acres, and if that water is used on a smaller area you are going to ruin your land. You are ruining it now.

"From what I have been told, your Twin Falls

South Side canal is using water on 160,000 acres that is sufficient for 300,000 acres, and in a few years that 160,000 acres and your 120,000 acres will be damaged to an extent that will cost you a huge sum to repair."

Eastern Banker Finds West Prosperous

The West is much better off than the East, according to Frederick E. Farnsworth of New York, secretary of the American Bankers' Association. In a recent statement Mr. Farnsworth said:

"The West, it appears to me, is going to have one of the most prosperous years in its history. There's no business depression—plenty of money in the banks, lots of it; big crops coming in—in fact, tremendous crops. The West is better off than the East, because you have the crops to rely upon, while we are largely depending upon our manufacturing industries."

Investigations by THE IRRIGATION AGE confirm every word of this prominent New York banker. The outlook for the West this year is exceedingly bright. Its prosperity, too, is of the good, substantial, permanent variety and will prove lasting.

U. S. Wheat Crop Goes to 900,000,000 Bushels

The Department of Agriculture predicts a wheat crop for 1914 of 900,000,000 bushels; the greatest in the history of the United States; almost half the world's yield of wheat. The yield in 1913 was 753,000,000 bushels.

Heavy yields in all other lines of produce on United States farms are also forecast. It is probable that the farm products for 1914 will exceed the colossal figures of last year, when the American farmers produced more than ten billion dollars' worth of products.

It is an enormous contribution to the prosperity of the nation. The money transactions involved in the marketing of this stupendous output mean processes of exchange of which there can be no measure. When the farmers are paid for these products and when they in turn square off their annual balances and make their investments, it means a distribution of wealth and profits almost beyond calculation.

The wheat prediction has even a greater significance. It shows that the soil that had been depleted in its fertility is being restored. It means that better farm methods are applied and a larger output per acre secured. It also means, beyond doubt, that every process on American farms is undergoing change from haphazard and primitive

methods to enlightened endeavor, out of which better live stock, better poultry, better bookkeeping and better results are obtained.

The improvement of the soil is our national safety valve. We are multiplying in population far faster than we are multiplying our farm products. Our consumption is swiftly overtaking production, and it is national defense when the broad acres of our farms are increasing the treasures that they give to mankind.

Uncle Sam's Rules for Borrowing Money

While the average farmer in the West is more troubled trying to find money which he can borrow at a reasonable rate of interest than with any other problem, nevertheless he can no doubt derive some good from an investigation which Uncle Sam's experts have just made concerning farm loans. Out of their extensive studies these experts have evolved three rules, which are worth while remembering. The rules are:

1. Make sure that the purpose for which the borrowed money is to be used will produce a return greater than needed to pay the debt.
2. The length of time the debt is to run should have a close relation to the productive life of the improvement for which the money is borrowed.
3. Provision should be made in long-time loans for the gradual reduction of the principal.

The first rule is, of course, the key to the wise use of credit. Between borrowing money to spend on one's self and borrowing money to buy equipment of some sort with which to make more money there is all the difference between folly and foresight, extravagance and thrift. If the money is borrowed for a wise purpose it will produce enough to pay back principal and interest and leave a fair margin of profit for the borrower into the bargain. If it is borrowed for a foolish purpose, it will produce nothing and consequently there will be nothing with which to repay the loan. From this point of view it matters comparatively little whether the interest be high or low. It is the repayment of the principal that is the chief difficulty.

Rules 2 and 3 deal with the most satisfactory ways of repayment. Underneath them both is the same principle: The loan must be repaid with the money it earns itself. For example, if the money is used to buy a machine that will last ten years, the machine must earn enough in that time to pay for itself or it never will. The loan, therefore, should be entirely repaid before the ten years are up or the farmer will lose money on the transac-

tion, paying out interest for no benefit in return. On the other hand, if too early a date is set for repayment, the machine will not have had sufficient opportunity to make the requisite money and the borrower may have difficulty in raising it elsewhere. Rule 3 provides for some form of amortization, the system by which the principal is repaid in installments so that the amount of the loan is continually diminishing and in consequence the interest charges also.

Some Canadian Figures on Wheat

A commission appointed by the government of Saskatchewan "to examine into the ways and means for bettering the position of Saskatchewan grain in the European markets," has just made a report, which every American farmer should read. The report will prove of particular benefit to those farmers who have contemplated crossing the border into Canada. The report tells a story entirely different from the alluring advertisements with which many farmers have been induced to leave the United States.

The cost of producing wheat as determined by the commission is reported to be 55 cents per bushel on the farm and 62 cents per bushel f. o. b. cars at country points.

According to the report, the cost of production has increased 12:15 per cent since 1909, while, on the other hand, the price of wheat to the Saskatchewan farmer has decreased from 81 1-5 cents per bushel in 1909, to 66½ cents per bushel in 1913, leaving a net return, on this basis, of 4½ cents per bushel to the farmer.

A. P. Davis Tackles The Wily Chinees

A. P. Davis, chief engineer of the Reclamation Service, has been sent to China to help the new Republic solve its flood problems. Davis, no doubt, can find plenty to do among the wily Chinees to keep him occupied for several years. Meanwhile, some of the problems of the projects under the Reclamation Service can no doubt be worked out. Davis' absence will perhaps facilitate the solutions.

THE IRRIGATION AGE suggested this Chinese job for Director Newell, believing it offered Secretary Lane an easy way of eliminating that person from the Reclamation Service.

We are just about as well pleased that Davis should have been sent, as we believe he is almost equally to blame for the present terrible conditions on the Federal projects and for the tremendous expenditures for which the government can never justly expect any return.

MELILOTUS ALBA—NO LONGER DESPISED



E. G. Finnup, who has 3,000 acres seeded to sweet clover.

MELILOTUS ALBA!
Do you recognize the name?
No?

Well, he is an old friend of yours—or rather you have considered him a foe, if you have lived east of the one hundredth meridian. If you have farmed in the eastern country you have waged relentless war upon him. Even the state legislatures have passed laws to exterminate him.

But he would not be downed. No matter how poor the land or how gravelly the roadside, *Melilotus Alba* found some spot to call home and to grow and to thrive. None but the bees and their masters ever said a kind word for him, but still his white blossoms, with their fragrance, and the deep green of the leaves, continued to lend cheer to friend as well as foe.

And still you don't recognize *Melilotus Alba*? Well, his other name is Sweet Clover.

And now Sweet Clover defines dollars instead of noxious weed.

Its value as a hay and forage crop has been proven, and hundreds of farmers have seeded fields with it this year. Thousands more will do so next year. The demand for sweet clover seed is greater than the supply today.

Investigation has proven that it compares favorably as a forage and hay crop with alfalfa. It is superior in some particulars to red clover. It has a more beneficial effect upon the soil. It has a high protein content.

Sweet clover will grow where hardly anything else will grow. It has been found to do well in land too high in alkali for anything else to live on. It

grows on land too wet, too dry, or too rocky for other crops. But it is not only a waste land crop. It is a crop that will pay well on the best land on the farm, and many farmers are seeding their choicest pasture to it. It is drouth resisting; therefore valuable where the rainfall is light.

Cattle will not eat it? True in many cases. Probably you had to learn to eat olives or rattlesnake steak or muskrat roast or snails or any of the other high-priced delicacies of one of Chicago's gilded restaurants. Cows, horses and other livestock are a good deal like humans. Some even have to learn to like corn.

Sweet clover makes very good pasture in early spring, and if the stock is turned in while the leaves are young and succulent, they quickly develop an appetite for it. After becoming accustomed to it, many cattle eat it in preference to other kinds of hay.

There are numerous varieties of sweet clover, but *Melilotus Alba*, the ordinary white blossomed kind, is generally considered the most valuable.

One of the pioneers in the sweet clover industry was E. G. Finnup, whose farm is located near Garden City, in Finney county, Kansas. He has 3,000 acres in sweet clover this year. But let him tell his own story.

"I started to feed this sweet clover about eight years ago," said Mr. Finnup. "It is the white blooming variety (*Melilotus Alba*), which is considered the best; and from watching my stock feeding on it I began to believe that they did better on sweet clover hay than most any other roughness, so I com-

menced to spread the fields and now I have about 3,000 acres.

"Sweet clover has proven to be as good feed for all kinds of stock as alfalfa.



Spring lambs pasturing on sweet clover on W. U. Sanderson's Farm at Nysta, Ore.



Handling sweet clover with a "boat sled." From 1,500 to 2,000 pounds of sweet clover hay can be carried to the thrasher on one of these sleds, 2x12x20 feet. Any seed, which is shattered off the shocks into the boats, is swept up and saved.

"It makes a better early pasture, will not bloat stock, and is easier grown.

"It grows without much preparation of the ground, and will grow on ground too poor for any other crop, and is about the best fertilizer for worn-out soil of any of the clovers.

"In 1912, from 120 acres of ground, I got a little over 900 bushels of seed, which sold for \$10 to \$15 per bushel. That year I sold a carload to one seed house—the first carload lot known to have been sold by any grower of sweet clover.

"In 1913 I harvested about 600 bushels off 200 acres, and it is selling at \$15 per bushel for the hulled, re-cleaned seed.

"I attribute the reason for sweet clover seed being so high and alfalfa seed so cheap to be because alfalfa will grow in only a few states profitably, while sweet clover will grow in nearly every state in the Union, if not in every one.

"It produces the best blossom for bees of any of the clovers. It is a help to orchards, keeping down weeds, making hay as well as fertilizing the land.

"I cut my first crop for hay the latter part of May. The last of August the seed is ripe, then another short hay crop. You can allow the first crop to go for seed, but the stems get pretty thick and tall, so that it is harder to handle. It is a biennial legume plant, so that the first year it does not go to seed, but will seed the next year. Enough seed falls off every fall to reseed the ground, so that it is a continuous crop similar to alfalfa.

"I thresh with a regular grain separator—either out of the stack or shocks. I think 10 pounds of seed per acre is sufficient to sow in this section. I prefer to sow in the fall and winter. A good many have excellent success by sowing in February, March, April, May and June. I think a good deal depends on the season; in fact, almost all.

"Prepare land about as for alfalfa. I have had good success, however, by sowing right on the sod and then harrowing or discing. The yield is about the same as alfalfa, but it makes a larger tonnage than alfalfa under similar conditions.

"It seems to stand all kinds of pasturing, both in the spring and fall. I know of some fields that are pastured clear up into May and then make a good crop of seed and a hay crop besides. I do not think it lasts as long as alfalfa for pasture in the fall. There is no bad effect on the milk of cows pasturing sweet clover or eating the hay. I refer to the white blooming variety.

"I am absolutely positive about it not bloating any kind of stock, and it will not give horses the heaves like alfalfa sometimes will.

"A good crop of seed averages from about 4 bushels to 15 bushels per acre. I consider it equal to alfalfa as a feed; that is the reason I am growing it in preference to alfalfa, one of the reasons, at least."

CONVICTS CLEAR IDAHO LANDS

Idaho has put its convicts to work clearing and developing state lands in the Gem Irrigation district. The land will be sold, after the convicts complete their work of clearing off the sage brush and ditching, as improved farms. The land is expected to bring close to \$100 per acre. Pending their sale, the improved lands will be used to raise produce for the prison.

Governor Haines, who originated the policy, believes he has solved the problem of finding a healthful employment for the prisoners. He also expects the development on the Gem project and on others where the state holds lands, to cut a big hole in the annual taxes.

The Gem Irrigation district is one of the most promising irrigation tracts in the West. It comprises about 30,000 acres of land, included in which are about 8,000 acres of state lands. These lands sell for from \$20 to

\$30 per acre in their raw state, in addition to which the purchaser buys a water right from the district. The land is excellent for fruit. It is located about twenty miles southwest of Caldwell in the Snake River valley.

SHOSHONE PROJECT GETS CREAMERY

Water Users and business men in the Shoshone, Wyoming, government irrigation project have organized a creamery company. The company is capitalized at \$10,000. No stockholder can own more than one share of the stock, the par value of which is \$50.

SOUTH AFRICAN PROJECT ASSURED

The long-proposed Crocodile river, South Africa, irrigation scheme now seems certain to be realized, the cost being estimated at \$3,310,000. The area brought into condition for cultivation will be 66,000 acres.

Cuts used with the Sweet Clover article are from photographs made for the International Harvester Co.



W. J. Bryao in clover. This photograph shows the Secretary of State and a party of friends inspecting a field of sweet clover in E. C. Fionup's farm near Garden City, Kan. This field stood 3½ feet high in the middle of June.

The Federal Water Users



A Department Devoted to the Interests of the Farmers on the Government Irrigation Projects

EDITED BY GEORGE J. SCHARSCHUG

TRUCKEE-CARSON WINS W. U. ASSOCIATION

FEDERAL WATER USERS on the Truckee-Carson project in Nevada will meet July 11 to complete steps for the formation of a recognized Water Users' association.



Fulton H. Sears
(Fallon, Nev.)

The organization meeting will be a victorious culmination of a fight extending over many years for the creation of such an association. The Truckee-Carson Water Users have had a voluntary association, but never succeeded in being recognized by any Secretary of the Interior, because of the opposition of F. H. Newell, director of the Reclama-

tion Service, and other officials to any thorough organization of Water Users. Demands for charter membership of at least two-thirds of the settlers on the project and for the acceptance of the charter-form created for new projects were the weapons used constantly to keep the settlers from organizing. This was done despite the fact that the Water Users' contracts demand that they belong to a Water Users' association.

Despite these tactics, the Water Users, realizing the value to themselves and their project of a recognized association, kept up their battle to obtain one. Fulton H. Sears, former president of the voluntary association, and member of the Executive Committee of the National Federation of Water Users' Associations, led the fight, and to him is due, largely, the credit for obtaining acceptance by the Reclamation Commission of a charter which is also satisfactory to the settlers. This charter is the most modern and advanced of Water Users' association contracts with the government, as it not only fulfills all the requirements of the Reclamation Act, but also contains provisions for co-operative enterprises of all kinds among the settlers. Under it the Water Users can do co-operative buying and selling, banking, build mills, warehouses, cold storage plants, and provide other necessary equipment for handling the produce of the project. They are also given full powers under which they can operate their project when it is turned over to them by the government.

Obtaining of approval of this charter was no small task. Mr. Sears made several trips to Washington to obtain aid from the various Secretaries of the Interior in forming an association. He told the officials that conditions on the Truckee-Carson project, the oldest among all of them, were such that it was impossible to get the settlers to accept the more or less archaic form, which the Reclamation Service adopted when associations were formed on newer projects. He explained that the government had attempted to settle for private water rights through individual contracts in the Truckee country, driving a different deal with each water owner, instead of working through an association, as was done on the newer projects. But all in vain.

Finally a conference was arranged in Chicago between W. A. Ryan, comptroller of the Reclamation Commission, Mr. Sears, and the editor of the Federal Water Users' department of THE IRRIGATION AGE. The situation was explained fully to Mr. Ryan. It was agreed that Mr. Sears should draw such a charter as would comply with the Reclamation Act, and which also would meet the needs of the Truckee-Carson project. Mr. Ryan agreed to see that it received the attention of Secretary of the Interior Lane and the Commission.

The charter was examined thoroughly by Judge King, counsel of the Reclamation Commission, and with some minor changes, approved by him. These changes were accepted by Mr. Sears.

Then came a long wait. Finally, early in June, word came from Judge King that as soon as the association was organized, Secretary Lane would recognize it by entering into a contract with it. Mr. Sears immediately began work of arranging for the organization meeting. Harvesting of alfalfa made it necessary to delay the meeting until in July, but meanwhile the Water Users have had opportunity to study the charter closely, and it is believed in Fallon that a very large percentage of the settlers will join the association at the first meeting.

VOTE FUNDS FOR WAPATO PROJECT

The Senate voted favorably recently on an amendment to the Indian appropriation bill, providing \$200,000 for starting work on the Wapato irrigation project on the Yakima Indian reservation in Washington. As the House had already passed the appropriation bill, construction of the project, which will put water on 60,000 acres and provide storage supply for another 60,000 acres, is assured.

MAKE THE FEDERAL WATER RIGHT AN ASSET

A Water User Tells How the Government Can Solve Its Irrigation Problem

By JOHN C. BELL

Associate Judge of the Court of Appeals of Colorado and a Water User on the Uncompahgre Project.

I WAS directed by the committee on Irrigation at the Denver Congress to present the question of finance for the farmers under the Irrigation projects to the Congress. Under this topic I referred to the question of the government making a water right not only a burden and an encumbrance upon the land to be watered, but even upon the cheap unwatered land, which was not tillable, and also on any watered land the owner might possess.

The government, in taking subscriptions upon lands held in private ownership, requires the subscriber to subscribe all the land he has, whether watered or unwatered, tillable or not tillable; then they record this subscription as a lien upon his watered land, that to be watered, his tillable land and that which is not tillable, then hold the water right as security for the payment of the water itself.

Where a private corporation builds a ditch, it usually regards the water worth all it charges for it; it holds the faucet and turns the water on when the fixed charges are paid. It generally gives indulgence to the farmer from the beginning to the end of the irrigation season, with the agreement that no water can be applied to the land in the future until all arrearages have been settled, hence any man who wishes to cultivate his land the second year cannot have the use of water until the arrearages are paid. This has been considered sufficient security for a private corporation. Why should it not be for the government?

The subscribers, when putting in all of their realty, with the understanding that the watered and non-irrigable lands were to be eliminated, understood that the elimination would take place in a reasonable time after the subscriptions were made, so they would at least have their non-irrigable and watered land as an asset; but, instead of this elimination being made within six months or a year, as anticipated, the government has held it throughout the long period of

construction and until the completion of the project, in cases now running up from near the date of the beginning of the first projects in 1902 and 1903 to

the present time, and with, probably, from four to six years more to be added.

If the government intends the water to be worth what it is charging, why should it not be as liberal with the citizen as the private corporation, and hold the faucet and pledge of the water, and give the farmer a chance to make a crop and pay his annual charges therefrom and, if he



A Cherry Orchard in Blossom, near Rifle, Colo.

neglects to pay the first year's charges before he requires a second year's use of water, then withhold the second year's use until his use for the first year is settled? Under the Uncompahgre Project the Montrose & Delta Canal, now owned by the government, was run successfully under the suggested system by the Travellers' Insurance Company under a long ownership by it, to the mutual benefit to both the owner and the farmer.

This is the simplest and easiest way for the farmer to get the money with which to pay for his water. Often his swamp lands or cheap lands, not worth the price of government irrigation, may be covered with spring flows, or accessible seep water, making it worth from \$10 to \$20 an acre, which would be an asset upon which he might obtain small loans if the government would relieve it from its subscription, as it promised to do when it obtained it.

There is no person so interested in making homes for the people as the government itself. Every time it makes an American home it has the assurance of an American patriot. The farm raised boy is never over-specialized, but is taught a diversified system of labor, and, if he cannot do the thing of his choice, he can do anything that turns up. It is a rare thing to find the farm boy tramping the roads for lack of employment.

It is from the ranks of those who are over-specialized to the performance of one or few duties that become helpless in limited labor markets. The men who arm themselves against the constituted authorities of the government are usually of the homeless and propertyless classes. It is the duty of the government to

exert an influence to overcome the necessity of anyone becoming homeless or propertyless.

It has been the general opinion of the man on the farm and who must pay for this reclamation that the government should not encumber either the land watered by it or the non-irrigable land, or that watered by the individual, but that the government should leave these assets for use of the owner in preparing himself to pay the government price for water. The present system makes the water purchaser a quasi ward of the government. It resembles in a measure the treatment of the American Indian. The government required the Indian to take his land in severalty, then did not permit him to sell it, obtain credit upon it, or to use it as an asset. The same rule applied to the white man would make him helpless and a failure on the farm, but, probably, not to the same extent as the Indian has been.

The way to make the farmer progress under the Reclamation projects is not to give him alms to weaken his self-reliance, but to give him the liberty of use of his property in making his own development. If the government will give the farmer freedom of action in the use of his land and a reasonable time in which to pay for his water on such terms as private corporations or individuals have done, with the elimination of the interest charge, then if the farmer does not succeed in general it is a waste of effort to attempt to keep him

on the farm, and the quicker he sells out and engages in some other vocation the better it will be for the government and the inefficient land owner. However, the government cannot afford to make this water right that it proposes to provide for the farmer by mere advance of money without interest, an incumbrance rather than an asset.

The harsh and exacting system of administration discourages and deters the poorer classes from trying to water or develop a home on arid land. No feasible system, manacled with hard and fast rules made equally applicable to all arid lands scattered over distances of from fifteen hundred to two thousand miles, while bodies of land in close proximity to each other require different administration, can be even passably successful.

What the farmer needs and must have to succeed is liberty of opportunity to sell, trade, use and encumber his lands in whole or part for the purpose of developing the same, stocking it or selling part to aid in improving the remainder. No one not actually in the harness and familiar with all the attending circumstances is qualified to say what is best for the farmer. The best financial policy that can be furnished the farmer is to relieve his land of all burdens, and allow him to work out his own development in his own chosen way.

LANE DENIES PLEA OF BLACK CANYON SETTLERS

A STORY by F. G. Burroughs, of Caldwell, Ida., in the June issue of THE IRRIGATION AGE, told how the settlers in the Black Canyon country—the abandoned portion of the Payette-Boise project—have struggled against almost insurmountable obstacles. It told how these men, despite their desertion by the Reclamation Service bureaucracy, which had invited them to settle on this project, have never lost faith in their government, and remained enthusiastic, patriotic citizens.

THE AGE commented editorially on this story and urged Secretary of the Interior Lane to take steps to carry out the promises of F. H. Newell and his ilk, whom the Secretary is still keeping on the government payroll. The Caldwell, Ida., News reprinted THE AGE editorial on its front page. In its editorial columns it had the following to say:

"Returning members of the delegations which visited Washington in the interests of the Black Canyon report that Secretary Lane refuses to recognize the fact that the Black Canyon was originally a part of the Payette-Boise project and was settled up as such. The Secretary is reported to have said that 'While promises made by a preceding Secretary of the Interior could not be regarded as binding upon his successors in office, it would be necessary to regard the Black Canyon as a new undertaking,' and added the consolation that 'the fact that the settlers there have endured and suffered would certainly lodge in the minds of those who will designate where new enterprises shall be located.'

"On another page we print an editorial written by the editor of a great Chicago irrigation journal

(THE IRRIGATION AGE), who has had exactly the same facts presented to him that were shown to Secretary Lane. It is a striking commentary upon the difference between the cold-blooded official viewpoint and that of a man whose heart is with the irrigated west.

"At that it is hard to see how the Secretary reaches his viewpoint. The Black Canyon (or North Side section of the Payette-Boise project) WAS a part of the original project. The settlers WERE induced to come and settle there upon the same promises of the government and at the same time as the completed section. The records of the Reclamation Service DO PROVE this fact. Former Secretaries of the Interior HAVE admitted that this is a fact. And yet along comes Lane and says that from HIS VIEWPOINT the Black Canyon is to be regarded as a 'new undertaking'!"

HELPS THE "STUNG" HOMESTEADER

W. A. Ryan, comptroller of the Reclamation Commission, announced a new policy of Secretary of the Interior Lane during his recent visit to the Uncompahgre project in Colorado.

He said that where a homesteader has taken up a homestead under the project and after living on it for the allotted time it is found that his land is not irrigable or not feasible under the project, the department is inclined to permit him to relinquish the non-irrigable homestead and select from the land under the project unentered, but at present withdrawn, another homestead, giving him credit on the new homestead for all the conditions he has already fulfilled on the original homestead.

THE STORY OF A FEDERAL WATER USER

This Simple Statement of Facts Shows the Kind of Stuff the Settlers Are Made of

By A. L. GURWELL

A Water User on the Belle Fourche, S. D., Project.

As a Water User on the Belle Fourche (S. D.) project I am in the fight against Newell and his bureaucracy for justice and equity. I filed on a farm unit here in 1910. I had a wife and five children, about \$4,000 and a carload of equipment. Today my money is gone, I am in debt and have nothing left, speaking in a business way, but muscle

and brawn to continue the battle. Thank God Newellism hasn't been able to deteriorate that.

I came to South Dakota to homestead land, expecting to have ample time to make my payments from the money, lands and labor invested. I understood that was the intent of the Reclamation Act. I was first required to make a payment of \$3.40 per acre cash down. I made my filing on March 1, 1910. In about 10 days my filing was turned down because 40 acres of the unit had been entered several years previous, and this entry had not been cancelled on records in the Land Office. I appealed to the General Land Office at Washington, D. C. There was delay in getting a decision until April 18, 1910.

Meanwhile I worked incessantly every day and a good part of the nights building fences, clearing sage brush land and breaking 30 acres. I seeded and irrigated the land, being forced to build ditches through my neighbor's farm to get water delivered to my own. The water supply was exhausted about July 1, and the crops were damaged very materially, notwithstanding Newell's reports and records at Washington to the contrary, so I have been informed.

I received orders from R. F. Water, supervising engineer, about July 1, 1910, that if I did not come through with two more payments on my land my water would be shut off. The order came through the local engineer, F. C. McGruder, in charge. I appeared at his office and notified him I would not make the payments, so my fight began.

I appealed through the local land office to Washington in November, 1910, and obtained decisions in my favor.

I made a short talk at the annual meeting of the Water Users in the fall of 1910, but it did not suit Newellism, for a day later I was approached by one of the Reclamation authorities, who tried to seal my mouth. The plaster Newellism compounds is no good, so did not partake. I wouldn't advise any Federal



Some Colorado Fogs, raised on a San Luis Valley Irrigated Farm.

Water User to let himself be silenced if he wants to be an American, or if he has a dollar, Newellism can squander in extravagance, waste and ignorance.

In January, 1911, I went to the engineer in charge and made inquiry if they would store water, so I would have water to raise a crop. I was assured that I would have plenty of water. I rented my neighbor's land,

about seventy acres, seeded it to grain, as I also did my own land. I received water with which to start the crop, but never threshed a bushel of grain. I cut something like thirteen small loads of burnt wheat and oats hay off my neighbor's land and a proportionate amount off my own. I lost a greater portion of my 1912 crop by hail, and failed to find a market for two carloads of onions.

With such conditions as these Newellism says come through and foot all the bills. Mortgage your land, sell your cow and your horse; run your face until it is no good, and then turn up your toes. But you must keep the Newellites riding around in automobiles, smoking cigars and wearing bull dog collars. The extravagant overhead charges of the Reclamation Service will break Uncle Sam, himself, if the brakes are not tightened.

Why is Newell retained at the head of the Reclamation Commission or permitted to have anything to do with it? This man has practically wasted \$40,000,000 of the people's money and a like amount of the Water Users' money, if all the other projects are in the same boat as is the Belle Fourche, as reports indicate.

The cry has gone up from all over the West to the seat of government, "Remove Newell." If it cannot be done in any other way, give him a pension. I will donate twenty-five cents a year to such a pension, providing that he is never again permitted to occupy a position by which he can blight the happiness and the homes of people as he has done in lording it over the Water Users.

Rally, Brother Water Users. Rally; don't give up or even think of such a thing. The day is dawning when you will be freed from Newellism, with all of its high-handed slavery and extravagance. Throw on the searchlight. Blow the bugle long and loud. The walls will crumble.

Continued on Page 281

CONGRESSMEN HUNT 20-YEAR BILL "LOBBYIST"

Mysterious Person, Who Suggested They Were Loafing, Scored in House

A MYSTERIOUS person, who is described as a Western man, is being hunted by the Congressmen from the irrigation states, with a large-sized club. If they find him, he is liable to be the subject of an "insidious lobby" investigation.



G. E. Rodman, Who Received the "Confidential" Letter

It is certain his name will get into the Congressional Record, accompanied by descriptions of him such as "bushwhacker, knave, ignoramus, m a r p l o t, grafter," and what not.

The mysterious person wrote a "confidential" letter to G. E. Rodman, secretary of the Sunnyside Water Users' Association of Washington, in which he charged that the

arid states' Representatives were negligent in pushing the Twenty-Year Reclamation Extension bill. He declared many of them were absent from the House when the bill was called up for passage in May.

Mr. Rodman, like many other Water Users, is anxious to see the Twenty-Year bill become a law. He immediately began a campaign of telegrams and letters through the Federal projects, seeking to "speed up" the Congressmen. He sent copies of the "confidential" letter, without its signature to various Water Users' Associations and others. The result was a flood of letters and telegrams to Western Congressmen.

When the bill was again called up for passage on the unanimous consent calendar on June 15, action upon it was promptly stopped by objection, but not until Congressman Hayden of Arizona and some others had had their say about the mysterious person.

"Recently a number of members from States in which Federal reclamation projects are located received letters and telegrams from Water Users' Associations and settlers on the projects urging them to greater activity in behalf of the reclamation extension bill," said Mr. Hayden. "Many of these letters and telegrams were of such a character as to impugn the good faith, the industry, and watchfulness of the members to whom they were sent, and all of them were evidently inspired by the same person. The insinuations which they contained were so grossly unfair and unjust that I have undertaken to ascertain, if possible, their source, in order that I might expose the despicable methods used to discredit among their constituents at least a score of men on both sides of this Chamber.

"I have secured a copy of a letter which discloses the reason why members have received these

letters and telegrams. Unfortunately the bushwhacker who made this attack has succeeded in having his name concealed on the plea that the information given was confidential in its nature."

Mr. Hayden read from the "confidential" letter. This paragraph was greeted with laughter:

If thirty projects can't muster sufficient energy and cohesiveness to raise, say, \$1,000 for expenses, travel, postage, correspondence, dispatches, etc., they don't deserve a great deal of sympathy.

"At the mention of this sum of money some members have been unkind enough to wonder whether in this secretive adviser might not be found another Col. Mulhall, who, for a suitable consideration, would consent to adopt this poor, orphaned measure and who would promise that under his lobbying care it would eventually reach the place where all good bills hope to go and become a law," continued Mr. Hayden. "It is said there are men who would stoop to deceive unsuspecting settlers in order to obtain the price of a meal ticket."

Congressman Mann, perhaps facetiously, suggested that Mr. Hayden start a Congressional inquiry immediately.

"Isn't that insidious lobby?" questioned Congressman Madden.

Mr. Hayden declared every member of the House Irrigation Committee except Chairman Smith was present on the day the bill was called up. He explained that objection to the bill had shut off debate. Then he continued:

"The man who sent out this letter stating that mere talk on the part of the Western members could have affected the result is either a knave or an ignoramus, and, whichever he is, his conduct is equally reprehensible.

"On receipt of this letter Mr. Rodman, without any attempt to verify the statements contained in it, immediately rushed to a printing office and had copies made for distribution among the Water Users of the entire West. With it he sent out the following letter:

"Sunnyside, Wash., May 26, 1914.

"To the Water Users' Associations:

"More information as to the opposition to the reclamation-extension bill impels us to urge the various associations to take prompt and vigorous action in favor of the bill, if they have not done so. Below are copies of the latest advices; as they are confidential, the name of the author is withheld. They come from a Western man who has been in Washington, D. C., now for some weeks and is thoroughly in touch with the situation, and we have full confidence that he is representing the condition as it actually exists.

"Thoroughly in touch with the situation, forsooth! And yet there is not a particle of truth in his letter that any Water User could not have obtained by reading the Congressional Record when it reached him on his own farm, 2,000 miles away from Washington. All that this evil-minded individual did was to read the Record here in Washington and then write a letter about it, in which he

Continued on Page 282

The Grimes Irrigat

Especially Designed for Irrigation
Lakes, Rivers, Canals and Shallow

Made to Order in Sizes and Lengths to Meet Local C

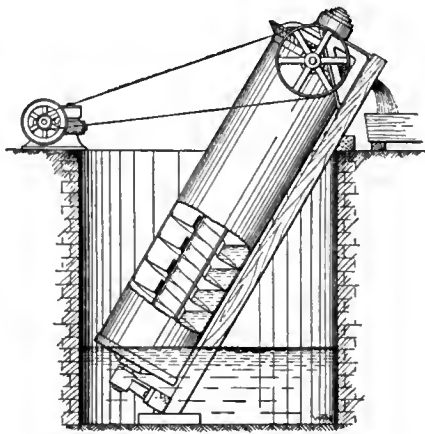

POINTS OF EXC

1. Unsurpassed simplicity of action—
Nothing to get out of order. Sand, gravel or mud conditions cannot interfere with constant operation of pump.
2. A solid, one-piece mechanism—
Powerfully constructed out of most durable materials. No valves, plungers or cylinders.
3. Low speed—24 to 50 revolutions per

*Guaranteed Ratings. 1000 gallons per min.
52 inch diameter pump.*

Lift	Horse Power	Lift	Horse Power
6 ft.	1.8	20 ft.	6.0
8 "	2.4	22 "	6.6
10 "	3.0	24 "	7.2
12 "	3.6	26 "	7.8
14 "	4.2	28 "	8.4
16 "	4.8	30 "	9.0
18 "	5.4		

Write

The Grimes Irr

1022 First Nat
DENVER

on Pump

umping from
Water Wells

itions and Requirements

LENCE

minute—an assurance of long life.

ght power requirement—See
ecimen rating in 1000 g. p. m.
zes. No other type of pump to
qual it.

pecial adaptation to Irrigation
umping.

ighest practical efficiency.

ost economical.

Booklet

ation Pump Co.

l Bank Building

OLORADO

Lamar Colo., April 13, 1914.

THE GRIMES IRRIGATION PUMP Co.,
Denver, Colo.

Gentlemen: Enclosed please find my check for two hundred and fifty dollars (\$250), balance due on pump, per our contract.

I have been using this pump constantly for ten days and find it doing more than your contract called for, and I think that, beyond all doubt, it is the best irrigation pump on the market, for it takes very little power and requires no attention from morning till night.

If I could not get another like it I would not sell it for three times what it cost me, and I predict your sales will be heavy as soon as its merits are generally known.

Yours very truly,
T. J. SAYLER.

Broadwater, Neb., May 11, 1914.

THE GRIMES IRRIGATION PUMP Co.,
Denver, Colo.

Gentlemen: I want to thank you for the good work done by your Mr. Grimes in helping me get my well in shape to receive the new 600-gallon pump, which is installed in fine shape and doing everything your contract called for.

I consider this the best investment I have made in some time for the reason that I get all the water I want, any time I want it, without asking a ditch rider any questions.

If I can be of any assistance in helping you place more of these pumps do not hesitate to let me hear from you.

Yours very truly,
WENZEL SCHMIOT.

THE GRIMES IRRIGATION PUMP Co.,
Denver, Colo.

Gentlemen: We are pleased to state that we were at Lamar, Colo., during the month of April, 1914, and witnessed the operation of the Grimes elevator that you installed for Mr. T. J. Sayler on his farm three miles northeast of Lamar recently.

This elevator was lifting 600 gallons of water per minute to a height of 16 feet with a 4-horsepower gasoline engine and doing the work easily, with plenty of power to spare.

After inspecting the plant we can easily understand why it cannot get out of order, even though worked in muddy or sandy water, and this feature, together with the small amount of power required, should attract the attention of any one who irrigates by pumping.

J. O. LOWE, Phillipshurg, Kans.,
Owner of 3,400 Acres Shallow Water Land in Powers County, Colo.

- GEORGE LAUTZENHEIZER, Kendall, Kans.
- J. D. THOMPSON, Farm Superintendent.
- T. B. OLDHAM, Capitalist.
- WARREN MUSGROVE, Auctioneer, Lamar, Colo.
- N. CARSON,
Supt. Intermountain Ry., Light & Power Co.
- C. C. HUDDLESTON,
Hardware and Implements, Lamar, Colo.
- E. BELEW,
Agriculturist, American Beet Sugar Co.,
Lamar, Colo.

- L. WIT MARKHAM,
Pres. Powers County Abstract Co.
- CORA R. STRAIN, President Strain Bros.,
Hay, Grain and Seeds, Lamar Colo.
- W. C. GRIER, Lamar, Colo.
- F. W. SAYLER, Manager Lamar Seed Co.,
Lamar, Colo.

IRRIGATION IN THE TEXAS PANHANDLE

MANY sections of the country are being made the basis of operations in irrigation work today, but there are few, if any, in which things are being carried on as in the Panhandle section of the Lone Star State.

Water was first successfully pumped in this district in the fall of 1911, and after several successful pumping plants had been installed, irrigation became the greatest industry of that section. Land values went up, towns boomed from a population of one hundred to that of five thousand in a single year. Now, a traveler entering this section will see pumping plant after pumping plant in operation and others going in on all sides. Every effort is being made toward the one object of getting more water at low cost. Land scorned ten years ago is now in a high state of cultivation.

Through the efforts of a number of more public spirited citizens of that section, the Pierson Syndicate was interested in the development of a large tract of land covering 68,000 acres. They are working on the gigantic task of developing wells on every part of this land, erecting house and barn on each quarter section and turning the complete outfit, including pumping plant, house and barn, complete for irrigation, with part of the land under cultivation, over to the home seeker. The Syndi-



A Texas Pumping Plant

cate's first purchase of engines for their requirements covered forty engines of the Two Cylinder Opposed Heavy Duty Type and corresponding pumps. Standard practice in this district is to mount the pump with a vertical shaft and operate it by twisting the belt from the engine, operating engine and pump at about 30-foot centers. The amount of water is measured entirely by a U. S. standard wire gauge, which, with the use of water tables, enable them to gauge very accurately the output of the plant.

Throughout this section the water strata lies at the depth of about 60 feet from the surface. No. 5 and No. 6 pumps are used to give a capacity of from 1,200 to 1,800 gallons per minute when operated by 35 to 50 H. P. engines. A man is placed on each plant to oversee the engine and pump and to superintend the irrigation through the various ditches. This method of operation and installation of pumping plants has been in use for upwards of eighteen months and the results are very gratifying. The finding of water at a level so easily accessible from the surface has proven a gold mine for that section. Land values have risen from one dollar an acre to upwards of \$200.00 an acre. This is not mere real estate boom or speculation; it is actual value of the land and it shows the advantage of placing a reliable engine and pumping plant on irrigable land.

IOWA IRRIGATOR USES ELECTRICITY

IRRIGATION by electrical power pumping is being tried out on Muscatine Island, near Muscatine, Ia., by F. X. Schaefer, who has an 80-acre garden tract. Several gasoline pumping plants are also being used in this important truck gardening district to guard against drought.

A distribution system in which galvanized iron piping is used, has been installed by Schaefer, and every inch of the eighty acres will be systematically watered during the dry season.

Truck gardeners throughout the eastern part of the state are watching the experiment with interest, and others are expected to install similar systems. The Muscatine Lighting Company is considering the extension of a wire through the island district, thus bringing power to every farm. To make the island farms droughtproof would result in a saving of many thousands of dollars annually to individual growers.

A loss of thousands of dollars was sustained this summer because of a lack of moisture during the strawberry growing season, and to preclude the

possibility of a melon failure, gasoline pumping irrigation systems have been established on a score of the largest farms. Mr. Schaefer is confident that the results which will accrue from his novel step will be such as to bring about the general use of electricity on the island and thus safeguard the richest melon producing area in the state of Iowa from crop failures.

NAMES IRRIGATION COMMITTEE MEN

Gov. Ernest Lister has named Attorney Ira P. Englehart of North Yakima, and E. F. Benson of Tacoma, formerly of Prosser, as the Washington members of the irrigation conference committee of thirty—two from each of the fifteen irrigation states—which was provided for at the irrigation conference at Denver in April. This committee is expected to work for co-operation between the United States and the Western states in the reclamation of arid lands. It will also seek more uniformity in the irrigation laws of the various states.

A PRACTICAL ALFALFA IRRIGATION GATE

By WM. H. CRIMMINS

A TYPE of irrigating check which was introduced on the Pacific Coast in the season of 1913, and which seems to operate to the satisfaction of ranchers engaged in the raising of alfalfa, fruits, berries, etc., consists of a length of corrugated galvanized pipe of high-purity iron, in the upper half of which a slot has been cut, through which works a flat disc of the same material. This slide is seated in a groove or nib, rolled in the lower half of the pipe, and is operated by means of a wrought iron handle which folds down over the pipe, and presents no obstruction when not in use.

The corrugated form of the pipe, of course, secures great strength and rigidity, and is also to quite an extent an insurance against wash-outs. This last is further provided against by the use of a galvanized iron bulkhead of sufficient size to prevent any streams finding their way around the outside of the pipe, or the falling down over its mouth of any of the material of the ditch bank.

The gate is made chiefly in the small sizes, and is useful for taking the water for the small laterals from the main ditch, thus displacing the temporary wooden boxes or the decidedly cumbersome concrete pipes which have been used for that purpose. It is not intended for high pressures, but is practically water-tight under the conditions to which it is adapted; and this quality is found to be highly important. The usual leaky box allows enough water to escape to result in a more or less water-soaked condition of near-by areas; and, in regions where the heat of the sun is extreme in the middle of the day, this often results in a serious scalding of the crop.

The contrivance is very light and conveniently handled, its installation being simply a matter of

A NEW TYPE OF IRRIGATION CHECK INTRODUCED ON THE COAST.

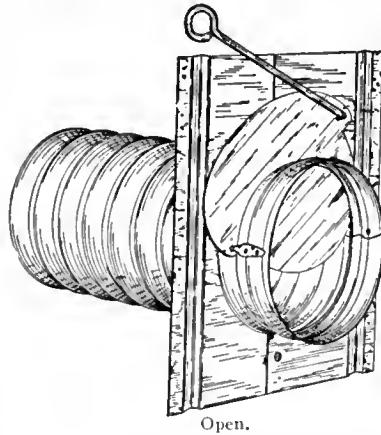

Open.

digging a trench and covering it over. The important consideration in this respect is the ease with which it may be removed to a new location. The cleaning of the ditches with a V-ing plow, to remove silt and weeds, or their relocating, makes necessary the removal of whatever gates and pipes are used

for these small outlets. With this corrugated device, which has been named the 4-C Gate, these removals are very readily made, and the same gate may be used in a dozen successive locations.

Probably the principal advantage of this type is in its perfect ease of operation. On a large system

the time of a responsible man for opening and closing the old-style boxes and valves constitutes a serious expense. These gates bear about the same relation to those formerly employed as a modern post-hole digging tool bears to a shovel and crow-bar. Anyone can open and close them effectively and quickly; and the saving in the time of capable workmen will soon amount to more than the cost of the improvement.

City Engineer Holmquist has made some very interesting installations of 4-C gates in the streets of Phoenix, Ariz. That rapidly growing city is in the midst of the Salt River Valley irrigation district, and there are some streets where open channels carry water by the side of the traveled way. These same channels serve to carry away drainage water during rain storms, and for this purpose are connected with the gutters by ingot iron corrugated pipes, running through the curb. To prevent a back flow from the ditch to the street at other times, these pipes are fitted with one form of the 4-C valve. Mr. Holmquist reports that the device seems perfectly adapted to the purpose.

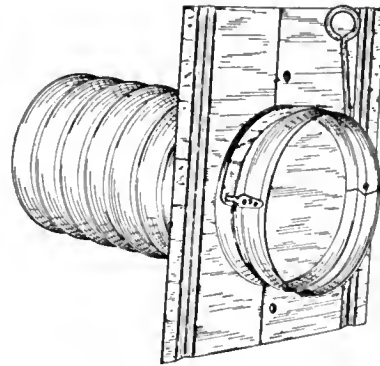

Closed.

GREAT PROJECT IS FINANCED

Completion of the necessary financial arrangements for the construction of a mammoth canal to store the flood waters of the Arkansas river, to be used for the irrigation of virtually all the vast territory between La Junta and Arlington, Colo., is announced by W. A. Colt of Las Animas.

The project will involve an investment of several million dollars. More than \$100,000 has already been spent in preliminary work.

The work is accounted among the greatest irrigation enterprises ever launched by private capital

in Colorado, and probably in the United States. It will bring under water thousands of acres of arid land, which is now waste, and provide homes for hundreds of families.

Plans for the project were perfected and work started several years ago. Financial complications arose and it was discontinued. These complications are said to have now been adjusted and, according to Colt, the construction work will be vigorously pressed.

The cuts on Pages 268 and 270 are from photographs made for the D. & R. G. railway.

BRIEF NOTES FROM IRRIGATION PROJECTS

Colorado.

The 1,800-foot siphon of the Oxford Farmers Ditch Company near Fowler, Colo., has been completed. The huge pipe was constructed at a cost of \$22,000, and will replace the company's old flume which has been in service for many years. The corporation was organized in 1887 as the Fowler Colony Company, and has been one of the oldest and best reclamation projects in the state. The present corporation, the Oxford Farmers' Ditch Company, was organized by those whose lands were embraced in the project. The company, which then had thirty-five stockholders, has grown until its list now numbers 150. The ditch itself, which is thirteen miles in length, cost \$36,000, and is accounted one of the best canals in the Arkansas valley country.

Dry land farmers east of Loveland, Colo., are negotiating for the purchase of Boyd Lake, one of the largest bodies of water in the northern part of the state. If the deal is closed it will mean that thousands of acres of dry land will be brought under irrigation. Dry land is at present averaging the farmers more than thirty bushels of wheat to the acre. With this same land under water supply, it is estimated the yield would be increased to fifty bushels. It is considered certain that the district would be converted into the best producing land in northern Colorado. The water would have to be pumped to the high land. This can be done at small cost.

The irrigation project started by the late Senator G. W. Swink, who planned to put 25,000 acres on Otero county, Colo., under water, is to be completed at once, according to an agreement between the Swink heirs and the stockholders of the Swink Ditch and Reservoir Co. The project will cost \$1,000,000.

The consolidation of the Omar and Van Sykes irrigation projects in Pueblo and Otero counties, Colo., has been effected. The new company will

be known as the Apishapa Consolidated Irrigation Company. The Omar irrigation district 20 miles south of Fowler is dissolved as a result of the consolidation. The value of the properties involved is estimated to be about \$1,000,000. The project will irrigate 50,000 acres of land and will construct an immense reservoir to take care of the flood waters and the water rights on the Apishapa owned by the company. A \$375,000 contract for this reservoir has been let. The land to be irrigated is located south of Fowler and is largely in Otero county with some tracts in Pueblo county. Several hundred farmers own land under the proposed ditches of the company.

Montana.

S. W. Bent, one of the large ranch owners on Sage creek, near Bridger, Mont., who has extensive sheep and

cattle interests, has completed the construction of a private piece of reclamation work of considerable proportions. By the erection of a dam 280 feet long and 50 feet high across the mouth of a draw he has provided a reservoir holding water to supply 300 acres.

Charging that they procured dummy entrymen to file on public lands in the Bitter Root valley, Ravalli county, Mont., which afterwards were deeded to the Bitter Root Valley Irrigation Company, the United States has filed suit against Walter I. Moody, Frederick D. Nichols, Harrison S. Lord and Robert A. O'Hara, officers of the company. The complainant asks that patents to the land be cancelled, in so far as they do not act upon innocent purchasers.

(Continued on page 278)

Only \$2 DOWN and One Year To Pay

For any Size—Direct from Factory

You can now get one of these splendid money-making, labor-saving machines on a plan whereby it will earn its own cost and more before you pay. You won't feel the cost at all.

\$24 BUYS THE NEW BUTTERFLY

30 DAYS' FREE TRIAL GUARANTEED A LIFETIME

No. 2 Junior—a light running, easy cleaning, close skimming, durable, lifetime guaranteed separator. Skims 95 quarts per hour. We also make four other sizes up to our big 600 lb. capacity machine shown here—all sold at similar low prices and on our liberal terms of only \$2 down and a year to pay.

Patented One-Piece Aluminum Skimming Device, Rust Proof and Easily Cleaned—Low Down Tank—Oil Bathed Ball Bearings—Easy Turning—Sanitary Frame—Open Milk and Cream Spouts.

You can have 30 days FREE trial and see for yourself how easily one of these splendid machines will earn its own cost and more before you pay. Try it alongside of any separator you wish. Keep it if pleased. If not you can return it at our expense and we will refund your \$2 deposit and pay the freight charges both ways. You won't be out one penny. You take no risk. Postal brings Free Catalog Folder and direct from factory offer. Buy from the manufacturers and save half. Write TODAY.



No. 514
Over 20,000
now in use

Albaugh-Dover Co., 2253 Marshall Blvd., Chicago, Ill.



THE TENT-COT
OPEN AND FOLDED

above the ground under a storm-proof covering that enables you to use the Tent-Cot every night in the year, and all the doors and windows are fitted with both storm and mosquito curtains that can be raised and lowered at will of the occupant. For anyone afflicted with lung trouble there is nothing equals the Tent-Cot. It also has a splendid appearance and can be set up on your porch, lawn or roof and taken down when not in use. Can be set up in a space 30x78 inches and only requires about 30 seconds to operate. It is ideal for hunters, fishers and campers as it eliminates all the annoyance of "making camp." With a Tent-Cot you carry your camp with you under your arm and sleep safe and sound any place.

SPECIFICATIONS—Length of cot open, 6 ft. 6 in.; width of cot, one person, 28 in.; width of cot, two persons, 44 in.; height of bed from ground, 17 in.; height of tent over cot, 32 in.; size of cot folded, for 1 person, 28x36; size of cot folded, for 2 persons, 44x36; weight, 1 person, 29 lbs.; weight, 2 persons, 44 lbs.; frame is of hard maple, painted green; covering is of heavy waterproof canvas in colors, tan or olive green.

PRICE—Tent-Cot 28 in. wide, open 1 side, \$9.00; Tent-Cot 28 in. wide, open 2 sides, \$9.50; Tent-Cot 44 in. wide, open 2 sides, \$11.50.

Manufactured
Exclusively by

ENTERPRISE BED COMPANY, HAMMOND, INDIANA

YOU SHOULD USE
The Enterprise Tent-Cot
"The Perfect Outdoor Bed"
For Porch, Lawn or Camp

The Enterprise Tent-Cot will protect you from all the discomforts and dangers of sleeping out. You sleep 17 inches above the ground under a storm-proof covering that enables you to use the Tent-Cot every night in the year, and all the doors and windows are fitted with both storm and mosquito curtains that can be raised and lowered at will of the occupant. For anyone afflicted with lung trouble there is nothing equals the Tent-Cot. It also has a splendid appearance and can be set up on your porch, lawn or roof and taken down when not in use. Can be set up in a space 30x78 inches and only requires about 30 seconds to operate. It is ideal for hunters, fishers and campers as it eliminates all the annoyance of "making camp." With a Tent-Cot you carry your camp with you under your arm and sleep safe and sound any place.

HOW TO PACK ALFALFA IN A SILO

BY M. E. SHERMAN

A Paper Read Before the Kansas State Board of Agriculture.

THE use of alfalfa as silage is rather a new idea to many people, yet since 1897 we have used it every year, often filling the silos the second time in the fall. The secret is simple and can be readily put into practice by anyone. The first thing is to cut the alfalfa when the bloom begins to show.

Wet it down thoroughly by having water dripping on it as it goes through the cutter. Pack it well by keeping the edges higher and tramping them firmly down. Give the silage time to settle well. My silo is thirty-two feet deep and twenty-six in diameter. I have found that when we put in ten feet as solid and wet as possible and we stop for a day or two, then put in up to the twenty-foot mark and after two days fill it up, we have caught up with the settling.

The first ten feet will often go down to five, then the next filling to the twenty-foot mark comes down to the fifteen or sixteen mark. We make the silo as full as possible and want it to heat up hot. The heat sterilizes and prevents any rotting of contents. It also cooks the mass. Woody alfalfa or over ripe stems will often show small spots of white mold due to the want of moisture to make enough heat and this indicates a lack of greenness in the plant. One of the latest advocates of alfalfa silage

recently told me that he wondered why he ever got along without a silo so long.

The alfalfa can be put into a silo full length or by cutting it into short lengths. The latter plan, however, makes the best silage, because it packs better and besides it is easier to get it out of the silo when wanted. Long alfalfa mats so firmly in the silo that it is anything but an easy matter to handle such an entanglement of stems and branches. Another reason for cutting is that it is difficult to elevate the alfalfa to the top of the silo. The easiest way to elevate it is by means of a blower after it has gone through the chopper. By using the cutter and blower all one has to do is to deliver the alfalfa to the cutter, and the machinery does the rest, besides making a better quality of ensilage and involving less work to remove it from the silo.

SOUTH AFRICANS STUDY U. S. METHODS

Fifty South African farmers will arrive in California early in August for the purpose of investigating irrigating systems and studying agricultural methods. The party will be made up of delegates from Cape Colony, Rhodesia, Natal, Transvaal, Orange Free State and Bechuanaland. Special attention will be given those parts of the country where climatic and growing conditions approximate those of South Africa.

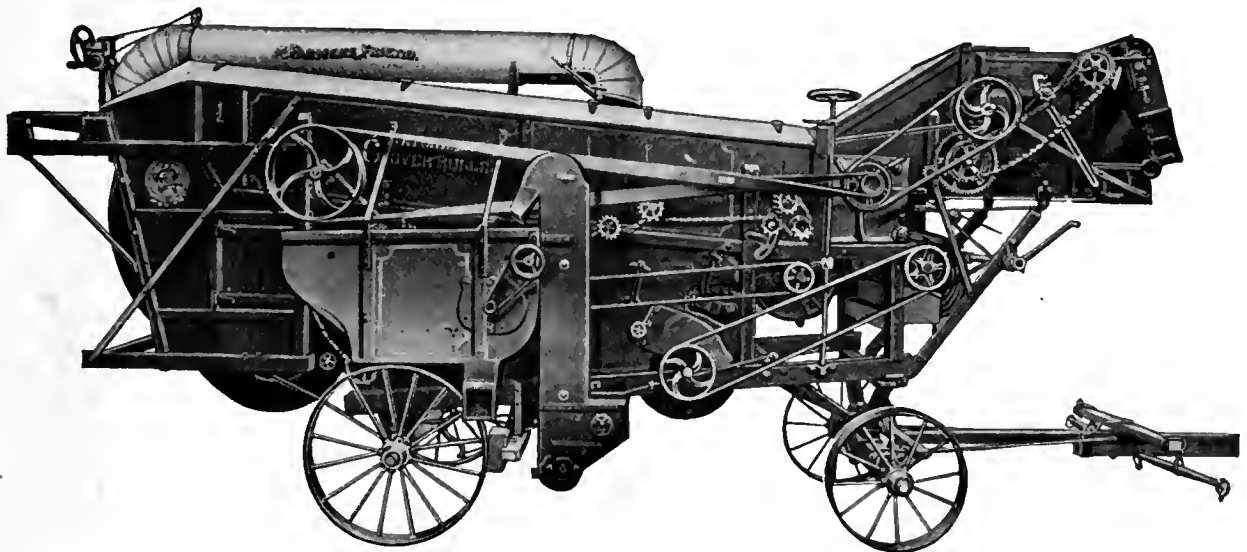

HULL YOUR SEED QUICKLY, PERFECTLY and ECONOMICALLY With a
"MATCHLESS" CLOVER and ALFALFA HULLER

That's just what you will do if you use a "Matchless" Huller on the job. It's the one huller that will hull all the Clover or Alfalfa you can get to it without sacrificing the quality of the work. Here's the reason! We use square steel brads in our hulling cylinder. This construction has every advantage over rasps of spikes, because no set of spikes will knock the seed out of the damp pods. Rasps gum up and are easily destroyed. Our system of separation is unique and effective. This consists of a series of rotating troughs with perforation in the bottom, with provision for adjustment to meet the various conditions of clover. The Patented Steel Scrapers attached to the bottom of these troughs thoroughly scrape the separator bottom and insure a steady and positive delivery of the pods to the hulling cylinder, regardless of the condition of the clover. This construction enables you to hull seed under conditions in which no other huller can operate; enables you to hull earlier in the morning and later in the evening than with any other—this insures a longer day, thus increasing your earning power. Give us an opportunity to prove to you right on your own farm that the "Matchless" is the speediest and cleanest huller on the market. WRITE FOR CATALOG TODAY, or call at our nearest Branch House.

THE AULTMAN & TAYLOR MACHINERY COMPANY, MANSFIELD, OHIO.

Sole Builders of Aultman-Taylor "Starved Rooster" Line of Machinery.

BRANCHES: Minneapolis, Minn.; Portland, Ore.; Lincoln, Nebr.; Kansas City, Mo.; Wichita, Kan.; Decatur, Ill.; Indianapolis, Ind.

When writing to advertisers please mention The Irrigation Age.

IRRIGATION NOTES

(Continued from page 276.)

Immediate construction of the high line ditch of the second unit of the Prickly Pear Valley pumping project, near Helena, Mont., is planned, according to an announcement by Max Hebgen, manager of the Montana Reservoir & Irrigation Company. It will reclaim 3,149 acres of land, and will be nine miles long. The water will be lifted by electricity from Hauser Lake, a height of 163 feet. Two lower ditches that will reclaim 8,636 acres of land will be built whenever sufficient land is signed up for water to justify the expense. At present only 874 acres have been signed. The first unit was constructed two years ago. It reclaims 6,000 acres, but not all of the land has been signed up under it, some of the large eastern land owners refusing to farm their land, and also refusing to consider any offers under \$150 an acre.

The Rock Creek Ditch & Flume Company has completed one of the largest irrigation projects in Granite county, Mont. This is a ditch and

flume 7½ miles in length and diverts the waters of the east fork of Rock creek from that watershed over the divide into the Trout creek district of the upper Flint creek watershed. This ditch carries approximately 1,000 miner's inches of water, which is calculated to be sufficient to irrigate 2,000 acres of land.

Nevada

A verdict in the case of the Porter Placer Mining Company vs. Mrs. Moses Stockdale is expected soon at Nevada City, Nev. A decision in the plaintiff's favor will mean that work will start very soon upon an irrigation and mining scheme. The project, which is backed by George Wingfield and other wealthy Nevadans, is to

build a dam across Deer creek at the intersection of the Newtown road and the creek to make a reservoir that will impound sufficient water to irrigate from 30,000 to 40,000 acres of land. The right of way for all of this land has been tied up, but the option given by Moses Stockdale before his death is contested by his widow. It is the intention of the promoters to mine the gravel that is taken from the bed of the creek to build the dam, and the gold that will be secured through dredging the gravel is expected to pay half the cost of building the dam. The dam will cost about \$1,250,000 or more when completed, and this cost will include a redwood conduit twenty miles long into the lower country that it is proposed to irrigate. The conduit will

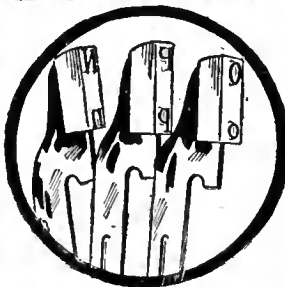

"The Type That Tells"

There are Real Reasons why the ROYAL

stands first in quality typing. There is the new Royal way of sending direct force from the fingertips to the type—at every powerful hammerstroke of its accelerating typewriters of carbon steel!

And there is a rigid carriage that meets the millions of blows of the type—the "business end of the typewriter."

The Royal way is a "better business," for its beautiful *presswork* adds the forceful stamp of quality to every letter you sign.

Price **\$100**



ROYAL TYPEWRITER CO., Inc.
58 East Monroe Street
Chicago, Ill.



Get Your Canadian Home from the Canadian Pacific

BUY an irrigated farm where you have insurance against drought and where you have just the moisture you need when you need it. You know the value of controlling the watering of your crops. In sunny Southern Alberta you are master of the moisture. The Canadian Pacific's great Irrigation Works insure your yield whenever rainfall is insufficient. Irrigation is not always a necessity—but it is yours at command. It means dependable crops, and wonderful crops every year. The Eastern section of the Canadian Pacific Irrigation Block East of Calgary is now open. Virgin soil of famous fertility—alfalfa, timothy and other fodders—raises all the grain and root crops, fine climate—great cattle country—good markets—unexcelled transportation.

We want the alert enterprising farmers who see this magnificent opportunity. So we make the most liberal terms. Take 20 years to pay. Call on us for long time loan of \$2000 for farm improvements if you want it. Investigate now. This block will soon be the most densely populated and intensely cultivated district in the west.

You Can Have 20 Years to Pay

We will sell you this rich, irrigated, Canadian land for \$35 to \$75 an acre. You need pay only one-twentieth down. Think of it—only one-twentieth down, and then the balance in 19 equal annual payments. Long before your final payment comes due, your farm will have paid for itself over and over again. Many good farmers in Western Canada have paid for their farms with one crop. Here are some of the startling features of the most remarkable land offer you have ever read:

We Lend You \$2,000 for Farm Improvements This offer of a loan up to \$2,000 with no other security than the land itself, and shows our confidence in the fertility of the soil and in your ability to make it produce prosperity for you and traffic for our lines. This loan will help you in providing buildings, fencing, sinking well and breaking, and you are given twenty years in which to fully repay this loan. While enjoying the use of this money, you pay interest at only 6%.

Advance Live Stock on Loan Basis The Company, in case of the approved land purchaser who is in a position and has the ability to take care of his stock, will advance cattle, sheep and hogs up to the value of \$1,000 on the basis of the settler's note with interest at eight per cent, to enable him to develop more rapidly, on the right basis of mixed farming.

Farm Made Ready by Experts if Desired If you want a place already established, select one which our Department of Agricultural Experts has developed. On our improved farms, houses and other buildings are up, well in dug, farm fenced, fields cultivated and in crop. All waiting for those who want an immediate start and quick results—all planned and completed by men who know—our own agricultural experts. Take twenty years to pay if you want to. We give free advice—expert advice—the valuable assistance of great demonstration farms, in charge of agricultural specialists employed by the Canadian Pacific for its own farms. This service is yours—free.

Water Rental Will Not Exceed \$1.25 per Acre And each water agreement will have the approval of the Dominion Government. You are doubly protected.

The Canadian Pacific offers you the finest land on earth for grain growing, cattle, hog, sheep and horse raising, dairying, poultry, vegetables and general mixed farming—irrigated lands for intensive farming. Remember, these lands are located on or near established lines of railway, near established towns. You can start on an irrigated farm, improved or unimproved.

Here is the Last Best West—where your opportunity lies. Don't delay. Mail the coupon here at once. The best land will be taken first—so time is precious to you. Write today.

R. O. THORNTON, Colonization Agent
Canadian Pacific Railway
Colonization Department
112 West Adams St., Chicago, Illinois

IRRIGATION FARMING IN ALBERTA

Name

Address

Town

State

cost about twice as much as a ditch, but the water will always be under control and will never run to waste.

The work of sinking fifty artesian wells in Las Vegas valley, Nev., the water from which will be conserved in large reservoirs and devoted to the irrigation of between 10,000 and 15,000 acres of land, has been commenced by the South Nevada Land and Development Company. Eleven miles of main canals and thirty miles of laterals will be constructed to carry the water from reservoirs to the land. The company is backed by English and Scotch capitalists.

Washington

Water Users under the High Line ditch in the Wenatchee valley, Wash., have decided to take over the project. An irrigation district will be formed. It is planned to issue bonds to cover the present expenses and to retire them through process of sinking fund accumulation extending over a period of twenty years. President W. T. Clark of the Wenatchee Canal Company made known his inability longer to maintain the ditch which will necessitate an expenditure of possibly \$75,000 prior to the season of 1915. The Water Users must assume an indebtedness of \$100,000 in taking over the ditch.

Engineer E. McCulloh, who has been engaged for several months in directing re-survey of the proposed Palouse irrigation project in eastern Washington, the expense of which has been borne equally by the United States Reclamation Service and the state of Washington, has completed his field work. "There is no question that there is a feasible irrigation project on the Palouse," says Mr. McCulloh, "but I am not prepared to say yet whether or not the cost of developing it will be greater than the value of the land developed. That can only be determined when we shall have completed our figures from the data we have obtained."

Oregon

The Modoc irrigation project in Oregon will be completed this fall. Ten miles of the main canals and ten miles of laterals are completed with the exception of a few minor connecting gaps. These are rapidly being put in. Work of building the dam across Sprague river is progressing nicely. The project, when completed, will water 8,200 acres of land.

Utah

Large crops of virtually every sort of grain, grass and vegetables, indigenous to Utah may be raised in the vicinity of Nada, Utah. This has been demonstrated by the experimental farm at that place, says L. M. Winsor, irrigation expert for the Utah Agricultural College. "Water is being pumped from near the surface for irrigation purposes," said Mr. Winsor, "demonstrating that the water, lying near the surface, can be raised with but little cost and trouble. This fact will do much to attract settlers to this rich, arable land."

Contract has been let by the Newcastle Land & Irrigation Company for construction work on the company's Newcastle project in the Pine valley mountains of Utah. The contract price is about \$40,000.

Arizona

A plan to harness the water power of the Grand Canyon of Arizona, utilizing the power generated for the reclamation of the arid territory of Arizona, has been presented to the Department of the Interior by Ralph Cameron. The plan embraces an ex-

penditure of \$50,000,000 to generate 200,000 horsepower, which will irrigate 2,500,000 acres of land now useless for agricultural purposes. The power is to be distributed over the land for pumping purposes, as it has been demonstrated that there is an abundance of underlying water. The best engineers in the United States have approved the plan of the hydro-electric project and its success seems assured.

Kansas

George Stump, who has a ranch in Haskell county, near Sublette, Kan.,

Alfalfa for profit

"One-Half the Alfalfa Seed Sown is Wasted Every Year"

This statement has been made by many recognized Alfalfa experts—men who know what they are talking about.

They say that they secured better stands of Alfalfa with 10 pounds of seed, drilled with the Superior Special Alfalfa and Grass Seed Drill than with 20 pounds of seed sown broadcast.

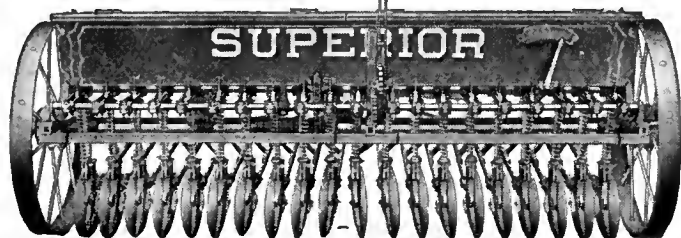

THE SUPERIOR 20 X 4 SPECIAL ALFALFA AND GRASS SEED DRILL

There are 20 discs on this machine set 4 inches apart. The construction is such that all the seed is sown at an even depth, and an equal amount of seed in every furrow.

None of the seed is wasted, when drilled in the ground with a Superior Alfalfa and Grass Seed Drill

REJUVENATES OLD ALFALFA FIELDS

RENEWS OLD PASTURES AND MEADOWS

PRODUCES BEST STANDS OF MILLET

INCREASES YIELDS OF WINTER WHEAT BY

CULTIVATION and SOWS CLOVER AT SAME TIME

Saves More Than Two Dollars an Acre on Seed Alone

Send for Superior Alfalfa Drill folder and read the **strong warranty**

Go to your local dealer and ask to see the Superior Special Alfalfa and Grass Seed Drill. If he will not supply your needs, we will.

THE AMERICAN SEEDING-MACHINE CO., Inc.
SPRINGFIELD, OHIO

FREE—A copy of "Boyd's Farmers' Alfalfa Guide," price 10c, will be mailed free to any reader of Irrigation Age who will write for the book and mention Irrigation Age.

reports some very successful irrigation from deep wells. In Haskell county the underflow is at a depth of nearly 200 feet. Stump uses a three-inch pump with an oil fuel engine. It will raise 3,000 gallons of water nearly 200 feet with one gallon of oil. He uses cement tile and sub-irrigates.

Eight candidates are in the field for members of the Kansas state irrigation board. This board was created by the Democratic legislature last year and was given \$100,000 to conduct some irrigation experiments in western Kansas. It is composed of three members.

California

P. M. Norboe, assistant state engineer, has completed his investigation of the Turtle bay irrigation project near Redding, Cal., by which 47,000 acres are to be reclaimed. An election on the formation of an irrigation district will be held July 14. It is estimated that water can be obtained at \$12 an acre.

Two new irrigation companies are placing water on 20,000 acres of land in Shasta valley near Montague, Siskiyou county, Cal., for the first time this season. Plans are being made to establish a new town below Montague to be known as Granada.

A plan is on foot to organize an irrigation district in the San Bernardino valley, comprising 85,000 acres to be irrigated with water from the great Los Angeles, Cal., aqueduct.

Texas

Formal application to the state of Texas for permission to use water from the San Antonio river for irrigation has been made by the owners of the Espada ditch, which has been in use for irrigation purposes for more than 100 years. Under a recent law of the legislature all diversions of public streams or impounding of water of any sort has to be given sanction by the state and has to be passed on by the state board of water engineers.

A project for the irrigation of 100,000 acres of land in Coke, Runnels and Tom Green counties has been launched at Miles, Tex.

The Brazos River Irrigation Company, Abilene, Tex., will construct a large system of irrigation near that place. The project involves the installation of pumping plants.

The Farmers' Canal Company, Blessing, Tex., will construct an irrigation pumping plant.

The Nueces Valley Irrigation Company, Carrizo Springs, Tex., will construct a pumping plant to water 10,000 acres of land.

J. C. Short, Saragosa, Tex., is preparing to irrigate 640 acres and will install a pumping plant.

A. M. Loomis, El Paso, Tex., and associates, will construct an irrigation pumping plant to irrigate 11,454 acres of land.

The Walker Products Company, Austin, Tex., will put in a pumping plant to irrigate more than 1,200 acres of land.

Fairbanks-Morse Oil Engines

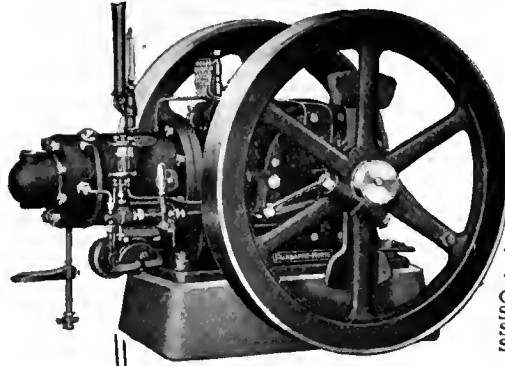

cut irrigation cost because they operate on low priced oils. Have hot-bulb ignition—start easily—run smoothly.

Let us tell you more about them

Fairbanks, Morse & Co.

Chicago	Kansas City	St. Louis
St. Paul	Denver	Omaha
Spokane	Portland	Los Angeles
Salt Lake City	Seattle	Atlanta
		(38 S 650)

Save high as 60% On Lumber and Millwork

Don't Pay Profits to Five Middlemen That's what you do when you buy of your local lumber dealer. Buy of us and you buy of the producer. We are one of the biggest independent

lumber companies in America; own thousands upon thousands of acres of choice Western timber. Do our own cutting, logging, railroading; operate six huge mills, where we produce daily 20 to 30 carloads of lumber and millwork.

Buy Direct From Our Six Mills. Besides up to 60% saving in price we offer you better materials, efficient delivery service and guaranteed satisfaction.

Immediate Shipments. We carry immense stocks. Miles and miles of lumber piles, and warehouses groaning with millwork, await your order. Make all shipments within 24 to 48 hours.

Better Quality Guaranteed. Our timber tracts are in the famous Puget Sound region. Noted for big trees. Our lumber is straight, free from sap and knots. Exceedingly durable.

Send Carpenter's List for Quick Prices Don't pay five profits for your lumber. Send your carpenter's list of lumber for delivered, freight-paid price. No extras guaranteed. We ship everything for building complete—lumber sash, doors, shingles, millwork, hardware and paint. We have doubled our estimating force to give **quick service** to everybody.

BUY A SEATTLE SILO DIRECT FROM MAKER

No wood stands silo service better than fir. We use Douglas Fir, from giant trees, straight-grained tough, long-lasting. Seattle Silos have quick detachable swinging doors. Door bars form strong ladder from which hoops are tightened. Write for special folder today and first farmer-in-a-town offer.

HEWITT-LEA-FUNCK CO.

471 CRARY BLDG., SEATTLE, WASH.



GET THIS MONEY-SAVING PLAN BOOK

If you haven't decided on your plan, you'll find just what you want in this book. It's prepared by practical people and packed full of sensible, full-value plans. Over 100 good plans in this book. Costs you 10 cents—worth a thousand times that.

Get Any Plan in This Book for \$2.00

For \$2 you can get complete blue prints, specifications and guaranteed estimate, covering complete materials of any plan in the book.

Send the Coupons

HEWITT-LEA-FUNCK CO.,
471 Crary Bldg., Seattle, Wash

Kindly send the following, quoting prices delivered, my station.

Be Sure to Write Plainly

- () Catalog Lumber and Millwork
- () Prize Plan Book, 10c
- () Special Barn Folder (4c)
- () Special Silo Folder

Name.....

Town.....State.....

I am planning to build as follows.....

A FEDERAL WATER USER'S STORY

(Continued from Page 270)

Rally to the support of the IRRIGATION AGE. Subscribe for it. Work for it. Contribute to its pages. If necessary, have the Water Users' Associations give it such financial aid that a copy of the AGE may be placed each month in the hands of every Senator and Congressman in the United States. Write the real facts about your conditions and those of your neighbors, that Congress may know, and, acting upon this knowledge, reform conditions on the projects, aid the great enterprise of Federal Reclamation, and see to it that the intent of the Reclamation Act is conformed to and its goal is finally reached.

A CRY FROM THE DESERT

Editor of THE IRRIGATION AGE:

Please send some sample copies of THE IRRIGATION AGE and some subscription blanks. I can get quite a number of my neighbors to subscribe for THE IRRIGATION AGE. I am postmaster here and am loaning my AGE to my neighbors and they all say they will subscribe for it. I will go down through the lower valley next month and see how many I can get to take it. I will write to you about what they doing to us in our settlement here. They have shut our water off and there are about fifteen settlers here that have had the water the last four years and now our alfalfa and everything is dying out from their d— management.

I remain very respectfully yours, etc.,

GEO. W. SELLS,
Laguna, Ariz.

GALVANIZED METAL IRRIGATION FLUME (Newcomb Patent)

Made entirely of rust-proof, galvanized iron. No bolts or rivets used in construction. This flume is considered by experts to be the most serviceable equipment for the purpose on the market.



Section of Flume

A careful examination of the construction as shown herewith will convince those who are acquainted with irrigation conditions of its lasting quality and the ease with which it may be put together. Complete information, with prices, will be furnished on application to the

KLAUER MFG. COMPANY, Dubuque, Iowa

The Passing of an Aristocrat



YOUR horses demand much, need much—and get much. For instance—costly stable, rigs and sheds for them; harnesses; hay and oats, and its storage space; time spent each day in the year caring for them, feeding, watering, currying, harnessing, frequent blacksmith, harness, and vehicle repair bills; occasional veterinary bills.

All that an international Motor Truck asks for is a shed, and a small ration of gasoline and oil—that's all. And when it's not working it wants only the shed. For profit and economy buy an

International Motor Truck

You will find that it costs considerably less than horse and wagon keep, it goes four times as fast and as far as the horse, saves you many hours of time, and will run twenty-four hours in a day if necessary. In reliability, strength, and ease of management, it is best.

Solid tires eliminate common tire troubles. The wheels are high enough to give ample road clearance. The simple, sturdy motor has plenty of power. Brakes are powerful. A single lever controls the car.

It will pay you to find out all that an International Motor Truck will do for you. Write for catalogues, facts and figures to the



WESTERN BRANCH HOUSES: Denver, Col.; Helena, Mont.; Portland, Ore.; Spokane, Wash.; Salt Lake City Utah; San Francisco. Cal.

International Harvester Company of America

Chicago

(Incorporated)

U S A



When writing to advertisers please mention The Irrigation Age.

CONGRESSMEN HUNT "LOBBYIST"

Continued from Page 271

warped and twisted the facts to suit his own base purposes. It is evident that he was not present in the gallery when this bill was under consideration, nor did he take the trouble to inquire of any member of the committee as to the actual situation.

"It is amazing to me that Mr. Rodman would be willing to accept as gospel truth the vaporings of a man who is ashamed of his identity and to scatter broadcast a mess of misinformation that could result in nothing but unwarranted uneasiness among thousands of settlers whose future prosperity is bound up in the success of the reclamation-extension act. God knows the lot of the pioneer is hard enough without adding unnecessary worry. Mr. Rodman must have a very sad view of life if he is willing to believe on anybody's statement that a majority of the Western Congressmen are utterly unmindful of the welfare of those who sent them here. He should make a sincere effort to cultivate a more Christian spirit.

"I deny that there has been the least apathy on the part of the Representatives from the 17 States affected by the reclamation-extension bill. Every one of them has exerted his best efforts to bring the bill to a vote. The Committee on Irrigation of Arid Lands directed that a subcommittee be appointed to call upon the Speaker, and I am glad to say that we found him most willing to assist us. The majority and minority leaders have both been interviewed. Mr. Underwood and Mr. Mann are agreed that this bill should be considered

at this session of Congress. We have talked with the President, and he has publicly stated that it ought to pass. And, lastly, we have circulated petitions among the membership of this House requesting the Rules Committee to report a special rule making the consideration of this bill in order along with four other measures that vitally affect the prosperity of the entire West. On these petitions we have secured the signatures of a clear majority of the membership of this House, and last Wednesday the Committee on Rules ordered a favorable report on such a rule.

"As soon as the pending sundry civil appropriation bill is out of the way and the water-power bill from the Committee on Interstate and Foreign Commerce, which has been made the unfinished business of the House, is passed, our special rule will be reported to the House.

"We believe in this bill and we have faith that when an opportunity is given us to explain its merits a large majority of the membership of this House will be glad to vote for it. At no time has

FOR SALE—Large tract of good valley farming land just thrown open for free settlement, in Oregon. Over 200,000 acres in all. Good climate, rich soil, and does not require irrigation to raise finest crops of grain, fruit, and garden truck. For large map, full instructions and information, and a plat of several sections of exceptionally good claims, send \$3.40 to John Keefe, Eugene, Oregon—three years a U. S. surveyor and timberman. An opportunity to get a good fertile free homestead near town and market.



THINK what it means to you! To have at your service—day and night if desired—the combined power of 30 to 35 horses and 10 to 15 men—ready at a moment's notice to plow, disc, harrow, seed, harvest, build roads, irrigate, thresh and do numerous other power jobs, all at the minimum expense for fuel and maintenance. That's what you get when you buy a time-tried and time-proven

AULTMAN-TAYLOR 30-60 GAS TRACTOR

They're built with the complete knowledge of the requirements of a tractor of the first quality. They're built right here in our own shop, under our own supervision. We know they're right and we stand back of every tractor. The Aultman-Taylor 30-60 burns either gasoline, kerosene or

distillate with unequaled economy. The Aultman-Taylor 30-60 is not an experiment. Their real worth has been demonstrated on thousands of farms throughout North America. Let us explain to you why you should own and operate one of these money-making and labor-saving tractors. **WRITE FOR CATALOG AND FURTHER INFORMATION TODAY.**

We are also builders of the Famous "New Century" Separator, "Matchless" Clover and Alfalfa Huller, Steam Traction and Portable Engines, Bean Threshers and Saw Mills. Catalog free upon request.

THE AULTMAN & TAYLOR MACHINERY COMPANY

MANSFIELD, OHIO.

BRANCHES: Minneapolis, Minn.
Wichita, Kan.

Portland, Ore.
Decatur, Ill.

Lincoln, Nebr.
Indianapolis, Ind. Kansas City, Mo.

anyone from the West sought to avoid the issue, and through our combined efforts a vote on the bill is in sight. We will pass the reclamation-extension bill through the House before the 15th of next July, and the President will approve it before this Congress adjourns. If this is apathy the anonymous

Westerner who is so "thoroughly in touch with the situation" can make the most of it. I only regret that Mr. Rodman has not seen fit to make known his correspondent's name, since it would afford me vast pleasure to denounce him in the terms that his infamy merits."

We planned this House and Saved Robert Zehntner \$375.00

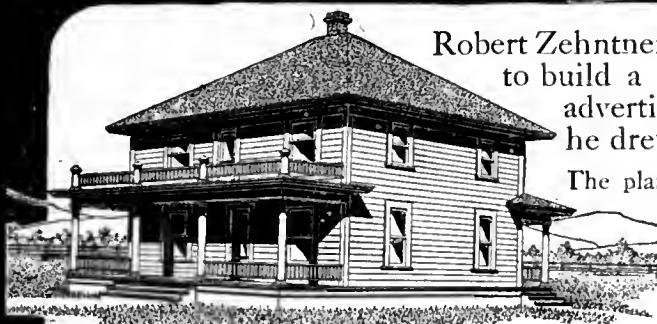

Home Designed for Robert Zehntner, White Sulphur Springs, Mont.

Robert Zehntner of White Sulphur Springs, Mont., wanted to build a home and answered a Hewitt-Lea-Funck advertisement. On the back of our question blank he drew a rough sketch of what he had in mind.

The plans you see at the left, and afterward, the house pictured, was the result. When it came to ordering the lumber, the local yard man asked for the chance to bid and got it, but he didn't get the business. Mr. Zehntner's letter to us tells why. "I unloaded the car," he says, "and found the material fine. The carpenters are well pleased, the finish being much better than I could have gotten here. The best local

bid on the material was \$375 higher than yours and lacked quite a bit of being complete."

Complete plans \$2

If you like this house, you can get the complete plans, specifications, guaranteed estimate of prices on lumber, millwork, hardware, paint and heating plant delivered at your station—all for \$2.

Our guaranteed price means *no extras*. We guarantee absolutely to provide sufficient materials to build the house, and guarantee grades equal or better, than required by standard rulings. Getting the plans does not obligate buying materials of us, if you do, you get your \$2 back. If this plan doesn't suit,

Send coupon for Prize Plan Book —100 homes—all sizes—all prices

It's the *most practical* book of it's kind ever published. Every plan is a good one—a lot of them will please you—one of them will doubtless *just suit you*. Our architects worked over a year on this book. It cost us \$30,000 to get it out. Books not nearly so good are sold at 50c to \$2.00. Yet, ten cents, merely to cover postage, will bring you this valuable book, if you use the coupon.

middleman and sell you direct at the *mill price*—a price that's way-down low, because the raw materials come from forests under our control. Our lumber is straight-grained, free from sap and large knots, doesn't warp or shrink. Makes a beautiful job.

Special plans at small cost

If none of the plans in this book quite suit you, and you have your own ideas of what you want, you'll find it easy to show us what your ideas are, just as Robert Zehntner did. We have a Plan Sheet for this purpose, that makes it simple. Give us a rough sketch of what you have in mind—and we will complete the plan for you.

Send for estimate—no obligation

Send us your carpenter's bill of materials for our prices, if you can. Do it even if you aren't ready to build. No charge or obligation. If we can be of any help to you in planning your building be sure to let us know. Our special plan sheet makes it easy to give us your ideas—ask for it. At any rate, mail the coupon today for catalog and general price list.

Save as high as 60% on lumber—buy direct from the producer

Too many middlemen come between the mill and the lumber dealer—that's why his prices are so high. We cut out every single

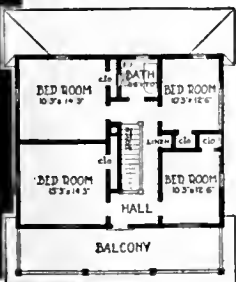
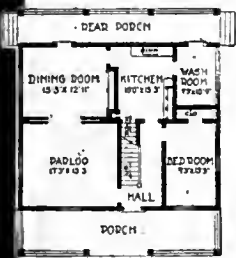

Silos at up to 60% Saving

Here's the biggest silo value you can get. *Buy direct*, at the mill price, a Seattle Silo of one-piece staves from durable Puget Sound fir. **Seattle Silos** have patented swinging doors. Door bars form strong ladder from which hoops are easily tightened. *Send the coupon* for folder on Seattle Silos. Get our special one-farmer-in-a-town-offer. Write today.

HEWITT-LEA-FUNCK COMPANY
471 Cravy Building Seattle, Wash.

Hewitt-Lea-Funck Plan Book

Hewitt-Lea-Funck Company
471 Cravy Bldg., Seattle, Wash.
(Be sure to write plainly and if possible send bill of materials for estimate)

Please send me the following:
 Book of Plans (for which 10c in stamps or coin is enclosed).
 Catalog and General Price List of Lumber and Millwork, Free.
 Special Silo Folder, Free.
 Special Plan Sheet, Free.

Name _____
 R. F. D. or Street No. _____
 Post Office _____ State _____
 Business _____

U. S. MAKES IT EASIER TO SHIP LIVESTOCK

NEW regulations governing the interstate movement of live stock became effective July 1. These changes are designed by the Department of Agriculture to facilitate the movement of live stock from quarantined areas or from public stock yards. The new regulations, which are known as B. A. I. (Bureau of Animal Industry), Order 210, superseding B. A. I. Order 143, deal with the shipment of cattle from tick-infested areas, with the movement of swine from public stock yards and with the dipping of cattle and sheep for scabies.

Hereafter cattle that have been dipped once under State or Federal supervision may be shipped from an area quarantined for ticks to a market center where there are proper dipping facilities and the Department of Agriculture maintains an inspector. After a second dipping there under his supervision the cattle may be sold for any purpose. Hitherto it has been necessary in times of drought for cattle owners in quarantined areas to slaughter their stock or sell it for slaughter for whatever it would bring.

The provision permitting, under certain strict conditions, the transportation of hogs from public stockyards into interstate commerce has been made possible by the discovery by Government scientists of a serum which renders swine immune to hog

cholera. Hitherto all stockyards have been considered as infected with this disease. Now, however, it is considered safe to permit the shipment of hogs which have been treated with the serum and which show no symptoms of suffering from any form of disease. As a result of this it is expected that thousands of light weight hogs will be sent from the stockyards to the country for feeding and fattening, and that the country's total production of pork will be greatly increased.

The new regulations also withdraw all permission for the use of nicotine solutions, coal-tar, creosote and cresol preparations in the official dipping of cattle and sheep for scabies. This step has been made necessary by the difficulty experienced in keeping baths of this nature at a strength sufficient to eliminate all danger of disease without having them so strong as to be injurious to the animals themselves. The Department, therefore, decided to insist upon a field test of the strength of all solutions used for dipping. A practical field test for this purpose is available in the case of the sulphid sulphur used in lime in sulphur baths for scabies, and for arsenious oxide in arsenical dips for cattle tick. Official dipping, therefore, will hereafter be confined to the lime-and-sulphur and arsenical baths.

The School For Your Daughter

TERM OPENS
SEPTEMBER
FIFTEEN

St. Mary-of-the-Woods

COLLEGE
AND
ACADEMY

DEGREES CONFERRED: B. A., B. S., PH. B. STRONG FACULTY

Located four miles west of Terre Haute, Indiana. Large campus, perfect drainage, commodious buildings, steam heat, electric lights, large airy rooms, many with private bath, and spacious halls, libraries and parlors. School plant consists of fourteen modern buildings, artistically grouped and completely equipped. Nothing lacking for convenience or comfort. Combining all the best features of school life with home environment on a country estate of 1,600 acres.

BOATING, HORSEBACK RIDING, SWIMMING, ARCHERY, GOLF and all outdoor athletics for girls under the constant supervision of a graduate of the Sargent School for Physical Education. School course comprises INTERMEDIATE, ACADEMIC and COLLEGIATE departments. Special courses in MUSIC, ART, LANGUAGES, DRAMATIC ART, and DOMESTIC SCIENCE. Information gladly furnished on application. A beautifully illustrated catalogue to be had for the asking. Address

SISTER SUPERIOR, Box 41,

St. Mary-of-the-Woods, Indiana



College Building

Conservatory of Music

Academy Building

When writing to advertisers please mention The Irrigation Age.



Purity

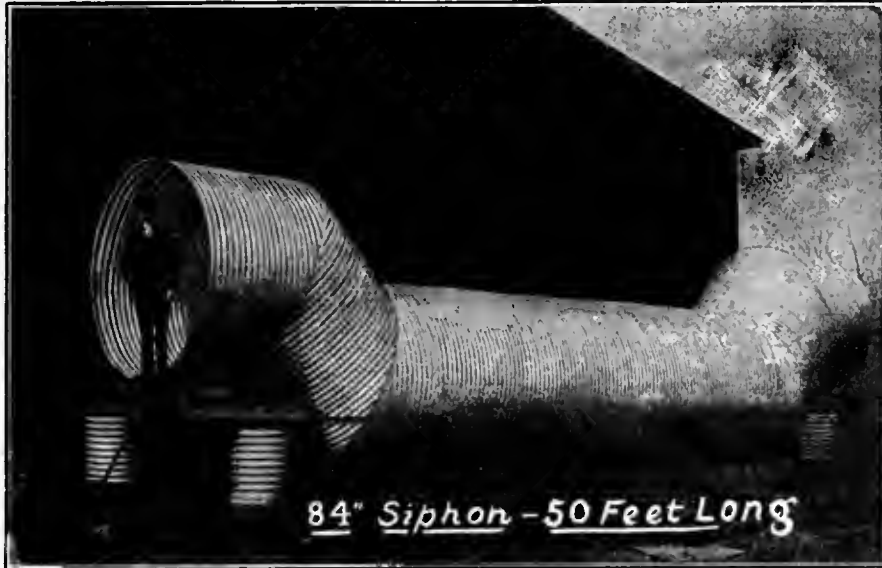

Permanence

84" Siphon - 50 Feet Long

Corrugated Inverted Siphons

are a valuable resource of the Irrigation Engineer.

They have the strength to endure the shocks and strains of traffic at highway and railroad crossings.

They keep themselves clear of mud and silt *more successfully* than any smooth construction.

And, when made from American Ingot Iron (Armco Iron), they constitute a *lasting installation*.

Write the Nearest Manufacturer for full information on American Ingot Iron Culverts, Siphons, Gates, Plates, Sheet Roofing and Formed Products.

Arkansas, Little Rock
Dixie Culvert & Metal Co.
California, Los Angeles
California Corrugated Culvert Co.
California, West Berkeley
California Corrugated Culvert Co.
Colorado, Denver
R. Hardesty Mfg. Co.
Delaware, Clayton
Delaware Metal Culvert Co.
Florida, Jacksonville
Dixie Culvert & Metal Co.
Georgia, Atlanta
Dixie Culvert & Metal Co.
Illinois, Bloomington
Illinois Corrugated Metal Co.
Indiana, Crawfordsville
W. Q. O'Neill Co.
Iowa, Des Moines
Iowa Pure Iron Culvert Co.
Iowa, Independence
Independence Corr. Cul. Co.

Kansas, Topeka
The Road Sup. & Metal Co.
Kentucky, Louisville
Kentucky Culvert Co.
Louisiana, New Orleans
Dixie Culvert & Metal Co.
Maryland, Havre de Grace
J. N. Spencer.
Massachusetts, Palmer
New England Metal Cul. Co.
Michigan, Bark River
Bark River Bridge & Cul. Co.
Michigan, Lansing
Michigan Bridge & Pipe Co.
Minnesota, Minneapolis
Lyle Corrugated Cul. Co.
Minnesota, Lyle
Lyle Corrugated Cul. Co.
Missouri, Moberly
Corrugated Culvert Co.
Montana, Missoula
Montana Culvert Co.

Nebraska, Lincoln
Lee-Arnett Co.
Nebraska, Wahoo
Nebraska Cul. & Mfg. Co.
Nevada, Reno
Nevada Metal Mfg. Co.
New Hampshire, Nashua
North-East Metal Cul. Co.
New Jersey, Flemington
Pennsylvania Metal Cul. Co.
New York, Auburn
Pennsylvania Metal Cul. Co.
North Carolina, Greensboro
Dixie Culvert & Metal Co.
North Dakota, Wahpeton
Northwestern Sheet & Iron Works.
Ohio, Middletown
American Rolling Mill Co.
The Ohio Corrugated Cul. Co.
Oklahoma, Shawnee
Dixie Culvert & Metal Co.

Oregon, Portland
Coast Culvert & Flume Co.
Pennsylvania, Warren
Pennsylvania Metal Cul. Co.
South Dakota, Sioux Falls
Sioux Falls Metal Cul. Co.
Tennessee, Nashville
Tennessee Metal Culvert Co.
Texas, Dallas
Atlas Metal Works.
Texas, El Paso
Western Metal Mfg. Co.
Texas, Houston
Lone Star Culvert Co.
Utah, Woods Cross
Utah Culvert Co.
Virginia, Roanoke
Virginia Metal & Cul. Co.
Washington, Spokane
Spokane Corrugated Culvert & Tank Co.
Wisconsin, Eau Claire
Bark River Bridge & Cul. Co.

DEPENDABLE POWER FOR IRRIGATION

When you buy an engine for irrigation pumping, look first to the quality. Dependability is the all-important consideration. You can't afford to risk failure of your pumping outfit at the critical time. It will cost you less in the long run to pay what a good engine is worth.

**Lauson and
Kerosene**



**"Frost King"
Engines**

are particularly well adapted for irrigation pumping because of their absolute reliability. "Lauson" Engines are built up to a standard, not down to a price; have more drop forged and case hardened parts than any other engine on the market, and will run as true after five years' use as when new.

By using a carburetor of special design ordinary kerosene distillate is used, securing the full rated horse power as with gasoline. The cold process type of carburetor is used because it is cleaner and more efficient than the oil heating system used by others.

For continuous heavy work there is no engine on the market today that equals the Lauson. We'll be glad to submit proof without obligating you in any way.

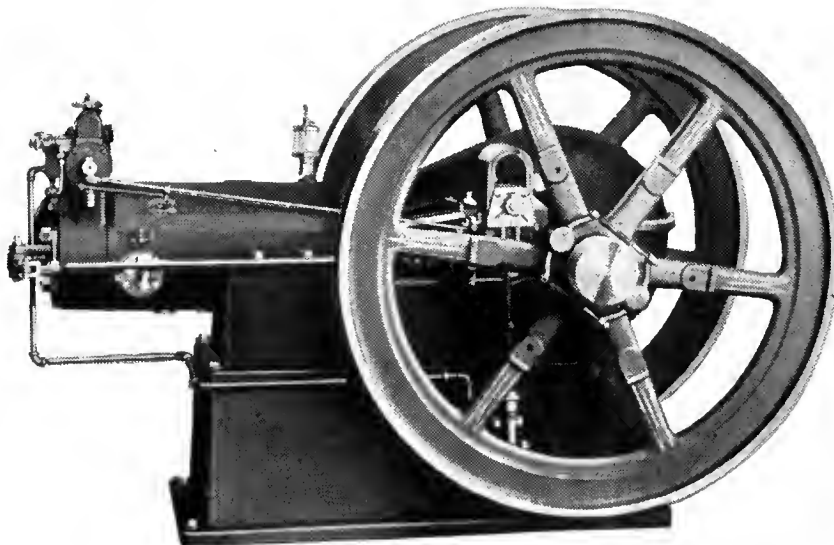

**Built in Sizes
from
6 to 50 H. P.,
Horizontal Portable or
Stationary Types.**

**80 to 100 H. P.
Multiple Cylinder
Vertical Type.**

**The
John Lauson Mfg. Co.
68 MONROE STREET, NEW HOLSTEIN, WIS.**

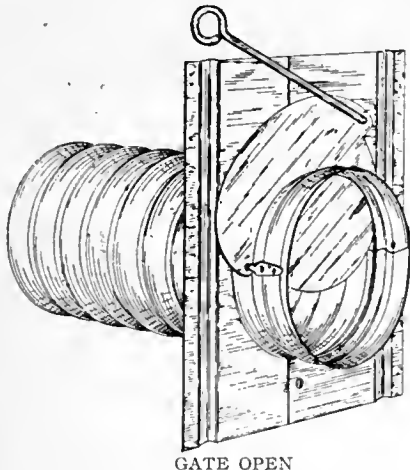

GATE OPEN

4-C IRRIGATION GATE

Reduces labor of irrigating.
Easy and quick to install
or move to new locations.
Does not wash out.
Saves water and stops
scalding of crops.
Can be removed, ditches
cleaned with teams, and
gates replaced without
loss.

Five other types of Gates. Culverts, Siphons,
Flumes, Stock and Water Troughs.

DURABLE
Because Made From
RUST-RESISTING AMERICAN INGOT IRON

Write Us.

California Corrugated Culvert Co.

435 Leroy St., Los Angeles, Calif.

424 Parker St., Berkeley, Calif.

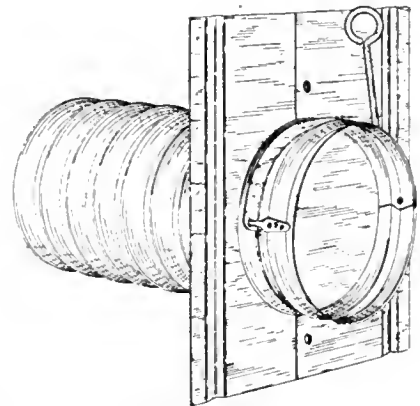

GATE CLOSED



Finish This Story

A WORKMAN in an IHC wagon factory was explaining the various stages of wagon construction to an interested visitor. He picked up two pieces of long leaf yellow pine, which to all appearances were sawed from the same board, and asked the visitor to notice the difference in the weight of the two pieces. The lighter piece, he explained, was kiln-dried. The heavier piece was air-dried and more thoroughly seasoned. It had retained the resinous sap which adds strength and toughness, while in the kiln-dried piece of lumber this sap had been drawn out by the too rapid application of heat.

Every Stick of Lumber Used in IHC Wagons is Carefully Selected, Air-Dried Stock

Here was something to think about. The visitor asked for a test as to the relative strength of the two pieces of wood. The air-dried piece held up under nearly double the weight under which the kiln-dried piece of lumber broke. The workman explained how the comparative life of air-dried and kiln-dried lumber has about as great a difference.

To the eye there was no difference between these two pieces of lumber, but when put to



the test there was a vast difference. So it is throughout the construction of IHC wagons — Weber, Columbus, New Bettendorf, Steel King. They are built for real strength, light draft, and satisfactory service.

After seeing the care used in the construction of every part of an IHC wagon, the visitor asked: "Why don't you let people know of the great care used in selecting material and in constructing IHC wagons?"

This is what we have been trying to do, but we cannot tell it all in one short advertisement.

Weber and Columbus wagons have wood gears. Steel King and New Bettendorf have steel gears. IHC local dealers handle the wagons best suited to your work. See them for literature and full information, or, write the nearest branch house.

WESTERN BRANCH HOUSES: Deaver, Col.; Helena, Mont.; Portland, Ore.; Spokane, Wash.; Salt Lake City, Utah; San Francisco, Cal.

International Harvester Company of America

Chicago U S A



If the Weather Man Were Always Kind
Irrigation Would Be Unnecessary

Don't Depend on Rainfall!

Install your own pumping plant and get
the maximum possible yield from land

"The Deane of Holyoke"
IRRIGATION PUMPING MACHINERY
Makes Your Water Supply Sure

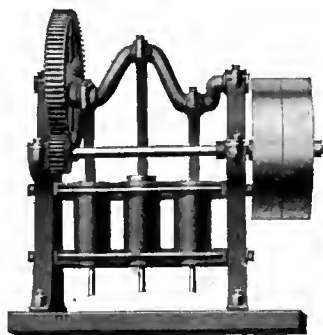

Fig. 2074
Tx. Deep Well "Tigreito" Type

Deane Pumps Are

Originated
Designed
Built
Sold

By
Experts

Bulletin D-230-89 tells about
Deane Irrigation Pumps

The Deane Steam Pump Co.

115 Broadway, New York

Works: Holyoke, Mass.

Branch Offices in Principal Cities

P. S.—A central pumping plant for supplying adjacent properties produces greater benefits at less outlay. Talk to your neighbors about it.

IRRIGATION FROM WELLS



An Arkansas Installation. Layne Patent Screen, and Patent Enclosed Line Shaft Centrifugal Pump.

With the twenty-three hundred successful working plants using our system of irrigation, which inoculates and energizes the dormant forces, there is now being produced in previously non-productive districts throughout the United States and in portions of Europe and Asia over eleven million dollars worth of FOOD PRODUCTS ANNUALLY. That our system is not an experiment is forcibly demonstrated by the fact that much of this production is from localities which were arid and barren previous to the introduction of our system.

Write for new catalog.

LAYNE & BOWLER COMPANY

Address nearest office.

The World's Largest Water Development Company

Houston, Texas

Memphis, Tennessee
Welsh, Louisiana

Stuttgart, Arkansas
Plainview, Texas

Jackson, Mississippi



International Harvester Tillage Implements

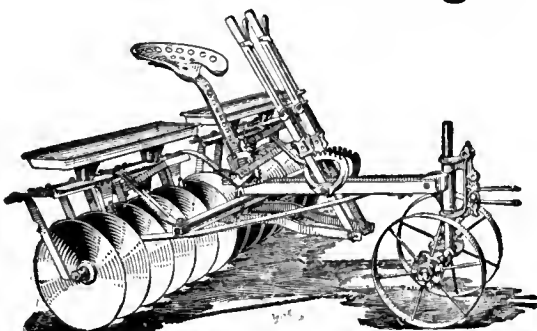

THIS year ten disk harrows will be sold where one was sold five years ago. Why? Because so many farmers have learned that the proper use of a disk harrow is the best guarantee of a successful crop.

Proper use of a disk harrow means the purchase of an IHC disk harrow, because they are the ones built to do the best work. The frames are strong, to stand the strain of following the binder or of slicing meadows. The set levers keep the gangs to their work at even depth. The bearings are the most durable that can be put on a disk harrow.

The full line includes disk, peg tooth, and smoothing harrows, drills and cultivators. See this line before you buy. We send catalogues on request.

"The Disk Harrow," a book which illustrates and explains the proper preparation of a seed bed, and gives examples of the value of disking—32 pages of valuable information—is yours for four cents to cover postage and packing.

GRAIN AND HAY MACHINES

Binders, Reapers
Headers, Mowers
Rakes, Stackers
Hay Loaders
Hay Presses

TILLAGE

Combination,
Peg and Spring-
Tooth, and Disk
Harrows
Cultivators

THE IHC LINE

CORN MACHINES

Planters, Pickers
Binders
Cultivators
Ensilage Cutters
Shellers
Shredders

GENERAL LINE

Oil and Gas
Engines
Oil Tractors
Manure
Spreaders
Cream Separators
Farm Wagons
Motor Trucks
Threshers
Grain Drills
Feed Grinders
Knife Grinders
Binder Twine

International Harvester Company of America

(Incorporated)

Denver—Helena—Portland—Spokane—Salt Lake City—San Francisco

Champion Deering McCormick Milwaukee Osborne Plano





WE SHALL be glad to mail anyone who wishes same, our free catalog. We sell our product through dealers and jobbers entirely and solicit inquiries from all dealers. Our goods are well and favorably known. They are standards in the United States Army and several other departments of the government.

Gold Medal Camp Furniture Mfg. Co.
Racine, Wis., U. S. A.



BUCKEYE

Power Working Heads

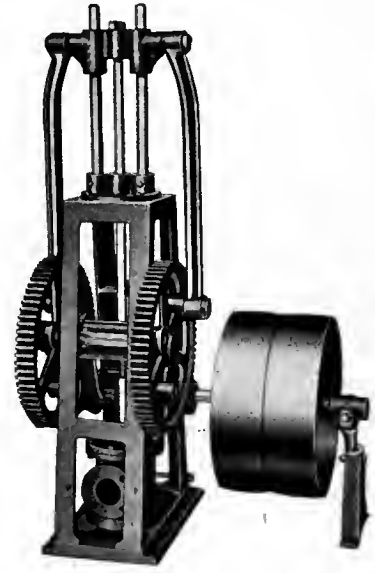

DESIGNED especially for IRRIGATION and pumping large quantities of water from deep wells.

Made in four sizes. Range of stroke, 5 to 24 inches. Size of cylinder can be varied to meet requirements of depth and diameter of well.

The frame is attached to the base of the pump so that it can be hinged back out of the way when the pump rods and valves are being removed.

Write TODAY for Catalogue R
Manufactured by
MAST, FOOS & COMPANY
SPRINGFIELD, OHIO

PAYS FOR ITSELF IN ONE MONTH

and Keeps on Saving You Money at the Same Rate Thereafter.

THE RECLAMATION DITCHER

Cuts Canals and Laterals for less than any other machinery—because it plows the dirt out with *One Continuous Sweeping Motion*.

We guarantee the cost per yard and prove it before you buy.

The J. D. Adams Mfg. Co.

Indianapolis, Ind.



Delays Pay No Dividends. Mail This Coupon Today.

The J. D. Adams Mfg. Co., Indianapolis, Ind.

Below are descriptions of our proposed ditches. What will it cost per cubic yard to make them with the Reclamation Ditcher?

Length	Width in Bottom	Average Depth	Maximum Depth	Minimum Depth	Slope of Sides	Character of Soil

Name _____ Address _____



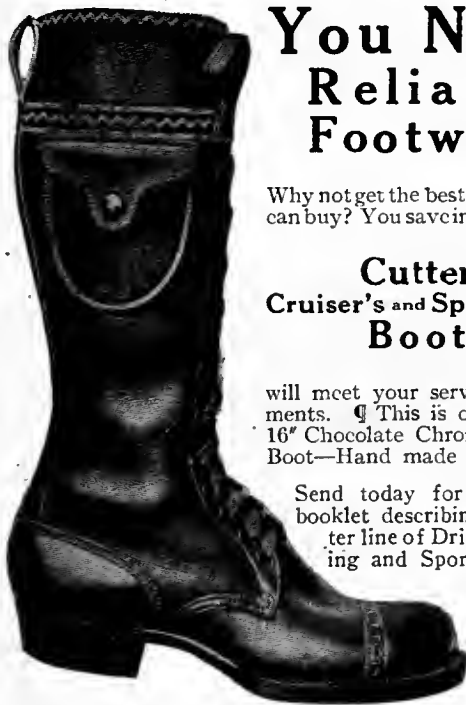

You Need Reliable Footwear

Why not get the best your money can buy? You save in the long run

Cutter's Cruiser's and Sportman's Boots

will meet your service requirements. ¶ This is our No. 106 16" Chocolate Chrome Sporting Boot—Hand made throughout.

Send today for illustrated booklet describing the Cutter line of Driving, Cruising and Sporting Boots.

*It
Will Pay
You*

A. A. Cutter Company

Eau Claire, Wisconsin

SAMSON TURBINE



When the PUMP cannot be direct connected to the turbine shaft, the power is usually transmitted by gears, shafting, etc. On account of the HIGH SPEED of the SAMSON, for a given power, lighter and consequently CHEAPER transmission machinery can be used.

JAMES LEFFEL & CO.

Springfield, Ohio, U. S. A.

316 Lagonda Street

The Lennon Metal Flume

has been from the first the ideal construction from the mechanical standpoint.

When American Ingot Iron

was adopted as its material, the Lennon Flume took its place with the Armeo Culvert as the standard product of its kind.

American Ingot Iron is the purest, most even and most carefully prepared iron in respect to rust resistance which is now obtainable.

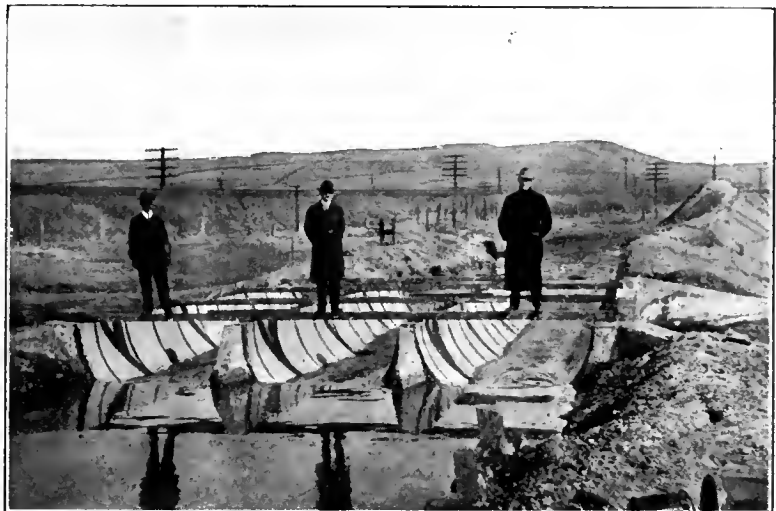

Write the Nearest Manufacturer for Full Information.

CALIFORNIA—Los Angeles and West Berkeley, California Corrugated Culvert Co.
COLORADO—Colorado Springs, Lennon Metal Flume Co.
COLORADO—Manitou, Lennon Flume Co.
MONTANA—Missoula, Montana Culvert Co.

NEBRASKA—Wahoo, Nebraska Culvert & Mfg. Co.

OREGON—Portland, Coast Culvert & Flume Co.

SOUTH DAKOTA—Sioux Falls, Sioux Falls Metal Culvert Co.

TEXAS—El Paso, Western Metal Mfg. Co.

TEXAS—Houston, Lone Star Culvert Co.

UTAH—Woods Cross, Utah Culvert Company.

WASHINGTON—Spokane, Spokane Corrugated Culvert & Tank Co.

When writing to advertisers please mention The Irrigation Age.

INSURE YOUR CROPS



against failure. Your success or failure in irrigation depends on the engine you buy. Delays and troubles with cheaper and more complicated engines often cause damage and loss to your crop in a single season, which would more than pay for a

HEER TWO CYLINDER OPPOSED ENGINE
(Heavy Duty Type)

Simple, safe, sturdy, strong, saving, steady-powered—one of these engines will give you all of the water you want when you want it—if you've got it there to pump—and at lower cost than other engines.

Burns kerosene and distillates—any semi-refined oil—and requires less trouble and attention than any other type. Fuel and maintenance cost low. Negligible repair cost. Total cost lower than others.

One customer buys thirty-two at a time after making tests of the best to be had. Hundreds of users endorse it as the best and most reliable.

SAFETY FIRST! Be sure of your crops. Start today by sending for our book on **THE HEER ENGINE.**

THE HEER ENGINE COMPANY, 208 E. Street
PORTSMOUTH, OHIO

**EDWARDS REVERSIBLE
4 HORSE ROAD GRADER**

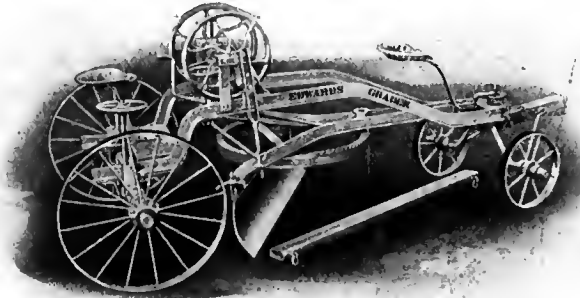

**AN UP TO DATE MACHINE FOR BUILDING
AND MAINTAINING ROADS**

Having a complete line of adjustments it is equally well adapted for making ditches, both for dry land irrigation and rice field work.

I also manufacture **THE RURAL ROAD GRADER** and **IRRIGATION DITCHER, STUMP PULLERS** and other machines.

Write for descriptive catalog and prices.

C. D. EDWARDS, Albert Lea, Minn.

Gates and Flumes

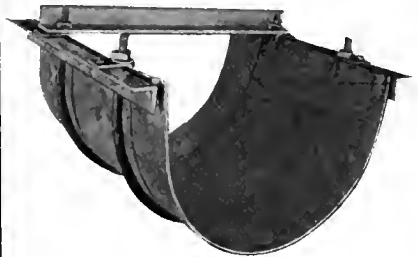

The simplest and quickest erected flume joint on the market, consequently lowest in initial and final cost. Can be fabricated in the field on large jobs, effecting a great saving in freight.

We manufacture:

- Main Headgates
- Lateral Headgates
- Gate Valves
- Metal Flumes
- Steel or Wood Pipe

We carry a complete stock of Wire Mesh and Steel Bars for Concrete reinforcement

Designs and estimates furnished on all irrigation structures and supplies.

Write us your requirements and full information will be sent.

Power Pumping Plants—Reasonable

The Fitts Machinery & Construction Co.
Main Office, McPhee Bldg., Denver, Col.

WASH BY POWER

Let the A. B. C. Power Washer do all your washing 2 weeks FREE. You will then never go back to the scrub board or hand power washer. The A. B. C. makes washing so easy. No headache, backache or tired feet. Use any 1/8 H.P. gas or gasoline engine or electric motor. The

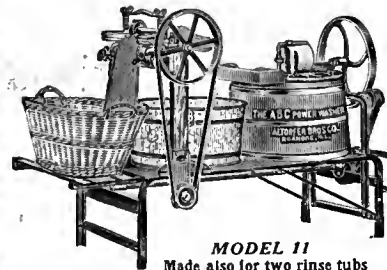

**A.B.C.
Power
Washer**

MODEL 11
Made also for two rinse tubs

is recognized everywhere as the best washer made. It is the **Original All Steel Adjustable Height Frame Power Washer with Sliding Power Wringer.**

Simple, durable, dependable. Our 14 Day FREE Trial proves its marked superiority. Low price, liberal guarantee. Write today for FREE Trial Offer and Illustrated Booklet.

ALTORFER BROS. CO.
Dept. 958 ROANOKE, ILL.

THE IRRIGATION AGE

VOL. XXIX

CHICAGO, AUGUST, 1914.

No. 10

THE IRRIGATION AGE

With which is Merged

The National Land and Irrigation Journal

MODERN IRRIGATION

THE IRRIGATION ERA

ARID AMERICA

THE WATER USERS' BULLETIN

THE DRAINAGE JOURNAL

MID-WEST

THE FARM HERALD

THE IRRIGATOR

D. H. ANDERSON

PUBLISHER,

30 No. Dearborn Street,
Old No. 112 Dearborn St.

CHICAGO

Entered as second-class matter October 3, 1897, at the Postoffice at Chicago, Ill., under Act of March 3, 1879.

D. H. ANDERSON, Editor

ANNOUNCEMENT.

The "Primer of Hydraulics" is now ready; Price \$2.50. If ordered in connection with subscription \$2.00.

SUBSCRIPTION PRICE

To United States Subscribers, Postage Paid,	\$1.00
To Canada and Mexico.	1.50
All Other Foreign Countries,	1.50

In forwarding remittances please do not send checks on local banks. Send either postoffice or express money order or Chicago or New York draft.

Official organ Federation of Tree Growing Clubs of America. D. H. Anderson, Secretary.

The Executive Committee of the National Federation of Water Users' Associations has taken action whereby THE IRRIGATION AGE is created the official organ of this vast organization, representing 1,000,000 persons on the government irrigation projects.

Interesting to Advertisers

It may interest advertisers to know that The Irrigation Age is the only publication in the world having an actual paid in advance circulation among individual irrigators and large irrigation corporations. It is read regularly by all interested in this subject and has readers in all parts of the world. The Irrigation Age is 29 years old and is the pioneer publication of its class in the world.

The Old Congress Cleansed, or a New Congress?

The officers and board of governors of the Irrigation Congress still sit idle and smirk and grin, while the Canadian land boomers are striving with all their might to use this great American institution to advertise their wares. No heed has been paid to the repeated demands of THE IRRIGATION AGE, various Western publications and many prominent Western men that the contract for the sale of the Congress be abrogated. Secretary Hooker is drawing a very large salary, which the Canadians are paying, and of course he is satisfied to let the deal stand, even though he is not permitted to do all the junketing he is said to have planned. The board of governors seem satisfied to let the Canadians run the Congress as they please in return for favors which may have been shown them or which they may expect.

Efforts to stir the executive committee of the Congress to action have met with little success. This is not the fault of the committeemen, many of whom are anxious to have the Canadian deal abrogated. It is the fault of the organization of the Congress. Certain influences, which gained

control of this great organization a few years ago, succeeded in making the executive committee little more than an honorary institution, whereas it was designed to have a most important voice in the government of the Congress. Realizing their almost helpless condition, the executive committeemen—one from each state—have found it impossible so far to arrange a meeting or devise means of rescinding the Canadian contract made by the board of governors.

It is unfortunate that this condition exists. The Irrigation Congress has done so much for the West and there is still so much that it can do for the West—in fact, for the whole nation—that some means should be found to restore it to its native soil and to the purposes for which it was originated.

Business men of Ogden, Utah, whose invitation to entertain the Congress was refused in order that the Canadian deal might be put through, have offered to finance the organization of a new Irrigation Congress. They have gone further. They have offered a permanent home for such a Congress.

Perhaps this is the solution. THE IRRIGATION AGE still has a very warm spot in its heart for the old Congress and for the men who were its back-

bone in the days when it was working for the good of the whole West and when no special interests controlled it. THE AGE would like to see the old Congress saved, and although the hour for action is almost passed, is still hopeful that the board of governors will come to their senses, awoken to their patriotic duty as Americans and rescind the ignominious deal which they made.

If they do not, then one of two things should be done, and done promptly. Either the invitation of Ogden should be accepted by the patriotic men of the West and a new Congress organized, or steps should be taken to eliminate absolutely from any authority in the old Congress every man who had anything to do with the Canadian deal.

If Secretary Hooker and the board of governors persist in carrying the Canadian deal to completion in order to collect their mess of pottage, they must be dealt with strenuously and in no uncertain manner. They should be ousted from office and so branded that all may know them and guard against any attempt they may make in the future to again creep into power in the Irrigation Congress.

If the Congress is restored to American soil, steps should be taken immediately by its patriotic American members to guard absolutely against any such deal as this Canadian affair in the future. Greater care should be taken in selecting new officers of the Congress. Only men who have the real interests of the irrigation areas of the United States at heart and are true blue Americans should be selected. The Congress should be reorganized so as to restore it to the high plane upon which its originators placed it, eliminating all the present money-seeking, money-grabbing features which have crept into it and which offered excuse for the despicable Canadian deal.

Meanwhile it will be well for all Americans to keep in mind the generous and patriotic offer of Ogden, Utah. If the old Congress can not be brought back to the United States thoroughly cleansed of the men who sold it out to the Canadian land boomers, if this influence, purchased with sordid gold, is to be permitted to continue, then it is best that the old Congress shall die. It must not be allowed to remain the slave of alien land boomers.

Ogden and her citizens are entitled to unstinted praise for their generous offer. And we know enough of the leading men of Ogden to say without fear of contradiction that if Ogden is called upon to fulfill her offer, she will do it in a manner to make every patriotic Westerner feel proud.

Some decisive action must be taken quickly. The West and the Nation need such a body as the

Irrigation Congress was before the insidious influences which now control it crept in.

Which shall it be—the old Congress, thoroughly cleansed, or a new Congress?

Whichever it is, it must be an institution of the United States, for and in the interests of the United States, and manned by patriotic citizens of the United States.

Bring the Landless Man To the Manless Land

Spokane business men are after the land hog. The Chamber of Commerce of the western metropolis of Washington has begun a campaign to induce the big landholders to put their lands on the market at reasonable figures.

These business men, interested in the development of their section of the nation, never have made a more wise move. The West has been handicapped seriously for years by the holding by wealthy men of large tracts of idle land for speculative purposes.

If desirable settlers are to be obtained, the land must be offered at prices which the farmer can pay. One intelligent farmer settled upon a piece of land for which he will be able to pay is worth a dozen speculative deals in real estate that remains idle.

Abnormal prices for land mean that few desirable settlers will attempt to buy it and still fewer will be able to pay for it.

It is estimated that there are 150,000 acres of land under the ditch in Washington, which are lying idle. This is nearly one-third of Washington's irrigated lands.

It is idle because it is practically all in private ownership and is held at prices which the average farmer cannot pay. True the land may be worth all the owners ask for it, and produce big interest, when cultivated, on the values at which they hold it, but this does not help the intelligent farmer with a small amount of capital who really wants to develop and pay for a farm.

Once these big landholders are taught that in the end they will realize a far greater profit as well as benefit their state and nation through permitting their lands to be settled up at reasonable valuations with progressive, hustling producers of wealth, the development of the West will progress with much greater strides.

More power to the business men of Spokane. This work which they have undertaken means much to the Inland Empire. It is a work which other western Chambers of Commerce and Commercial clubs can well afford to follow.

**Newell
and the
"Betterment"
Joker**

A pernicious joker, under which the Reclamation Service expects to force the Federal Water Users to pay for the correction of all the mistakes and incompetency of its engineers as well as some other things which look suspicious, was slipped into an Indian irrigation bill, which was passed by Congress in 1912. It is known as the "betterment" clause, and makes all charges, in addition to those named in the settler's original contract, a lien upon the lands of the water right applicants.

Western Congressmen and Senators, almost to a man, insist that they did not know the import of this joker at the time the bill was passed. The settlers did not learn of it until they sought by law suit to protect their rights.

When Congress took up reclamation legislation at this session, G. E. Rodman, secretary of the Sunnyside Water Users' Association, and treasurer of the National Federation of Water Users' Associations, wrote to F. H. Newell, director of the Reclamation Service. He asked him as a matter of fairness to urge the repeal of this pernicious "betterment" clause.

This, in part, was Mr. Newell's reply:

"Relative to your request that an endeavor be made to secure from Congress legislation eliminating the provision as to betterments, contained in Section 3 of the Act of August 9, 1912 (37 Stat., 265), it may be stated that the so-called Reclamation Extension Bill is, as you doubtless know, now pending before the proper committee in Congress, and it can not be foretold what disposition Congress will make of the matter."

In a letter to Secretary of the Interior Lane, Mr. Rodman quotes the Newell reply and adds:

"It is the desire of the Water Users that this provision in regard to betterments be repealed and if Mr. Newell is not opposed to the repeal of it, why did he not say so? The only conclusion that we can come to from his answer is that he is opposed to the repeal of the provision and will fight to have it retained in the law if the matter ever comes up in Congress. We cannot get away from the conclusion that Mr. Newell is taking too much of a hand in the legislation affecting the Water Users."

The Newell letter is typical of the man. It shows clearly just how little he has at heart the interests of the Federal Water Users.

The problems of the Reclamation Service are now largely human ones. Secretary Lane must realize this. In fact, he has been quoted as believing the human problems are uppermost. If he is going to solve these problems, he can only do so

by surrounding himself with red-blooded, warm-hearted men who will devote themselves to the interests of the settlers instead of those of designing politicians and corporations.

The time has come to eliminate Mr. Newell and his ilk from the Reclamation Service. Their usefulness to the Service is passed.

The Newell crowd have heaped up millions upon millions of dollars in charges against the Federal irrigation projects, all of which the settlers are asked to pay. Nearly one-half of these charges are unjust because the settlers will obtain no benefits from the work for which it is claimed this money was paid. Forty millions of dollars is generally considered a conservative estimate of the amount of money charged against the settlers for something which is not doing them any good and will never do them any good.

This condition, and Secretary Lane has been made pretty well acquainted with the facts concerning these expenditures, should be enough to cause Mr. Newell's elimination from the Reclamation Service.

If it is not, then he should be ousted on the grounds of humanity. His place should be filled by a man sufficiently human to fight for and protect the interests of the Federal Water Users.

What is the whole Federal reclamation of the West worth, if even one man can charge justly, and prove his charge, that he has been treated unfairly or dishonestly by his government?

**The
Call
To
Arms**

With the Twenty-Year Extension bill a law, the real serious business of the Federal Water Users in re-adjusting their conditions is at hand. The projects are to be revalued. Secretary Lane has declared that the Water Users shall have one member of the board of three, who will make these revaluations. These boards must decide whether the settlers must pay for \$30,000,000 to \$40,000,000 worth of so-called work, from which it is generally agreed they can derive no benefit.

Shall the Water Users be made to pay one dollar for which they do not receive full value?

It is now time for every Federal Water User to ask himself or herself this question. It is now time for the various Water Users' Associations to consider this question.

It is a question which must be settled for all time while the project revaluations and the re-adjustment of payments are in progress. It can only be settled satisfactorily by every Water User doing his share in working out the problem in a

manner fair and equitable to his government and to himself. If an equitable adjustment is reached it can only be accomplished by united action of the Water Users, forgetting individual interests and working patriotically for the good of all.

THE IRRIGATION AGE urges the officers of the National Federation of Water Users to call a meeting of delegates from all the projects to meet in some Western city, centrally located, within the next month to consider thoroughly the revaluation problem. The problem should be studied from every angle at this meeting. Policies, which will protect the interests of the Water Users as well as the government should be adopted. United action in following these policies in all the projects should be pledged.

Every Water Users' association should take immediate steps to do its share toward financing the work of the National Federation. It cannot do anything without funds.

Unless the Water Users present a united front it is doubtful if they can obtain a fair or satisfactory revaluation of their projects. Not because the United States government is grasping; not because Secretary Lane does not want to be fair, but because the old bureaucracy in the Reclamation Service will have one member of each revaluation board and this bureaucracy is determined to stay on the government pay roll at any cost. It can only do so by covering up its mistakes, its extravagance, its foolish experiments, its ill-smelling work by making the settlers pay the bills.

If revaluations are agreed upon, which result in charging off at least \$30,000,000 from the costs of the projects, as they now stand on the government books, the Reclamation Service bureaucrats know Congress will probe their work to its very vitals. They know Congress will clean house from top to bottom and that many if not all of them will be turned out.

Better every one of them lose their jobs and go to the poor house than that any Water User be forced to pay one dollar which cannot be charged justly against him.

Absolutely fair revaluations—revaluations made by boards which will go to the very bottom and sift each expenditure in minutest detail—will result, THE IRRIGATION AGE believes, in charging off at least \$30,000,000, which the settlers otherwise must pay. If a fair revaluation results in charging off only one dollar, it is worth working for because once it is made, every Water User will be satisfied and contented with his financial relations with his government.

If the National Federation officers call this

meeting, which THE IRRIGATION AGE again most earnestly urges them to do, steps should also be taken to obtain from Congress further relief measures for the settlers. The twenty-year bill covers but a very small part of the reforms and relief needed to make the federal projects the ideal spots in which to live which they should be and which the men who helped originate and embellish the legislation under which the projects were begun hoped they would be.

Congress will grant this further relief if the Water Users go to Washington united. They can only do this through their National Federation of Water Users' Associations. Rally, Water Users! Concentrate your fire. Make the Federation a thoroughly substantial institution. Finance it so it can work for you 365 days in the year.

The Farmer and the School-Teacher "I am firmly convinced that the country school in its work should represent and reflect the industrial life of the community and that the teacher should be so trained that he can serve in a very large and helpful way, not merely the school interests of his community, but the industrial and agricultural interests of his community as well."

State Superintendent of Public Instruction W. F. Doughty, of Texas, uses the above words in a letter urging all country school teachers to attend the state and county farmers' institutes. The school teacher is something more than just a salaried employe. He is a servant of the public, charged with a most sacred duty. He can best perform his duty if he is in thorough touch with the parents of the children whom he must instruct, and if he has the interests of the citizens of the community in which he works at heart.

It may mean giving up some of his vacation days to attend the farmers' meetings, but if he really wants to succeed in his work he will find these days well spent. He will learn much of the industrial conditions and needs of his state. Better still, he will do much toward bringing about closer co-operation between the farmers and the country schools, a most desirable condition in every rural community.

The North Platte Valley Water Users' Association has offered ten cents a head for all pocket gophers trapped within the project. The gopher situation is quite a serious one on this project.

Australia plans to spend \$25,000,000 to open the Murray river to navigation and to construct an irrigation system that will develop 1,500,000 acres of land.

THE SILO MEANS MONEY TO THE IRRIGATOR

It Is no Longer an Experiment in the West; It Is a Necessity

BUILD a silo. It means more to the irrigated farm today than almost any other improvement which the farmer can add. The silo on the irrigated farm is no longer an experiment. In fact, today among the most close students of intensified farming, it is considered an absolute necessity.

Its value to the irrigated farm, where dairy cows are kept or where livestock is being fed, has been greatly enhanced through experiments by practical farmers, who have proven that the feed crops of the West are practically all good for silage. Alfalfa is being used as silage on some farms in nearly all the Western states. Experiments in Western Washington have proved that all of the grass crops, wheat, oats, vetch, rye, peas, clover and even mesquite make good silage.

Corn can now be grown almost any place west of the one-hundredth meridian. As it is becoming acclimated the corn is improving rapidly throughout the West and some of the best corn in the nation is now being grown on irrigated farms. Corn is the most important silage feed in the dairy sections of the eastern and central sections of the United States and it promises to assume almost equal importance in the dairies of the West.

The sorghums, which grow prolifically in many parts of the West, are also recommended for silage.

"The silo is a proven necessity on our high priced irrigated lands," says J. S. Stinson, a

WHY I USE A SILO

THE Irrigation Age will pay five dollars to the irrigation farmer who writes the best letter on "Why I Use a Silo." It will present copies of *The Primer of Irrigation*, a book every irrigator should have in his library, to the writers of the five next best letters. These letters should reach The Irrigation Age office, 30 N. Dearborn St., Chicago, Ill., not later than Sept. 1, 1914. Address care of the Silo Editor.

The Age offers these prizes because it wants to give to its readers information of results being accomplished by actual irrigation farmers. The Age believes in the value of the silo on the irrigated farm. There are still many skeptics among irrigators concerning the silo. The best arguments with which to convince them are facts; the accomplishments of other actual irrigators.

Tell The Age what you have accomplished through the use of a silo. Do it not only because you may want to win one of the prizes but because your experiences may greatly aid some brother irrigator.

Colorado farmer. "The selling prices of our dairy products are not always under our control, but the cost of production is. The silo has solved this cost problem for me, for by its use I am keeping twenty-five head of stock on twenty acres. We are buying some hay at \$5 a ton and by feeding it to the cows I am getting \$12 to \$15 a ton. Every stock man and dairy woman has looked out over the meadow and longed for the green grass for the winter time. The ensilage from the silo is summer conditions for our cows; that degree of succulency is present in this feed so that it keeps up the milk flow. Our

cows dropped off two pounds each a day last month when we stopped feeding it and we had the best of other green feed to take its place.

"Ensilage is a heavy product and we feed each cow twelve to twenty pounds morning and evening. To reduce the labor and keep down the cost of the cream, the silo should be close to the feeding alley, by the stable, barn or sheds, outside the barn, for an odor is always present and we do not care for this in the stable."

The silo makes it possible to conduct a farming business on a business basis instead of being compelled to follow the wasteful practices adopted in the days of cheap lands, feed and labor. It is an all-year-round insurance against the shortage of succulent feed. It often proves just as much of a necessity in summer as in winter.

Those who



Silage fed calves. They gained two pounds daily on Kafir Silage

are warmest in praise of the silo are the farmers who are using them.

The use of silos has three great advantages over dry feed methods. It is more economical, the feeding value of the product is improved, and silos make cattle feeding profitable and hence help to maintain soil fertility. The economy of silage results from the fact that cattle will readily eat the whole stalk in

silage form while in whole or shredded dry fodder a goodly portion of the stalk is refused. If fodder is stored in a dry shed the percentage of waste in curing is not much different from the same in the silo, since there is a portion of silage on top that spoils, but if the corn is husked in the field the same crop in silage is worth at least 25 per cent more.

If the crop is to be stored the silo is the most economical storage room, since nearly twice the amount of dry matter may be stored in the same space in the form of silage as in the form of dry fodder. Also crops may often be siloed that would otherwise be lost.

The greatest recommendation for a silo is that it increases the feeding value of a crop. The increased feeding value does not come entirely from increased digestibility, but chiefly from the physical effects and the increased palatability of the silage. Therefore animals may be induced to eat larger amounts. Owing to its succulence, silage, like grass, keeps the bowels regulated and tends to maintain that degree of healthful vigor so essential in hard-worked dairy and breeding animals.

Some silo advantages are indirect. The most laudable thing about the silo harvest system is that it does away with selling crops off the land and thereby depleting the soil fertility. It makes a system of stock farming possible whereby nearly all the fertilizing constituents are thrown back to the soil in the form of manure.

Silage is pre-eminently a cow feed. It finds greatest favor with dairy cattle, since it may be made to replace the succulent grass in winter, or may serve to uphold the milk flow during a drought in summer. In dairies near cities, where pasture is not available, it often determines the difference between profit and loss by supplanting costly grain foods. It also makes possible the rearing of calves cheaply to replenish the herd. Some complaint has

The cuts used in connection with the story on silos are from photographs made for the Santa Fe Railway.



Southwest farmers listening to a discussion of silos and their possibilities. The talks were made by lecturers on a Santa Fe railway demonstration train.

been made against the flavor of milk from silage fed cows, but there is no danger from this source if the silage is first class, unless the milk is allowed to set in open vessels in the barn and to absorb the odors, and the milking is done after silage is fed.

On the general farm the good effect of silage on the health of the breeding of young stock in winter can

hardly be overestimated. It is an excellent feed for ewes with lambs. It may be used in small quantities for maintaining the idle horses, but it is too sappy to feed to work horses.

The chief value of silage on the beef farm is in providing a cheap and healthful ration for the breeding herd. Large quantities fed to fattening animals makes the flesh too soft and sappy. It may, however, be used freely in the first part of the fattening period and since it is a great appetizer small amounts fed to animals on full feed produce wonderful results as a tonic.

In regard to the kind of a silo, that is a matter for each individual farmer to settle for himself. They are all good. They will all keep silage in first-class shape. They will all pay for themselves several times over. Some makes stand the wind-storms and are more fireproof than others. Some cost more than others. These are points for the individual to settle. Do not build too large a silo. It is much better to build two smaller ones. Do not have too much surface space, as from two to four inches should be fed off the surface each day. This insures less waste and sweeter silage. Some build two silos, one for winter feeding and one for summer feeding. This is a very good thing to do.

Extensive experiments with silage have been conducted recently at the experimental station at Puyallup, Wash. Concerning the results accomplished, H. L. Blanchard, assistant superintendent of the station, says:

"We must not cut our corn into the silo before it has become sufficiently mature. There is much evidence that corn in this state should pass the glazing stage and have about begun to ripen for the best ensilage. No doubt the quality of our corn silage will continue to improve from year to year as certain varieties become more and more acclimated. The best method of planting—in hills or in drills—will need to be worked out under the

(Continued on page 313.)

The Federal Water Users



A Department Devoted to the
Interests of the Farmers on the
Government Irrigation Projects

EDITED BY GEORGE J. SCHARSCHUG

THE TWENTY-YEAR BILL PASSES; NOW WHAT?

Any Relief for Settlers in New Law is Due These Men; the Executive Committee of the National Federation of Water Users' Association

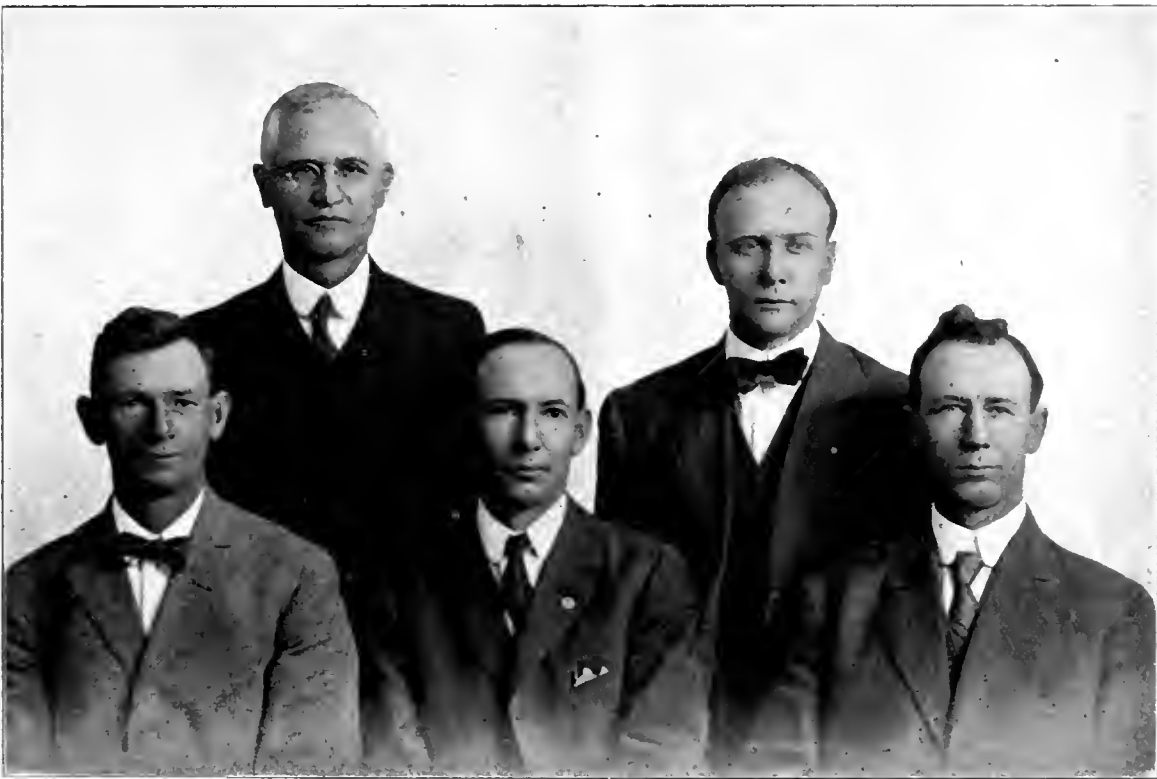

Standing—Earl B. Smith, Somerton, Ariz. (Yuma Project), President, and O. E. Farnham, Newell, S. D. (Belle Fourche Project), Secretary.
Seated—Fulton H. Sears, Fallon, Nev. (Truckee Carson Project); Scott Etter, Carlsbad, N. M. (Carlsbad Project), and George E. Rodman, Sunnyside, Wash. (Sunnyside Unit of the Yakima Project), Treasurer.

THE Twenty-Year Reclamation Extension bill will be law within a few days. It passed the House on July 30, in about the form agreed upon in Secretary of the Interior Lane's conferences early last spring, except for one important amendment. This amendment, which completely revolutionizes the financial side of the Reclamation Service, will not directly affect the settlers now on the projects, for whose relief the measure primarily was advocated.

The amendment provides that all expenditures for irrigation work must be approved through annual appropriation measures by Congress, author-

izing such withdrawals from the Reclamation fund. In the past, the expenditures from the fund have been entirely at the discretion of the Secretary of the Interior.

As many amendments designed to afford greater relief to the settlers, which the Senate adopted, were eliminated in the House, the bill will go to a conference. There may be some changes from its present form, but in all probability it will become law in practically the form in which Secretary Lane and his conferees originally offered it to Congress.

And now?



ABEL ADY,

President of the Klamath Water Users' Association of Oregon, Who Has Worked for Months in Washington for the Twenty-Year Bill.

In accordance with his pledge to the Federal Water Users in his letter which accompanied an early draft of the Twenty-Year bill, Secretary Lane must proceed immediately with the revaluation of the projects and the readjustment of the payments for water rights. In their oratorical efforts to carry the measure to victory, Western Congressmen, almost to a man, declared every dollar of the Reclamation fund would be paid back into the United States treasury, providing the extension of payments was granted. In their pleas for the "poor devils out in the desert," they made no mention of the fact that from \$30,000,000 to \$40,000,000 had been spent by the Reclamation Service, from which the Water Users derive no benefit and for which in all justice the settlers should not be held responsible. Secretary Lane has been quoted as stating that he favored charging off certain overhead charges, amounting to about \$3,000,000, now charged against the projects, but that the settlers must pay for all engineering "mistakes" and other expenditures, because irrigation engineering is not an exact science.

If the settlers are forced to pay for all the waste, extravagance, mistakes and wild-eyed experiments which have characterized the Reclamation Service work, the price to them of the ten-year extension in their water right payments will be tremendous.

Under such conditions it is doubtful if many of the settlers will give up their old contracts, which stipulated much smaller payments, in order to obtain the benefits of the extension law. This may mean chaos and worse conditions than ever before on the projects.

The Secretary of the Interior is armed with much more drastic powers than before to enforce the demands of the law and the Reclamation Service regulations. What results these new powers will bring is hard to foretell.

In addition to the possibility that the extension of payments may save many settlers their homes and make home building easier for new comers, there is one other feature of real value in the bill. This is the recognition accorded the Federal Water Users' Associations. It is the one bulwark against even greater domination by a government bureaucracy which the Water Users have.

Credit for the two features of the bill, which it is hoped will prove of relief and benefit to the settlers—the extension of payments and recognition of the Water Users' associations, is due entirely to the officers and active leaders of the National Federation of Water Users' Associations. These men

laid the foundation for the bill at a conference in Washington fifteen months ago. They fought valiantly to the end to obtain effective relief for the Water Users. Not once did they waver.

Measure after measure of relief, which they asked, was cut from the bill in the Lane conferences. Finally it was sent to Congress minus all relief clauses except the time extension. Recognition for the Water Users' associations was gained only after some very adroit maneuvering by officials of the Federation. They worked hard for other amendments to the measure but the forces at Washington could not be overcome.

The Western Congressmen were kept badly frightened about the success of the measure until the last moment, through threats of interest charges on water payments and other changes in the Reclamation law. That is why they feared to tell the truth about the Reclamation Service or insist vigorously on the various relief amendments asked by the settlers.

This fright, if it was really honest, was entirely unnecessary, as it was "doped" by the administration forces from the beginning of this session of Congress that the Twenty-Year bill in some form must be passed as sop to the West. Republican and Progressive Congressmen were pledged to such a measure by their party platforms, and with the administration seeking to appease the West, which is not at all pleased by the free sugar, wool and other features of the tariff measure, as well as some other recent legislation, the bill was never seriously in danger of not passing. These facts were borne out by the final vote upon the bill in the House. It was passed without even a roll call being demanded.

PROTECTS THE WATER USERS

The Secretary of the Interior has awarded the contract to the Canyon Power Company of Oakland, California, for the lease of the electric power plant, substation and transmission line in the Truckee-Carson irrigation project in Nevada. The term of the lease is ten years.

The bid of the Canyon Power Company is at the rate of one-fourth of a cent per kilowatt hour for the excess power during the summer months (April to September, inclusive), and at the rate of three-eighths of a cent during the period from October to March, inclusive. There is to be a minimum payment of \$1,200 per month during the summer months. The net income to be expected is approximately \$14,000 per annum as a minimum, with a possible maximum of approximately \$30,000 per annum.

A stipulation will be inserted in the contract for the protection of the Federal Water Users and other small consumers by limiting the price to be charged such consumers.

ALFALFA BLOAT IN CATTLE

This remedy for alfalfa bloat in cattle has been used successfully in Idaho for years: Put a level teaspoonful of common pine tar on the root of the animal's tongue and relief will come immediately.

SOME R. S. METERS WHICH FAILED TO METER

Also Another Vigorous Demand for a Reclamation Service Investigation

By H. A. BUSTRIN

Vice-President of the Land Owners' Protective Association
of Phoenix, Ariz.

I WISH to criticize a recent article by W. A. Ryan, comptroller of the Reclamation Service, on the liberality of the 20-year extension bill. In the first place, conditions he refers to do not compare with irrigation under our Federal projects. They can only be compared with Rural Credits, as now planned. If he wishes to be fair why does he not make his comparison with foreign irrigating projects? Since he has seen fit to compare with strictly farm loans, I will answer in that line.

In the first place, Mr. A. borrows a given sum on his land, or he buys his land for a price and borrows to improve his future home. That money is his. He does not have to support an army of government engineers, clerks, and helpers, who spend this cash for him without his consent or even asking him whether he wants certain work done, and sometimes even without his knowledge as to what they are doing. This army often does experimental work, one piece after another, which is all lost and all because these government experts are ignorant of the practical way of doing things, and have no knowledge or concern as to Mr. A's needs or his ability to pay.

Now, Mr. Ryan was here and I am informed that he found some terrible things here. His report was so strong that Secretary Lane almost accused him of hobnobbing with Sam Barrett. If he had, Sam Barrett could have shown him more things than he could find in the Reclamation Service books in Phoenix.

For instance, a certain man invented a water meter. To test it a certain concrete box had to be built and it was very expensive.

Instead of building one such box they built several hundred, and the aforesaid meter was a failure.

Mr. A in that foreign land of which Mr. Ryan speaks, borrows and spends only the amount he

feels able to repay, and uses it for his own benefit. But we are not asked as to our ability to pay back. Cost is piled on cost until it makes the best of us stagger. And now they are willing to give us twenty years instead of ten, hoping that we will take the bait and not question their wisdom, much less their honesty. I verily believe that the Reclamation Service has spent enough time and money on this project to build two. The meter boxes mentioned are only one instance out of hundreds where money has been wasted or thrown away and from which we get no benefit.

Another thing Mr. A does not have to pay for is a lot of engineers, helpers, visitors, and hangers-on who gather sixty miles from the railroad for a "banquet," and all the food and drink—the very best on the market—was freighted to that banquet hall and charged against the farmers as labor performed. Neither does he have to support an advertising outfit taking pictures boosting the same engineers. On this project alone such advertising had cost more than \$9,000 up to 1912. Their traveling advertising man has been here several times since.

Now, do you blame us for asking relief? We are not responsible for that waste, incompetence and "ignorance." The Reclamation Service office is so full of incompetents that they are in each other's way. And their only purpose seems to be to spend money and draw their pay. The extension of payments will not still our cry for justice. Every unnecessary item of cost must be eliminated and the house must be cleaned from top to bottom. Then and then only will we be content.

Water Users on every project stand firm and demand justice and I am sure justice will be given us. Congress is awake, they know we are being worse than robbed. They may be waiting for us to act. Why not ask a sifting of the Reclamation Service to the very bottom? I am sure they will give it.

WATER USERS PLAN AGRICULTURAL SCHOOL

THE foundation on which the Federal Water Users on the Truckee-Carson project in Nevada hope to see built within a few years a great agricultural college, have been laid. The foundation is a ten-acre playground and park, carved out of the desert in a day.

With true community spirit and enterprise, the farmers of the Harmon district on the project banded together, and with 140 head of their horses and machinery leveled the land in a day. Five acres are being set out in ornamental trees, shrubbery and lawns. The balance of the land will be used for a ball grounds, an athletic field and as a site for a school building. A bond issue for the construction of a public school will be voted on soon.

About two months ago the people of the Harmon district asked the government to set apart 40 acres of land for the benefit of that locality. Among the points that they urged was that in all the project there is not a place where the farmers can take their families for Sunday's rest or a day's picnic; that in the timber along the river the mosquitoes are bad and the groves are not in condition for enjoyment.

The government agreed to give them 10 acres, with free water, and withdraw the 40 so that when they proved that they made good use of the 10 acres they could have the rest. The people of the district immediately went to work and cleared the

(Continued on page 311.)

"U. S. HAS DRAINED PROJECT OF ITS CAPITAL"

By O. E. FARNHAM

OF NEWELL, S. D.

Secretary of the National Federation of Water Users' Association



O. E. Farnham

THE Belle Fourche Water Users' association suit, which may settle many important points in the reclamation law and the regulations promulgated under it by the Reclamation Service, is still awaiting decision by the circuit court of appeals. The arguments were presented on June 2.

Our people are receiving water for their crops under the injunctive orders issued a year ago and are certainly improv-

ing the opportunity to get in shape to meet such payments as may have to be made in the future to protect their homes. We have a dairying and stockfeeding proposition almost exclusively and it takes capital to handle it and stock our farms.

The Government has been draining the project of its capital during the past five or six years, until

most of the livestock has been sold at forced sales and the balance heavily mortgaged to meet water payments. We can not operate the project under such conditions and the farmers must necessarily be permitted to recuperate before any payments can be expected.

Some Congressmen at Washington seem to lose sight of the fact that the Government has millions invested in these projects that can never be realized on unless it permits the accumulation of sufficient capital and livestock in these communities with which to stock up these farms and develop them to a high state of production. Most of the lands to be reclaimed are Government lands, otherwise worthless, and the Government must handle these lands as private capital has in the past developed large areas of arid and semi-arid lands in the West.

Time and credit have been extended the people who would take hold of these lands and develop them. In some cases the promoters have developed the lands themselves to a high state of productivity and then sold them on the installment plan, the produce from the lands paying the purchase price. The matter of extending time and credit to these settlers is an entirely different proposition from loaning money to the Eastern farmer, as the settlers on these projects are developing what is considered as worthless Government land.

USE YOUR WATER USERS' ASSOCIATION

THE Water Users' Association on the Shoshone project in Wyoming is working hard to solve the seeped land problem, with which many of the settlers must cope. A committee, consisting of a representative of the Reclamation Service, a representative of the Water Users, and a disinterested non-resident will examine the seeped areas in the project during this month.

In order to make this examination thorough and fruitful of results, the association has been collecting data from the settlers concerning the seeped land. The seepage and drainage problem concerns the whole project, yet some of the Water Users have shown an inclination to "go it alone." To these The Tribune, of Powell, Wyo., has something to say which not only the Water Users of the Shoshone project should take to heart, but about which every other Federal Water User should also think. It concerns the advantages of acting through the Water Users' Association in dealing with the government. The editorial, in part, is as follows:

"The opportunity to file with the directors of the Water Users' Association one's own estimate of his bogged land is too good a one to be lost. It was for just such purposes as this that the Association was formed; that is, to serve as the accredited mouthpiece of the settlers taken collectively. Requests and complaints from a single person are often ineffectual—not, perhaps, on account of a dis-

inclination on the part of the authorities to attend to such cases, but because in the press of work of the sort for which the Reclamation Service was instituted, the personal interests of the individual are often temporarily sidetracked and maybe forgotten in the course of time.

"No doubt many of the settlers dislike what smacks of too much 'red tape'; they prefer to do their own talking—to disburden their minds of their opinions of what seems to them a personal wrong, but which is most probably merely an incident in the day's work of the Reclamation Service. With all due respect to them, we would say that sort of thing does not pay. The proper thing is to write or go to the secretary or some other official of the Water Users and state your case, which is added to other similar cases and the whole tabulated and put into business-like shape so as to be easily and quickly understood by the official to whom it is presented. In this way you are pretty sure of a prompt consideration of your case. That is one point. Another is the fact that several complaints together have an added weight; they mutually sustain each other.

"Pace off your seeped areas and send in your estimate of them. Thus the secretary will have something to guide him in representations to the proper officials. The Association will be all the stronger the more it is used."

IRRIGATION IN THE EAST AND SOUTH

By GEO. J. SCHARSCHUG

FARMERS in the Delaware valley in New Jersey are urging their Congressmen to seek a government appropriation for the construction of an irrigation system.

The next session of Congress is likely to witness the introduction of a number of measures proposing federal aid for irrigation projects in various sections of the rain belt.

Severe droughts, which have prevailed this year in many of the best trucking, fruit growing and farming sections of the East and South, have aroused the agriculturists of these sections to the possibilities—yes, necessity of irrigation, if they desire to obtain maximum crops from their lands.

The old cry of the rain belt farmer that "water out of a ditch ain't like that that falls from the heavens" is being forgotten.

The Eastern growers are rapidly coming to realize that rain is a fine thing—when it falls; but if good crops are to be grown they must have water—and the crops will not discriminate as to whether the water comes from the skies or out of a ditch.

More private irrigation systems, none of them extensive, it is true, have been constructed in the East and South this year than ever before. Several projects covering big garden truck and fruit areas in Kentucky, Indiana and Iowa are being planned and work on these will probably begin this fall. A number of prominent growers from various parts of the East and South have been in the West studying irrigation methods and systems. The government has sent trained irrigation experts into the South to teach the farmers the value of irrigation water and how to develop and use it. A twenty-acre government irrigation demonstration farm has been established near Selma, Alabama.

Newspapers throughout the East and South have begun advocating actively through editorials the establishment of irrigation systems.

"Put the untold millions upon millions of gallons of water now going to waste each year to work," is their battle cry.

And with crop after crop being totally destroyed or seriously damaged by the droughts, the farmers are becoming thoroughly aroused to need of "irrigation insurance."

The irrigation agitation in the East and South has only begun. It will result in the installation of a number of plants this fall, and more next sum-

mer if there are conditions of drouth. If next summer proves a season of sufficient rainfall, many proposed projects and systems will be delayed or completely forgotten for a time.

Meanwhile the men who have irrigation systems will continue as they have been doing this year to demonstrate the feasibility and value of "artificial watering," and other farmers will take it up. They are bound to do so, because it means dollars in their pockets.

Two years more of such conditions as have been experienced in many sections this year will mean the installation of irrigation plants on some of the farms and in some of the orchards in practically every county east of the one hundredth meridian.

The possibility of the United States being an irrigated land from the Atlantic to the Pacific and from Canada to the Gulf within the next two decades is a dream that is likely to be realized. It is a dream that if realized will mean billions of

added wealth to the nation, and is perhaps the only certain and effective method of cutting down the present high cost of living.

Irrigation in the East and South can be established with far less difficulty than in many sections of the West. In every one of these states the supply of water either on the surface or close to the surface is very large. There is hardly a farm which has not within its own limits either wells or springs from which pumps or hydraulic rams could take sufficient water to absolutely insure the crops against drouth. Then there are the vast numbers of rivers, creeks and ponds, all filled with life-giving water, which can be taken out either by gravity or pumping systems.

Such development costs money, but so does any other farm improvement, and the farmers are beginning to realize that they cannot buy any better insurance than an irrigation system, even though they do not have to use it more than once or twice in a season. Its insurance value must appeal to them, but there is another feature about irrigation in these areas which compels their attention—the increased value of crops where irrigation waters are used to augment the natural rainfall. This is especially true where intensified truck farming or fruit growing is practiced.

A sub-irrigated farm in Florida, part in truck and part in fruit, sold recently for \$3,200 an acre. It paid about 25 per cent gross profit on this investment last year.



The irrigation pump house on the poor farm at McCook, Neb. The pump delivers an 8-inch stream against a 90-foot head.

The GRIMES

A spiral water lift that will permanently solve your irrigation pumping problem. Unfailing in its delivery from lake, stream, ditch or well.

Especially designed for elevating water from shallow sources regardless of sand, gravel, or mud conditions. Action uniform at all times.

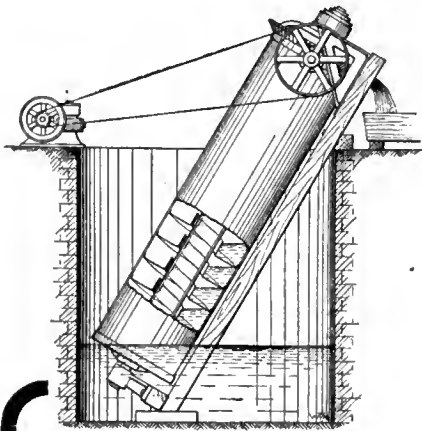

The Grimes Pump is an ingenious but exceedingly simple, one-piece machine of the most durable construction.

Always ready for instant use.

Cannot get out of order.

Requires very little attention.

The Most Economical Pump on the Market

The Grimes Pump will lift a given quantity of water to a greater height with less power than any other water elevator. Our 52-inch diameter pump will raise 1000 gallons per minute 30 feet on 9 horse power.

Guaranteed ratings of standard sizes are given herewith



Can be operated with any form of power available, constantly or as needed.

52 Inch 1000 Gallons		40 Inch 600 Gallons	
Elev.	H. P.	Elev.	H. P.
6 ft.	1.8	6 ft.	1.05
8 ft.	2.4	8 ft.	1.35
10 ft.	3.0	10 ft.	1.79
12 ft.	3.6	12 ft.	2.24
14 ft.	4.2	14 ft.	2.70
16 ft.	4.8	16 ft.	3.14
18 ft.	5.4	18 ft.	3.58
20 ft.	6.0	20 ft.	4.05
22 ft.	6.6	22 ft.	4.40
24 ft.	7.2	24 ft.	4.95
26 ft.	7.8	26 ft.	5.38
28 ft.	8.4	28 ft.	5.83
30 ft.	9.0	30 ft.	6.28

Irrigation Pump

The Grimes pump is the pump the wise irrigation farmer will eventually buy. This pump is today standing the most rigid tests alongside of other pumps and performing the work that they were intended to do.

Among our recent installations are plants at Lamar, Colo. (well); Delta, Colo. (river); Broadwater, Neb. (well); Mitchell, Neb. (ditch); Chadron, Neb. (river); Ft. Collins, Colo. (ditch); Loveland, Colo. (ditch—this Loveland pump is 40 feet long and a thorough success); Bridgeport, Neb. (well—plant just being installed).

Facsimile letters from users of the Grimes pump will be sent you on request, or we will supply you with their names and you can write to them direct, asking just what satisfaction their pumps have given them.

J. D. Thompson, general superintendent for seven large ranches in the famous Arkansas Valley of Colorado—a man who has had wide experience with many styles of pumping plants—writes us as follows:

“Was down to Lamar, Colo., and went out to see your Pump in action on Mr. Saylor’s place. Was very much pleased with the Pump; like it the best of any Pump I have ever seen. Have looked at a great many pumps from Garden City, Kan., to Pueblo, Colo.”

Respectfully yours,

(Signed) J. D. THOMPSON

The moderate initial cost of Grimes Pumps varies largely with local conditions and requirements, character of installations, etc.

Each plant is built to order and guaranteed to give complete satisfaction.

PRICE ESTIMATES GLADLY FURNISHED

WRITE FOR BOOKLET OR CUT OUT THIS COUPON AND MAIL TO US STATING YOUR PUMPING NEEDS



The Grimes Irrigation Pump Co.

1022 First National Bank Building
Denver, Colo.

GRIMES IRRIGATION PUMP CO.
1022 First National Bank Bldg.
Denver, Colo.

Acreage to be irrigated.....

Height to be lifted.....(ft.)

Nature of water
Source (ditch or well, etc.).....

Volume of supply

Kind of power available.....

Name.....

Town.....State.....

NEW IRRIGATION CONGRESS PROPOSED

Ogden, Utah, Ready to Furnish Permanent Home for Such an Institution

A MOVEMENT has been started in the West for the organization of a new Irrigation Congress to supplant the one which was sold to the Canadian land boomers. Ogden, Utah, is in the forefront of the movement and offers a permanent home for annual meetings of the new Congress.

The Ogden Examiner says editorially of this movement:

"Utah was the cradle of irrigation in the United States. The thrifty people who came to the Salt Lake Valley were the first to put water on the land. They taught the arid West a lesson that has meant billions of dollars in the cause of reclamation. But with all these years of progress and practical experience we have still much to learn of the scientific use of water, and there are yet millions of acres in this state waiting to blossom like the rose with the coming of water. Each year there is much water wasted in the irrigated districts. The warning has been sounded repeatedly that farmers are using too much water because it is handy. There is need of conservation of water if we are to make the most of our reclamation opportunities. We have had much talk of new irrigation projects, but action has been deferred from time to time because of lack of organization. Utah and every other state in the West needs a working organization to promote irrigation and reclamation projects. It is of vital importance to future growth. In the face of these crying needs that mean so much to the upbuilding of the West, the Irrigation Congress, a strictly Western institution, has been sold to Canada for a mess of pottage."

The Examiner then quotes in full an editorial demand for an abrogation of the sale of the Congress to Canada, which appeared in the July issue of THE IRRIGATION AGE.

Continuing its comment, The Examiner says:

"It must be admitted that the Irrigation Congress has gone far afield from its original purpose.

Its value to the West at the present time is practically nil. It has become cheap trading stock for personal favors. The last meeting held in the West was at Salt Lake two years ago. The report of that meeting has never been given to the public, though repeated calls have been made for its publication. The constitution provides that this report be published. George W. Snow as chairman of the board of control, and Richard W. Young as chairman of the board of governors, should see to it that there is no further delay in making a full report of the Salt Lake session. It would not cost more than \$1,500 and it would be an invaluable record. If there is no other way to do it the people of Salt Lake should guarantee the expense until such time as an appropriation can be made by the legislature. That report would be a decided advantage to Judge King, who is now in Salt Lake in behalf of the Secretary of the Interior in an effort to evolve the best plans for Reclamation Service. His conference with attorneys of irrigation districts would profit by having access to these records.

"This is a time for prompt action by the friends of irrigation in the West if the cause is to go forward. It is time to organize a new Irrigation Congress to take the place of the one which lapsed last year and was this year sold to Canada. The West should not suffer by the failure of the present Congress to make good. Ogden offered to entertain the Congress this year and was turned down. Now Ogden will offer to entertain an Irrigation Congress next year and make Utah its permanent home. It will entertain such a Congress as will promote the interests of the West. And it will guarantee full publication of the proceedings. This city has always been ready to aid in giving life to such an important organization, and if Ogden is given the opportunity it will build a temple to irrigation that will be a beacon to progress and a signal that the West has come into its own."

A COVER CROP SHOULD BE SOWN IN THE ORCHARD

Winter Rye Seeded This Month Can Be Plowed Under In the Spring

E. P. SANSTEN

Colorado Agricultural College, Fort Collins, Colorado

THE success of an orchard depends in a large degree upon the management of the soil. The general tendency of Colorado fruit growers in the past has been to keep the orchard in clean culture from year to year with the result that the vegetable matter in the soil has become depleted and the trees are suffering from improper soil conditions, if not from lack of fertility. Experience shows that an orchard that is permanently kept in clean cultivation is not bringing the results that it should. Not only this, but in many sections of the state the formation of niter due in a large measure to clean culture has become a serious problem.

To remedy these defects in orcharding, cover crops should be used; that is to say, some vegetation should be grown among the trees to shade the soil and also for turning under later in the fall.

What crop to use in orchards can best be determined by local conditions and character of soil. In other words, the choice of plants is a local problem. Any crop that will produce a large amount of green material to be plowed under can be used. Oats sown early in the spring will form a heavy mat of herbage and should be plowed under when in milk. Red clover is another excellent crop, but in this case the cover crop should remain in the orchard for two years. The first crop of

(Continued on page 313.)

MANY USE IRON IRRIGATION GATES

By John J. Tibbetts

THE ranchers of the Sacramento and San Joaquin valleys of California are making quite extensive use of pure iron corrugated pipe, fitted with slide or hinge gates of cast iron, for taking water for irrigation purposes from the rivers. The corrugated pipe is especially useful for levee work because its form enables it to bend and adjust itself to changes of its bed, and to continue to do its work under conditions which would cause any rigid materials to crack and break. These pipes can often be seen in good condition for all practical purposes in spite of the fact that the shifting and settling of the embankment has forced the middle to a position several inches lower than either end.

Where water is so readily and cheaply obtained, as in these valleys, over-irrigation is likely to become a serious evil. The lowest portion of a section becomes water-soaked as a result of excess drainage from the remainder; and it is necessary to draw this water to a certain point and pump it over the levee and back into the river. Pumps and engines and necessary attention for this work constitute a continual expense; and this is one of the conditions which make the work of the island rancher so different from that of the farmer in other localities.

The lowest portions of his cultivated land are always well below the level of the river at high tide, but it is often the case that the surface of the river at ebb tide is quite a little lower than that of the water to be drained away. It follows that a pipe through the levee which is opened at low tide

and closed when the river is high will accomplish the drainage without the use of power of any sort. Many ranchers installed such pipes, opening and closing the gates at the proper times, and thus dispensed with the use of an engine.

The further step of making these gates automatic, so that the pressure of the water on one side or the other will open or close them when the conditions require it, was very easily taken. Cast iron gates, with the valve so counterbalanced, are now on the market, for use with corrugated pipe, and seem to be giving perfect service.

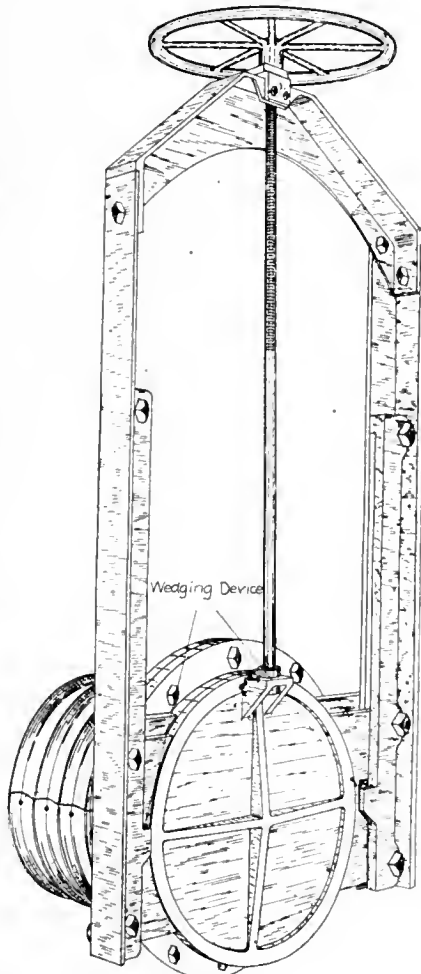

One of the Iron Irrigation Gates

THE DEEP WELL PROBLEM

THE limitation of space available in a bored well for the installation of machinery necessitates the use of special constructions for this service and the design of a pump to give maximum capacity and reliability with a minimum of power required has been the effort of expert engineers for many years. In many sections the yield of wells is limited and fairly efficient apparatus can be obtained that will pump all of the water that the well will give; but in other sections the volume of water to be obtained is dependent only on the capacity of the pumping machinery.

Such a condition necessitates a pump that will go in a limited space and has large capacity, simplicity of parts, steady load, high efficiency, durability and reliability. A pump called the Glendora has been built to meet these requirements. Its three plungers give approximately three times the volume of water that can be obtained with a single plunger, single acting pump of same size and approximately fifty per cent more than either the double acting or the two-plunger pumps. All valve stems, springs, cages and restricted waterways are avoided. Each plunger has sufficient leather cup packing to insure long service, has a single heavy valve so constructed as to allow maximum waterway and direct flow. Its power end is a crank motion of accepted form with no freak devices or cams or inefficient movements.

The load is steady as in a triplex pump. The plungers alternately coming into action at approximately their maximum speed and being so timed that one takes up the full load as the preceding one relinquishes it, insure a uniform, continuous flow of the water column and a constant average load on the driving mechanism.

The continuous flow of the water column prevents losses due to slip and the design of the power head reduces friction to the minimum. Positive displacement insures the maximum capacity at varying depths of water level and a power consumption directly in proportion to the net work performed.

IRRIGATION IN EAST AND SOUTH

(Continued from page 303.)

On the government demonstration farm in Alabama it has been found this year that by the application of irrigation waters garden truck can be matured almost at will and when the markets are at the highest point. A spraying system of irrigation is used on five acres of this farm. Under the supervision of the government experts irrigation systems are being installed on a number of farms in the Selma district. On many of them the furrow system of irrigation will be used.

The berry growers of Warren county, Kentucky, are installing one of the first large co-operative irrigation systems in the East. Their plant will be one of the overhead variety and will cost them about \$200 per acre.

Perforated pipes are to be set about sixty feet apart above the berry beds. Into these the water will be pumped at sufficient pressure to hurl sprays of water thirty feet.

These growers were forced to make this development after suffering an aggregate loss from drouth in two years of more than \$100,000. They also expect the spraying system to prove of additional value in the early spring by warding off late frosts.

When drouth threatened to completely destroy the garden at the Indiana Reformatory at Jeffersonville this summer the warden offered a demonstration of irrigation possibilities in the Hoosier state that has jarred many farmers from their lethargy and willingness to accept whatever nature brings. He put fifty prisoners to work in the fields constructing ditches and within a day completed an

irrigation system that saved the crops. The experiment at the reformatory will be continued and the state's agricultural experts hope to use its lessons in increasing interest among the Indiana farmers in the value of irrigation.

Just a little ways out of Chicago there is a farmer who is outdoing the canteloupe growers of the West as to profits per acre, because he irrigates. He has a flowing artesian well on his place. Other truck gardeners and farmers, whose lands adjoin his, are making just mediocre profits because they depend only on the natural rainfall.

In the truck garden districts of Iowa several different systems of irrigation are being used. Electricity, gasoline engines and windmills are being used to pump water. In the bottomlands along the Mississippi river a large number of pumping plants have been put in operation this year. There are thirty-seven eight-inch wells down on one large tract near Fruitland.

Irrigation is being advocated among the berry growers of Missouri. As strawberries are about 90 per cent water and good Missouri berries are worth \$2.00 a crate, the irrigation arguments have proven pretty effective this year.

Irrigation is being used effectively for celery and other truck crops in Michigan.

One might write pages and pages about these beginnings, and experiments in irrigation which are being made in the East and South. Each one is doing its educational work. Each one is demonstrating to the farmers its value. Each one will result in the installation of more of these "crop insurance" plants.

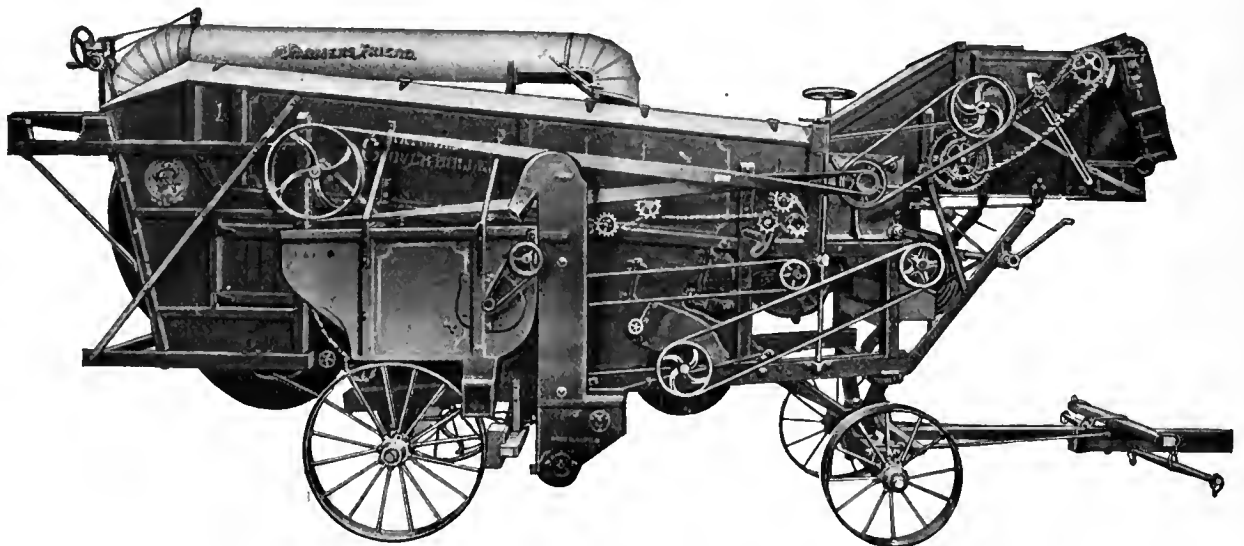

HULL YOUR SEED QUICKLY, PERFECTLY and ECONOMICALLY With a
"MATCHLESS" CLOVER and ALFALFA HULLER

That's just what you will do if you use a "Matchless" Huller on the job. It's the one huller that will hull all the Clover or Alfalfa you can get to it without sacrificing the quality of the work. Here's the reason! We use square steel brads in our hulling cylinder. This construction has every advantage over rasps of spikes, because no set of spikes will knock the seed out of the damp pods. Rasps gum up and are easily destroyed. Our system of separation is unique and effective. This consists of a series of rotating troughs with perforation in the bottom, with provision for adjustment to meet the various conditions of clover. The Patented Steel Scrapers attached to the bottom of these troughs thoroughly scrape the separator bottom and insure a steady and positive delivery of the pods to the hulling cylinder, regardless of the condition of the clover. This construction enables you to hull seed under conditions in which no other huller can operate; enables you to hull earlier in the morning and later in the evening than with any other—this insures a longer day, thus increasing your earning power. Give us an opportunity to prove to you right on your own farm that the "Matchless" is the speediest and cleanest huller on the market. WRITE FOR CATALOG TODAY, or call at our nearest Branch House.

THE AULTMAN & TAYLOR MACHINERY COMPANY, MANSFIELD, OHIO.

Sole Builders of Aultman-Taylor "Starved Rooster" Line of Machinery.

BRANCHES: Minneapolis, Minn.; Portland, Ore.; Lincoln, Nebr.; Kansas City, Mo.; Wichita, Kan.; Decatur, Ill.; Indianapolis, Ind.

When writing to advertisers please mention The Irrigation Age.

BRIEF NOTES FROM IRRIGATION PROJECTS

Colorado

Farmers in Prowers county, Colo., have organized a drainage district to reclaim about 2,000 acres of land in the Arkansas river valley. This land is now practically swamp. It will be drained and a power plant with which to pump water for irrigation will be installed.

The United States has filed an appeal in the Colorado supreme court in a suit to set aside the priority rulings of District Judge J. C. Caverder, involving 1,400 cubic feet per second of water in the Grand valley. The claim is being made that this water is being used to irrigate 12,000 acres which otherwise could be devoted to watering 140,000 acres under a government reclamation project.

Two hundred and sixty-six thousand dollars will be expended by farmers and the National Sugar Manufacturing Company in the perfecting of a system of irrigation for 12,000 acres of land lying north of Sugar City and between the Henry and Meredith lakes in Colorado. About \$90,000 has already been spent in the purchase of the Colorado canal, which conveys water into Lake Henry from the Arkansas river and the Twin lakes east of Leadville.

Twenty-seven farmers whose properties in the Platte valley are estimated to be worth \$500,000, have instituted suit in the Denver district court seeking an injunction against the Platte Valley Irrigation Company, et al. to prevent interference with the use of the waters of what is known as the Big Dry creek, on which these farmers depend for their irrigation water. The lands involved are situated in Weld and Adams counties, Colo., and comprise about 3,000 acres. The suit involves the question of the use of seepage waters from the Platte river and other irrigating ditches taking their water supply from natural sources.

Texas

The Trinity river irrigation district

in Chambers county, Texas, has filed on water for 30,000 acres of land. The district has constructed a dam, creating a reservoir to store 20,000 acre feet of water.

Sames, Moore & Co. have obtained control of the Espejo Land & Irrigation Company's property in the Rio Grande valley, near Laredo, Tex.

Farmers in Jones county, Texas, are

preparing to irrigate 1,000 acres with water from the Clear Fork, a branch of the Brazos river. The Brazos River Irrigation Company has also obtained a state permit for water to irrigate a large tract in Jones county.

A tract of 1,680 acres of land in Reeves county, Texas, is to be irrigated by the farmers owning it. The water will be taken from Sandia and Toyah creeks.

Irrigating In New Way

At Big Saving of Time, Money and Labor

This picture was taken from a farmer cutting ditch in the New Easy Martin Ditcher way that's proving such a great boon to farmers and road builders the country over. See description below.

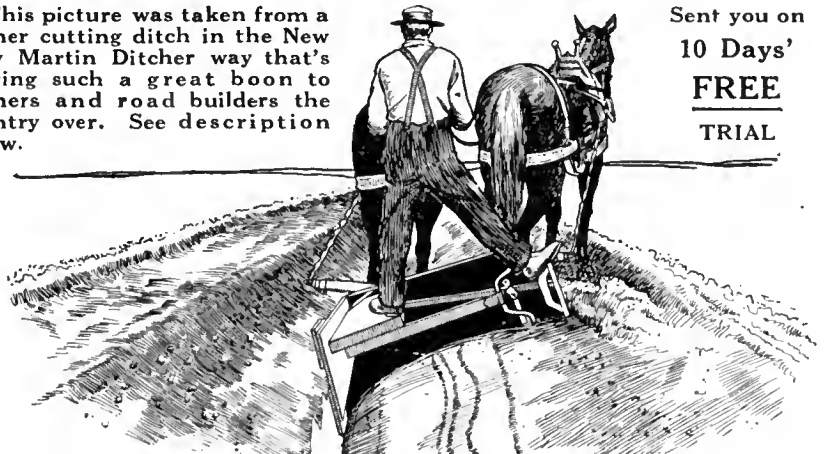

Sent you on
10 Days'
FREE
TRIAL

This combined Farm Ditcher and Road Grader is certainly a money-maker on the farm or road section. Does as much ditching or road grading in 1 day with 1 team and 1 man as 50 to 100 men with shovels, or 10 men and teams with plows, scoops, etc. Ideal for Irrigating, cutting laterals, cleaning out old ditches and for levee work.

Best of all, the price is only one-fifth of the big, clumsy, costly ones. Can even be used wherethey can't. Very simple. Fool-proof. Anybody can run it. All steel. Reversible. Lasts lifetime—no cogs or wheels to break. Sent on 10 days free trial. Money back guarantee. Write for free descriptive book, testimonials, prices, terms, etc.

Owensboro Ditcher & Grader Co., Inc.
103 Allen St., Owensboro, Ky.

Quickly Pays for Itself

Besides greatly increasing your crop and land value, you can make big money hiring it out when your team and hired help might otherwise be idle. Pays for itself in 1 to 3 days. Cuts ditch 2 ft. deep and 1200 yards long in 1 day.

Owensboro Ditcher & Grader Co., Owensboro, Ky.
Send free Descriptive Booklet, Prices, Terms, Etc.

Name.....
Post Office.....
R. F. D.....State..... 103



THE TENT-COT
OPEN AND FOLDED

above the ground under a storm-proof covering that enables you to use the Tent-Cot every night in the year, and all the discomforts and dangers of sleeping out. You sleep 17 inches and windows are fitted with both storm and mosquito curtains that can be raised and lowered at will of the occupant. For anyone afflicted with lung trouble there is nothing equals the Tent-Cot. It also has a splendid appearance and can be set up on your porch, lawn or roof and taken down when not in use. Can be set up in a space 30x78 inches and only requires about 30 seconds to operate. It is ideal for hunters, fishers and campers as it eliminates all the annoyance of "making camp." With a Tent-Cot you carry your camp with you under your arm and sleep safe and sound any place.

SPECIFICATIONS—Length of cot open, 6 ft. 5 in.; width of cot, one person, 28 in.; width of cot, two persons, 44 in.; height of bed from ground, 17 in.; height of tent over cot, 32 in.; size of cot folded, for 1 person, 28x36; size of cot folded, for 2 persons, 44x36; weight, 1 person, 29 lbs.; weight, 2 persons, 44 lbs.; frame is of hard maple, painted green; covering is of heavy waterproof canvas in colors. **PRICE**—Tent-Cot 28 in. wide, open 1 side, \$9.00; Tent-Cot 28 in. wide, open 2 sides, \$9.50; Tent-Cot 44 in. wide, open 2 sides, \$11.50.

YOU SHOULD USE The Enterprise Tent-Cot

"The Perfect Outdoor Bed" For Porch, Lawn or Camp

Manufactured Exclusively by

ENTERPRISE BED COMPANY, HAMMOND, INDIANA

When writing to advertisers please mention The Irrigation Age.

Kansas

J. L. Hibarger, tenant on the I. T. Steele farm, near Wichita, Kan., has installed a pumping plant to irrigate the entire 160 acres. The water is pumped by electricity and the plant has a capacity of 18,000 gallons an hour. The wells are about fifty feet deep. Ninety acres of land is in alfalfa and seventy acres in garden truck. It will cost about \$2 per acre for each irrigation.

The Pawnee County (Kan.) Irrigating Company, composed of farmers in that county, has practically completed the construction of eleven miles of irrigating ditches.

The Great Plains Co-operative Experimental Association met recently at Hays, Kan. More than 100 experimenters in irrigation work attended.

Washington

Work has been started on a power plant to pump water to irrigate about 1,100 acres adjacent to Omak, Wash.

CORN HARVESTER with binder attachment, cuts and throws in piles on harvester or winrows. Man and horse cut and shock equal to a corn binder. Sold in every state. Price only \$20.00 with fodder binder. J. D. Borne, Haswell, Colo., writes: "Your corn harvester is all you claim for it; cut, tied and shocked 65 acres milo, cane and corn last year." Testimonials and catalog free, showing pictures of harvester. Address **PROCESS MFG. CO., Salina, Kansas.**

BINDER ATTACHMENT with corn harvester cuts and throws in piles on harvester or in winrows. Man and horse cut and shock equal with a corn binder. Sold in every state. Price only \$20.00 with fodder binder. J. D. Borne, Haswell, Colo., writes: "Your corn harvester is all you claim for it; cut, tied and shocked 65 acres milo, cane and corn last year." Testimonials and catalog free, showing pictures of harvester. Address **PROCESS MANUFACTURING CO., Salina, Kansas.**

Wyoming

Baron Hooft, representing Holland capital, recently completed an inspection of the Oregon Basin project near Cody, Wyoming. Reports from Cody state that the Baron let it be known that he and his fellow Hollanders would probably agree to finance the construction of the project.

H. P. Krehbiel, president of the colonization committee of the western conference of the Mennonite church, has closed a three years' option on 8,000 acres of irrigable land near Wheatland, Wyo., to be used for colonization purposes by the Mennonite church. The purpose of this move is to concentrate the emigration of younger members of the church who

are being compelled to look for land elsewhere than in the present colonies on account of the high price of land, and the difficulty of purchasing any tract at reasonable prices.

Utah

The Utah Lake & Irrigation Company is preparing to enlarge its plant near Saratoga, Utah. The company's canals now furnish water on both sides of the Salt Lake Valley, but demands for water necessitate arrangements to increase the supply.

Arizona

The Desert Irrigation Pump Company of Globe, Ariz., has been incorporated with capital stock of \$200,000. (Continued on page 311)

BILL AND CHARGE **GENERAL CORRESPONDENCE** **CARDS TAGS LABELS ETC.**



Price **\$100**

The Royal
does the work of several typewriters in one—it writes, types cards and bills! All this without a dollar for "special" attachments. The one machine does it all.

Write Direct for our new Brochure, "BETTER SERVICE," and a beautiful Color-Photograph of the New Royal Master-Model 10.

ROYAL TYPEWRITER CO., Inc.
Royal Typewriter Building Broadway, N. Y.



Get Your Canadian Home from the Canadian Pacific

B

CANADIAN PACIFIC

BUY an irrigated farm where you have insurance against drought and where you have just the moisture you need when you need it. You know the value of controlling the watering of your crops. In sunny Southern Alberta you are master of the moisture. The Canadian Pacific's great Irrigation Works insure your yield whenever rainfall is insufficient. Irrigation is not always a necessity—but it is yours at command. It means dependable crops, and wonderful crops every year. The Eastern section of the Canadian Pacific Irrigation Block East of Calgary is now open. Virgin soil of famous fertility—alfalfa, timothy and other fodders—raises all the grain and root crops, fine climate—great cattle country—good markets—unexcelled transportation.

We want the alert enterprising farmers who see this magnificent opportunity. So we make the most liberal terms. Take 20 years to pay. Call on us for long time loan of \$2000 for farm improvements if you want it. Investigate now. This block will soon be the most densely populated and intensely cultivated district in the west.

You Can Have 20 Years to Pay

We will sell you this rich, irrigated, Canadian land for \$35 to \$75 an acre. You need pay only one-twentieth down. Think of it—only one-twentieth down, and then the balance in 19 equal annual payments. Long before your final payment comes due, your farm will have paid for itself over and over again. Many good farmers in Western Canada have paid for their farms with one crop. Here are some of the startling features of the most remarkable land offer you have ever read:

We Lend You \$2,000 for Farm Improvements This offer of a loan up to \$2,000 is for farm development only, with no other security than the land itself, and shows our confidence in the fertility of the soil and in your ability to make it produce prosperity for you and traffic for our lines. This loan will help you in providing buildings, fencing, sinking well and breaking, and you are given twenty years in which to fully repay this loan. While enjoying the use of this money, you pay interest at only 6%.

Advance Live Stock on Loan Basis The Company, in case of the approved land purchaser who is in a position and has the ability to take care of his stock, will advance cattle, sheep and hogs up to the value of \$1,000 on the basis of the settler's note with interest at eight per cent, to enable him to develop more rapidly, on the right basis of mixed farming.

Farm Made Ready by Experts if Desired If you want a place already established, select one which our Department of Agricultural Experts has developed. On our improved farms, houses and other buildings are up, well in dug, farm fenced, fields cultivated and in crop. All waiting for those who want an immediate start and quick results—all planned and completed by men who know—our own agricultural experts. Take twenty years to pay if you want to. We give free service—expert service—the valuable assistance of great demonstration farms, in charge of agricultural specialists employed by the Canadian Pacific for its own farms. This service is yours—free.

Water Rental Will Not Exceed \$1.25 per Acre Each water agreement will have approval of Dominion Government. Lands are located on or near established lines of railway. First payment of irrigated land is 1-20th of purchase price. At end of first year no payment is due on principal or water rental, only payment of interest is required. At end of second year, no payment of principal is required, but purchaser will be required to pay interest and water rental. At end of third year, the second payment of principal, interest and water rental will be required.

Here is where your opportunity lies. Don't delay. Mail coupon here at once. Best land will be taken first—time is precious to you. Write today.

R. O. THORNTON, Colonization Agent
Canadian Pacific Railway
Colonization Department
112 West Adams St., Chicago, Illinois

P. C. THORNTON, Colonization Agent.
Canadian Pacific Railway, Colonization Department, 112 W. Adams St., Chicago

Please send me your book of Information on Irrigation Farming in Sunny Alberta.

Name

Address

Town

State

PLAN AGRICULTURAL COLLEGE

(Continued from page 301.)

10 acres of sage brush and have had it carefully surveyed and ditches laid out. Then came the question of leveling, but this is work in which the farmers are well versed, and they accordingly organized and took hold of the proposition.

Three divisions were laid out and W. A. Harmon was placed in charge of one, W. H. Williams of another, and C. W. Renfro of the third. The farmers were liberal in coming forward with their

teams and implements, while the women of the community prepared a bountiful dinner.

When the balance of the 40 acres is turned over to the district, the people of the district propose to have an agricultural college established. They also hope that the government will make an appropriation for this purpose.

Fulton H. Sears, member of the Executive Committee of the National Federation of Water Users' Associations, H. C. Taylor, L. J. Clark and F. E. Buerer composed the committee in charge.

IRRIGATION NOTES

(Continued from page 310)

L. L. Henry and John R. Williams are among the incorporators. The concern will manufacture pumps and other irrigation supplies.

The Reclamation Service is asking for proposals for the construction of the Wallace Feeder Canal on the Salt River irrigation project, Arizona. The work, which is located near Phoenix, involves the excavation of approximately 68,000 cubic yards of material; 275 cubic yards of plain reinforced concrete in structures; 80 square yards of grouted paving; laying 160 linear feet of 18-inch concrete pipe, and the erection of four bridges, involving the use of 16,480 feet B. M. of lumber and 9,600 pounds of steel and iron. Bids will be opened after 2 p. m., August 24, at Phoenix, Arizona.

California

The California state irrigation board has approved a plan to issue \$400,000 in bonds for improvements and extensions in the Oakdale Irrigation district. The district is already bonded for \$2,000,000. The water rights of the system are estimated to be worth \$1,400,000 and the land within the district is estimated to be worth \$5,192,000.

Farmers on the west side of the Fall river in Shasta county, Cal., have formed an irrigation district to water 5,000 acres. Engineers estimate the plant can be installed for \$15,000 or about \$3 an acre. It is planned to install a pumping plant, reservoir and ditches. Electric power will be used for pumping water. The construction of a new power plant in this vicinity will give the district ample power for pumping at reasonable rates.

Because of the increased demand for fruit and dairy lands, it is reported that extra preparations are being made to place water on the two extensions of the present watered area of the Perris Irrigated Farms near Los Angeles, Cal. Wells have been bored for pumping plant No. 3, and the tunnel connecting the three areas is now under construction. Four wells for a fourth pumping plant are also completed, and will be put in operation next fall.

The directors of the Turlock irrigation district in California have levied

Alfalfa for profit

"One-Half the Alfalfa Seed Sown is Wasted Every Year"

This statement has been made by many recognized Alfalfa experts—men who know what they are talking about.

They say that they secured better stands of Alfalfa with 10 pounds of seed, drilled with the Superior Special Alfalfa and Grass Seed Drill than with 20 pounds of seed sown broadcast.



THE SUPERIOR 20 X 4 SPECIAL ALFALFA AND GRASS SEED DRILL

There are 20 discs on this machine set 4 inches apart. The construction is such that all the seed is sown at an even depth, and an equal amount of seed in every furrow.

None of the seed is wasted, when drilled in the ground with a Superior Alfalfa and Grass Seed Drill

REJUVENATES OLD ALFALFA FIELDS

RENEWS OLD PASTURES AND MEADOWS

PRODUCES BEST STANDS OF MILLET

INCREASES YIELDS OF WINTER WHEAT BY

CULTIVATION and SOWS CLOVER AT SAME TIME

Saves More Than Two Dollars an Acre on Seed Alone

Send for Superior Alfalfa Drill folder and read the **strong warranty**

Go to your local dealer and ask to see the Superior Special Alfalfa and Grass Seed Drill. If he will not supply your needs, we will.

THE AMERICAN SEEDING-MACHINE CO., Inc.
SPRINGFIELD, OHIO

FREE—A copy of "Boyd's Farmers' Alfalfa Guide," price 10c, will be mailed free to any reader of Irrigation Age who will write for the book and mention Irrigation Age.

an emergency tax to raise \$40,000, the amount necessary to cover the cost of repairing the damage to the irrigation system caused by the break in the outlet gate of the Davis reservoir and the wrecking of a mile and a half of the main canal. A new canal will be built to take the place of the wrecked portion.

The South San Joaquin (Cal.) Irrigation District has voted an assessment of \$140,000 to complete its irrigation system.

Reclamation plans for the improvement of 30,000 acres in California Irrigation District 999 (Netherlands), at a cost of \$2,134,000, have been approved. The work planned will reclaim approximately 30,000 acres west of Lisbon, Merritt and Sutter, the last of the unclaimed land in the Yolo basin that touches the Sacramento river. About 82 per cent of the land is the property of the Netherlands Farms Company, which company has already expended \$350,000 on levees. Some of the levees to be built will be among the largest in California.

Irrigation by means of pumping is proving a success around Wheatland, Yuba county, Cal. Several of the farmers have obtained abundant water and others are planning to sink wells. A. Reichers has a pump that throws 800 gallons per minute and his supply of water seems to be unlimited. A. G. Oakly has a pump that throws 1,000 gallons a minute and his well has shown no signs of a decrease under critical tests.

The Orchard Heights Land Company of Beaumont, Cal., have completed their wells and pipe line and are now filling their three and one-half million gallon reservoir; a capacity sufficient to supply their tract of eleven hundred acres, which is now subdivided into lots of ten acres each. Water will be piped under pressure to the high corner of every ten-acre piece.

ONE WAY TO STRETCH WIRE.

Here is an easy method of tightening barb wire if you haven't a wire tightener. All that is required is a common log chain, a few feet of smooth wire, and your wagon. To tighten wire by this method, drive your wagon so that the rear wheels are a few feet beyond the corner post to which you wish to fasten the wire. Fasten the chain to the wire you wish tightened by running the smooth wire through the links of the chain, and then wrapping around the barb wire. Then run the large link at the other end of the chain between two spokes of the hind wheel, next to the hub. Turn the large link over after passing between the spokes, then all you have to do to stretch the wire is to turn the wheel forward. When the wire has become tight enough, fasten securely

to the post, turn the wheel back, unwrap the smooth wire from the tight-ened strand, and proceed with the next.

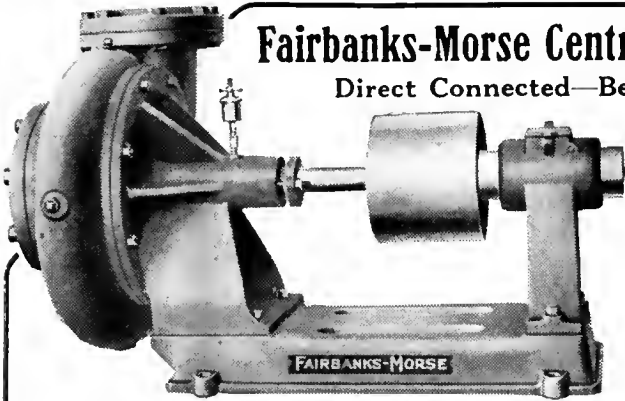

Fairbanks-Morse Centrifugal Pumps
Direct Connected—Belt Driven

- Oil Engines
- Oil Tractors
- Portable Engines
- Electric Motors

Write for Catalog 27N-650

Chicago	Kansas City	St. Louis
St. Paul	Denver	Omaha
Spokane	Portland	Los Angeles
Salt Lake City	Seattle	Atlanta

Fairbanks, Morse & Co.

Save high as 60% On Lumber and Millwork

Don't Pay Profits to Five Middlemen That's what you do when you buy of your local lumber dealer. Buy of us and you buy of the producer. We are one of the biggest independent lumber companies in America; own thousands upon thousands of acres of choice Western timber. Do our own cutting, logging, railroading; operate six huge mills, where we produce daily 20 to 30 carloads of lumber and millwork.

Buy Direct From Our Six Mills. Besides up to 60% saving in price we offer you better materials, efficient delivery service and guaranteed satisfaction.

Immediate Shipments. We carry immense stocks. Miles and miles of lumber piles, and warehouses groaning with millwork, await your order. Make all shipments within 24 to 48 hours.

Better Quality Guaranteed. Our timber tracts are in the famous Puget Sound region. Noted for big trees. Our lumber is straight, free from sap and knots. Exceedingly durable.

Send Carpenter's List for Quick Prices Don't pay five profits for your lumber. Send your carpenter's list of lumber for delivered, freight-paid price. No extras guaranteed. We ship everything for building complete—lumber sash, doors, shingles, millwork, hardware and paint. We have doubled our estimating force to give **quick service** to everybody.

BUY A SEATTLE SILO DIRECT FROM MAKER

No wood stands silo service better than fir. We use Douglas Fir, from giant trees, straight-grained tough, long-lasting. Seattle Silos have quick detachable swinging doors. Door bars form strong ladder from which hoops are tightened. Write for special folder today and first farmer-in-a-town offer.

HEWITT-LEA-FUNCK CO.
471 CRARY BLDG., SEATTLE, WASH.



GET THIS MONEY-SAVING PLAN BOOK

If you haven't decided on your plan, you'll find just what you want in this book. It's prepared by practical people and packed full of sensible, full-value plans. Over 100 good plans in this book. Costs you 10 cents—worth a thousand times that.

Get Any Plan in This Book for \$2.00

For \$2 you can get complete blue prints, specifications and guaranteed estimate, covering complete materials of any plan in the book.

Send the Coupons

HEWITT-LEA-FUNCK CO.,
471 Crary Bldg., Seattle, Wash

Kindly send the following, quoting prices delivered, my station.

Be Sure to Write Plainly

() Catalog Lumber and Millwork
 () Prize Plan Book, 10c
 () Special Barn Folder (4c)
 () Special Silo Folder

Name.....
 Town.....State.....
 I am planning to build as follows.....

SOW A COVER CROP

(Continued from page 306.)

clover should be cut and left on the ground, while the second crop should be plowed under when in blossom. The fruit growers should bear in mind that the orchard is not a hay field and that very little good will result from the use of cover crops if the crop is cut for hay. Besides, there is danger from poisoning if the orchard is sprayed with arsenical poisons. Alfalfa is not adapted to orchards, as it is difficult to eradicate and no orchard should be left permanently in sod.

The question is sometimes asked: Why cannot weeds be used as cover crops? The objection to weeds is mostly from the fact that they do not mature at the same time and in order to get the best results they have to be cut too early and even then some species of plants will have already matured their seeds which afterward may be difficult to eradicate. Field peas is another excellent crop for the orchard. Winter rye sown in August and plowed under the following May is a crop that should be used in many orchards. The point that the writer wishes to emphasize is that the use of a cover crop is not primarily to increase the fertility of the land, but to add vegetable matter.

SILOS ON IRRIGATED FARMS

(Continued from page 298.)

varying conditions. We find that among our most successful corn growers some plant one way and some the other. Under the drill plan an earlier

maturity will follow when the plants are not too thick in the drill. Thinning to 10 to 12 inches is recommended with rows not closer than 30 inches apart. Under the other plan the hills may be 36 inches apart and be thinned to three good stalks.

"It has been demonstrated that the cutting of clover or some legume into the silo with the corn improves the feeding value of the ensilage, by giving the feed nutrients a better balance, also clover containing considerable timothy or some other grass gives a better quality of silage than will straight clover, owing to the fact that clover is deficient in sugar. By mixture of clover with such crops as corn, rye, wheat, timothy and the like, all of which are high in sugar, the entire mixture will be well preserved and palatable. The legumes being low in sugar do not have enough to prevent the fermentation of their high protein content, which results in the objectionable smell of legume silage.

"It is entirely practical in Western Washington to have a crop of rye, wheat or barley just entering the dough stage at the time when clover is first ready to cut and to cut the same into the silo with the clover, in the proportion of one ton of rye, wheat, etc., to two tons of clover or alfalfa. Some legume crops may also be seeded for the purpose of being cut into the silo with the corn crop and thus increase the feeding value of the corn silage.

"The following crop mixtures for silage may be recommended: Fall seeded rye and vetch, corn and the third crop of clover or fourth crop of alfalfa, corn and oats and vetch, barley and oats and vetch, clover and mesquite or timothy or rye grass or



THINK what it means to you! To have at your service—day and night if desired—the combined power of 30 to 35 horses and 10 to 15 men—ready at a moment's notice to plow, disc, harrow, seed, harvest, build roads, irrigate, thresh and do numerous other power jobs, all at the minimum expense for fuel and maintenance. That's what you get when you buy a time-tried and time-proven

**AULTMAN-TAYLOR 30-60
GAS TRACTOR**

They're built with the complete knowledge of the requirements of a tractor of the first quality. They're built right here in our own shop, under our own supervision. We know they're right and we stand back of every tractor. The Aultman-Taylor 30-60 burns either gasoline, kerosene or

distillate with unequalled economy. The Aultman-Taylor 30-60 is not an experiment. Their real worth has been demonstrated on thousands of farms throughout North America. Let us explain to you why you should own and operate one of these money-making and labor-saving tractors. **WRITE FOR CATALOG AND FURTHER INFORMATION TODAY.**

We are also builders of the Famous "New Century" Separator, "Matchless" Clover and Alfalfa Huller, Steam Traction and Portable Engines, Bean Threshers and Saw Mills. Catalog free upon request.

THE AULTMAN & TAYLOR MACHINERY COMPANY

MANSFIELD, OHIO.

BRANCHES: Minneapolis, Minn.
Wichita, Kan.Portland, Ore.
Decatur, Ill.

Lincoln, Nebr.

Kansas City, Mo.
Indianapolis, Ind.

orchard grass, clover, oats and vetch, wheat and vetch, oats and vetch or peas, straw and clover, or alfalfa in the proportion of one to four, have been used with good results. The better practice would be to cut them into the silo together as well mixed as possible, rather than cutting in alternate layers.

"When the crops are approaching maturity they are ready to be cut for the silo. Corn should be cut well along in the glazing stage, the cereals in the dough stage, and the meadow grasses and clover well in bloom. Peas and vetch are ready when the first grains begin to harden."

We planned this House and Saved Robert Zehntner \$375.00

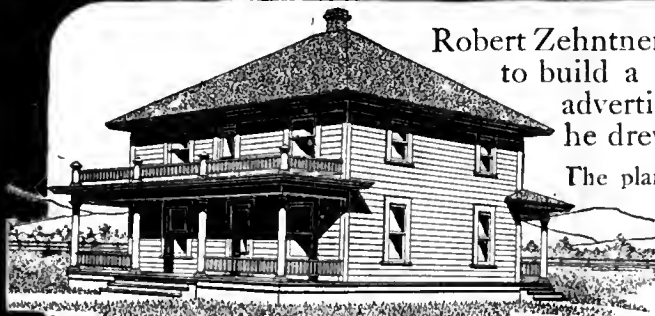

Robert Zehntner of White Sulphur Springs, Mont., wanted to build a home and answered a Hewitt-Lea-Funck advertisement. On the back of our question blank he drew a rough sketch of what he had in mind.

The plans you see at the left, and afterward, the house pictured, was the result. When it came to ordering the lumber, the local yard man asked for the chance to bid and got it, but he didn't get the business. Mr. Zehntner's letter to us tells why. "I unloaded the car," he says, "and found the material fine.

The carpenters are well pleased, the finish being much better than I could have gotten here. The best local

Home Designed for Robert Zehntner, White Sulphur Springs, Mont.

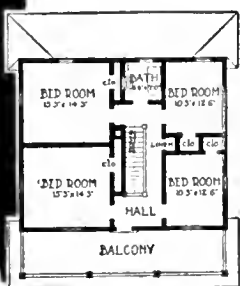
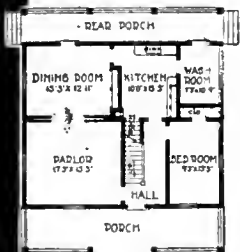

bid on the material was \$375 higher than yours and lacked quite a bit of being complete."

Complete plans \$2

If you like this house, you can get the complete plans, specifications, guaranteed estimate of prices on lumber, millwork, hardware, paint and heating plant delivered at your station—all for \$2.

Our guaranteed price means *no extras*. We guarantee absolutely to provide sufficient materials to build the house, and guarantee grades equal or better, than required by standard rulings. Getting the plans does not obligate buying materials of us, if you do, you get your \$2 back. If this plan doesn't suit,

Send coupon for Prize Plan Book — 100 homes—all sizes—all prices

It's the *most practical* book of its kind ever published. Every plan is a good one—a lot of them will please you—one of them will doubtless *just suit you*. Our architects worked over a year on this book. It cost us \$30,000 to get it out. Books not nearly so good are sold at \$6 to \$2.00. Yet, ten cents, merely to cover postage, will bring you this valuable book, if you use the coupon.

middleman and sell you direct at the *mill price*—a price that's way-down low, because the raw materials come from forests under our control. Our lumber is straight-grained, free from sap and large knots, doesn't warp or shrink. Makes a beautiful job.

Special plans at small cost

If none of the plans in this book quite suit you, and you have your own ideas of what you want, you'll find it easy to show us what your ideas are, just as Robert Zehntner did. We have a Plan Sheet for this purpose, that makes it simple. Give us a rough sketch of what you have in mind—and we will complete the plan for you.

Send for estimate—no obligation

Send us your carpenter's bill of materials for our prices, if you can. Do it even if you aren't ready to build. No charge or obligation. If we can be of any help to you in planning your building be sure to let us know. Our special plan sheet makes it easy to give us your ideas—ask for it. At any rate, mail the coupon today for catalog and general price list.

Save as high as 60% on lumber—buy direct from the producer

Too many middlemen come between the mill and the lumber dealer—that's why his prices are so high. We cut out every single

Silos at up to 60% Saving

Here's the biggest silo value you can get. *Buy direct*, at the mill price, a Seattle Silo of one-piece staves from durable Puget Sound fir. **Seattle Silos** have patented swinging doors. Door bars form strong ladder from which hoops are easily tightened.

Send the coupon for folder on Seattle Silos. Get our special one-farmer-in-a-town-offer. Write today.

HEWITT-LEA-FUNCK COMPANY
471 Crary Building Seattle, Wash.

Hewitt-Lea-Funck Company
471 Crary Bldg., Seattle, Wash.

(Be sure to write plainly and if possible send bill of materials for estimate)

Please send me the following:

- Book of Plans (for which 10c in stamps or coin is enclosed).
- Catalog and General Price List of Lumber and Millwork, Free.
- Special Silo Folder, Free.
- Special Plan Sheet, Free.

Name _____

R. F. D. or Street No. _____

Post Office _____ State _____

Business _____

"INGECO" Oil Engines

The engines that give you abundant power at low fuel cost

Before you decide on what engine to buy, look carefully into the advantages the "INGECO" line offers. Note the *strong, sturdy construction* of "INGECO" Oil Engines (neither too heavy nor too light)—their *simplicity* (no superfluous parts or complicated

mechanism to get out of order and cause trouble)—their *safety* (no exposed flame)—their *ease of operation* (quick starting, smooth running.) And, above all, fix this fact in your mind: "INGECO" Engines are the most economical engines you can use, for they work perfectly on kerosene, distillates and oil at about one-half the cost of gasoline.

Whatever your power requirements, there's an "INGECO" to meet them. "INGECO" Oil Engines are made in all sizes from 1½ to 350 H. P.—vertical and horizontal, portable, semi-portable and stationary types.

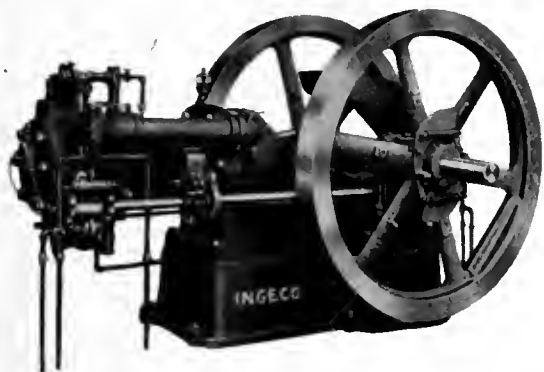

"INGECO" Farm Engines

Thoroughly reliable, internal combustion oil engines of the throttling governor type, air or water cooled. Uniform speed under varying loads. No flame exposed. Absolute safety—perfect combustion—all parts accurate and interchangeable—built for long years of hard service.

We furnish equipment for Irrigation Purposes including Complete Plants, Engine and Pumps to meet all conditions

Tell us what your power needs are and we will be very glad to suggest the engines or outfit which our experience shows to be most practical, quoting prices and terms.

Shall we send you one of our latest catalogs?

If you need a Feed Grinder ask us about the "New Holland"



A LIGHT draft, light weight, big capacity mill that gives splendid results on all kinds of feed. Runs successfully with 1½ to 3 H. P. engine at a big fuel saving. Fully guaranteed. We are general Northwestern Distributors for New Holland Feed Mills and will quote you interesting prices.

INTERNATIONAL GAS ENGINE COMPANY

General Sales Office and Factory

Holthoff Place, Cudahy, Wis. (Suburb of Milwaukee)

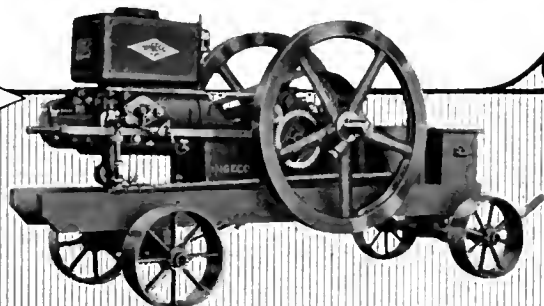



The Passing of an Aristocrat

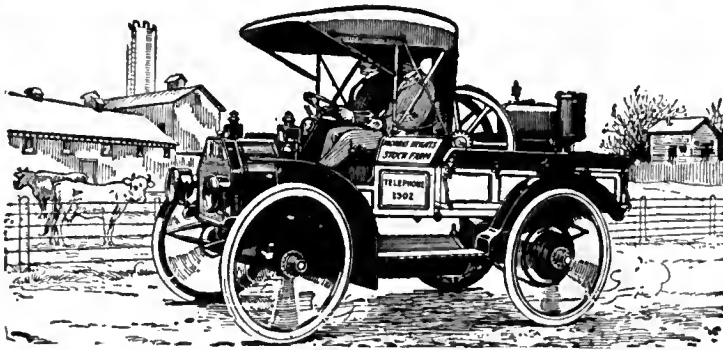

YOUR horses demand much, need much—and get much. For instance—costly stable, rigs and sheds for them; harnesses; hay and oats, and its storage space; time spent each day in the year caring for them, feeding, watering, currying, harnessing, frequent blacksmith, harness, and vehicle repair bills; occasional veterinary bills.

All that an international Motor Truck asks for is a shed, and a small ration of gasoline and oil—that's all. And when it's not working it wants only the shed. For profit and economy buy an

International Motor Truck

You will find that it costs considerably less than horse and wagon keep, it goes four times as fast and as far as the horse, saves you many hours of time, and will run twenty-four hours in a day if necessary. In reliability, strength, and ease of management, it is best.

Solid tires eliminate common tire troubles. The wheels are high enough to give ample road clearance. The simple, sturdy motor has plenty of power. Brakes are powerful. A single lever controls the car.

It will pay you to find out all that an International Motor Truck will do for you. Write for catalogues, facts and figures to the



WESTERN BRANCH HOUSES: Deaver, Col.; Helena, Mont.; Portland, Ore.; Spokane, Wash.; Salt Lake City Utah; San Francisco, Cal.

International Harvester Company of America

Chicago

(Incorporated)

U S A



The School For Your Daughter

TERM OPENS
SEPTEMBER
FIFTEEN

St. Mary-of-the-Woods

COLLEGE
AND
ACADEMY

DEGREES CONFERRED: B. A., B. S., PH. B. STRONG FACULTY

Located four miles west of Terre Haute, Indiana. Large campus, perfect drainage, commodious buildings, steam heat, electric lights, large airy rooms, many with private bath, and spacious halls, libraries and parlors. School plant consists of fourteen modern buildings, artistically grouped and completely equipped. Nothing lacking for convenience or comfort. Combining all the best features of school life with home environment on a country estate of 1,600 acres.

BOATING, HORSEBACK RIDING, SWIMMING, ARCHERY, GOLF and all outdoor athletics for girls under the constant supervision of a graduate of the Sargent School for Physical Education. School course comprises INTERMEDIATE, ACADEMIC and COLLEGIATE departments. Special courses in MUSIC, ART, LANGUAGES, DRAMATIC ART, and DOMESTIC SCIENCE. Information gladly furnished on application. A beautifully illustrated catalogue to be had for the asking. Address

SISTER SUPERIOR, Box 41,

St. Mary-of-the-Woods, Indiana



College Building

Conservatory of Music

Academy Building

When writing to advertisers please mention The Irrigation Age.



Every Great
Irrigation
Project
Involves
the
Building of
Miles of
Roadway

AMERICAN INGOT IRON ARMCO CULVERTS

will permanently care for the intersecting drainage ways, with the least expenditure of time and money.

In the form of corrugated, inverted siphons, they will solve the problem of depressed crossings either for the storm water or for that of the laterals.

This is the *purest* and *most durable* iron on the market.

For full information on American Ingot Iron Culverts, Siphons, Gates, Plates, Sheets, Roofing and Formed Products, write the nearest manufacturer.

Arkansas, Little Rock
Dixie Culvert & Metal Co.

California, Los Angeles
California Corrugated Culvert Co.

California, West Berkeley
California Corrugated Culvert Co.

Colorado, Denver
R. Hardesty Mfg. Co.

Delaware, Clayton
Delaware Metal Culvert Co.

Florida, Jacksonville
Dixie Culvert & Metal Co.

Georgia, Atlanta
Dixie Culvert & Metal Co.

Illinois, Bloomington
Illinois Corrugated Metal Co.

Indiana, Crawfordsville
W. Q. O'Neal Co.

Iowa, Des Moines
Iowa Pure Iron Culvert Co.

Iowa, Independence
Independence Corr. Cul. Co.

Kansas, Topeka
The Road Sup. & Metal Co.

Kentucky, Louisville
Kentucky Culvert Co.

Louisiana, New Orleans
Dixie Culvert & Metal Co.

Maryland, Havre de Grace
J. N. Spencer.

Massachusetts, Palmer
New England Metal Cul. Co.

Michigan, Bark River
Bark River Bridge & Cul. Co.

Michigan, Lansing
Michigan Bridge & Pipe Co.

Minnesota, Minneapolis
Lyle Corrugated Cul. Co.

Minnesota, Lyle
Lyle Corrugated Cul. Co.

Missouri, Moberly
Corrugated Culvert Co.

Montana, Missoula
Montana Culvert Co.

Nebraska, Lincoln
Lee-Arnett Co.

Nebraska, Wahoo
Nebraska Cul. & Mfg. Co.

Nevada, Reno
Nevada Metal Mfg. Co.

New Hampshire, Nashua
North-East Metal Cul. Co.

New Jersey, Flemington
Pennsylvania Metal Cul. Co.

New York, Auburn
Pennsylvania Metal Cul. Co.

North Carolina, Greensboro
Dixie Culvert & Metal Co.

North Dakota, Wahpeton
Northwestern Sheet & Iron Works.

Ohio, Middletown
The Ohio Corrugated Cul. Co.

Oklahoma, Shawnee
Dixie Culvert & Metal Co.

Oregon, Portland
Coast Culvert & Flume Co.

Pennsylvania, Warren
Pennsylvania Metal Cul. Co.

South Dakota, Sioux Falls
Sioux Falls Metal Cul. Co.

Tennessee, Nashville
Tennessee Metal Culvert Co.

Texas, Dallas
American Rolling Mill Co.

Texas, El Paso
Atlas Metal Works.

Texas, El Paso
Western Metal Mfg. Co.

Texas, Houston
Lone Star Culvert Co.

Utah, Woods Cross
Utah Culvert Co.

Virginia, Roanoke
Virginia Metal & Cul. Co.

Washington, Spokane
Spokane Corrugated Culvert & Tank Co.

Wisconsin, Eau Claire
Bark River Bridge & Cul. Co.

DEPENDABLE POWER FOR IRRIGATION

When you buy an engine for irrigation pumping, look first to the quality. Dependability is the all-important consideration. You can't afford to risk failure of your pumping outfit at the critical time. It will cost you less in the long run to pay what a good engine is worth.

**Lauson and
Kerosene**



**"Frost King"
Engines**

are particularly well adapted for irrigation pumping because of their absolute reliability. "Lauson" Engines are built up to a standard, not down to a price; have more drop forged and case hardened parts than any other engine on the market, and will run as true after five years' use as when new.

By using a carburetor of special design ordinary kerosene distillate is used, securing the full rated horse power as with gasoline. The cold process type of carburetor is used because it is cleaner and more efficient than the oil heating system used by others.

For continuous heavy work there is no engine on the market today that equals the Lauson. We'll be glad to submit proof without obligating you in any way.

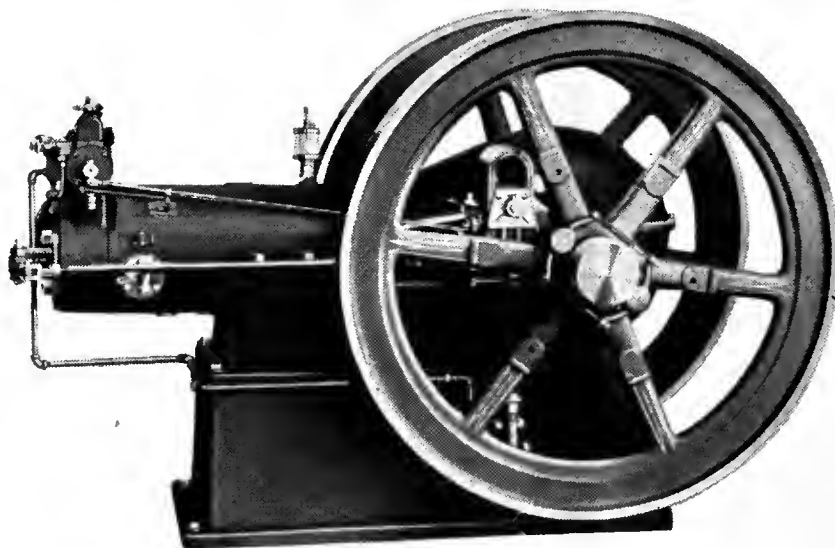

**Built in Sizes
from
6 to 50 H. P.,
Horizontal Portable or
Stationary Types.**

**80 to 100 H. P.
Multiple Cylinder
Vertical Type.**

**The
John Lauson Mfg. Co.
68 MONROE STREET, NEW HOLSTEIN, WIS.**

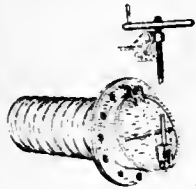

Hinge Gate



Lennon Flume

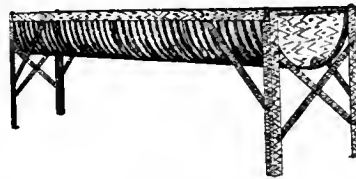

Water Trough



Simplex Stack Trough

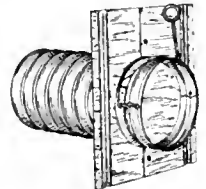

4-C Gate



Slide Gate

IRRIGATION GATES

For use in connection with **RUST-RESISTING AMERICAN INGOT IRON CORRUGATED PIPE.**

All stamped with the approval of experienced Irrigators.

The cuts show only part of our line.

Write us your requirements.

Consult our Engineers.

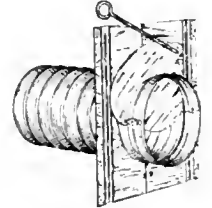

4-C Gate

CALIFORNIA CORRUGATED CULVERT CO.

435 Leroy St., Los Angeles, Calif.

424 Parker St., Berkeley Calif.

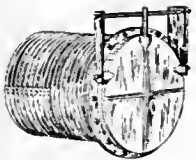

Automatic Tide Gate

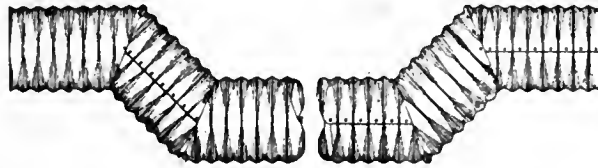

Inverted Siphon

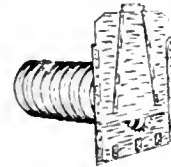

Berkeley Gate

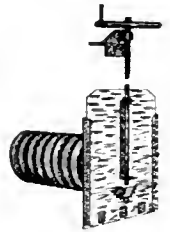

With Screw Attachment

Finish This Story

A WORKMAN in an IHC wagon factory was explaining the various stages of wagon construction to an interested visitor. He picked up two pieces of long leaf yellow pine, which to all appearances were sawed from the same board, and asked the visitor to notice the difference in the weight of the two pieces. The lighter piece, he explained, was kiln-dried. The heavier piece was air-dried and more thoroughly seasoned. It had retained the resinous sap which adds strength and toughness, while in the kiln-dried piece of lumber this sap had been drawn out by the too rapid application of heat.

Every Stick of Lumber Used in IHC Wagons is Carefully Selected, Air-Dried Stock

Here was something to think about. The visitor asked for a test as to the relative strength of the two pieces of wood. The air-dried piece held up under nearly double the weight under which the kiln-dried piece of lumber broke. The workman explained how the comparative life of air-dried and kiln-dried lumber has about as great a difference.

To the eye there was no difference between these two pieces of lumber, but when put to



the test there was a vast difference. So it is throughout the construction of IHC wagons—Weber, Columbus, New Bettendorf, Steel King. They are built for real strength, light draft, and satisfactory service.

After seeing the care used in the construction of every part of an IHC wagon, the visitor asked: "Why don't you let people know of the great care used in selecting material and in constructing IHC wagons?"

This is what we have been trying to do, but we cannot tell it all in one short advertisement.

Weber and Columbus wagons have wood gears. Steel King and New Bettendorf have steel gears. IHC local dealers handle the wagons best suited to your work. See them for literature and full information, or, write the nearest branch house.

WESTERN BRANCH HOUSES: Denver, Col.; Helena, Mont.; Portland, Ore.; Spokane, Wash.; Salt Lake City, Utah; San Francisco, Cal.

International Harvester Company of America

(Incorporated) Chicago U S A



Irrigators Cannot Afford to Buy Other Artesian Pumps

THE DEANE OF HOLYOKE "GLEDORA" Triple-Plunger Deep-Well Pump

Trade-Mark

New
Style
Glendora

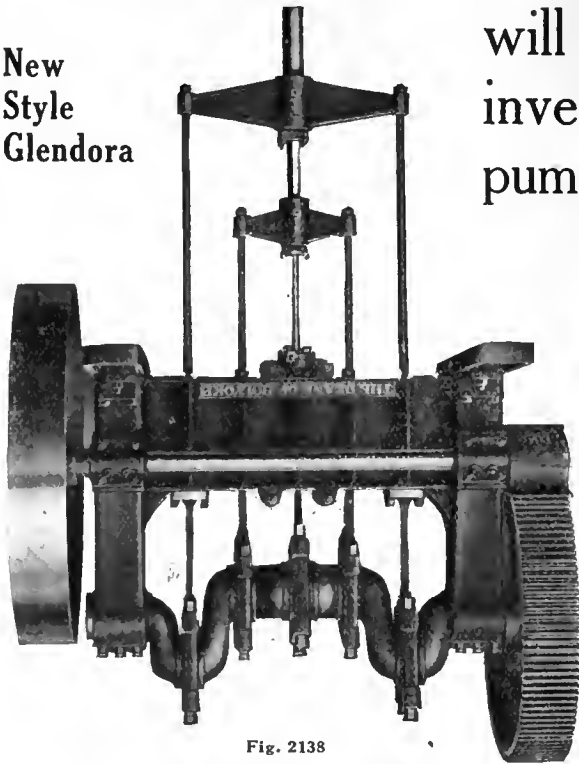

Fig. 2138

Write for Bulletin D300-89.

will prove itself to be the best investment for artesian-well pumping machinery.

Its Design Obtains—

- Constant steady flow.
- Freedom from shocks in the rods.
- Maximum capacity from a given casing.
- Constant load on driving engine or motor.
- Absolutely reliable in operation.
- Gradual transference of load from plunger to plunger.

Workmanship and Materials the Best

Power Pumping Machinery

The Deane Steam Pump Co.

New York Office, 115 Broadway

Works, Holyoke, Mass.

Branch Offices in All Principal Cities

IRRIGATION FROM WELLS



An Arkansas Installation. Layne Patent Screen and Patent Enclosed Line Shaft Centrifugal Pump.

With the twenty-three hundred successful working plants using our system of irrigation, which inoculates and energizes the dormant forces, there is now being produced in previously non-productive districts throughout the United States and in portions of Europe and Asia over eleven million dollars worth of FOOD PRODUCTS ANNUALLY. That our system is not an experiment is forcibly demonstrated by the fact that much of this production is from localities which were arid and barren previous to the introduction of our system.

Write for new catalog.

LAYNE & BOWLER COMPANY

Address nearest office.

The World's Largest Water Development Company

Houston, Texas

Memphis, Tennessee
Welsh, Louisiana

Stuttgart, Arkansas
Plainview, Texas

Jackson, Mississippi



LOW COLONIST FARES

Daily Sept. 24th to Oct. 8th inclusive.

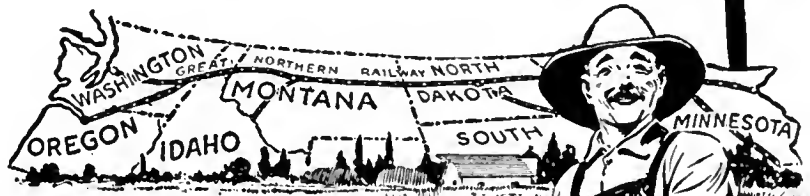

Irrigated Lands in the Zone of Plenty

\$25.00 To Havre, Great Falls, Helena, Butte, Kalispell, Columbia Falls and other Montana Points. From St. Paul, Minneapolis, Duluth, Omaha, and Kansas City, Mo.

\$33.00 FROM CHICAGO

\$30.00 To Spokane, Everett, Bellingham, Vancouver, Seattle, Tacoma, Portland, and other points in the Pacific Northwest. From St. Paul, Minneapolis, Duluth, Omaha and Kansas City, Mo.

\$38.00 FROM CHICAGO

Make a Home for Yourself in the Bigger Crop States

The Great Northern Railway has published a number of well-illustrated books describing opportunities in the States comprising the Zone of Plenty, telling about low-priced irrigated land and the easy terms on which it may be procured. These books are full of solid facts. They contain bona fide letters from men who have made good. The information contained in them may be the means of making you independent for life. They are absolutely free and yours for the asking. Simply fill out the coupon below and mail today.



E. C. LEEDY

General Immigration Agent G. N. Ry.
ST. PAUL, MINN.:

SEND ME YOUR "MAKE GOOD" BOOK ON

TELL ME ABOUT LOW FARES FROM

NAME _____

ADDRESS _____

MONTANA
WASHINGTON
OREGON
NORTH DAKOTA
MINNESOTA

CHECK ONE



WE SHALL be glad to mail anyone who wishes same, our free catalog. We sell our product through dealers and jobbers entirely and solicit inquiries from all dealers. Our goods are well and favorably known. They are standards in the United States Army and several other departments of the government.

Gold Medal Camp Furniture Mfg. Co.
Racine, Wis., U. S. A.

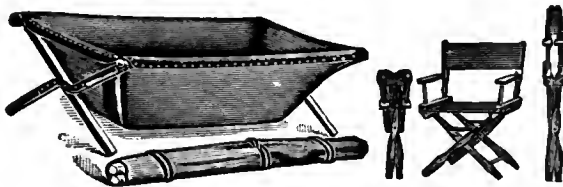

BUCKEYE Power Working Heads

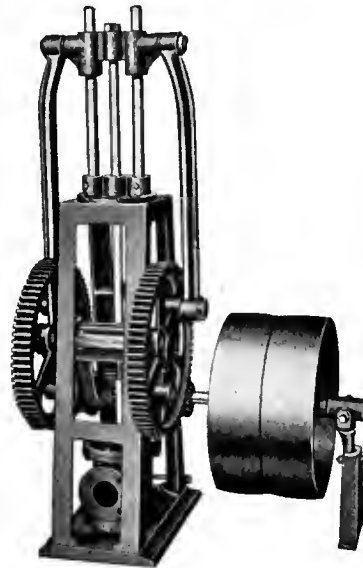

DESIGNED especially for IRRIGATION and pumping large quantities of water from deep wells.

Made in four sizes. Range of stroke, 5 to 24 inches. Size of cylinder can be varied to meet requirements of depth and diameter of well.

The frame is attached to the base of the pump so that it can be hinged back out of the way when the pump rods and valves are being removed.

Write TODAY for Catalogue R

Manufactured by

MAST, FOOS & COMPANY
SPRINGFIELD, OHIO

PAYS FOR ITSELF IN ONE MONTH



and Keeps on Saving You Money at the Same Rate Thereafter.

THE RECLAMATION DITCHER

Cuts Canals and Laterals for less than any other machinery—because it plows the dirt out with *One Continuous Sweeping Motion*.

We guarantee the cost per yard and prove it before you buy.

The J. D. Adams Mfg. Co.
Indianapolis, Ind.



Delays Pay No Dividends. Mail This Coupon Today.

The J. D. Adams Mfg. Co., Indianapolis, Ind.

Below are descriptions of our proposed ditches. What will it cost per cubic yard to make them with the Reclamation Ditcher?

Length	Width in Bottom	Average Depth	Maximum Depth	Minimum Depth	Slope of Sides	Character of Soil

Name _____ Address _____

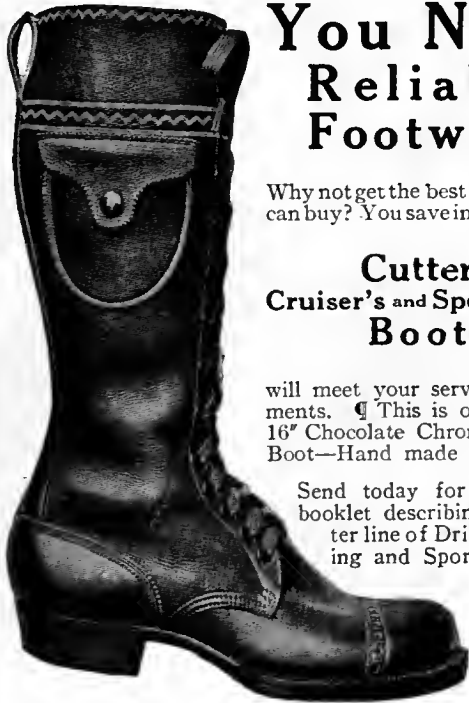

You Need Reliable Footwear

Why not get the best your money can buy? You save in the long run

Cutter's Cruiser's and Sportman's Boots

will meet your service requirements. ¶ This is our No. 106 16" Chocolate Chrome Sporting Boot—Hand made throughout.

Send today for illustrated booklet describing the Cutter line of Driving, Cruising and Sporting Boots.

*It
Will Pay
You*

A. A. Cutter Company

Eau Claire, Wisconsin

SAMSON TURBINE



When the PUMP cannot be direct connected to the turbine shaft, the power is usually transmitted by gears, shafting, etc. On account of the HIGH SPEED of the SAMSON, for a given power, lighter and consequently CHEAPER transmission machinery can be used.

JAMES LEFFEL & CO.

Springfield, Ohio, U. S. A.

316 Lagonda Street



100% Efficient THE LENNON METAL FLUME

delivers, not 50%, 70% or 90% of the water entrusted to it, but

ALL OF IT

The time has arrived when the conservation of water, through the use of watertight conduits, is one of the most important elements of irrigation work. The material of the Lennon Flume is

Armco-American Ingot Iron

with all that that name ensures as to quality and length of service.

Write the Nearest Manufacturer for Full Information on Armco-American Ingot Iron Flumes, Culverts, Tanks, Silos, Roofing and Formed Products

CALIFORNIA—Los Angeles and West Berkeley, California Corrugated Culvert Co.
COLORADO—Colorado Springs, Lennon Metal Flume Co.
COLORADO—Manitou, Lennox Flume Co.
MONTANA—Missoula, Montana Culvert Co.

NEBRASKA—Wahoo, Nebraska Culvert & Mfg. Co.
OHIO—Middletown, American Rolling Mill Co.
OREGON—Portland, Coast Culvert & Flume Co.
TEXAS—El Paso, Western Metal Mfg. Co.
TEXAS—Houston, Lone Star Culvert Co.

SOUTH DAKOTA—Sioux Falls, Sioux Falls Metal Culvert Co.
UTAH—Woods Cross, Utah Culvert Co.
WASHINGTON—Spokane, Spokane Corrugated Culvert & Tank Co.

DEPENDABLE PORTABLE ENGINES



Light enough to be easily moved from place to place, yet durable enough and powerful enough to stand up to the hard, severe grind of irrigation hour after hour and day after day.

HEER ENGINES

are built on the two cylinder opposed principle which eliminates vibration and saves fuel. Burns small amount of cheap oil. Has small repair cost. Total cost of irrigating lower than others.

The **HEER ENGINE**
Company
209 P Street,
Portsmouth,
Ohio.

EDWARDS REVERSIBLE 4 HORSE ROAD GRADER

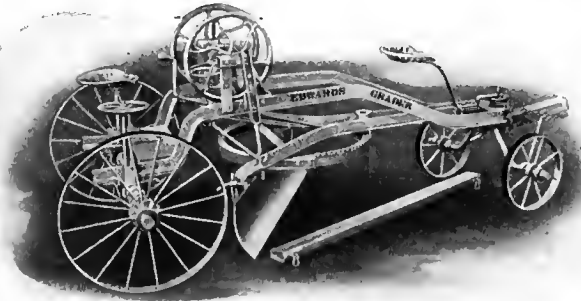

AN UP TO DATE MACHINE FOR BUILDING AND MAINTAINING ROADS

Having a complete line of adjustments it is equally well adapted for making ditches, both for dry land irrigation and rice field work.

I also manufacture THE RURAL ROAD GRADER and IRRIGATION DITCHER, STUMP PULLERS and other machines.

Write for descriptive catalog and prices.

C. D. EDWARDS, Albert Lea, Minn.

Gates and Flumes

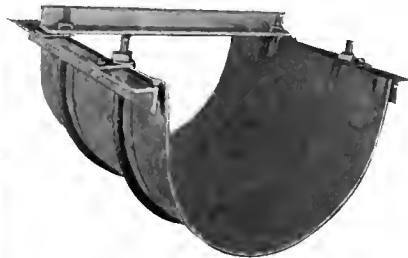
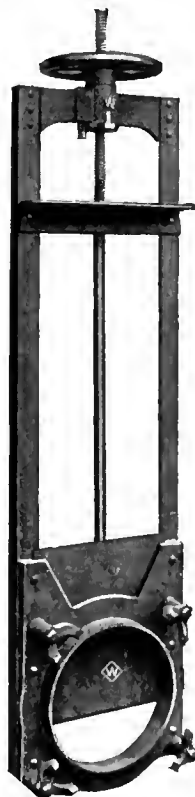

The simplest and quickest erected flume joint on the market, consequently lowest in initial and final cost. Can be fabricated in the field on large jobs, effecting a great saving in freight.

We manufacture:

- Main Headgates
- Lateral Headgates
- Gate Valves
- Metal Flumes
- Steel or Wood Pipe

We carry a complete stock of Wire Mesh and Steel Bars for Concrete reinforcement

Designs and estimates furnished on all irrigation structures and supplies.

Write us your requirements and full information will be sent.

Power Pumping Plants—Reasonable

The **Fitts Machinery & Construction Co.**
Main Office, McPhee Bldg., Denver, Col.

WASH WITH EASE

Here is the finest and most efficient power washer on the market. It does everything except hang up the clothes. Every user praises it. The

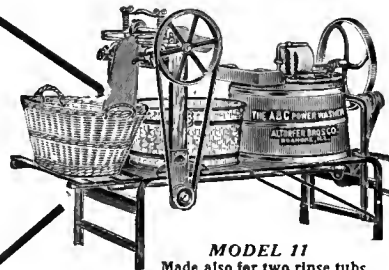

MODEL 11
Made also for two rinse tubs

A.B.C. Power Washer

is the **Original All Steel Adjustable Height Frame Power Washer with Sliding Power Wringer.** Many copy it—none equal it. Insist on the A. B. C. Guaranteed. Write today for 14 days FREE trial and Illustrated Booklet.

ALTORFER BROS. CO.
Dept. 959
ROANOKE, ILL.

Twenty-Ninth Year

THE IRRIGATION AGE

VOL. XXIX

CHICAGO, SEPTEMBER, 1914.

No. 11

THE IRRIGATION AGE

With which is Merged

The National Land and Irrigation Journal

MODERN IRRIGATION

THE IRRIGATION ERA

ARIO AMERICA

THE WATER USERS' BULLETIN

THE DRAINAGE JOURNAL

MID-WEST

THE FARM HERALD

THE IRRIGATOR

D. H. ANDERSON

PUBLISHER,

Published Monthly at 30 No. Dearborn Street,
CHICAGO

Entered as second-class matter October 3, 1897, at the Postoffice at Chicago, Ill., under Act of March 3, 1879.

D. H. ANDERSON, Editor

ANNOUNCEMENT.

The "Primer of Hydraulics" is now ready; Price \$2.50.
If ordered in connection with subscription \$2.00.

Canadian Government May Halt Irrigation Congress

As this editorial is written there is a strong possibility that there will be no session of the Irrigation Congress in Canada next month. If the congress does meet, it will

have its wings closely clipped, and its "International" aspects will be only those furnished by such delegates from the United States as may attend.

As soon as Great Britain opened war on Germany the Canadian government showed a decided inclination to disapprove of the meeting of the congress. It took this position on the grounds that the organization was "international" in character, and therefore it was improper for a colony of a nation at war to entertain it. The Ottawa government also declined to extend official invitations to other nations to send delegates to the congress.

Several prominent Canadians interested in the congress, including J. S. Dennis, head of the Canadian board of control and a prominent Canadian Pacific Railway official, expressed themselves as ready to accept the suggestion of the government and abandon the meeting.

Secretary Arthur Hooker and a number of Cal-

SUBSCRIPTION PRICE

To United States Subscribers, Postage Paid, \$1.00
To Canada and Mexico, 1.50
All Other Foreign Countries, 1.50
In forwarding remittances please do not send checks on local banks. Send either postoffice or express money order or Chicago or New York draft.

Official organ Federation of Tree Growing Clubs of America. D. H. Anderson, Secretary.

The Executive Committee of the National Federation of Water Users' Associations has taken action whereby THE IRRIGATION AGE is created the official organ of this vast organization, representing 1,000,000 persons on the government irrigation projects.

Interesting to Advertisers

It may interest advertisers to know that The Irrigation Age is the only publication in the world having an actual paid in advance circulation among individual irrigators and large irrigation corporations. It is read regularly by all interested in this subject and has readers in all parts of the world. The Irrigation Age is 29 years old and is the pioneer publication of its class in the world.

gary land boomers took the stand that the "international" feature of the congress didn't amount to much any way, and by eliminating everybody except the United States and Canada, the congress could meet without offending the Ottawa government, King George or his ally, Czar Nicholas.

These men opened a series of "diplomatic conversations" with the heads of the Canadian government. The results of these "conversations" have not yet reached us. Because of the strong words in which the Canadian government couched its first "message of disapproval," it is feared by many in Calgary that the congress will finally be ordered abandoned.

The Canadian land boomers are, however, still using the congress as a pretext to try to obtain publicity in American newspapers for their country and to attract United States farmers across the border.

Now, isn't this a pretty mess? A once-great institution of the United States, an organization, which, if it had not fallen into control of sordid, money-seeking men, would still be a power for good and for development in this nation, a congress which has been officered by some of the most

illustrious men of the West, buffeted and cuffed about, treated almost with contempt. And the excuse—a King's government might not like it.

How proud of this mess the American officials of the congress, who sold it out to the Canadian land boomers, must feel!

**Clinch the
Markets
While They
Are Open**

“An army marches on its belly,” is one of the most widely quoted axioms of Napoleon, and also a very truthful one.

“The Irrigated West is insurance for the United States against drouth or any other great disaster,” is a statement to which practically all students of economy will agree.

And now with Europe plunged into the greatest war of all ages, these two statements take on added strength.

This is the hour of opportunity for the irrigated areas. It is not the hour for suddenly building up a fortune by withholding produce from the markets for war-time prices. It is the hour for introducing the produce of the irrigated sections into those parts of the United States and other nations at peace where the markets have been controlled by the war-torn countries. If this introduction is done in a businesslike manner—the produce offered at fair prices and in attractive form—the irrigators will have builded far better than could be any quickly-made fortune through war-time prices.

Markets for all time for their farms and gardens will be secure against all competition, and success and in time a liberal competence for each irrigator and his children will be assured.

The farmers on every project should busy themselves immediately in taking advantage of this remarkable opportunity. On the Federal projects, the Water Users' Associations should be put to work immediately as co-operative marketing associations. On other projects, where there are no marketing associations, steps should be taken immediately to organize. The associations should pick competent men among their fellows or hire experts and begin a whirlwind campaign to place their products in homes where they have never been before and in markets which have formerly looked to Europe for their supplies.

Let's Americanize America right now, so far as farm produce is concerned. If the irrigators of the West take hold, they can do it and do it so well that competition will be stilled forever.

The English, supreme in commercial lines when the war began, realize this better than anyone else, and they are striving with all their might to halt the commercial advance of the United States.

Even now in Canada, the English have already begun a press campaign to encourage their colony to hold for the mother country part of its trade and to discourage so far as possible any enthusiasm among Americans to make inroads upon their vast trade.

The war will make prices higher in some lines of farm produce. A considerable portion of the crops of the United States will be shipped to the warring nations while the struggle goes on. Thereby the farmer will benefit.

The depletion of our home stocks may be just cause for some increase in prices in the United States, thus bringing further benefit to the farmers.

These, however, are only temporary benefits. It is the permanent markets right here at home, in the other countries at peace, which can be now established, that offer the real benefits to the farmers of the nation and particularly to the irrigators, whose greatest need has been markets.

The irrigated West now has also opportunity, as never before, to prove its “insurance” value. By putting every acre to work, the irrigators can produce a crop for the next season that will hold the balance of power in the world—a balance of power for equitable prices in the United States. On the irrigated lands sufficient crops can be raised in 1915 to prevent any shortage in the United States, should speculators and the “food trusts” sufficiently evade the nation's law officers to ship unlimited quantities of foodstuffs out of the United States to the warring nations.

The West should benefit further through hurried completion of projects under way, and development of new ones. As soon as capital gets straightened out of the tangle into which war tossed international credits, it is bound to realize the values of land-at-work in the United States and there should be money to develop every feasible project.

Irrigation will double and treble crops on many semi-arid farms. Where water can be obtained by pumping, the wise farmer on these semi-arid lands is going to dig wells just as quickly as possible, and install pumps and bring his land up to its highest efficiency.

The war is a tremendous struggle, awesome in its greatness and horror, but do not be blinded by its awesomeness and miss this opportunity—greatest in the history of the United States and even greater for the West and the irrigators.

Americanize America. Clinch the markets while they are open.

It is our earnest hope that out of Europe's great struggle there will evolve the truism: “The sun never sets on the American flag, flying above American ships.”

Fulton H. Sears May Go to Congress

Fulton H. Sears, member of the Executive Committee of the National Federation of Water Users' Associations and a farmer on the Truckee-Carson project, is a candidate at the primaries for the Democratic nomination for Congressman from Nevada. There are few men in the United States with a better knowledge of irrigation affairs as they concern the settlers on federal projects than is Mr. Sears, and if nominated and elected, he will be an exceedingly valuable man, not only to his own state, but to all the West and to the nation.

Mr. Sears is a man well equipped also to represent the various other interests of Nevada as well as its farmers. He is a lawyer and his practice has been of a kind to acquaint him with the human as well as the business side of life. He has developed one of the best homestead eighties on the Truckee project, and has proven himself a business farmer.

Although Mr. Sears spent many years of his life in the east before taking up his homestead, he is of "Nevada blood." His father was a pioneer in Nevada and staked out Carson City.

As a worker in the interests of the Federal Water Users, Mr. Sears has been tireless. This work has taken him to Washington frequently and he is no stranger to the ways of Congress, in which he hopes to sit.

THE IRRIGATION AGE wishes Mr. Sears success in his venture. Nevada could not choose a better man.

A Good "Trust" but Born Wrong

The International Harvester Company is a perfectly good trust, but it wasn't born twelve years ago in accordance with the prescribed rules of old Doctor Sherman Law. Therefore it must be dissolved, says the United States district court. Two out of the three judges, who heard the case, reached the verdict.

The decision does not sustain any of the government's charges—so often and so recently repeated in political discussion—of (a) monopolization and coercion of local dealers; or (b) local price-cutting to destroy competitors; or (c) excessive prices; or (d) oppressive trade practices; or (e) destruction of freedom of competition in the manufacture and sale of harvesting machines.

Although the government's complaint was based almost entirely upon the charges that the International company was monopolizing trade in 1912, when the suit was filed, the court ignores that charge and bases its decision upon the size and proportion of trade acquired by the company at its

birth. This is declared to be an entirely new construction of the Sherman law. In other words, under this decision the company is not allowed any credit for having "reformed," even though all its acts since its birth have been fair and just. And on the latter point, the judges seem to have agreed, for in concurring in the majority opinion, Judge Hook says:

"It is but just, however, to say and to make it plain that in the main the business conduct of the company toward its competitors and the public has been honorable, clean and fair. Some petty dishonesties were tracked in at the start, mostly from subordinates, who had been in the service of the old companies, but they were soon gotten rid of. In this connection, it should also be said that specific charges of misconduct were made in the government's petition which found no warrant whatever in the proof. They were of such a character and there was so much of them apparently without foundation that the case is exceptional in that particular."

It looks to the man on the outside that the only sufferers under this decision are the thousands of stockholders, many of whom became such long after the birth of the company.

Well, there are some other sufferers—the political prattlers, who delighted in denouncing the "Great Harvester Trust." Poor fellows, all their ammunition is gone. The court did not even find that the organizers had any intention of violating the law, when the company was organized.

European Women Ready for Farm Duties

The crops of Europe are being harvested by women. Upon them also may devolve the duty of planting such crops as may be grown next year in the war-torn nations.

The task is a big one, but according to a report of the International Institute of Agriculture at Rome, the European women are well prepared to handle it. This report, prepared before the war began, is almost uncanny in the picture it presents of the preparations made by the women themselves for just such a gigantic emergency as now has arisen. Leadership in the "back to the land" movement had fallen almost entirely into the hands of the women, according to the report. They were being encouraged by monarchy and republic alike, when war was declared, and they were called upon to put their training into actual practice.

The women had taken up the movement with greater appreciation of its economical, social and moral importance. They had obtained the enactment of many laws favoring their position.

In its report, the institute declares that the most

striking feature of the "back to the land" movement is its universality, the manner in which it has sprung into importance in practically every country in the world. This has been due largely to the world-wide awakened conscience of woman.

While immense progress has been made in the education of women for agricultural pursuits in such larger countries as the United States, Great Britain and Germany, the institute finds that it is being carried forward on a much more extensive basis in several of the smaller states.

In Switzerland, for example, there are in every canton agricultural schools for women, all of which have more or less subsidy from the state. Holland already has twenty-one such schools with several others in course of construction. Sweden has five normal schools alone, the sole object of which is the preparation of teachers for agricultural instruction to women. The little duchy of Luxembourg, with a population of only 240,000, has fifteen agricultural schools for women. Italy has ten.

In Belgium the movement has taken a most general and effective trend. The government has thirty schools and in addition has given great encouragement to the organization of clubs among women engaged in agricultural pursuits. Of these clubs 183 have been formed with a total membership of nearly 22,000. The clubs have had the important effect of keeping thousands of young girls on the farm, and it has been found that where the young women remain the young men will always linger. This is a practical solution of the agricultural labor problem.

After Belgium, the institute gives the greatest credit to France for novel methods of agricultural education for women. Here the most effective work has been done by the "perambulating school." Any community that will meet the expense and guarantee a certain number of girl students over fifteen years of age can have one of these schools. The teachers and all the material necessary are sent to the community by the government. The courses last for several months and when finished the school moves on to the next place where its presence has been requested.

Within a few years it will be possible to give agricultural education to the entire 900,000 women and girls in France.

There is no reason at present why the United States should become involved in the great European and Asiatic war. However, if trouble must come, it is better that we settle it in this generation than that we should pass it on as a heritage to our children.

**It's Time,
Mr. Lane,
to Clean
House.**

With the Twenty Year bill out of the way, isn't this the opportune moment for Secretary Lane to clean out the Reclamation Service bureaucracy? True, he has neutralized it to a degree, but with the bill as it finally passed Congress, neutralization of F. H. Newell and the other cogs of the old bureaucracy is not enough.

The Underwood amendment, if the direful predictions of western senators may be believed to the extent of about one-twentieth of their face value, offers tremendous opportunity for political log-rolling. Washington has never had a better corps of log-rollers than those who created the Reclamation Service bureaucracy. As a matter of self-protection, if not in the interests of the settlers, Secretary Lane should start cleaning house.

Newell has proven himself a cold-blooded bureaucrat, with no regard for the interests of the settlers. Under his administration of the Reclamation Service tremendous burdens have been heaped upon the settlers.

It is high time Newell was retired. Secretary Lane should swing his ax without further excuse or parley.

**More Money
For Farm
Loans in
The West**

The big bankers, insurance companies and others with money to lend are turning their eyes to the West. Since early in April, the number of farm loans throughout the West, made with eastern money, has steadily increased. The feeling that a farm in the West offers just about as good security as can be found is growing daily in Chicago, New York and other financial centers.

Several big insurance companies now have representatives in the West seeking desirable loans. There will be more before the end of the year. This is going to mean cheaper money for the West. The day of eight, ten and twelve per cent money, on which the private bankers of the West have grown rich and waxed fat, are about over. And it is time these days should end. There is nothing that so retards the development of an agricultural country as high-priced money.

One big insurance company already has \$15,000,000 loaned out in Oklahoma and Kansas and is extending its operations westward, we are told. As the result of the invasion of this eastern money, interest rates in the leading districts of the two states have dropped from an average rate of 6½ per cent a year ago to 5½ to 5¾ per cent.

MANAGER AND IRRIGATOR FACE TO FACE

The Human Problem on the Project; How to Solve It

By W. O. COTTON

Civil Engineer and Irrigation Manager, Idaho Falls, Idaho

AFTER an irrigation system is completed, it is found that questions yet remain for decision that are far more perplexing than the mere construction of ditches. Probably no canal has been constructed in this country of which this has not been true.

On the new project it might be said that the engineering, physical and legal problems are very well worked out and the most important problem confronting the irrigation men of today is the human problem, and one of the most important items of this problem is how best to reach the farmer, get his viewpoint and diffuse knowledge to him.

While practically all managers of irrigation systems have their methods of handling this problem, there are some in charge of large systems of distribution who are much more successful than others and there are probably few, if any, who are entirely satisfied with their method. Every superintendent or manager realizes that his first duty is to divide and deliver the water carried to every irrigator in a just and practical manner, and do this tactfully, as the irrigator knows only one test of successful canal operation—an ample water supply when and where needed.

It is my belief that at the bottom of this problem is the need of better understanding between the farmer and the men in charge. The farmers on many of our projects are men of all classes and vocations, and it goes without saying that these people have many different ideas, hence it is hard to settle upon any one rule which will work in all cases. The men in charge are, in most cases, men who thoroughly understand either the engineering, physical or legal conditions, but there are few who have a combination of these three and with it an understanding of the human problem. Nor is it any wonder, as it is only a short time since the irrigation men thought that when the engineering, physical and legal questions were solved, the system was completed.

Few farmers can take the same viewpoint of

canal operation that the professional manager does. The manager must look after the interests of many, scattered over a large territory; try to give the farmer the best and most economical service and at the same time look after the best interests of the system for the future. All of this is out of the farmer's line and he often takes grave exceptions to it, and too often when the farmer sees a professional irrigation or agriculture man come into his field, he immediately thinks he is after something, either his water right, his farm or his money, for he reasons "What interest can this man have in me unless it be a monetary one?"

These roads traveled, one by the farmer, the other by men in charge, seem to be parallel and perhaps convergent in the distant future, but just how to get off the wrong road and meet half-way the farmer is the question.

First: The manager must, through the joint division and distribution of water, gain the confidence of the farmer; then, through keeping his word in all cases and at all times, and by displaying a character well above reproach, he may gain the farmer's respect.

Second: The manager should consider visiting his farmers a part of his duty and do as much of it as his other duties will allow him; in this way the farmer will come to see that the manager is not only a technical man,

but is also a practical man, and there is no one who has the chance the manager does of knowing the aggregate production of his particular section, and with this knowledge is in a position to give helpful suggestions in regard to the plants best adapted to soil, climate and market conditions. I aided a farmer to secure a prize on his potatoes at the National Land Show, which helped wonderfully in winning him over and also some of his neighbors.

Third: The success of irrigation lies to a great extent in specializing; the manager cannot hope to be a specialist on all lines, but he knows where to find the State or Government specialist



A water wheel which lifts irrigating waters from Grand River in Colorado.

in this particular line, who is always glad to cooperate. In this way he can do a great deal of good.

Fourth: The manager must be tactful in telling the farmer he is using too much water for his own good and the good of his neighbors, or that he should raise this crop or that crop;

the farmer is the most skeptical and superstitious of any class of men, and at the same time the backbone of the country. Unless the farmer was of rare makeup he would probably resent information given in this manner, but the same information can be diffused to him through the local newspapers, in articles pointing out some man who has made a notable success by using less water, or who has made a success in specializing.

Fifth: I am a strong believer in the men in charge owning land in the project over which they have charge; the settler or farmer will probably argue that favoritism is practiced in the vicinity of that farm, but I do not consider this as dangerous a charge as that of not being interested in the enterprise, as it seems to afford the farmer a good deal of satisfaction to know that the manager has all of these heavy operation and maintenance charges to "dig up," and in turn it gives the manager a certain satisfaction if he can make his farm pay or meet expenses, laboring under the same conditions as the neighboring farmer. This, I think, establishes a sympathy and comes nearer giving the manager the viewpoint of the farmer than any other thing that can be done.

Sixth: I think a great deal can be done to forestall this problem on new irrigation schemes by understanding the failures in the past and making use of the experience gained, as the history of the railroad companies forty or fifty years ago shows the same mad rush that we experienced, only a few years ago, in irrigation development, with a depression following which caused a "survival of the fittest."

Seventh: Too often the farmer does not realize the fact that a cheap manager may cause partial crop failure which may run anywhere from one dollar to ten dollars per acre on a good many thousands of acres; they fail to realize that the best investment is intelligence, and in order to keep this man they must pay a wage comparable with the position he holds.

Usually a major portion of the complaints registered come from men who have been too optimistic or who do not care to succeed, if success means laborious toil and study of soil, climate and market conditions.

Eighth: The thing demanded on these irriga-



Water for the crops when needed. The headgate on a Colorado irrigation canal.

tion projects is a man with good practical judgment, who can speak a language that the layman can understand, who can treat them like bank presidents when they come into the office. If they have a grievance the man in charge should be cool and composed and explain the point

in question so that the farmer can understand. This will not always satisfy the farmer, but at least you have gained his respect, and this is a long step in the right direction.

I will borrow an illustration for the point I wish to make from C. H. DeCamp, one of the most successful farmers in the Upper Snake River Valley. The cow that was black on one side and white on the other, when viewed from different sides left different impressions, both correct. What the manager and farmer want to accomplish is to both get on the same side of the cow at the same time. In order to do this, the water user must understand more of the technical and the manager more of the practical. The manager must secure the confidence and respect of the water users; he must keep in touch with them; he should take time to show the farmer why the installation of a measuring device is necessary for the successful division of the water and will not deprive him of any of his water.

The manager should not waste any time telling the farmer about the value of "N" in Cutter's formula. He doesn't know anything about it and cares less. He should talk plain English; give the farmer to understand he is working for him and that his interests as manager are identical with those of the settler and that his success as a water user and farmer means success also for the manager.

It will perhaps seem that in this case the manager must do the major portion of the teaching (or work), but it is my firm belief that in doing so he will gradually obtain the farmer's viewpoint and thus he puts himself in a good position to cooperate which is absolutely necessary to be successful.

Send \$1.00 for 1 year's subscription to the IRRIGATION AGE and bound copy of THE PRIMER OF IRRIGATION. If you desire a copy of The Primer of Hydraulics add \$2.50 to above price.

The Federal Water Users



A Department Devoted to the
Interests of the Farmers on the
Government Irrigation Projects

EDITED BY GEORGE J. SCHARSCHUG

SETTLERS' ORGANIZATION WIDENS ACTIVITIES

President Smith of National Federation of Water Users Outlines Plans

A MEETING in the near future of the National Federation of Water Users' Associations, as suggested editorially in the August issue of THE IRRIGATION AGE, now seems assured. Arrangements to widen the scope of activities of the Federation and make it a still more effective weapon in behalf of the Federal Water Users, are also under way.

Prominent irrigators on the Federal projects recognize that with the revaluation of the systems at hand, the settlers are face to face with problems even more serious than those confronted in obtaining passage of the Twenty Year bill. The putting into operation of various features of the new law will also present added complications.

In order to meet this situation with a united and thoroughly representative front, the Executive Committee of the National Federation has taken steps to enlarge this committee and to include in its membership a representative from every project. Where the regular Water Users' Association is dominated by the Reclamation Service, as is the case on three or four projects, the Executive Committee proposes to recognize some minority organization of the settlers until such time as the regular Association joins the Federation.

The value of the National Federation to the individual Water User and to the various project associations is far greater today than ever before. In the conferences in Washington in May, 1913, Secretary Lane pledged himself to deal so far as possible with the Federation officials as the recog-



A Prune Orchard in the San Joaquin Valley of California.

nized representatives of the Water Users. The Secretary did this because he believed it was better to deal with an organized body than with numerous individuals or Associations. Under the new law and the policies which the Secretary is inaugurating on the projects the value of the Federation is believed to be recognized more at Washington now than when Secretary Lane met with the Federation in 1913.

Some indications of the plans of the Executive Committee are outlined in the following letter, written by Earl B. Smith, of Somerton, Ariz., president of the National Federation, to H. A. Bustrin, of Phoenix, Ariz., vice-president of the Land Owners' Protective Association on the Salt River project:

"Your Salt River Valley Water Users' Association always cooperated with the Executive Committee of the National Federation of Water Users up to the end of the Washington Conference with Secretary Lane in May, 1913, but since that time it has not cooperated. You have all had the benefit of all the work this Committee has done, and we are disappointed that your Association saw fit to abandon us, and it is difficult for us to understand the reason as none was ever given or offered. My knowledge of you is only obtained from your communications to THE IRRIGATION AGE. I am well acquainted with your Mr. Sam Barrett.

"There are only four or five Associations that have not cooperated with us, all of which, we think, are under the control of the United States Reclama-

tion Service for certain unknown reasons. The Service thinks we are its enemy, whereas we are only the enemy of the persons who have controlled its policies in the past.

"Some time ago I recommended to our Committee that we enlarge the scope of our Committee to include one from each project Water Users' Association, and where the regular Association did not see fit to cooperate with us, that we recognize a representative from some minority organization on the project. This recommendation was approved by all the members of our Executive Committee, but we did not see fit to push the matter during the period of time while the extension bill was under consideration as we all had all we could attend to in the way of correspondence during that long period. Now that that bill has become a law, I think we should more thoroughly organize for future work, which I think will be as important as the extension matter.

"The Irrigation Congress has gone to the dogs, apparently, and if our committee could be strengthened we might reorganize such an institution through the instrumentalities of our enlarged Committee. THE AGE would be our organ, undoubtedly. But that organ needs our help in order that it may be of influence among the actual Water Users.

"I will now ask you if your Land Owners' Protective Association, of which you are the vice-president, would be willing to delegate a committeemen who would represent the Water Users of Phoenix up to the time when the regular Association should see fit to again cooperate with us.

"I wish you would think this matter over carefully and consult your Association regarding it, and if the idea should seem to you feasible, I should feel encouraged to make the same proposition to the other four projects who have been influenced to not cooperate."

HOW WILL 20-YEAR BILL AFFECT SETTLERS?

Big Questions Arise as New Law is About to be Enforced

WHAT proportion of the settlers on the Federal projects will accept the conditions provided in the recently passed twenty-year payment bill?

How will the bill affect those who prefer to continue their payments and complete title to their land and water rights under the original Reclamation Act?

These are two big, outstanding questions on every Federal project. Their answer hinges largely upon Secretary Lane's forthcoming public notice concerning readjustment of payments and operation of the law. The answer also will be affected greatly by the results of the revaluations of the projects, which the Secretary has ordered.

A hint of what this revaluation may bring is contained in the order opening a new unit of the Truckee-Carson project in Nevada. The settlers now on the project have contracts with the government providing for payments of \$22 and \$30 per acre for their water rights. The cost of water rights in the new unit has been fixed at \$60.

The Underwood amendment to the Twenty-Year bill has also caused much speculation among the irrigators as to its future effects on Federal Reclamation. Congressman Taylor of Colorado declares the members of the House from the East and South were solid for this amendment because they felt it would prevent abuses of the Reclamation fund, such as have characterized its history in the past, and would also force the Reclamation Service to "operate on a business basis."

In accepting the amendment, many Western Senators took a very gloomy view of its "pork barrel" possibilities.

"I consider the provision put in the bill in the House a very unwise if not a vicious provision; but we were confronted with the proposition of no bill at all or agreeing to this amendment," said Senator Wesley L. Jones of Washington. "I felt compelled to sign the conference report rather than

have the bill fail, because I know the condition of many of the settlers under the various irrigation projects; and for their relief and for their help it is absolutely necessary and essential that the other parts of this bill should be passed.

"We are simply forced to take this bill with this amendment, and that is all there is to it, to get the relief that is absolutely essential to the settlers under many of these various irrigation projects. For that reason, and that reason alone, I signed the conference report."

Senator Myers of Montana declared:

"I view with great alarm the adoption of this report. I would rather stay on the 10-year payment plan of Reclamation projects than to adopt this report and have the bill amended in this way.

"I think the expenditure of the Reclamation fund is right where it belongs and ought to be—under the administrative department of the Government. It can handle it better, it knows the needs better, it knows conditions better than Congress can possibly know them; it has been well conducted. I have no fault to find with the administration of the Reclamation Service of the Government.

"If we take the control of these expenditures away from the Reclamation Service and put it in Congress, I think it will make just what is popularly called a "pork-barrel" proposition out of it. It will not be decided on its merits. It will be subject to wirepulling and intrigue and pressure and influence of all sorts, wholly independent of merit, and will be decided in a manner far removed from the merits of the proposition.

"I know by experience what it takes to get money from Congress for reclamation projects, and I predict that when this is put in the hands of Congress every reclamation project in the West will be up against just the same thing that the Flathead (Indian) reclamation project in Montana is up against every year.

"There are three Government reclamation projects in Montana; and if I had to go through what I have to go through every year for the Flat-head project in the case of every one of three others, making four in all, I would not be able to do it; that is all there is to it. I would not have any time or life left.

"Our conferees come back here and tell us what is undoubtedly true, that unless we recede the House conferees say the bill shall fail and they will put in a provision for interest the next time. That is another threat hanging over our heads. That very same condition might arise if this becomes a law. Every time a bill appropriating money for reclamation projects is passed, when we fix it the way we think it ought to be, it will go to conference and the House conferees will have it in their power to say it must be changed so-and-so, and if it is not the whole bill will fail and nobody will get a dollar."

Refusal of the House to agree to the "court jurisdiction" amendment, which was advocated strongly by the National Federation of Water Users' Associations was a disappointment to the settlers generally, but it has not ended the fight. The Water Users feel that they should have the right of litigation, when a question concerning their interests arises, and the leaders are already preparing to renew the battle for "court jurisdiction" before a future session of Congress.

Although it is now history, it is interesting to study the argument of the Reclamation Service against the court amendment. It furnished what little excuse the members of the House committee on Irrigation could stir up for refusing the request of the settlers. The plea, which was made by A. R. Honnold, Denver attorney of the Reclamation Service, follows:

"I believe that the amendment is not consonant with or in keeping with the United States Judicial Code or court decisions, but is a radical departure, hedged about with no restrictions, and gives the United States court jurisdiction of all cases arising in the future between Water Users and the association and others.

"It confers no rights on the United States that it does not now enjoy.

"The Water Users have a method of enforcing the law. Under the code and the equity rules one or more settlers may sue on behalf of all concerned and similarly situated.

"It does not restrict associations or districts to those contemplated by the Reclamation Act, but embraces all such as are legally organized. All such associations and districts are creatures of State statute.

"Water Users' associations represent all users thereunder and costs are apportioned against all. Perhaps but a part wish to sue or are in a position to benefit by the suit. On account of the comparative small cost to each farmer by such cooperative litigation it will be easy for unscrupulous lawyers to induce the association to permit of bringing a suit on the slightest provocation.

"It permits any such organization legally constituted under State law to bring suits against United States officials regarding water rights.

"It means many legal complications and will entail large expense without compensating benefits.

"In the enforcement of the homestead laws under projects the General Land Office and the local land officers will be forced to follow decisions of the United States courts in various States, and which may be different in the various States.

"Possible private irrigation promoters under the guise of irrigation districts or Water Users' associations may tie up Government construction of reclamation projects for long periods of time by raising questions regarding the water supply.

"Government construction might be held up for long periods by injunctions pendente lite, etc.

"The amendment will greatly complicate the disposition of Government business and interfere with its dispatch.

"It will have the effect of nullifying to a certain effect much of the very things the bill sought to do.

"It has not been considered by the Judiciary Committee nor by the Department of Justice.

"I believe the amendment is entirely foreign to the general purposes of the bill to which it is attached and should be stricken therefrom.

"The judicial code of the United States provides, in chapter 2, the first section, that the United States district courts shall have original jurisdiction of all suits of a civil nature, at common law or in equity, brought by the United States. To that extent the first part of the bill confers no new rights. However, the jurisdiction which is given to the courts of all suits brought by Water Users' associations or otherwise is unlimited, and if at any time projects are turned over to the farmers and the Government has no remaining interest in them, still the United States courts would be vested with jurisdiction of all cases relating to individuals regardless of the land involved. To that extent it looks to me like it would be a burden upon the Water Users."

IRRIGATED LAND LOTTERY

The second unit of the Truckee-Carson project will be thrown open to settlement this month. Uncle Sam will allot the 40 and 80 acre homesteads by a lottery at Fallon, Nev., Sept. 18.

There is a lot of valuable land for general farming, dairying and beet raising in the new unit. A sufficient water supply now seems assured.

The cost of water right under this unit of the Truckee-Carson project will be \$60 per acre, the payment required when application is made amounting to \$3 per acre. The remainder of the construction charge, \$57 per acre, shall be paid in fifteen annual installments, the first five of which shall be \$3 per acre each, and the remainder \$4.20 each.

Send \$1.00 for 1 year's subscription to the IRRIGATION AGE and bound copy of THE PRIMER OF IRRIGATION. If you desire a copy of The Primer of Hydraulics add \$2.50 to above price.

MAY GROW SUGAR BEET SEED IN NEVADA

J. W. FERGUSON is experimenting with the raising of sugar beet seed on the Truckee - Carson project in Nevada. Mr. Ferguson found that there were many beets left on his place from last year's crop that were not injured by the winter weather. He called the attention of Professor S. C. Knight, of the University of Nevada to this and Mr. Knight suggested that a test be made of the beets in growing seed. It was agreed that a dozen should be sent to the experiment station at the University and that a number would be reset on the ranch where they grew. Tests of the beets were made and it was found that they came through the winter and still tested 23 per cent sugar.

The samples which Mr. Ferguson has dug up show that the growth and development of the seed is most prolific, every stalk being loaded with seed. It is the intention of Mr. Ferguson and Prof. Knight to make thorough tests of growing beets from the seed thus produced and if possible determine whether it is feasible to produce beet seed in Nevada.

Practically all of the beet seed for this country comes from Germany and Austria. It is a wonderfully scientific industry in those countries, hundreds of chemists being employed in order to insure the production of seed that can be depended upon to germinate. Now that those countries are at war with the probability that the beet fields will be neglected and destroyed by armies, the securing of seed for America becomes a serious problem.

The process of raising beet seed is rather slow. For instance, the beets grown last year are set out this spring and will bring forth a crop of seed the coming fall. Then in turn, that seed would be planted next spring, so it takes two years to secure the seed.

If seed can be grown here to advantage, there are a number of Nevada farmers who are raising beets this season that could save a good supply for next year and soon have this valuable home industry well under way if the necessary scientific methods can be applied in the United States to determine whether the seed grown will germinate.

Secretary H. E. Roe of the Nevada Sugar Company says there is an ample supply of seed now on hand in the Fallon factory for all requirements



Almost Ready to Harvest. Fields Near Deming, N. M.

for seeding in 1915, so if seed could be produced next year it would fill the requirements for 1916, and western Nevada would sail along with the beet industry regardless of conditions across the water. The experiment will be watched with much interest in all the other beet districts.

KANSAS IRRIGATORS MEET

The third annual meeting of the Kansas State Irrigation congress will be held in Scott City, September 22 and 23, according to an announcement by H. B. Walker, irrigation engineer in the Kansas State Agricultural college, who is secretary of the organization.

Problems relating to the construction of wells, pumps, engines, central power plants and the preparation of land, to the care of crops and to irrigation legislation, will be discussed. It is stated that Kansas has between two and three million acres of shallow water land. Practical Kansas irrigators will make the addresses at the meeting, over which E. E. Coffin of Scott City, president of the congress, will preside.

Scott City is situated in the great shallow water district which extends southward to the Arkansas river, and persons who attend the meeting will have an opportunity to visit some of the numerous pumping plants in the vicinity. Demonstrations will be given of the proper methods of handling water.

PARK FOR UMATILLA FOLKS

Federal Water Users on the Umatilla project in Oregon are considering plans for the establishment of a summer resort on the banks of the big reservoir created by the diversion dam near Hermiston. It is proposed to plant shade trees and grass and make other improvements. Several boats have been placed on the lake.

Send \$1.00 for 1 year's subscription to the IRRIGATION AGE and bound copy of THE PRIMER OF IRRIGATION. If you desire a copy of The Primer of Hydraulics, add \$2.50 to above price.

SILO PROVES ITS WORTH ON IRRIGATED FARMS

Farmers Tell of Success With "Feed Ice Boxes"

ACTUAL farmers are proving the value of the silo on the irrigated farms of the West.

Ensilage proved exceedingly valuable in many sections of the West this year, when the warm and dry weather began to cut down the pasturage.

The Western Washington experiment station at Puyallup began feeding from one of its silos

early in July. The oats, vetch and corn put into the silo last fall, were all found in excellent condition and were relished by the stock.

Years ago many silos were erected in Western Oregon, but more than half of them were failures because they were not air-tight. The result was lost enthusiasm, a backset to this system of preserving the feed.

While a good silo may cost a little more at the beginning than a poorly constructed one, it is the cheaper of the two and the only practical one. Had the farmers of Oregon built air-tight instead of leaky silos in the first place their dairy and live stock industry would have been far more profitable to them than at the present time.

Many irrigation farmers have started in this year with home-made pit silos. Writing of his experiences with such a silo, A. H. Weeks, of Valleyford, Wash., says:

"My pit silo is 10 feet 6 inches in diameter from wall to wall of earth. I hired the digging done and furnished the powder to loosen the clay. Labor and powder cost me \$15, cement \$14, gravel \$2, lumber cut to make forms \$3, mixing concrete and filling cost \$7.50, making a total of \$41.50 cash outlay. The silo is 10 feet diameter and 14 feet deep. The hauling of the gravel and work of making and putting up forms we did ourselves. Figuring wages for time and teams, I consider the cost to be about \$60.

"My forms are made of segments sawed from 1x12 common boards and braced across from joint to joint by 1x4, with small pieces of board nailed over the joint to hold together. I then set these forms in the pit and set 2x4 pieces under each joint

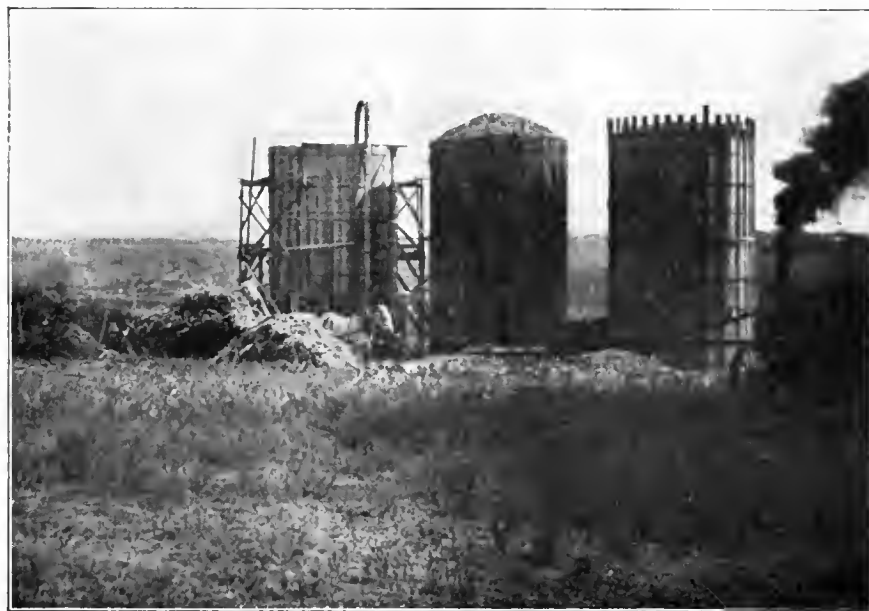

Filling home-made stave silos in the Southwest.

so as to hold them the right distance apart, plumbed and braced these circles to hold them in position. I used 1x12 16 feet for the backing, and poured the concrete between them and the dirt, using a 2x4 to tamp the concrete with, making a wall 3 inches in thickness. I used one part Portland cement and 9 parts of gravel, which makes a

very good wall, but does not turn water. The last two feet at top I used 1 to 6 parts cement and gravel. I covered the bottom same as main part of sides.

"I put in what I considered was 12 tons of green fodder for silage; this filled about 10 feet when settled. I cut this fodder from about four acres of ground. I also cut and shocked about seventeen acres, which we cut with a hand cutter, and fed before starting on the silage. We got relatively the same amount of feed from the four acres made into silage as we did from the seventeen acres of dry fodder. The silage, however, held the cows up in their milk flow to quite a degree, noticeable, at least when they began to fail on the dry fodder after threshing.

"When the spring freshets came my silo took in a considerable amount of water. I thought I had lost my feed but instead it proved the saving of it. I am digging it out of the water today and feeding it along with alfalfa hay and green oats and peas and the cows seem to like it as well as they did before the water entered. We dip the water out so as to keep the silage solid enough to stand on, and feed as usual. In filling I tamped the fodder well as it fell from the cutter and added four oil barrels of water. Two or three days after filling I put two barrels more on, and a week later two additional barrels. Then I left the pit open until December, after having filled up above the silage to about level with oats, straw and chaff. I am well pleased with my pit silo and contemplate later of putting a stave silo on top of the pit silo."

Fred A. Hutton, who is farming near Dixon.

(Continued on page 347.)

The GRIMES

**The Pump
that You Will
Eventually
Buy—So Why
Not Save Your
Experimental
Expense?**

**The Sooner You
Install a GRIMES,
The Sooner You Will
Begin Reducing
Your Pumping Costs
and Solve Your
Pumping Problems**

**Screw Principle—
the Archimedian
Effective Use of
This—a simple but
Well—Just Like
Ditch, Stream or
Water from Lake,
It Raises the**

**Moderate Initial Cost
Requires Very Little
Attention**

**Cannot Get Out
of Order**

**A Durable, One-
Piece Machine**

**Unaffected by Sand,
Gravel or Mud
Conditions**

**Always Ready for
Instant Use**

**Can be Operated
With Any Form of
Power Available**

**Low Power
Consumption**



Irrigation Pump

Loveland, Colorado,
August 15th, 1914

The Grimes Irrigation Pump Company,
Denver, Colorado.

Gentlemen:

It gives me pleasure to advise that the 40" diameter Grimes pump you installed for me is doing everything you guaranteed it would do. I am elevating more water, to a height of 34 feet, than my 8" pipe will carry under pressure with an 8 horse-power engine.

When operated to the full capacity of the engine it requires a 12" pipe to carry off the flow.

I see no reason why this pump should not give me good service for a number of years as it is certainly made to last.

I believe you will make a large number of sales in this immediate vicinity as the pump is attracting the attention of the farmers for quite a distance around.

If you have any prospective customers, who will want to know what I think of this pump, if they will write me, I will be glad to tell them all they want to know.

Very truly yours,
W. W. NICHOLS.

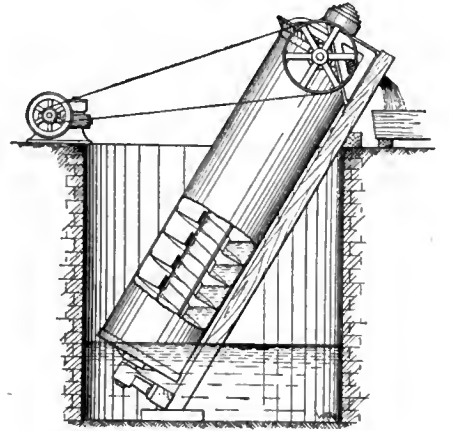

**The GRIMES Pump
Will Lift a Given
Quantity of Water
to a Greater Height
With Less Power
Than Any Other
Water Elevator
on the Market.**

**WE CAN PROVE THIS
BY OUR MACHINES'
RECORDS WHEREVER
INSTALLED.**

**EACH PLANT BUILT TO ORDER TO MEET
VARIED INDIVIDUAL NEEDS AND CONDI-
TIONS. ESTIMATES GLADLY FURNISHED.**

Fill Out Mail TODAY 

The Grimes Irrigation Pump Co.

**1022 First National Bank Building
DENVER, COLORADO**

**THE GRIMES IRRIGATION PUMP CO., 1022 First Nat. Bk. Bldg.
Denver, Colo.**

Gentlemen:—
 (My Name is).....
 (Post Office).....
 (Nature of Water Source).....
 (Volume of Supply).....
 (Ac. Sage to Irrigate).....
 (Height of Lift).....
 (Power).....
 I—A—
 B—14

(State).....
 ft.

DRYLAND DREDGING

DRY LAND dredging is one of the newer industries that is developing rapidly. Oil and gas engines are the motive powers most generally used for this work. The steam engine on this class of work has proven successful from a financial standpoint, but the great weight of the outfit, together with the extreme difficulties of supplying it with water and



A Dry Land Dredge Driven by a Heer Two-Cylinder Opposed Engine.

fuel, have made it prohibitive in some parts of the country.

The dry land dredges are regular dirt-eaters. A one-half yard machine will shovel from 400 to 600 yards of dirt in 10 hours. The machine's operation is similar to that of a steam shovel.

The work is very hard on an engine, because of the sudden variation from no load to overload. In dropping the empty bucket, there is practically no load.

When the bucket is being loaded, an overload is thrown on the engine, yet the engine must hold onto its load until the bucket is lifted, swung around and emptied.

SEEKS EXPORT TRADE

A SPECIAL bed for camp and all outdoor use, that is a clever and practical idea, is being offered to the export trade by the Enterprise Bed Co., of Hammond, Ind. It is both a tent and a cot, built in such a manner that it folds away into a very small, compact package that is easily picked up and carried, and yet opens up into a full-sized and comfortable bed.

It is just the thing for hunting, fishing, or for any form of camp use, and is ideal for convalescents or anyone afflicted with lung trouble, as it enables the occupant to sleep out the year round.

The frame of the cot is made of very strong maple, and the canvas top or tent is of especially treated canvas, that is made waterproof by a special process, which has been perfected after years of experimenting. The end and side openings of this cot are all fitted with both storm curtains and heavy mosquito netting, that can be adjusted by the occupant from his position inside the cot.



The "Enterprise" Tent Cot, Set Up and Folded.

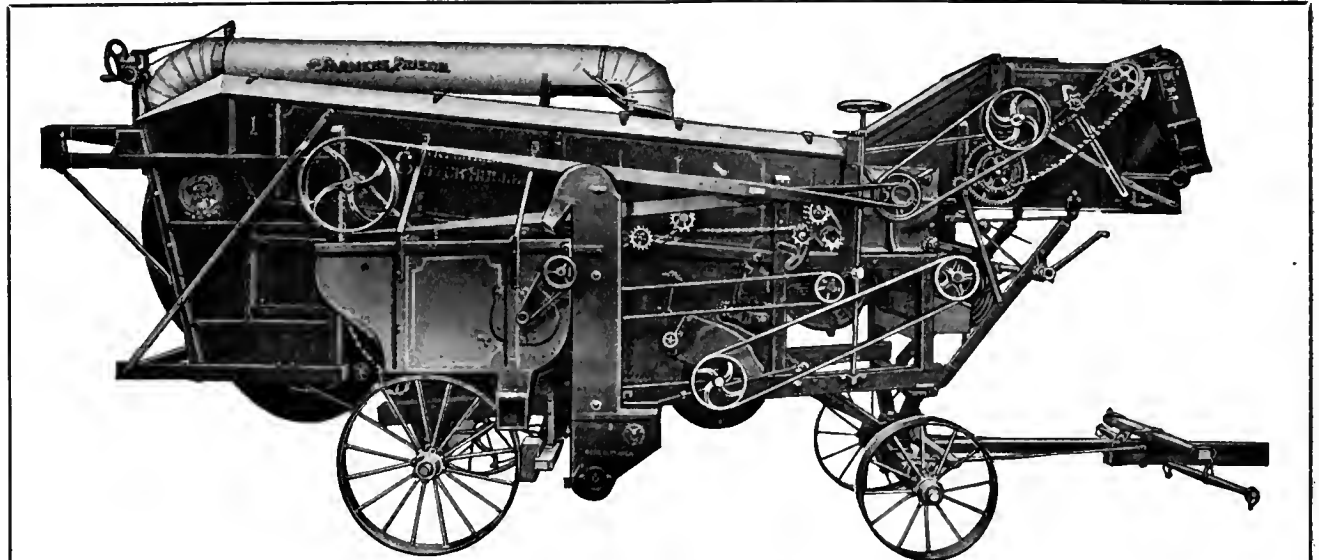

HULL YOUR SEED QUICKLY, PERFECTLY and ECONOMICALLY With a "MATCHLESS" CLOVER and ALFALFA HULLER

That's just what you will do if you use a "Matchless" Huller on the job. It's the one huller that will hull all the Clover or Alfalfa you can get to it without sacrificing the quality of the work. Here's the reason! We use square steel brads in our hulling cylinder. This construction has every advantage over rasps of spikes, because no set of spikes will knock the seed out of the damp pods. Rasps gum up and are easily destroyed. Our system of separation is unique and effective. This consists of a series of rotating troughs with perforation in the bottom, with provision for adjustment to meet the various conditions of clover. The Patented Steel Scrapers attached to the bottom of these troughs thoroughly scrape the separator bottom and insure a steady and positive delivery of the pods to the hulling cylinder, regardless of the condition of the clover. This construction enables you to hull seed under conditions in which no other huller can operate; enables you to hull earlier in the morning and later in the evening than with any other—this insures a longer day, thus increasing your earning power. Give us an opportunity to prove to you right on your own farm that the "Matchless" is the speediest and cleanest huller on the market. WRITE FOR CATALOG TODAY, or call at our nearest Branch House.

THE AULTMAN & TAYLOR MACHINERY COMPANY, MANSFIELD, OHIO.

Sole Builders of Aultman-Taylor "Starved Rooster" Line of Machinery.

BRANCHES: Minneapolis, Minn.; Portland, Ore.; Lincoln, Nebr.; Kansas City, Mo.; Wichita, Kan.; Decatur, Ill.; Indianapolis, Ind.

GATE STRUCTURES FOR IRRIGATION CANALS

MOST of the gate structures in American irrigation canals a few years ago were of wood, but more recently concrete, both plain and reinforced, has come into common use. Wood has the advantage of cheapness and of easy handling and the disadvantage of rapid depreciation, while concrete, which has the advantage of permanence, is more costly. The kind of material used, as well as other features of gate structures, varies in different irrigated regions of the West. One section often uses features especially adapted to it, of which other sections, that could use them equally well, are ignorant. The U. S. Department of Agriculture is endeavoring to bring together such designs for gate structures as are adapted to many localities so that each locality may profit by the practices of others, and has just issued a new bulletin (No. 115) entitled, "Gate Structures for Irrigation Canals." It is intended to be of assistance to engineers and others with technical knowledge of the subject.

Small and medium-sized structures are for the most part described in the new bulletin, as it is believed that most of the problems confronting the engineer located in isolated regions of the West relate to this class. The bulletin should also be of value to directors of mutual water companies who are themselves irrigators and who are called upon to pass upon questions of construction and maintenance.

One of the important questions dealt with is that of the materials to be used for gate structures. Shall they be of wood or concrete? The best practice, according to the department's investigator, seems to be to make a structure of combined wood and concrete, using concrete for the parts that are inaccessible and not easily replaced, and wood for the accessible parts which can be replaced easily. Local conditions affecting the relative prices of these materials will also help to determine which material should be used.

Because of the high cost of water rights, and the inability of settlers to make the payments required, there is much to be said in favor of the cheaper wooden structures for original construction with a view to their replacement with more permanent structures of concrete as the wood decays. This will lessen the first cost and will bring

the heavier cost after the lands have been put under cultivation. The use of wood has the further advantage that in case of mistakes in either the type of structure or the location it is not so costly. It frequently happens that structures are found to be placed too high or too low, or they are too small and not of the best type. A few years' experience in their operation will demonstrate these facts, after which a more permanent structure of wood or concrete may be put in.

Fuel Oil and the Bessemer Cut Power Cost More Than $\frac{1}{2}$

FREE CATALOGUE — WRITE TODAY

The Bessemer Oil Engine not only reduces your power cost but at the same time gives you steam plant reliability *plus*, and the continuous output of power that characterizes the electric motor.

BESSEMER FUEL OIL ENGINES

Not experimental—there being 15000 Bessemer Gas and Oil Engines in daily use. For your mill, mine or factory power plant they form the ideal unit. Single and double cylinders ready for quick delivery. 15 to 165 H.P. The Bessemer operates on low gravity fuel oils costing but one-third the price paid for fuel oils used in other engines. Write for catalogue of this oil engine possessing a score of exclusive better features.

THE BESSEMER GAS ENGINE COMPANY

12 York Street, Grove City, Pa.



BESSEMER ENGINES RUNNING TODAY IN FIFTEEN THOUSAND POWER PLANTS



THE TENT-COT OPEN AND FOLDED

above the ground under a storm-proof covering that enables you to use the Tent-Cot every night in the year, and all the doors and windows are fitted with both storm and mosquito curtains that can be raised and lowered at will of the occupant. For anyone afflicted with lung trouble there is nothing equals the Tent-Cot. It also has a splendid appearance and can be set up on your porch, lawn or roof and taken down when not in use. Can be set up in a space 30x78 inches and only requires about 30 seconds to operate. It is ideal for hunters, fishers and campers as it eliminates all the annoyance of "making camp." With a Tent-Cot you carry your camp with you under your arm and sleep safe and sound any place.

SPECIFICATIONS—Length of cot open, 6 ft. 6 in.; width of cot, one person, 28 in.; width of cot, two persons, 44 in.; height of bed from ground, 17 in.; height of tent over cot, 32 in.; size of cot folded, for 1 person, 28x36; size of cot folded, for 2 persons, 44x36; wgt. ht. 1 person, 29 lbs.; wgt. 2 persons, 44 lbs.; frame is of hard maple, painted green; covering is of heavy waterproof canvas in colors, tan or olive green.
PRICE—Tent-Cot 28 in. wide, open 1 side, \$9.00; Tent-Cot 28 in. wide, open 2 sides, \$9.50; Tent-Cot 44 in. wide, open 2 sides, \$11.50.

Manufactured Exclusively by

ENTERPRISE BED COMPANY, HAMMOND, INDIANA

When writing to advertisers please mention The Irrigation Age.

BRIEF NOTES FROM IRRIGATION PROJECTS

Kansas

Many new pumping plants have been installed in Kansas this year. An electrically propelled centrifugal pump is pouring 1,800 gallons of water per minute on to the Schuyler Jones farm near Valley Center, in the Arkansas valley. Four crops of alfalfa have already been cut on this farm and two more are expected, while neighboring farms, not irrigated, will have but two or three cuttings.

Walter Underwood has installed a Skinner irrigation system on his truck gardens in Hutchinson.

E. G. Hoover has installed a ten-inch pump, pulled by a 20 horsepower engine, to irrigate his 120 acres near Wichita.

Chas. I. Zirkle & Co. have put in two pumps, each with a capacity of 1,100 gallons per minute and capable of irrigating a half section, near Hutchinson. They are using gas and oil and the cost per acre for irrigating is figured at about 35 cents.

William C. Mueller, living near Hanover, is pumping water from the Little Blue river. He is using a 15 horsepower engine and a pump with capacity of 750 gallons per minute. He is throwing the water up about 25 feet.

C. S. Drake of Valley Center states that he has sold \$500 worth of cantaloupes off one and one-half acres of land which he is irrigating.

Page M. House, living near Wichita, is of the opinion that any man can make a living from five acres of land irrigated by water pumped from the underflow of the Arkansas river. Mr. House has installed a small plant on his place and by means of electric power pumps 300 gallons of water per minute from a 15-inch casing in a well 47 feet deep. His entire plant, including well, pump and motor, was installed for \$500.

Land near where Mr. House has a tract of 42 acres is worth \$300 per acre, but good living for a family may be made from five or ten acres, said he. Mr. House has two acres in corn which he has irrigated and from which he expects to get 200 bushels. He set out black raspberry plants last spring and from them gathered a few berries this year.

Plans are being made to irrigate the forty-acre alfalfa field at the Kansas Boys' State Industrial school. Experiments indicate the idea is feasible.

Washington.

The directors of the West Okanogan Valley Irrigation district of Washington have secured the cooperation of the Great Northern railway in the construction of the irrigation canal which will water 12,000 acres adjacent to Oroville. Construction will begin this month. A large amount of the land to be brought under this canal has been listed for sale at reasonable prices for the purpose of encouraging immigration.

Samuel Lapioli has finished installing an electric pump on his 10-acre tract and will irrigate his garden and orchard at Hayford, Wash.

A United States government engineer has been in Eltopia, Wash., making soil surveys in connection with the Palouse irrigation project.

Water users under the Wenatchee Canal company of Washington voted down a proposition to form an irrigation district to take over the system.

Sentiment is quite unanimous that in the near future an irrigation district will have to be formed in order to take over the high-line canal. It supplies water to 13,000 acres, but the

Alfalfa for profit

"One-Half the Alfalfa Seed Sown is Wasted Every Year"

This statement has been made by many recognized Alfalfa experts—men who know what they are talking about.

They say that they secured better stands of Alfalfa with 10 pounds of seed, drilled with the Superior Special Alfalfa and Grass Seed Drill than with 20 pounds of seed sown broadcast.

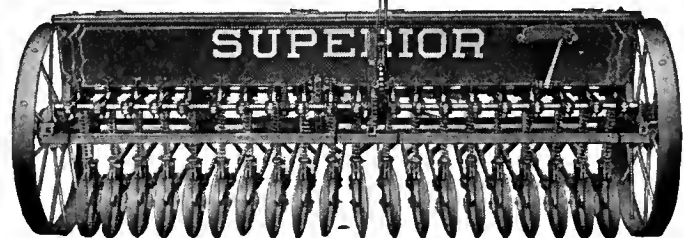

THE SUPERIOR 20 X 4 SPECIAL ALFALFA AND GRASS SEED DRILL

There are 20 discs on this machine set 4 inches apart. The construction is such that all the seed is sown at an even depth, and an equal amount of seed in every furrow.

None of the seed is wasted, when drilled in the ground with a Superior Alfalfa and Grass Seed Drill

REJUVENATES OLD ALFALFA FIELDS

RENEWS OLD PASTURES AND MEADOWS

PRODUCES BEST STANDS OF MILLET

INCREASES YIELDS OF WINTER WHEAT BY

CULTIVATION and SOWS CLOVER AT SAME TIME

Saves More Than Two Dollars an Acre on Seed Alone

Send for Superior Alfalfa Drill folder and read the **strong warranty**

Go to your local dealer and ask to see the Superior Special Alfalfa and Grass Seed Drill. If he will not supply your needs, we will.

THE AMERICAN SEEDING-MACHINE CO., Inc.
SPRINGFIELD, OHIO

FREE—A copy of "Boyd's Farmers' Alfalfa Guide," price 10c, will be mailed free to any reader of Irrigation Age who will write for the book and mention Irrigation Age.

maintenance fee of \$1.50 per acre annually has been much less than the cost of maintaining the big ditch. The company announces this is the last season it will guarantee to keep the canal in safe condition.

Water users realize the gravity of the situation and already there is much talk of immediately proceeding to hold another election, but the election call will probably include no acreage about which there is any dispute. It is deemed better to put the burden of proof on them and allow their rights to be established in court.

Permanent construction plans formulated by the directors of the Union Gap Water Users' Association of North Yakima, Wash., for the improvement of the big ditch that waters a large acreage on Parker Heights were given the decided approval of the stockholders in an almost unanimous vote for the issuance of \$90,000 bonds. There is a large amount of land under the ditch now unwatered, which it is felt will require water in the near future, and

with these demands in mind steel flume will replace wornout wooden flumes, the ditch will be relined and the grade changed in several places, and right of way will be purchased where it has not already been secured. The bonds will be payable in 20 years.

Oregon.

The title to \$100,000,000 of land in Eastern Oregon is menaced by the suit of the Pacific Livestock Company against the State Water Board, according to Superintendent of Water Division Cochran. The company has asked the Federal Court for an injunction against the State Board adjudicating water rights in the Silvies River for 70,000 acres. The suit attacks the Oregon water right statutes.

A pamphlet describing irrigated lands open for settlement on the Tumalo project in the Deschutes valley and giving prices of privately owned lands on the project and in the vicinity, is being published by the Oregon state immigration commission

and the Oregon Development league:

Utah.

As a result of experiments carried on by the Federal Department of Agriculture, in co-operation with the Utah Agricultural College, means have been found for converting the greater part of Washington, Iron, Millard and Beaver counties, in southern Utah, from desert wastes into garden spots capable of producing bountiful crops of grain and general farm products. Two wells have been sunk near the experiment station and water discovered, while indications are that subterranean streams abound at intervals throughout the district, which has never been susceptible to cultivation because of lack of water.

One well is 33 feet deep, and by means of a pump and a gasoline engine produces a flow of 6,000 gallons an hour. The other is 60 feet deep and has a flow of 20,160 gallons an hour. This is capable of supplying water for about 100 acres.

CORN HARVESTER with hinder attachment, cuts and throws in piles on harvester or winrows. Man and horse cut and shock equal to a corn binder. Sold in every state. Price only \$20.00 with fodder binder. J. D. Borne, Haswell, Colo., writes: "Your corn harvester is all you claim for it; cut, tied and shocked 65 acres milo, cane and corn last year." Testimonials and catalog free, showing pictures of harvester. Address **PROCESS MFG. CO., Salina, Kansas.**

BINDER ATTACHMENT with corn harvester cuts and throws in piles on harvester or in winrows. Man and horse cut and shock equal with a corn binder. Sold in every state. Price only \$20.00 with fodder binder. J. D. Borne, Haswell, Colo., writes: "Your corn harvester is all you claim for it; cut, tied and shocked 65 acres milo, cane and corn last year." Testimonials and catalog free, showing pictures of harvester. Address **PROCESS MANUFACTURING CO., Salina, Kansas.**

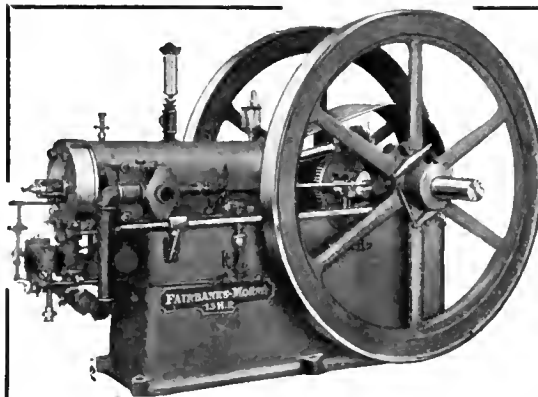

DEMAND Oil Engine Reliability

Why take chances with an engine that may fail you in the hottest, dryest time?

Reliability has taken *first place* in the building of Fairbanks-Morse Oil Engines.

Fuel cost is low because they run as well on kerosene or low grade distillate as on gasoline.

What are your needs?

Fairbanks-Morse & Co.,

Chicago Kansas City St. Louis Omaha
St. Paul Denver Salt Lake City Los Angeles
Spokane Portland Seattle Atlanta (634-246)

BILL AND CHARGE **GENERAL CORRESPONDENCE** **CARDS TAGS LABELS ETC**

Price **\$100**

The Royal does the work of several typewriters in *one*—it writes, types cards and bills! All this without a dollar for "special" attachments. The one machine does it all.

Write Direct for our new Brochure, "**BETTER SERVICE**," and a beautiful Color-Photograph of the **New Royal Master-Model 10.**

ROYAL TYPEWRITER CO., Inc.
Royal Typewriter Building Broadway, N. Y.

Only \$2 DOWN and One Year To Pay

For any Size—Direct from Factory

You can now get one of these splendid money-making, labor-saving machines on a plan whereby it will earn its own cost and more before you pay. You won't feel the cost at all.

\$24 BUYS THE NEW BUTTERFLY

No. 2 Junior—a light running, easy cleaning, close skimming, durable, lifetime guaranteed separator. Skims 95 quarts per hour. We also make four other sizes up to our big 600 lb. capacity machine shown here—all sold at similar low prices and on our liberal terms of **only \$2 down and a year to pay.**

30 DAYS' FREE TRIAL GUARANTEED A LIFETIME

Patented One-Piece Aluminum Skimming Device, Rust Proof and Easily Cleaned — Low Down Tank — Oil Bathed Ball Bearings — Easy Turning — Sanitary Frame — Open Milk and Cream Spouts.

You can have 30 days FREE trial and see for yourself how easily one of these splendid machines will earn its own cost and more before you pay. Try it alongside of any separator you wish. Keep it if pleased. If not you can return it at our expense and we will refund your \$2 deposit and pay the freight charges both ways. You won't be out one penny. You take no risk. Postal brings Free Catalog Folder and direct from factory offer. Buy from the manufacturers and save half. Write TODAY.

Albaugh-Dover Co., 2253 Marshall Blvd., Chicago, Ill.

No. 5 Over 20,000 now in use

Idaho.

Jesse S. Richards was successful in a suit in Pocatello, Idaho, for recovery of damages in the amount of \$9,200 against an irrigation company for non-delivery of water. A great many points were involved in the case, and it was preferred against the Portneuf-Marsh Valley Irrigation company. The jury returned a verdict awarding Richards \$6,640.

North Dakota.

Practically every farmer under the Federal pumping project at Williston, N. D., has used water extensively this year. This is the first season that the plant has been operated to capacity.

South Dakota.

An old engine from a Missouri river steamer is now the backbone of an irrigation plant at Forest City, S. D. It is pumping water from the Missouri river for hundreds of acres of land.

Colorado.

Water is now being brought over the divide in Colorado for irrigation purposes. It is coming from the west slope through the \$1,000,000 tunnel of the Greeley-Poudre irrigation district. The system when completed, will put water on 125,000 acres of land in the vicinity of Greeley and Purcell, Colo., and will cost approximately \$5,000,000.

All the water now being brought through the tunnel is in litigation before the United States Supreme court in the Colorado-Wyoming suit.

The tunnel is more than two miles long and takes water from the Laramie river into the Cache La Poudre and then through a system of canals.

Morgan county, Colo., irrigation systems were able to draw their water directly from the South Platte river during August. This is the first time this has occurred in thirty years.

The Jackson lake reservoir, holding 1,500,000,000 cubic feet of water, has not been touched, and the big Empire reservoir has run water only two days.

J. K. Samples, water commissioner, says that when the irrigation season closes Jackson lake will be full and other reservoirs more than half full for use in 1915. A dry winter would have little effect on crop prospects for next year, say experts.

It is estimated that 100,000 acre feet of water is now stored in the various reservoirs in the Arkansas River valley. This means good crops in that section next year, as the amount of stored water is sufficient when added to the natural flow of the river, to water the 600,000 acres under irrigation in the valley, allowing three feet to the acre.

The Water Supply & Storage company of Fort Collins, Colo., has filed an application for permission to change the storage of water in the reservoir known as Long Pond, from that lake to the Black Hollow reservoir, further east on the company's

Irrigated Lands in the West—

Offer Attractive Opportunity To the Man Who Knows How

There has been an unusual revival of interest, during the past few months, in the irrigated lands of our Western states.

This increase has been brought about not because of the economic revolution which has engulfed the old world—though that is a good reason for investing surplus money in rich farm lands—but because the keen American farmer is beginning to see that the irrigated valleys of the West offer certain profit and perfect security.

The Colonization Department of the Santa Fe Railway was organized for the sole purpose of giving those looking for homes in the Southwest and California facilities for investigating the sections that interest them. Our data has grown in volume, until today we are in position to give definite information about every part of the Southwest and California served by Santa Fe lines. This service is free.

C. L. SEAGRAVES,

General Colonization Agent

A. T. & S. F. Ry., 1100 Railway Exchange
Chicago

line. Nearly all the irrigation companies on the Poudre are made defendants. The purpose of the proposed change is not stated in the complaint.

Tentative plans for the reclamation of 500,000 acres of seepage lands in the San Luis valley in Colorado, have been made, according to Governor Ammons. The state is to have the co-operation of the federal government and owners of large tracts in the basin. The reclamation of the lands will not only double the present enormous crops of the valley but may solve the estrangement between the government and the state over the uses of the water rights of the Rio Grande, according to Governor Ammons.

Arizona.

John S. Williams and other Bisbee, Ariz., men are planning the irrigation of 1,500 acres of land southeast of Casa Grande. They will install a pumping plant. Water is obtained in this district at from 50 to 60 feet.

New Mexico.

The Urton Lake, Land & Water company will construct water storage dams and pumping plants near Fort Sumner, N. M., at a cost of about \$1,775,000 for the purpose of reclaiming about 80,000 acres of land. M. A. Otero is president of the company.

Texas.

C. F. Siegel of Sweeney, Texas, is installing a sub-irrigation system on his lands. He is laying tile in the same manner as does the Illinois farmer for drainage and believes it will serve him for both irrigation and drainage.

The Bedell Moore estate is planning to install a \$16,000 irrigation plant on the Rio Grande between Eagle Pass and Del Rio, Tex.

Land owners in the Harlingen district near Brownsville, Texas, have voted in favor of issuing bonds to the amount of \$750,000 for a public irrigation enterprise. The issue is for the purpose of purchasing the present canal system of the Harlingen Land and Water company at a cost of \$350,000. The balance will be used in improving and extending this system.

A receiver has been appointed for the San Antonio, Uvalde and Gulf railroad and for the Medina Irrigation company. Bonds of the companies aggregating \$2,750,000 are held by the Bankers' Trust company of St. Louis.

Permit has been granted by the Texas Board of Water Engineers to the Brazos River Irrigation company for a project in Jones county to irrigate 10,200 acres, the water to be taken from the Clear Fork of the Brazos river and Bitter creek.

The permit calls for the use of eighty cubic feet per second directly from Clear Fork and for the storage and diversion of 1,000 acre feet per annum from the same stream. The storage and diversion of 21,430 acre

feet per annum from Bitter creek, a tributary of Clear Fork, is also provided. The estimated cost of the project is \$225,000.

J. M. Thomas of Dallas is head of the irrigation company.

Montana.

Twelve thousand acres on the Pipestone bench, 25 miles east of Butte, Mont., have been brought under irrigation. Water is taken from Pipestone creek and a reservoir with a drainage water shed of 26 square miles in the heart of the Montana Rockies.

Work on the Flathead Indian project in Northwestern Montana is being resumed, Congress having appropriated \$200,000 to continue the work.

About 25 desert entrymen around Lewistown, Mont., have combined to

create a water supply for 10,000 acres of land. The main canal is well underway.

Signatures covering 2,000 acres have been obtained from farmers whose land lies under what is known as the "high line ditch" at Buffalo Rapids, Mont., for the purpose of creating an irrigation district.

The Bass Creek Lake Dam company, located near Missoula, Mont., has authorized an extension of the present dam to double its capacity. The lake at present covers 100 acres and the dam is 10 feet high.

The Yellowstone river is the lowest in years and at many places the irrigation ditch intakes are above the stream, so that pumping stations have had to be installed. The present (Continued on page 344.)

Saved \$7 to \$10 per M - got better Lumber

Read this letter

Hamburg, Minn.

HEWITT-LEA-FUNCK COMPANY,
Seattle, Wash

Gentlemen. — I have just unloaded my car of lumber and millwork that I bought of you, and will say that I never have seen any lumber and millwork that will compare with yours, and the saving in price is from \$7.00 to \$10.00 per M with all freight charges paid.

Yours truly,
WM. ZUM HOFE

Here's your Start toward Better Lumber

Send list for proof of big saving

Send the list you're now figuring on, to Hewitt-Lea-Funck Co. We'll give it quick and efficient handling. Every man in our estimating crew is an expert who knows lumber and knows contracting. You'll get a quick quotation, correct in every way, and right as to price, and when you get our freight-paid price, you'll know what you can save over local yard cost. You can also be sure that lumber you'll get from Hewitt-Lea-Funck, when you place your order, will be clean straight-grained, highest quality.

Grades guaranteed

Controlling through our officers the forests and mills, we guarantee absolutely the grades we sell. It's all fresh stock that nobody's had a chance to pick over. Satisfaction guaranteed or money refunded.

Speedy delivery

Seven railroads fight for our big business. We get service. We ship in 24 to 48 hours, deliver far as Mississippi River in 2 weeks. Lumber usually arrives before you're ready.

Get our Prize Plan Book — full of real homes planned for folks who work for their money. Third edition now ready. Send 10c for copy today.

Barn Builder's Guide for barn plans — Another winner is our Barn Builder's Guide. Valuable information on barn building by John H. Flemming, a contractor whose experience covers two continents. Explains Mr. Flemming's famous gambrel-roofed barn — no posts or tie rods. Sent for 4 cents.

**H-L-F
SILOS**
14x30 size
\$174.73
Freight paid to your station

**HEWITT-LEA-FUNCK
COMPANY**
471 Crary Bldg.,
Seattle, Wash.

Sending the coupon has started many farmers towards better buildings

Hewitt-Lea-Funck Co. (Write your name plainly please)
471 Crary Bldg., Seattle, Wash.

Please send the following:

- Delivered, freight paid price on enclosed list of lumber, millwork and other materials (no charge or quotation)
- Lumber Price List and Millwork Catalog (free)
- Prize Plan Book (ten cents enclosed)
- Barn Builder's Guide (four cents enclosed)
- Silo Folder (free) and Special Silo Proposition

Name _____
Street No. or R. F. D. _____
Post Office _____
State _____ Business _____

MAKE THE IRRIGATION CONGRESS USEFUL AGAIN

CONCERNING the sale of the Irrigation Congress to the Canadian land boomers, the Albuquerque (N. M.) Herald says:

"For years one of the most aggressive and most powerful forces for progress in the whole West, the National Irrigation Congress, founded here and once entertained in Albuquerque, in 1908, has fallen upon evil days. Now it is the International Irrigation Congress, has been adopted by Canada, which has a friendly way of absorbing American congresses of this character, and this year will meet in Calgary, Alberta.

"For several years the Irrigation Congress, in the eyes of the pioneers and workers who were its organizers and chief supporters through many years, has looked more like an organization maintained for the purpose of paying a salary to a secretary than for any other use which it may accomplish. As an organization of the irrigation states, organized and working to a definite end, it was all powerful; as an international organization largely devoted to discussion of the theoretical side of irrigation, its interest has waned and its influence has vanished. Resolutions passed by it are received with no more attention in Congress than would be paid to a memorial from the Friendly Islands. In the United States it has trouble finding a city which cares to entertain it, and last year it went to Canada chiefly because there was no anxious line of

communities bidding for the privilege of entertaining it on this side of the line.

"Yet the Irrigation Congress has done a great deal of work for the West. Its backing resulted in the Reclamation Service and the creation of the national policy of federal aid in reclamation. It may become useful again; its influence may return. But it will not be so until the organization returns to the irrigation states which created it, confines its activities to those states and comes down out of the international clouds of theory to concentrate upon a definite purpose."

EXCESSIVE FREIGHT RATES

Reparation Awarded

Shippers paying freight into the inter-mountain territory will be interested to know that they can now not only enjoy practically the same rates, with few exceptions, as those enjoyed by the Pacific coast terminals, but also can soon recover the excess paid above the legal rates for the past three years. This is in accordance with a recent opinion of the United States Supreme Court upholding the decision of the interstate commerce commission of July 22, 1911, which was enjoined by the railroads before the commerce court.

IRRIGATION NOTES

(Continued from page 343.)

condition is due to light snow in the mountains last winter.

California.

A new pump for irrigation purposes has been installed on the Nuevo Rancho property near Los Angeles, Cal.

The Modesto, Cal., irrigation district is preparing to issue \$610,000 in bonds, to finance improvements. The lands and water rights under the project are valued at more than \$16,000,000. Water is taken from the Tuolumne river.

The board of assessors held a hearing at Fresno, Cal., Sept. 1 on the proposed reclamation of overflow lands along the San Joaquin and Sacramento rivers. Forty million dollars will be needed to finance this immense scheme. Of this amount \$5,000,000 has been appropriated by the United States, \$5,000,000 is now being raised by the state, and the remainder, \$30,000,000, will have to be paid by the owners of the lands benefited.

Louis Clark and fourteen other landholders near Fresno, Cal., are about to sink a 500-foot well and install a co-operative pumping plant to irrigate 960 acres. It is a citrus fruit proposition.

The Oakdale, Cal., irrigation dis-
(Continued on page 345.)

The CROCODILE WRENCH

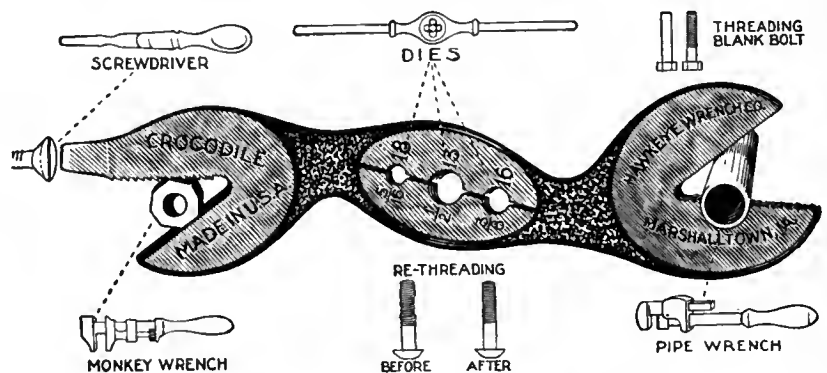

Six Handy Farm Tools in One

The Crocodile Wrench is drop forged from the finest tool steel and scientifically tempered. Every wrench guaranteed against breakage. It is $8\frac{1}{2}$ inches long and weighs ten ounces.

A pipe wrench, a nut wrench, a screw driver and three dies for cleaning up and re-threading rusted and battered threads; also for cutting new threads on blank bolts. Dies will fit all bolts used on standard farm machinery.

Teeth and dies are case-hardened in bone-black, making them hard and keen.

The dies on this wrench are tempered to wear and would be of inestimable benefit to any farmer or ranchman, as they would often save valuable time, besides an extra trip to town for repairs.

Sent free with each order for Irrigation Age for one year—price for both \$1.00; also sent to old subscribers who renew their subscription for one year.

Address: IRRIGATION AGE, 30 No. Dearborn St., Chicago

This decision will entitle shippers to obtain reparation with interest at 6 per cent for the three years affected. It is estimated that several million dollars can be collected from the railroads by shippers through competent assistance.

The roads will shortly issue new rates from the five different zones as described in the decision of the commission of July 22, 1911, and the differences between these rates and those previously in effect must be paid by the railroads on presentation in proper form of the shippers' claims.

Most shippers, however, will not be in a position to file their own claims and will find it more economical and surer to delegate some one well versed in all the phases of this particular traffic problem to recover for them on a commission basis. Shippers are familiar, no doubt, with the numerous freight audit bureaus doing work of a similar nature, but probably remember as well the exorbitant rates of commission charged usually for this kind of work.

IRRIGATION NOTES

(Continued from page 344.)

strict proposes to issue \$400,000 in bonds, to finance the construction of laterals and other improvements to water additional land. As the result of the irrigation development in this district, two schools closed since the decline of the wheat industry, will be reopened this fall.

A large dam for irrigation purposes is to be built across Oak creek, near Mojave, Cal., by W. W. Kaye and James Arp, who plan to found an agricultural settlement there. The dam will be 92 feet high and 1,096 feet in length.

After futile efforts to bring about a settlement of differences between the land owners of the Tulare basin and those of the San Joaquin delta, the California Reclamation Board has filed a suit against Laguna Lands, Limited, L. A. Nares, Lemoore Canal and Irrigation company and others.

The purpose of the action is to abate an alleged public nuisance by causing a restoration of water, which, it is alleged, has been diverted from the Kings river. It is set forth in the complaint that dams and obstructions have been built to divert the waters to the San Joaquin, and that prior to August 10, 1913, a waterway known as Zalda canal was built to carry waters of the Kings river to the San Joaquin.

It is alleged that the diversion of the waters will cause a marked raising of the flood plane in the San Joaquin during the freshet season and that thousands of acres of reclaimed lands will be endangered.

The 70,000,000 gallon reservoir of the Happy Valley Land and Water company of California, has been completed. This is the largest reservoir in Shasta county; it is for storage

(Continued on page 346.)

Therefore it will pay interested persons to be careful in selecting the bureau through which their claims are to be placed. This paper, after a careful investigation, recommends to all its readers and friends affected by the decision, the services of the Shippers' Claim Department, Chicago, which offers to handle all claims in connection with the decision to a conclusion before the commission or otherwise for the small charge of 25 per cent of the actual money recovered.

It is important that paid freight bills for the past three years be submitted for collection at once, in order to secure prompt payment of the claims immediately after the publication of the new tariff upon which they depend. Shippers will understand that no charge will be made by the Shippers' Claim Department for services unless claims are recovered from the transportation companies.

Address Shippers' Claim Department, Room 212, Boyce Building, Chicago.

International Harvester Engines Two Lines—Mogul and Titan

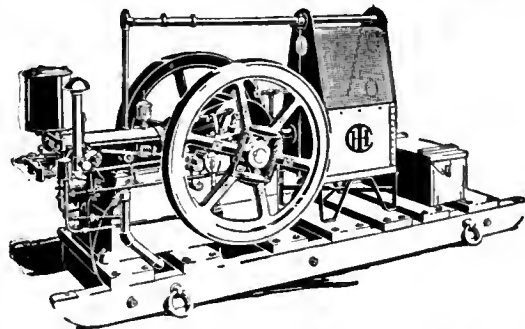

“WHICH engine shall I buy?”

If this question troubles you, a little careful observation and investigation will show that the International Harvester engines are the most satisfactory. No doubt is left in your mind when the advantages of features like the following are clear to you: Extra large intake and exhaust valves, proper distribution of weight, cylinder and piston construction, careful workmanship, prompt repair service, etc.

Ask the men who have used I H C engines. That is the best test. They will tell you of the excellence of I H C construction, simplicity, strength and durability.

Study the engines yourself at the nearest dealer's where International Harvester engines are sold. They are made in all styles, and range in all sizes from 1 to 50-H. P. They operate on low and high grade fuels.

Write for our interesting and instructive catalogues, and when we send them we will tell you where the engines may be seen. A postal will do.

THE I H C LINE GRAIN AND HAY MACHINES

Binders, Reapers
Headers, Mowers
Reels, Stackers
Hay Loaders
Hay Presses

CORN MACHINES

Planters, Pickers
Binders, Cultivators
Ensilage Cutters
Shellers, Shredders

TILLAGE

Combination,
Peg and Spring-Tooth,
and Disk Harrows
Cultivators

GENERAL LINE

Oil and Gas Engines
Oil Tractors
Manure Spreaders
Cream Separators
Farm Wagons
Motor Trucks
Threshers
Grain Drills
Feed Grinders
Knife Grinders
Binder Twine

International Harvester Company of America

(Incorporated)

CHICAGO

U S A

Champion Deering McCormick Milwaukee Osborne Plano



IRRIGATION NOTES

(Concluded from page 345.)

purposes only. The company has six other reservoirs at various points. The system is capable of watering 6,000 acres of land at a yearly cost that will not exceed \$2 per acre.

FOREIGN

Approximately 400,000 acres of land in the southern portion of Alberta will be put under irrigation by the Dominion Government, or by the municipalities, which obtain from the government the right to operate a system of irrigation in the various districts, some time in the near future, according to the statement of F. Peters, irrigation commissioner for the Dominion, with headquarters in Calgary.

It is learned from Cameron Bey, governor of Sonnar Province in the Sudan, that the new dam on the Blue Nile will be located about 160 miles below Khartum; the height of the dam had not been decided and he thought the width would be somewhat less than the dam at Assouan. If begun this summer it will take about three years to complete, as work can be carried on only during the dry season. Drillings already taken show an excellent rock foundation, although there are V-shaped fissures which will have to be overcome. The canalization would be straight with few difficulties in construction.

**Cutting
Ditches****At Much Less Cost**

This shows Mortise Ditcher and Grader doing with one man and one team as much in one day as 100 men with shovels or six teams with plows, etc.



Real Money Maker
Cuts Ditch 1200 Yds. Long and 2 Ft. Deep in a Day
Finest thing out for cutting laterals, cleaning out old ditches, grading roads, levee work, etc. Costs only one-tenth of other makes. Fool proof, lasts lifetime. 10 days Free Trial. Money back guarantee.

Write for free book, terms, etc.

OWENSBORO DITCHER & GRADER CO.
103 Allen Street, Owensboro, Ky.

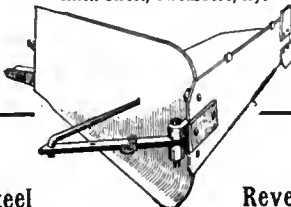
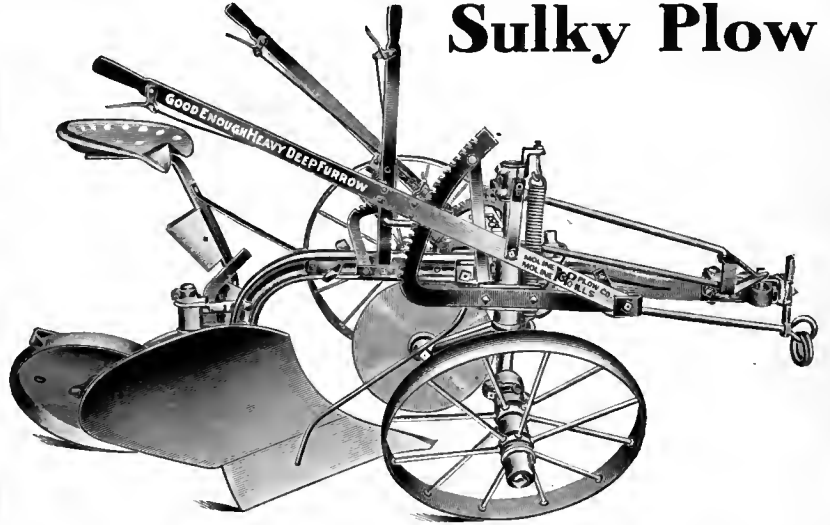
**All Steel****Reversible****GOOD ENOUGH
Heavy Deep Furrow
Sulky Plow****Save Moisture—Increase Yield**

Plow deep—form deep moisture reservoirs—increase the feeding area of the plant roots—liberate more plant food. Do these things and your crops will be greatly increased. The Good Enough Heavy Deep Furrow Sulky is the most efficient plow for deep plowing on the market.

The Good Enough Heavy Deep Furrow Sulky is a tremendously strong and powerful plow. It will plow any soil that is capable of being plowed and will turn a furrow from 6 to 15 inches deep.

The landing lever controls both the front furrow wheel and the hitch. The dial hitch can be adjusted to either side and up or down. The draft is applied directly to the beam through the heavy draft rod. The rear wheel is locked in place, but can be instantly released by means of the foot trip at the ends of the rows.

Regularly furnished with five-horse evener, rolling coulter and extra shares.

**See Your Flying Dutchman Dealer
or Write for Information**

**Moline Plow Co.****Dept. 3****MOLINE, ILL.**

SILOS ON IRRIGATED FARMS

(Continued from page 335.)

Cal., has an interesting story to tell of his experiences with a concrete silo. He says:

"We have on our farm near Dixon, Cal., the first concrete silo constructed in the Sacramento valley. It is 12 feet in diameter, 30 feet high, and holds approximately 70 tons. For eleven years we have filled this silo with alfalfa twice a year, spring and fall. During that period we have never lost a single pound of silage.

"We follow the rule of cutting the crop just a little younger than when cutting it for hay. It is mowed and hauled to the feed chopper immediately, preserving all the freshness possible. Many a load is thus stored in the silo within half an hour from the time it is mowed, and for excellence and succulence it cannot be beaten. Damp and cloudy weather frequently prevails while we are filling our silo, and the alfalfa is heavily laden with moisture. On these occasions we put up our best silage, a feed most relished by our cows. If these natural conditions do not prevail, we make a practice of running a small stream of water from a hose into the blower when filling the silo.

"In a few days after the silo is filled the fermentation is in process, the moisture may be seen oozing out around the doors and even through many pores in the walls of the silo. Our opinion is that a little moisture added to that in the alfalfa itself adds to its succulence and assists in packing it into the silo, the latter an essential which should not be overlooked. During the filling process the injunc-

tion to keep the silage built up high and well tramped around the sides of the silo should be kept in mind. There will be no spoiled or moldy silage if that practice is faithfully followed, and the silo is up to the requirements as such.

"We feed but little hay in summer, finding it more convenient to cut the alfalfa and feed it fresh from the field. The ground, by this practice, is at once cleared of the crop and ready for irrigation. By this method we are able to harvest seven and eight crops in a season, whereas it is possible to get not more than six crops where we allow our alfalfa to mature for hay. Our acreage is entirely taken up by alfalfa, and we have no land on which to grow corn, this furnishing the reason why our experience has been entirely with the former feed."

SEEKS TO PROTECT CAREY ACT MEN

GOVERNOR WEST of Oregon may call a special meeting of the legislature to meet Dec. 1, to consider the irrigation situation in his state.

"I want to see settlers get relief and I want to see the companies get justice," declared the governor. "It is impossible to get the legislature, to consider the reclamation situation at its regular session and I propose to have it deal fairly with the people who have invested money in these projects. The man who has his money invested is entitled to fair treatment.

"The Carey act projects comprise a moral obligation of the state to the settlers to see that they are not beaten out of the land on which they have settled, and that they are furnished water.



THINK what it means to you! To have at your service—day and night if desired—the combined power of 30 to 35 horses and 10 to 15 men—ready at a moment's notice to plow, disc, harrow, seed, harvest, build roads, irrigate, thresh and do numerous other power jobs, all at the minimum expense for fuel and maintenance. That's what you get when you buy a time-tried and time-proven

**AULTMAN-TAYLOR 30-60
GAS TRACTOR**

They're built with the complete knowledge of the requirements of a tractor of the first quality. They're built right here in our own shop, under our own supervision. We know they're right and we stand back of every tractor. The Aultman-Taylor 30-60 burns either gasoline, kerosene or

distillate with unequalled economy. The Aultman-Taylor 30-60 is not an experiment. Their real worth has been demonstrated on thousands of farms throughout North America. Let us explain to you why you should own and operate one of these money-making and labor-saving tractors. **WRITE FOR CATALOG AND FURTHER INFORMATION TODAY.**

We are also builders of the Famous "New Century" Separator, "Matchless" Clover and Alfalfa Huller, Steam Traction and Portable Engines, Bean Threshers and Saw Mills. Catalog free upon request.

THE AULTMAN & TAYLOR MACHINERY COMPANY

MANSFIELD, OHIO.

BRANCHES: Minneapolis, Minn.
Wichita, Kan.

Portland, Ore.
Decatur, Ill.

Lincoln, Nebr.

Kansas City, Mo.
Indianapolis, Ind.

When writing to advertisers please mention The Irrigation Age.

"INGECO" Oil Engines

These Smooth Running Internal Combustion Engines Give Unusual Service

For downright efficiency under all conditions, and on all power requirements, "INGECO" Engines stand in a class by themselves. They are built for practical service in a big engine factory in accordance with advanced standards of engine construction. They deliver plenty of power at lowest cost for fuel and in every way afford the power user maximum satisfaction.

The New Holland FEED MILL

is a
Money Saver

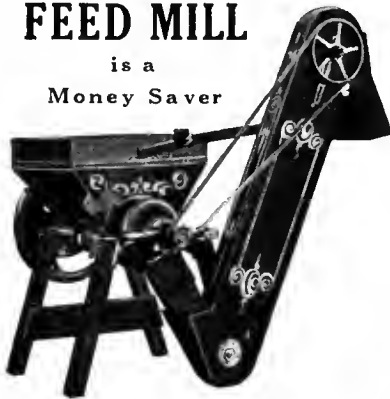

THIS light-running feed mill works successfully with small engine (1½ to 15 H. P.) at a big saving in fuel. It's a large capacity, light draft mill that grinds all kinds of feed—fast and fine. Fully guaranteed. Write for prices. We are general Northwestern Distributors for the New Holland Mill.

The "INGECO" catalogue
will interest you

All Sizes

1½ to 350 H. P.
Vertical and Horizontal—Portable, Semi-Portable and Stationary.

Give us an idea of your requirements and we will advise you on the type and size of "INGECO" Engine that will give you best results. We make prompt shipments.

perfectly on kerosene, distillates or other light oils at a saving of about one-half over present market prices of gasoline. Can be operated on gasoline also if desired. The quickest-starting, easiest running and most economical engines on the market. Uniform speed under variable loads. No complicated parts. No exposed flame.

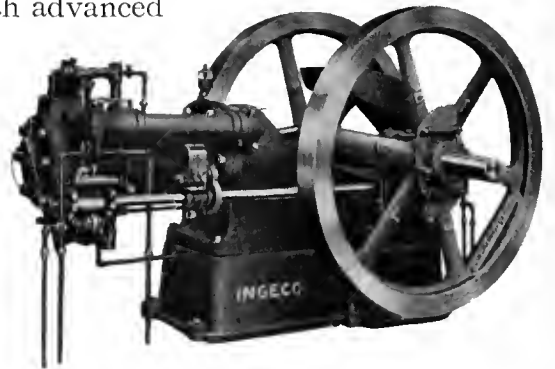

"INGECO" Farm Engines

"INGECO" Standard Oil (6 to 60 H. P.) and Kerosene Farm Engines (2½ to 15 H. P.) are engines of the "throttling governor" type—not ordinary gasoline engines fitted with make-shift attachments for operation on cheaper fuels. Work

ENGINES AND OUTFITS FOR IRRIGATION WORK

If you are considering the purchase of power equipment for irrigation use, complete plant, engine or pump, write us. We can supply your needs exactly and promptly.

INTERNATIONAL GAS ENGINE COMPANY

General Sales Office and Factory

Holthoff Place, Cudahy, Wis. (Suburb of Milwaukee)

Distributing stocks conveniently located in all parts of the U. S.

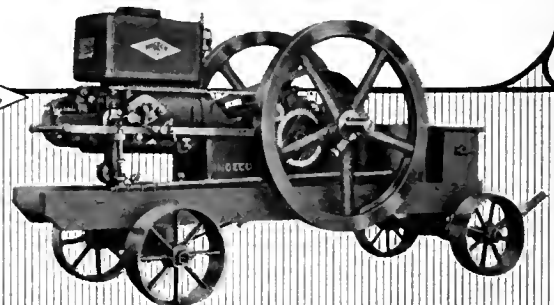
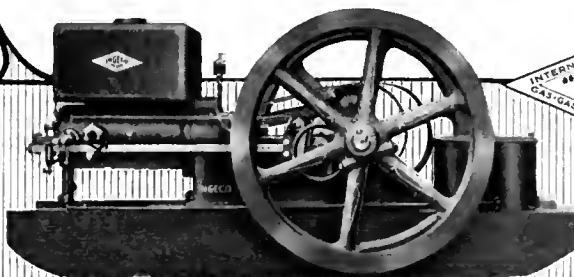

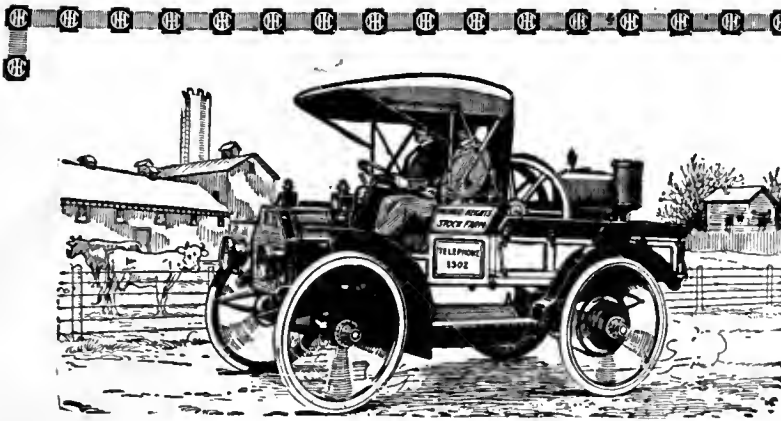

The Passing of an Aristocrat

YOUR horses demand much, need much—and get much. For instance—costly stable, rigs and sheds for them; harnesses; hay and oats, and its storage space; time spent each day in the year caring for them, feeding, watering, currying, harnessing, frequent blacksmith, harness, and vehicle repair bills; occasional veterinary bills.

All that an international Motor Truck asks for is a shed, and a small ration of gasoline and oil—that's all. And when it's not working it wants only the shed. For profit and economy buy an

International Motor Truck

You will find that it costs considerably less than horse and wagon keep, it goes four times as fast and as far as the horse, saves you many hours of time, and will run twenty-four hours in a day if necessary. In reliability, strength, and ease of management, it is best.

Solid tires eliminate common tire troubles. The wheels are high enough to give ample road clearance. The simple, sturdy motor has plenty of power. Brakes are powerful. A single lever controls the car.

It will pay you to find out all that an International Motor Truck will do for you. Write for catalogues, facts and figures to the



WESTERN BRANCH HOUSES: Denver, Col.; Helena, Mont.; Portland, Ore.; Spokane, Wash.; Salt Lake City Utah; San Francisco, Cal.

International Harvester Company of America

Chicago

(Incorporated)

U S A



The School For Your Daughter

TERM OPENS
SEPTEMBER
FIFTEEN

St. Mary-of-the-Woods

COLLEGE
AND
ACADEMY

DEGREES CONFERRED: B. A., B. S., PH. B. STRONG FACULTY

Located four miles west of Terre Haute, Indiana. Large campus, perfect drainage, commodious buildings, steam heat, electric lights, large airy rooms, many with private bath, and spacious halls, libraries and parlors. School plant consists of fourteen modern buildings, artistically grouped and completely equipped. Nothing lacking for convenience or comfort. Combining all the best features of school life with home environment on a country estate of 1,600 acres.

BOATING, HORSEBACK RIDING, SWIMMING, ARCHERY, GOLF and all outdoor athletics for girls under the constant supervision of a graduate of the Sargent School for Physical Education. School course comprises INTERMEDIATE, ACADEMIC and COLLEGIATE departments. Special courses in MUSIC, ART, LANGUAGES, DRAMATIC ART, and DOMESTIC SCIENCE. Information gladly furnished on application. A beautifully illustrated catalogue to be had for the asking. Address

SISTER SUPERIOR, Box 41,

St. Mary-of-the-Woods, Indiana



College Building

Conservatory of Music

Academy Building

When writing to advertisers please mention The Irrigation Age.

DEPENDABLE POWER FOR IRRIGATION

When you buy an engine for irrigation pumping, look first to the quality. Dependability is the all-important consideration. You can't afford to risk failure of your pumping outfit at the critical time. It will cost you less in the long run to pay what a good engine is worth.

**Lauson and
Kerosene**



**"Frost King"
Engines**

are particularly well adapted for irrigation pumping because of their absolute reliability. "Lauson" Engines are built up to a standard, not down to a price; have more drop forged and case hardened parts than any other engine on the market, and will run as true after five years' use as when new.

By using a carburetor of special design ordinary kerosene distillate is used, securing the full rated horse power as with gasoline. The cold process type of carburetor is used because it is cleaner and more efficient than the oil heating system used by others.

For continuous heavy work there is no engine on the market today that equals the Lauson. We'll be glad to submit proof without obligating you in any way.

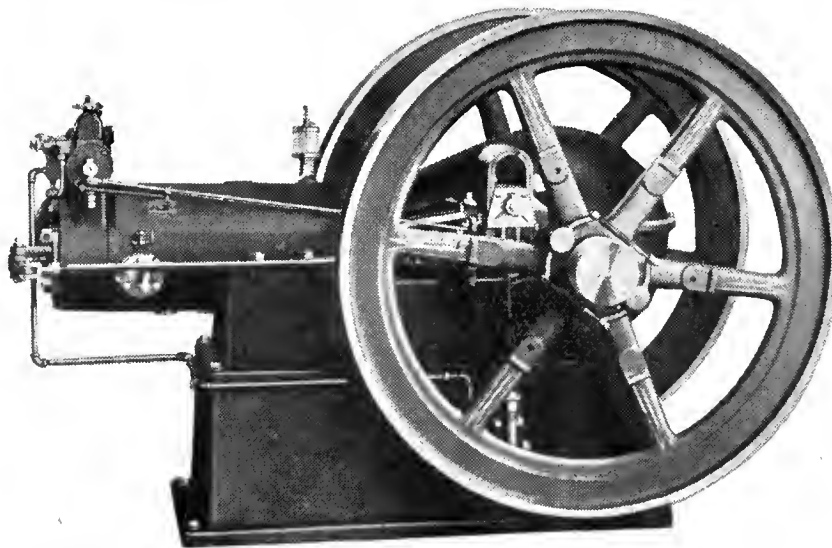

**Built in Sizes
from
6 to 50 H. P.,
Horizontal Portable or
Stationary Types.**

**80 to 100 H. P.
Multiple Cylinder
Vertical Type.**

**The
John Lauson Mfg. Co.
68 MONROE STREET, NEW HOLSTEIN, WIS.**



Purity



Permanence

Corrugated Inverted Siphon

Replacing a steel syphon which had rusted to failure.

¶ Since it has come to be generally admitted that iron resists corrosion in proportion to its purity, the results of chemical analysis have assumed a great importance. Analyses of iron and steel samples by the *carbon method* (pencil, paper and carbon) may eliminate, at very low cost, the most stubborn of impurities and establish wonderfully high standards. The methods of well equipped laboratories are somewhat different. These show today what they have been showing for years—Arco-American Ingot Iron is the purest on the market.

¶ Write the nearest Manufacturer for particulars and prices on American Ingot Iron Corrugated Culverts, Siphons, Plates, Sheets, Roofing and Formed Products.

Arkansas, Little Rock Dixie Culvert & Metal Co.	Kansas, Topeka The Road Sup. & Metal Co.	Nebraska, Lincoln Lee-Arnett Co.	Pennsylvania, Warren Pennsylvania Metal Cul. Co.
California, Los Angeles California Corrugated Culvert Co.	Kentucky, Louisville Kentucky Culvert Co.	Nebraska, Wahoo Nebraska Cul. & Mfg. Co.	South Dakota, Sioux Falls Sioux Falls Metal Cul. Co.
California, West Berkeley California Corrugated Culvert Co.	Louisiana, New Orleans Dixie Culvert & Metal Co.	Nevada, Reno Nevada Metal Mfg. Co.	Tennessee, Nashville Tennessee Metal Culvert Co.
Colorado, Denver R. Hardesty Mfg. Co.	Maryland, Havre de Grace J. N. Spencer.	New Hampshire, Nashua North-East Metal Cul. Co.	Texas, Dallas American Rolling Mill Co. Atlas Metal Works.
Delaware, Clayton Delaware Metal Culvert Co.	Massachusetts, Palmer New England Metal Cul. Co.	New Jersey, Flemington Pennsylvania Metal Cul. Co.	Texas, El Paso Western Metal Mfg. Co.
Florida, Jacksonville Dixie Culvert & Metal Co.	Michigan, Bark River Bark River Bridge & Cul. Co.	New York, Auburn Pennsylvania Metal Cul. Co.	Texas, Houston Lone Star Culvert Co.
Georgia, Atlanta Dixie Culvert & Metal Co.	Michigan, Lansing Michigan Bridge & Pipe Co.	North Carolina, Greensboro Dixie Culvert & Metal Co.	Utah, Woods Cross Utah Culvert Co.
Illinois, Bloomington Illinois Corrugated Metal Co.	Minnesota, Minneapolis Lyle Corrugated Cul. Co.	North Dakota, Wahpeton Northwestern Sheet & Iron Works.	Virginia, Roanoke Virginia Metal & Cul. Co.
Indiana, Crawfordsville W. Q. O'Neill Co.	Minnesota, Lyle Lyle Corrugated Cul. Co.	Ohio, Middletown The Ohio Corrugated Cul. Co.	Washington, Spokane Spokane Corrugated Culvert & Tank Co.
Iowa, Des Moines Iowa Pure Iron Culvert Co.	Missouri, Moberly Corrugated Culvert Co.	Oklahoma, Shawnee Dixie Culvert & Metal Co.	Wisconsin, Eau Claire Bark River Bridge & Cul. Co.
Iowa, Independence Independence Corr. Cul. Co.	Montana, Missoula Montana Culvert Co.	Oregon, Portland Coast Culvert & Flume Co.	

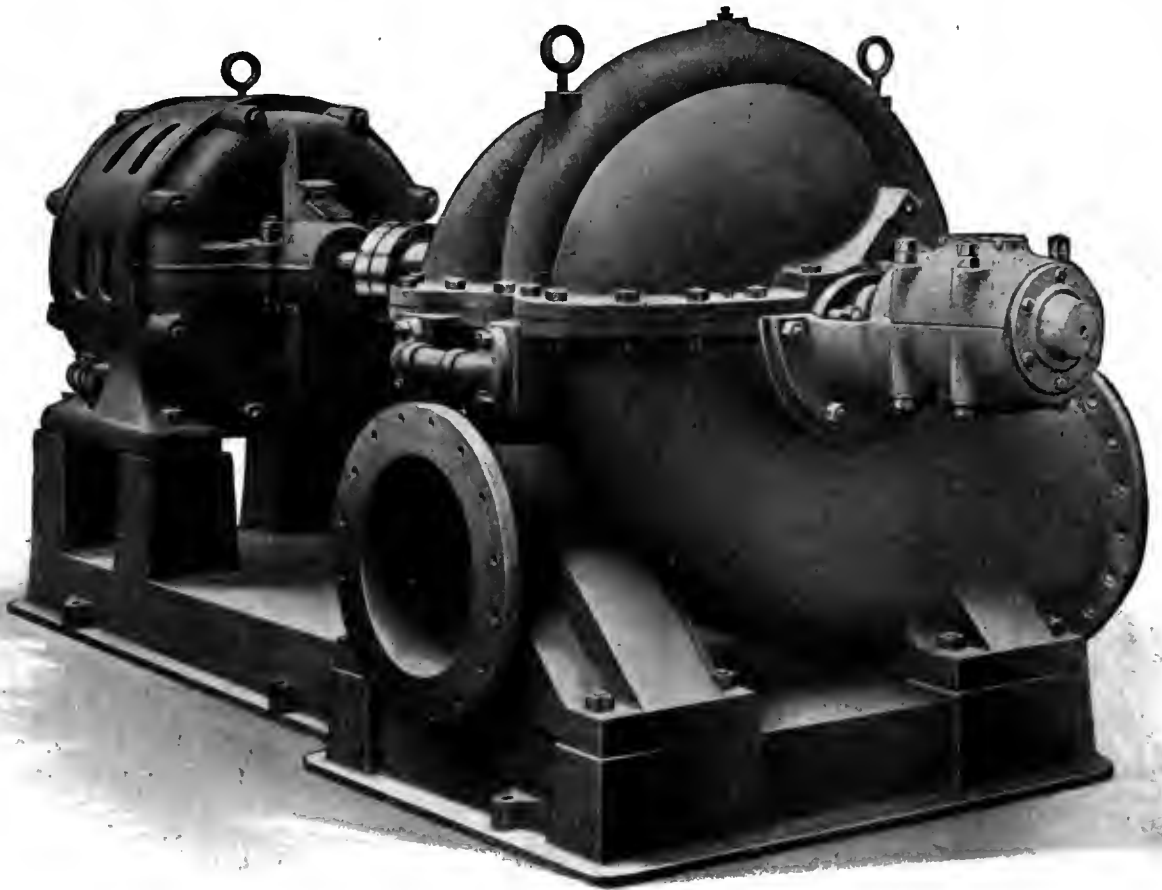

SUCCESS OR FAILURE

OF AN IRRIGATION SYSTEM
DEPENDS UPON THE PROPER SELEC-
TION OF PUMPING EQUIPMENT

WORTHINGTON CENTRIFUGAL PUMPS

ARE BUILT BY ENGINEERS WHO HAVE MADE
A CAREFUL STUDY OF THE IRRIGATION
PROBLEM—THEY REPRESENT THE HIGHEST
DEVELOPMENT IN THE DESIGN OF PUMPING
MACHINERY FOR THIS CLASS OF SERVICE.

WE WILL BE PLEASED TO MAIL UPON APPLICATION, COPIES
OF OUR CATALOGUE W202-89 AND SPECIAL BOOKLET W204-89

HENRY R. WORTHINGTON

115 BROADWAY, NEW YORK.

WORKS: HARRISON, NEW JERSEY

Branch Offices in all Principal Cities.

W271.8

IRRIGATION FROM WELLS



An Arkansas Installation. Layne Patent Screen and Patent Enclosed Line Shaft Centrifugal Pump.

With the twenty-three hundred successful working plants using our system of irrigation, which inoculates and energizes the dormant forces, there is now being produced in previously non-productive districts throughout the United States and in portions of Europe and Asia over eleven million dollars worth of FOOD PRODUCTS ANNUALLY. That our system is not an experiment is forcibly demonstrated by the fact that much of this production is from localities which were arid and barren previous to the introduction of our system.

Write for new catalog.

LAYNE & BOWLER COMPANY

Address nearest office.

The World's Largest Water Development Company

Houston, Texas

Memphis, Tennessee
Welsh, Louisiana

Stuttgart, Arkansas
Plainview, Texas

Jackson, Mississippi



SEND FOR THESE Free Books

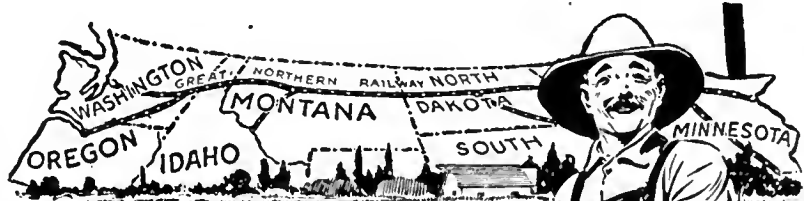

Minnesota—North Dakota—Montana—Oregon—Washington

There are big opportunities awaiting *you* in the Great Northwest—a chance to become independent on low priced irrigated land in a new and growing country. These great states comprising "The Zone of Plenty" need men of brain and brawn to develop their immense resources.

Make a Fresh Start in the Bigger Crop States

There is room in this immense empire for nineteen people where there are now but five. These beautifully illustrated 36 page books, with maps, tell all about the low priced irrigated land—its location and the easy terms on which it may be secured. They also contain bona fide experience letters from settlers who took advantage of this opportunity and made good. These books are yours for the asking.

SEND TODAY.

E. C. LEEDY, General Immigration Agent,
Great Northern Railway, St. Paul, Minn.

Please send me your free book regarding opportunities in

(Name State).....
 Name.....
 Town.....
 State.....



Learn How To Take Care of Your

"BALL BAND"^{TRADE MARK}

RUBBER FOOTWEAR

It's not while rubber footwear is being worn that it gets the most abuse—it's how you care for it after you get home and take it off, that makes it wear a long time or a short time.

For the benefit of the eight and one half million men who wear "Ball-Band" Rubber Footwear, we have prepared a booklet

"More Days Wear"

This booklet is sent free. It tells you how to treat your rubber footwear so as to get the most out of it. "Ball-Band" Rubber Footwear if rightly treated will outlast ordinary rubber footwear two to one. Send and get the booklet.

When you buy rubber footwear look for the Red Ball. It's the "Ball-Band" Trade Mark and it stands for Quality. 50,000 stores sell "Ball-Band."

Mishawaka Woolen Mfg. Co.
346 Water Street
Mishawaka, Ind.

"The House That Pays
Millions for Quality"



BUCKEYE Power Working Heads

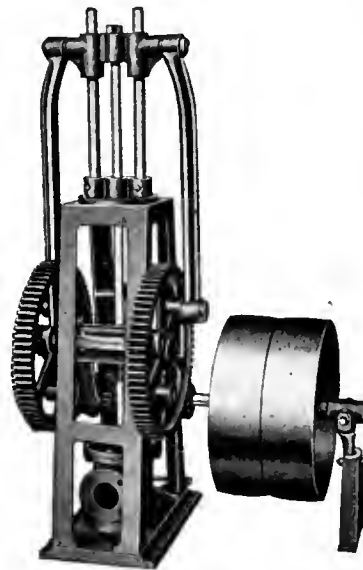

DESIGNED especially for IRRIGATION and pumping large quantities of water from deep wells.

Made in four sizes. Range of stroke, 5 to 24 inches. Size of cylinder can be varied to meet requirements of depth and diameter of well.

The frame is attached to the base of the pump so that it can be hinged back out of the way when the pump rods and valves are being removed.

Write TODAY for Catalogue R

Manufactured by

MAST, FOOS & COMPANY
SPRINGFIELD, OHIO

PAYS FOR ITSELF IN ONE MONTH



and Keeps on Saving You Money at the Same Rate Thereafter.

THE RECLAMATION DITCHER

Cuts Canals and Laterals for less than any other machinery—because it plows the dirt out with *One Continuous Sweeping Motion*.

We guarantee the cost per yard and prove it before you buy.

The J. D. Adams Mfg. Co.
Indianapolis, Ind.



Delays Pay No Dividends. Mail This Coupon Today.

The J. D. Adams Mfg. Co., Indianapolis, Ind.

Below are descriptions of our proposed ditches. What will it cost per cubic yard to make them with the Reclamation Ditcher?

Length	Width in Bottom	Average Depth	Maximum Depth	Minimum Depth	Slope of Sides	Character of Soil

Name _____

Address _____



You Need Reliable Footwear

Why not get the best your money can buy? You save in the long run

Cutter's Cruiser's and Sportman's Boots

will meet your service requirements. ¶ This is our No. 106 16" Chocolate Chrome Sporting Boot—Hand made throughout.

Send today for illustrated booklet describing the Cutter line of Driving, Cruising and Sporting Boots.

*It
Will Pay
You*

A. A. Cutter Company

Eau Claire, Wisconsin

SAMSON TURBINE



When the PUMP cannot be direct connected to the turbine shaft, the power is usually transmitted by gears, shafting, etc. On account of the HIGH SPEED of the SAMSON, for a given power, lighter and consequently CHEAPER transmission machinery can be used.

JAMES LEFFEL & CO.

Springfield, Ohio, U. S. A.

316 Lagonda Street



The Lennon Metal Flume

will never crack, leak, rot or burn. It has the lowest co-efficient of friction and therefore the highest carrying capacity of any known type. Its material is

Armco-American Ingot Iron

a material which represents the utmost durability yet achieved in iron or steel for exposed situations.

Write the nearest manufacturer for Full Information on Armco-American Ingot Iron Flumes, Culverts, Tanks, Silos, Roofing and Formed Products.

CALIFORNIA—Los Angeles and West Berkeley, California Corrugated Culvert Co.
COLORADO—Colorado Springs, Lennon Metal Flume Co.
COLORADO—Manitou, Lennon Flume Co.
MONTANA—Coast Culvert & Flume Co., Portland, Ore.
NEBRASKA—Wahoo, Nebraska Culvert & Mfg. Co.
OHIO—Middletown, American Rolling Mill Co.

OREGON—Portland, Coast Culvert & Flume Co.
TEXAS—El Paso, Western Metal Mfg. Co.
TEXAS—Houston, Lone Star Culvert Co.
SOUTH DAKOTA—Sioux Falls, Sioux Falls Metal Culvert Co.
UTAH—Woods Cross, Utah Culvert Co.
WASHINGTON—Coast Culvert & Flume Co., Portland, Ore.

IRRIGATION ENGINES

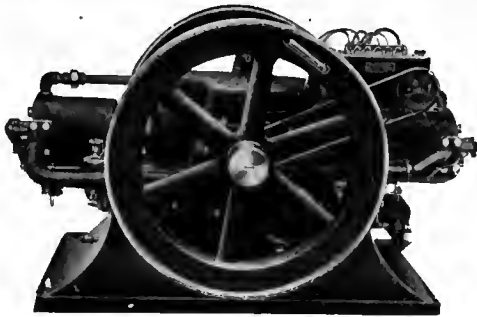

TWO CYLINDER OPPOSED

Unequalled for shops, factories, mills, mines, blowers, air compressors, electric generators and any other machinery requiring steady, regular, even power at low cost. Does not require special attachments for electric lighting work. Can be direct connected by solid coupling to generator and it will pull steady enough to burn a tungsten light without a flicker.

Heavy Foundations Unnecessary

Because lack of vibration does away with need of heavy bracing. Merely necessary to provide enough foundation to hold up its lighter weight. Requires less space than other types. Much easier to install.

TWO ENGINES IN ONE

Are provided in this engine as it can be run indefinitely on one cylinder either through choice or necessity. Provides you with an emergency power plant in case of trouble with one cylinder and keeps the machines moving without completely shutting down as required in others. Equipped to run on

Gas, Gasoline, Kerosene or Distillates.

Write for catalog "E" of
"The reliable engine with the jerk left out."

The Heer Engine Co. 2010 E Street,
Portsmouth, O.

EDWARDS REVERSIBLE 4 HORSE ROAD GRADER

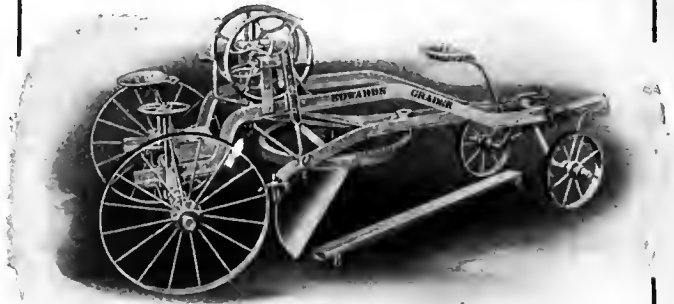

AN UP TO DATE MACHINE FOR BUILDING AND MAINTAINING ROADS

Having a complete line of adjustments it is equally well adapted for making ditches, both for dry land irrigation and rice field work.

I also manufacture THE RURAL ROAD GRADER and IRRIGATION DITCHER, STUMP PULLERS and other machines.

Write for descriptive catalog and prices.

C. D. EDWARDS, Albert Lea, Minn.

Gates and Flumes

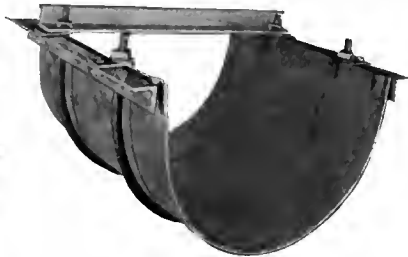

The simplest and quickest erected flume joint on the market, consequently lowest in initial and final cost. Can be fabricated in the field on large jobs, effecting a great saving in freight.

We manufacture:

- Main Headgates
- Lateral Headgates
- Gate Valves
- Metal Flumes
- Steel or Wood Pipe

We carry a complete stock of Wire Mesh and Steel Bars for Concrete reinforcement

Designs and estimates furnished on all irrigation structures and supplies.

Write us your requirements and full information will be sent.

Power Pumping Plants—Reasonable

The Fitts Machinery & Construction Co.
Main Office, McPhee Bldg., Denver, Col.

Wash and Wring With Ease

No backache, headache or tired feet. Time, labor and money saved. A tubful of clothes washed and wrung out dry in a few moments time with the

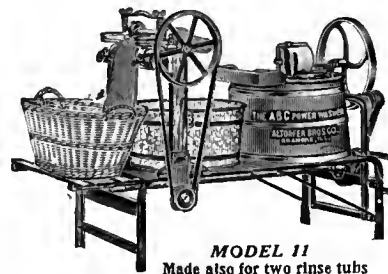

MODEL 11
Made also for two rinse tubs

A.B.C. Power Washer

Famous the world over for its marked superiority. The pioneer All Steel Adjustable Height Frame Washer with Sliding Power Wringer.

Simple, durable, low price. Guaranteed. Write for Fourteen Days' FREE Trial Offer and Illustrated Booklet.

ALTORFER BROS. CO.

Dept. 9510

ROANOKE, ILL.

THE IRRIGATION AGE

VOL. XXIX

CHICAGO, OCTOBER, 1914.

No. 12

THE IRRIGATION AGE

With which is Merged

The National Land and Irrigation Journal

MODERN IRRIGATION

THE IRRIGATION ERA

ARID AMERICA

THE WATER USERS' BULLETIN

THE DRAINAGE JOURNAL

MID-WEST

THE FARM HERALD

THE IRRIGATOR

D. H. ANDERSON

PUBLISHER,

Published Monthly at 30 No. Dearborn Street,
CHICAGO

Entered as second-class matter October 3, 1897, at the Postoffice at Chicago, Ill., under Act of March 3, 1879.

D. H. ANDERSON, Editor

ANNOUNCEMENT.

The "Primer of Hydraulics" is now ready; Price \$2.50. If ordered in connection with subscription \$2.00.

A Long and Useful Life Thirty years old. The November issue of THE IRRIGATION AGE will witness the beginning of the thirtieth year of life and work of this magazine. And what a life and a work it has been; one filled with hard struggles, with bitter fights, with some defeats and some victories. For its publisher THE AGE has acquired some unrelenting foes and thousands of life-lasting friendships.

THE AGE has weathered, during its long life, many storms, in which many another ship sank. It has steered straight toward the goal of right and justice, day in and day out, in sunshine or in storm, and today, at the beginning of its thirtieth year, it stands pre-eminent and alone in its field. Merged with THE AGE today are The National Land and Irrigation Journal, Modern Irrigation, The Irrigation Era, Arid America, The Drainage Journal, Mid-west, The Farm Herald, The Irrigator and The Water Users' Bulletin.

The last named journal became a member of THE AGE family when The National Federation of Water Users' Association made THE AGE its official organ, and this magazine with renewed vigor

SUBSCRIPTION PRICE

To United States Subscribers, Postage Paid, \$1.00
To Canada and Mexico. 1.50
All Other Foreign Countries, 1.50
In forwarding remittances please do not send checks on local banks. Send either postoffice or express money order or Chicago or New York draft.

Official organ Federation of Tree Growing Clubs of America. D. H. Anderson, Secretary.

The Executive Committee of the National Federation of Water Users' Associations has taken action whereby THE IRRIGATION AGE is created the official organ of this vast organization, representing 1,000,000 persons on the government irrigation projects.

Interesting to Advertisers

It may interest advertisers to know that The Irrigation Age is the only publication in the world having an actual paid in advance circulation among individual irrigators and large irrigation corporations. It is read regularly by all interested in this subject and has readers in all parts of the world. The Irrigation Age is 29 years old and is the pioneer publication of its class in the world.

opened its guns on the Federal bureaucracy, which has controlled the Reclamation Service for years arrogantly and with a policy of rule or ruin—rule and jobs for the bureaucracy; ruin for the hapless settlers.

In absorbing these various competitors, the publisher of THE AGE was actuated only by a desire to better serve the subscribers and advertisers. For the subscribers, and all interested in irrigation, these absorptions meant a better magazine because from each of our former competitors we acquired some ideas, features or contributors, and thus added strength to THE AGE. For the advertisers in the irrigation field, we feel we have done a service for which mere advertising rates, however high they might be placed, cannot pay. We have concentrated in one magazine the vehicle for their advertising.

The record of THE AGE is remarkable. It is one of which we feel justly proud. We have succeeded where others failed, because THE AGE is built upon solid foundations, and each year it has grown better and stronger. Each year its influence has spread. It is read today in every corner of the

world and is quoted in foreign publications as the final authority in irrigation affairs.

Since its birth thirty years ago, THE AGE has witnessed tremendous strides in irrigation. The Great American desert of our school day geographies was still a reality when THE AGE began telling the story to the world of how water only was needed to make these arid lands the richest in America. Today the Great American Desert is the food basket of the United States. The message of irrigation, carried to foreign lands by THE AGE, has brought fortune and happiness to many other peoples. Within the lifetime of THE AGE gigantic irrigation projects have been constructed in South America, Asia, Africa, Europe and Australasia, adding millions upon millions of wealth to nations, and creating homes for untold thousands.

It is worth while to have had a part in this great creative work.

The past year has been one of accomplishment for THE AGE. In the battle in behalf of the settlers on the Federal projects, we have helped accomplish much. The extension of payments for water rights on these projects to cover a period of twenty years instead of ten has been obtained. Secretary of the Interior Lane has been brought to see the dangers of the bureaucracy, which so long ruled the Reclamation Service, and has taken steps to at least neutralize it if not wipe it out. Before he gets through, we believe the Secretary will cleanse the Service thoroughly of the bureaucrats.

We hope to see justice meted out to the settlers, who have struggled to build homes on these projects. Many of them were led to settle there through reading stories of these projects in THE AGE, and we will stand shoulder to shoulder with these men and women and continue to fight for their rights as long as we have one ounce of strength.

THE AGE has been of great educational value to irrigators throughout the world—more, perhaps, during the past year than ever before. It will strive to give to its subscribers during the next year even more articles of educational value. It is the real irrigation farmers and those who want to become irrigators whom we want to help.

Despite the great war which is devastating half the world, THE AGE starts on its thirtieth year facing what promises to develop into the most prosperous era in irrigation affairs, particularly in the United States. The war means tremendous opportunities for the irrigation farmers—markets for every ounce of produce they can raise. The war makes necessary the development of every acre of

land susceptible to cultivation. This means that many projects, either embryo or partially finished, must be rushed to completion. From some investigations which we have made, we are confident there will soon be plenty of money to carry on these proposed improvements.

The development of pumps for irrigation to a high state of perfection has also made irrigation feasible and possible in many districts, previously abandoned to the prairie dogs and rattlesnakes or on which farmers struggled to make livings by conserving meager rainfalls.

Irrigation development during the next year and hereafter will be on sane lines in the United States. A commission of prominent men from the Western states will meet at Helena, Mont., this month, to pave the way for the complete elimination of "blue sky" from irrigation affairs; to codify so far as possible the various state irrigation laws and to frame measures to be placed upon the Federal statute books, which will provide for Federal and state co-operation in irrigation construction, untangle Carey Act snarls, clear up other difficulties and aid in further development of the West. We also hope to see Congress appropriate \$100,000,000, as advocated by Secretary Lane, to construct additional irrigation projects.

The next year will also witness a rapid spread of the "irrigation habit" to the central, southern and eastern states. Drouths during recent years have awakened the farmers in these sections to the possibilities of irrigation, and there are today irrigation plants in nearly every state in the union. We expect to live to see the United States veritably an irrigated nation.

THE IRRIGATION AGE looks forward with much pleasure to the work ahead. It will continue always to try to be of real value to its readers and its advertisers. To our friends, old and new, we say, "Thanks for the support in the past," and ask them to continue it. We shall try to merit this support.

If you are a Federal Water User, read every line of Fulton H. Sears' article on "The Price of Extension of Payments." Mr. Sears' reasoning is remarkable. He seems to have hit the nail squarely on the head. If he has also succeeded in penetrating to the inner secrets of the Secretary of the Interior and the Reclamation Service—virtually reading their minds—he has uncovered conditions which must arouse every Federal Water User to immediate action.

Buy a Bale of Long Fibre Cotton A large part of the settlers on the Yuma (Ariz.) federal irrigation project raised Egyptian long fibre cotton this year. They had a good crop and were in a fair way to get on their feet, when war in Europe broke out. The war has practically ruined the cotton markets of the world.

Although we have not heard any very pessimistic reports or wild calls for help from the settlers on the Yuma project, we believe the cotton growers there will be hit harder by the destruction of their market than will any planters in the South or anywhere else. This is because these settlers have little or no capital with which to harvest and store their crop, and if their bankers are like most bankers we have met in the neighborhood of United States irrigation projects, the settlers are unable to borrow any capital.

The reason that there has not been any pitiful appeal for help, such as has gone up from the Southern cotton growers, is that the Federal Water User is, in nine cases out of ten, the gamest man who lives, and ready to tax his every resource and bit of strength before he will yell "quits." And the men and women on the Yuma project are among the bravest of all the Water Users.

However, from such reports as we have obtained, THE IRRIGATION AGE believes the cotton growers on the Yuma project, and possibly in many other districts in the Southwest, need help. If you can afford it, we urge you to get in touch with some of these irrigators immediately and help them finance their cotton crop by offering to buy one or more bales of cotton from them at ten cents a pound. The Egyptian cotton they are raising is worth more than that in the open market—lots more when the markets are normal—and you cannot lose any money by buying that cotton at ten cents a pound. It will help out these settlers, steady the market, prevent speculation and you will be performing a patriotic duty.

THE AGE has not had time to get word back from the Yuma project as to whether the settlers will sell their cotton at ten cents a pound. As this is the price agreed upon among the "Buy-a-Bale-of-Cotton" clubs which are helping the South, we believe the Yuma folks will be glad to accept the help, in the spirit it is offered, and sell their much higher grade product at the same figure.

We urge you to write to Earl B. Smith, of Somerton, Ariz., president of the National Federation of Water Users' Associations, who is a settler on the Yuma project, and offer to take some of the Yuma cotton. We vouch for Mr. Smith as a clean

man and we are confident he will do everything he can, as intermediary, between you and the settlers in buying one or more bales of cotton.

Buy a Bale of Long Fibre Egyptian Cotton.

Mention The Age Next Time

It takes only an additional minute to add to your letter to advertisers: "I saw your advertisement in THE IRRIGATION AGE."

Won't you please add this line to your next letter? It will not only be a courtesy to THE AGE, but you will be performing a duty which subscribers owe to a magazine like THE AGE.

Some advertisers "key" their advertising in the hope that in this way they can trace most of the results. But even this does not allow every answer to be traced to its place of publication, because subscribers will not use the "key," but insist upon their own ways of addressing the advertisers. For this reason a great many answers to advertising are received which are credited to general publicity—and wrongly.

By telling the advertiser you saw his advertisement in THE AGE you will show him that you are interested in the magazine in which he is advertising; it will create more advertising for the publisher, and he, in turn, will be able to give you and all other subscribers a better magazine.

Make 1915 the Banner Year for Production Have you begun to figure yet, Mr. Farmer, on next year's crops? Upon your shoulders largely rests the responsibility for American prosperity during the next few years. You answer: "That's my regular job." True, the prosperity of the farmer generally means prosperity for the nation, but the truism means more today than ever before.

The great European war means that the United States must feed the world. The United States must also grow practically everything its own citizens need.

Farm products are bound to be in great demand next year, no matter what is the outcome of the war. Europe, yes, all the lands of the earth, will come to us for relief. The farmers must prepare to supply their wants.

Therefore it is well to begin now taking stock. Look over your farm carefully. Study every inch of ground. Figure if there is not some way that you can get bigger production. Work every acre of your land and work it to its full capacity. This is your opportunity.

Profit during the long winter evenings by

studying the latest methods in agriculture. We can learn something new every day and something worth while. Get your farm machinery into first-class shape.

See to it that your seed-beds are most carefully prepared. Make up your mind to cultivate your growing crops so thoroughly next year that the possibility of crop curtailment or failure will be reduced to a minimum.

Help make 1915 the greatest year for crop production in the history of the nation.

**Plenty
of Food
Being
Produced**

The widespread impression that the population of this country is increasing faster than the food supply is erroneous. This is proven by a report issued by the committee on statistics and standards of the Chamber of Commerce of the United States, located at Washington, D. C. It shows that comparisons of the first and last years of a decade may lead to unwarranted conclusions. It shows that in the decade from 1899 to 1909, the population in the United States increased 21 per cent, while the yield of cereals in 1909 was on the whole only 1.7 per cent greater than in 1899. The report points out that 1909 was a poor year for corn, while other cereal yields in 1909 showed increases as follows: Buckwheat, 32 per cent; rye, 15 per cent; edible beans, 122 per cent; rice, 142 per cent; but as corn was much the largest factor, it pulled down the whole statement of percentages so as to show only a small net increase. The report draws proper attention to the great development of sorghum grains throughout the West and Southwest, and then shows that if 1899 and 1912 are compared, corn, wheat, oats and rye show greater percentages of increase than the increase of population.

The report then takes up the increasing acreage devoted to vegetables and to the growth of fruits and nuts, showing that, as all of these are human food, they are of vast importance in the study of the future of the nation's food supply. The report also shows by a diagram that the ratio existing between grain exported and the total crop has shown very little variation, and scarcely any decline, between 1900 and 1913.

The report in conclusion makes a number of optimistic statements as to the improving methods applied to the cultivation of lands in the United States, and ends with the following words:

"The steadily broadening work of the Federal Department of Agriculture and the State Agricultural Colleges throughout the country gives assurance that we may expect a steady increase in pro-

duction per acre in the coming years. If, therefore, we survey the field in sober thought rather than the Cassandra-like spirit of prophecy, the outlook seems to be for a greater variety, increasing abundance, and a more reasonable price of food for the people."

**Newell
Again
Boosts for
Canada**

We have little use for the man who will accept a salary from one concern and then go forth and sing the praises of his employer's rival.

But where in the dictionary are there proper words to describe a man who will accept pay from his government to help develop and settle up its desert lands, and then go forth and boost for the lands of an alien nation?

Such a man is Frederick Haynes Newell, Director of the United States Reclamation Service.

Newell's name appears above an article in a recent issue of *Power Farming*, of St. Joseph, Mich. The article describes a Canadian project in most glowing, Newellistic terms, and is printed, without doubt, for the purpose of inducing American farmers and other American citizens to cross the border.

This is not Newell's first offense of this nature.

It should be his last—at least as an employe of the government.

Secretary Lane should eliminate this Canadian publicity booster from the payrolls of the United States government. He won't violate any neutrality by swinging his axe on Newell, and he will win the plaudits of thousands upon thousands of patriotic men who disapprove absolutely of the Newell type of man, and of thousands of settlers on the Federal projects who know Newell far too well.

The "Interstate Irrigation Commission" began work on the first day of this month at Helena, Mont. This commission was organized at the suggestion of Secretary of the Interior Lane and consists of three delegates from each of the arid states. The commission is to work for more uniformity of state laws on irrigation and for a solution of various irrigation project problems, through federal and state co-operation. It is a big job, but there are some very able men among the members of this body, and THE IRRIGATION AGE hopes to see it accomplish some real results.

Citizens of all political faiths in the Western part of South Dakota are working diligently to obtain a favorable vote at the November election for an irrigation amendment to the state constitution.

The Federal Water Users



A Department Devoted to the
Interests of the Farmers on the
Government Irrigation Projects

EDITED BY GEORGE J. SCHARSCHUG

THE PRICE OF EXTENSION OF PAYMENTS

By FULTON H. SEARS, of Fallon, Nevada

When Congress authorized the issuance of \$20,000,000 worth of Reclamation Certificates to provide funds to aid in the completion of the Federal Irrigation projects, a clause was inserted in the bill directing that this money should be distributed in accordance with the advice of a board of army engineers. Among the engineers named by the President to visit the projects and apportion the funds was Brig. Gen. William L. Marshall, retired. Many Water Users, no doubt, recall meeting Gen. Marshall during that inspection trip.



Fulton H. Sears, member of the Executive Committee of the National Federation of Water Users' Associations.

It was in May, 1913, that a number of Water Users, who had gone to Washington to confer with Secretary of the Interior Lane concerning needed legislation, again met Gen. Marshall. The general had been appointed consulting engineer to the Secretary of the Interior at a salary of \$7,500 a year.

One of us asked the doughty old general what he thought of the large gathering of Federal Water Users, who had come in response to the Secretary's invitation.

"A lot of — — farmers, seeking to repudiate their obligations to the government," was Gen. Marshall's reply.

The Water Users are to meet Gen. Marshall again—this time as a member of the supervisory board, which will be the final court on the revaluation of the projects. He is one of the three members appointed by the Secretary. This board is instructed to consider the reports of the various project revaluation boards, "and to definitely and finally estimate and determine the cost of construction of each of said projects, or units thereof."

Federal Water Users still have faith in their government. Notwithstanding odious conditions imposed upon them by the Reclamation Service, misrepresentations of conditions on the projects

and the overbearing, cold-blooded, Czar-like attitude of the bureaucrats who have ruled the destinies of the Water Users, the confidence in the final justice, integrity and fairness of their government is still unshaken among the settlers. That is why they have fought almost unbearable conditions bravely and silently, with little or no complaint.

Now the costs of the projects are to be fixed for all time. There is an item of something like \$40,000,000 involved—money expended on these projects in various ways, but producing no benefits to the settlers.

Who is going to pay this bill?

The original Reclamation Act provided that the estimated cost of the projects should form the basis of payment for water rights by the settlers. In accordance with this law of 1902, contracts were issued to settlers, specifying the amounts which they must pay per acre for their water rights. The settlers felt that the price named in their contract would govern finally the amount they would be required to pay, notwithstanding future estimates or costs. That was, as lawyers say in describing a contract, the "meeting of the minds."

This evidently is also the view of Secretary of the Interior Lane, for in his public notice of September 24 concerning the extension act, he states specifically that present contracts are to be recognized and there shall be no increase in the cost of water rights to settlers holding such contracts without the consent of the settler. The notice provides further that those who desire to come under the terms of the Twenty Year bill must make application, which includes consent to abrogation or revision of water right contracts now held.

In plain English, then, those who desire to extend their water payments over twenty years must

agree to pay any increased charges which may be fixed as the result of the project revaluations. Those who can handle their payments within the ten years allowed under the original Reclamation Act will pay such an amount as is provided in their present contracts.

No one can say offhand just what the increases in charges will amount to, but that they are liable to be very large is conceded on all sides. It is a well known fact that the costs of practically all the projects were underestimated and the area of irrigable land, suitable for agricultural purposes, was overestimated.

The Secretary's notice also announces that in the future there shall be two classes of water payments—those for construction and those for operation and maintenance. This seems to eliminate the betterment charges, which have been used by the Reclamation Service to cover excessive additional charges in some projects.

Secretary Lane should be commended for his recognition of the present contracts and for his elimination of the betterment "joker." He must also be commended for stating his order plainly and clearly—something exceedingly rare in Reclamation Service documents.

The Secretary's two orders, the first concerning the revaluation boards, and this second one in regard to water payments, are both so general in terms that there is much of conditions which he must meet and comply with at which the settler can only guess.

The price which he must pay for an extension of time in which to pay for his water, is but one of the riddles.

It is therefore to the interest of every Water User that he become thoroughly acquainted with conditions, the Secretary's plans and the purposes of the revaluation, as it concerns him, before he rushes in madly and agrees to abandon his present contract. The Reclamation Service can and should do much to enlighten the settlers. The Water Users' Associations should make it their business to inform each settler fully upon these great questions.

In order that the associations can do this in a competent manner there should be a conference of delegates from the various projects, at which the revaluation and the extension bill could be fully discussed. Secretary Lane, Comptroller Ryan, Legal Adviser King and the supervisory board on revaluations should be invited to attend and to elucidate fully their plans. The Water Users must be fully informed that each may know how to act for his best interests.

I earnestly urge an early meeting of the National Federation of Water Users' Associations and of the unaffiliated associations and various other organizations of Water Users at an early date. Ogden, Utah, has offered to entertain such a meeting. The Executive Committee of the National Federation has had some correspondence concerning a date for such a meeting, but none has yet been set.

What do you think about it, Mr. Federal Water User? Stir up your local association and your fellow Water Users. We must act now or accept whatever conditions the Department of the Interior and the Reclamation Service chooses to impose upon us.

RAISES CORN FOR SILAGE IN THE UNCOMPAGHGRE

D. J. SCHAMBACH is the hero of the hour on the Uncompahgre project in Colorado. Not only has Mr. Schambach erected the first metal silo in the project, but he has also raised 30 acres of corn this year. The silo has a capacity of 305 tons, and the cornfield is expected to furnish food for sixty cows for a period of nine months.

More corn will be planted next spring by other farmers and a number of silos will be erected as the result of Mr. Schambach's experiments.

"The silo is the solution of the dairy business in the Uncompahgre valley," said Mr. Schambach. "I have studied the dairy business for a number of years for the purpose of finding out why the dairyman as a rule usually went broke unless he got out of the business before such a calamity befell him. I soon became convinced that one of the principal troubles was in the feed. In the first place, it cost the dairyman too much, and in the second place, the kind of feed being used did not bring the maximum results. No dry feed can take the place as a milk producer of the green food, and I soon concluded that the silo represents in a large measure the difference between success and failure in the dairy business."

DO STATES OR U. S. OWN WATER ?

The transcript of a case which is expected to settle the question of whether the federal government or the various states own the unappropriated waters within their boundaries has been filed in the Colorado Supreme Court by Ethelbert Ward, special assistant to the attorney-general of the United States.

The suit is called the "United States, plaintiff in error, versus the Palisade Irrigation District Company and others." It began in 1908, growing out of a dispute over the waters of the Grand river.

The government claims that it withdrew, in connection with the Grand valley reclamation project, 1,200 feet of these waters from further appropriation in 1902. Since that time further appropriations were made by private companies under the state laws.

The United States brought suit at Grand Junction against the state in 1912, and was awarded a priority dating from 1908. This did not satisfy the federal authorities, who claimed a priority of right over the water dating from 1902.

\$1,000,000 IN CROPS BURNED UP BY RED TAPE

Cold Blooded Policy of F. H. Newell Scored by Nebraska Man

By WALTER v. HOAGLAND

ON June 7, 1902, the Federal Congress passed the Reclamation Act which provided for the loaning of the public lands fund of certain western arid states for the construction of irrigation projects in the arid states to irrigate the government lands. The Reclamation Service was organized and one of these projects was started by the construction of the Pathfinder Reservoir in Eastern Wyoming, for the conservation of the waters of the North Platte River for irrigation purposes. The Reclamation officials set aside three tracts of land situated in the state of Wyoming and Nebraska for Reclamation. One is known as the Interstate Canal, irrigating a tract of land consisting of 129,270 acres, north of the North Platte River in Scotts Bluff County, Neb. There was a second project contemplated, known as the Fort Laramie unit, consisting of about 100,000 acres in Wyoming and Nebraska on the south side of the North Platte River; the third project contemplated was a large tract of land known as the Goshen Hole unit.

The Reclamation Service constructed their Pathfinder reservoir, holding a capacity of more than 1,000,000 acre-feet of water at a total cost of \$1,794,365.94. The Inter-State canals, reservoir and irrigation works have been constructed for irrigating the 129,270 acres at a total cost to the government of \$4,909,793.34. These figures are official and were given me by the project engineer. The government is collecting from the settlers under the project the sum of \$55.00 per acre or something more than \$7,000,000.00, if all of the land under the canal is taken and paid for. This would net something more than \$300,000.00 more than the total cost of the irrigation works



Walter V. Hoagland, of North Platte, Neb., chairman of the judiciary committee of the State Senate of Nebraska, and republican candidate for Lieutenant Governor of Nebraska.

and Pathfinder reservoir combined. The Secretary of the Interior estimated when they started the project that the land could be watered for \$35.00 per acre, but this cost has been increased by \$20.00.

Reclamation officers have abandoned the Goshen Hole unit because their estimates of the cost of construction are so great as to make it prohibitive. The officials are now attempting to get the settlers owning land under the Fort Laramie unit to place all of their lands in trust under the control of the Secretary of the Interior for the construction of that project at a cost of something in the neighborhood of \$75.00 per acre, but the conditions are so harsh that it is difficult to get the owners of the property to place their property outside of their own control, and but a small percentage have signed the trust agreement. If this project should succeed, there must necessarily intervene a number of years before any of the water from the Pathfinder Reservoir can be used upon any of this property.

The records of the flow of the North Platte River show that in the years of the greatest scarcity of water in the North Platte River the government can impound in this reservoir from the flood waters not less than 600,000 acre-feet of water and in years of plenty, the maximum flow shows that the government, if the reservoir was large enough, could easily impound more than 2,000,000 acre-feet of water. On June 25, 1914, the government had actually impounded in this reservoir from the flood waters during the past year 1,093,280 acre-feet of water. This was the full capacity of the reservoir and the government kept the quantity of storage above 1,000,000 acre-feet until July 16, 1914.

Mr. Andrew Weiss, the

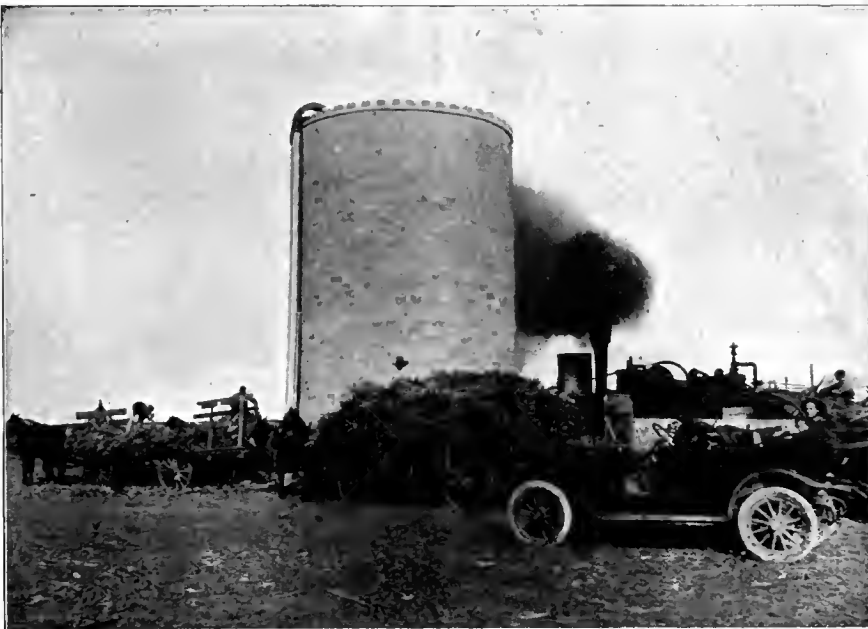

Filling a Concrete Silo with Kaffir in Texas.—Courtesy of Santa Fe Railroad.

project engineer, says that during the present season there are 57,000 acres of crops under the Inter-State unit, and that he figured $2\frac{1}{2}$ acre-feet of water per acre of land. This would require a total of 142,500 acre-feet of water for use this year on the Reclamation project; and for which the government officials filed water appropriations in Nebraska and Wyoming. The Reclamation officials have also contracted for impounding rights in this reservoir with the owners of private lands for 88,500 acres of land in Scotts Bluff and Morrill counties, Neb., which Mr. Weiss says will take an additional 143,500 acre-feet of water. On these latter contracts, the government is to receive about \$750,000. Under these contracts the government merely turns the water loose from the reservoir and the private ditches are compelled to rely upon the State Board of Irrigation of Nebraska to have the water turned into their ditches.

When the government is applying water upon all of the 129,270 acres under the Inter-State unit it will not require in excess of 300,000 acre-feet from the reservoir. The Reclamation officers are charging \$5.00 per acre-foot for the water in the reservoir and if they are permitted to sell the balance of the capacity of the reservoir, or at least about, 750,000 acre-feet, the government will receive an additional sum of about \$3,750,000.00, which will be clear profit on this project, if the government is permitted to collect the full sum of \$55.00 per acre from the farmers on the Inter-State unit. In addition to this, after the agitation was started the present year, the service started to sell temporary water from the canal for this season at 30 cents per acre-foot, which will still more increase the profits to the government.

The appropriators of water for irrigation purposes from the North Platte River extend from the

Wyoming line on the west for a little more than 300 miles east along the river, and it requires some time for the water to flow from the reservoir to the east end of the irrigated territory at Kearney. This is variously estimated at from 12 days to a month, according to conditions of the river and the volume of the water. The records show that by reason of the impounding of water by the government in its canal as late as July 9, 1914, the river in Nebraska went

dry at Kearney, on July 14, 1914, and the Kearney Canal had no water although it had the second right on the Platte river, and the company was compelled to operate their power plant with coal. The records of the Kearney Power Company show that during a period of 1,406 days, covering irrigation seasons of seven months each, between July 1, 1901, and May 1, 1905, this company was operated but 51 days on steam. However, since the construction of the Pathfinder reservoir, this company has been deprived of water as long as five months at a single time, covering the months of the irrigating season, when the river, prior to the construction of the dam, had



Small irrigation plants in Idaho and Utah—587GC is a pumping plant made up of a 9 H. P. Vertical Oil Engine and 3-inch Vertical Centrifugal Pump. This pump is in a 60-foot pit. Plant at Lehi, Utah. 591GC is a plant located at Springfield, Idaho. This consists of a 3-inch Vertical Centrifugal Pump being driven by a 2 H. P. engine, delivering 350 gallons per minute into the irrigation ditch. The engine is mounted on a farm wagon and can easily be moved to other wells or used for other power purposes. 584GC is located near Bountiful, Utah, and consists of a 4 H. P. engine with walking beam operating a 6-inch cylinder at a depth of 72 feet. 564GC is located at Layton, Utah, and consists of a 5 H. P. Motor driving a 5-inch Centrifugal Pump which delivers about 800 gallons per minute into the flume.—Courtesy of Fairbanks-Morse & Co.

never before been known to go dry. These are facts beyond dispute.

Until the year 1910, the Reclamation officials permitted enough water to flow in the river in addition to the natural flow to furnish water for the irrigation ditches and made no attempt to collect compensation for the water. Since that time the government has refused to turn down any water during the irrigating season except what the people would pay for, but after the irrigating season was over, the Reclamation officials have each year permitted the water to flow down the river and go to waste. They claim this was done because they had to empty the reservoir in order to permit repair work on the gates.

One question which the citizens of Nebraska have been asking themselves is why is the government not willing to let the water go down the river during the season of the year when it will benefit the people and not wait until the crops have been destroyed by the sun's rays.

Since 1910, with a capacity of only 142,500 acre-feet of water for its own lands and less than an additional 150,000 acre-feet for use upon lands where water was sold, the

government has been storing each year from 700,000 to 1,000,000 acre-feet of water for which it had no beneficial use and has stood by and watched more than a million dollars' worth of crops burned up each year for want of water while the Nebraska State Board of Irrigation was compelled to shut down the head gates of the irrigators in Nebraska.

In addition to this it is well known that when the water is in the river there is not only an evaporation for rain, but also a raising of the water table in the valley adjacent to the river, so that the valley crops can get moisture from subirrigation. When there is a dry bed of sand one-half mile wide and 200 miles long, the hot winds blow across the sand, cook the crops and draw all of the moisture out of the ground, prevent the few local showers that we do have from crossing the river, and lower the water table in the adjacent land so that the crops dependent upon rain and subirrigation are destroyed.

The people are now up in arms along the river and are demanding that the Reclamation officials at Washington cut out their red tape and solve the problems of the Platte river watershed in some equitable manner that will permit the conservation and beneficial use of the large amount of water in the Pathfinder Reservoir.

Frederick H. Newell, the Director of the Reclamation Service, has in the judgment of our people pursued a cold blooded policy of using the funds of the Reclamation Service for the purpose of perpetuating the Service at the expense of and by the exploitation of the people.

From the investigation which I have made, the general opinion of the people, not only in Nebraska, but in all of the states where the Reclamation Service is operating, is that there are no red corpuscles and no red blood running in Mr. Newell's veins. We have never been able to get a single concession from Mr. Newell and have always been required to go beyond him in order to get humanitarian methods applied.

It is almost inconceivable, in this day and age, that it can be said the administration of our Federal Government at Washington would tolerate a policy which permits its officials because it has wrongfully squeezed \$4,000 out of a few ditch companies this year for temporary water, at 30 cents per acre-foot, to stand by and see a million dollars in crops burn up on



Picking Fruit in a Utah Orchard.—Courtesy of Rio Grande Railroad.

the so-called equitable claim that it is not fair to let all the people have water when they have squeezed a few pennies from a part of the people. This is Mr. Newell's policy and to the astonishment of our people who have always held Secretary Lane in the very highest esteem, it seems to have the endorsement of the secretary himself.

Our congressman, M. P. Kinkaid, introduced a resolution in the Federal Congress requiring the release of this water for the

benefit of our people, and Secretary Lane by the use of the powerful influence of the Interior Department, according to the reports of Congressman Kinkaid to us, prevented the passage of the resolution. Therefore Secretary Lane is morally responsible for the cold-blooded, inequitable, unjust and illegal administration of the waters in the Pathfinder Reservoir. On the very day that Mr. Lane by his influence got the Congressional Committee to refuse relief, the department, after we were without water for three weeks and when it would take a couple of weeks more to get the water to Kearney, ordered the release of an additional 1,000 second-feet of water. It was estimated that this would keep the river flowing and all of the ditches supplied. The red tape of the department cost us a delay of three weeks to give the federal officers time to send a man here to investigate and get his reports to Washington and then it took about two weeks, when the irrigation season was over, before we got the water. This illustrates the methods used at Washington by the Interior Department and while the department got water to the power company at Kearney, the crops of our irrigators are lost. The sun kept up with its deadly work of burning the crops while Newell and Lane and the Interior Department were unwinding red tape and squeezing our people.

Secretary Lane sent Mr. I. D. O'Donnell, the Supervisor of Irrigation, to this territory and after I had made a statement of the conditions, Mr. O'Donnell stated to our party that he believed that I was eminently fair in my attitude for a permanent solution of this problem. I took the position that the people were willing to pay to the Government their equitable share of the cost of the construction of this reservoir, but they did not propose to be held up by the Government officials and that while the Government was furnishing a permanent solution of the problem, the Government ought to permit some of the surplus waters to flow down the river so that the people who had constructed ditches to the river could have water for their

(Continued on Page 370)

Send \$1.00 for 1 year's subscription to the IRRIGATION AGE and bound copy of THE PRIMER OF IRRIGATION. If you desire a copy of The Primer of Hydraulics add \$2.50 to above price.

FIX STANDARDS FOR YOUR FARM PRODUCE

The Community Which Cooperates Is Certain to Attract Buyers

By W. C. PALMER

North Dakota Experiment Station

THE lack of standardization in farm products makes the marketing of them expensive and difficult. The market demands standardized products and too often gets it in this way: Some one buys the varied products that the farmers bring in, and out of the assortment tries to make grades and classes so far as possible, and then it is impossible to make much of any quality out of it. It requires considerable work and there is necessarily much waste. Considerable risk is taken; this all means that the price paid must needs be low in order to make enough margin to pay for all the work, the waste, the risk, and to leave a profit.

It would take but little more work, and perhaps less, for the farmers of a community to plan together and to produce considerable of one thing, and that of a good quality. Then the product would be ready for the market when it leaves the farm. This will bring the farmer a better price. It has cut out the need of the middleman, whose job it has been to get the stuff ready to market.

This is a community problem. To make it effective a number of farmers must produce the same thing and all of the same quality, and prepare it for market in the same way. Each farmer must stand back of his product, must guarantee it so that all the produce coming from this community is standardized and guaranteed. This will bring the market to the community, and this community will be ahead of all other places not so organized in producing.

A community in which each farmer grows a different kind of potato, and some mixed kinds, will never attract potato buyers; in fact such products will be hard to sell at any price. On the other hand, the community in which the farmers grow the same kind and quality of potato will have the market come to it. The cost of production would be no more in the second case than in the first; in fact the community that is planning and working together can produce the potatoes cheaper than the community in which community concert is lacking.

The above cut was made from a Northern Pacific Ry. photograph.

The community which breeds one-kind of cattle, or one kind of any other kind of stock, will attract buyers, while the community that breeds no particular kind of stock, or has several kinds, will have to hunt for a market, and when it finds the market it will not have the prestige of the other one. The stock can be produced cheaper, too, where several are raising one kind.

The buyer who wants to pick up a carload of cattle and has to visit 10 or 15 herds scattered over a state, will use up a couple of weeks' time and pay out a lot of money for livery and hotel bills in visiting the herds, and then if he finds one or two animals at each place it will be expensive and take a good deal of time to get them all together. On the other hand, if the ten or fifteen herds are located in one place he could visit them in one or two days and in three days' time he could have them bought and all loaded on a car



One-year-old apple orchard in the lower Yellowstone government project in Montana and North Dakota.

ready for shipping, while in the other case it might take three weeks or even more to accomplish the same thing.

New Salem, N. D., and Northfield, Minn., are good examples of communities that are planning together in producing Holstein cattle.

The fruit growers of the West have organized so they can standardize and guarantee their fruit. They are so well organized that they can keep poor varieties from being planted in their community. The result is that a box of a certain kind and grade of apples can be duplicated year after year, and the quality can be depended on. It is on this point that the Western fruit growers are in command of the market even in the East, where there is more fruit grown, but little community planning, standardizing, and guaranteeing.

To make the most of the opportunities in any community it is necessary that the members of the community, or a number of them, plan together in their production; that they agree on some one thing or a few things; and that good and uniform quality be produced, such as the market wants. Then stand back of the goods, guarantee them. The community that will do this can keep the cost of production down to a minimum, and sell its goods at a premium.

EVERY IRRIGATOR SHOULD HAVE A GARDEN

By **FRITZ KNORR**

Superintendent of the Nebraska Agricultural Station at Scotts Bluff, Neb., on the North Platte Federal irrigation project.

NO part of the irrigated farm will bring better results in money actually saved than the kitchen garden. To have a large supply of good fresh vegetables always on hand during the summer season to furnish an abundance of cheap and wholesome food for the family is a problem that should receive more consideration in the farm home. The fruits of the kitchen garden should not be limited to summer use. In addition to this, nearly all the vegetables grown may be preserved in some form for winter use, making it unnecessary for the farmer to purchase canned vegetables.

The canning of garden stuff has often been thought a difficult problem and something that a farmer's wife could not undertake. With the guidance of some of the bulletins issued by the Department of Agriculture any woman may soon learn to can successfully any of the common vegetables.

Lack of gardens is more apparent in the West than in the East. The reason advanced is that a garden requires "the best piece of land on the farm" and "considerable time and money." It does require some time and a little money to have a good garden, but the actual expenditure of either time or money is not large. The largest cash outlay is for two or three hotbed sashes and a hand cultivator.

Experiments at the Scottsbluff, Neb., Agricultural Station have demonstrated that with little expense the garden can be planned to supply an abundance of cheap and wholesome food for summer and winter use.

At an elevation of 4,100 feet, thirty different kinds of vegetables have been successfully grown in the garden at the Experiment Farm.

A garden of one-third to one-half acre should be large enough to supply the average family with all the vegetables required and with some small fruit as well.

Plant small amounts of the various vegetables and make several plantings during the season.

If possible, protect the garden with a wind-break.

Only well-decayed stable manure should be used for fertilizer, and then as a top-dressing



An Irrigator's Kitchen Garden at Alamosa, Colo.

put on in the fall.

Care must be used in irrigating the different vegetables in order to secure the best quality and flavor.

A little care in gathering seed will cut down the seed bill the following spring as well as improve the vegetables from year to year.

Asparagus requires rich, well-prepared soil.

By withholding water until the pods begin to set and then forcing a growth a much

earlier crop of beans can be secured.

Beets do not keep long in storage, and therefore should be canned during the summer. The smaller the beet, the more tender.

Brussels sprouts should be grown only for summer consumption.

For early varieties of cabbage, the Early Wakefield and Winningstadt have proved the best. The same is true of the Danish Ball Head as a late variety.

Bleaching cauliflower will produce better flavored heads than growing them in the open.

Carrots should be so irrigated as to be kept in a good growing condition.

Swiss chard has proved worthy of a place in the garden.

There is no danger of giving celery too much water.

It is better to under-irrigate than over-irrigate for early corn.

Planting cucumbers in continuous rows insures fruit from one to two weeks earlier than the hill method.

Lettuce should be kept growing rapidly to insure tenderness.

Growing onions from seed is cheaper and the results are as good as when grown from sets.

For varieties of peas, Premium Gem, Nott's Excelsior, and British Wonder have given the best satisfaction.

For early potatoes, plant seed that has been sprouted.

Rhubarb should have a place in every garden.

Over-irrigation of squash produces a rank growth but little fruit.

Failure to secure a good crop of tomatoes is due more to over-irrigation than to anything else.

Watermelons and cantaloups can be grown in abundance, but only early varieties should be used.

The GRIMES

**The Pump
that You Will
Eventually
Buy—So Why
Not Save Your
Experimental
Expense?**

**The Sooner You
Install a GRIMES,
The Sooner You Will
Begin Reducing
Your Pumping Costs
and Solve Your
Pumping Problems**

**Screw Principle—
the Archimedian
Effective Use of
This—a simple but
Well—Just Like
Ditch, Stream or
Water from Lake,
It Raises the**

**Moderate Initial Cost
Requires Very Little
Attention**

**Cannot Get Out
of Order**

**A Durable, One-
Piece Machine**

**Unaffected by Sand,
Gravel or Mud
Conditions**

**Always Ready for
Instant Use**

**Can be Operated
With Any Form of
Power Available**

**Low Power
Consumption**



Irrigation Pump

Loveland, Colorado,
August 15th, 1914

The Grimes Irrigation Pump Company,
Denver, Colorado.

Gentlemen:

It gives me pleasure to advise that the 40" diameter Grimes pump you installed for me is doing everything you guaranteed it would do. I am elevating more water, to a height of 34 feet, than my 8" pipe will carry under pressure with an 8 horse-power engine.

When operated to the full capacity of the engine it requires a 12" pipe to carry off the flow.

I see no reason why this pump should not give me good service for a number of years as it is certainly made to last.

I believe you will make a large number of sales in this immediate vicinity as the pump is attracting the attention of the farmers for quite a distance around.

If you have any prospective customers, who will want to know what I think of this pump, if they will write me, I will be glad to tell them all they want to know.

Very truly yours,
W. W. NICHOLS.

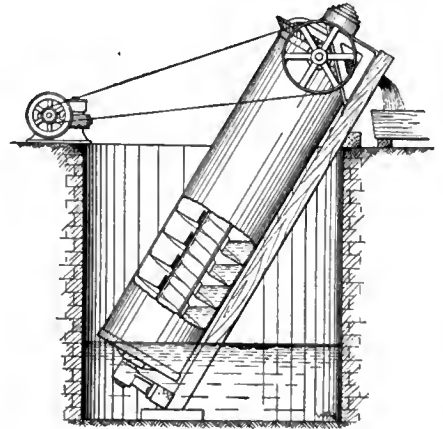

**The GRIMES Pump
Will Lift a Given
Quantity of Water
to a Greater Height
With Less Power
Than Any Other
Water Elevator
on the Market.**

**WE CAN PROVE THIS
BY OUR MACHINES'
RECORDS WHEREVER
INSTALLED.**

**EACH PLANT BUILT TO ORDER TO MEET
VARIED INDIVIDUAL NEEDS AND CONDI-
TIONS. ESTIMATES GLADLY FURNISHED.**

Fill Out Mail TODAY 

The Grimes Irrigation Pump Co.

**1022 First National Bank Building
DENVER, COLORADO**

**THE GRIMES IRRIGATION PUMP CO., 1022 First Nat. Bk. Bldg.
Denver, Colo.**

Gentlemen:—
 (My Name is).....
 (Post Office)..... (State).....
 (Nature of Water Source).....
 (Volume of Supply).....
 (Ac. to Irrigate).....
 (Height of Lift)..... ft.
 (Power)..... H.P.
 I-7-A.
 9-14

RED TAPE BURNS UP \$1,000,000

(Continued from Page 365)

crops and that it was not morally right for the Government officials to use its power to squeeze the people because of their necessity for water and make them pay an exorbitant price and thus destroy millions of dollars of crops each year while arriving at the solution.

The course of the Reclamation officials appears more inequitable when the Government's legal rights are considered and when it is clear from consideration of elementary principles of law that the Government is not entitled, as a matter of law, to sell this water.

The Reclamation Act itself does not provide for the sale of any water, but merely provides for reimbursement from the Government projects to the public land funds. It is an elementary principle of law that there is no private ownership in the public water; that the use of waters is an appurtenant to the riparian owner, and the regulation and control of waters is exclusively in the states and in the State Government, and is not in the Federal Government; and that Federal regulation and control of the waters in the Interstate streams is prohibited by the Federal Constitution.

The Reclamation Act itself recognized this principle by Sec. 8 of the Act, which says:

"That nothing in this act shall be construed as affecting or intending to affect or to in any way interfere with the laws of any state or territory relating to the control, appropriation, use or distribution of water used in irrigation or any vested right acquired thereunder, and the Secretary of the Interior, in carrying out the provisions of this act, shall proceed in conformity with such laws, and nothing herein shall in any way affect any right of any state, or of the federal government, or of any landowner, appropriator or user of water, in, to or from any interstate stream or the

waters thereof; provided, that the right to the use of the water acquired under the provisions of this act shall be appurtenant to the land irrigated and beneficial use shall be the basis, the measure and the limit of the right."

The United States Supreme Court in the case of *Kansas vs. Colorado*, 206 U. S. 46; 51 Law Ed. 956, denied the right of the Reclamation Service to control the waters, except waters for irrigation of Government lands and held that there was no power in the Federal Constitution giving the Federal Government control of the waters in the stream, and held that the control of the waters of the stream was exclusively in the states.

The Reclamation Act can only be held Constitutional upon the theory that it gives the Federal Government, under the power to control its public lands, the rights of riparian owners to appropriate the waters of the public stream and to construct irrigation works to irrigate its own lands. The act itself provides that the Reclamation Service shall be subject to the laws of the states and that beneficial use shall be the basis, measure and the limit of the right, and the water taken under the act shall be appurtenant to the land contemplated in the Reclamation Act, which was the Government land only. Therefore if there is any surplus waters held by the Government within the reservoir, in the bed of the public stream which are not required by the Government and not necessary for the irrigation of the Government lands, such surplus is public waters and belongs to the riparian owners along the stream in Wyoming and Nebraska, in accordance with the laws of the states of Nebraska and Wyoming. Therefore the Government has no legal or moral right to withhold these surplus waters in the Pathfinder Reservoir above what are required by the Government for irrigating its own lands.

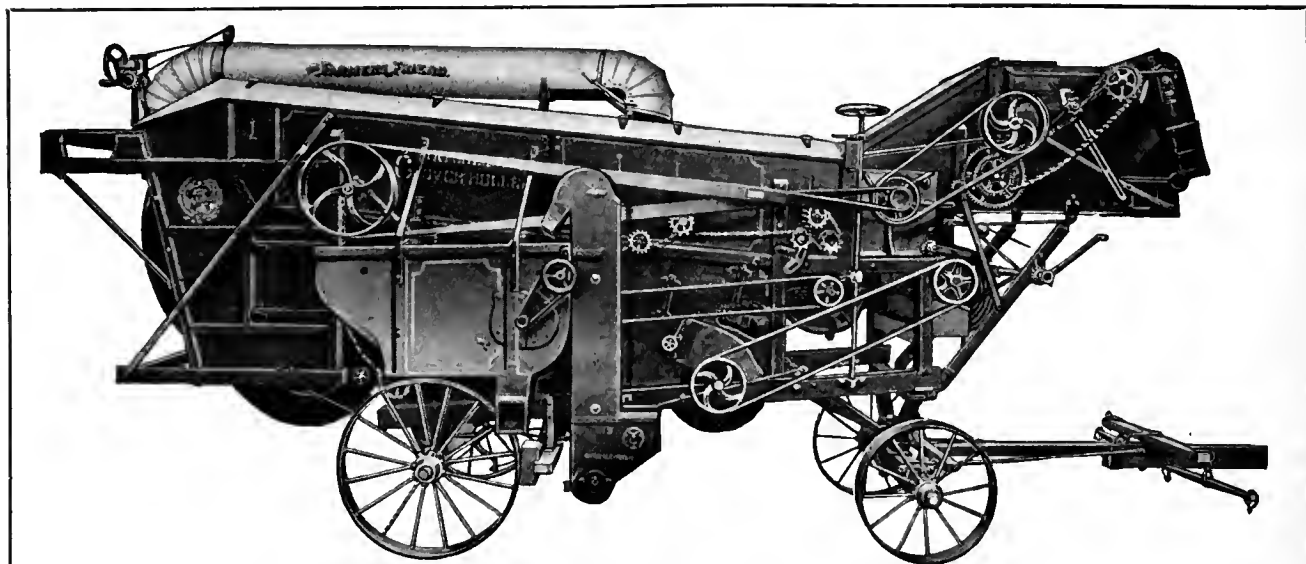

HULL YOUR SEED QUICKLY, PERFECTLY and ECONOMICALLY With a
"MATCHLESS" CLOVER and ALFALFA HULLER

That's just what you will do if you use a "Matchless" Huller on the job. It's the one huller that will hull all the Clover or Alfalfa you can get to it without sacrificing the quality of the work. Here's the reason! We use square steel brads in our hulling cylinder. This construction has every advantage over rasps of spikes, because no set of spikes will knock the seed out of the damp pods. Rasps gum up and are easily destroyed. Our system of separation is unique and effective. This consists of a series of rotating troughs with perforation in the bottom, with provision for adjustment to meet the various conditions of clover. The Patented Steel Scrapers attached to the bottom of these troughs thoroughly scrape the separator bottom and insure a steady and positive delivery of the pods to the hulling cylinder, regardless of the condition of the clover. This construction enables you to hull seed under conditions in which no other huller can operate; enables you to hull earlier in the morning and later in the evening than with any other—this insures a longer day, thus increasing your earning power. Give us an opportunity to prove to you right on your own farm that the "Matchless" is the speediest and cleanest huller on the market. WRITE FOR CATALOG TODAY, or call at our nearest Branch House.

THE AULTMAN & TAYLOR MACHINERY COMPANY, MANSFIELD, OHIO.

Sole Builders of Aultman-Taylor "Starved Rooster" Line of Machinery.

BRANCHES: Minneapolis, Minn.; Portland, Ore.; Lincoln, Nebr.; Kansas City, Mo.; Wichita, Kan.; Decatur, Ill.; Indianapolis, Ind.

It may be said that these waters are collected from the surplus and would go to waste if not impounded by the Government, and if my conclusions are correct, the Government would not be compelled to store the water for the benefit of the people, and can let the surplus go to waste. If the Government should take such a position when it is spending millions of dollars in experimental work in the agricultural department and millions of dollars in protecting the banks of the Mississippi and Ohio rivers from floods, for which there is no return, it ought to receive the condemnation of all honest thinking people. It is apparent that these surplus waters could be kept in the reservoir without the expenditure of a dollar on the part of the Government, and could be released upon orders of the State Boards of Irrigation of Wyoming and Nebraska, as required by the people along the stream.

It is therefore apparent that the following facts must be recognized:

1. The Government now holds in storage a vast quantity of water in excess of any possible demand by the Government upon the reservoir.

2. By withholding this water at this time the Government can neither hold it for nor apply it for any beneficial use, the only legal right the Government has to any water is that given it under the laws of the states to which it submitted when it made the appropriation for the reservoir.

3. The portion of the water impounded from the natural flow at times when the natural flow would have reached numerous canals with rights prior to the Government, is clearly water that belongs to such canals and the Government is holding it without right.

4. It is up to the Reclamation Department to at once release a reasonable amount of the excess stored water for the use of the people in the Platte valley and to at once determine upon some fair and equitable method of adjustment and permanent solution of the trouble. The department should at once take the people into their confidence, and turn the reservoir over to the people upon being reimbursed for the moneys invested by the Government in the reservoir.

5. If the Reclamation Department refuses to do this it is up to the irrigators and riparian owners along the Platte river in Nebraska to secure an adjudication in the court against the Reclamation Department and compel the department to recognize the rights of our people.

The people of Nebraska and Wyoming as those

jointly interested in this enterprise of the Government, started for the purpose of benefiting our people, and the state officials and legislative machinery of Nebraska and Wyoming, ought to co-operate and compel the Reclamation Service to observe the laws of the states of Nebraska and Wyoming in the administration of the waters under the control of the Reclamation Service, but for which the Reclamation Service has no beneficial use.

Senator Norris of Nebraska has introduced a joint resolution allowing suit to be brought against the officers of the Reclamation Service to determine our rights. It remains to be seen whether or not the Rec-

(Continued on Page 379)

\$.00141 per H.P. per hour

Write us about this!

A fraction over a mill per H. P. per hour is the proven cost of Bessemer Fuel Oil Engines on California fuel oil. Compare this with Steam or Central Station Costs. To this economy we add simplicity, reliability, dependability. The

BESSEMER FUEL OIL ENGINE

is two stroke cycle, built with crosshead, enclosed crank crank case, automatic air starter and high class equipment throughout. Ask us today for catalog of this wonderful engine.

THE BESSEMER GAS ENGINE CO.
12 York St. - GROVE CITY, PA.
Gas Engines 5 to 350 H. P.
Fuel Oil Engines 15 to 165 H. P.
Kerosene Engines 2 to 10 H. P.

BESSEMER ENGINES RUNNING TODAY IN FIFTEEN THOUSAND POWER PLANTS

YOU SHOULD USE The Enterprise Tent-Cot

"The Perfect Outdoor Bed"
For Porch, Lawn or Camp

The Enterprise Tent-Cot will protect you from all the discomforts and dangers of sleeping out. You sleep 17 inches above the ground under a storm-proof covering that enables you to use the Tent-Cot every night in the year, and all the doors and windows are fitted with both storm and mosquito curtains that can be raised and lowered at will of the occupant. For anyone afflicted with lung trouble there is nothing equals the Tent-Cot. It also has a splendid appearance and can be set up on your porch, lawn or roof and taken down when not in use. Can be set up in a space 30x75 inches and only requires about 30 seconds to operate. It is ideal for hunters, fishers and campers as it eliminates all the annoyance of "making camp." With a Tent-Cot you carry your camp with you under your arm and sleep safe and sound any place.

SPECIFICATIONS—Length of cot open, 6 ft. 6 in.; width of cot, one person, 28 in.; width of cot, two persons, 44 in.; height of bed from ground, 17 in.; height of tent over cot, 32 in.; size of cot folded, for 1 person, 38x36; size of cot folded, for 2 persons, 44x36; weight, 1 person, 29 lbs.; weight, 2 persons, 44 lbs.; frame is of hard maple, painted green; covering is of heavy waterproof canvas in colors, tan or olive green.

PRICE—Tent-Cot 28 in. wide, open 1 side, \$9.00; Tent-Cot 28 in. wide, open 2 sides, \$9.50; Tent-Cot 44 in. wide, open 2 sides, \$11.50.

Manufactured Exclusively by ENTERPRISE BED COMPANY, HAMMOND, INDIANA

BRIEF NOTES FROM IRRIGATION PROJECTS

Montana

Preliminary surveys in the Big Horn Canyon Irrigation & Power Company's project near Hardin, Mont., have been completed. These surveys show that the fall of the Big Horn river through the canyon is 405 feet in a distance of 49½ miles of canyon and it will be necessary to plan for the construction of a dam 415 feet in height in order to procure the benefit of all the fall and the storage. A site has been selected in the mouth of the canyon for such a structure which measures about 90 feet across the river at water level and 1,000 feet across at an elevation above the water of 415 feet.

The Tongue River Land & Livestock Company will irrigate 6,000 acres of the 23,000-acre Clarke ranch, 45 miles from Miles City, Mont. The dam will be of concrete, 300 feet long, outside of the abutments, eight feet high and will weigh 711¾ tons. Its base will be 13 feet wide and will rest on bedrock. It will back the waters of the river up probably a mile and a half. The abutments on each side will be six feet higher than the dam proper.

A syndicate of Montana and Illinois men has purchased the property of the Beaverhead Ranch Company near Dillon, Mont., and will colonize it. The property includes 12,000 acres of irrigated land and an irrigation system with a chain of seven lakes and numerous canals, ditches and streams. It is the intention of the company to

cut the vast tract of land into small tracts ranging from 40 acres up and to colonize it.

The Kalispell (Mont.) chamber of commerce for some time has been investigating the proposition of small pumping irrigating plants on farms. There is a large acreage of land in Flathead valley, particularly in the river bottoms, where there is an abundance of water equally distributed over the land at a depth of from 10 to 15 feet.

Work has commenced on the excavation and construction of the Little Missouri River Irrigation Company's project in Fallon, Mont. The contract has been let to a firm of Glasgow contractors and includes the building of the big reservoir a few miles north of Alzada as well as the excavation of the main ditch and lat-

crals. The new project will irrigate about 30,000 acres of Little Missouri bottom which is among the best land in the eastern part of Montana.

New Mexico

Denver capitalists have raised \$400,000 to construct the first unit of the Eagle's Nest irrigation project in Colfax county, N. M., together with the dam in the Cimarron canyon.

Colorado

Properties valued at \$3,000,000, owned heretofore by the Pueblo-Rocky Ford Irrigation Company, passed into the hands of the Chicago Title & Trust Company as trustees for owners of bonds by the issuance of a decree by Federal Judge Robert E. Lewis. The affairs of the company have been in the hands of receivers, and the stipulations filed, praying for the foreclosure in August, 1912.



Irrigation plant on the Carter sugar beet farm at Garden City, Kansas

(650-43B)

10 cents an Acre

is the yearly operating cost of this Fairbanks-Morse 15 h. p. oil engine irrigating outfit. The horizontal centrifugal pump delivers 1,000 gallons of water per minute to the 80 acres irrigated.

Let us help solve your irrigation problems

Fairbanks, Morse & Co.

Chicago	Kansas City	St. Louis
St. Paul	Denver	Omaha
Spokane	Seattle	Los Angeles
Portland	Salt Lake City	Atlanta

Price **\$100**

The Royal does the work of several typewriters in one—it writes, types cards and bills! All this without a dollar for "special" attachments. The one machine does it all.

Write Direct for our new Brochure, "BETTER SERVICE," and a beautiful Color-Photograph of the **New Royal Master-Model 10**.

ROYAL TYPEWRITER CO., Inc.
Royal Typewriter Building Broadway, N. Y.

Only \$2 DOWN and One Year To Pay

For any Size—Direct from Factory

You can now get one of these splendid money-making, labor-saving machines on a plan whereby it will earn its own cost and more before you pay. You won't feel the cost at all.

\$24 BUYS THE NEW BUTTERFLY

No. 2 Junior—a light running, easy cleaning, close skimming, durable, lifetime guaranteed separator. Skims 95 quarts per hour. We also make four other sizes up to our big 600 lb. capacity machine shown here—all sold at similar low prices and on our liberal terms of **only \$2 down and a year to pay.**

Patented One-Piece Aluminum Skimming Device, Rust Proof and Easily Cleaned — Low Down Tank — Oil Bathed Ball Bearings — Easy Turning — Sanitary Frame — Open Milk and Cream Spouts.

30 DAYS' FREE TRIAL GUARANTEED A LIFETIME

You can have 30 days FREE trial and see for yourself how easily one of these splendid machines will earn its own cost and more before you pay. Try it alongside of any separator you wish. Keep it if pleased. If not you can return it at our expense and we will refund your \$2 deposit and pay the freight charges both ways. You won't be out one penny. You take no risk. Postal Invoice Free Catalog Folder and direct from factory offer. Buy from the manufacturers and save half. Write TODAY.

No. 5½ Over 20,000 now in use

Albaugh-Dover Co., 2253 Marshall Blvd., Chicago, Ill.

charged mismanagement. The total indebtedness proved was \$2,544,000. The company owned about 500 acres of land in the Arkansas valley with irrigation improvements, ditches, dams and water rights.

Texas

A deal has just been closed and signed by the Donna, Tex., farmers, the La Blanca Agricultural Company, Beemer, Snyder & McDowell, by which an irrigation district of 40,000 acres is to be formed, \$800,000 worth of 5 per cent bonds, running forty years, to be issued, and the present canal system is to be taken over, reconstructed and extended. This will settle the water question at Donna and make the Donna proposition one of the best, if not the best, proposition in the lower Rio Grande valley.

Farmers around Harlingen, Tex., have voted in favor of a \$750,000 bond issue to construct an irrigation project.

The state board of water engineers has granted a permit to the Brazos River Irrigation Company of Dallas to appropriate sufficient water from the Brazos river and Bitter creek, a tributary of that stream in Jones county, to irrigate 10,200 acres of land. This company is to operate an irrigation plant to cost about \$225,000.

Kansas

It cost 9 cents an acre to put water on the Fort Larned ranch in Pawnee county, Kan., this year. E. E. Frizell says that it cost 15 cents an hour for fuel oil and 3 cents an hour for lubricating oil, and in an hour two acres can be covered with from four to six inches of water. This is a considerable reduction from last year, when it cost about 21 cents an hour, making the cost per acre 10½ cents. The difference was in the cost of the fuel oil. Mr. Frizell says that one-fourth of the land in Pawnee county can be irrigated for 9 cents an acre. The Fort Larned land is being irrigated with water from the Pawnee river. He says that there are 125,000 acres in the valleys underlaid by sheet water at a depth of from 10 to 25 feet, and that all of this land can be irrigated cheaply by pumping.

The pump of the Fort Larned ranch produces 3,600 gallons a minute. There are now twelve irrigation plants, watering 1,500 acres, in Pawnee county.

Wheat grown this year under irrigation in Kearney county, Kan., showed some very fine yields. A. B. Downing, of the Deerfield district, from 400 acres threshed 10,000 bushels. The American Sugar Beet Company harvested nearly 40,000 bushels.

Oregon

It is considered probable that the Tumalo irrigation project in eastern Oregon will be extended, taking in an additional 16,000 acres, Governor West having taken the matter up with government officials in the U.

S. Reclamation Service. The plan of the executive is to use the \$450,000 allotted to Oregon by the secretary of the interior for cooperative work for carrying out of the proposed extension. A large amount of this money has been put into the Tumalo project.

"The \$450,000 allotted to Oregon by the secretary of the interior for cooperative work will be lost to the state unless tied up before the first of the year," said the governor. "It is hoped

to see this money applied to either completing the Central Oregon Irrigation Company's project or extending the Tumalo project. If applied to the Tumalo project it would mean the government's taking up the work where the state will leave off November 1, and extending it so as to place water upon 16,000 additional acres and at a probable cost of about \$40 per acre. The government's report will be awaited with interest."

(Continued on Page 374)

Alfalfa for profit

"One-Half the Alfalfa Seed Sown is Wasted Every Year"

This statement has been made by many recognized Alfalfa experts—men who know what they are talking about.

They say that they secured better stands of Alfalfa with 10 pounds of seed, drilled with the Superior Special Alfalfa and Grass Seed Drill than with 20 pounds of seed sown broadcast.

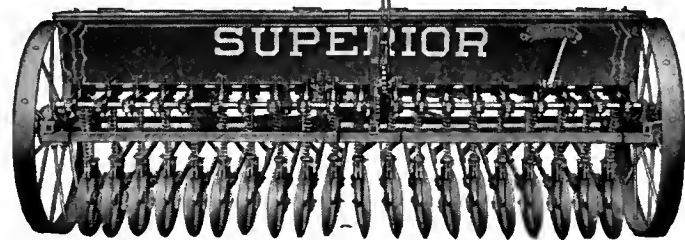

THE SUPERIOR 20 X 4 SPECIAL ALFALFA AND GRASS SEED DRILL

There are 20 discs on this machine set 4 inches apart. The construction is such that all the seed is sown at an even depth, and an equal amount of seed in every furrow.

None of the seed is wasted, when drilled in the ground with a Superior Alfalfa and Grass Seed Drill

REJUVENATES OLD ALFALFA FIELDS

RENEWS OLD PASTURES AND MEADOWS

PRODUCES BEST STANDS OF MILLET

INCREASES YIELDS OF WINTER WHEAT BY

CULTIVATION and SOWS CLOVER AT SAME TIME

Saves More Than Two Dollars an Acre on Seed Alone

Send for Superior Alfalfa Drill folder and read the **strong warranty**

Go to your local dealer and ask to see the Superior Special Alfalfa and Grass Seed Drill. If he will not supply your needs, we will.

THE AMERICAN SEEDING-MACHINE CO., Inc.
SPRINGFIELD, OHIO

FREE—A copy of "Boyd's Farmers' Alfalfa Guide," price 10c, will be mailed free to any reader of Irrigation Age who will write for the book and mention Irrigation Age.

WAR HALTS BIG DAM IN SPAIN

Work on the great power dam at Barcelona, Spain, where about 100 Texans were employed, was entirely suspended on September 1, owing to a lack of funds. The project was backed by an English syndicate, the intention being to build dams at several other places in the peninsular kingdom in addition to the one at Barcelona, concessions having already been obtained. The total cost of the work would have run up to many millions of dollars.

Inability to secure funds, owing to the European war, is given as a reason for the cessation of work. The officials stated that no definite information could be given as to the time when operations would be resumed.

The backers of the Spanish enterprises are said to be the same people that were behind the build-

ing of the dam across the Medina River near Castroville, Texas. That corporation was known as the Medina Valley Irrigation Company, for which there have been two receivers appointed, one by the United States court and one by the state court.

Statement of the ownership, management, circulation, etc., required by the act of August 24, 1912, of IRRIGATION AGE, published monthly at Chicago, Ill., for October 1, 1914:

Editor, D. H. Anderson, Chicago, Ill.
Managing editor, George J. Scharschug, Chicago, Ill.
Business manager, E. H. Anderson, Chicago, Ill.
Publisher, D. H. Anderson, Boyce building, Chicago, Ill.
Owners: (If a corporation, give its name and the names and addresses of stockholders holding 1 per cent or more of total amount of stock. If not a corporation, give names and addresses of individual owners.) Not a corporation. Individual ownership of D. H. Anderson, Boyce building, Chicago, Ill.

Known bondholders, mortgagees and other security holders, holding 1 per cent or more of total amount of bonds, mortgages or other securities: (If there are none, so state.) None.

D. H. ANDERSON,
Publisher.

Sworn to and subscribed before me this second day of October, 1914.
MICHAEL J. O'MALLEY,
Notary Public.

(My commission expires March 8, 1916.)

IRRIGATION NOTES

(Continued from Page 373)

Utah

The Keeler Automatic Headgate Company, Provo, Utah, has been incorporated with a capital stock of \$10,000 by J. B. Keeler and others to manufacture patented hydraulic apparatus. Joseph B. Keeler is president and R. J. Murdock is secretary.

The Uinta Land & Water Company has filed application with the Utah state engineer for 75 second feet of water from Dry Fork, Ashley river, Uinta county, for irrigation.

A party of Reclamation Service officials has completed a trip along the Weber river in Utah for the purpose of investigating conditions and computing costs of one of the biggest irrigation projects in the country. About 300 miles were covered and a thorough examination made of the Weber river system, opportunities for building reservoirs and the means of diverting the waters into Provo river, through which it is proposed to convey it to Utah valley, where canals will be built to carry the water to lands in Utah, Salt Lake and Toole counties for irrigating large areas of fertile land, now without water. The proposed project will cost about \$10,000,000.

A large number of farmers having land under the Hammond canal near Brigham City, Utah, are preparing to organize. The farmers feel that if they have an incorporated organization they will then be in a position to work to each others' interests and cooperate more successfully with the Hammond canal people in the matter of getting water for their lands.

Washington

The Horse Heaven Land Owners' Association, representing the control of 300,000 acres of unirrigated land in Klickitat county, Wash., is making an active effort to secure serious consideration by the government of the Klickitat Irrigation & Power Company's project for irrigation of these lands.

(Continued on Page 378.)



Buying direct of HEWITT-LEA-FUNCK Co. Saved these 5 Farmers \$1283

Saved \$175.00

Received the lumber O. K. I see it was shipped the tenth and got here the twenty-fifth. I am well pleased with it, being better than I could get here. I have saved about \$175, enough to build my barn.

J. E. REYNOLDS, Junius,
South Dakota

Saved \$250.00

Material was all better grade than I had figured at our local yards. Had more than needed to finish my building. Had enough for a few small sheds. Saved me at least \$250 on my bill as I have exact figures.

A. M. STERN, Regan,
North Dakota

Saved \$393.60

Lumber O. K. We had two of our lumber dealers inspecting our lumber, but they were disappointed. They had no chance to shoot hot air into us. We saved over 40% (\$393.60.)

THOMAS SHEEHAN, Weaver,
Minnesota

Saved \$326.00

We feel greatly indebted to your firm for the way you've treated us—in quality of lumber, promptness in delivery and prices. Same quality of lumber in local yards would have been nearly half more.

J. O. JOHNSON, Fallon,
Montana

Saved \$139.00

Finished unloading on the nineteenth. As for lumber, I am satisfied. I saved from \$1.00 to \$5.00 per thousand, and better lumber.

CHAS. F. ROBERSON, Opal,
Wyoming

Here are a few things these farmers say: Saved enough to build my barn—enough lumber left to build some sheds—carpenter said he never worked up lumber comparing with this for quality—the same quality of lumber would have cost at least twice as much locally. From these letters you can see the kind of saving you can make and the kind of lumber and treatment you get from Hewitt-Lea-Funck.

Through our officers we own big forests and mills

We do all our own cutting, logging and sawing. One operating expense—only one profit for you to pay. We sell old growth yellow fir, the strongest lumber for structural use—red cedar, for long lasting shingles and siding—spruce, Western yellow pine, hemlock, etc. You can't get such lumber in local yards nor can you get such low prices.

Now's the time to read up on H.-L.-F. prices and terms—send coupon today

If you are thinking of building—next Spring or within a year or two—now's the time, during these long evenings to study H.-L.-F. Prize Book of House Plans, H.-L.-F. Barn Builders Guide, H.-L.-F. Silo Folder, H.-L.-F. Millwork Catalog and the H.-L.-F. Price List. Send the coupon.

Special Fall Offer

Late Fall's a dull season with the lumber trade. Buy now while the price is favorable and we'll send along, free, enough roofing to cover and keep dry during the winter. Don't pass up this chance. Send your carpenter's bill today for price. If bill isn't ready send us rough sketch of the building you want, for estimate.



Hewitt-Lea-Funck Company

Capital \$1,000,000 NOT IN ANY TRUST

271 Cray Bldg., Seattle, Wash.

Hewitt-Lea-Funck Co., 271 Cray Bldg., Seattle, Wash.

Please send the following: (Be sure to write plainly.)

- Prize Plan Book (Houses), send 10c. Barn Builders Guide, send 4c.
 H.-L.-F. Silo Folder, free.
 Delivered, freight paid price on enclosed list of materials, no charge.
 Millwork Catalog and price list of lumber.

Name _____

Street No. or R. F. D. _____

Post Office _____ State _____

Business _____

LEARN QUALITY OF YOUR IRRIGATING WATER

DR. A. E. VINSON, of the University of Arizona Agricultural Experiment Station, is urging all farmers in his state to have all water which they propose to use for irrigation tested. He declares some farmers have been led to make heavy investments because of the discovery of a large supply of water near the surface, only to find later that this water was very damaging to the land and fatal to crops.

Too often the prospective settler or homesteader considers only the depth to water and the available supply when found. Modern pumping machinery has increased greatly the depth from which water may be lifted and better cultural methods have increased the duty of the water so that now a farmer can be successful under conditions that a few years ago were impossible. However, the effect of bad water is not so easily, and in fact, rarely, to be overcome.

It happens occasionally that two waters occur close enough together so that, although either alone is unfit for irrigation, yet when combined in proper proportion they give a water of usable quality. Such is the case where a very pure, but prohibitively black alkaline, water occurs near a strongly saline but hard water; sometimes the two may be blended to give a neutral water of moderate salt content that will answer well for irrigating. Again the

abundance of pure, sweet flood water may be available from time to time, which can be applied to work out and carry away the alkali accumulated from the application of alkaline pumped water between the flood periods. But these conditions are not general, and usually the farmer will find it well to consider the quality of his water supply before going to the expense of testing out the yield.

All waters that have a strong saline taste are too salty for use excepting under special conditions. On light soils, well drained, and with an abundance of cheap water so that the salts can be kept leached out of the upper three or four feet of soil, excellent results may be had indefinitely. In proportion to the lack of these conditions, sooner or later the detrimental effects of the alkaline water will become manifest. In some cases it may be only a few years; in others a generation.

In Arizona the quality of ground water is apt to be a local condition, sometimes confined to a very small area. There are in general regions of saline waters, of black alkaline waters, and of pure waters, within which most of the waters are of the same general character. But occasionally a good water is found in a district where bad waters abound, and the reverse is not unknown. Attempts have been made to improve the quality of water by prolonged pumping, but usually without success.

The New Era Elevating Grader

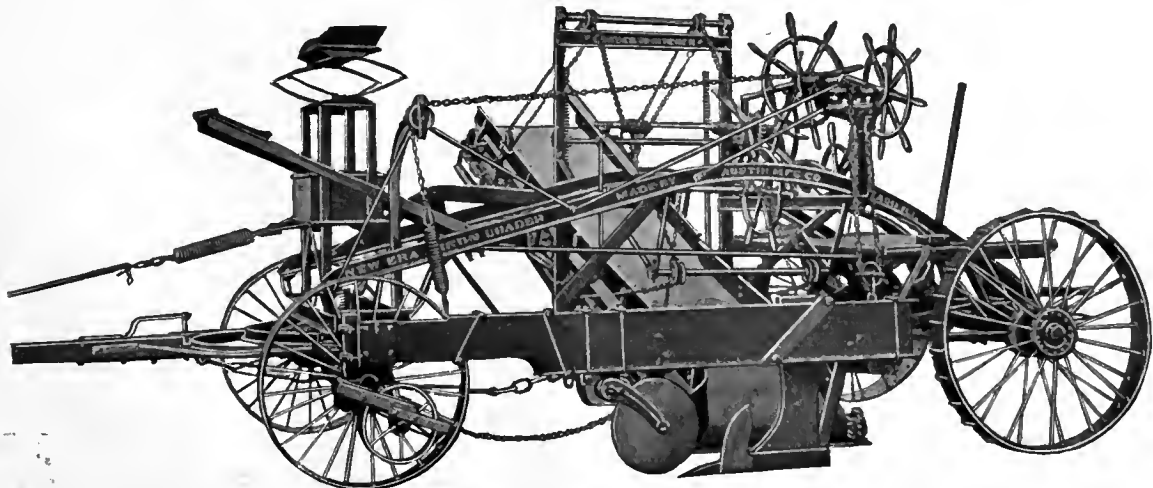

For over fifty years the leader and pioneer for economical earth handling, has advanced still higher in the estimation of practical earth handling contractors by its recent improvements.

1. The Austin reversible earth deflector.
2. The Austin roller bearing disc plow.
3. The Austin automatic sand pan cleaner.

AUSTIN MANUFACTURING CO., CHICAGO

New York Office, 50 Church Street

Canadian Agents, Mussels Ltd., Montreal

Write for fully descriptive catalogue showing machines adapted to all kinds of special work

One well, however, with very salty water occurred in the Rilito valley near Tucson in a district of generally good waters. Recently this well has been pumped freely and is now quite as good as other waters in the neighborhood. In parts of the Casa Grande valley and the Buckeye-Arlington district the first stratum waters are very saline, while those found at greater depth are very much less so. A deep well was put down adjoining the University grounds at Tucson and samples were analyzed from different depths. The water at 700 or 800 feet in

this case did not differ materially from that found at 100 feet—illustrating the uncertainty of applying conditions in one neighborhood to another.

Water for irrigating cannot be judged solely by the taste, since an injurious amount of black alkali does not reveal itself in this way. Black alkali waters usually make very satisfactory domestic waters, since they are soft and work well with soap. They are not more harmful to the health than other waters with a little pinch of baking soda added; in fact, in some cases they may be decidedly beneficial.

IRRIGATION CONGRESS MEETS IN CANADA

AS this issue of the IRRIGATION AGE goes to press, the twenty-first annual meeting of the International Irrigation Congress is being held at Calgary, Alberta.

A program covering four days has been arranged by the officers. A. A. Jones, first assistant secretary of the interior, is the most prominent American scheduled to appear. Among other Americans on the program are: J. M. Kennedy, Montana Commissioner of Agriculture; J. B. Case, of Kansas; D. W. Ross, of California; John Fairweather, of California; George A. Snow, of Utah; J. T. Hinkle, of Oregon; F. H. Newell, Kurt Grunwald, of Colorado; H. B. Walker, state irrigation engineer of Kansas; J. C. Nagle, chairman of the board of water engineers of Texas; John Widstoe,

president of the Utah Agricultural college; L. Newman, of Montana; F. C. Finkle, of California; John Barrett, of Washington, D. C., and E. F. Benson, of Washington.

The balance of the program is filled by Canadian speakers, provincial officers and employes of the Canadian Pacific Railway and its land companies.

The European war has had a depressing effect on the preparations for the congress, and almost resulted in its complete abandonment. As it is, there will be no distinguished visitors from abroad, such as characterized the meetings of the congress in the days when it was an honored institution of the United States and working heart and soul in behalf of the irrigated West.

The School For Your Daughter

TERM OPENS
SEPTEMBER
FIFTEEN

St. Mary-of-the-Woods

COLLEGE
AND
ACADEMY

DEGREES CONFERRED: B. A., B. S., PH. B. STRONG FACULTY

Located four miles west of Terre Haute, Indiana. Large campus, perfect drainage, commodious buildings, steam heat, electric lights, large airy rooms, many with private bath, and spacious halls, libraries and parlors. School plant consists of fourteen modern buildings, artistically grouped and completely equipped. Nothing lacking for convenience or comfort. Combining all the best features of school life with home environment on a country estate of 1,600 acres.

BOATING, HORSEBACK RIDING, SWIMMING, ARCHERY, GOLF and all outdoor athletics for girls under the constant supervision of a graduate of the Sargent School for Physical Education. School course comprises INTERMEDIATE, ACADEMIC and COLLEGIATE departments. Special courses in MUSIC, ART, LANGUAGES, DRAMATIC ART, and DOMESTIC SCIENCE. Information gladly furnished on application. A beautifully illustrated catalogue to be had for the asking. Address

SISTER SUPERIOR, Box 41,

St. Mary-of-the-Woods, Indiana



College Building

Conservatory of Music

Academy Building

When writing to advertisers please mention The Irrigation Age.

IRRIGATION DOUBLES YIELD IN OREGON

IRRIGATION of nine standard field crops of the Willamette valley in Oregon, for a period of seven years has shown that irrigation produces an increased yield of 53 per cent as an average. At the maximum price of \$1 per acre inch of water the average profit on these crops was \$2.66 per acre inch for all water used. Since the most profitable amount of water varies with different crops from one to two acre inches to six acre inches, the entire profit per acre is seen to be a highly important factor in lowering the production cost of these crops.

In order to determine scientifically and accurately the value of irrigation in the Willamette valley the agronomy department of the Oregon Agricultural college instituted an exhaustive series of tests seven years ago. The experiments have been carried on continuously since that time, and now for the first time results have been compiled by Professor W. L. Powers. Concerning the character and extent of the tests Professor Powers says:

"The experiment to determine the practicability and also the most advisable means and methods of irrigation here has been enlarged and carried forward with 60 plats, including nine different crops of standard varieties. Seven years' data are now on hand, showing profit from irrigation with all but one of these crops. Careful weather and evaporation records have been kept and nearly 10,000

soil moisture determinations have been made in connection with this work.

"Usable moisture has been found throughout the dry season below the fourth foot of soil, but upward capillary movement becomes retarded, and the weathering processes and bacterial activity retarded by drying out of the surface soil in summer. A little irrigation seems to stimulate these life-giving processes in the soil. Irrigation has given a higher sessional moisture content and this is associated with higher yields. The greatest increase in moisture has been in meadow plants, but the most economical yields due to irrigation have been with cultivated crops.

"Irrigation lowered the temperature of the surface soil as much as 4 degrees in cultivated plants and as much as 10 degrees in meadow plants.

"One irrigation has been better than two irrigations for most crops. The most economical increase in yield of hay was secured by use of about four acre inches' irrigation in a wet season and about six acre inches in a dry season, while the maximum yield has been obtained from six acre inches in a wet season and twelve acre inches in a dry season. The most economical returns with potatoes has been secured with two acre inches in a wet season and with three or four acre inches in a dry season, while the maximum yield for potatoes



THINK what it means to you! To have at your service—day and night if desired—the combined power of 30 to 35 horses and 10 to 15 men—ready at a moment's notice to plow, disc, harrow, seed, harvest, build roads, irrigate, thresh and do numerous other power jobs, all at the minimum expense for fuel and maintenance. That's what you get when you buy a time-tried and time-proven

AULTMAN-TAYLOR 30-60 GAS TRACTOR

They're built with the complete knowledge of the requirements of a tractor of the first quality. They're built right here in our own shop, under our own supervision. We know they're right and we stand back of every tractor. The Aultman-Taylor 30-60 burns either gasoline, kerosene or

distillate with unequalled economy. The Aultman-Taylor 30-60 is not an experiment. Their real worth has been demonstrated on thousands of farms throughout North America. Let us explain to you why you should own and operate one of these money-making and labor-saving tractors. **WRITE FOR CATALOG AND FURTHER INFORMATION TODAY.**

We are also builders of the Famous "New Century" Separator, "Matchless" Clover and Alfalfa Huller, Steam Traction and Portable Engines, Bean Threshers and Saw Mills. Catalog free upon request.

THE AULTMAN & TAYLOR MACHINERY COMPANY

MANSFIELD, OHIO.

BRANCHES: Minneapolis, Minn.
Wichita, Kan.

Portland, Ore.
Decatur, Ill.

Lincoln, Nebr.

Indianapolis, Ind. Kansas City, Mo.

When writing to advertisers please mention The Irrigation Age.

has been secured with three inches in a wet season and six inches in a dry season.

"Experiments have shown that the moisture content of the soil and evaporation from a water surface make very valuable guides as to the best time to irrigate. Potatoes have made a maximum yield where the irrigation was applied whenever the moisture content dropped to 20 per cent in the first foot of soil. With clover the most economical returns were obtained when the moisture content dropped to 15 per cent in the first two feet of soil.

"Pumping with gasoline has proven somewhat cheaper in fuel cost than electricity, yet the saving in labor by electricity is more important than the total fuel bill. The electric plant can also be made to serve more acres and this lowers the overhead cost per acre.

"Using \$1, which is our maximum total annual cost per acre inch, corn has given an average profit of \$0.43 per acre inch; kale, \$0.60; beets, \$1.15; alfalfa, \$1.65; clover, \$2.71; beans, \$2.79; carrots, \$6.83, and potatoes, \$7.75 per acre inch of water

applied. The mean profit per acre inch as an average of all crops and including nearly 150 trials, has been \$2.66. The average increase in yield by crops has been 53 per cent and the average depth of irrigation per season 504 inches."

AVOID TURKESTAN ALFALFA SEEDS

A warning to alfalfa growers to avoid the use of commercial Turkestan seed is contained in Department Bulletin No. 138, of the U. S. Department of Agriculture, which is shortly to be issued under the title "Commercial Turkestan Alfalfa Seed." Specialists of the department have been investigating the comparative merits of different kinds of alfalfa seeds, and have reached the conclusion that there is nothing to recommend the Turkestan variety for general use in this country. Growers who wish to avoid this variety can readily identify it by the presence of Russian knapweed seeds. Their chalky white color makes them especially conspicuous.

IRRIGATION NOTES

(Continued from Page 374)

Letters received by the executive board of the Washington Irrigation Institute, the second annual session of which is to be held in North Yakima in December, indicate that there will be a large attendance from every section of the state. Governor Ernest Lister, President Bryan of Washington state college, B. A. Etchberry of the University of California and Don M. Bart, government irrigation expert in Idaho, will speak. The program for the three-day session, December 16, 17 and 18, calls for one day on engineering problems in irrigation work, one on irrigation farming and one on legal problems, legislation and future development.

A proposition to irrigate the high land on the flat not reached by the Okanogan (Wash.) project, by conveying the water of Boulder creek into the west fork of Salmon creek, thence to Brown's lake, which they plan to use as a reservoir, has been made and a plan launched by H. S. Albertson, S. T. Sterling, Richard Malone and others of Pogue.

The feasibility of the project has impressed itself on the sponsors, who have solicited the aid of Manager Calvin Casteel of the Okanogan project with the hope that he may in turn be able to interest and influence the Reclamation Service.

Work on all three of the United States Reclamation Service pumping plants in the lower Yakima valley in Washington, including the Snipes Mountain, the Grandview and the Outlook, has been started. It is understood that \$50,000 additional to the \$290,000 originally set aside for pumping plants will be available. The latter sum would have allowed but two of the three to be completed.

(Continued on Page 379)

International Harvester Engines Give You Cheapest Power

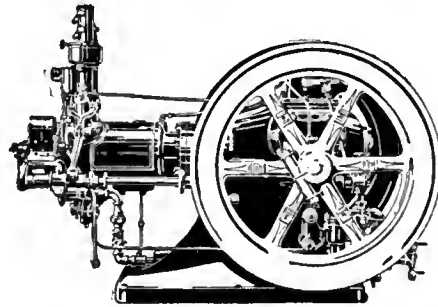

WISE farmers buy International Harvester engines—Mogul or Titan—engines of standard construction with such features as accurately fitted piston and rings, extra large valves, prompt repair service, use of cheapest local fuel—features that make them last by far the longest and save the most money in the end.

Be sure when you buy your engine that it is an I H C engine, and you will be sure of best material and best construction. They are made portable, stationary, or skidded; vertical or horizontal; air or water-cooled. Sizes range from 1 to 50-H. P. They operate on both low and high grade fuels.

Not every local dealer can show you International Harvester engines. Write us for interesting catalogues and full information, and we will tell you the name of the local dealer who handles our engines.

The IHC Line

GRAIN AND HAY MACHINES

Binders, Reapers
Headers, Mowers
Rakes, Stackers
Hay Loaders
Hay Presses

CORN MACHINES

Planters, Pickers
Binders, Cultivators
Ensilage Cutters
Shellers, Shredders

TILLAGE

Peg, Spring-Tooth,
and Disk Harrows
Cultivators

GENERAL LINE

Oil and Gas Engines
Oil Tractors
Manure Spreaders
Cream Separators
Farm Wagons
Motor Trucks
Thrashers
Grain Drills
Feed Grinders
Knife Grinders
Binder Twine

International Harvester Company of America

(Incorporated)

CHICAGO

Champion Deering McCormick Milwaukee Osborne Plano

USA



RED TAPE BURNS UP \$1,000,000

(Continued from page 371)

Reclamation Service and the present administration at Washington will use its powerful political machinery to prevent the passage of this joint resolution and thus try to prevent our citizens from having a decision of the courts to determine the rights of the people of Nebraska and Wyoming to this water.

There is some indication on the part of under officials working in the Reclamation Service that the department at Washington may change its present course and offer some equitable solution of the problem. It is to be hoped that the policy will be changed and that it will be unnecessary to go into litigation. The people want amicable and contractual relations with the government if it is possible. If it is not possible, we must strictly enforce our state rights.

NEW ARMCO PUBLICATIONS

"Defeating Rust—The Story of Armco Iron," "Iron Roofs That Resist Rust," and "A Journey to Armco Farm," are the titles of three new publications on "Armco" products recently issued by the American Rolling Mill Co. of Middletown, O. In the booklet on the story of "Armco" iron are shown many illustrations of "Armco" iron used for roofs, ventilators, gutters, lath, window frames, stoves, refrigerators, culverts, pipes, etc. The booklet entitled "Iron Roofs That Resist Rust" contains an article on why iron roofs resist rust and illustrations and descriptions of many forms of "Armco" iron used in roof construction. Rules for estimat-

ing amounts of corrugated iron required to cover given spaces, tables of weights and list of products manufactured of "Armco" iron are also given in the booklet. "A Journey to Armco Farm" contains an interesting story of the various uses to which "Armco" iron is put.

CALL IT UMATILLA CORN

S. L. Carson, a settler on the Umatilla project, in Oregon, has propagated a new variety of corn, which seems well suited to climatic conditions in the northwest.

Mr. Carson's corn is a cross of three varieties. In color it resembles the White Dent. The shape of the kernel is more like sweet corn. The stalks do not run over five or six feet high but the leaf blades start at the ground. This is a feature which makes it excellent for ensilage. The ears are of good size and well formed.

Mr. Carson has been working on this variety for five years, weeding out that which did not come true.

VOTE FOR \$2,759,510 BONDS

The Paradise Irrigation District in Oregon has authorized a bond issue, aggregating \$2,759,510. No attempt will be made to sell the bonds until the money market, now disturbed by the European war, becomes more settled. It is proposed to use the money realized from the sale of the bonds to pay off present indebtedness and to irrigate additional land.

IRRIGATION NOTES

(Continued from Page 378)

California

Preliminary work is being done by the property owners and business men of the Terra Bella district around Porterville, Cal., for the formation of a new irrigation company, which will have for its purpose the watering of the Terra Bella and Deer Creek orchard and alfalfa district, the water to be secured by control of the floods of the foothills during the spring and fall.

It is stated by those in charge of the work, headed by T. M. Gronen, a banker, that there is ample water in the foothills upon which no filing has been made.

Some work has already been done and it is estimated by those interested that the system can be constructed for about \$1,000,000.

Settlers in the Orland Federal project in California have started a cheese factory to take care of their surplus dairy products. The following officers have been selected: President, J. A. Younggreen; vice president, J. Lundeen; secretary, H. L. Lundeen; treasurer, G. G. Ladine. The factory will be run on a co-operative basis and only dairymen will be allowed to purchase stock.

The Carmel Cattle company has purchased the Cox ranch, consisting of 4,000 acres, situated five miles southeast of Lost Hills, Cal. The principal owners of this company are

The CROCODILE WRENCH

Six Handy Farm Tools in One

The Crocodile Wrench is drop forged from the finest tool steel and scientifically tempered. Every wrench guaranteed against breakage. It is 8½ inches long and weighs ten ounces.

A pipe wrench, a nut wrench, a screw driver and three dies for cleaning up and re-threading rusted and battered threads; also for cutting new threads on blank bolts. Dies will fit all bolts used on standard farm machinery.

Teeth and dies are case-hardened in bone-black, making them hard and keen. The dies on this wrench are tempered to wear and would be of inestimable benefit to any farmer or ranchman, as they would often save valuable time, besides an extra trip to town for repairs.

Sent free with each order for Irrigation Age for one year—price for both \$1.00; also sent to old subscribers who renew their subscription for one year.

Address: IRRIGATION AGE, 30 No. Dearborn St., Chicago

James Ogden and Chandler, Bryant and Clark of Los Angeles.

"We will employ between 30 and 40 men and will plow and ditch and put into alfalfa the entire 4,000 acres," said Mr. Ogden recently. "We are principally in the cattle business and will use our product for feeding stock. The Lost Hills district looks good to me and outside of a few little spots here and there, most of the country is suitable for agricultural purposes."

G. W. Pierce will sink a series of irrigation wells on his ranch property three miles west of Davis, Cal. Pierce has 2,000 acres of excellent land in the Putah district, and the wells will form a portion of an extensive irrigation system.

Land owners on the west side of Fall river, in the vicinity of Glenburn and Fall River Mills, Cal., propose to irrigate several thousand acres with water pumped electrically from Fall river. The lift is a small one, the supply of water is never failing, and the power is available, now that a new power company has completed its installation and strung wires through the valley.

A plan is on foot to irrigate a large tract that is protected by levees around the shore of Tulare lake in California, the first to be irrigated being a tract of 960 acres belonging to E. E. Bush and J. F. Pryor, in the Buena Vista reclamation district. A 15-inch pump will be installed to lift the water from the lake over the levee to the land adjoining. When the tract is all irrigated it will be planted to wheat, the prospects being that wheat will be a paying crop next season, even with the added cost of irrigation.

A plan for the formation of the most extensive irrigation district that has ever been proposed in Los Angeles county has been submitted to the board of supervisors of that county by land owners of San Fernando valley. The district, if established, will take in virtually the entire valley and the estimated cost of the work is more than \$2,500,000.

More than 75 persons representing vast property interests in the valley have signed the petition.

The proposition is to build a large system of conduits and pipes to connect with the Los Angeles city system and take Owens river water to the valley.

O. M. Enslow has filed on 37,500 miners' inches of water in the Feather river in California to irrigate lands on the east side of the river west of Palmero and Honcut. It is proposed to divert the water at a point near Hazelbush, and to carry it in a general southerly and easterly direction through Butte and into Yuba county.

GOOD ENOUGH

Heavy Deep Furrow Sulky Plow

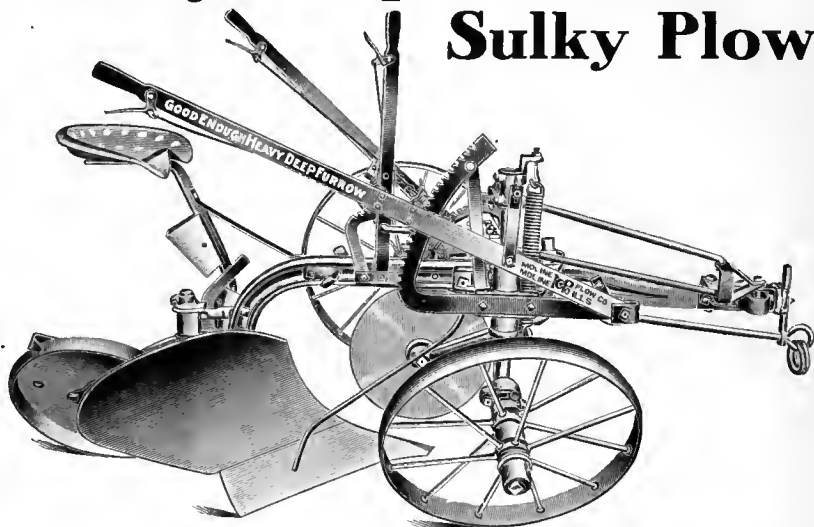

Save Moisture—Increase Yield

Plow deep—form deep moisture reservoirs—increase the feeding area of the plant roots—liberate more plant food. Do these things and your crops will be greatly increased. The Good Enough Heavy Deep Furrow Sulky is the most efficient plow for deep plowing on the market.

The Good Enough Heavy Deep Furrow Sulky is a tremendously strong and powerful plow. It will plow any soil that is capable of being plowed and will turn a furrow from 6 to 15 inches deep.

The landing lever controls both the front furrow wheel and the hitch. The dial hitch can be adjusted to either side and up or down. The draft is applied directly to the beam through the heavy draft rod. The rear wheel is locked in place, but can be instantly released by means of the foot trip at the ends of the rows.

Regularly furnished with five-horse evener, rolling coulter and extra shares.

**See Your Flying Dutchman Dealer
or Write for Information**



Moline Plow Co.

Dept. 3

MOLINE, ILL.



ADAM AND EVE'S FARM WAS IRRIGATED

ADAM and Eve were irrigation farmers. Sir William Wilcocks, the eminent English engineer, whom Secretary of the Interior Lane sent recently on an inspection tour of the United States reclamation projects, is the authority for this statement. He also declares the original garden of Eden had an irrigation system just as scientific and correct from an engineering point of view as any now in the West.

Sir William, whose fame rests upon the building of the great Assouan dam, in Egypt, where he has turned the land of the Pharaohs back to their original fertility, has been recently engaged by the Turkish government in reclaiming ancient Mesopotamia. The success of the English engineer in Egypt caused the Turkish government to loosen its purse strings to the extent of \$75,000,000, and the work is now under way in sections. The English irrigation expert and his engineers have made a careful survey of Mesopotamia and have discovered parts of an ancient system of irrigation so well preserved that some of the canals are to be used in the new project after the mud of centuries is taken out.

It was while on this survey that Sir William found what he believes to be the location of the traditional garden of Eden, with full equipment of irrigation canals. He says the garden of Eden could not have been a garden at all without the irrigation system.

The supposed location of the garden is surrounded by a wall or dike two feet high, with openings for the canals. The English engineer said that during high water in the rivers Euphrates and Tigris the dike kept the water from flooding the garden and in the dry season the gates were open and the water entered the canals.

USE NORTHWEST BY-PRODUCTS

To provide a "safety valve" for the fruit industry of the Pacific Northwest a by-products congress will be held in Spokane, Wash. Nov. 19, in connection with the seventh National Apple Show, out of which is expected to develop a big organization designed to handle the low grade fruit problem in a systematic way. Concerning the meeting Man-

ager Gordon C. Corbaley, of the apple show, says:

"When we recall that 60 per cent of our fruit is marketed as extra fancy or fancy and that the bulk of the remaining 40 per cent is wasted we can clearly see the vital importance of immediate constructive action. The by-product side is the most important feature of California's apple business, and the men who have made a painstaking investigation of our situation in the northwest declare that this business can be developed in a very large way here."

FEDERAL PROJECT WORK

The Reclamation Service is asking for proposals for the reconstruction of Dodson South Canal at Dodson bridge, in connection with the Milk River Irrigation Project, Mont. The work involves about 71,000 cubic yards of excavation, 12,000 cubic yards of puddled filling, 5,200 cubic yards of rip-rap, 40 cubic yards of concrete, and the moving of two steel bridge spans, abutments and pier. The work is situated on the south side of Milk River, about one and one-quarter miles south of Dodson. The bids will be opened at Malta, Mont., on October 28.

The International Portland Cement Company, of Irving, Wash., has obtained a contract for 10,000 barrels of Portland cement for use in connection with the Umatilla Federal Irrigation Project in Oregon. The contract price is \$1.15 per barrel, F. O. B. cars at Irving.

The Reclamation Service has awarded contracts for the construction of the Cave Creek cut-off, Arizona Canal, Salt River Irrigation Project, Arizona, as follows:

Schedules 1 and 2, involving 131,000 cubic yards of excavation, to Martin & Gillis, of Phoenix, Arizona. Contract price, \$15,643.80.

Schedule 3, involving 300 cubic yards of concrete, most of which contains steel reinforcements, and 107 square yards of grouted paving, Haney Bros. & Company, of Oklahoma City, Oklahoma. Contract price, \$2,956.

GALVANIZED METAL IRRIGATION FLUME (Newcomb Patent)

Made entirely of rust-proof, galvanized iron. No bolts or rivets used in construction. This flume is



Section of Flume

considered by experts to be the most serviceable equipment for the purpose on the market. A careful examination of the construction as shown herewith will convince those who are acquainted with irrigation conditions of its lasting quality and the ease with which it may be put together. Complete information, with prices, will be furnished on application to the

KLAUER MFG. COMPANY, Dubuque, Iowa

The Reclamation Service is asking for proposals for the construction of divisions 1, 2, and 3 of the High Line Canal and structures, Strawberry Valley Irrigation Project, Utah.

The work involves approximately 384,000 cubic yards of canal excavation, 2,300 cubic yards of excavation for structures, 3,300 cubic yards of reinforced concrete, 167,000 square feet of canal lining, 230 lineal feet of tunnel complete with concrete lining, laying approximately 1,700 feet of vitrified pipe of miscellaneous sizes; also 1,400 cubic yards of back filling and small quantities of rock filling and stone paving and the placing of sluice gates and miscellaneous structural steel.

The Canal will extend in a southwesterly direction from the power plant of the U. S. Reclamation Service near the mouth of Spanish Fork Canyon, to a point near Payson City, Utah. The bids will be opened on November 15, at Provo, Utah.

The Secretary of the Interior has authorized the Reclamation Service to execute the following contracts for furnishing gates and gate stands for irrigation projects in Montana and Wyoming:

The Minneapolis Steel and Machinery Company, of Minneapolis, Minnesota, Schedules 1, 2, and 3. Contract price \$12,589.00, f. o. b. cars at shipping point.

The Hinman Hydraulic Manufacturing Company, of Denver, Colorado, Schedules 4, 5, 6, 7, and 8. Contracts price, \$11,350.00 f. o. b. cars at shipping point.

These contracts call for structural steel and cast iron sluices and regulator gates, gate frames, gate stands and accessories.

The Portland Cement Company of Utah has the contract for furnishing 3,000 barrels of portland cement for use in connection with the Strawberry Valley irrigation project in Utah. The contract price is \$1.28 per barrel, f. o. b. cars, Salt Lake City.

The Midland Bridge Company of Kansas City, has been awarded the contract for furnishing and erecting a steel bridge at Arrowrock Dam, Boise irrigation project, Idaho. Under this contract, the total cost of the bridge, including freight and erecting, will be \$2,333.83.

The Hinman Hydraulic Manufacturing Company of Denver, Colo., has been given the contract for furnishing steel flumes for the North Platte irrigation project, Nebraska. The contract price is \$6,772.92, f. o. b. cars, Denver, Colo.

GROWS COTTON IN MONTANA

A. T. Thompson has succeeded in growing cotton on his homestead on the Huntley project in Montana. He raised enough this year to pad a quilt, which will be made up by the children on the project and exhibited at the San Francisco exposition. Thompson formerly lived in Texas and is well acquainted with cotton cultivation.

AN EXTRAORDINARY OPPORTUNITY

Good for Thirty Days Only

(This offer terminates November 10)

IRRIGATION AGE has arranged with the important magazines mentioned below for a series of special Discounts in Magazine Subscriptions, good until Nov. 10th only. The volume of subscription business has grown enormously within the last few years. Most people arrange their year's subscription in November and December. The congestion resulting from the necessity of handling almost a year's business in a month or two is a very serious problem. A remedy has suggested itself. Why not induce the public to subscribe early, and thus eliminate many causes for complaints and inevitable delays? It is worth something to accomplish this, and the following money-saving offers are made with this end in view. Here are a number of the worth-while magazine combinations. By subscribing now, an actual saving of from 25 to 100 per cent is possible. This is your opportunity. Why not take advantage of it by sending your order TODAY?

Irrigation Age.....	\$1.00	Our Special Price Until Nov. 10th \$1.50 Thereafter \$1.85
To-Day's Magazine.....	.50	
McCall's Magazine.....	.50	
Total regular price..		\$2.00
Irrigation Age.....	\$1.00	Our Special Price Until Nov. 10th \$1.55 Thereafter \$2.00
Home Needlework.....	.75	
Housewife.....	.50	
Total regular price..		\$2.75
Irrigation Age.....	\$1.00	Our Special Price Until Nov. 10th \$1.60 Thereafter \$1.85
Little Folks Magazine... or Boy's Life or American Boy	1.00	
Total regular price..		
Irrigation Age.....	\$1.00	Our Special Price Until Nov. 10th \$1.75 Thereafter \$2.25
Ladies' World.....	1.00	
McCall's Magazine.....	.50	
Total regular price..		\$2.50
Irrigation Age.....	\$1.00	Our Special Price Until Nov. 10th \$2.00 Thereafter \$2.60
Ladies' World.....	1.00	
Modern Priscilla.....	1.00	
Total regular price..		\$3.00
Irrigation Age.....	\$1.00	Our Special Price Until Nov. 10th \$2.25 Thereafter \$3.15
Mother's Magazine.....	1.50	
Pictorial Review.....	1.00	
Total regular price..		\$3.50
Irrigation Age.....	\$1.00	Our Price Until Nov. 10th, only \$2.50 SPECIAL
Lippincott's Magazine..	3.00	
Total regular price..		\$4.00
Irrigation Age.....	\$1.00	Special Price Until Nov. 10th Only \$2.75 Thereafter \$3.50
Harper's Weekly for 6 mos. Authentic comprehensive, illustrated news of the European war. As a weekly record of current history— brilliant, forceful, authoritative— you will want Harper's Weekly for the next few mos. Rand-McNally War Map of Europe.....	2.50	
Total regular price..		\$1.00
A special war map, size about 2x3 feet, printed in colors, giving full in- formation regarding the fighting strength and resources of the contend- ing forces.		
Total regular price..		\$4.50

Irrigation Age.....	\$1.00	Our Special Price Until Nov. 10th \$2.75 Thereafter \$3.40
Everybody's Magazine..	1.50	
Delineator.....	1.50	
Total regular price..		\$4.00
Irrigation Age.....	1.00	Our Special Price Until Nov. 10th \$2.75 Thereafter \$3.40
Woman's Home Companion	1.50	
American Magazine.....	1.50	
Total regular price..		\$4.00
Irrigation Age.....	1.00	Our Special Price Until Nov. 10th \$2.75 Thereafter \$3.60
Ladies' World.....	1.00	
Modern Priscilla.....	1.00	
Total regular price..		\$4.00
Irrigation Age.....	\$1.00	Our Special Price Until Nov. 10th \$2.75 Thereafter \$3.30
American Magazine.....	1.50	
McClure's Magazine.....	1.50	
Total regular price..		\$4.00
Irrigation Age.....	\$1.00	Our Special Price Until Nov. 10th \$3.00 Thereafter \$3.50
Suburban Life.....	1.00	
The Countryside Magazine	3.00	
Total regular price..		\$4.00
Irrigation Age.....	\$1.00	Our Special Price Until Nov. 10th \$3.15 Thereafter \$3.90
Review of Reviews.....	3.00	
Metropolitan Magazine..	1.50	
Total regular price..		\$5.50
Irrigation Age.....	\$1.00	Our Special Price Until Nov. 10th \$3.25 Thereafter \$3.75
Scribner's Magazine.....	3.00	
or House and Garden or Outing Magazine	-	
Total regular price..		\$4.00
Irrigation Age.....	\$1.00	Our Special Price Until Nov. 10th \$3.25 Thereafter \$4.00
Review of Reviews.....	3.00	
Woman's Home Companion	1.50	
Total regular price..		\$5.50
Irrigation Age.....	\$1.00	Our Special Price Until Nov. 10th \$3.75 SPECIAL
Youth's Companion with Tarbell's Life of Lincoln, in two volumes, 991 pages, cloth binding	2.00	
Total regular price..		
Irrigation Age.....	\$1.00	Our Special Price Until Nov. 10th \$3.90 Thereafter \$4.40
Delineator.....	1.50	
Pictorial Review.....	1.00	
Total regular price..		\$5.00
Woman's Home Companion	1.50	
Total regular price..		\$5.00

Subscriptions can begin with any month. If you are already a subscriber, your subscription will extend one year from the present date of expiration. The magazines may be sent to one address or each to a different address. This affords an opportunity for friends to subscribe together, and makes it possible to use the magazine subscriptions as gifts to friends or relatives. Here is a rare opportunity to provide for Christmas gifts while these low-priced offers are available.

Address all orders and send remittances by check, postal or express money order, to

IRRIGATION AGE, 30 North Dearborn St., Chicago, Ill.

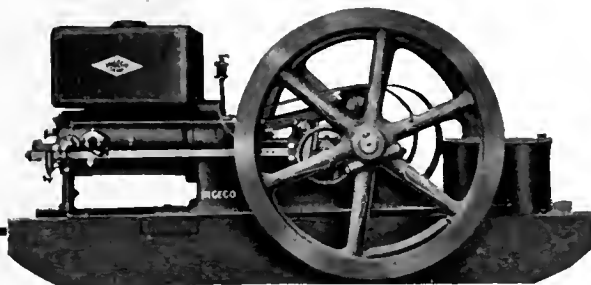

What Will You Look For When You Buy an Engine?

Power? Then the "INGECO" will suit you, for in every size its performance "on duty" exceeds the factory rating. And it's always reliable.

Simplicity? The "INGECO" has few parts and its mechanism is remarkably simple. All parts are accurate and interchangeable.

Fuel Economy? The "INGECO" works perfectly on kerosene, distillates and light oils at about half current cost of gasoline.

Long Life? The sturdy construction of the "INGECO" assures you unusual service.

Safety? The "INGECO" leaves no flame exposed. It's as near accident and fool proof as an engine can be made.

Mechanical Excellence? The "INGECO" is an internal combustion engine of the throttling governor type, which is recognized everywhere as the highest standard of engine design.

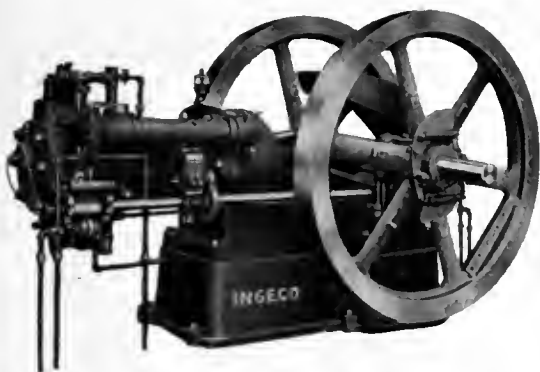

In short, "INGECO" Oil Engines represent the highest degree of engine efficiency. Judged by cost per year of service, they are in the long run an unusually profitable investment.

Do You Need a New FEED MILL?



Write for full information about the "New Holland" for which we are General Northwestern Distributors. It's a big capacity mill of light weight and light draft—that handles all sorts of feed in first class shape at low fuel cost. You can easily do your grinding with a 1½ to 3 H. P. Engine. Get better posted about it.

"INGECO" Oil Engines are made in all sizes from ½ to 350 H. P., vertical and horizontal; portable, semi-portable and stationary types—air or water cooled. Uniform speed under variable loads.

We are prepared to supply **Complete Equipment for Irrigation Plants**, including both **engines** and **pumps** to meet all requirements. Write us for suggestions and estimates of cost.

INTERNATIONAL GAS ENGINE COMPANY

**General Sales Offices and Factory
Holthoff Place, Cudahy, Wis.**

"INGECO" Oil Engines



Purity

American Ingot Iron

ARMCO CULVERTS



Permanence

THE great irrigation companies have many places where corrugated iron pipe, gates and bulkheads can be used to advantage, the only difficulty being that the ordinary material in this form has a rather limited service life. This objection is overcome by the use of high-purity iron. See Engineering News, Jan. 22nd, 1914, **Corrugated Iron Construction on the Sacramento Valley Irrigation Project**, by E. C. Mills, Engineer. (Copy mailed on request.)

The illustration shows part of a shipment of 26 cars of American Ingot Iron Culverts, made to the South San Joaquin Irrigation District, San Joaquin County, California.

Write the nearest manufacturer for particulars and prices on American Ingot Iron Armco Culverts Siphons, Flumes, Plates, Sheets, Roofing and Formed Products:

Arkansas, Little Rock Dixie Culvert & Metal Co.	Kansas, Topeka The Road Sup. & Metal Co.	Nebraska, Lincoln Lee-Arnett Co.	Pennsylvania, Warren Pennsylvania Metal Cul. Co.
California, Los Angeles California Corrugated Culvert Co.	Kentucky, Louisville Kentucky Culvert Co.	Nebraska, Wahoo Nebraska Cul. & Mfg. Co.	South Dakota, Sioux Falls Sioux Falls Metal Cul. Co.
California, West Berkeley California Corrugated Culvert Co.	Louisiana, New Orleans Dixie Culvert & Metal Co.	Nevada, Reno Nevada Metal Mfg. Co.	Tennessee, Nashville Tennessee Metal Culvert Co.
Colorado, Denver R. Hardesty Mfg. Co.	Maryland, Havre de Grace J. N. Spencer.	New Hampshire, Nashua North-East Metal Cul. Co.	Texas, Dallas American Rolling Mill Co. Atlas Metal Works.
Delaware, Clayton Delaware Metal Culvert Co.	Massachusetts, Palmer New England Metal Cul. Co.	New Jersey, Flemington Pennsylvania Metal Cul. Co.	Texas, El Paso Western Metal Mfg. Co.
Florida, Jacksonville Dixie Culvert & Metal Co.	Michigan, Bark River Bark River Bridge & Cul. Co.	New York, Auburn Pennsylvania Metal Cul. Co.	Texas, Houston Lone Star Culvert Co.
Georgia, Atlanta Dixie Culvert & Metal Co.	Michigan, Lansing Michigan Bridge & Pipe Co.	North Carolina, Greensboro Dixie Culvert & Metal Co.	Utah, Woods Cross Utah Culvert Co.
Illinois, Bloomington Illinois Corrugated Metal Co.	Minnesota, Minneapolis Lyle Corrugated Cul. Co.	North Dakota, Wahpeton Northwestern Sheet & Iron Works.	Virginia, Roanoke Virginia Metal & Cul. Co.
Indiana, Crawfordsville W. Q. O'Neall Co.	Minnesota, Lyle Lyle Corrugated Cul. Co.	Ohio, Middletown The Ohio Corrugated Cul. Co.	Washington, Spokane Spokane Corr. Culvert & Tank Co.
Iowa, Des Moines Iowa Pure Iron Culvert Co.	Missouri, Moberly Corrugated Cul. Co.	Oklahoma, Shawnee Dixie Culvert & Metal Co.	Wisconsin, Eau Claire Bark River Bridge & Cul. Co.
Iowa, Independence Independence Corr. Cul. Co.	Montana, Missoula Montana Culvert Co.	Oregon, Portland Coast Culvert & Flume Co.	

When writing to advertisers please mention The Irrigation Age.

