



COURSE CATALOG
2009-2010



Notice:

This catalog is intended to supply accurate information to the reader. From time to time, certain information may be changed.

The College may revise any matter described in this catalog at any time without publishing a revised edition of this catalog. Courses, programs, curricula and program requirements may be changed or discontinued at any time. Information that appears to apply to a particular student should be verified with the Office of Student Affairs at your local campus. Local campus information is found on page 4. The publication and its provisions are not in any way a contract between the student and Ivy Tech Community College.

Ivy Tech is an accredited, equal opportunity, affirmative action state college.

A copy of the most recent annual financial statement can be obtained upon request from the Office of the Treasurer.

© 2009 Ivy Tech Community College.

Message from the President



Welcome to Ivy Tech Community College, the nation's largest single accredited statewide community college system and Indiana's largest college/university. We offer degrees at 29 locations and we have more than 120,000 students studying over 150 different programs throughout Indiana. You have made a wise choice in choosing to continue your education at Ivy Tech Community College. You will find faculty and staff dedicated to assisting you as you progress through your academic studies and complete your certificate or degree program. And whether you choose to enter the workforce after earning your degree/certificate or transfer your credits to another institution to pursue a bachelor's degree, Ivy Tech Community College is committed to giving you the education you need to be competitive and successful.

Not only will your education change your life, but it will also benefit those around you. You will directly contribute to your communities by providing the skills and knowledge needed in today's workplace. Community colleges are growing across the country because they provide education where it is needed the most – in communities that they serve. Ivy Tech Community College stands by its commitment to change the lives of its students and in turn change the state of Indiana. We are proud to have you as an Ivy Tech Community College student.



Tom Snyder, President
Ivy Tech Community College
president@ivytech.edu



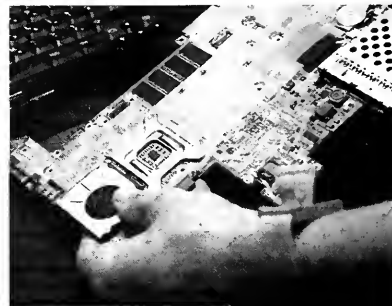

TABLE OF CONTENTS



General Information	1
College Mission	1
College Core Values	1
College Calendar	1
Non-Discrimination and Equal Opportunity	1
Regional Accreditation Statement	1
Academic Calendars	2
How to Use This Catalog	1
How to Use the Programs of Study Section	3
Campuses	4
Programs of Study	5
Ivy Tech Program Inventory	6
Programs of Curriculum	9
Accounting	10
Advanced Manufacturing	11
Agriculture	12
Automotive Technology	14
Aviation Technology	16
Biotechnology	17
Building Construction Management	18
Business Administration	19
Central Service Technician	20
Chemical Technology	21
Community Emergency Preparedness & Management	22
Computer Information Systems	23
Computer Information Technology	25
Construction Technology	27
Criminal Justice	29
Dental Assisting	30
Dental Hygiene	31
Design Technology	32
Early Childhood Education	34
Education	36
Electrical Engineering Technology	36
Electronics & Computer Technology	37
Fine Art	38
General Studies	38
Health Information Technology	39
Hospitality Administration	40
Human Services	41
Industrial Technology	43

Information Security	45
Interior Design	46
Kinesiology	47
Liberal Arts	47
Library Technical Assistant	48
Machine Tool Technology	49
Mechanical Engineering Technology	50
Medical Assisting	51
Medical Laboratory Technology	53
Mortuary Science	54
Nursing	54
Office Administration	56
Paralegal Studies	57
Paramedic Science	59
Physical Therapist Assistant	60
Practical Nursing	60
Pre-Engineering	61
Professional Communication	62
Public Safety	62
Radiation Therapy	64
Radiologic Technology	64
Respiratory Care	65
Surgical Technology	66
Therapeutic Massage	67
Transportation, Distribution and Logistics	68
Visual Communication	68
Course Descriptions	70
Comprehensive Course Description List	71
Program Availability	155
Anderson Campus	156
Batesville Campus	156
Bloomington Campus	156
Columbus Campus	157
Connorsville Campus	157
East Chicago Campus	157
Elkhart Campus	158
Evansville Campus	158
Fort Wayne Campus	159
Gary Campus	160
Greencastle Campus	160
Indianapolis Campus	160

Kokomo Campus	161	Richmond (Richmond)	197
Lafayette Campus	162	Columbus (Columbus)	197
Lawrenceburg Campus	162	Southeast (Lawrenceburg, Madison)	197
Logansport Campus	163	Southwest (Evansville)	197
Madison Campus	163	Southern Indiana (Sellersburg)	198
Marion Campus	163	Bloomington (Bloomington)	198
Michigan City Campus	164	Contact Information for Accrediting Organizations	199
Muncie Campus	164	College Services	201
New Castle Campus	165	Entering the College	202
Richmond Campus	165	Admissions for Non-Degree Enrollment	202
Sellersburg Campus	165	Admissions for Degree Enrollment	202
South Bend Campus	166	Course Placement Assessment	202
Tell City Campus	167	Readmission Following Enrollment Absence	202
Terre Haute Campus	167	Limited Admissions Enrollment	202
Valparasio Campus	167	Admission Procedures and Support Documents—Degree Objective	202
Wabash Campus	168	Secondary Initiatives	203
Warsaw Campus	168	Dual Credit	203
Faculty and Staff	169	Transferring Credit to the College	203
Northwest	170	Admission Procedures and Support Documents—International Students	203
North Central	172	Student Orientation	203
Northeast	174	Advanced Placement Credit and Credit for Prior Learning	203
Lafayette	176	Registration	204
Kokomo	178	Registering for Courses	204
East Central	179	Open/Late Registrations	204
Wabash Valley	181	Course Drop and Add	204
Central Indiana	183	Student Withdrawal	204
Richmond	186	College Fees	204
Columbus	186	Additional expenses	204
Southeast	187	Payment of Fees	204
Southwest	188	Refund Policy	205
Southern Indiana	190	Financial Aid	205
Bloomington	191	Application Procedures for Financial Aid	205
Accreditations and Membership	193	Student Records	205
Northwest (Gary, East Chicago, Michigan City, Valparasio)	194	Dependency Provision	206
North Central (South Bend, Elkhart, Warsaw)	194	Academic Grading	206
North East (Fort Wayne)	194	Grades	206
Lafayette (Lafayette)	195	Status Codes	206
Kokomo (Kokomo, Logansport)	195	Status	206
East Central (Anderson, Marion, Muncie)	195	I—Incomplete	206
Wabash Valley (Terre Haute)	196	AU—Audit	206
Central Indiana (Indianapolis)	196	W—Withdrawal	207

S--Satisfactory	207
U--Unsatisfactory	207
V--Verified Competency	207
Credit Hours	207
Credit Hours Load	207
Enrollment Status	207
Quality Points	207
Grade Point Averages	207
Improving a Grade	207
Dean's List	207
Grade Reports	208
Prior Courseworks	208
Attendance	208
Standards of Progress	208
Special Problems	208
Assessment	208
Graduation	209
Transferring to another Institution	209
Transfer IN	209
Student Support Services	209
Academic Skills Advancement Program Services	210
Academic Advising	210
Career Services	210
College Bookstore	210
Library	210
Disability Support Services	210
Student Life	210
Organizations and Activities	210
Student Government Association (SGA)	211
Phi Theta Kappa	211
Intramural Sports	211
Clubs	211
Social Activities	211
Professional Organizations	211
Leadership Development	211
Community Service	211
Ivy Tech Alumni Association	211
E-Mail	211
Campus Connect: The College Portal Website	211
Housing	212
Student Parking	212
Student Accident Insurance	212

Student Health Insurance	212
Accidents and Illness	212
Voter Registration	212
Emergency Closing of Campus	212
Student Rights and Responsibilities	212
Student Conduct	212
College Rules	213
Repeated Offenses of a Less Serious Nature	215
Policy and Complaint Procedure Against Harassment	215
Reporting and Complaint Procedure	215
Investigation	215
Determination	215
Corrective Action	215
Violations	215
Disciplinary Actions	216
Student Grievance Policy	216
Informal Grievance Procedure	216
Formal Grievance Procedure	216
Format of the Written Grievance	216
Timely Filing of a Formal Grievance	216
Filing the Formal Grievance	216
Mediation	217
Student Status Committee	217
Disposition of a Formal Grievance by the Student Status Committee	217
Appeal to the Office of the President	217
Reinstatement to the College	217
Student Appeal of a Grade	217
Student Right to Know	218
Campus Security Information	218
Jeanne Clery Act (Campus Crime Statistics) Information	218
Campus Sex Crime Prevention Act	218
Instructional Programs	218
Associate of Arts (AA) Degree Programs	219
Associate of Science (AS) Degree Programs	219
Associate of Applied Science (AAS) Degree Programs	219
Associate of Fine Arts (AFA) Degree Programs	219
Technical Certificates (TC) Programs	219
Certificate Programs	219
Distance Learning	219
Apprenticeship Programs	219
Ivy Tech Community College General Education Courses by Category	220



GENERAL INFORMATION



COLLEGE MISSION

Ivy Tech Community College prepares Indiana residents to learn, live, and work in a diverse and globally competitive environment by delivery professional, technical, transfer, and lifelong education. Through its affordable, open-access education and training programs, the College enhances the development of Indiana's citizens and communities and strengthens its economy.

COLLEGE VISION

Indiana's residents, communities, and economy will be transformed by Ivy Tech Community College's leadership in higher education.

CORE VALUES

We value, respect, and promote:

- A Student-centered Environment
- A Faculty/staff-focused Environment
- Diversity
- Integrity
- Community Engagement
- Innovation
- Excellence

NON-DISCRIMINATION AND EQUAL OPPORTUNITY POLICY

Ivy Tech Community College of Indiana provides open admission, degree credit programs, courses and community service offerings, and student support services for all persons regardless of race, color, creed, national origin, religion, gender, sexual orientation, physical or mental disability, age or veteran status. The College also provides opportunities to students on the same non-discriminatory opportunity basis. Persons who believe they may have been discriminated against should contact the campus affirmative action officer, Human Resources Administrator, or Dean of Student Affairs. Ivy Tech Community College of Indiana is an accredited, equal opportunity/affirmative action institution.

COLLEGE CALENDAR

Ivy Tech is on a semester schedule. Fall and spring semesters are 16 weeks long. Summer terms are of varying lengths. Certain dates on the college calendar may vary by campus. Specific start and end dates for the fall, spring and summer semesters are listed in the calendar in this publication.

REGIONAL ACCREDITATION STATEMENT

Ivy Tech Community College is accredited by The Higher Learning Commission of the North Central Association of Colleges and Schools, <http://www.ncahlc.org>, (312) 263-0456.

The Higher Learning Commission
30 N. LaSalle Street, Suite 2400
(800) 621-7400 or (312) 263-0456
Fax: (312) 263-7462

UPCOMING ACADEMIC CALENDARS

Fall 2009

Classes begin
Labor Day Holiday*
Thanksgiving Holiday/Fall Break*
Classes end

August 24, 2009
September 7
November 26-27
December 20

Spring 2010

Classes begin
Martin Luther King, Jr. Holiday
Spring Break
Classes end
Graduation varies; check with your campus

January 11, 2010
January 18
March 7-13
May 9

Summer 2010

Classes begin
Memorial Day Holiday
Distance Education classes begin
Independence Day Holiday
Classes end

May 24, 2010
May 31
June 7
July 5
August 3, 2010

Fall 2010

Classes begin
Labor Day Holiday*
Thanksgiving Holiday/Fall Break*
Classes end

August 23, 2010
September 6
November 25-26
December 19

Spring 2011

Classes begin
Martin Luther King, Jr. Holiday
Spring Break
Classes end
Graduation varies; check with your campus

January 10, 2011
January 17
March 6-12
May 8

Summer 2011

Classes begin
Memorial Day Holiday
Distance Education classes begin
Independence Day Holiday
Classes end

May 23, 2011
May 30
June 6
July 4
August 2

**Some regions/campuses may have additional vacation days; check with your campus for your specific calendar.*

How to Use this Catalog

THIS CATALOG IS EASY TO USE

Just take a minute to flip through it. You'll see right away that it isn't too hard to find what you're looking for. When in doubt, use the table of contents in the front or the index in the back.

IT HAS SIX SECTIONS

General Information and College Services – This section has basic information about the College and its campuses. It includes College history, campus addresses, and other important information such as financial aid, student rights, grading systems, and so on. Get to know this section well.

Degree Programs and Requirements – Use this section to find out which classes to take to earn the degree or certificate you want. It's organized by "program" (such as business administration or industrial technology), and then by "concentration" (such as youth services). You also use this section to find out what degrees are offered in a certain field and how many course credits you need to complete them. It also tells how many credits you'll earn for each course.

Course Descriptions – After you look up the classes you need in Section 2, you'll probably want to know what they're all about. Go to this easy-to-use section for that. Simply find the course number (see sample page at right) in the Program Descriptions section (Section 2) and then look it up in the Course Descriptions section (Section 3). Everything in Section 3 is in alphabetical order.

Program Availability – Ivy Tech offers many educational programs and degrees, but not all programs and degrees are offered at all 23 campuses. This section is designed to help you quickly find which programs are available at the Ivy Tech campus that interests you.

Faculty and Staff – This section is a list of full-time faculty and their educational backgrounds.

Accreditations and Memberships – This section shows which organizations and agencies accredit Ivy Tech Community College, its campuses, and programs.

WATCH FOR SYMBOLS AND TERMS.

A degree or certificate program requires different types of courses. There are four terms that describe course types: "General Education," "Professional/Technical," "Concentration," and "Regionally Determined." Most degrees or certificates require some courses of each type. Other terms you'll see are:

Elective– The term "elective" means you can choose the class you want from those offered on your campus. These are marked with a "*".

Capstone Course– This type of course includes a component that assesses certain skills that will be expected of you as a graduate in the workforce. The assessment typically involves a written assignment. These are marked with a "^".

Regionally Determined – This means your campus decides which classes you must take to complete the degree. In cases where you see courses marked with the symbol "***," it means that one of two courses is required and your campus decides which. In other cases, your campus determines which courses are required to fulfill the degree, based primarily on needs of local business and industry.

Your academic advisor can tell you which classes are required.



IVY TECH
COMMUNITY
COLLEGE

How to Use the Programs of Study Section

All of the pages in the Programs of Study section follow the same format. The page at the right (page 3) contains a typical page from this section. The table below gives the description of each of the keyed items on the sample page.

- A** This tells the name of the educational program.
- B** This describes the educational program.
- C** This tells you the types of careers you can have with a degree within this program.
- D** This tells the degrees available within the educational program.
- E** This tells you the concentrations that are available within this program.
- F** This is the type of degree.
- G** This tells how many credits you need to earn a degree.
- H** This describes the course types and how many credits hours in each you need to earn the degree.
- I** This is the course type symbol.
- J** This is the course number.
- K** This is the course name.
- L** This tells how many credits a course is worth.

COURSE TYPE KEY

- * Elective
- ^ Capstone Course
- *** Regionally Determined

Criminal Justice **A**

Program Description

If you are looking for an opportunity for public service in a challenging job that involves personal responsibility, you may find success in the criminal justice field. Knowledge of sociology, psychology, government and law is helpful in preparing for this career. **B**

Sample Careers

Corrections officer, law enforcement officer **C**

Degrees Available

Associate of Science, Associate of Applied Science **D**

Concentrations Offered

Corrections, Law Enforcement, Youth Services **E**

Availability of concentrations and degrees varies by campus. Contact your local campus for more information. See page 6 for contact information. **F**



Associate of Science

Articulated transfer through an Associate of Science in Criminal Justice is available with Indiana State University, Indiana University and IU-South Bend. To view these Associate of Science transfer degree programs and to see if they are available at your local Ivy Tech campus, students should go to <http://www.ivytech.edu/>.

Students are encouraged to review these options with their advisors, to consult the current catalog of the institution to which they wish to transfer, and to contact the institution to which they wish to transfer. Additional opportunities for course and program transfer may also be available at your local campus. Students should contact the transfer office of their local Ivy Tech for further information.

Associate of Applied Science

To earn this degree, you must have 61-62 credits in the following areas: **G**

General Education Core	19
Professional/Technical Core	27
Concentration Courses	12
Regionally Determined Credits	3-4

General Education (19 Credits)

COMM 101 Fundamentals of Public Speaking	3
COMM 102 Introduction to Personal Communication	3
ENGL 101 English Composition	3
IVYT 1XX Life Skills Elective	1
* MATH 1XX Mathematics Elective	3
PSYC 101 Introduction to Psychology	3
or	
SOCI 111 Introduction to Sociology	3
* XXXX XXX Humanities Elective	3
* XXXX XXX Life/Physical Science Elective	3

Professional/Technical (27 credits)

CRIM 101 Introduction to Criminal Justice Systems	3
CRIM 103 Cultural Awareness	3
CRIM 105 Introduction to Criminology	3

CRIM 110 Introduction to Law Enforcement	3
CRIM 120 Introduction to Courts	3
CRIM 130 Introduction to Corrections	3
CRIM 201 Ethics in Criminal Justice	3
CRIM 240 Criminal Law and Procedure	3
^ CRIM 260 Criminal Justice Research	3

Associate of Applied Science – Concentrations

Choose One of the Following Concentrations

Corrections Concentration (15-16 credits)

Vigorous law enforcement and stringent sentencing rules have increased the number of people being held for trial or imprisoned for their crimes in the last decade. Corrections officers monitor people being detained for trial and those who have been imprisoned.

CRIM 230 Community-Based Corrections	3
CRIM 231 Special Issues in Corrections	3
CRIM 246 Legal Issues in Corrections	3
XXXX XXX Program Elective	3
Regionally Determined Credits:	
CRIM 280 Internship	4
or	
CRIM XXX Criminal Justice elective	3

Law Enforcement Concentration (15-16 credits)

Law enforcement officials provide assistance, respond to emergency calls, investigate crime scenes and testify in court. This concentration places emphasis on developing the skills needed to be a police officer, including law, community relations, procedural law, and criminal investigations.

CRIM 113 Criminal Investigations	3
CRIM 210 Police and Community Relations	3
CRIM 220 Criminal Evidence	3
CRIM XXX Program Elective	3
Regionally Determined Credits:	
CRIM 280 Internship	4
or	
CRIM XXX Criminal Justice elective	3

Campuses

Ivy Tech offers degrees in 29 locations. Courses are offered in communities across the state.

ANDERSON (East Central)

104 West 53rd Street
Anderson, IN 46013-1502
Phone: (765) 643-7133
1-800-644-4882

BATESVILLE (Southeast)

920 County Line Road
Batesville, IN 47006
Phone: (812) 934-3954
1-888-360-0027

BLOOMINGTON (Bloomington)

200 Daniels Way
Bloomington, IN 47404-9272
Phone: (812) 332-1559
1-866-447-0700

COLUMBUS (Columbus)

4475 Central Avenue
Columbus, IN 47203-1868
Phone: (812) 372-9925
1-800-922-4838

CONNORSVILLE (Richmond)

717 W. 21st St.
Connorsville, IN 47331
Phone: (765) 825-9394

EAST CHICAGO (Northwest)

410 E. Columbus Drive
East Chicago, IN 46312-2714
Phone: (219) 392-3600
1-800-843-4882

ELKHART (North Central)

2521 Industrial Parkway
Elkhart, IN 46516-5430
Phone: (574) 293-4657

EVANSVILLE (Southwest)

3501 First Avenue
Evansville, IN 47710-3398
Phone: (812) 426-2865

FORT WAYNE (Northeast)

3800 North Anthony Boulevard
Fort Wayne, IN 46805-1489
Phone: (260) 482-9171
1-800-859-4882

GARY (Northwest)

1440 East 35th Avenue
Gary, IN 46409-1499
Phone: (219) 981-1111
1-800-843-4882

GREENCASTLE (Wabash Valley)

1 North Calbert Way
Greencastle, IN 46135

INDIANAPOLIS (Central Indiana)

50 W. Fall Creek Parkway N. Dr.
Indianapolis, IN 46208-5752
Phone: (317) 921-4800
1-800-732-1470

KOKOMO (Kokomo)

1815 East Morgan Street
Kokomo, IN 46901-1373
Phone: (765) 459-0561
1-800-459-0561

LAFAYETTE (Lafayette)

3101 South Greasy Lane
Lafayette, IN 47903-6299
Phone: (765) 269-5000
1-800-669-4882

LAWRENCEBURG (Southeast)

50 Walnut Dr.
Lawrenceburg, IN 47025-2971
Phone: (812) 537-4010
1-800-715-1058

LOGANSPOUT (Kokomo)

2815 East Market Street
Logansport, IN 46947-2152
Phone: (574) 753-5101

MADISON (Southeast)

590 Ivy Tech Drive
Madison, IN 47250-1881
Phone: (812) 265-2580
1-800-403-2190

MARION (East Central)

261 S. Commerce Drive
Marion, IN 46953-9370
Phone: (765) 662-9843
1-800-554-1159

MICHIGAN CITY (Northwest)

3714 Franklin Street
Michigan City, IN 46360-7311
Phone: (219) 879-9137
1-800-843-4882

MUNCIE (East Central)

4301 South Cowan Road
Muncie, IN 47302-9448
Phone: (765) 289-2291
1-800-589-8324

NEW CASTLE (East Central)

300 Trojan Lane
New Castle, IN 47362
Phone: (765) 521-9012

RICHMOND (Richmond)

2357 Chester Boulevard
Richmond, IN 47374-1298
Phone: (765) 966-2656
1-800-659-4562

SELLERSBURG (Southern Indiana)

8204 Highway 311
Sellersburg, IN 47172-1897
Phone: (812) 246-3301
1-800-321-9021

SOUTH BEND (North Central)

220 Dean Johnson Blvd.
South Bend, IN 46601-3415
Phone: (574) 289-7001
1-888-489-5463

TELL CITY (Southwest)

1034 31st Street
Tell City, IN 47586
Phone: (812) 547-7915

TERRE HAUTE (Wabash Valley)

7999 U.S. Highway 41 South
Terre Haute, IN 47802-4898
Phone: (812) 299-1121
1-800-377-4882

VALPARAISO (Northwest)

3100 Ivy Tech Dr.
Valparaiso, IN 46383-2520
Phone: (219) 464-8514
1-800-843-4882

WABASH (Kokomo)

277 N. Thorne Street
Wabash, IN 4xxxx
Phone: (260) 563-8828

WARSAW (North Central)

3755 Lake City Highway
Warsaw, IN 46580-3901
Phone: (574) 267-5428

OFFICE OF THE PRESIDENT

OFFICE OF THE PROVOST
50 W. Fall Creek Parkway N. Dr.
Indianapolis, IN 46208
Phone: (317) 921-4800

Ivy Tech Community College regions

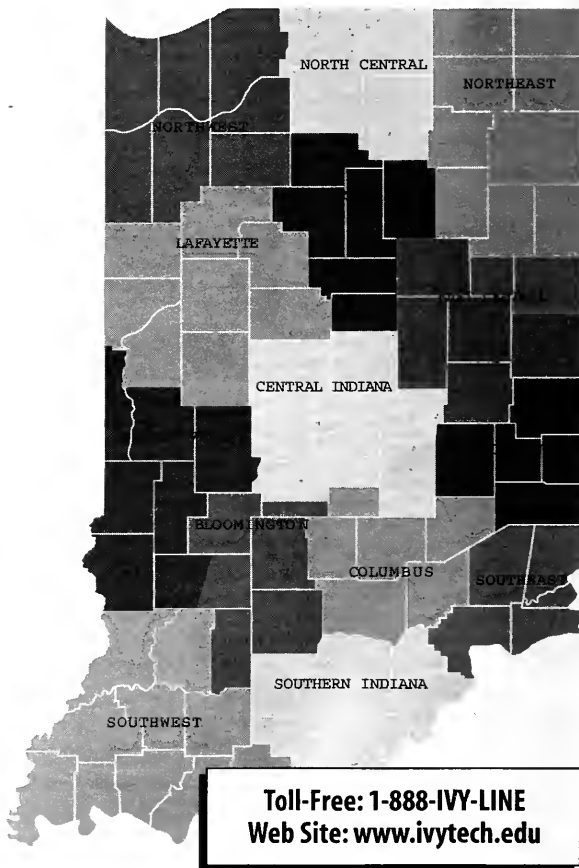

Toll-Free: 1-888-IVY-LINE
Web Site: www.ivytech.edu



PROGRAMS OF STUDY



Ivy Tech Program Inventory

SCHOOL OF APPLIED SCIENCE AND ENGINEERING TECHNOLOGY

Advanced Manufacturing	AAS	
Agriculture	AAS, AS	Concentrations: Agriculture Business Management Agriculture Equipment Management Crop Management Livestock Management
Biotechnology	AAS, AS	
Chemical Technology	AAS	Concentrations: Chemical Lab Tech Forensics Lab Tech
Electrical Engineering Technology	AS	
Kinesiology	AS	
Mechanical Engineering Technology	AS	
Pre-Engineering	AS	

SCHOOL OF BUSINESS

Accounting <i>*Available online</i>	TC, AAS*, AS Certificate	Bookkeeper Fundamental Payroll
Business Administration <i>*Available online</i>	TC, AAS*, AS Certificate	Human Resources Management
Computer Information Systems <i>*Available online</i>	TC, AAS*, AS* Certificate	Concentrations: Database Management Programmer/Analyst Student Directed Studies Web Management Database Java Programming Visual Programming Web Management
Computer Information Technology	TC, AAS	Concentrations: Computer Security Network PC Support and Administration

Computer Information Technology	Certificate	Student Directed Studies Network Administration PC Support and Administration Routing and Switching Systems Security
Information Security	AAS Certificate	Concentrations: Network Security Data Security Network Security Data Security
Office Administration <i>*Available online</i>	TC, AAS*, AS Certificate	Concentrations: Administrative Legal Medical Software Applications Microsoft Office Specialist
Transportation, Distribution and Logistics	AS	

SCHOOL OF EDUCATION

Early Childhood Education <i>*Available online</i>	TC*, AAS*, AS
Education	AS

SCHOOL OF FINE ARTS AND DESIGN

Fine Arts	AFA
Interior Design	AAS Concentrations: Decorative Arts and Design Garden Design Interior Design
Visual Communications	AAS, AS, AFA Concentrations: Film and Video Graphic Design Graphic Media Production Photography Web Design Web Development

SCHOOL OF HEALTH SCIENCES

Central Service Technician	TC
-----------------------------------	----

Dental Assisting	TC	
Dental Hygiene	AS	
Health Information Technology	AS	
Medical Assisting	TC, AAS	Concentrations: Administrative Clinical EKG Generalist Insurance Medical Assistant Pharmacy Technician Phlebotomy Therapeutic Massage Transcription
Medical Laboratory Technology	AAS	
Nursing	AS	
Paramedic Science	AAS, AS	
Physical Therapy Assisting	AS	
Practical Nursing	TC	
Radiation Therapy	AS	
Radiologic Technology	AS	
Respiratory Care	AS	
Surgical Technology	AAS, AS	
Therapeutic Massage	TC, AAS	

SCHOOL OF LIBERAL ARTS AND SCIENCES

General Studies	AS*	
<i>*Available online</i>		
Liberal Arts	AA, AS	Concentrations: English and Communication Foreign Language Humanities Life and Physical Sciences Mathematics Social and Behavioral Sciences
Professional Communication	AS	

SCHOOL OF PUBLIC AND SOCIAL SERVICES

Community Emergency Preparedness and Management	AS	
Criminal Justice	AAS, AS*	Concentrations: Corrections Law Enforcement Youth Services
<i>*Available online</i>		
Hospitality Administration	TC, AAS, AS	Concentrations: Baking and Pastry Arts Culinary Arts Event Management Hotel Management Restaurant Management
Human Services	TC, AAS*, AS*	Concentrations: Correctional Rehabilitation Services Generalist Gerontology Mental Health Substance Abuse
<i>*Available online</i>		
Library Technical Assistant	AS*	Concentrations: Children's Services Library Technology
<i>*Available online</i>		
Mortuary Science	AAS	
Paralegal Studies	AAS*, AS*	
<i>*Available online</i>		
Public Safety	TC, AAS	Concentrations: Environmental Health and Safety Fire Science Hazardous Materials Public Administration

SCHOOL OF TECHNOLOGY

Automotive Technology	TC, AAS, AS	Concentrations: Alternative Fuel Technician Auto Body Repair Auto Service Automotive Service Management Dealer Co-Op Heavy Truck/Diesel High Performance
-----------------------	-------------	--

Automotive Technology		Concentrations Motor Sports Motor Sports Fabrication Automotive Electrical/Electronics Brakes and Suspension Engine Performance Power Train
	Certificate	
Aviation Maintenance Technology	AAS	Concentrations: Aircraft Maintenance Technician
Building Construction Management	AAS, AS	
Building Trades Apprenticeship	TC, AAS, AS	Concentrations: Boilermaker Bricklayer Carpenter Cement Mason Electrical Lineman Electrician Elevator Constructor Floorlayer Glazier Heat/Frost Insulator/Asbestos Worker Ironworker Millwright Mining Operations Operating Engineer Painter Plasterer Plumber/Pipefitter Roofer Sheet Metal Worker Sprinkler Fitter Substation Mechanic Telecommunications Technician
Construction Technology	TC, AAS	Concentrations: Architectural Cabinetry Electrical HVAC Interior Planning and Design Landscape Technology Residential and Light Carpentry

Construction Technology	Certificate	Construction Technician
Design Technology <i>*Available online</i>	TC, AAS*, AS	Concentrations: Architecture CAD-CAM Civil Computer Graphics Mechanical
Electronics and Computer Technology	AAS, AS	
Industrial Apprenticeship	TC, AAS	Concentrations: Electrician Facilities Maintenance Heating Ventilating/Air Conditioning Industrial Mechanic Machine Repair Mechanic-Gas/Electric Vehicles Millwright Mold/Die Maker Pattern Repairer Plumber/Pipefitter Sheet Metal Stationary Power Plant Toolmaker
Industrial Technology	TC, AAS, AS	Concentrations: Heating, Ventilation & Air Conditioning Machining Maintenance Power Plant Process Operations Welding Fluid Power Heating and Air Conditioning Industrial Electrician Machine Tool Welding
Machine Tool Technology	AAS	



PROGRAM CURRICULUM

Key for Curriculum Listings

- * Student Elective
- ** Regionally Determined
- ^ Capstone



Accounting

Program Description

The Accounting program develops an understanding of accounting principles, business law, communications, business equipment and related areas of study in the field. Instruction is offered in computerized accounting systems. Technical skills in financial accounting, cost accounting and tax preparation are emphasized.

Sample Careers

Bookkeeper, payroll clerk, junior or staff accountant

Degrees Available

Associate of Science, Associate of Applied Science, Technical Certificate

Certificates Offered

Bookkeeper, Fundamental Payroll

Concentrations Offered

None

Availability of concentrations and degrees varies by campus. Contact your local campus for more information.



Associate of Science

Articulated transfer through an Associate of Science in Accounting is available with IU Kokomo, IUPUI and IUPUC. To view these transfer degree programs and to see if they are available at your local Ivy Tech campus, students should go to <http://www.ivytech.edu>. Students are encouraged to review these options with their advisors, to consult the current catalog of the institution to which they wish to transfer, and to contact the institution to which they wish to transfer. Additional opportunities for course and program transfer may also be available at your local campus. Students should contact the transfer office of their local Ivy Tech for further information.

Associate of Applied Science

To earn this degree, you must have 61 credits in the following areas:

General Education Core	19
Professional/Technical Core	30
Regionally Determined Credits	12

General Education (19 Credits)

COMM 101 Fundamentals of Public Speaking	3
* ECON XXX Economics Elective	3
ENGL 111 English Composition	3
IVYT 1XX Life Skills Elective	1
** MATH XXX Intermediate Algebra or Higher	3
* XXXX XXX Life/Physical Sciences Elective	3
* XXXX XXX Humanities/Social Sciences Elective	3

Professional/Technical (30 credits)

ACCT 101 Financial Accounting	3
ACCT 102 Managerial Accounting	3
ACCT 105 Income Tax	3
ACCT 201 Intermediate Accounting I	3
ACCT 203 Cost Accounting I	3
^ ACCT 225 Integrated Accounting Systems	3
BUSN 101 Introduction to Business	3
BUSN 102 Business Law	3
CINS 101 Introduction to Microcomputers	3
OFAD 218 Spreadsheets	3

Other Required Courses (12 credits)

Regionally Determined Credits	12
-------------------------------	----

Associate of Applied Science via Distance Education

To earn this degree, you must have 61 credits in the following areas:

General Education	19
Professional/Technical Core	42

General Education (19 Credits)

COMM101 Fundamentals of Public Speaking	3
ECON 201 Principles of Macroeconomics or ECON 202 Principles of Microeconomics	3
ENGL 111 English Composition	3
IVYT 1XX Life Skills Elective	1
MATH 111 Intermediate Algebra	3
XXXX XXX Life/Physical Sciences Elective	3
XXXX XXX Humanities/Social and Behavioral Sci. Elective	3

Professional/Technical (42 credits)

ACCT 101 Financial Accounting	3
ACCT 102 Managerial Accounting	3
ACCT 105 Income Tax	3
ACCT 106 Payroll Accounting	3
ACCT 201 Intermediate Accounting I	3
ACCT 202 Intermediate Accounting II	3
ACCT 203 Cost Accounting I	3
ACCT 207 Accounting for Government and Nonprofit Entities	3
^ ACCT 225 Integrated Accounting Systems	3
BUSN 101 Introduction to Business	3
BUSN 102 Business Law	3
BUSN 210 Managerial Finance or CINT 106 Microcomputer Operating Systems or OFAD 216 Business Communications	3
CINS 101 Introduction to Microcomputers	3
OFAD 218 Spreadsheets	3

Advanced Manufacturing

Technical Certificate

To earn this degree, you must have 31 credits in the following areas:

General Education Core	7
Professional/Technical Core	9
Regionally Determined Credits	15

General Education (7 Credits)

** COMM 101 Fundamentals of Public Speaking or	3
** ENGL 111 English Composition	3
IVYT 1XX Life Skills Elective	1
* XXXX XXX Humanities/Social Sciences Elective	3

Professional/Technical (9 credits)

ACCT 101 Financial Accounting	3
ACCT 102 Managerial Accounting	3
CINS 101 Introduction to Microcomputers	3

Other Required Courses (15 credits)

Regionally Determined Credits	15
-------------------------------	----

Certificate: Bookkeeper

Professional/Technical (18 credits)

ACCT 101 Financial Accounting	3
ACCT 102 Managerial Accounting	3
ACCT 105 Income Tax	3
ACCT 106 Payroll Accounting	3
CINS 101 Introduction to Microcomputers	3
OFAD 218 Spreadsheets	3

Certificate: Fundamental Payroll

Professional/Technical (18 credits)

ACCT 101 Financial Accounting	3
ACCT 106 Payroll Accounting	3
ACCT 122 Accounting Systems Application	3
BUSN 102 Business Law	3
CINS 101 Introduction to Microcomputers	3
OFAD 218 Spreadsheets	3

Program Description

The Advanced Manufacturing Technology program is designed to prepare students for the modern manufacturing environment. This program will prepare you for employment with companies that have implemented team oriented design, production, quality, and maintenance systems within the manufacturing environment.

American manufacturers are becoming increasingly dependent upon the use of high-tech equipment that involves multiple, integrated systems. It is critical that these companies be able to recruit and employ individuals who know how to operate, troubleshoot, and maintain this high-tech equipment.

Sample Careers

Jobs in the manufacturing environment

Degrees Available

Associate of Applied Science

Certificates Offered

Manufacturing Operations, Mechatronics Certification Level I

Concentrations Offered None

Availability of concentrations and degrees varies by campus.
Contact your local campus for more information.

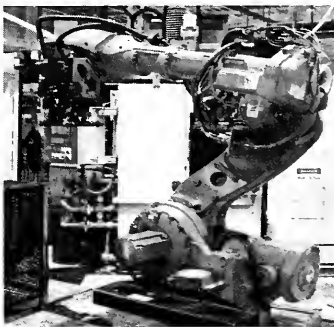

Associate of Applied Science

To earn this degree, you must have 64-65 credits in the following areas:

General Education Core	20-21
Professional/Technical Core	32
Regionally Determined Credits	12

General Education (20-21 Credits)

COMM 101 Fundamentals of Public Speaking	3
ENGL 111 English Composition	3
IVYT 1XX Life Skills Elective	1
MATH 111 Intermediate Algebra	3
MATH 137 Trigonometry with Analytic Geometry	3
PHYS 101 Physics I	4
XXXX XXX Humanities/Social and Behavioral Sciences Elective	3-4

Professional/Technical (44 credits)

ADMF 101 Key Principles of Advanced Manufacturing	3
ADMF 102 Technology in Advanced Manufacturing	3
ADMF 103 Graphic Communications for Manufacturing	3
ADMF 113 Electrical and Electronic Principles for Manufacturing	3
ADMF 115 Materials and Processes for Manufacturing	3
ADMF 116 Automation and Robotics in Manufacturing I	3
ADMF 201 Lean Manufacturing	3
ADMF 206 Automation and Robotics in Manufacturing II	3
ADMF 211 Quality Systems in Manufacturing	3
ADMF 216 Projects in Advanced Manufacturing	3
ADMF 280 Manufacturing Co-op/Internship Elective	2

Regionally Determined Credits (12 credits)

Certificate: Manufacturing Operations

Professional/Technical (21 credits)

ADMF 101	Key Principles of Advanced Manufacturing	3
ADMF 102	Technology in Advanced Manufacturing	3
ADMF 109	Green Manufacturing Operations	3
ADMF 118	World Class Manufacturing	3
ADMF 201	Lean Manufacturing	3
ADMF 211	Quality Systems in Manufacturing	3
MATH 111	Intermediate Algebra	3

Certificate: Mechatronics Certification Level I

Professional/Technical (18 credits)

ADMF 101	Key Principles of Advanced Manufacturing	3
ADMF 102	Technology in Advanced Manufacturing	3
ADMF 112	Mechatronics I	3
ADMF 122	Mechatronics II	3
ADMF 202	Mechatronics III	3
ADMF 222	Mechatronics IV	3



IVY TECH
COMMUNITY
COLLEGE

Agriculture

Program Description

Indiana's agriculture industry is high-growth and high tech. Changes in the business of agriculture and technologies used have tremendous potential for our economy, the environment—and your future. The agriculture AAS degree at Ivy Tech will immerse students in the field of agriculture by taking a core of 27 credit hours of agriculture courses and 18 credit hours of agriculture courses in one of four agriculture concentrations. Students will gain hands-on experience and knowledge through class room, laboratory and field trip activities in a small class size environment with highly educated and experience instructors in agricultural disciplines. A supervised agriculture internship is also required in the curriculum. This internship allows students to apply concepts learned in the classroom, while developing connections within the agriculture industry

Sample Careers

Farm management, technical representative, meat processor

Degrees Available

Associate of Science, Associate of Applied Science

Concentrations Offered

Agriculture Business Management, Agriculture Equipment Management, Crop Management, Livestock Management

Availability of concentrations and degrees varies by campus. Contact your local campus for more information.



Associate of Science

Articulated transfer through an Associate of Science in Agriculture is available with Purdue University. To view these Associate of Science transfer degree programs and to see if they are available at your local Ivy Tech campus, students should go to <http://www.ivytech.edu/>. Students are encouraged to review these options with their advisors, to consult the current catalog of the institution to which they wish to transfer, and to contact the institution to which they wish to transfer. Additional opportunities for course and program transfer may also be available at your local campus. Students should contact the transfer office of their local Ivy Tech for further information.

Associate of Applied Science

To earn this degree, you must have 65-67 credits in the following areas:

General Education Core	19
Professional/Technical Core	27
Concentration Courses	12
Regionally Determined Credits	7-9

General Education (19 Credits)

CHEM 101 Introductory Chemistry I	3
COMM 1XX Communications Elective	3
ENGL 111 English Composition	3
IVYT 1XX Life Skills Elective	1
MATH 1XX Mathematics Elective	3
MATH 1XX Mathematics Elective or SCIN 1XX Science Elective	3
XXXX XXX Humanities/Social and Behavioral Sciences Elective 3	

Professional/Technical (27 credits)

AGRI 100 Introduction to Agriculture	3
AGRI 101 Agricultural Data Management	3
AGRI 110 Introductory Agricultural Business and Economics	3
AGRI 111 Introduction to Crop Production	3
AGRI 113 Introduction to Animal Science	3
AGRI 114 Introduction to Agricultural Systems	3
AGRI 117 Soil Science	3

AGRI 200 Precision Farming Technology	3
AGRI 210 Management Methods for Agriculture Business	3

Choose One of the Following Concentrations

Agriculture Business Management Concentration

(19-21 credits)

The Agricultural Business Management Concentration prepares students for management positions in various agriculture businesses, including agricultural marketing and processing firms, agricultural supply and service firms, and agriculture production and management and farming operations. Students will study sales, advertising, merchandising, economics, farm management, marketing, agronomy and animal science.

AGRI 204 Agriculture Salesmanship	3
AGRI 207 Marketing Agriculture Products	3
AGRI 208 Agriculture Financial Records	3
AGRI 209 Agriculture Commodity Marketing	3
Regionally Determined Credits	7-9

Agriculture Equipment Management Concentration

(19-21 credits)

Agriculture Equipment Management prepares individuals for a career in agriculture the equipment industry. Students will study the management of agriculture businesses while learning about machinery principles of agriculture production. Course work taken for this concentration will prepare students to work as parts assistants, setup technicians, and office support in agriculture equipment businesses

AGRI 213 Agriculture Equipment Power Systems	3
AGRI 219 Crop Machinery and Equipment	3
AUTC 152 Diesel Engine Theory	3
INDT 104 Fluid Power Basics	3
Regionally Determined Credits	7-9

Crop Management Concentration (19-21 credits)

Our state is well-known for its corn and soybeans, but changing technology is broadening the scope of crop production in Indiana. In this concentration, you'll study the science behind crop production, learning how to maximize profit and production, adapt to changing environmental conditions, and how to best use new technology in agronomic row crop management. Careers in with this concentration include fertilizer and pesticide applicators, seed agronomist,

precision agriculture technicians, seed research technicians and home farm operators.

AGRI 216 Disease and Insect Identification and Control	3
AGRI 217 Soil Fertility	3
AGRI 218 Weed Identification and Control	3
AGRI 219 Crop Machinery and Equipment	3
Regionally Determined Credits	7-9

Livestock Management Concentration (19-21 credits)

The Livestock Management Concentration is designed to prepare individuals for a career in the world of animal agriculture. The growing area of animal care requires a strong background in the sciences of behavior, genetics, breeding, reproduction, nutrition and health. Jobs students might get with this degree concentration include herdsman positions, A.I. technicians, livestock managers and home farm operators.

AGRI 202 Animal Production Facilities	3
AGRI 203 Livestock Selection and Evaluation	3
AGRI 205 Animal Nutrition and Livestock Disease	3
AGRI 206 Animal Anatomy and Physiology	3
Regionally Determined Credits	7-9



IVY TECH
COMMUNITY
COLLEGE

Automotive Technology

Program Description

The Automotive Technology program offers exciting careers and unlimited opportunities. Through the use of modern equipment and A.S.E. master certified instructors, students learn how to diagnose and repair the modern automobile. This is a "hands-on" training program that allows plenty of lab time to develop the skills needed to be a successful automotive technician.

Sample Careers

Body repair technician, insurance adjuster, damage appraiser, automotive service and sales manager

Degrees Available

Associate of Science, Associate of Applied Science, Technical Certificate

Certificates Offered

Automotive Electrical/Electronics, Brakes and Suspension, Engine Performance, Power Train

Concentrations Offered

Alternative Fuel Technician, Auto Body Repair, Auto Service, Automotive Service Management, Dealer Co-op, Heavy Truck/Diesel, Motorsports

Availability of concentrations and degrees varies by campus. Contact your local campus for more information.



Associate of Science

Articulated transfer through an Associate of Science in Automotive Technology is available with Indiana State University. To view this Associate of Science transfer degree program and to see if it is available at your local Ivy Tech campus, students should go to <http://www.ivytech.edu/>. Students are encouraged to review this option with their advisors, to consult the current catalog of the institution to which they wish to transfer, and to contact the institution to which they wish to transfer. Additional opportunities for course and program transfer may also be available at your local campus. Students should contact the transfer office of their local Ivy Tech for further information.

Associate of Applied Science

To earn this degree, you must have 67-69 credits in the following areas:

General Education Core	19-20
Professional/Technical Core	24
Concentration Courses	12
Regionally Determined Credits	12-13

General Education (19-20 Credits)

* COMM 101 Fundamentals of Public Speaking	3
or	
COMM 102 Introduction to Interpersonal Communication	3
ENGL 111 English Composition	3
IVYT 1XX Life Skills Elective	1
* MATH 1XX Math Elective	3
** SCIN 111 Physical Science	3
or	
SCIN 101 Science of Traditional and Alternative Energy	4
* XXXX XXX General Education Elective	3
* XXXX XXX Humanities/Social and Behavioral Sci. Elective	3

Professional/Technical (24credits)

AUTC 101 Steering and Suspension Systems	3
AUTC 105 Powertrain Service	3
AUTC 107 Engine Principles and Design	3
AUTC 109 Engine Performance	3

AUTC 113 Electrical and Electronics I	3
AUTC 121 Braking Systems	3
AUTC 123 Electrical and Electronics II	3
AUTC 201 Climate Control Systems	3

Choose One of the Following Concentrations

Alternative Fuel Technician (24-25 credits)

An alternative fuel technician needs an understanding of traditional vehicle maintenance and repair skills combined with knowledge of alternative fuel systems. This concentration will offer training in safe handling of fuel systems and problem solving techniques.

AUTC 103 Principles of Alternative/Renewable Energies	3
AUTC 106 Compressed Natural Gas I	3
AUTC 114 Compressed Natural Gas II	3
^ AUTC 210 Hybrid Systems	3
Regionally Determined Credits	12-13

Automotive Service Management Concentration

(24-25 credits)

Automotive shops operate at their best when they're run smoothly. This concentration will help you develop the necessary wide variety of managerial and technical skills, such as hiring, training, supervision, inventory control, computing, and budget management.

ACCT 101 Financial Accounting	3
^ AUTC 253 Service Organization and Parts	3
BUSN 101 Introduction to Business	3
MKTG 101 Principles of Marketing	3
Regionally Determined Credits	12-13

Auto Service Concentration (24-25 credits)

Modern cars need trained technicians to diagnose and repair them. This concentration offers "hands-on" training in engine rebuilding, fuel injection, automatic transmission/transaxle, computer engine control diagnosis and more.

AUTC 127 Engine Repair	3
AUTC 209 Engine Performance I	3
AUTC 219 Engine Performance II	3
^ AUTC 243 Advanced Electronics	3
Regionally Determined Credits	12-13

Auto Body Repair Concentration (24-25 credits)

Unibody construction and synthetic materials have made advanced training in automotive body repair important for those just entering the fields as well as for those who are currently working. This concentration is designed to teach the skills you need to repair today's auto body.

AUBR 101	Body Repair Fundamentals	3
AUBR 103	Auto Paint Fundamentals	3
AUBR 125	Automotive Body Welding	3
^ AUBR 207	Capstone Course	3
Regionally Determined Credits		12-13

Dealer Co-Op Concentration (24-25 credits)

This ASE/NATEF master certified training program allows you to choose one of the cooperative education specialties which combine classroom and lab training at the college with hands-on work experience at an independent service facility or franchise dealership.

^ AUTC 243	Advanced Electronics	3
AUTC 274	Cooperative - Electrical Systems	3
AUTC 276	Cooperative - Engine Performance	3
TECH 104	Computer Fundamentals for Technology	3
Regionally Determined Credits		12-13

Heavy Truck/Diesel Concentration (24-25 credits)

TRCK 101	Heavy Truck Steering and Suspension	3
TRCK 127	Diesel Engine Repair	3
^ TRCK 219	Diesel Engine Performance	3
TRCK 224	Heavy Truck Electrical Systems	3
Regionally Determined Credits		12-13

Motorsports Concentration (24-25 credits)

Do you like fast cars? Want to work with automotive, aviation, marine, motorcycle, motorsports and racing industries? This training program offers the education demanded by employers. By combining lessons in the classroom with practical hands-on experience in the lab or at the track, you will set your career in gear.

AUTC 149	Introduction to Motor Sports	3
AUTC 250	Motor Sports Fabrication I	3
AUTC 254	High Performance Engines/Systems I	3
^ AUTC 267	Motorsports Project	3

Regionally Determined Credits 12-13

Technical Certificate

To earn this degree, you must have 31 credits in the following areas:

General Education Core	7
Professional/Technical Core	3
Concentration Courses	6
Regionally Determined Credits	15

General Education (7 Credits)

** CDMM XXX	Communications Course	3
IVTY 1XX	Life Skills Elective	1
** XXXX XXX	Humanities/Social and Behavioral Sci. Elective	3

Professional/Technical (3 credits)

AUTC 101	Steering and Suspension Systems	3
----------	---------------------------------	---

Choose One of the Following Concentrations**Alternative Fuel Technician Concentration** (21 credits)

AUTC 113	Electrical and Electronics I	3
AUTC 121	Braking Systems	3
Regionally Determined Credits		15

Auto Body Repair Concentration (21 credits)

AUBR 101	Body Repair Fundamentals	3
AUBR 103	Auto Paint Fundamentals	3
Regionally Determined Credits		15

Automotive Service Management Concentration

(21 credits)

AUTC 113	Electrical and Electronics I	3
AUTC 121	Braking Systems	3
Regionally Determined Credits		15

Heavy Truck/Diesel Concentration (21 credits)

AUTC 113	Electrical and Electronics I	3
TRCK 121	Braking Systems	3
Regionally Determined Credits		15

Motorsports Concentration

(21 credits)

AUTC 107	Engine Principles and Design	3
AUTC 113	Electrical and Electronics	3
Regionally Determined Credits		15

Certificates**Automotive Electrical/Electronics** (18 Credits)

AUTC 109	Engine Performance I	3
AUTC 113	Electrical and Electronics I	3
AUTC 123	Electrical and Electronics II	3
AUTC 201	Climate Control Systems	3
AUTC 209	Engine Performance II	3
AUTC 219	Engine Performance III	3

Brakes and Suspension (18 Credits)

AUTC 101	Steering and Suspension Systems	3
AUTC 105	Powertrain Service	3
AUTC 109	Engine Performance	3
AUTC 113	Electrical and Electronics I	3
AUTC 121	Braking Systems	3
AUTC 123	Electrical and Electronics II	3

Engine Performance (18 Credits)

AUTC 107	Engine Principles and Design	3
AUTC 109	Engine Performance I	3
AUTC 113	Electrical and Electronics I	3
AUTC 209	Engine Performance II	3
AUTC 219	Engine Performance III	3
AUTC 229	Driveability Diagnosis	3

Power Train (18 Credits)

AUTC 105	Powertrain Service	3
AUTC 107	Engine Principles and Design	3
AUTC 113	Electrical and Electronics I	3
AUTC 125	Manual Drivetrains	3
AUTC 127	Engine Repair	3
AUTC 135	Automotive Transmission	3

Aviation Maintenance Technology

Program Description

The Aviation Maintenance Technology program will prepare you to become a certified Aviation Technician with ratings for Airframe or Powerplant. The course of instruction introduces control methods, team building, technical writing and computer skills.

Sample Careers

Employment with commercial air carriers and private maintenance operations

Degrees Available

Associate of Applied Science

Concentrations Offered

Airframe, Powerplant

Availability of concentrations and degrees varies by campus. Contact your local campus for more information.



Associate of Applied Science

To earn this degree, you must have 72-76 credits in the following areas:

General Education Core	20-21
Professional/Technical Core	18
Concentration Courses	30-37

General Education (20-21 Credits)

ENGL 111 English Composition	3
ENGL 211 Technical Writing	3
IVYT 1XX Life Skills Elective	1
MATH 111 Intermediate Algebra	3
MATH 131 Algebra/Trigonometry I	3
PHYS 101 Physics I	4
* XXXX XXX Humanities/Social and Behavioral Sci. Elective	3-4

Professional/Technical (18 Credits)

AVIT 141 Aviation Basics I	3
AVIT 142 Aviation Basics II	3
AVIT 144 Aircraft Electricity	5
AVIT 145 Aircraft Ground Servicing	2
AVIT 146 Aviation Regulations	2
AVIT 148 Aviation Materials and Processes	3

Choose One Of The Following Concentrations

Airframe Concentration (37 Credits)

The airframe concentration prepares you for working on aircraft structures and their associated systems. At the completion of this concentration, you are eligible to take the Federal Aviation Administration's exams. Successful completion of the FAA exams will earn the student a FAA mechanics certificate with an airframe rating.

AVIT 222 Nonmetallic Structures	6
AVIT 226 Airframe Electrical Systems	3
AVIT 227 Aircraft Sheetmetal	8
AVIT 228 Aircraft Instruments and Avionics	3
AVIT 241 Aircraft Fuel System and Welding Practices	3
^ AVIT 242 Aircraft Inspection and Rigging	5
AVIT 243 Aircraft Hydraulic and Pneumatic Systems	3
AVIT 244 Aircraft Landing Gear Systems	3
AVIT 245 Aircraft System	3

Powerplant Concentration (34 Credits)

The powerplant concentration prepares you for working on aircraft piston and turbine engines and their associated systems. At the completion of this concentration, you are eligible to take the Federal Aviation Administration's exams. Successful completion of the FAA exams will earn the student a FAA mechanics certificate with powerplant rating.

AVIT 231 Reciprocating Powerplants	7
AVIT 232 Turbine Powerplants	7
AVIT 233 Powerplant Fuel and Induction Systems	3
AVIT 235 Powerplant Fluid and Indicating Systems	3
AVIT 237 Propellers	5
AVIT 251 Engine Cooling and Exhaust	3
^ AVIT 252 Engine Install, Conformity, and Ignition	3
AVIT 253 Engine Starting System	3



Biotechnology

Program Description

Do you want a career on the cutting edge? The biotechnology program will prepare you to work in a variety of life science laboratory settings. Emphasis is placed on learning applications such as analysis of biological molecules, use of bioreactors and fermentors, recombinant DNA technology, generation of cell cultures and safe operation of laboratory equipment.

Sample Careers

Clinical or Laboratory Technician

Degrees Available

Associate of Science, Associate of Applied Science

Concentrations Offered

None

Availability of concentrations and degrees varies by campus. Contact your local campus for more information.

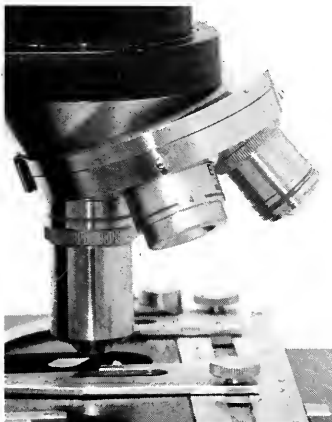

Associate of Science

Articulated transfer through an Associate of Science in Biotechnology is available with IUPUI. To view this Associate of Science transfer degree program and to see if it is available at your local Ivy Tech campus, students should go to <http://www.ivytech.edu/>.

Students are encouraged to review this option with their advisors, to consult the current catalog of the institution to which they wish to transfer, and to contact the institution to which they wish to transfer. Additional opportunities for course and program transfer may also be available at your local campus. Students should contact the transfer office of their local Ivy Tech for further information.

Associate of Applied Science

To earn this degree, you must have 67-68 credits in the following areas:

General Education Core	24-25
Professional/Technical Core	31
Regionally Determined Credits	12

General Education (24-25 Credits)

BIOL 121	General Biology	4
CHEM 105	General Chemistry I	5
CHEM 106	General Chemistry II	5
ENGL 111	English Composition	3
MATH 133	College Algebra with Analytic Geometry	4
or		
MATH 136	College Algebra	3
XXXX XXX	Humanities/Social Science Elective	3
IVYT XXX	Life Skills Elective	1

Professional/Technical (43 credits)

COMM 101	Fundamentals of Public Speaking	3
or		
COMM 102	Introduction to Interpersonal Communication	3
BIOT 101	Introduction to Biotechnology	4
BIOT 103	Safety and Regulatory Compliance for Biotechnology	3
BIOT 201	Cell Culture and Cellular Processes	4
BIOT 211	Analytical Methods for Biotechnology I	3

BIOT 212	Analytical Methods for Biotechnology II	3
BIOT 227	Genetic Engineering and DNA Analysis	4
BIOT 233	Protein Analysis and Purification	4
^ BIOT 280	Internship	3
Regionally Determined Credits		12



Building Construction Management

Program Description

The Building Construction Management program will prepare you for work in residential, commercial and industrial construction and construction consulting. Emphasis is placed on building a foundation in materials science, concrete and soil technology, statics and strength of materials science, surveying and building fabrication.

Sample Careers

Field engineer, Estimator

Degrees Available

Associate of Science, Associate of Applied Science

Concentrations Offered

None

Availability of concentrations and degrees varies by campus. Contact your local campus for more information.

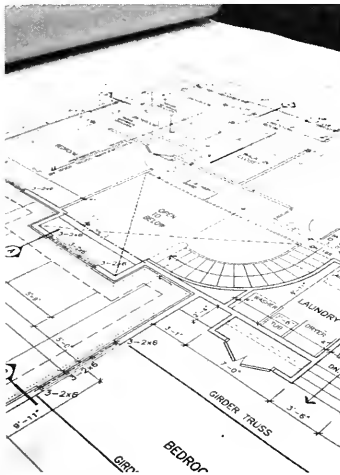

Associate of Science

Articulated transfer through an Associate of Science in Building Construction Management is available with Indiana State University. To view this Associate of Science transfer degree program and to see if it is available at your local Ivy Tech campus, students should go to <http://www.ivytech.edu/>.

Students are encouraged to review this option with their advisors, to consult the current catalog of the institution to which they wish to transfer, and to contact the institution to which they wish to transfer. Additional opportunities for course and program transfer may also be available at your local campus. Students should contact the transfer office of their local Ivy Tech for further information.

Associate of Applied Science

To earn this degree, you must have 62 credits in the following areas:

General Education Core	20
Professional/Technical Core	30
Regionally Determined Credits	12

General Education (20 Credits)

COMM 101	Fundamentals of Public Speaking	3
ENGL 111	English Composition	3
IVYT 1XX	Life Skills Elective	1
MATH 111	Intermediate Algebra	3
MATH 121	Geometry - Trigonometry	3
PHYS 101	Physics I	4
XXXX XXX	Humanities/Social Science Elective	3

Professional/Technical (42 credits)

BCOM 102	Construction Graphics and Print Reading	3
BCOM 104	Commercial and Industrial Construction	3
BCOM 105	Concrete and Soils	3
BCOM 115	Construction Management Practices	3
BCOM 206	Construction Estimating	3
BCOM 210	Codes and Specifications	3
^ BCOM 220	Project Planning and Control	3
DESN 210	Surveying	3

DESN 221	Statics	3
DESN 222	Strength of Materials	3
Regionally Determined Credits		12



IVY TECH
COMMUNITY
COLLEGE

Business Administration

Program Description

Whether your career goal is to start your own business, to advance your career in an existing business, or to continue your education at a four-year institution, the Business Administration program can be a stepping stone on your path to success. The program provides outstanding career opportunities by giving you new job skills or by improving the ones you already possess.

Sample Careers

Sales assistant, first line manager, real estate office assistant, restaurant assistant manager

Degrees Available

Associate of Science, Associate of Applied Science, Technical Certificate

Certificates Offered

Human Resource Management

Concentrations Offered

None

Availability of concentrations and degrees varies by campus. Contact your local campus for more information.

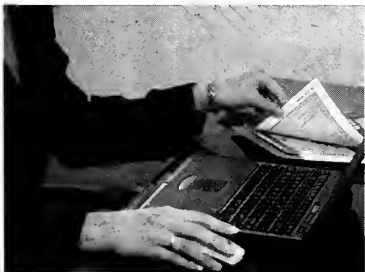

Associate of Science

Articulated transfer through an Associate of Science in Business Administration is available with Ball State University, Indiana State University, IU East, IU Kokomo, IU South Bend, IUPUI Columbus, IUPUI-Fort Wayne, Indiana Wesleyan University, Purdue University and the University of Southern Indiana. To view these Associate of Science transfer degree programs and to see if they are available at your local Ivy Tech campus, students should go to <http://www.ivytech.edu/>.

Students are encouraged to review these options with their advisors, to consult the current catalog of the institution to which they wish to transfer, and to contact the institution to which they wish to transfer. Additional opportunities for course and program transfer may also be available at your local campus. Students should contact the transfer office of their local Ivy Tech for further information.

Associate of Applied Science

To earn this degree, you must have 61-63 credits in the following areas:

General Education Core	19-21
Professional/Technical Core	42

General Education (19-21Credits)

COMM 101	Fundamentals of Public Speaking	3
* ECON XXX	Economics Elective	3
ENGL 111	English Composition	3
IVYT 1XX	Life Skills Elective	1
** MATH 1XX	Mathematics Elective	3
* XXXX XXX	Humanities/Social and Behavioral Sci. Elective	3-4
* XXXX XXX	Life / Physical Sciences Elective	3-4

Professional/Technical (44 credits)

ACCT 101	Financial Accounting	3
ACCT 102	Managerial Accounting	3
BUSN 101	Introduction to Business	3
BUSN 102	Business Law	3
BUSN105	Principles of Management	3
BUSN 120	Business Ethics and Social Responsibility	3

BUSN 202	Human Resources Management	3
^ BUSN 204	Case Problems in Business	3
CINS 101	Introduction to Microcomputers	3
MKTG 101	Principles of Marketing	3
*** XXXX XXX	Regionally Determined Credits	12

Associate of Applied Science via Distance Education

To earn this degree, you must have 61-63 credits in the following areas:

General Education Core	19-21
Professional/Technical Core	42

General Education (19-21Credits)

COMM 101	Fundamentals of Public Speaking	3
* ECON XXX	Economics Elective	3
ENGL 111	English Composition	3
IVYT 1XX	Life Skills Elective	1
** MATH 1XX	Mathematics Elective	3
* XXXX XXX	Humanities/Social And Behavioral Sci. Elective	3-4
* XXXX XXX	Life/Physical Sciences Elective	3-4

Professional/Technical (42 credits)

ACCT 101	Financial Accounting	3
ACCT 102	Managerial Accounting	3
BUSN 101	Introduction to Business	3
BUSN 102	Business Law	3
BUSN 105	Principles of Management	3
BUSN 120	Business Ethics and Social Responsibility	3
BUSN 202	Human Resources Management	3
^ BUSN 204	Case Problems in Business	3
CINS 101	Introduction to Microcomputers	3
MKTG 101	Principles of Marketing	3
*** XXXX XXX	Regionally Determined Credits	12

*** 12 hours of School of Business program electives (credits ACCT, BANK, BUSN, CINS, CINT, INSC, LOGM, MKTG, OFAD, OPMT, SPMT) or 12 hours of self-directed courses with advisor

approval

Technical Certificate

To earn this degree, you must have 31 credits in the following areas:

General Education Core	7
Professional/Technical Core	9
Regionally Determined Credits	15

General Education (7 Credits)

** ENGL111	English Composition	3
IVYT 1XX	Life Skills Elective	1
XXXX XXX	Humanities/Social and Behavioral Sci. Elective	3

Professional/Technical (24 credits)

BUSN 101	Introduction to Business	3
BUSN 105	Principles of Management	3
CINS 101	Introduction to Microcomputers	3
Regionally Determined Credits		15

Certificate

Human Resources Management (21 credits)

BUSN 101	Introduction to Business	3
BUSN 105	Principles of Management	3
BUSN 202	Human Resource Management	3
BUSN 221	Principles of Employment	3
BUSN 222	Benefits Administration	3
BUSN 223	Occupational Safety and Health	3
OPMT 211	Labor Relations	3

Program Description

Find your place in the ever-growing healthcare industry. Central service departments are the center of all activity surrounding supplies and equipment needed in surgery and other patient care areas. You would have a major role in preventing infections by cleaning, decontaminating, assembling, sterilizing, and packaging all instruments used during surgery.

Sample Careers

Central Service Technician

Degrees Available

Technical Certificate

Availability of concentrations and degrees varies by campus. Contact your local campus for more information.



Technical Certificate

To earn this degree, you must have 36 credits in the following areas:

General Education Core	7
Professional/Technical Core	29

General Education (7 Credits)

ENGL 111	English Composition	3
IVYT 1XX	Life Skills Elective	1
PSYC 101	Introduction to Psychology	3

Professional/Technical (29 credits)

CSTC 101	Infection Control Procedures	4
CSTC 102	Surgical Instrumentation	2
CSTC 103	Fundamentals of Health Careers	3
CSTC 104	Clinical Applications I	3
CSTC 105	Fundamentals of Central Service Technician Skills	4
CSTC 106	Clinical Applications II	3
CSTC 107	Application of Central Service Technician Skills	3
CSTC 108	Clinical Applications III	4
HLHS 101	Medical Terminology	3



IVY TECH
COMMUNITY
COLLEGE

Chemical Technology

Program Description

If you're interested in science and mathematics, chemical technology could be for you. The focus of the program is using principles of science, math and technology to prepare and analyze samples in a variety of laboratory settings

Sample Careers

Laboratory Technician, Forensic Technician

Degrees Available

Associate of Applied Science

Concentrations Offered

Chemical Laboratory Technician, Forensics Laboratory Technician

Availability of concentrations and degrees varies by campus. Contact your local campus for more information.



Associate of Applied Science

To earn this degree, you must have 62 credits in the following areas:

General Education Core	23
Professional/Technical Core	22
Concentration Courses	17

General Education (23 Credits)

CHEM 105	General Chemistry I	5
CHEM 106	General Chemistry II	5
* COMM XXX	Communication Elective	3
ENGL 111	English Composition	3
IVYT XXX	Life Skills Elective	1
MATH 136	College Algebra	3
* XXXX XXX	Humanities/Social and Behavioral Sci. Elective	3

Professional/Technical (22 credits)

CHEM 211	Organic Chemistry I	5
CHMT 101	Industrial Laboratory Techniques	3
CHMT 170	Success in Science	1
CHMT 201	Industrial Instrumentation and Techniques I	3
^ CHMT 202	Industrial Instrumentation and Techniques II	3
CHMT 270	Professional Development	1
CHMT 280	Co-op/Internship	3
TECH 104	Computer Fundamentals for Technology	3

Choose One of the Following Concentrations

Chemical Laboratory Technician Concentration

(17 credits)

If you have an interest in science, mathematics, health, or technology, and have good communication skills, you may find success as a chemical lab technician. Chemical lab technicians work in laboratories and production facilities. They use state of the art technological equipment to gather and analyze data.

ADMF 101	Key Principles of Advanced Manufacturing	3
CHEM 212	Organic Chemistry II	5
CHMT 204	Presentation of Technical Issues	3
CHMT 207	Food, Drugs, and Polymers	3
CHMT 210	Quantitative Analysis	3

Forensic Laboratory Technician Concentration

(17 credits)

The forensic laboratory technician concentration will help you develop skills of quantitative and qualitative analysis to be used in laboratories of police departments, crime scene investigation and morgues.

CHEM 212	Organic Chemistry II	5
CHMT 210	Quantitative Analysis	3
CRIM 101	Introduction to the Criminal Justice Systems	3
FORN 101	Introduction to Forensic Science	3
FORN 203	Crime Methods and Techniques	3



IVY TECH
COMMUNITY
COLLEGE

Community Emergency Preparedness & Management

Program Description

Significant changes have occurred since September 2001. The Community Emergency Preparedness and Management program is designed to address those changes and enhance the ability of individuals to prevent and respond safely and recover from natural or man-made disasters.

This program has been carefully designed with input from employers who know the demand of emergency management. In short, careers in emergency preparedness and response and environmental health and safety are in demand. Those benefiting from the associate degree are first responders, firefighters, military personnel, corrections and law enforcement professionals, emergency managers, those in the health care professions, as well as corporate and government workers.

Sample Careers

Environmental science and protection technicians, firefighters, first line supervisors of firefighting and prevention workers

Degrees Available

Associate of Science

Concentrations Offered

None

Availability of concentrations and degrees varies by campus. Contact your local campus for more information.



Associate of Science

To earn this degree, you must have 66-68 credits in the following areas:

General Education Core	24-26
Professional/Technical Core	42

General Education (24-26 Credits)

*English/Communications (9 credits) Choose 3 courses:

COMM 101 Fundamentals of Public Speaking	3
COMM 102 Introduction to Interpersonal Communication	3
ENGL 111 English Composition	3
ENGL 211 Technical Writing	3

*Mathematics (3 credits)

MATH 1XX Mathematics Elective	3
-------------------------------	---

*Humanities/Social Sciences (9 credits) Choose 3 courses:

PHIL 102 Introduction to Ethics	3
POLS 101 Introduction to American Government and Politics	3
POLS 112 State and Local Government	3
PSYC 253 Introduction to Social Psychology	3
SOCI 111 Introduction to Sociology	3

*Life/Physical Sciences (3-5 credits)

BIOL 201 General Microbiology I	4
CHEM 105 General Chemistry	5
CHEM 111 Chemistry I	4
SCIN 111 Physical Science	3

Professional/Technical (42 credits)

CEPM 101 Introduction to Homeland Security	3
CEPM 102 Principles of Emergency Management and Planning	3
CEPM 103 Basic Skills in Emergency Program Management	3
CEPM 104 Disaster and Terrorism Awareness	3
CEPM 105 Introduction to Mitigation	3
CEPM 106 Disaster Response and Recovery Operations	3
CEPM 107 Exercise Program Design, Planning and Evaluation	3
CEPM 210 Understanding and Combating Terrorism	3
CEPM 212 Homeland Security Intelligence Ops and Tactical Skills	3

CEPM 213 Weapons of Mass Destruction and Hazardous Materials	3
CEPM 214 Understanding the Incident Command System	3
CEPM 215 Contingency Planning and Incident Command	3
CEPM 216 Public Information Officers Course	3
^ CEPM 257 Preparedness Practicum	3



IVY TECH
COMMUNITY
COLLEGE

Computer Information Systems

Program Description

Get the knowledge you need to meet today's business requirements in the computer world. The CIS curriculum is designed to provide a flexible and comprehensive education. You will be instructed in both theoretical concepts and practical applications. You also will become familiar with programming languages, operating systems, database management systems, and web design, as well as application programming concepts and practices.

Sample Careers

Information Manager, Website Manager,
Computer Programmer

Degrees Available

Associate of Science, Associate of Applied Science
Technical Certificate

Certificates Offered

Database, Java Programming, Visual Programming
Web Management

Concentrations Offered

Database Management, Programmer/Analyst
Student Directed Studies, Web Management

*Availability of concentrations and degrees varies by campus.
Contact your local campus for more information.*



Associate of Science

Articulated transfer through an Associate of Science in Computer Information Systems is available with Indiana State University, IUPUI, IUPUI-Columbus, IU East and the University of Southern Indiana. To view these Associate of Science transfer degree programs and to see if they are available at your local Ivy Tech campus, students should go to <http://www.ivytech.edu/>.

Students are encouraged to review these options with their advisors, to consult the current catalog of the institution to which they wish to transfer, and to contact the institution to which they wish to transfer. Additional opportunities for course and program transfer may also be available at your local campus. Students should contact the transfer office of their local Ivy Tech for further information.

Associate of Applied Science

To earn this degree, you must have 62-66 credits in the following areas:

General Education Core	19
Professional/Technical Core	31
Concentration Courses	12

General Education (19 Credits)

COMM 101	Fundamentals of Public Speaking	3
* ECON XXX	Economics Elective	3
ENGL 111	English Composition	3
IVYT 1XX	Life Skills Elective	1
** MATH 1XX	Mathematics Elective	3
* XXXX XXX	Humanities/Social Sciences Elective	3
* XXXX XXX	Life/Physical Sciences Elective	3

Professional/Technical (31 credits)

ACCT 101	Financial Accounting	3
BUSN 101	Introduction to Business	3
CINS 101	Introduction to Microcomputers	3
CINS 102	Information Systems Fundamentals	3
CINS 113	Logic, Design and Programming	3
CINS 125	Database Design and Management	3
CINS 157	Web Site Development	3
CINS 203	Systems Analysis and Design	3

^ CINS 279	Capstone Class (new course)	1
CINT 106	Microcomputer Operating Systems	3
CINT 121	Network Fundamentals	3

Choose One of the Following Concentrations

Database Management Concentration (15 credits)

The focus of the Database Management concentration is learning to work with the storage and management of electronic data. Emphasis is placed on learning database management systems software and understanding and recommending user system requirements and data storage methods.

Four courses from list:

CINS 131	Structured Query Language	3
CINS 205	Database Design Using Oracle	3
CINS 215	Field Study	3
CINS 225	Advanced Database Management Systems	3
CINS XXX	Programming Course Involving Database Manipulation	3
CINT 251	Introduction to Systems Security	3
CINS 280	Coop/Internship	1-6

Programmer/Analyst Concentration (12 credits)

Interested in learning a different language? Just like humans, computers speak their own languages. This concentration places emphasis on developing advanced programming skills, mastering a variety of computer languages.

Four courses from list:

CINS 107	Microcomputer Programming	3
CINS 112	Introduction to Simulations and Game Development	3
CINS 118	Introduction to COBOL Programming	3
CINS 121	C/C++/C# Programming	3
CINS 122	RPG Programming Fundamentals	3
CINS 123	Assembler Language Programming	3
CINS 124	Pascal Programming	3
CINS 126	Shell Command Language for Programmers	3
CINS 131	Structured Query Language	3
CINS 136	Introduction to Java Programming	3
CINS 137	Visual Basic Programming	3
CINS 218	Advanced COBOL Programming	3
CINS 221	Advanced C/C++/C# Programming	3

Computer Information Systems continued

CINS 222	Advanced RPG Programming	3
CINS 236	Advanced JAVA Programming	3
CINS 237	Advanced Visual Basic Programming	3
CINS 238	Advanced Simulation and Game Development	3
CINS 253	Graphics Image Lab	3

Student Directed Studies Concentration (12 credits)
The student directed studies concentration allows you to select elective courses from a wide list of options, focusing on specific areas of interest.

Four courses from the list:

ACCT XXX	Accounting Elective	0-12
BUSN XXX	Business Elective	0-12
CINS XXX	Computer Information Systems Elective	0-12
CINT XXX	Computer Information Technology Elective	0-12
CRIM XXX	Criminal Justice Elective	0-12
EECT XXX	Electronics and Computer Technology	0-12
ENGL 211	Technical Writing	0-3
OFAD XXX	Office Administration Elective	0-12
VISC XXX	Visual Communications Elective	0-12

Web Management Concentration

 (12 credits)

Websites must be both appealing and functional. This concentration will help you develop the skills necessary to manage great websites. Those skills include graphic design, understanding of operating systems, principles in eBusiness and programming techniques.

Four courses from the list:

BUSN 209	Introduction to e-Business	3
CINS 136	Introduction to Java Programming	3
CINS 137	Visual Basic Programming	3
CINS 236	Advanced Java Programming	3
CINS 253	Graphic Image Lab	3
CINS 257	Advanced Web Site Development (required)	3
CINS 258	Web Applications Programming	3
CINS 259	Web Administration (required)	3
CINS XXX	Web-based Programming Elective	3
CINT 109	UNIX Operating System	3
CINT 201	Advanced Operating Systems: LINUX (required)	3

Associate of Applied Science via Distance Education

To earn this degree, you must have 62 credits in the following areas:

General Education Core	19
Professional/Technical Core	31
Regionally Determined Credits	12

General Education (19 Credits)

COMM 101	Fundamentals of Public Speaking	3
* EC DN XXX	Economics Elective	3
ENGL 111	English Composition	3
IVYT 1XX	Life Skills Elective	1
** MATH 1XX	IMathematics Elective	3
* XXXX XXX	Humanities/Social Sciences Elective	3
* XXXX XXX	Life/Physical Sciences Elective	3

Professional/Technical (43 credits)

ACCT 101	Financial Accounting	3
BUSN 101	Introduction to Business	3
CINS 101	Introduction to Microcomputers	3
CINS 102	Information Systems Fundamentals	3
CINS 113	Logic, Design and Programming	3
CINS 125	Database Design and Management	3
CINS 157	Web Site Development	3
CINS 203	Systems Analysis and Design	3
CINS 279	Capstone Class	1
CINT 106	Microcomputer Operating Systems	3
CINT 121	Network Fundamentals	3
Regionally Determined Credits		12

Technical Certificate

To earn this degree, you must have 31 credits in the following areas:

General Education Core	7
Professional/Technical Core	3
Concentration Courses	6
Regionally Determined Credits	15

General Education (7 Credits)

ENGL 111	English Composition	3
IVYT 1XX	Life Skills Elective	1
MATH 1XX	Mathematics Elective	3

Professional/Technical (3 credits)

CINS 102	Information Systems Fundamentals	3
----------	----------------------------------	---

Concentration (6 credits)

CINS 113	Logic, Design and Programming	3
CINS 106	Microcomputer Operating Systems	3

Locally Determined Courses (15 credits)

CINS XXX	CINS Course Elective	12
CINS XXX	CINS Course Elective	3
or		
CINT XXX	CINT Course Elective	3

Certificate

Database (27 credits)

CINS 101	Introduction to Microcomputers	3
CINS 102	Information Systems Fundamentals	3
CINS 113	Logic, Design and Programming	3
CINS 125	Database Design and Management	3
CINS 131	Structured Query Language	3
CINS 137	Visual Basic Programming	3
CINS 205	Database Design	3
CINS 225	Advanced Database Management Systems	3
CINS 237	Advanced Visual Basic Programming	3

Computer Information Technology

Java (21 credits)

CINS 101	Introduction to Microcomputers	3
CINS 102	Information Systems Fundamentals	3
CINS 113	Logic, Design and Programming	3
CINS 125	Database Design and Management	3
CINS 136	Introduction to Java Programming	3
CINS 157	Web Site Development	3
CINS 236	Advanced Java Programming	3

Visual Programming (21 credits)

CINS 101	Introduction to Microcomputers	3
CINS 102	Information Systems Fundamentals	3
CINS 113	Logic, Design and Programming	3
CINS 121	C-C++ -C# Programming	3
CINS 125	Database Design and Management	3
CINS 137	Visual Basic Programming	3
CINS 237	Advanced Visual Basic Programming	3

Web Management (27 credits)

CINS 101	Introduction to Microcomputers	3
CINS 102	Information Systems Fundamentals	3
CINS 125	Database Design and Management	3
CINS 157	Web Site Development	3
CINS 257	Advanced Web Site Development	3
CINS 259	Web Administration	3
CINT 106	Microcomputer Operating Systems	3
CINT 121	Network Fundamentals	3
CINT 201	Advanced Operating Systems: Linux	3



IVY TECH
COMMUNITY
COLLEGE

Program Description

IT careers are in abundance and the Computer Information Technology program will prepare you to get the career you want. You will develop skills in network management, network security, computer hardware support and operating system administration. You will be prepared to provide technical support to computer users, including hardware, network and operating system support

Sample Careers

Computer support specialist

Degrees Available

Associate of Applied Science, Technical Certificate

Certificates Offered

Network Administrator, PC Support and Administration
Routing and Switching, Systems Security

Concentrations Offered

Computer Security, Network, PC Support and Administration
Student Directed Studies

*Availability of concentrations and degrees varies by campus.
Contact your local campus for more information.*



Associate of Applied Science

To earn this degree, you must have 62-66 credits in the following areas:

General Education Core	19
Professional/Technical Core	31
Concentration Courses	12-16

General Education (19 Credits)

CDMM 101	Fundamentals of Public Speaking	3
ECON XXX	Economics Elective	3
ENGL 111	English Composition	3
IVYT 1XX	Life Skills Elective	1
MATH 1XX	Mathematics Elective	3
XXXX XXX	Life/Physical Science Elective	3
XXXX XXX	Social Science Elective	3

Professional/Technical (31 credits)

CINS 101	Introduction to Microcomputers	3
CINS 113	Logic, Design and Programming	3
CINS 203	Systems Analysis and Design	3
CINT 106	Microcomputer Operating Systems	3
CINT 121	Network Fundamentals	3
CINT 201	Advanced Operating Systems: LINUX	3
CINT 210	PC Technology Essentials	3
CINT 211	IT Technician	3
CINT 225	Windows Network Operating Systems	3
CINT 251	Introduction to Systems Security	3
CINT 279	Capstone Class	1

Choose One of the Following Concentrations

Computer Security Concentration (12 credits)

This concentration focuses on developing in-depth knowledge and technical skills related to network and information security.

Four courses from the list:

CINT 252	Routers and Firewalls	3
CINT 253	Microsoft Network Security	3
CINT 254	Linux Network Security	3
CINT 271	Field Study	3
CINT 280	Coop/Internship	3
CINT 2XX	CINT Elective	3

Computer Information Technology continued

Network Concentration (12-16 credits)

This concentration focuses on developing in-depth knowledge and technical skills related to creating and maintaining computer network systems.

Four courses from the list:

CINT 125	Windows Client Operating System	3
CINT 135	Novell Administration I	3
CINT 136	Novell Advanced Administration	3
CINT 140	Cisco Discovery: Networking for Home and Small Businesses	4
CINT 141	Cisco Discovery: Working at a Small-to-Medium Business of ISP	4
CINT 240	Cisco Discovery: Introducing Routing and Switching in the Enterprise	4
CINT 241	Cisco Discovery: Designing and Supporting Computer Networks	4
CINT 160	Cisco Exploration: Network Fundamentals	4
CINT 161	Cisco Exploration: Routing Protocols and Concepts	4
CINT 260	Cisco Exploration: LAN Switching and Wireless	4
CINT 261	Cisco Exploration: Accessing the WAN	4
CINT 226	Implementing & Administering a Windows Network Infrastructure	3
CINT 227	Managing a Windows Network	3
CINT 228	Administering Windows Directory Services	3
CINT 235	Networking Technology Concepts	3
CINT 236	Novell Hardware Service and Support	3
CINT 237	Novell Administration III	3
CINT 25X	Security Elective (maximum 3 credit hours)	3

PC Support and Administration Concentration

(12 credits)

This concentration focuses on developing in-depth knowledge and technical skills related to assisting computer users with software, hardware and network needs.

Four courses from the list:

CINS 125	Database Design and Management	3
CINS 151	Integrated Business Software	3
CINS 157	Web Site Development	3
CINS 206	Project Development with High-Level Tools	3
CINT 109	UNIX Operating Systems	3

CINT 120	Data Communications	3
CINT XXX-	CINT Elective (maximum 3 credit hours)	3
EECT 120	Introduction to Electronics	3
CINT 212	Application User Support and Troubleshooting	3
CINT 213	Hardware Support and Troubleshooting	3
CINT 214	Help Desk Tools and Technologies	3
CINT 217	Preventative Maintenance and Data Recovery	3

Student Directed Studies Concentration (15 credits)

The student directed studies concentration allows students to select elective courses from a wide list of options, focusing on specific areas of interest.

ACCT XXX	Accounting Elective	0-12
BUSN XXX	Business Elective	0-12
CINS XXX	Computer Information Systems Elective	0-12
CINT XXX	Computer Information Technology Elective	0-12
EECT XXX	Electronics Elective	0-12
ENGL 211	Technical Writing	0-3
INDT XXX	Industrial Technology Elective	0-12
OFAD XXX	Office Administration Elective	0-12
VISC XXX	Visual Communications Elective	0-12

Technical Certificate

To earn this degree, you must have 31 credits in the following areas:

General Education Core	7
Professional/Technical Core	3
Concentration Courses	6
Regionally Determined Credits	15

General Education (7 Credits)

ENGL 111	English Composition	3
IVYT 1XX	Life Skills Elective	1
MATH 1XX	Mathematics Elective	3

Professional/Technical (3 credits)

CINT 106	Microcomputer Operating Systems	3
----------	---------------------------------	---

Concentration (6 credits)

CINT 121	Network Fundamentals	3
CINT 225	Windows Network Operating Systems	3

Locally Determined Courses (15 credits)

CINS XXX	CINS Course Elective	3
of		
CINT XXX	CINT Course Elective	3
CINT XXX	CINT Course Electives	12

Certificate

Network Administration (21 credits)

CINS 101	Introduction to Microcomputers	3
CINT 106	Microcomputer Operating Systems	3
CINT 121	Network Fundamentals	3
CINT 125	Windows Client Operating System	3
CINT 225	Windows Network Operating Systems	3
CINT 227	Managing a Windows Network	3
CINT 251	Introduction to Systems Security	3

PC Support and Administration (21 credits)

CINS 101	Introduction to Microcomputers	3
CINT 106	Microcomputer Operating Systems	3
CINT 121	Network Fundamentals	3
CINT 125	Windows Client Operating System	3
CINT 201	Advanced Operating Systems: Linux	3
CINT 210	PC Technology Essentials	3
CINT 211	IT Technician	3

Routing and Switching (16 credits)

Four courses from the list:

CINT 140	Cisco Discovery: Networking for Home and Small Businesses	4
CINT 141	Cisco Discovery: Working at a Small-to-Medium Business of ISP	4
CINT 240	Cisco Discovery: Introducing Routing and Switching in the Enterprise	4
CINT 241	Cisco Discovery: Designing and Supporting Computer Networks	4
CINT 160	Cisco Exploration: Network Fundamentals	4
CINT 161	Cisco Exploration: Routing Protocols and Concepts	4
CINT 260	Cisco Exploration: LAN Switching and Wireless	4
CINT 261	Cisco Exploration: Accessing the WAN	4

Systems Security (27 credits)

CINS 101	Introduction to Microcomputers	3
CINT 106	Microcomputer Operating Systems	3
CINT 121	Network Fundamentals	3
CINT 201	Advanced Operating Systems: Linux	3
CINT 225	Windows Network Operating Systems	3
CINT 251	Introduction to Systems Security	3
CINT 252	Routers and Firewalls	3
CINT 253	Microsoft Network Security	3
CINT 254	Linux Networking Security	3

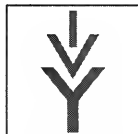

IVY TECH
COMMUNITY
COLLEGE

Construction Technology

Program Description

The construction industry has placed new demands on the building industry. There is a need for employees skilled in estimating, writing specifications for building plans, layout and assembly of residential steel framing, and building restoration and renovation.

This program will give you the knowledge and skills necessary for job success either as a self-employed business person, or as an employee in home improvement centers, plumbing and electrical contractor, carpentry trades, or many other phases within the construction industry.

Sample Careers

HVAC Technician, carpenter, electrical installer

Degrees Available

Associate of Applied Science, Technical Certificate

Certificates Offered

Construction Technician

Concentrations Offered

Architectural, Cabinetry, Electrical, Heating, Ventilation, and Air Conditioning, Home Inspection, Landscape Technology, Residential and Light Carpentry

Availability of concentrations and degrees varies by campus. Contact your local campus for more information.

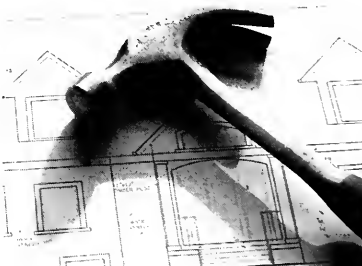

Associate of Applied Science

To earn this degree, you must have 62 credits in the following areas:

General Education Core	20
Professional/Technical Core	18
Concentration Courses	12
Regionally Determined Credits	12

General Education (20 Credits)

COMM 101	Fundamentals of Public Speaking	3
ENGL 111	English Composition	3
IVYT 1XX	Life Skills Elective	1
MATH 1XX	Mathematics Elective	3
MATH 121	Geometry/Trigonometry	3
** PHYS 100	Technical Physics	4
or		
** PHYS 101	Physics 1	4
or		
	Science of Traditional and Alternative Energy	4
* XXXX XXX	Humanities/Social and Behavioral Sci. Elective	3

Professional/Technical (18 credits)

CONT 101	Introduction to Construction Technology	3
CONT 102	Construction Materials	3
CONT 106	Construction Blueprint Reading	3
CONT 127	Electrical Basics	3
^ CONT 204	Estimating and Specifications	3
TECH 104	Computer Fundamentals for Technology	3

Choose One of the Following Concentrations

Architectural Concentration (24 credits)

Get prepared for a career in an architect's office. This coursework includes drafting, residential construction materials, commercial construction materials, geometry, technical math, production drawing, light, medium, and heavy construction drafting.

Four courses from the list:

DESN 105	Architectural Design I	3
DESN 108	Residential Design	3
DESN 204	Architectural Design II	3
DESN 208	Structural Design and Detailing	3
	Regionally Determined Credits	12

Construction Technology continued

Cabinetry Concentration (24 credits)

This concentration places an emphasis on woodworking, design and installation. Learn to build and install cabinetry and to assist clients in selecting and designing residential and commercial cabinetry.

BCOT 120	Woodworking Fundamentals	3
BCOT 121	Furniture Design and Construction	3
BCOT 122	Woodworking Jig Layout	3
BCOT 126	Furniture Door and Drawer Assembly	3
Regionally Determined Credits		12

Electrical Concentration (24 credits)

This concentration can provide you with the knowledge and skills to gain employment as an electrical technician, installer or service provider. The focus of this program is residential and light commercial installation, troubleshooting and maintenance.

BCOT 201	Residential Wiring	3
BCOT 213	Motor and Motor Controls	3
BCOT 220	Electrical Troubleshooting Techniques	3
BCOT 222	Commercial/Industrial Wiring	3
Regionally Determined Credits		12

Heating, Ventilation, and Air Conditioning Concentration (24 credits)

This concentration provides theory and laboratory work in heating, ventilation, and air conditioning (HVAC). As a technician, you'll be prepared for employment in a variety of areas, including: designing HVAC systems for residential, commercial, and industrial applications.

HVAC 101	Heating Fundamentals	3
HVAC 103	Refrigeration I	3
HVAC 104	Heating Service	3
HVAC 106	Refrigeration II	3
Regionally Determined Credits		12

Landscape Technology Concentration (24 credits)

This concentration is designed to provide understanding and skill in the technical requirements for work in any of the many areas of employment in the "green industry." The curriculum is planned to prepare you for positions in landscape construction and management, golf course, park and cemetery maintenance.

LAND 101	Landscape Trees	3
LAND 102	Shrubs and Other Plants	3
LAND 103	Landscape Management I	3

LAND 104	Turf Management I	3
Regionally Determined Credits		12

Residential and Light Carpentry Concentration (24 credits)

The Residential and Light Carpentry Specialty can provide you with the knowledge and skills you need for employment as a carpenter. You will study residential and commercial construction.

BCOT 104	Floor and Wall Layout and Construction	3
BCOT 105	Roof Construction	3
BCOT 114	Exterior Trim	3
BCOT 221	Interior Trim	3
Regionally Determined Credits		12

Surveying Concentration (24 credits)

DESN 103	CAD Fundamentals	3
DESN 106	Descriptive Geometry	3
DESN 210	Surveying	3
DESN 213	CAD Mapping	3
Regionally Determined Credits		12

Technical Certificate

To earn this degree, you must have 31-37 credits in the following areas:

General Education Core	7
Professional/Technical Core	3
Concentration Courses	6-9
Regionally Determined Credits	15-18

General Education (7 Credits)

** COMM 101	Fundamentals of Public Speaking	3
or		
** ENGL 111	English Composition	3
IVYT 1XX	Life Skills Elective	1
* XXXX XXX	Math/Social Sciences/Humanities/Life/Physical Sciences Elective	3

Professional/Technical (3 credits)

CONT 101	Introduction to Construction Technology	3
----------	---	---

Choose One of the Following Concentrations

Architectural Concentration (24 credits)		
DESN 105	Architectural Design I	3

DESN 204	Architectural Design II	3
Regionally Determined Credits		18

Electrical Concentration (24 credits)

BCOT 201	Residential Wiring	3
CONT 127	Electrical Basics	3
Regionally Determined Credits		18

Heating, Ventilation, and Air Conditioning Concentration (24 credits)

HVAC 101	Heating Fundamentals	3
HVAC 103	Refrigeration I	3
Regionally Determined Credits		18

Home Inspection Concentration (24 credits)

BCOT 130	Home Inspection	3
BCOT 131	Residential Building Codes	3
Regionally Determined Credits		18

Landscape Technology Concentration (24 credits)

LAND 101	Landscape Trees	3
LAND 102	Shrubs and Other Plants	3
LAND 103	Landscape Management I	3
Regionally Determined Credits		15

Residential and Light Carpentry Concentration (24 credits)

BCOT 104	Floor and Wall Layout and Construction	3
BCOT 105	Roof Construction	3
Regionally Determined Credits		18

Certificate

Construction Technician (21 credits)

BCOT 104	Floor and Wall Layout and Construction	3
BCOT 105	Roof Construction	3
BCOT 114	Exterior Trim	3
BCOT 221	Furniture Design and Construction	3
CONT 101	Introduction to Construction Technology	3
CONT 106	Construction Blueprint Reading	3
CONT 127	Electrical Basics	3

Criminal Justice

Program Description

If you are looking for an opportunity for public service in a challenging job that involves personal responsibility, you may find success in the criminal justice field. Knowledge of sociology, psychology, government and law is helpful in preparing for this career.

Sample Careers

Corrections officer, law enforcement officer

Degrees Available

Associate of Science, Associate of Applied Science

Concentrations Offered

Corrections, Law Enforcement, Youth Services

Availability of concentrations and degrees varies by campus. Contact your local campus for more information.



Associate of Science

Articulated transfer through an Associate of Science in Criminal Justice is available with Indiana State University, Indiana University and IU-South Bend. To view these Associate of Science transfer degree programs and to see if they are available at your local Ivy Tech campus, students should go to <http://www.ivytech.edu>.

Students are encouraged to review these options with their advisors, to consult the current catalog of the institution to which they wish to transfer, and to contact the institution to which they wish to transfer. Additional opportunities for course and program transfer may also be available at your local campus. Students should contact the transfer office of their local Ivy Tech for further information.

Associate of Applied Science

To earn this degree, you must have 61-62 credits in the following areas:

General Education Core	19
Professional/Technical Core	27
Concentration Courses	12
Regionally Determined Credits	3-4

General Education (19 Credits)

COMM 101 Fundamentals of Public Speaking or	3
COMM 102 Introduction to Interpersonal Communication	3
ENGL 111 English Composition	3
IVYT 1XX Life Skills Elective	1
* MATH 1XX Mathematics Elective	3
PSYC 101 Introduction to Psychology or	3
SOCI 111 Introduction to Sociology	3
* XXXX XXX Humanities Elective	3
* XXXX XXX Life/Physical Science Elective	3

Professional/Technical (27 credits)

CRIM 101 Introduction to Criminal Justice Systems	3
CRIM 103 Cultural Awareness	3
CRIM 105 Introduction to Criminology	3

CRIM 110 Introduction to Law Enforcement	3
CRIM 120 Introduction to Courts	3
CRIM 130 Introduction to Corrections	3
CRIM 201 Ethics in Criminal Justice	3
CRIM 240 Criminal Law and Procedure	3
^ CRIM 260 Criminal Justice Research	3

Associate of Applied Science – Concentrations

Choose One of the Following Concentrations

Corrections Concentration (15-16 credits)

Vigorous law enforcement and stringent sentencing rules have increased the number of people being held for trial or imprisoned for their crimes in the last decade. Corrections officers monitor people being detained for trial and those who have been imprisoned.

CRIM 230 Community-Based Corrections	3
CRIM 231 Special Issues in Corrections	3
CRIM 246 Legal Issues in Corrections	3
XXXX XXX Program Elective	3
Regionally Determined Credits:	
CRIM 280 Internship or	4
CRIM XXX Criminal Justice elective	3

Law Enforcement Concentration (15-16 credits)

Law enforcement officials provide assistance, respond to emergency calls, investigate crime scenes, and testify in court. This concentration places emphasis on developing the skills needed to be a police officer, including law, community relations, procedural law and criminal investigations.

CRIM 113 Criminal Investigations	3
CRIM 210 Police and Community Relations	3
CRIM 220 Criminal Evidence	3
CRIM XXX Program Elective	3
Regionally Determined Credits:	
CRIM 280 Internship or	4
CRIM XXX Criminal Justice elective	3

Criminal Justice continued

Youth Services Concentration (15-16 credits)

This concentration will prepare you to work with youth offenders and their families as they navigate the judicial and correctional system. Youth services professionals strive to prevent youth offenders from committing future crimes by helping the youth and the families discover the causes of illegal behavior.

CRIM 150 Juvenile Justice Systems	3
CRIM 250 Juvenile Law and Procedures	3
CRIM 251 Special Issues in Youth Services	3
CRIM 252 Juvenile Delinquency	3
Regionally Determined Credits:	
CRIM 280 Internship or	4
CRIM XXX Criminal Justice elective	3

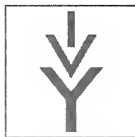

IVY TECH
COMMUNITY
COLLEGE

Dental Assisting

Program Description

The dental assistant is an integral part of the dental health care team. Dental assistants prepare a patient for an exam; pass instruments to the doctor; prepare dental materials; expose and develop X-rays; teach preventative dental care; sterilize instruments; and / or perform dental receptionist duties. You could be instrumental in helping a patient be less anxious about having a dental check up. You could help a child understand why brushing their teeth is important.

Sample Careers

Dental assistant

Degrees Available

Technical Certificate

Concentrations Offered

None



Technical Certificate

To earn this degree, you must have 40 credits in the following areas:

General Education Core	7
Professional/Technical Core	33

General Education (7 Credits)

COMM 102 Introduction to Interpersonal Communication	3
ENGL 111 English Composition	3
IVYT 1XX Life Skills Elective	1

Professional/Technical (33 credits)

DENT 102 Dental Materials and Laboratory I	3
DENT 115 Preclinical Practice I	4
DENT 116 Dental Emergencies/Pharmacology	2
DENT 117 Dental Office Management	2
DENT 118 Dental Radiography	4
DENT 122 Clinical Practicum I	1
DENT 123 Dental Anatomy	2
DENT 124 Preventive Dentistry/Diet and Nutrition	2
DENT 125 Preclinical Practice II	3
DENT 129 Dental Materials and Laboratory II	3
^ DENT 130 Clinical Practicum II	5
DENT 131 Basic Integrated Science	2



IVY TECH
COMMUNITY
COLLEGE

Dental Hygiene

Program Description

The Ivy Tech Community College Dental Hygiene program educates a group of diverse dental hygiene students by providing a curriculum which reflects the core values of the profession, instills an understanding of life-long learning, and educates the graduate to assess, plan, implement, and evaluate dental hygiene care for the individual and the community. As a graduate of this program, you will be eligible to take national and state/regional examinations for licensure which are required to practice dental hygiene.

The dental hygienist is an integral part of the dental health care team who specializes in preventive dental care and techniques in oral hygiene. Common procedures performed by hygienists include cleaning, scaling and root planing, radiography, and application of dental sealants. Local dental regulations determine the duties hygienists are able to perform.

Sample Careers

Dental Hygienist

Degrees Available

*Associate of Science

Concentrations Offered

None
Availability of concentrations and degrees varies by campus.
Contact your local campus for more information.



Associate of Science

To earn this degree, you must have 77 credits in the following areas:

General Education Core:	29
Professional/Technical Core:	48

General Education (29 Credits)

# APHY 101	Anatomy and Physiology I	3
# APHY 102	Anatomy and Physiology II	3
# BIOL 211	Microbiology I	3
# CHEM 111	Chemistry I	4
COMM 101	Fundamentals of Public Speaking	3
or		
COMM 102	Introduction to Interpersonal Communication	3
# ENGL 111	English Composition	3
IVYT 1XX	Life Skills Elective	1
# MATH 111	Intermediate Algebra	3
PSYC 101	Introduction to Psychology	3
SOCI 111	Introduction to Sociology	3

Professional/Technical (48 credits)

DHYG 101	Fundamentals of Dental Hygiene	2
DHYG 102	Fundamentals of Dental Hygiene Lab	2
DHYG 103	Dental Radiology	2
DHYG 104	Dental Anatomy	2
DHYG 105	Nutrition and Oral Health	2
DHYG 106	Oral Histology and Embryology	1
DHYG 107	Head and Neck Anatomy	1
DHYG 109	Preventive Dentistry	1
DHYG 113	Dental Radiography Clinic I	1
DHYG 114	Dental Hygiene Clinic I	5
DHYG 120	Pharmacology	2
DHYG 121	Medical and Dental Emergencies	1
DHYG 122	General Pathology	1
DHYG 201	Community and Public Health Dentistry	3
DHYG 203	Dental Materials	2
DHYG 204	Pain Management	2

DHYG 208	Periodontology	2
DHYG 222	Oral Pathology	2
DHYG 224	Dental Hygiene Clinic II	5
DHYG 228	Dental Hygiene Clinical Procedures	1
^ DHYG 230	Clinic Seminar	2
DHYG 234	Dental Hygiene Clinic III	6

Courses must be successfully completed before admittance to the program.



IVY TECH
COMMUNITY
COLLEGE

Design Technology

Program Description

Look around your surroundings and consider the opportunities. Consider your favorite hobbies, toys, and necessities. It all had to be designed. Do you want to know the secrets of good design? The Design Technology Program will show you how you can become a valuable member of a process engineering team. You'll learn how to design solutions for modifying new or existing buildings, developing innovative commercial products, creating compelling animations and technical brochures, or carving complex machine parts from simple blocks of wood. Choose from one of four specialties—Architectural, Mechanical, Graphics or CAD-CAM—and you'll be on your way to an exciting career in an in-demand field.

Sample Careers

Designer, drafter, graphic designer, surveyor

Degrees Available

Associate of Science, Associate of Applied Science
Technical Certificate

Concentrations Offered

Architecture, Civil, CAD-CAM, Computer Graphics, Mechanical

*Availability of concentrations and degrees varies by campus.
Contact your local campus for more information.*

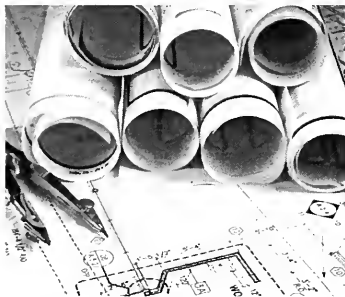

Associate of Science

Articulated transfer through an Associate of Science in Design Technology is available with Indiana State University and Purdue Calumet. To view these Associate of Science transfer degree programs and to see if they are available at your local Ivy Tech campus, students should go to <http://www.ivytech.edu>.

Students are encouraged to review these options with their advisors, to consult the current catalog of the institution to which they wish to transfer, and to contact the institution to which they wish to transfer. Additional opportunities for course and program transfer may also be available at your local campus. Students should contact the transfer office of their local Ivy Tech for further information.

Associate of Applied Science

To earn this degree, you must have 62-63 credits in the following areas:

General Education Core	20-21
Professional/Technical Core	18
Concentration Courses	12
Regionally Determined Credits	12

General Education (20-21 Credits)

COMM 101	Fundamentals of Public Speaking	3
ENGL 111	English Composition	3
IVYR 1XX	Life Skills Elective	1
** MATH 111	Intermediate Algebra	3
and		
** MATH 121	Geometry/Trigonometry	3
or		
** MATH 131	Algebra/Trigonometry I	3
and		
** MATH 132	Algebra/Trigonometry II	3
or		
** MATH 133	College Algebra	4
and		
** MATH 134	Trigonometry	2
or		
** MATH 136	College Algebra	3
and		
** MATH 137	Trigonometry with Analytic Geometry	3
** PHYS 101	Physics I	4
* XXXX XXX	Humanities/Social and Behavioral Sci. Elective 3-4	

Professional/Technical (18 credits)

DESN 102	Technical Graphics	3
DESN 103	CAD Fundamentals	3
DESN 106	Descriptive Geometry	3
DESN 220	Advanced CAD	3
DESN 221	Statics	3
^ DESN 225	Portfolio Preparation	3

Choose One of the Following Concentrations

Architecture Concentration (24 credits)

Everyone enjoys attractively designed residential areas, public parks, and playgrounds, college campuses, shopping centers, golf courses, parkways, and industrial parks. Architects help design these areas so that they are not only functional but beautiful and compatible with the environment as well.

DESN 105	Architectural Design I	3
DESN 109	Construction Materials and Specifications	3
DESN 204	Architectural Design II	3
DESN 208	Structural Design and Detailing	3
	Regionally Determined Credits	12

Civil Concentration (24 credits)

The civil concentration places emphasis on construction materials, structural design and surveying. You will be prepared for employment with civil engineering firms, construction firms, surveying firms and highway departments.

DESN 109	Construction Materials and Specifications	3
DESN 210	Surveying	3
DESN 213	CAD Mapping	3
DESN 228	Civil I	3
	Regionally Determined Credits	12

Computer-Aided Design and Manufacturing

Concentration (24 credits)

Manufacturing or CAD/CAM design technologists translate engineers' and designers' ideas into graphic form. This places emphasis on using CNC programming, and CAD/CAM technology in design and manufacturing applications.

ADMF 115	Materials and Processes for Manufacturing	3
MTTC 208	CNC Programming I	3
MTTC 220	CAD/CAM I	3
MTTC 221	CAD/CAM II	3
	Regionally Determined Credits	12

Computer Graphics Concentration (24 credits)

This new concentration combines Technical Drawing and Fine Arts Drawing. You will be prepared to find employment as graphic illustrators and commercial artists who design parts catalogs, magazine and newspaper advertising, as well as entry level animation used in movie production.

DESN 130	Fundamentals of Computer Graphics	3
DESN 132	Raster Imagine Fundamentals	3
DESN 133	Vector Imaging Fundamentals	3
DESN 230	Computer Modeling and Animation	3
Regionally Determined Credits		12

Mechanical Concentration (24 credits)

Mechanical disciplines work in many industries that vary by industry and function. Some specialties include applied mechanics, computer-aided-design and manufacturing; energy systems; material handling systems; pressure vessel and piping systems; heating, refrigeration and air condition systems.

ADMF 115	Materials and Processes for Manufacturing	3
DESN 104	Mechanical Graphics	3
DESN 214	Kinematics of Machinery	3
DESN 217	Design Process and Applications	3
Regionally Determined Credits		12

Associate of Applied Science via Distance Education

To earn this degree, you must have 62-63 credits in the following areas:

General Education-Core	20-21
Professional/Technical Core	42

Architecture Concentration (62-63 Credits)**General Education** (20-21 Credits)

COMM 101	Fundamentals of Public Speaking	3
ENGL 111	English Composition	3
IVYT 1XX	Life Skills Elective	1
MATH 111	Intermediate Algebra	3
MATH 121	Geometry/Trigonometry	3
PHYS 101	Physics I	4
XXXX XXX	Humanities/Social & Behavioral Sci. Elective	3-4

Professional/Technical Core (42 credits)

DESN 102	Technical Graphics	3
DESN 103	CAD Fundamentals	3
DESN 105	Architectural Design I	3
DESN 106	Descriptive Geometry	3
DESN 109	Construction Materials and Specifications	3
DESN 204	Architectural Design II	3
DESN 220	Advanced CAD	3
DESN 221	Statics	3
DESN 222	Strength of Materials	3
DESN 225	Portfolio Preparation	3
DESN 228	Civil I	3

Choose 3 courses from the list below:

DESN 108	Residential Design	3
DESN 113	Intermediate CAD	3
DESN 206	Mechanical and Electrical Equipment	3
DESN 209	Estimating	3
DESN 210	Surveying	3
DESN 213	CAD Mapping	3
DESN 228	Civil I	3
DESN 280	Co-Op/Internship	3
INDT 113	Basic Electricity	3
TECH 104	Computer Fundamentals for Technology	3

Civil Concentration (62-63 Credits)**General Education** (20-21 Credits)

COMM 101	Fundamentals of Public Speaking	3
ENGL 111	English Composition	3
IVYT 1XX	Life Skills Elective	1
MATH 111	Intermediate Algebra	3
MATH 121	Geometry/Trigonometry	3
PHYS 101	Physics I	4
XXXX XXX	Humanities/Social Sciences Elective	3-4

Professional/Technical Core (42 credits)

DESN 102	Technical Graphics	3
DESN 103	CAD Fundamentals	3
DESN 106	Descriptive Geometry	3
DESN 109	Construction Materials and Specifications	3
DESN 208	Structural Design and Detailing	3

DESN 210	Surveying	3
DESN 213	CAD Mapping	3
DESN 220	Advanced CAD	3
DESN 221	Statics	3
DESN 222	Strength of Materials	3
DESN 225	Portfolio Preparation	3
Choose 3 courses from the list below:		
DESN 105	Architectural Design I	3
DESN 108	Residential Design	3
DESN 110	Architectural Rendering	3
DESN 204	Architectural Design II	3
DESN 206	Mechanical and Electrical Equipment	3
DESN 209	Estimating	3
DESN 228	Civil I	3
DESN 280	Co-Op/Internship	3
TECH 104	Computer Fundamentals for Technology	3

Computer-Aided Design and Manufacturing**Concentration** (62-63 Credits)**General Education** (20-21 Credits)

COMM 101	Fundamentals of Public Speaking	3
ENGL 111	English Composition	3
IVYT 1XX	Life Skills Elective	1
MATH 111	Intermediate Algebra	3
MATH 121	Geometry/Trigonometry	3
PHYS 101	Physics I	4
XXXX XXX	Humanities/Social Sciences Elective	3-4

Professional/Technical Core (42 credits)

DESN 102	Technical Graphics	3
DESN 103	CAD Fundamentals	3
DESN 106	Descriptive Geometry	3
DESN 220	Advanced CAD	3
DESN 221	Statics	3
DESN 222	Strength of Materials	3
DESN 225	Portfolio Preparation	3
MTTC 208	CNC Programming I	3
MTTC 220	CAD/CAM I	3
MTTC 221	CAD/CAM II 3	

Design Technology continued

TECH 101	Processes and Materials	3
Choose 3 courses from the list below:		
DESN 104	Mechanical Graphics	3
DESN 202	CAD Customization and Programming	3
DESN 214	Kinematics of Machinery	3
DESN 217	Design Process and Applications	3
DESN 227	Geometric Dimensioning and Tolerancing	3
DESN 280	Co-Op/Internship	3
INDT 104	Fluid Power Basics	3
INDT 113	Basic Electricity	3
TECH 104	Computer Fundamentals for Technology	3

Mechanical Concentration (62-63 Credits)

General Education (20-21 Credits)

COMM 101	Fundamentals of Public Speaking	3
ENGL 111	English Composition	3
IVYT 1XX	Life Skills Elective	1
MATH 111	Intermediate Algebra	3
MATH 121	Geometry/Trigonometry	3
PHYS 101	Physics I	4
XXXX XXX	Humanities/Social Sciences Elective	3-4

Professional/Technical Core (42 credits)

DESN 102	Technical Graphics	3
DESN 103	CAD Fundamentals	3
DESN 104	Mechanical Graphics	3
DESN 106	Descriptive Geometry	3
DESN 214	Kinematics of Machinery	3
DESN 217	Design Process and Applications	3
DESN 220	Advanced CAD	3
DESN 221	Statics	3
DESN 222	Strength of Materials	3
^ DESN 225	Portfolio Preparation	3
TECH 101	Processes and Materials	3

Choose 3 courses from the list below:

DESN 113	Intermediate CAD	3
DESN 202	CAD Customization and Programming	3
DESN 206	Mechanical and Electrical Equipment	3
DESN 210	Surveying	3
DESN 227	Geometric Dimensioning and Tolerancing	3

DESN 280	Co-Op/Internship	3
INDT 104	Fluid Power Basics	3
INDT 113	Basic Electricity	3
MTTC 208	CNC Programming I	3
MTTC 220	CAD/CAM I	3
TECH 104	Computer Fundamentals for Technology	3

Technical Certificate

To earn this degree, you must have 31-32 credits in the following areas:

General Education Core	7-8
Professional/Technical Core	3
Concentration Courses	6
Regionally Determined Credits	15

General Education (7-8 Credits)

ENGL 111	English Composition	3
IVYT 1XX	Life Skills Elective	1
** XXXX XXX	General Education Elective	3-4

Professional/Technical (3 credits)

DESN 102	Technical Graphics	3
----------	--------------------	---

Other Required Courses (21 credits)

DESN 103	CAD Fundamentals	3
DESN 106	Descriptive Geometry	3
Regionally Determined Credits	15	

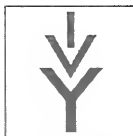

IVY TECH
COMMUNITY
COLLEGE

Early Childhood Education

Program Description

The Early Childhood Education Program focuses on early child growth and development including adult-child relationships. Emphasis is placed on the development of skills and techniques for providing appropriate environments and care for young children. Instruction is provided in the physical, emotional, social, and cognitive areas of early childhood. The student develops competencies through classroom instruction, observation, and participation in early education and care settings.

Sample Careers

Work in settings such as child care, nursery school, Head Start, family child care, pediatrics, nanny care, infant/toddler care, resource and referral services.

Degrees Available

Associate of Science, Associate of Applied Science
Technical Certificate

Concentrations Offered

None

Availability of concentrations and degrees varies by campus. Contact your local campus for more information.



Associate of Science

Articulated transfer through an Associate of Science in Early Childhood Education is available with Ball State University, IU Kokomo, IPFW, IUPUI, Anderson University, Indiana State University, and the University of Southern Indiana. To view these Associate of Science transfer degree programs and to see if they are available at your local Ivy Tech campus, students should go to <http://www.ivytech.edu/>.

Students are encouraged to review these options with their advisors, to consult the current catalog of the institution to which they wish to transfer, and to contact the institution to which they wish to transfer. Additional opportunities for course and program transfer may also be available at your local campus. Students should contact the transfer office of their local Ivy Tech for further information.

Associate of Applied Science

To earn this degree, you must have 67-68 credits in the following areas:

General Education Core	19-20
Professional/Technical Core	39
Regionally Determined Credits	9

General Education (19-20 Credits)

IVYT 1XX Life Skills Elective	1
ENGL 111 English Composition	3
* COMM 101 Fundamentals of Public Speaking or * COMM 102 Introduction to Interpersonal Communication	3
* MATH 1XX Intermediate Algebra or Higher	3
SOCI 111 Introduction to Sociology	3
* XXXX XXX Life/Physical Science Elective	3
* XXXX XXX Humanities Elective	3-4

Professional/Technical (48 credits)

ECED 100 Introduction to Early Childhood Education	3
ECED 101 Health, Safety and Nutrition	3
ECED 103 Curriculum in the Early Childhood Classroom	3
ECED 120 Child Growth and Development	3
ECED 130 Developmentally Appropriate Guidance in a Cultural Context	3

ECED 204 Families in Transition	3
ECED 210 Early Childhood Administration	3
ECED 230 The Exceptional Child	3
ECED 233 Emerging Literacy	3
ECED 243 Cognitive Curriculum	3
^ ECED 260 Early Childhood Professional	3

Choose two of the following:

ECED 105 CDA Process or ECED 115 Indiana Youth Development (IYD) Process	3
ECED 205 Early Care Practicum	3
ECED 225 Infant and Toddler Practicum	3
ECED 235 Preschool Practicum	3
ECED 245 School Age Practicum	3
ECED 255 Generalist Practicum	3
Regionally Determined Credits	9

Technical Certificate

To earn this degree, you must have 31 credits in the following areas:

General Education Core	7
Professional/Technical Core	15
Regionally Determined Credits	9

General Education (7 Credits)

ENGL 111 English Composition	3
IVYT 1XX Life Skills Elective	1
** SDCI 111 Introduction to Sociology	3

Professional/Technical (24 credits)

ECED 100 Introduction to Early Childhood Education	3
ECED 101 Health, Safety and Nutrition	3
ECED 103 Curriculum in the Early Childhood Classroom	3
ECED 120 Child Growth and Development	3

Choose one of the following:

ECED 105 CDA Process or ECED 115 Indiana Youth Development (IYD) Process	3
ECED 205 Early Care Practicum	3

ECED 225 Infant and Toddler Practicum	3
ECED 235 Preschool Practicum	3
ECED 245 School Age Practicum	3
ECED 255 Generalist Practicum	3
Regionally Determined Credits	9



IVY TECH
COMMUNITY
COLLEGE

Education

Program Description

With an Associate of Science degree in education, you will acquire knowledge of the teaching profession as well as a strong background in general education subjects required of teachers. You will be well prepared if you choose to transfer your degree to a bachelor's degree program in education.

By completing a core of educational foundation courses, general education requirements, and the Praxis I exam, you will be ready to enter baccalaureate degree programs as a junior ready to pursue your bachelor's degree in education.

Articulated transfer opportunities are available with the public four-year universities in Indiana. Additional opportunities for courses and program transfer may also be available. You should contact the transfer office of your local Ivy Tech for additional information.

Sample Careers

Substitute teacher, teacher assistant, transfer degree

Degrees Available

Associate of Science

Concentrations Offered

None

Availability of concentrations and degrees varies by campus. Contact your local campus for more information.



Electrical Engineering Technology

Program Description

The Electrical Engineering Technology program is designed to prepare students for a variety of careers in electronics engineering technology, such as computing, communications, process control, biomedical, energy management, and transportation. The program addresses needs for skilled technicians who can work with engineers and other technicians to implement electronic designs and to support engineering processes such as collecting, analyzing, and interpreting data, and troubleshooting various electronic systems. Graduates will be able to continue their education at Indiana University-Purdue University-Indianapolis (IUPUI) in a Bachelor of Science degree in Electrical Engineering Technology (BS-EET), and at Purdue North Central (PNC) in a Bachelor of Science degree in Engineering Technology (BS-ET).

Sample Careers

Skilled Technician, Transfer Degree

Degrees Available

Associate of Science

Concentrations Offered

None

Availability of concentrations and degrees varies by campus. Contact your local campus for more information.



Associate of Science

To earn this degree, you must have 66 credits in the following areas:

General Education Core	29
Professional/Technical Core	37

General Education (29 Credits)

COMM 101	Fundamentals of Public Speaking	3
ENGL 111	English Composition	3
ENGL 211	Technical Writing	3
IVYT 1XX	Life Skills Elective	1
MATH 136	College Algebra	3
MATH 137	Trigonometry with Analytic Geometry	3
MATH 210	Calculus for Technology	3
PHYS 101	Physics I	4
XXXX XXX	Humanities/Social and Behavioral Sci. Elective	6

Professional/Technical Core (37 credits)

DESN 103	CAD Fundamentals	3
EECT 111	Introduction to Circuit Analysis	4
EECT 112	Digital Fundamentals	3
EECT 121	Electronics Circuit Analysis	4
EECT 122	Digital Applications	4
EECT 128	Introduction to C Programming	3
EECT 213	Introduction to Industrial Controls	3
EECT 222	Introduction to Microcontrollers	4
EECT 223	Electrical Machines	3
EECT 226	Computer Troubleshooting	3
INDT 205	Programmable Controllers I	3



IVY TECH
COMMUNITY
COLLEGE

Electronics & Computer Technology

Program Description

The Electronics and Computer Technology program is structured to prepare you with the technical skills, general knowledge and critical thinking and problem-solving skills necessary to pursue a career and adapt to changes in the fields of computer and electronics systems in such industries as telecommunications, medicine, electrical service, industry, instrumentation and others using this type of technology.

Sample Careers

Engineering technician

Degrees Available

Associate of Science, Associate of Applied Science,

Concentrations Offered

None

Availability of concentrations and degrees varies by campus.

Contact your local campus for more information.



Associate of Science

Articulated transfer through an Associate of Science in Electronics Technology is available with Indiana State University, IUPUI-Fort Wayne, and the University of Southern Indiana. To view these Associate of Science transfer degree programs and to see if they are available at your local Ivy Tech campus, students should go to <http://www.ivytech.edu>. Students are encouraged to review these options with their advisors, to consult the current catalog of the institution to which they wish to transfer, and to contact the institution to which they wish to transfer. Additional opportunities for course and program transfer may also be available at your local campus. Students should contact the transfer office of their local Ivy Tech for further information.

Associate of Applied Science

To earn this degree, you must have 63 credits in the following areas:

General Education Core	20
Professional/Technical Core	31
Regionally Determined Credits	12

General Education (20 Credits)

COMM 101	Fundamentals of Public Speaking	3
ENGL 111	English Composition	3
IVYT 1XX	Life Skills Elective	1
MATH 1XX	First Course in a Series	3
MATH 1XX	Second Course in a Series	3
PHYS 101	Physics-I	4
XXXX XXX	Humanities/Social and Behavioral Sci. Elective	3

Professional/Technical (43 credits)

EECT 101	Introduction to Electronics and Projects	3
EECT 111	Introduction to Circuit Analysis	4
EECT 112	Digital Fundamentals	3
EECT 121	Electronics Circuit Analysis	4
EECT 122	Digital Applications	4
EECT 128	Introduction to C Programming	3
EECT 211	AC Electronics Circuit Analysis	4

EECT 226	Computer Troubleshooting	3
EECT 279	Advanced Problem Solving	3
Regionally Determined Credits		12



IVY TECH
COMMUNITY
COLLEGE

Fine Art

Program Description

The art/design/fashion industry captures the creative individual. Earn an associate degree in fine arts and cultivate your artistic skills- whether it is in fine arts, commercial art, film, fashion, or photography. Artists make careers everywhere that visual expression, flexible thinking and communication skills are in demand.

Sample Careers

Fine artists, such as painters, sculptors and illustrators

Degrees Available

Associate of Fine Arts

Concentrations Offered

None

*Availability of concentrations and degrees varies by campus.
Contact your local campus for more information.*



Associate of Fine Arts

To earn this degree, you must have 61 credits in the following areas:

General Education Core	28
Concentration	33

General Education (28 Credits)

ARTH 101	Survey of Art and Culture I	3
ARTH 102	Survey of Art and Culture II	3
COMM 101	Fundamentals of Public Speaking	3
ENGL 111	English Composition	3
ENGL 112	Exposition and Persuasion	3
IVYT 1XX	Life Skills Elective	1
MATH 118	Concepts in Mathematics	3
PSYC 101	Introduction to Psychology	3
SCIN 111	Physical Science	3
SOCI 111	Introduction to Sociology	3

Professional/Technical (33 credits)

ARTS 100	Life and Object Drawing I	3
ARTS 101	Life and Object Drawing II	3
ARTS 102	Color and Design Theory	3
ARTS 103	Three-Dimensional Design	3
ARTS 104	Contemporary Art History	3
ARTS 2XX	Studio Electives	15
ARTS 2XX	Art History Elective	3



IVY TECH
COMMUNITY
COLLEGE

General Studies

Program Description

The General Studies program focuses on students taking their first two years of college at Ivy Tech and then transferring their credits to other colleges and universities both in state and out of state. General Studies' students complete a core of general education courses which include: Fundamentals of Public Speaking, English Composition, Exposition and Persuasion, Mathematics and Life and Physical Sciences. Also students select from courses which include: History, Government and Politics, Psychology, Sociology and Philosophy.

Sample Careers

The General Studies program is designed as a transfer opportunity to bachelor's degree-granting institutions.

Degrees Available

Associate of Science

Concentrations Offered

None

*Availability of concentrations and degrees varies by campus.
Contact your local campus for more information.*



Health Information Technology

Program Description

Healthcare professionals strive daily to provide real-time health care delivery and aid in health-related decision making. Helping provide that commitment of quality healthcare are health information management professionals who specialize in medical records management, privacy, risk management, medical coding, insurance reimbursement, corporate compliance, data analysis and reporting. Employment possibilities include physician offices, clinics, hospitals, long-term care facilities, rehabilitation centers, and other healthcare facilities that maintain, collect, and analyze healthcare data.

This Ivy Tech associate of science degree program has the input of employers who understand the demand for trained professionals committed to the timely, accurate, and secure collection of health information.

Sample Careers

Documentation specialist, Coder, HIM director, HIM department manager or supervisor

Degrees Available

Associate of Science

Concentrations Offered

None

Availability of concentrations and degrees varies by campus. Contact your local campus for more information.



Associate of Science

To earn this degree, you must have 69 credits in the following areas:

General Education Core	25
Professional/Technical Core	44

General Education (25 Credits)

# APHY 101	Anatomy and Physiology I	3
APHY 102	Anatomy and Physiology II	3
# COMM 101	Fundamentals of Public Speaking	3
# ENGL 111	English Composition	3
ENGL 211	Technical Writing	3
IVYT 1XX	Life Skills Elective	1
MATH 115	Statistics	3
PHIL 102	Introduction to Ethics	3
PSYC 101	Introduction to Psychology	3
or		
SOCI 111	Introduction to Sociology	3

Professional/Technical (44 credits)

# CINS 101	Introduction to Microcomputers	3
CINS 102	Information Systems Fundamentals	3
HIMT 101	Health Information Systems	3
HIMT 102	Health Data Content and Structure	2
HIMT 104	Health Information and the Law	3
HIMT 105	Healthcare Organizations and Delivery Systems	3
HIMT 201	Reimbursement Systems	3
HIMT 202	Healthcare Data Literacy and Statistics	3
HIMT 203	ICD Coding	3
HIMT 204	Quality Assessment and Improvement	2
^ HIMT 205	Organization and Supervision	2
HIMT 207	Health Information Externship I	1
HIMT 208	Health Information Externship II	1
HIMT 210	Pathophysiology and Pharmacology I	3
HIMT 213	CPT Coding	3
HIMT 219	Pathophysiology and Pharmacology II	3
# HLHS 101	Medical Terminology	3

Courses must be successfully completed before admittance to the program.

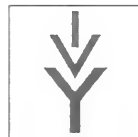

IVY TECH
COMMUNITY
COLLEGE

Hospitality Administration

Program Description

Event planning careers are for people with strong organizational and inter-personal skills, and that also enjoy the art of creating a functional and pleasant environment for customers attending an event. The hospitality administration's concentration in event management provides training in budget management, organizational skills, management skills, communication skills, and how to coordinate the activities of many diverse groups of people and suppliers.

Sample Careers

Event planner, meeting planner, convention center coordinator or director, lodging manager

Degrees Available

Associate of Science, Associate of Applied Science
Technical Certificate

Concentrations Offered

Baking & Pastry Arts, Culinary Arts, Event Management
Hotel Management, Restaurant Management

*Availability of concentrations and degrees varies by campus.
Contact your local campus for more information.*



Associate of Science

Articulated transfer through an Associate of Science in Hospitality Administration is available with Ball State University. To view these Associate of Science transfer degree programs and to see if they are available at your local Ivy Tech campus, students should go to <http://www.ivytech.edu/>.

Students are encouraged to review these options with their advisors, to consult the current catalog of the institution to which they wish to transfer, and to contact the institution to which they wish to transfer. Additional opportunities for course and program transfer may also be available at your local campus. Students should contact the transfer office of their local Ivy Tech for further information

Associate of Applied Science

To earn this degree, you must have 63-69 credits in the following areas:

General Education Core	19
Professional/Technical Core	20
Concentration Courses	24-30
Regionally Determined Credits	0-6

General Education (19 Credits)

** COMM 101 Fundamentals of Public Speaking or	3
** COMM 102 Introduction to Interpersonal Communication	3
ENGL 111 English Composition	3
IVYT 1XX Life Skills Elective	1
** MATH 1XX Mathematics Elective	3
* XXXX XXX Life/Physical Science Elective	3
* XXXX XXX Social/Behavioral Science Elective	3
* XXXX XXX Humanities Elective	3

Professional/Technical (20 credits)

HOSP 101 Sanitation and First Aid	2
HOSP 102 Basic Food Theory and Skills	3
HOSP 104 Nutrition	3
HOSP 108 Human Relations Management	3
HOSP 201 Hospitality Purchasing and Cost Control	3
HOSP 203 Menu, Design, and Layout	3
^ HOSP 280 Co-op/Internship	3

Choose One of the Following Concentrations

Baking and Pastry Arts Concentration (30 credits)
Restaurants, hotels, clubs, grocery stores, commercial, and independent shops are constantly seeking bakers and pastry chefs with the necessary skills and experience. This concentration is tailored to will prepare you to satisfy industry demands and American Culinary Federation Standards for Baker certification.

HOSP 105 Introduction to Baking	3
HOSP 106 Pantry and Breakfast	3
HOSP 111 Yeast Breads	3
HOSP 113 Baking Science	3
HOSP 208 Cakes, Icings, and Fillings	3
HOSP 209 Advanced Decorating and Candies	3
HOSP 213 Classical Pastries and Chocolates	3
HOSP 270 Bakery Merchandising	3
Regionally Determined Credits	6

Culinary Arts Concentration (30 credits)

Ivy Tech's excellent educational kitchen enables us to train you for entry-level positions, such as first, second or sauté cooks, sous chefs, and garde mangers. The goal is to send you into the food service industry equipped with manual, theoretical and technical competence.

HOSP 103 Soup, Stock, and Sauces	3
HOSP 105 Introduction to Baking	3
HOSP 106 Pantry and Breakfast	3
HOSP 110 Meat Fabrication	3
HOSP 202 Fish and Seafood	3
HOSP 207 Table Service	3
HOSP 210 Classical Cuisine	3
HOSP 212 Garde Manger	3
HOSP 211 Specialized Cuisine or	3
HOSP 221 Catering Administration	3
HOSP 213 Classical Pastries and Chocolates	3

Event Management Concentration (30 credits)

Ivy Tech's excellent educational kitchen enables us to train you for entry-level positions, such as first, second or sauté cooks, sous chefs, and garde mangers. The goal is to send you into the food service industry equipped with manual, theoretical and technical competence.

ACCT 101 Financial Accounting	3
-------------------------------	---

BUSN 105	Principles of Management	3
CINS 101	Introduction to Microcomputers	3
HOSP 114	Introduction to Hospitality	3
HOSP 144	Travel Management	3
HOSP 171	Introduction to Convention & Meeting Management	3
HOSP 172	Development and Management of Attractions	3
HOSP 271	Mechanics of Meeting Planning	3
HOSP 272	The Tourism System	3
MKTG 101	Principles of Marketing	3

Hotel Management Concentration (30 credits)

Hospitality at the basic level is simply the art of making guests feel welcome. It is the largest service industry in the nation and dramatic employment growth is expected both nationally and in Indiana. This concentration addresses your potential to become a successful manager.

ACCT 101	Financial Accounting	3
BUSN 102	Business Law	3
BUSN 105	Principles of Management	3
CINS 101	Introduction to Microcomputers	3
HOSP 114	Introduction to Hospitality	3
* HOSP 144	Travel Management	3
or		
* BUSN 101	Introduction to Business	3
HOSP 207	Table Service	3
HOSP 215	Front Office	3
HOSP 217	Housekeeping	3
MKTG 101	Principles of Marketing	3

Restaurant Management Concentration (30 credits)

Restaurant management training provides you with great opportunities to manage a complex operation and play the lead role in creating a great experience for your customers. This concentration includes courses in hotel and restaurant management, financial management, business, sales, food and beverage purchasing.

ACCT 101	Financial Accounting	3
BUSN 101	Introduction to Business	3
BUSN 102	Business Law	3
BUSN 105	Principles of Management	3
BUSN 208	Organizational Behavior	3
CINS 101	Introduction to Microcomputers	3
HOSP 114	Introduction to Hospitality	3

HOSP 207	Table Service	3
MKTG 101	Principles of Marketing	3
* OPMT 224	Operations Management	3
or		
* MKTG 204	Marketing Management	3

Technical Certificate

To earn this degree, you must have 30 credits in the following areas:

General Education Core	7
Professional/Technical Core	2
Concentration Courses	6-9
Regionally Determined Credits	12-15

General Education (7 Credits)

COMM 102	Introduction to Interpersonal Communication	3
or		
ENGL 111	English Composition	3
IVYT 1XX	Life Skills Elective	1
MATH 1XX	Mathematics Elective	3

Professional/Technical (3 Credits)

HOSP 101	Sanitation and First Aid	2
----------	--------------------------	---

Choose One of the Following Concentrations

Baking and Pastry Arts Concentration (21 credits)

HOSP 105	Introduction to Baking	3
HOSP 113	Baking Science	3
HOSP 270	Bakery Merchandising	3
Regionally Determined Credits		12

Culinary Arts Concentration (21 credits)

HOSP 102	Basic Foods Theory and Skills	3
HOSP 104	Nutrition	3
Regionally Determined Credits		15

Human Services

Program Description

If you're looking for a career that will allow you to help others, you may want to check out our Human Services program. It's designed to provide meaningful training for students interested in working with people. The program emphasizes the personal attitudes, technical knowledge, and practical skills necessary to obtain entry-level employment in a wide variety of social service settings. As human services paraprofessionals, graduates reach out to individuals, families and communities.

Career opportunities exist in local community mental health centers, psychiatric hospitals, group homes, substance abuse programs, government welfare agencies, correctional institutions, homeless shelters, and agencies serving the developmentally disabled.

Sample Careers

Social service worker, corrections counselor, counselor

Degrees Available

Associate of Science, Associate of Applied Science
Technical Certificate

Concentrations Offered

Correctional Rehabilitation Services, Generalist, Gerontology, Mental Health, Substance Abuse

Availability of concentrations and degrees varies by campus. Contact your local campus for more information.



Human Services continued

Associate of Science

Articulated transfer through an Associate of Science in Human Services is available with Ball State University, Indiana State University, IUPUI-Fort Wayne, IUPUI and the University of Southern Indiana. To view these Associate of Science transfer degree programs, students should go to www.ivytech.edu.

Students are encouraged to review these options with their advisors, to consult the current catalog of the institution to which they wish to transfer, and to contact the institution to which they wish to transfer. Opportunities for course and program transfer may also be available at your local campus. Students should contact their local transfer office.

Associate of Applied Science

To earn this degree, you must have 62-63 credits in the following areas:

General Education Core	19
Professional/Technical Core	26
Concentration Courses	12
Regionally Determined Credits	5-6

General Education (19 Credits)

BIOL 100 Human Biology	3
or	
BIOL 101 Introductory Biology	3
COMM 101 Fundamentals of Public Speaking	3
ENGL 111 English Composition	3
IVY 1XX Life Skills Elective	1
** MATH 1XX Mathematics Elective	3
PSYC 101 Introduction to Psychology	3
SOCI 111 Introduction to Sociology	3

Professional/Technical (26 credits)

CNS 101 Introduction to Microcomputers	3
HUMS 101 Introduction to Human Services	3
HUMS 102 Helping Relationship Techniques	3
HUMS 103 Interviewing and Assessment	3
HUMS 201 Internship I	4
^ HUMS 202 Internship II	4
HUMS 205 Behavior Modification/Choice Theory	3
HUMS 206 Group Process and Skills	3

Choose One of the Following Concentrations

Correctional Rehabilitation Services Concentration

(18 credits)

This concentration prepares you to work in correctional facilities, courts, youth rehabilitation and crime prevention.

HUMS 105 Introduction to Correctional Rehabilitation Services	3
HUMS 113 Problems of Substance Abuse in Society	3
HUMS 215 Juvenile Delinquency	3
HUMS 240 Rehabilitation Process: Probation and Parole	3
Regionally Determined Credits	6

Direct Support Professional Concentration

(17-18 credits)

This concentration prepares you for a career at agencies that provide community-based services and support to individuals with developmental disabilities in a variety of settings including vocational, residential, and recreational.

HUMS 116 Introduction to Disabilities	3
HUMS 123 Health and Wellness/Disabilities	3
HUMS 127 Positive Personal Support	3
HUMS 128 Disability Support Teams	3
Regionally Determined Credits	5-6

Generalist Concentration (18 credits)

This concentration prepares you to find employment in a variety of settings, such as community centers, group homes, substance abuse centers, and assisted living facilities.

HUMS 109 Understanding Diversity	3
HUMS 113 Problems of Substance Abuse in Society	3
HUMS 220 Issues and Ethics in Human Services	3
PSYC 201 Lifespan Development	3
Regionally Determined Credits	6

Mental Health Concentration (18 credits)

With a mental health concentration, you may find jobs in community mental health centers, crisis centers, residential facilities for the developmentally delayed, and services for the mentally ill.

HUMS 104 Crisis Intervention	3
HUMS 220 Issues and Ethics in Human Services	3
PSYC 201 Lifespan Development	3
PSYC 205 Abnormal Psychology	3

Regionally Determined Credits

6

Substance Abuse Concentration (18 credits)

With a concentration in substance abuse, you may find a job in substance abuse centers (residential, detox, hospitals) as counselors or counselors-in-training.

HUMS 113 Problems of Substance Abuse in Society	3
HUMS 208 Treatment Models of Substance Abuse	3
HUMS 209 Counseling Issues in Substance Abuse	3
HUMS 210 Issues of Substance Abuse in Family Systems	3
Regionally Determined Credits	6

Technical Certificate

To earn this degree, you must have 31 credits in the following areas:

General Education Core	7
Professional/Technical Core	3
Concentration Courses	21

General Education (7 Credits)

COMM 101 Fundamentals of Public Speaking	3
IVYT 1XX Life Skills Elective	1
PSYC 101 Introduction to Psychology	3

Professional/Technical (3 credits)

HUMS 101 Introduction to Human Services	3
---	---

Mental Health Concentration (21 credits)

HUMS 205 Behavior Modification/Choice Theory	3
PSYC 205 Abnormal Psychology	3
Regionally Determined Credits	15

Direct Support Professional Concentration (21 credits)

HUMS 102 Helping Relationship Techniques	3
HUMS 103 Interviewing and Assessment	3
HUMS 116 Introduction to Disabilities	3
HUMS 123 Health and Wellness	3
HUMS 126 Community Integration	3
HUMS 127 Positive Personal Support	3
HUMS 128 Disability Support Teams	3

Industrial Technology

Program Description

The Industrial Technology program is designed to prepare you for the modern industrial environment. In today's modern factories, CNC machines and automated equipment fabricate industrial and consumer products. To operate in the modern manufacturing facility requires highly trained individuals.

Sample Careers

Industrial technologist, CNC technologist, machinist, quality manager

Degrees Available

Associate of Science, Associate of Applied Science, Technical Certificate

Certificates Offered

Fluid Power, Heating and Air Conditioning, Industrial Electrician, Machine Tool, Welding

Concentrations Offered

Heating, Ventilation and Air Conditioning, Machining, Maintenance, Power Plant Technology, Process Control and Automation, Welding

Availability of concentrations and degrees varies by campus. Contact your local campus for more information.



Associate of Science

Articulated transfer through an Associate of Science in Industrial Technology is available with Purdue University. To view this Associate of Science transfer degree program and to see if it is available at your local Ivy Tech campus, go to <http://www.ivytech.edu>.

Students are encouraged to review this option with their advisors, to consult the current catalog of the institution to which they wish to transfer, and to contact the institution to which they wish to transfer. Opportunities for course and program transfer may be available at your local campus. Students should contact their local transfer office.

Associate of Applied Science

To earn this degree, you must have 62-64 credits in the following areas:

General Education Core	20-22
Professional/Technical Core	18
Concentration Courses	12
Regionally Determined Credits	12

General Education (20-22 Credits)

COMM 101	Fundamentals of Public Speaking	3
ENGL 111	English Composition	3
IVYT 1XX	Life Skills Elective	1
MATH 1XX	Math Elective	3
PHYS 101	Physics I	4
or		
SCIN 101	Science of Traditional and Alternative Energy	4
* XXXX XXX	Humanities/Social and Behavior Sciences/ Mathematics Electives	6-8

Professional/Technical (18 credits)

INDT 102	Introduction to Print Reading	3
INDT 106	Introduction to the Workplace and Safety	3
INDT 113	Basic Electricity	3
INDT 114	Introductory Welding	3
△ INDT 260	Problem Solving and Teamwork	3
TECH 104	Computer Fundamentals	3

Choose One of the Following Concentrations

Electric Line Concentration (24 credits)

Learn how to repair and maintain electrical transmission systems. Common jobs include lineworker, line installer and line technician.

ENGR 102	Climbing	3
ENGR 103	Electrical Essentials for Power Line Workers	3
ENGR 107	Transmission and Distribution of Electric Power	3
ENGR 109	Rigging for Line Workers	3
Regionally Determined Credits		12

Heating, Ventilation and Air Conditioning

Concentration (24 credits):

This concentration will prepare you to install and repair heating, air conditioning, refrigeration and ventilation systems.

HVAC 101	Heating Fundamentals	3
HVAC 103	Refrigeration I	3
HVAC 208	Heating Service	3
HVAC 211	Refrigeration II	3
Regionally Determined Credits		12

Machining Concentration (24 credits)

Today's industries rely on trained and skilled machinists, machine operators and manufacturers to produce precision components for everything from household appliances to aircraft parts. With training that includes CNC operation and programming, as well as robotics and CAD systems, you'll be ready for a machine tool-related career.

MTTC 101	Introduction to Machining	3
MTTC 104	Machining Handbook	3
MTTC 105	Abrasive Processes I	3
MTTC 110	Turning and Milling Processes	3
Regionally Determined Credits		12

Maintenance Concentration (24 credits)

This concentration will provide you with a broad range of skills applicable to a variety of jobs in the industrial environment. You will be prepared to install, repair, maintain and troubleshoot industrial machinery and equipment such as pumps, motors, pneumatic and hydraulic systems, and production machinery.

INDT 103	Motor and Motor Controls	3
INDT 104	Fluid Power Basics	3
INDT 203	Machine Maintenance and Installation	3
INDT 205	Programmable Controllers I	3
Regionally Determined Credits		12

Natural Gas Technology Concentration (24 credits)

Learn how natural gas lines are constructed and maintained. Graduates will install new projects and maintain the pipelines.

Industrial Technology continued

NGAS 101	Fundamentals of Natural Gas	3
NGAS 102	Natural Gas Pipe Joining	3
NGAS 203	Natural Gas Regulatory and Compliance Issues	3
NGAS 204	Natural Gas Construction and Techniques	3
Regionally Determined Credits		12

Power Plant Technology Concentration (24 credits)

This concentration emphasizes the operation of modern power plants and will provide the skills for a career in this field. You'll learn technical and safety aspects of plant and facility operations.

PPTC 101	Power Plant Fundamentals	3
PPTC 121	Power Plant Steam Systems	3
PPTC 201	Power Plant Instrumentation and Control	3
PPTC 221	Advanced Power Plant Systems	3
Regionally Determined Credits		12

Process Operations (24 credits)

This concentration is designed to train you for technician work in refineries and energy industry. It offers study in monitoring, controlling and troubleshooting equipment used in the production of gasoline, airplane fuel, plastic soft drink bottles, glass jars, pharmaceutical, and electricity. You will learn pneumatic, electronic and microcomputer instrumentation, how to use instruments that measure variables such as pressure, flow, temperature and chemical composition.

INDT 131	Introduction to Process Technology	3
INDT 132	Process Technology I (Equipment)	3
INDT 133	Process Technology II (Systems)	3
INDT 134	Process Technology III (Operations)	3
Regionally Determined Credits		12

Welding Concentration (24 credits)

This concentration is designed for you if you are interested in learning welding or upgrading your skills in the various processes. Novices and advanced-level students can benefit from the individualized competency-based program offered. This concentration offers a variety of skill levels in oxyacetylene, arc, MIG, TIG, and welding/cutting processes, using both manual and semi-automatic applications.

WELD 108	Shielded Metal Arc Welding I	3
WELD 207	Gas Metal Arc (MIG) Welding	3
WELD 208	Gas Tungsten Arc (TIG) Welding	3
WELD 210	Welding Fabrication I	3
Regionally Determined Credits		12

Technical Certificate

To earn this degree, you must have 31-32 credits in the following areas:

General Education Core	7-8
Professional/Technical Core	3
Concentration Courses	6
Regionally Determined Credits	15

General Education (7 Credits)

COMM 101	Fundamentals of Public Speaking	3
IVYT 1XX	Life Skills Elective	1
MATH 1XX	Mathematics Elective	3 - 4

Professional/Technical (3 credits)

INDT 102	Introduction to Print Reading	3
----------	-------------------------------	---

Choose One of the Following Concentrations

Heating, Ventilation and Air Conditioning Concentration (21 credits)

HVAC 101	Heating Fundamentals	3
HVAC 103	Refrigeration I	3
Regionally Determined Credits		15

Machining Concentration (21 credits)

MTTC 101	Introduction to Machining	3
MTTC 110	Turning and Milling Processes	3
Regionally Determined Credits		15

Maintenance Concentration (21 credits)

INDT 104	Fluid Power Basics	3
INDT 113	Basic Electricity	3
Regionally Determined Credits		15

Welding Concentration (21 credits)

WELD 108	Shielded Metal Arc Welding I	3
WELD 207	Gas Metal Arc (MIG) Welding	3
Regionally Determined Credits		15

Certificates

Fluid Power (18 Credits)

IMTC 201	Fluid Power Systems (Hydraulics/Pneumatics)	3
INDT 102	Introduction to Print Reading	3
INDT 103	Motors and Motor Controls	3
INDT 104	Fluid Power Basics	3
INDT 106	Introduction to the Workplace and Safety	3
INDT 113	Basic Electricity	3

Heating and Air Conditioning (18 credits)

HVAC 101	Heating Fundamentals	3
HVAC 103	Refrigeration I	3
HVAC 205	Heat Pump Systems	3
HVAC 208	Heating Service	3
HVAC 211	Refrigeration II	3
INDT 113	Basic Electricity	3

Industrial Electrician (18 credits)

ECT 105	Introduction to National Electrical Code	3
IMTC 122	Electrical Wiring Fundamentals/NEC Code	3
INDT 204	Electrical Circuits	3
INDT 103	Motors and Motor Controls	3
INDT 113	Basic Electricity	3
TECH 104	Computer Fundamentals for Technology	3

Machine Tool (18 credits)

INDT 102	Introduction to Print Reading	3
INDT 106	Introduction to the Workplace and Safety	3
MTTC 101	Introduction to Machining	3
MTTC 105	Abrasive Processes I	3
MTTC 110	Turning and Milling Processes	3
MTTC 208	CNC Programming I	3

Welding (18 credits)

INDT 114	Introductory Welding	3
WELD 108	Shielded Metal Arc Welding I	3
WELD 206	Shielded Metal Arc Welding II	3
WELD 207	Gas Metal Arc (MIG) Welding	3
WELD 208	Gas Tungsten Arc (TIG) Welding	3
WELD 209	Welding Certification	3

Information Security

Program Description

The Associate of Applied Science in Information Security will prepare you to work in areas related to information assurance and computer security. The certificates are designed for students currently working in the computer industry to enhance their knowledge of Information and network-related risks and their avoidance and resolution. Major employers include computer and data processing companies, wholesale and retail trade companies, universities and colleges, and federal, state, and local government agencies.

Sample Careers

Computer Security or Information Assurance technicians

Degrees Available

Associate of Applied Science

Concentrations Offered

Network Security, Data Security

Availability of concentrations and degrees varies by campus. Contact your local campus for more information.



Associate of Applied Science

To earn this degree, you must have 64 credits in the following areas:

General Education Core	19
Professional/Technical Core	33
Concentration Courses	12

General Education (19 Credits)

COMM 101	Fundamentals of Public Speaking	3
ENGL 111	English Composition	3
IVYT 1XX	Life Skills Elective	1
MATH 111	Intermediate Algebra	3
MATH 115	Statistics	3
SCIN XXX	Life/Physical Science Elective	3
XXXX XXX	Humanities/Social & Behavioral Science Elective	3

Professional/Technical (33 credits)

CINS 113	Logic, Design and Programming	3
CINS 121	C/C++/C# Programming	3
CINS 139	Introduction to Computer Forensics	3
CINS 203	Systems Analysis and Design	3
CINT 121	Network Fundamentals	3
CINT 125	Windows Client Operating System	3
CINT 201	Advanced Operating Systems: LINUX	3
CINT 225	Windows Network Operating Systems	3
^ CINT 251	Introduction to Systems Security	3
CINT 253	Microsoft Network Security	3
INSE 101	Introduction to Information Systems Security	3

Choose One of the Following Concentrations

Network Security Concentration (12 credits)

CINT 252	Routers and Firewalls	3
CINT 254	Linux Network Security	3
INSE 201	Risk Management/Cyber Terrorism	3
INSE 202	Advanced Routers/Firewalls	3

Data Security (12 credits)

CINS 221	Advanced C/C++/C# Programming	3
----------	-------------------------------	---

CINS 239	Advanced Computer Forensics	3
INSE 210	Secure Coding Theory and Application	3
INSE 211	Cryptography	3

Certificates

Data Security (24 Credits)

CINS 121	C/C++/C# Programming	3
CINT 201	Advanced Operating Systems: LINUX	3
CINT 225	Windows Network Operating Systems	3
CINT 251	Introduction to Systems Security	3
CINT 253	Microsoft Network Security	3
INSE 101	Introduction to Information Systems Security	3
INSE 210	Secure Coding Theory and Application	3
INSE 211	Cryptography	3

Network Security (27 Credits)

CINT 201	Advanced Operating Systems: LINUX	3
CINT 225	Windows Network Operating Systems	3
CINT 251	Introduction to Systems Security	3
CINT 253	Microsoft Network Security	3
CINT 252	Routers and Firewalls	3
CINT 254	Linux Network Security	3
INSE 101	Introduction to Information Systems Security	3
INSE 201	Risk Management/Cyber Terrorism	3
INSE 202	Advanced Routers/Firewalls	3



IVY TECH
COMMUNITY
COLLEGE

Interior Design

Program Description

The Interior Design Program provides career education in the creation of safe, functional, productive and aesthetically pleasing interior and exterior environments for work, home, health and recreation. Students investigate many topics ranging from the interaction between human beings and their environments, to design conception and problem-solving, to materials specifying, project management and more. Student activities culminate in the development of an exit portfolio and resumé demonstrating the skills and knowledge for a professional position in one of many concentration areas.

Sample Careers

Interior designer, landscape designer, retail designer

Degrees Available

Associate of Applied Science

Concentrations Offered

Decorative Arts and Design, Garden Design, Interior Design

Availability of concentrations and degrees varies by campus.

Contact your local campus for more information.



Associate of Applied Science

To earn this degree, you must have 67 credits in the following areas:

General Education Core	19
Professional/Technical Core	24
Concentration Courses	12
Regionally Determined Credits	12

General Education (19 Credits)

ARTH 101	Survey of Art and Culture I	3
ARTH 102	Survey of Art and Culture II	3
** COMM 101	Fundamentals of Public Speaking	3
** COMM 102	Introduction to Interpersonal Communication	3
ENGL 111	English Composition	3
IVYT 1XX	Life Skills Elective	1
** MATH 1XX	Mathematics Elective	3

Professional/Technical (24 credits)

INTD 101	Design Theory	3
INTD 102	Drafting and Construction	3
INTD 103	Introduction to Interior Design	3
INTD 105	Design Presentations	3
INTD 201	Interior Materials	3
INTD 203	Professional Practices	3
^ INTD 209	Portfolio Preparation/Internship	3
INTD 216	CAD for Environmental Designers	3

Choose One of the Following Concentrations

Decorative Arts and Design Concentration (24 credits)

Do you know the difference between faux finish and Venetian plaster? If you're interested in decorative arts, this concentration will prepare you with classes ranging from three-dimensional design to visual merchandising.

ARTS 100	Life and Object Drawing I	3
ARTS 103	Three-Dimensional Design	3
INTD 109	History of Interiors I	3
INTD 217	Visual Merchandising	3
Regionally Determined Credits		12

Garden Design Concentration (24 credits)

Are your thumbs green? As a garden designer, you'll be able to put them to use. This concentration offers studies on designing and maintaining harmonious natural ecosystems for human enjoyment and use.

GRDN 110	Fundamentals of Gardening	3
GRDN 114	Garden Design I	3
GRDN 115	History of Garden Design	3
GRDN 116	Theme Gardening	3
Regionally Determined Credits		12

Interior Design Concentration (24 credits)

As an interior designer, you're responsible for the decoration, design and functionality of your client's space. This concentration prepares you for careers in the creation of safe, functional and aesthetically pleasing interior and exterior environments for work, home, health and recreation.

INTD 103	Introduction to Interior Design	3
INTD 104	Textiles for Interiors	3
INTD 108	Interior Design II	3
INTD 109	History of Interiors I	3
INTD 200	Lighting and Building Systems	3
Regionally Determined Credits		9



IVY TECH
COMMUNITY
COLLEGE

Kinesiology

Program Description

With an Associate of Science degree in Kinesiology, you will acquire an understanding of motion, particularly of the human body. The purpose of this degree program is to prepare you to work in entry-level positions in fitness leadership, sports management, wellness promotion, and corporate wellness.

Articulated transfer opportunities are available with Indiana University Bloomington with specializations in Sports Marketing/Management, Fitness and Exercise Science. Students can transfer from the Ivy Tech Community College Bloomington campus to the Department of Kinesiology in the School of Health, Physical Education and Recreation at the Indiana University Bloomington campus.

Degrees Available

Associate of Science

Concentrations Offered

None

Availability of concentrations and degrees varies by campus. Contact your local campus for more information.



Associate of Science

To earn this degree, you must have 61 credits in the following areas:

General Education Core 46
Professional/Technical Core 15

General Education (46 Credits)

COMM 101	Fundamentals of Public Speaking	3
COMM 102	Introduction to Interpersonal Communication	3
ECON 201	Principles of Macroeconomics	3
ECON 202	Principles of Microeconomics	3
ENGL 111	English Composition	3
ENGL 202	Creative Writing	3
ENGL 211	Technical Writing	3
IVYT 1XX	Life Skills Elective	1
MATH 135	Finite Math	3
PSYC 101	Introduction to Psychology	3
SOCI 111	Introduction to Sociology	3
SOCI 252	Social Problems	3
SOCI 261	Sociology of Relationships and the Family	3
XXXX XXX	Humanities/Social & Behavioral Sciences Elective 3	
XXXX XXX	Life & Physical Sciences/Mathematics Electives	6

Professional/Technical (15 credits)

BUSN 101	Introduction to Business	3
BUSN 102	Business Law	3
CINS 101	Introduction to Microcomputers	3
HPER 211	Introduction to Sport Management	3
^ HPER 212	Introduction to Exercise Science	3



Liberal Arts

Program Description

The Associate of Arts and Associate of Science in Liberal Arts are transfer programs that provide you with an opportunity to complete the first two years of study leading to a bachelor's degree in liberal arts areas.

Articulation agreements have been established with all the public, four-year universities in Indiana so that if you complete your associate degree, you may fulfill the requirements for a related bachelor's degree in an additional two years of full-time study at the university.

Sample Careers

Transfer degree

Degrees Available

Associate of Arts, Associate of Science

Concentrations Offered

English and Communication, Foreign Language, Humanities
Life and Physical Sciences, Mathematics
Social and Behavioral Sciences

Availability of concentrations and degrees varies by campus. Contact your local campus for more information.



Library Technical Assistant

Program Description

The Library Technical Assistant program will give you an understanding of the history of libraries and the functions and roles of the different types of libraries. You will have an understanding of and be functionally proficient in: basic library technical services including ordering, processing, and copy-cataloging of the variety of types and forms of materials found in libraries; library public support services including circulation, interlibrary loan, and basic reference, and computer operations as they relate to library functions.

As a library technical assistant, you might work under the supervision of librarians in circulation, technical processing, reference and audio-visual services. You also might assist librarians in the preparation and organization of materials and help patrons use the library.

Sample Careers

Staff positions in public, academic, school and special libraries

Degrees Available

Associate of Science

Concentrations Offered

Children's Services, Library Technology

Availability of concentrations and degrees varies by campus.

Contact your local campus for more information.



Associate of Science

To earn this degree, you must have 61 credits in the following areas:

General Education Core	25
Professional/Technical Core	24
Concentration Courses	12

General Education (25 Credits)

COMM 102	Introduction to Interpersonal Communication	3
ENGL 111	English Composition	3
IVYT 1XX	Life Skills Elective	1
MATH 1XX	Mathematics Elective	3
PSYC 101	Introduction to Psychology	3
SOCI 111	Principles of Sociology	3
XXXX XXX	Humanities Elective	6
XXXX XXX	Life/Physical Science Elective	3

Professional/Technical (24 credits)

CINS 101	Introduction to Microcomputers	3
LIBR 101	Introduction to Libraries and Library Services	3
LIBR 102	Introduction to Reference Sources and Services	3
LIBR 103	Introduction to Libraries Public Services	3
LIBR 104	Introduction to Technical Services	3
LIBR 201	Cataloging and Classification	3
LIBR 202	Electronic Resources and Online Searching	3
LIBR 206	Library Assistant Practicum	3

Choose One of the Following Concentrations

Children's Services Concentration (12 credits)

This concentration will prepare you to work under the supervision of a children's librarian or in the children's section of a library.

Choose four of the following:

ECED 103	Curriculum in Early Childhood Classroom	3
ECED 120	Child Growth and Development	3
ECED 130	Developmentally Appropriate Guidance in Cultural Context	3
ECED 223	School Age Programming	3
ECED 233	Emerging Literacy	3

ENGL 240	Children's Literature	3
LIBR 203	Library Services for Children	3
LIBR 204	Library Media Center Operations and Services	3
LIBR 205	Library/Media Materials and Equipment	3
XXXX XXX	Any LTA Library Technician Concentration Course	3

Library Technician Concentration (12 credits)

The ever changing world of technology affects libraries just as much as it does other businesses and facilities. This concentration equips you with knowledge to support a library through such areas as websites and information systems.

Choose four of the following:

CINS 102	Information Systems Fundamentals	3
CINS 157	Web Site Development	3
OFAD 103	Introduction to Computers with Word Processing	3
OFAD 110	Presentation Graphics	3
OFAD 114	Desktop Publishing	3
OFAD 207	Integrated Applications	3
OFAD 214	Multimedia Design	3
OFAD 218	Spreadsheets	3
XXXX XXX	Any LTA Children Services Concentration Course	3



IVY TECH
COMMUNITY
COLLEGE

Machine Tool Technology

Program Description

Virtually all manufactured products depend on America's precision machining industry at some point during their production. The Machine Tool Technology program was developed from employer input—employers who know the demand for solid training in this specialized field of metal cutting operations for the creation of machined parts, specialized tooling molds, dies and prototypes.

Sample Careers

Machinists, First line supervisors/managers of production and operating workers, tool and die makers

Degrees Available

Associate of Applied Science

Concentrations Offered

None

*Availability of concentrations and degrees varies by campus.
Contact your local campus for more information.*



Associate of Applied Science

To earn this degree, you must have 65 credits in the following areas:

General Education Core	20
Professional/Technical Core	45

General Education (20 Credits)

COMM 101	Fundamentals of Public Speaking	3
ENGL 111	English Composition	3
IVYT 1XX	Life Skills Elective	1
MATH 111	Intermediate Algebra	3
MATH 121	Geometry/Trigonometry	3
PHYS 101	Physics I	4
XXXX XXX	Humanities/Social Science Elective	3

Professional/Technical (45 credits)

ADMF 115	Materials and Processes for Manufacturing	3
DESN 103	CAD Fundamentals	3
DESN 227	Geometric Dimensions and Tolerancing	3
INDT 102	Introduction to Print Reading	3
MTTC 102	Turning Processes I	3
MTTC 103	Milling Processes I	3
MTTC 204	Abrasive Processes I	3
MTTC 208	CNC Programming I	3
MTTC 209	CNC Programming II	3
MTTC 220	CAD/CAM I	3
MTTC 240	Machine Operations I	3
MTTC 241	Machine Operations II	3
^ MTTC 242	CNC Machining	3
TECH 102	Technical Graphics	3
TECH 104	Computer Fundamentals for Technology	3



IVY TECH
COMMUNITY
COLLEGE

Mechanical Engineering Technology

Program Description

The Mechanical Engineering Technology program will educate skilled technicians who will work with engineers and other technicians to implement mechanical designs and to support engineering processes such as collecting, analyzing and interpreting data and troubleshooting mechanical systems. You will develop basic mechanical design skills and the appropriate science and math knowledge to enter the workforce and/or transfer to a four-year engineering technology program. Graduates can continue their education at IUPUI.

Sample Careers

Manufacturing, Transportation, Computer and electronics, Transfer degree

Degrees Available

Associate of Science

Concentrations Offered

None

Availability of concentrations and degrees varies by campus. Contact your local campus for more information.

Associate of Applied Science

To earn this degree, you must have 64 credits in the following areas:

General Education Core	30
Professional/Technical Core	34

General Education (30 Credits)

COMM 101	Fundamentals of Public Speaking	3
CHEM 111	Chemistry I	4
ENGL 111	English Composition	3
ENG 211	Technical Writing	3
IVYT 1XX	Life Skills Elective	1
MATH 136	College Algebra	3
MATH 137	Trigonometry with Analytic Geometry	3
MATH 221	Calculus for Technology I	3
PHYS 101	Physics I	4
XXXX XXX	Humanities/Social and Behavioral Science Elective	3

Professional/Technical (34 credits)

BUSN 101	Introduction to Business	3
DESN 102	Technical Graphics	3
DESN 103	CAD Fundamentals	3
DESN 104	Mechanical Graphics	3
DESN 221	Statistics	3
EECT 111	Introduction to Circuit Analysis	4
INDT 104	Fluid Power Basics	3
METC 105	Introduction to Engineering Technology	3
METC 220	CAD/CAM for Mechanical Design	3
METC XXX	Mechanical Engineering Technical Elective	6



IVY TECH
COMMUNITY
COLLEGE

Medical Assisting

Program Description

A graduate of the Medical Assistant Program is a professional, multi-skilled healthcare provider dedicated to assisting in patient care management in an ambulatory care setting. You would perform administrative and clinical duties and may manage emergency situations, facilities and/or personnel. Competence in the field requires professionalism and effective communication skills as well as technical skills. A required externship provides valuable on-the-job experience.

Sample Careers

Certified Medical Assistant (CMA), medical assistant, insurance specialist, medical transcriptionist

Degrees Available

Associate of Applied Science, Technical Certificate

Concentrations Offered

Administrative, Clinical, EKG, Generalist, Insurance, Medical Assistant, Pharmacy Technician, Phlebotomy, Therapeutic Massage, Transcription

Availability of concentrations and degrees varies by campus. Contact your local campus for more information.



The Ivy Tech Community College Medical Assisting Program is accredited by the Commission on Accreditation of Allied Health Education Programs (CAAHEP), on recommendation of the Curriculum Review Board of the American Association of Medical Assistants Endowment (CRB-AAMAE).

Commission on Accreditation of Allied Health Education Programs

1361 Park Street
Clearwater, FL 33756
(727) 210-2350

Only graduates of the AAS and GENERALIST-TC are eligible to take the national exam to become a Certified Medical Assistant (CMA). The American Association of Medical Assistants Certifying Board (AAMA CB) awards the CMA credential after successful completion of the exam. The Commission on Accreditation of Allied Health Education Programs (CAAHEP), in collaboration with the Curriculum Review Board (CRB) of the AAMA Endowment (a committee on accreditation of CAAHEP), accredits medical assisting programs.

Associate of Applied Science

To earn this degree, you must have 61 credits in the following areas:

General Education Core	19
Professional/Technical Core	36
Regionally Determined Credits	6

General Education (19 Credits)

APHY 101	Anatomy and Physiology I	3
APHY 102	Anatomy and Physiology II	3
COMM 101	Fundamentals of Public Speaking	3
or		
COMM 102	Introduction Interpersonal Communication	3
ENGL 111	English Composition	3
IVYT 1XX	Life Skills Elective	1
* MATH 1XX	Math Elective	3
* XXXX XXX	Humanities/Social Sciences Elective	3

Professional/Technical (42 credits)

HLHS 101	Medical Terminology	3
MEAS 107	Administrative I	3

MEAS 108	Administrative II	3
MEAS 137	Medical Insurance and Basic Coding with Computer Applications	3
MEAS 207	Integrated Medical Office Systems	3
MEAS 218	Pharmacology	3
MEAS 219	Medical Assisting Laboratory Techniques	3
MEAS 238	Clinical I	3
MEAS 239	Clinical II	3
MEAS 242	Disease Conditions	3
^ MEAS 258	Medical Assisting Clinical Externship	3
MEAS 259	Medical Assisting Administrative Externship	3
Regionally Determined Credits		6

Technical Certificate

To earn this degree, you must have 31-46 credits in the following areas:

General Education Core	7
Professional/Technical Core	3
Concentration Courses	6-36
Regionally Determined Credits	0-15

General Education (7 Credits)

IVY 1XX	Life Skills Elective	
* XXXX XXX	English/Communications Elective	3
* XXXX XXX	Social Science/Science/Mathematics/Humanities Elective	3

Professional/Technical (3 credits)

HLHS 101	Medical Terminology	3
----------	---------------------	---

Choose One of the Following Concentrations

Administrative Concentration (21 credits)

This concentration includes classes that cover a range of administrative-centered duties within the medical assisting field.

MEAS 107	Administrative I	3
MEAS 108	Administrative II	3
Regionally Determined Credits		15

Clinical Concentration (21 credits)

This concentration includes classes that cover a range of clinic-centered responsibilities within the medical assisting field.

MEAS 238	Clinical I	3
----------	------------	---

MEAS 239	Clinical II	3
Regionally Determined Credits		15

Generalist Concentration (36 credits)

The Generalist Concentration is the one concentration that will allow you to sit for certification.

** APHY 101	Anatomy and Physiology I	3
** APHY 102	Anatomy and Physiology II	3
MEAS 107	Administrative I	3
MEAS 108	Administrative II	3
MEAS 137	Medical Insurance and Basic Coding with Computer Applications	3
MEAS 207	Integrated Medical Office Systems	3
MEAS 218	Pharmacology	3
MEAS 219	Medical Assisting Laboratory Techniques	3
MEAS 238	Clinical I	3
MEAS 239	Clinical II	3
MEAS 258	Medical Assisting Clinical Externship	3
MEAS 259	Medical Assisting Administrative Externship	3

EKG Concentration (21 credits)

This concentration will prepare you to administer diagnostic EKG testing and start you on your way to a career as an EKG Technician.

MEAS 205	Introduction to Electrocardiography	3
MEAS 206	Advanced Electrocardiography Techniques	3
Regionally Determined Credits		15

Insurance Concentration (21 credits)

Correctly coding and billing insurance claims is a vital piece of the medical profession and is a job which demands specialized training. This concentration starts with basic insurance claims and coding, and progresses to advanced duties which include hospital billing, coding and claims.

MEAS 137	Medical Insurance and Basic Coding with Computer Applications	3
MEAS 213	Advanced Insurance Coding	3
MEAS 220	Advanced Insurance Claims Processing	3
Regionally Determined Credits		12

Pharmacy Technician Concentration (21 credits)

This concentration will equip you to assist pharmacies, medical centers and other medical facilities.

APHY 101	Anatomy and Physiology I	3
----------	--------------------------	---

APHY 102	Anatomy and Physiology II	3
CINS 101	Introduction to Microcomputers	3
MEAS 151	Pharmacy Technician I	3
MEAS 152	Pharmacy Technician II	3
MEAS 218	Pharmacology	3
MEAS 254	Pharmacy Externship	3
or		
MEAS 255	Pharmacy Technical Experiential Seminar	3

Phlebotomy Concentration (21 credits)

This concentration prepares you to be a specialist in obtaining blood samples at hospitals, laboratories and other medical facilities.

MEA 212	Phlebotomy	3
MEA 257	Phlebotomy Externship	3
Regionally Determined Credits		15

Therapeutic Massage Concentration (33 credits)

This concentration provides you with information in anatomy and physiology of skeletal, cardiovascular, lymphatic, respiratory, and muscular systems. It includes information on different styles, techniques and viewpoints of massage. The course demonstrates the physiological effects of circulatory massage strokes.

HLHS 105	Medical Law and Ethics	3
APHY 101	Anatomy and Physiology I	3
APHY 102	Anatomy and Physiology II	3
TMAS 101	Holistic Approach to Massage Therapy	3
TMAS 120	Massage Technician Training I	3
TMAS 122	Massage Financial Management	3
TMAS 125	Acupressure Theory and Methods	3
TMAS 140	Massage Technician Training II	3
TMAS 141	Massage Through the Life Span	3
TMAS 202	Deep Tissue Muscle Release	3
TMAS 205	Pathology and Massage	3

Transcription Concentration (21 credits)

This concentration prepares you to work in the field of medical transcription with focus on word processing software and medical dictation. You will learn proofreading techniques and improve speed and accuracy in production of medical documents.

MEAS 135	Medical Word Processing and Transcription	3
MEAS 235	Advanced Transcription	3
Regionally Determined Credits		15

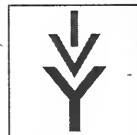

IVY TECH
COMMUNITY
COLLEGE

Medical Laboratory Technology

Program Description

As research continues to change the face of modern medicine, more sophisticated tests allow for more accurate and rapid diagnosis. Medical Laboratory Technology (MLT) has become a technologically complex field requiring specific knowledge and skills. The MLT program at Ivy Tech will train you to proficiently perform the duties required in a clinical laboratory. This two-year Associate in Applied Science Degree Program will prepare you theoretically and technically for the procedures you will be performing.

Sample Careers

Medical Laboratory Technician, Clinical Laboratory Technician

Degrees Available

Associate of Applied Science

Concentrations Offered

None

Availability of concentrations and degrees varies by campus. Contact your local campus for more information.

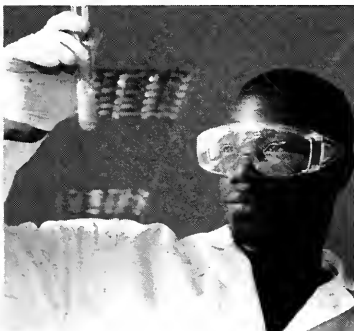

Associate of Applied Science

To earn this degree, you must have 69-71 credits in the following areas:

General Education Core	19-20
Professional/Technical Core	50-51

General Education (19-20 Credits)

APHY 101	Anatomy and Physiology I	3
** APHY 102	Anatomy and Physiology II or	3
** BIOL 201	General Microbiology	4
** COMM 101	Fundamentals of Public Speaking or	3
** COMM 102	Introduction to Interpersonal Communication	3
ENGL 111	English Composition	3
IVYT 1XXX	Life Skills Elective	1
MATH 1XX	Mathematics Elective	3
** PSYC 101	Introduction to Psychology or	3
** SOCI 111	Introduction to Sociology	3

Professional/Technical (50-51 credits)

** CHEM 101	Introductory Chemistry I or	3
** CHEM 111	Chemistry I	4
HLHS 105	Medical Law and Ethics	3
MEDL 101	Fundamentals of Laboratory Techniques	3
MEDL 102	Routine Analysis Techniques	3
MEDL 201	Immunology Techniques	3
MEDL 202	Immunohematology Techniques	3
MEDL 205	Hematology Techniques I	3
MEDL 206	Hematology Techniques II	3
MEDL 207	Chemistry Techniques I	3
MEDL 209	Routine Analysis Applications	1
MEDL 210	Hematology Applications	3
MEDL 212	Immunology Applications	1
MEDL 213	Immunohematology Applications	3

MEDL 215	Parasitology and Mycology	1
^ MEDL 218	Clinical Pathology	3
MEDL 221	Microbiology Applications	3
MEDL 222	Microbiology Techniques	3
MEDL 224	Chemistry Applications	3
MEDL 227	Chemistry Techniques II	2

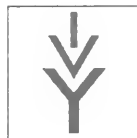

IVY TECH
COMMUNITY
COLLEGE

Mortuary Science

Program Description

Program Aim:

The central aim of the Mortuary Science program recognizes the importance of funeral service education personnel as:

1. Members of a human service profession,
2. Members of the community in which they serve,
3. Participants in the relationship between bereaved families and those engaged in the funeral service profession,
4. Professionals knowledgeable of and compliant with federal, state, provincial/territorial, and local regulatory guidelines (in the geographic area where they practice), as well as
5. Professionals sensitive to the responsibility for public health, safety and welfare in caring for human remains.

Program Objectives:

1. To enlarge the background and knowledge of students about the funeral service profession;
2. To educate students in every phase of funeral service, and to help enable them to develop the proficiency and skills necessary for the profession, as defined by the Preamble above.
3. To educate students concerning the responsibilities of the funeral service profession to the community at large.
4. To emphasize high standards of ethical conduct.
5. To provide a curriculum at the post secondary level of instruction.
6. To encourage student and faculty research in the field of funeral service

The annual passage rate of first-time takers on the National Board Examination (NBE) for the most recent three-year period for this institution and all ABFSE accredited funeral service education programs is posted on the ABFSE website (www.abfse.org).

All mortuary science students must take the National Board Examination (NBE) as a graduation requirement.

The Mortuary Science Program at Ivy Tech Community College of Indiana-De La Garza campus is accredited by the American Board of Funeral Service Education, 3432 Ashland Avenue, Suite U, St. Joseph, MO 64506, (816) 233-3747. Web: www.abfse.org.

The Mortuary Science Program at Ivy Tech Community College of Indiana-Central Indiana is accredited by the American Board of Funeral Service Education, 3432 Ashland Avenue, Suite U, St. Joseph, MO 64506, (816) 233-3747. Web: www.abfse.org.

Sample Careers

Embalmer, funeral director

Degrees Available

Associate of Applied Science

Concentrations Offered

None

Availability of concentrations and degrees varies by campus. Contact your local campus for more information.

Associate of Applied Science

To earn this degree, you must have 67 credits in the following areas:

General Education Core	22
Professional/Technical Core	45

General Education (19 credits)

# APHY 101	Anatomy and Physiology I	3
# APHY 102	Anatomy and Physiology II	3
# BIOL 211	General Microbiology I	3
COMM 102	Introduction to Interpersonal Communication	3
# ENGL 111	English Composition	3
IVYT 1XX	Life Skills Elective	1
# MATH 111	Intermediate Algebra	3
SOCI 111	Introduction to Sociology	3

Professional/Technical (45 credits)

ACCT 101	Financial Accounting	3
BUSN 101	Introduction to Business	3
CINS 101	Introduction to Microcomputers	3
# MORT 100	Orientation to Funeral Service	3
MORT 101	Grief Psychology for Funeral Service	3
MORT 102	Mortuary Law	3
MORT 103	Embalming Chemistry	3
MORT 105	Embalming Theory I	3
MORT 205	Embalming Theory II	3
MORT 207	Embalming Practicum I	3
MORT 208	Pathology for Funeral Service	3
MORT 209	Restorative Art	3
MORT 212	Funeral Service Management	3
MORT 217	Embalming Practicum II	3
^ MORT 220	National Board Exam Review	3

Courses must be successfully completed before admittance to the program.

Nursing

Program Description

The Associate of Science in Nursing Program is designed to accommodate two groups of students: those who are entering a nursing program for the first time and those licensed practical nurses or certified paramedics seeking educational mobility to the associate-degree level. As a graduate of the ASN program, you will be eligible to take the NCLEX-RN examination to become registered nurses. You may seek immediate employment as nurses or choose to transfer their credits to a four-year institution offering a baccalaureate degree.

Sample Careers

Registered Nurse

Degrees Available

Associate of Science

Concentrations Offered

None

Availability of concentrations and degrees varies by campus. Contact your local campus for more information.



Nursing continued

Articulated transfer opportunities are available with Ball State University, the IU School of Nursing, Indiana State University, and the University of Southern Indiana. Students are encouraged to review these options with their advisors, to consult the current catalog of the institution to which they wish to transfer, and to contact the institution to which they wish to transfer. Additional opportunities for course and program transfer may also be available at your local campus. Students should contact the transfer office of their local Ivy Tech for further information.

Associate of Science

To earn this degree, you must have 45-71 credits in the following areas:

General Education Core	31-33
Professional/Technical Core	14-38

General Education (31-33 Credits)

# APHY 101	Anatomy and Physiology I	3
# APHY 102	Anatomy and Physiology II	3
# ENGL 111	English Composition	3
IVYT 1XX	Life Skills Elective	1
# PSYC 101	Introduction to Psychology	3
MATH 117	The Art of Geometry	3
or		
MATH 118	Concepts in Mathematics	3
PSYC 201	Lifespan Development	3
or		
PSYC 205	Abnormal Psychology	3
or		
SOCI 111	Introduction to Sociology	3
or		
SOCI 164	Introduction to Multicultural Studies	3
COMM 101	Fundamentals of Public Speaking	3
or		
COMM 102	Introduction to Interpersonal Communication	3
ENGL 112	Exposition and Persuasion	3
or		
ENGL 211	Technical Writing	3

Choose two of the following:

APHY 201	Advanced Human Physiology	4
BIOL 201	General Microbiology	4
<> BIOL 211	General Microbiology I	3

>< CHEM 101	Introductory Chemistry	3
CHEM 111	Chemistry I	4
PHYS 101	Physics I	4

Professional/Technical Traditional (38 credits)

NRSG 100	Fundamentals of Nursing	3
X NRSG 101	Fundamentals of Nursing Lab	1
NRSG 102	Medical-Surgical Nursing I	2
NRSG 103	Medical-Surgical Nursing I Lab	2
NRSG 105	Medical-Surgical Nursing I Clinical	2
NRSG 106	Pharmacology for Nursing	3
NRSG 110	Medical Surgical Nursing II	3
NRSG 111	Medical Surgical Nursing II Clinical	2
NRSG 112	Maternal-Child Nursing	3
NRSG 113	Maternal-Child Nursing Clinical	2
NRSG 114	Health Care Concepts in Nursing	1
^ NRSG 200	Complex Medical-Surgical Nursing for the ASN	3
NRSG 201	Complex Medical-Surgical Nursing for the ASN Clinical	4
NRSG 202	Nursing Care of the Complex Family	2
NRSG 203	Nursing Care of the Complex Family Clinical	2
NRSG 204	Psychiatric Nursing	2
NRSG 205	Psychiatric Nursing Clinical	1

Professional/Technical LPN Transition to Nursing (New Curriculum) (14 credits)

^ NRSG 200	Complex Medical-Surgical Nursing for the ASN	3
NRSG 201	Complex Medical Surgical Nursing for the ASN Clinical	4
NRSG 202	Nursing Care for the Complex Family	2
NRSG 203	Nursing Care of the Complex Family Clinical	2
NRSG 204	Psychiatric Nursing	2
NRSG 205	Psychiatric Nursing Clinical	1

Professional/Technical LPN Transition to Nursing (Old Curriculum) (22 credits)

NRSG 106	Pharmacology for Nursing	3
NRSG 120	Transition to ASN for the LPN	5
^ NRSG 200	Complex Medical Surgical Nursing for the ASN	3

NRSG 201	Complex Medical Surgical Nursing for the ASN Clinical	4
NRSG 202	Nursing Care of the Complex Family	2
NRSG 203	Nursing Care of the Complex Family Clinical	2
NRSG 204	Psychiatric Nursing	2
NRSG 205	Psychiatric Nursing Clinical	1

Professional/Technical Paramedic Transition to Nursing (30 credits)

NRSG 106	Pharmacology for Nursing	3
NRSG 108	Transition for the Paramedic to the ASN	5
NRSG 109	Transition for the Paramedic to the ASN Lab/Clinical	3
NRSG 112	Maternal-Child Nursing	3
NRSG 113	Maternal Child Nursing Clinical	2
^ NRSG 200	Complex Medical-Surgical Nursing for the ASN	3
NRSG 201	Complex Medical Surgical Nursing for the ASN Clinical	4
NRSG 202	Nursing Care for the Complex Family	2
NRSG 203	Nursing Care of the Complex Family Clinical	2
NRSG 204	Psychiatric Nursing	2
NRSG 205	Psychiatric Nursing Clinical	1

Symbol Key

- ^ Capstone Course
- # Courses must be successfully completed before admittance to the program
- <> BIOL 201 will substitute for BIOL 211
- >< CHEM 111 will substitute for CHEM 101
- X Advanced placement may be available for Certified Nursing Assistant - see program chair

Office Administration

Program Description

As the business office relies increasingly on technology, companies need a well-trained, take-charge person to ensure that daily tasks are handled quickly and efficiently. In Ivy Tech's Office Administration Program, you'll learn the technical and interpersonal skills that will make you a key player in day-to-day operations. Not only will you cover basics of word processing, spreadsheets and databases, but you'll also study more advanced areas such as desktop publishing, developing skills that will move you to the top of a company's must-hire list. Programs are tailored for beginning, intermediate and advanced skill levels.

Sample Careers

Administrative assistant, first line manager, legal secretary, software application specialist

Degrees Available

Associate of Applied Science, Technical Certificate

Certificates Offered

Microsoft Certified Application Specialist

Concentrations Offered

Administrative, Legal, Medical, Software Applications

Availability of concentrations and degrees varies by campus. Contact your local campus for more information.



Associate of Applied Science

To earn this degree, you must have 61 credits in the following areas:

General Education Core	19
Professional/Technical Core	18
Concentration Courses	12
Regionally Determined Credits	12

General Education (19 Credits)

COMM 101 Fundamentals of Public Speaking	3
* ECON XXX Economics Elective	3
ENGL 111 English Composition	3
IVYT 1XX Life Skills Elective	1
** MATH 1XX Mathematics Elective	3
* XXXX XXX Life/Physical Sciences Elective	3
* XXXX XXX Humanities/Social Sciences Elective	3

Professional/Technical (18 credits)

ACCT 101 Financial Accounting	3
BUSN 101 Introduction to Business	3
OFAD 103 Introduction to Computers with Word Processing	3
OFAD 119 Document Processing	3
OFAD 216 Business Communications	3
^ OFAD 221 Organizational Leadership	3

Choose One of the Following Concentrations

Administrative Concentration (24 credits)

This concentration prepares you for an automated office environment, covering skills such as word processing and microcomputer operating systems. As an administrative assistant, your tasks might include secretarial duties, scheduling work and planning meetings, taking minutes and composing correspondence.

OFAD 114 Desktop Publishing	3
OFAD 121 Office Procedures and Team Dynamics	3
OFAD 218 Spreadsheets	3
OFAD 220 Records and Database Management	3
Regionally Determined Credits	12

Legal Concentration (24 credits)

Legal office administrators perform and coordinate a law office's administrative activities and disseminate information to staff and

clients. This concentration prepares you to use computers, business software and different legal research tools. Legal office administrators prepare correspondence and legal documents.

PARA 101 Introduction to Paralegal Studies	3
PARA 102 Legal Research	3
PARA 103 Civil Procedure	3
DFAD 218 Spreadsheets	3
Regionally Determined Credits	12

Medical Concentration (24 credits)

Working in a medical office requires specific job skills, such as a knowledge of medical terminology and transcription skills. Medical office administrators are responsible for a variety of administrative and clerical duties necessary to run a medical office efficiently.

HLHS 101 Medical Terminology	3
MEAS 137 Medical Insurance & Basic Coding with Computer Applications	3
DFAD 121 Office Procedures and Team Dynamics	3
DFAD 220 Records and Database Management	3
Regionally Determined Credits	12

Software Applications Concentration (24 credits)

This concentration prepares you for an office environment, covering skills such as word processing, microcomputer operating systems, multimedia design and desktop publishing. With a software applications concentration, your career choice could range from software applications specialist to desktop publisher.

OFAD 114 Desktop Publishing	3
OFAD 214 Multimedia Design	3
OFAD 218 Spreadsheets	3
OFAD 222 Database Applications	3
Regionally Determined Credits	12

Associate of Applied Science via Distance Education

To earn this degree, you must have 61 credits in the following areas:

General Education Core	19
Professional/Technical Core	42

General Education (19 Credits)

COMM 101 Fundamentals of Public Speaking	3
--	---

Office Administration continued

* ECON XXX	Economics Elective	3
ENGL 111	English Composition	3
IVYT 1XX	Life Skills Elective	1
** MATH 1XX	Mathematics Elective	3
* XXXX XXX	Life/Physical Sciences Elective	3
* XXXX XXX	Humanities/Social Sciences Elective	3

Professional/Technical (42 credits)

ACCT 101	Financial Accounting	3
BUSN 101	Introduction to Business	3
OFAD 103	Introduction to Computers with Word Processing	3
OFAD 110	Presentation Graphics	3
OFAD 114	Desktop Publishing	3
OFAD 116	Essentials of Business Correspondence	3
OFAD 119	Document Processing	3
OFAD 121	Office Procedures and Team Dynamics	3
OFAD 130	Quality and Customer Care	3
OFAD 216	Business Communications	3
DFAD 218	Spreadsheets	3
DFAD 220	Records and Database Management	3
△ OFAD 221	Organizational Leadership	3
OFAD 222	Database Applications	3

Technical Certificate

To earn this degree, you must have 31 credits in the following areas:

General Education Core	7
Professional/Technical Core	3
Concentration Courses	9-18
Regionally Determined Credits	3-12

General Education (7 Credits)

ENGL 111	English Composition	3
IVYT 1XX	Life Skills Elective	1
* XXXX XXX	Humanities/Social Sciences Elective	3

Professional/Technical (3 credits)

DFAD 119	Document Processing	3
----------	---------------------	---

Choose One of the Following Concentrations

Administrative Concentration (21 credits)

DFAD 103	Introduction to Computers with Word Processing	3
OFAD 121	Office Procedures and Team Dynamics	3
DFAD 218	Spreadsheets	3
Regionally Determined Credits		12

Customer Service Concentration (21 credits)

DFAD 103	Introduction to Computers with Word Processing	3
OFAD 121	Office Procedures and Team Dynamics	3
OFAD 130	Quality and Customer Service	3
OFAD 216	Business Communication	3
OFAD 217	Problem Solving for Computer Users	3
OFAD 218	Spreadsheets	3
Regionally Determined Credits		3

Certificate

Microsoft Certified Application Specialist (18 Credits)

OFAD 103	Introduction to Computers with Word Processing	3
DFAD 110	Presentation Graphics	3
OFAD 204	Outlook 2003	3
OFAD 218	Spreadsheets	3
OFAD 222	Database Applications	3
OFAD 226	Advanced Electronic Spreadsheets	3



IVY TECH
COMMUNITY
COLLEGE

Paralegal Studies

Program Description

If you like writing, research and problem-solving, you'll love a career as a paralegal. Our Paralegal program provides students with the wide variety of skills needed to handle duties such as performing legal research, drafting legal correspondence, interviewing clients and managing trial exhibits. Courses are taught by attorneys who are experienced in the subject matter and familiar with the important role paralegals play as members of the legal team.

Sample Careers

Legal assistant, paralegal

Degrees Available

Associate of Science, Associate of Applied Science

Concentrations Offered

None

Availability of concentrations and degrees varies by campus. Contact your local campus for more information.

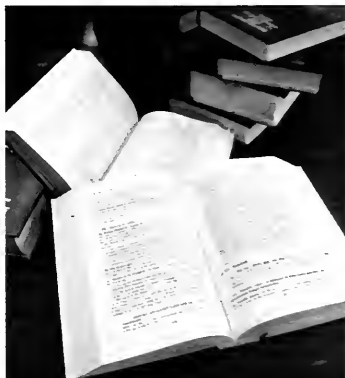

Associate of Science

Articulated transfer through an Associate of Science in Paralegal Studies is available with Ball State University and JUPU-Fort Wayne. To view these Associate of Science transfer degree programs and to see if they are available at your local Ivy Tech campus, students should go to <http://www.ivytech.edu/>.

Students are encouraged to review these options with their advisors, to consult the current catalog of the institution to which they wish to transfer, and to contact the institution to which they wish to transfer. Additional opportunities for course and program transfer may also be available at your local campus. Students should contact the transfer office of their local Ivy Tech for further information.

Associate of Applied Science

To earn this degree, you must have 64 credits in the following areas:

General Education Core	19
Professional/Technical Core	33
Regionally Determined Credits	12

General Education (19 Credits)

COMM 101 Fundamentals of Public Speaking	3
or	
COMM 102 Introduction to Interpersonal Communication	3
ENGL 111 English Composition	3
ENGL 112 Exposition and Persuasion	3
or	
ENGL 211 Technical Writing	3
IVYT 1XX Life Skills Elective	1
** MATH 1XX Intermediate Algebra or Higher	3
* XXXX XXX Humanities/Social Sciences Elective	3
* XXXX XXX Life/Physical Sciences Elective	3

Professional/Technical (45 credits)

CINS 101 Introduction to Microcomputers	3
PARA 101 Introduction to Paralegal Studies	3
PARA 102 Legal Research	3
PARA 103 Civil Procedures	3
PARA 106 Tort Law	3
PARA 107 Contracts and Commercial Law	3

PARA 108 Property Law	3
PARA 200 Legal Ethics	3
PARA 202 Litigation	3
PARA 203 Law Office Technology	3
^ PARA 204 Legal Writing	3
Regionally Determined Credits	12

Associate of Applied Science— Distance Education

To earn this degree, you must have 64 credits in the following areas:

General Education Core	19
Professional/Technical Core	33
Regionally Determined Credits	12

General Education (19 Credits)

COMM 101 Fundamentals of Public Speaking	3
or	
COMM 102 Introduction to Interpersonal Communication	3
ENGL 111 English Composition	3
ENGL 112 Exposition and Persuasion	3
or	
ENGL 211 Technical Writing	3
IVYT 1XX Life Skills Elective	1
** MATH 1XX Intermediate Algebra or Higher	3
* XXXX XXX Humanities/Social Sciences Elective	3
* XXXX XXX Life/Physical Sciences Elective	3

Professional/Technical (33 credits)

CINS 101 Introduction to Microcomputers	3
PARA 101 Introduction to Paralegal Studies	3
PARA 102 Legal Research	3
PARA 103 Civil Procedures	3
PARA 106 Tort Law	3
PARA 107 Contracts and Commercial Law	3
PARA 108 Property Law	3
PARA 200 Legal Ethics	3
PARA 202 Litigation	3
PARA 203 Law Office Technology	3
^ PARA 204 Legal Writing	3

Electives (12 credits)

Choose four from this list of courses

PARA 205 Business Associations	3
PARA 209 Family Law	3
PARA 210 Wills, Trusts and Estates	3
PARA 211 Criminal Law and Procedure	3
PARA 280 Internship	3
PARA XXX Paralegal Elective	3



IVY TECH
COMMUNITY
COLLEGE

Paramedic Science

Program Description

Does the idea of being an emergency first-responder make your heart beat a little faster? Are you an emergency medical technician who wants to get to the next level of emergency care and job opportunity? Then our Paramedic Science program may be for you. Through clinical and practical instruction as well as a field internship, you'll be prepared to function in the uncontrolled environment of emergency medicine in the pre-hospital setting. Upon completion, you'll qualify for state certification as an emergency medical technician-paramedic. Already a certified paramedic? Take just seven general education courses, and you'll earn an Associate of Science degree that transfers into four-year degree programs.

Sample Careers

EMT, paramedic

Degrees Available

Associate of Science, Associate of Applied Science

Concentrations Offered

None

Availability of concentrations and degrees varies by campus. Contact your local campus for more information.



The Paramedic Science program is accredited by the Commission on Accreditation of the Allied Health Education Program (CAAHEP), in collaboration with the Committee on Accreditation of Education Programs for the Emergency Medical Services Professional.

Commission on Accreditation of Allied Health Education Programs

1361 Park Street
Clearwater, FL 33756
(727) 210-2350

Associate of Science

Articulated transfer through an Associate of Science in Paramedic Science is available with the University of Southern Indiana. To view the Associate of Science transfer degree program and to see if it is available at your local Ivy Tech campus, students should go to <http://www.ivytech.edu/>.

Students are encouraged to review these options with their advisors, to consult the current catalog of the institution to which they wish to transfer, and to contact the institution to which they wish to transfer. Additional opportunities for course and program transfer may also be available at your local campus. Students should contact the transfer office of their local Ivy Tech for further information.

Associate of Applied Science/Associate of Science

To earn this degree, you must have 66.5 credits in the following areas:

General Education Core	19
Professional/Technical Core	47.5

General Education (19 Credits)

APHY 101	Anatomy and Physiology I	3
APHY 102	Anatomy and Physiology II	3
* COMM XXX	Communications Elective	3
ENGL 111	English Composition	3
IVYT 1XX	Life Skills Elective	1
* MATH 1XX	Mathematics Elective	3
XXXX XXX	Humanities/Social Science Elective	3

Professional/Technical (47.5 credits)

PARM 102	Emergency Medical Technician - Basic Training	7.5
PARM 111	Preparatory	3
PARM 112	Prehospital Pharmacy	3
PARM 115	Airway, Patient Assessment	3.5
PARM 116	Clinical Applications I	1.5
PARM 200	Trauma	3
PARM 210	Medical I	6
PARM 213	Medical II	5
PARM 215	Special Considerations	3.5
PARM 216	Clinical Applications II	1.5
PARM 219	Clinical Applications III	1.5
^ PARM 220	Operations	2.5
PARM 221	Ambulance Internship	6



Physical Therapist Assistant

Program Description

If you like to help people and want to work in the medical field, our Physical Therapist Assistant program may be for you. The PTA program will prepare you to work, under the supervision of a physical therapist, with physically impaired persons to help reverse adverse effects of physical disability. The therapist and assistant work together to provide appropriate therapeutic intervention and communication within the health care team. You will learn to administer therapeutic and psychosocial support for individuals with musculoskeletal, neurological, cardiopulmonary, vascular or other physiological dysfunctions.

Sample Careers

Physical Therapist Assistant

Degrees Available

Associate of Science

Concentrations Offered

None

Availability of concentrations and degrees varies by campus. Contact your local campus for more information. See page 6 for contact information.



Associate of Science

To earn this degree, you must have 69.5 credits in the following areas:

General Education Core	25
Professional/Technical Core	44.5

General Education (25 Credits)

# APHY 101	Anatomy and Physiology I	3
APHY 102	Anatomy and Physiology II	3
COMM 101	Fundamentals of Public Speaking	3
or		
COMM 102	Introduction to Interpersonal Communication	3
# ENGL 111	English Composition	3
IVYT 1XX	Life Skills Elective	1
MATH 118	Concepts in Mathematics	3
PSYC 101	Introduction to Psychology	3
SOCI 111	Introduction to Sociology	3
SCIN 111	Physical Science	3

Professional/Technical (42.5 credits)

# PTAS 101	Introduction to Physical Therapist Assistant	3
PTAS 102	Diseases, Trauma, and Terminology	3
PTAS 103	Administrative Aspects of Physical Therapist Assisting	3
PTAS 106	PTA Treatment Modalities I	5
PTAS 107	Kinesiology	5
PTAS 115	Clinical I	2.5
PTAS 205	Clinical II	6
PTAS 207	PTA Treatment Modalities II	5
PTAS 215	Clinical III	6
PTAS 217	PTA Treatment Modalities III	5
^ PTAS 224	Current Issues and Review	1

Courses must be successfully completed before admittance to the program

Practical Nursing

Program Description

The licensed practical nurse (LPN) is an integral part of the health care team. The Practical Nursing program leads to a Technical Certificate and can be completed in approximately one year. The accredited program will prepare you to care for patients in a variety of health care settings, such as hospitals, convalescent centers, clinics, home care and physicians' offices. Graduates are eligible to take the state licensure exam to become a licensed practical nurse.

Sample Careers

LPN, LPVN

Degrees Available

Technical Certificate

Concentrations Offered

None

Availability of concentrations and degrees varies by campus. Contact your local campus for more information.



Practical Nursing continued

Technical Certificate

To earn this degree, you must have 43 credits in the following areas:

General Education Core	13
Professional/Technical Core	30

General Education (13 Credits)

# APHY 101	Anatomy and Physiology I	3
# APHY 102	Anatomy and Physiology II	3
# ENGL 111	English Composition	3
IVYT 1XX	Life Skills Elective	1
# PSYC 101	Introduction to Psychology	3

Professional/Technical (30 credits)

NRSG 100	Fundamentals of Nursing	3
X NRSG 101	Fundamentals of Nursing Lab	1
NRSG 102	Medical-Surgical Nursing I	2
NRSG 103	Medical-Surgical Nursing I Lab	2
NRSG 105	Medical-Surgical Nursing I Clinical	2
NRSG 106	Pharmacology for Nursing	3
NRSG 110	Medical Surgical Nursing II	3
NRSG 111	Medical Surgical Nursing II Clinical	2
NRSG 112	Maternal-child Nursing	3
NRSG 113	Maternal-child Nursing Clinical	2
NRSG 114	Health Care Concepts in Nursing	1
△ NRSG 116	Geriatric/Complex Medical Surgical Nursing for the Practical Nurse III	4
NRSG 117	Geriatric/Complex Medical Surgical Nursing for the Practical Nurse Clinical III	2

Symbol Key

- △ Capstone Course
- X Advanced placement may be available for Certified Nursing Assistant – see program chair
- # Courses must be successfully completed before admittance to the program

Pre-Engineering

Program Description

The program is designed to prepare you for transfer to baccalaureate degree programs in engineering. The program curriculum will provide a strong foundation in science, math and technology. Special emphasis is placed on qualitative and quantitative analytical skills necessary in engineering design and problem solving while working in a cooperative team environment. Skills and knowledge can be applied to a wide range of baccalaureate engineering specialties including Electrical, Mechanical, Civil, Industrial, and Chemical engineering. The program will also focus on the applied aspects of science and engineering.

Sample Careers

Transfer degree

Degrees Available

Associate of Science

Concentrations Offered

None

Availability of concentrations and degrees varies by campus. Contact your local campus for more information.

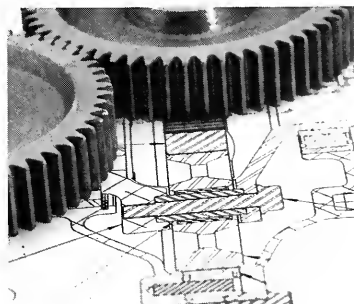

Associate of Science

To earn this degree, you must have 66-67 credits in the following areas:

General Education Core	40
Professional/Technical Core	26-27

General Education (40 Credits)

CHEM 105	General Chemistry I	5
COMM 101	Fundamentals of Public Speaking	3
ENGL 111	English Composition	3
IVYT 1XX	Life Skills Elective	1
MATH 211	Calculus I	4
MATH 212	Calculus II	4
MATH 261	Multivariate Calculus	4
MATH 264	Differential Equations	3
PHYS 220	Mechanics	5
PHYS 221	Heat, Electricity and Optics	5
XXXX XXX	Humanities/Social Sciences elective	3

Professional/Technical (26-27 credits)

ENGR 116	Geometric Modeling for Visualization	2
ENGR 140	Introduction to Engineering I	3
ENGR 160	Introduction to Engineering II	3
ENGR 190	Introduction to Engineering Design	2
ENGR 251	Electrical Circuits I	4
ENGR 260	Vector Mechanics-Statics	3
△ ENGR 261	Dynamics	3
ENGR 270	Engineering Project Management	3
ENGR XXX	Pre-engineering elective	3-4



Professional Communication

Program Description

The Professional Communication program provides you with a rich background in the arts and sciences. This background will equip you with problem solving skills, communication and writing abilities, and experience in communicating and designing texts using information technologies.

Sample Careers

Executive assistant, writer

Degrees Available

Associate of Science

Concentrations Offered

None

Availability of concentrations and degrees varies by campus. Contact your local campus for more information.



Associate of Science

To earn this degree, you must have 64 credits in the following areas:

General Education Core	31
Professional/Technical Core	33

General Education (31 Credits)

COMM 101	Fundamentals of Public Speaking	3
ENGL 111	English Composition	3
ENGL 112	Exposition and Persuasion	3
IVYT 1XX	Life Skills Elective	1
MATH 111	Intermediate Algebra	3
XXXX XXX	Science Elective	3
XXXX XXX	Social Services Electives	6
XXXX XXX	Humanities Electives	9

Professional/Technical (33 credits)

BUSN 101	Introduction to Business	3
CINS 101	Introduction to Microcomputers	3
COMM 102	Introduction to Interpersonal Communication	3
COMM 201	Introduction to Mass Communication	3
COMM 202	Small Group Communication	3
COMM 211	Fundamentals of Public Relations	3
ENGL 202	Creative Writing	3
ENGL 211	Technical Writing	3
PSYC 101	Introduction to Psychology	3
VISC 101	Fundamentals of Design	3
VISC 115	Introduction to Computer Graphics	3



Public Safety

Program Description

The Public Safety Technology program is designed to meet the ongoing needs of municipalities, students, business, and industries. The program will develop your technical skills, general knowledge, critical thinking, and problem solving abilities. Broad-based technical skills and critical thinking processes will assist you in adapting to changes in the work environment and promoting successful advancement on the job.

Sample Careers

Public safety specialist, firefighter, environmental safety specialist

Degrees Available

Associate of Applied Science, Technical Certificate

Concentrations Offered

Environmental Health and Safety, Fire Science, Hazardous Materials, Public Administration

Availability of concentrations and degrees varies by campus. Contact your local campus for more information.



Public Safety continued

Associate of Applied Science

To earn this degree, you must have 62-66 credits in the following areas:

General Education Core	19
Professional/Technical Core	19
Concentration Courses	12-15
Regionally Determined Credits	12-13

General Education (19 Credits)

** BIOL 101	Introductory Biology	3
or		
** SCIN 111	Physical Science	3
CHEM 101	Introductory Chemistry I	3
** COMM 101	Fundamentals of Public Speaking	3
or		
** COMM 102	Introduction to Interpersonal Communication	3
ENGL 111	English Composition	3
IVYT 1XX	Life Skills Elective	1
MATH 1XX	Mathematics Elective	3
POLS 101	Introduction to American Government and Politics 3	
or		
POLS 220	Public Administration	3

Professional/Technical (19 credits)

PSAF 115	Hazmat Awareness and Operations	3
PSAF 120	First Responder	3
PSAF 121	Risk Management	3
PSAF 220	Incident Management Systems	3
PSAF 222	Computer Applications in Public Safety	3
△ PSAF 279	Public Safety Capstone Course	1
TECH 104	Computer Fundamentals for Technology	3

Choose One of the Following Concentrations

Environmental Health and Safety Concentration

(24credits)

This concentration prepares you to work in state and local agencies, waste water facilities, private companies and labs where they often test samples in lab environments, monitor air and water quality and advise on nature conservation strategies, site management, species protection, urban and rural development, and pest control.

ENVM 101	Introduction to Environmental Technology	3
ENVM 102	Environmental Management	3
ENVM 110	Environmental Toxicology	3
HAZM 200	Environmental Protection Agency (EPA) Regulations	3
Regionally Determined Credits		12

Fire Science Concentration (27-28 credits)

This concentration prepares you to work in public and industrial fire departments and at airports and fire protection agencies where they often respond to and put out fires, operate emergency equipment and investigate fires.

FIRE 102	Fire Apparatus and Equipment	3
FIRE 103	Firefighting Strategy and Tactics	3
FIRE 201	Fire Protection Systems	3
FIRE 202	Fire Service Management	3
FIRE 204	Fire Service Hydraulics	3
Regionally Determined Credits		12-13

Hazardous Materials Concentration (24 credits)

This concentration prepares you to work in fire departments, spill recovery companies, environment companies or government agencies.

HAZM 100	OSHA Regulations	3
HAZM 104	HAZ-MAT Health Effects	3
HAZM 200	Environmental Protection Agency (EPA) Regulations	3
HAZM 220	Hazardous Materials Recovery, Incineration and Disposal	3
Regionally Determined Credits		12

Public Administration Concentration (24 credits)

The Public Administration specialty prepares you to work in local, city and state government agencies where you might support city managers of other public administrators.

BUSN 105	Principles of Management	3
BUSN 208	Organizational Behavior	3
OPMT 224	Operations Management	3
POLS 112	State and Local Government	3
Regionally Determined Credits		12

Technical Certificate—Fire Science

To earn this degree, you must have 31 credits in the following areas:

General Education Core	7
Professional/Technical Core	3
Specialty Courses	6
Regionally Determined Credits	15

General Education (7 Credits)

ENGL 111	English Composition	3
IVYT 1XX	Life Skills Elective	1
POLS 101	Introduction to American Government and Politics	3

Professional/Technical (3 credits)

TECH 104	Computer Fundamentals for Technology	3
----------	--------------------------------------	---

Other Required Courses (21 credits)

FIRE 103	Firefighting Strategy and Tactics	3
FIRE 201	Fire Protection Systems	3
Regionally Determined Credits		15



IVY TECH
COMMUNITY
COLLEGE

Radiation Therapy

Program Description

This newest degree track brings another strong addition to Ivy Tech's commitment to the growth of our Life Science initiatives through education and professional development in our community. The Radiation Therapy program provides didactic and clinical education opportunities for individuals who enjoy significant patient interaction and close patient/professional relationships. Clinical practice occurs at our partnering medical centers and oncology clinics throughout Indiana.

Sample Careers

Radiation Therapist

Degrees Available

Associate of Science

Availability of concentrations and degrees varies by campus. Contact your local campus for more information.



Associate of Science

To earn this degree, you must have 70 credits in the following areas:

General Education Core	26
Professional/Technical Core	44

General Education (26 Credits)

APHY 101	Anatomy and Physiology I	3
APHY 102	Anatomy and Physiology II	3
COMM 101	Fundamentals of Public Speaking	3
or		
COMM 102	Introduction to Interpersonal Communication	3
ENGL 111	English Composition	3
IVYT 1XX	Life Skills Elective	1
MAT 13X	Mathematics Elective	3
PSYC 101	Introduction to Psychology	3
PHYS 101	Physics I	4
XXXX XXX	Humanities Elective	3

Professional/Technical (44 credits)

HLHS 101	Medical Terminology	3
RDTH 100	Introduction to Radiation Therapy	2
RDTH 145	Clinical Externship I	1
RDTH 150	Patient Care Radiation Oncology	3
RDTH 155	Clinical Externship II	3
RDTH 220	Techniques and Applications in Radiation Therapy	3
RDTH 223	Radiobiology and Safety	2
RDTH 225	Clinical Externship III	4
RDTH 230	Pathology and Treatment Principles I	2
RDTH 232	Radiation Therapy Physics	3
RDTH 233	Research Methodology in Radiation Oncology	1
RDTH 235	Clinical Externship IV	5
RDTH 240	Pathology and Treatment Principles II	2
RDTH 241	Treatment Planning	3
RDTH 242	Quality Management in Radiation Oncology	2
RDTH 243	Radiation Therapy Capstone Course	2
RDTH 245	Clinical Externship V	3

[^]

Radiologic Technology

Program Description

A radiologic technologist is someone who specializes in using x-rays to create images of the body. The radiographs that are produced by the radiographer enable the doctor to diagnose the patient for disease, fractures, or any irregularities. Therefore, as a radiographer, you must be a professional skilled in the art and science of radiography and able to apply scientific knowledge, problem-solving techniques, and use high-tech equipment, while providing quality patient care. Technologists are in demand in hospitals, clinics, physicians' and dentists' offices.

Sample Careers

Radiologic Technologist

Degrees Available

Associate of Science

Concentrations Offered

None

Availability of concentrations and degrees varies by campus. Contact your local campus for more information.



Radiologic Technology continued

Associate of Science

To earn this degree, you must have 77 credits in the following areas:

General Education Core	19
Professional/Technical Core	58

General Education (19 Credits)

# APHY 101	Anatomy and Physiology I	3
# APHY 102	Anatomy and Physiology II	3
# CDMM 101	Fundamentals of Public Speaking	3
or		
# CDMM 102	Introduction to Interpersonal Communication	3
# ENGL 111	English Composition	3
# IVYT 1XX	Life Skills Elective	1
# MATH 131	Algebra/Trigonometry I	3
or		
# MATH 136	College Algebra	3
*** PSYC 101	Introduction to Psychology	3
or		
*** SOCI 111	Introduction to Sociology	3

Professional/Technical (58 credits)

# CINS 101	Introduction to Microcomputers	3
# HLHS 101	Medical Terminology	3
RADT 111	Orientation and Patient Care	4
RADT 112	Image Production and Evaluation I	3
RADT 113	Radiographic Positioning I and Lab	3
RADT 114	Radiographic Clinical Education I	3
RADT 115	Radiographic Positioning II and Lab	3
RADT 116	Radiographic Clinical Education II	4
RADT 117	Radiation Physics and Equipment Operation	3
RADT 201	Radiographic Positioning III and Lab	3
RADT 202	Radiographic Clinical Education III	4
RADT 203	Radiographic Clinical Education IV	4
RADT 204	Radiographic Clinical Education V	4
RADT 206	Radiobiology and Radiation Protection	3
RADT 209	Radiographic Positioning IV and Lab	3
RADT 218	Image Production and Evaluation II	2
RADT 221	Pharmacology and Advanced Procedures	3
^ RADT 299	General Examination Review	3

Courses must be successfully completed before admittance to the program.

Respiratory Care

Program Description

Respiratory therapists are health care specialists who provide care for patients with breathing disorders. Care includes assessment, evaluation, and treatment of patients ranging in age from premature infants to the elderly. Therapists also work with adults who have chronic lung problems, such as asthma or emphysema. As a respiratory therapist, you must possess good communication skills. You will work side by side with physicians, nurses and other health care providers in caring for patients with lung disorders. As part of the health care team, you help with interviewing patients, making recommendations to physicians to change therapy based on your assessments, and providing patient and family education about lung disease.

Sample Careers

Respiratory therapist

Degrees Available

Associate of Science

Concentrations Offered

None

Availability of concentrations and degrees varies by campus. Contact your local campus for more information.

The Respiratory Care program is accredited by the Commission on Accreditation of the Allied Health Education Programs (CAAHEP), in collaboration with the Committee on Accreditation for Respiratory Care (CoARC), 1361 Park Street, Clearwater, FL 33756; (727) 210-2350



Associate of Science

To earn this degree, you must have 71-73 credits in the following areas:

General Education Core	25-27
Professional/Technical Core	46

General Education (25-27 Credits)

# APHY 101	Anatomy and Physiology I	3
# APHY 102	Anatomy and Physiology II	3
** BIOL 2XX	Microbiology Elective	3-4
* CDMM 101	Fundamentals of Public Speaking	3
or		
* CDMM 102	Introduction to Interpersonal Communication	3
** CHEM 1XX	Chemistry Elective	3-4
# ENGL 111	English Composition	3
IVYT 1XX	Life Skills Elective	1
# MATH 1XX	Math Elective	3
or		
PSYC 101	Introduction to Psychology	3
or		
SDCI 111	Introduction to Sociology	3

Professional/Technical (46 credits)

RESP 121	Introduction to Respiratory Care	6
RESP 122	Therapeutic Modalities	3
RESP 123	Cardiopulmonary Physiology	3
RESP 125	Critical Care I	3
RESP 126	Clinical Medicine I	3
RESP 129	Respiratory Care Pharmacology	3
RESP 134	Clinical Applications I	2
RESP 137	Clinical Applications II	2
RESP 138	Clinical Applications in Adult Critical Care	5
RESP 221	Cardiopulmonary Diagnostics	4
RESP 222	Critical Care II	3
RESP 224	Clinical Medicine II	3
^ RESP 226	Continuing Care	2
RESP 229	Emergency Management	1
RESP 237	Clinical Applications of Advanced Critical Care and Specialty Rotations	3

Courses must be successfully completed before admittance to the program

Surgical Technology

Program Description

A career in surgical technology is very fast-paced and challenging. You may be able to hold a beating heart in your hand. You may be part of a team in the OR that works on replacing a total hip or knee in the orthopedic rotation at your site. You will certainly hand many different instruments to the surgeon in the correct fashion and at the correct time. You will be the keeper of the sterile field. This is a very rewarding career in the Health Science Field. It is not nursing; you do a very specific technical job and work under the RN and Surgeon.

Sample Careers

Surgical Technologist

Degrees Available

Associate of Science, Associate of Applied Science

Concentrations Offered

None

Availability of concentrations and degrees varies by campus. Contact your local campus for more information.



The Surgical Technology program is accredited by the Commission on Accreditation of the Allied Health Education Program (CAAHEP), in collaboration with the Accreditation Review Committee on Education in Surgical Technology (ARCE-ST).

Commission on Accreditation of Allied Health Education Programs

1361 Park Street
Clearwater, FL 33756
(727) 210-2350

Associate of Science

Articulated transfer through an Associate of Science in Surgical Technology is available with IUPUI-FW. To view these Associate of Science transfer degree programs and to see if they are available at your local Ivy Tech campus, students should go to <http://www.ivytech.edu/>.

Students are encouraged to review these options with their advisors, to consult the current catalog of the institution to which they wish to transfer, and to contact the institution to which they wish to transfer. Additional opportunities for course and program transfer may also be available at your local campus. Students should contact the transfer office of their local Ivy Tech for further information.

Associate of Applied Science

To earn this degree, you must have 68-69 credits in the following areas:

General Education Core	19
Professional/Technical Core	49-50

General Education (19 Credits)

# APHY 101	Anatomy and Physiology I	3
APHY 102	Anatomy and Physiology II	3
* COMM 101	Fundamentals of Public Speaking	3
or		
* COMM 102	Introduction to Interpersonal Communication	3
# ENGL 111	English Composition	3
IVYT 1XX	Life Skills Elective	1
* # MATH 1XX	Mathematics Elective	3

* PSYC 101	Introduction to Psychology	3
or		
* SOCI 111	Introduction to Sociology	3

Professional/Technical (49-50 credits)

BIOL 2XX	General Microbiology	3-4
# HLHS 101	Medical Terminology	3
HLHS 105	Medical Law and Ethics	3
SURG 111	Fundamentals of Surgical Technology	4
SURG 112	Application of Surgical Fundamentals	2
SURG 113	Surgical Procedures I	3
SURG 114	Clinical Applications I	3
SURG 211	Surgical Procedures II	6
SURG 212	Clinical Applications II	9
^ SURG 213	Surgical Procedures III	3
SURG 214	Clinical Applications III	7
XXXX XXX	Pharmacology	3

Courses must be successfully completed before admittance to the program



IVY TECH
COMMUNITY
COLLEGE

Therapeutic Massage

Program Description

The Therapeutic Massage program addresses the theory and hands-on techniques of therapeutic massage. Massage skills include, assessment, relaxation massage, therapeutic massage, deep tissue, sports massage, hydrotherapies, applications for special populations including pregnant women, children, geriatrics and the disabled. Anatomy, physiology, disease conditions, pharmacology and their effects on the body alone and during massage applications are studied thoroughly, to promote understanding of massage indications and contraindications. Psychological and emotional issues, legal and ethical aspects, and business development are addressed. The program is designed to prepare you for beginning entry into the massage profession, with an emphasis on working within the wellness community.

Sample Careers

Massage therapist

Degrees Available

Associate of Applied Science, Technical Certificate

Concentrations Offered

None

Availability of concentrations and degrees varies by campus. Contact your local campus for more information.

Completion of the Technical Certificate provides the student in excess of 700 hours of training and preparation to sit for the NCBTMB (National Certification Board for Therapeutic Massage and Bodywork) National Certification Exam. Completion of the AAS degree provides the student in excess of 1000 hours of preparation to sit for the National Certification Exam.



Associate of Applied Science

To earn this degree, you must have 67 credits in the following areas:

General Education Core	19
Professional/Technical	48

General Education (19 Credits)

APHY 101	Anatomy and Physiology I	3
APHY 102	Anatomy and Physiology II	3
ENGL 111	English Composition	3
IVYT 1XX	Life Skills Elective	1
MATH 1XX	Mathematics Elective	3
XXXX XXX	Humanities/Social Science Elective	3
XXXX XXX	English/Communications Elective	3

Professional/Technical (48 credits)

HLHS 101	Medical Terminology	3
TMAS 101	Holistic Approach to Massage Therapy	3
TMAS 102	Legal Massage Applications	3
TMAS 120	Massage Technician Training I	3
TMAS 122	Massage Financial Management	3
TMAS 125	Acupressure Theory and Methods	3
TMAS 140	Massage Technician Training II	3
TMAS 141	Massage Through the Life Span	3
TMAS 201	Sports, Injuries and Hydrotherapies	3
TMAS 202	Deep Tissue	3
TMAS 203	Herbs, Drugs and Massage	3
TMAS 205	Pathology and Massage	3
TMAS 210	Biomechanics	3
^ TMAS 220	Advanced Techniques	3
TMAS 221	Business Development	3
TMAS XXX	Massage Elective	3

Technical Certificate

To earn this degree, you must have 49 credits in the following areas:

General Education Core	10
Professional/Technical	39

General Education (10 Credits)

APHY 101	Anatomy and Physiology I	3
APHY 102	Anatomy and Physiology II	3
IVYT 1XX	Life Skills Elective	1
XXXX XXX	English/Communications Elective	3

Professional/Technical (39 credits)

HLHS 101	Medical Terminology	3
TMAS 101	Holistic Approach to Massage Therapy	3
TMAS 102	Legal Massage Applications	3
TMAS 120	Massage Technician Training I	3
TMAS 122	Massage Financial Management	3
TMAS 125	Acupressure Theory and Methods	3
TMAS 140	Massage Technician Training II	3
TMAS 141	Massage Through the Life Span	3
TMAS 201	Sports, Injuries and Hydrotherapies	3
TMAS 203	Herbs, Drugs and Massage	3
TMAS 205	Pathology and Massage	3
TMAS 210	Biomechanics	3
TMAS XXX	Massage Elective	3



IVY TECH
COMMUNITY
COLLEGE

Transportation, Distribution and Logistics

Program Description

Transportation and logistics is a major industry in Indiana. Many companies now depend on their ability to accurately move goods around the world. Ivy Tech Community College's Transportation, Distribution and Logistics program prepares a workforce that meets this demand. Indiana's central location and access to national and world markets has attracted a large increase in the companies in the transportation, distribution and logistics arena.

The logistics and transportation field uses high technology and information systems to track goods and increase efficiencies. There are many opportunities for careers in transportation and logistics management using the latest technologies in supply management, distribution systems, and inter-modal transportation.

Sample Careers

Shipping/receiving clerk, cargo and freight agent, first line supervisor

Degrees Available

Associate of Science

Concentrations Offered

None

Availability of concentrations and degrees varies by campus. Contact your local campus for more information.



Associate of Science

To earn this degree, you must have 64 credits in the following areas:

General Education Core	31
Professional/Technical Core	33

General Education (31 Credits)

COMM 101	Fundamentals of Public Speaking	3
ECON XXX	Economics Elective	3
ENGL 111	English Composition	3
GEOL 207	World Geography	3
IVYT 1XX	Life Skills Elective	1
MATH 131	Algebra/Trigonometry I	3
MATH 132	Algebra/Trigonometry II	3
PHIL 102	Introduction to Ethics	3
PSYC 101	Introduction to Psychology	3
SOCI 111	Introduction to Sociology	3
XXXX XXX	Life/Physical Sciences Elective	3

Professional/Technical (33 credits)

ACCT 101	Financial Accounting	3
BUSN 101	Introduction to Business	3
BUSN 102	Business Law	3
BUSN 105	Principles of Management	3
BUSN 227	Logistics/Supply Chain Management	3
BUSN 228	Principles of Purchasing	3
BUSN 229	Transportation Systems	3
BUSN 230	Business Statistics	3
CINS 101	Introduction to Microcomputers	3
MKTG 101	Principles of Marketing	3
OPMT 224	Operations Management	3

Visual Communication

Program Description

Visual Communications students are provided with all the skills necessary to work in the design industry. You will develop advanced skills and knowledge in your particular field of interest. The program prepares you for the world of work by developing real-world internship and design exhibit opportunities. You will also develop a professional print and media portfolio that will be critiqued by local industry representatives. You will take part in mock interviews with these representatives and get important feedback on what it takes to get a job in the design field.

Sample Careers

Camera operator, graphic designer, production assistant, webmaster

Degrees Available

Associate of Science, Associate of Applied Science, Associate of Fine Arts

Concentrations Offered

Film and Video, Graphic Design, Multimedia Production
Photography, Web Design, Web Development

Availability of concentrations and degrees varies by campus. Contact your local campus for more information.



Associate of Science

Articulated transfer through an Associate of Science in Visual Communications is available with IUPUI and the University of Southern Indiana. To view this Associate of Science transfer degree program and to see if they are available at your local Ivy Tech campus, students should go to <http://www.ivytech.edu/>.

Students are encouraged to review these options with their advisors, to consult the current catalog of the institution to which they wish to transfer, and to contact the institution to which they wish to transfer. Additional opportunities for course and program transfer may also be available at your local campus. Students should contact the transfer office of their local Ivy Tech for further information.

Associate of Applied Science

To earn this degree, you must have 67 credits in the following areas:

General Education Core	19
Professional/Technical Core	24
Concentration Core	12
Regionally Determined Credits	12

General Education (19 Credits)

ARTH 101	Survey of Art and Culture I	3
ARTH 102	Survey of Art and Culture II	3
* COMM 101	Fundamentals of Public Speaking or	3
* COMM 102	Introduction to Interpersonal Communication	3
ENGL 111	English Composition	3
IVYT 1XX	Life Skills Elective	1
* MATH 1XX	Math Elective	3
* XXXX XXX	Life/Physical Science Elective	3

Professional/Technical (24 credits)

VISC 101	Fundamentals of Design	3
VISC 102	Fundamentals of Imaging	3
VISC 110	Web Design I	3
VISC 115	Introduction to Computer Graphics	3
VISC 201	Electronic Imaging	3
VISC 205	Business Practices for Visual Artists	3

^ VISC 207	Portfolio Preparation	3
VISC 213	Advanced Electronic Imaging	3

Choose One of the Following Concentrations

Film and Video Concentration (24 credits)

This concentration exposes you to a broad technical core of courses representing key topics such as organizing the visual fields, color theory and application, image acquisition and manipulation technology. You will learn to operate television, video or motion picture.

VIDT 110	Production Editing I	3
VIDT 111	Studio and Field Production I	3
VIDT 202	Studio and Field Production II	3
VISC 105	Video and Sound	3
Regionally Determined Credits		12

Graphic Design Concentration (24 credits)

This concentration involves creating 2D commercial designs for print. You will learn approaches for production, printing, planning, business issues, and web design and its relationship to print.

VISC 114	Graphic Design I	3
VISC 113	Typography	3
VISC 116	Electronic Illustration	3
VISC 217	Graphic Design II	3
Regionally Determined Credits		12

Photography Concentration (24 credits)

This concentration will expose you to a broad technical core of courses representing key topics such as: organizing the visual field, color theory and application, image acquisition and manipulation technology, the computer as a powerful tool, the professional visual artist as a business person and exit portfolio.

PHOT 104	Basic Photography	3
PHOT 106	Studio Practices	3
PHOT 107	Intermediate Photography	3
PHOT 201	Principles of Color Photography	3
Regionally Determined Credits		12

Web Design Concentration (24 credits)

This concentration provides you with approaches to developing interactive content for CD/DVDs and websites, addressing issues with production-quality digital video and sound editing. Enjoy cre-

ative problem-solving in your own interactive 3D environment.

VISC 113	Typography	3
VISC 114	Graphic Design I	3
VISC 116	Electronic Illustration	3
VISC 210	Web Design II	3
Regionally Determined Credits		12

Web Development Concentration (24 credits)

This concentration will provide you with experience in both creative and technical areas. The latest technologies that are currently in high demand include website design, web development and interactive media.

CINS 125	Database Design and Management	3
VISC 103	Interactive Media I	3
VISC 113	Typography	3
VISC 210	Web Design II	3
Regionally Determined Credits		12





COURSE DESCRIPTIONS



Comprehensive Course Description List (Alphabetical Order)

ACCT 090 Introduction to Accounting 3 Credits

Prerequisites : None. Introduces the basic principles of accounting as utilized in a variety of office settings. Includes the principles of debit and credit, double-entry bookkeeping, use of journals, and analyzing transactions. Uses of ledgers, posting procedures, petty cash, banking procedures, payroll, depreciation, work sheets, balance sheets, and income statements are covered as well.

ACCT 101 Financial Accounting TransferN 3 Credits

Prerequisites: Demonstrated competency through appropriate assessment or earning a grade of "C" or better in ENG 025, ENG 032 and MAT 044. Introduces the fundamental principles, techniques, and tools of financial accounting. The development and use of the basic financial statements pertaining to corporations both service and retail.

ACCT 102 Managerial Accounting 3 Credits

Prerequisites: ACCT 101. Emphasizes managerial accounting concepts, general versus cost accounting systems, cost behavior, cost-volume profit analysis, budgeting, standard cost systems, responsibility accounting, incremental analysis, and capital investment analysis.

ACCT 105 Income Tax 3 Credits

Prerequisites: Demonstrated competency through appropriate assessment or earning a grade of "C" or better in ENG 025, ENG 032 and MAT 044. Offers an overview of federal and state income tax law for individuals including taxable income, capital gains and losses, adjustments, standard and itemized deductions, tax credits and appropriate tax forms. Introduces tax concepts needed by a sole proprietorship.

ACCT 106 Payroll Accounting 3 Credits

Prerequisites: Demonstrated competency through appropriate assessment or earning a grade of "C" or better in ENG 025, ENG 032 and MAT 044. Covers payroll calculating and reporting including various federal and state withholding taxes, employer payroll taxes, typical insurance and other arrangements affecting the preparation of payroll registers and employees' earnings records.

ACCT 109 Personal Finance 3 Credits

Prerequisites: Demonstrated competency through appropriate assessment or earning a grade of "C" or better in ENG 025, ENG 032 and MAT 044. Examines the process of setting and achieving financial goals. Emphasizes managing financial resources, budgeting for current expenses, projecting cash flow and managing short- and long-term credit. Includes use of insurance to reduce risks and vehicles for saving and investing.

ACCT 112 Managerial Accounting Application 1 Credit

Prerequisites: Program Advisor Approval. Presents a series of planned accounting learning problems and activities designed to accompany concepts and theories included in a Managerial Accounting Application course.

ACCT 118 Financial Concepts for Accounting 3 Credits

Prerequisites: None. Surveys the applications of mathematics to various business and accounting activities. Includes a brief review of basic mathematical operations and their subsequent application to such commercial activities as payroll, consumer finance, business borrowing, inventory control, pricing, depreciation, and time value of money.

ACCT 122 Accounting Systems Applications 3 Credits

Prerequisites: ACCT 101. Solves accounting problems using software similar to what is currently used in business. Includes installation, operation, and analysis of an accounting software package or packages.

ACCT 201 Intermediate Accounting I 3 Credits

Prerequisites: ACCT 102. Studies accounting principles and applications at an intermediate level pertaining to the income statement and balance sheet, cash and cash equivalents, receivables, inventories, plant assets and intangible assets, current and contingent liabilities, corrections of errors, and statement of cash flows. Included are analysis of bad debts, inventory valuation, repairs and maintenance, depreciation of plant assets and present value applications.

ACCT 202 Intermediate Accounting II 3 Credits

Prerequisites: ACCT 201. Continues studies of Intermediate Accounting I and includes long-term investments, long-term debt, stockholders' equity, special accounting problems and analysis, and financial statement analysis. Also included are corporate capital and treasury stock transactions, dividends, earnings per share, accounting for income taxes, and creation of financial statements from incomplete records.

ACCT 203 Cost Accounting I 3 Credits

Prerequisites: ACCT 102. Examines the manufacturing process in relation to the accumulation of specific costs of manufactured products. Studies various cost accounting report forms, material, labor control, and allocation of manufacturing costs to jobs and departments.

ACCT 204 Cost Accounting II 3 Credits

Prerequisites: ACCT 203. Studies the master or comprehensive budget, flexible budgeting and capital budgeting. Emphasizes tools for decision-making and analysis. Introduces human resource accounting.

ACCT 206 Advanced Managerial Accounting 3 Credits

Prerequisites: ACCT 102. Provides an intermediate understanding of accounting records and management decision making, with topics including internal accounting records and quantitative business analysis.

ACCT 207 Accounting for Government 3 Credits and Nonprofit Entities 1

Prerequisites: ACCT 101. Emphasizes the similarities and differences between government, nonprofit and commercial accounting methods and procedures. Exposes students to the basic fund accounting cycle for the general fund and other special funds.

ACCT 208 Advanced Income Tax 3 Credits

Prerequisites: ACCT 101 and ACCT 105. Studies procedures and problems pertaining to federal and state income tax laws for partnerships and corporations. Includes a review and in-depth study of concepts related to proprietorships covered in Income Tax I.

ACCT 209 Auditing 3 Credits

Prerequisites: ACCT 201. Covers public accounting organization and operation including internal control, internal and external auditing, verification and testing of the balance sheet and operating accounts, and the auditor's report of opinion of the financial statements.

ACCT 212 Business Finance 3 Credits

Prerequisites: ACCT 101, BUS 101 and MAT 111. Introduces basic tools and techniques of financial analysis. Financial analysis includes but is not limited to the use of ratios, common size statements, and pro forma statements.

ACCT 213 Advanced Spreadsheets 3 Credits

Prerequisites: OAD 218 and ACCT 102. Continues the study of electronic spreadsheets in business. Emphasizes the advanced application of electronic spreadsheets.

ACCT 217 Intermediate Accounting Applications I 1 Credit

Prerequisites: ACCT 102. Presents a series of planned accounting learning problems and activities designed to accompany concepts and theories included in ACCT 201. Uses computerized problems.

ACCT 218 Intermediate Accounting Applications II 1 Credit

Prerequisites: ACCT 102. Presents a series of planned accounting learning problems and activities designed to accompany concepts and theories included in Intermediate Accounting II. Uses computerized problems.

ACCT 219 Cost Accounting Applications 1 Credit
Prerequisite: ACCT 102. Presents a series of planned accounting learning problems and activities designed to accompany concepts and theories included in Cost Accounting I. Uses computerized problems.

ACCT 225 Integrated Accounting Systems 3 Credits
Prerequisites: ENG 111 and MAT 111 or higher and ACCT 201 and OAD 218. Uses integrated accounting software package(s) to illustrate computerized accounting practices. The general ledger will be integrated with accounts receivable, accounts payable, and other accounting modules.

ACCT 271 Accounting Applications 3 Credits
Prerequisite: ACCT 201 or Program Chair Approval. Provides students with the opportunity to experience seminars, workshops, and other instructional activities on topics of interest that reinforce the concepts presented in their program area.

ACCT 272 Business Writing for Accounting 3 Credits
Prerequisite: BUSN 101, CINS 101, ENGL 111. Focuses on the effective use of Standard English in written, business correspondence. Also addresses the psychology of effective communication. Students will apply the ten characteristics of effective writing and practice the ten guidelines for writing effective sentences and paragraphs. Students will practice using a reference manual for guidance in writing Standard English.

ACCT 273 VITA Tax Seminar 1 Credit
Prerequisite: ACCT 105. This volunteer program prepares students to process both federal and state income tax returns for eligible citizens. Students will complete an IRS-developed training program for two levels of service – Basic and Intermediate. This level of training will permit the volunteers to prepare most individual tax returns. Student volunteers will be required to successfully pass the IRS Certification Tests for two levels of tax preparation service. Once certified, student volunteers will conduct interviews with VITA clients, prepare both the federal and state tax returns using IRS efile software, and undergo a Quality Review Process to ensure accurate and acceptable tax returns for electronic filing in addition to providing tax information and tax law to VITA clients.

ACCT 280 Co-op/Internship 1-6 Credits
Prerequisites: Program Chair Approval. Provides students with the opportunity to work at a job site that is specifically related to their career objectives. Provides on-the-job experience while earning credit toward an associate degree.

ACCT 298 Field Study 1-6 Credits
Prerequisites: Program Chair approval. Provides students with the opportunity to work at a job site that is specifically related to their

career objectives. Provides on-the-job experience while earning credit toward an associate degree.

ADMF 101 Key Principles of Advanced Manufacturing (MSSC) 3 Credits

Prerequisite: None. Introduces the basic principles and practices of Safety and Quality used in manufacturing environments. Safety instruction covers topics including: Material Safety Data Sheets (MSDS), confined space, lock out/tag out, zero energy state, hazardous materials, storage of flammable materials, storage of fuel gas and high pressure gas cylinders, portable powered tool safety, hand tool safety, record keeping, training, employer enforcement of safety regulations, and right to know. This course also covers current quality control concepts and techniques in industry with emphasis on modern manufacturing requirements. Topics of instruction include basic statistical and probability theory, sampling techniques, process control charts, nature of variation, histograms, attributes and variable charts. This course will use lecture, lab, online simulation and programming to prepare students for Production Certification Testing through Manufacturing Skill Standards Council (MSSC).

ADMF 102 Technology in Advanced Manufacturing (MSSC) 3 Credits

Prerequisite: None. Introduces manufacturing processes and basic mechanical, electrical, and fluid power principles and practices used in manufacturing environments. Topics include: types of production, production materials, machining and tooling, manufacturing planning, production control, and product distribution will be covered. Students will be expected to understand the product life cycle from conception through distribution. This course also focuses on technologies used in production processes. Basic power systems, energy transfer systems, machine operation and control will be explored. This course will use lecture, lab, online simulation and programming to prepare students for Production Certification Testing through Manufacturing Skill Standards Council (MSSC).

ADMF 103 Graphic Communications for Manufacturing 3 Credits

Prerequisite: None. Introduces basic blueprint reading skills commonly used in the manufacturing industry. Areas of study include: Interpretation of drawing dimensions and notes to ANSI standards for machining including; Geometric Dimensioning and Tolerancing (GD&T), welding, fabrication applications and inspection techniques. Students will be able to use Computer Aided Design software (CAD) to create 3D models and working drawings.

ADMF 106 Supervision and Teams at Work 3 Credits

Prerequisite: Demonstrated competency through appropriate assessment or earning a grade of "C" or better in ENGL 025 and/or ENGL 032. Introduces basic employee development with emphasis on the

responsibilities of a newly-appointed supervisor. Emphasizes organizational structure, motivation, delegation of authority, interviews, orientation and induction of new employees, employee performance evaluations and dealing with employee conflict.

ADMF 109 Green Manufacturing Operations 3 Credits

Prerequisite: Demonstrated competency through appropriate assessment or earning a grade of "C" or better in ENGL 025 and/or ENGL 032. Introduces the basic concepts of restructuring the manufacturing workplace and technological activity to incorporate environmental concerns. This course serves as an introduction to the basic principles of "green" manufacturing.

ADMF 112 Mechatronics I 3 Credits

Prerequisite: Demonstrated competency through appropriate assessment or earning a grade of "C" or better in MATH 044. Introduces the basic principles and practices of mechanical technology used in advanced manufacturing and mechatronic systems. This course will examine the appropriate procedures for the installation, troubleshooting, and repair of mechanical machine components. Issues including; material properties, surface finish, lubrication, and preventive maintenance of mechatronic systems will be discussed.

ADMF 113 Electrical & Electronic Principles for Manufacturing 3 Credits

Prerequisite: ADMF 102 Technology in Advanced Manufacturing and demonstrated competency through appropriate assessment or earning a grade of "C" or better in MATH 050 Basic Algebra. Introduces electrical and electronics topics common to Advanced Manufacturing Technology. Material will concentrate on practical techniques for proper and safe use of basic test equipment and hand tools. Techniques for connecting various types of circuits and power distribution will be introduced. Electrical wiring, circuit theory, soldering, testing, scheduling and calculations will be studied. An applied knowledge of Alternating Current (AC) and Direct Current (DC) voltage, resistance, and current will be presented through lecture and lab activities. Written communication skills will be used to document and report circuit descriptions, circuit problems, and repair procedures.

ADMF 115 Materials & Processes for Manufacturing 3 Credits

Prerequisite: Demonstrated competency through appropriate assessment or earning a grade of "C" or better in ENGL 024 Introduction to College Writing I and ENGL 031 Reading Strategies for College I. Introduces materials and processes common to Advanced Manufacturing Technology. This course will emphasize a practical understanding of materials used in production processes. Techniques for proper selection, evaluation, measurement and testing of materials will be covered. Students will be required to per-

form basic manual and machine production processes in a project oriented learning environment.

ADMF 116 Automation & Robotics in Manufacturing I 3 Credits

Prerequisite: ADMF 102 Technology in Advanced Manufacturing and MATH 111 Intermediate Algebra. Introduces the basic theory, operation, and programming of automated manufacturing systems. The course will focus on three main types of manufacturing automation including: Programmable Logic Controllers (PLC), Computer Numerically Controlled Machines (CNC), and Robotics. Students will be required to design, program and troubleshoot computer controlled machine logic and production processes in a project oriented learning environment.

ADMF 122 Mechatronics II 3 Credits

Prerequisite: Demonstrated competency through appropriate assessment or earning a grade of "C" or better in MATH 050. Introduces the common types electrical wiring circuits used for power and control of electrical devices and motors used in advanced manufacturing. Topics covered will include electrical safety, terminology, and interpretation of electrical symbols, motor theory, motor wiring, control wiring, and ladder diagrams.

ADMF 201 Lean Manufacturing 3 Credits

Prerequisite: None. Introduces the philosophical background, historical development, fundamental concepts, operating fundamentals, and the organizational rationale for the implementation of lean disciplines in manufacturing. The course also applies to the application of lean disciplines and concepts to service and support industries. The use and implementation of lean disciplines has generally resulted in the ability of an enterprise to develop a work environment that promotes continuous improvement, eliminates waste, reduces operating cost, improves quality, and achieves measurable improvement in customer satisfaction.

ADMF 202 Mechatronics III 3 Credits

Prerequisites: ADMF 122 Mechatronics II. Introduces the common types of Programmable Logic Controllers (PLCs) and electric motor drive systems used in advanced manufacturing. Topics covered will include PLC theory, PLC installation, control wiring, ladder diagrams, AC & DC motor drive application and installation.

ADMF 205 Sensors in Manufacturing 3 Credits

Prerequisite: ADMF 113. Introduces the basic principles and practices of sensor technology used in advanced manufacturing. This course will prepare students to utilize commonly used sensor technology from simple switches to complex modern sensors. Students will be required to match appropriate sensor technology with specific manufacturing processes.

ADMF 206 Automation & Robotics in Manufacturing II 3 Credits

Prerequisite: ADMF 116 Automation and Robotics in Manufacturing I. Continues to develop the theory, operation, and programming of automated manufacturing systems. This course will focus on three main types of manufacturing automation including: Programmable Logic Controllers (PLC), Computer Numerically Controlled Machines (CNC), and Robotics. Students will be required to integrate and troubleshoot computer controlled machines in a manner that represents actual advanced manufacturing production processes in a project oriented learning environment.

ADMF 211 Quality Systems in Manufacturing 3 Credits

Prerequisite: MATH 111 Intermediate Algebra. Covers current quality improvement concepts and techniques in industry with emphasis on modern manufacturing requirements. This course introduces the fundamental tools of Statistical Process Control (SPC) as they are used in industry to reduce costs, identify root cause, and increase productivity at a predictable quality level. Applied principles and techniques of total quality systems will be utilized to ensure correct definition, measurement, analysis, and improvement of common manufacturing problems. Areas of study include; basic statistical and probability theory, sampling techniques, process control charts, nature of variation, histograms, attributes and variable charts.

ADMF 216 Projects in Advanced Manufacturing 3 Credits

Prerequisite: ADMF 101 Key Principles of Advanced Manufacturing and ADMF 206 Automation and Robotics in Manufacturing II. Requires the student of advanced manufacturing to formally display their knowledge and implementation of a broad range of skills from the advanced manufacturing curriculum. Specifically, this course will require students, working in manufacturing teams, to develop a manufacturing line for the production of a product. Students will enhance manufacturing processes by implementing concepts of lean manufacturing and employing quality concepts to ensure high production rates.

ADMF 222 Mechatronics IV 3 Credits

Prerequisite: Demonstrated competency through appropriate assessment or earning a grade of "C" or better in MATH 050. Introduces the basic principles and practices of fluid power technology used in advanced manufacturing and Mechatronics systems. This course will examine fluid power components and fluid power circuit design.

ADMF 280 Manufacturing COOP/Internship 3 Credits

Prerequisite: Program Chair Approval. Gives students the opportunity to work in a manufacturing environment that is specifically related to their career objectives. Students gain on-the-job experience while earning credit toward an associate degree. Students already

working may apply to use that current job experience to meet course requirements. Students will be required to establish learning outcomes and prepare job reports in conjunction with the employer.

AGRI 100 Introduction to Agriculture 3 Credits

Prerequisite: None. Presents an overview of agriculture emphasizing the basic concepts of crop and animal growth and production. In addition, the course provides a survey of the diversity of agricultural industries.

AGRI 101 Agricultural Data Management 3 Credits

Prerequisite: None. Principles of collecting, managing, and retrieving financial, physical, and spatial data from farm operations to support the farm's decision-making and reporting. Emphasizes use of financial, statistical, and logical spreadsheet functions, GIS systems, record-keeping for fertilizer and pesticide usage and regulation, and specialized software applications, including integration of information from various sources and packages.

AGRI 110 Introductory Agricultural Business and Economics 3 Credits

Prerequisites: ENGL 025, ENGL 032, and MATH 050. Examines the role and characteristics of farm and off-farm agricultural business in our economy; introductory economic and business principles involved in successful organization, operation, and management.

AGRI 111 Introduction to Crop Production 3 Credits

Prerequisites: ENGL 025, ENGL 032 and MATH 050. Introduces and examines fundamental principles of crop production and distribution. Emphasis is placed on applying technological advances in agronomy to active crop-production situations, including basic soils, agricultural meteorology, and crop physiology and breeding.

AGRI 112 Fundamentals of Horticulture 3 Credits

Prerequisites: ENGL 025, ENGL 032 and MATH 050. Biology and technology involved in the production, storage, processing, and marketing of horticultural plants and products. Laboratories include experiments demonstrating both the theoretical and practical aspects of horticultural plant growth and development.

AGRI 113 Introduction to Animal Science 3 Credits

Prerequisites: ENGL 025, ENGL 032 and MATH 050. Examines the importance of livestock in the field of agriculture, and the place of meats and other animal products in the human diet.

AGRI 114 Introduction to Agricultural Systems 3 Credits

Prerequisites: ENGL 025, ENGL 032 and MATH 050. An introduction to the Agricultural Systems Management technical curriculum. Basic mathematical problem solving techniques; power generation, transfer, and utilization; basic principles of agricultural operations management; soil and water management; crop handling and conditioning; and heat transfer.

AGRI 117 Soil Science 3 Credits

Prerequisite: None. Classification and characterization of soils and differences between soils, including physical, chemical, and biological properties. Relation of soils to land use and tillage, erosion, drainage, moisture supply and aeration practices. Relationship of soil properties to plant nutrition and to fertilizer chemistry, use, and management.

AGRI 200 Precision Farming Technology 3 Credits

Prerequisite: AGRI 111 and AGRI 117. Technology and applications of electronics for precision agriculture. Characteristics of personal computer hardware, electronic sensors, monitors, machine controllers, environmental monitors, and global positioning systems. Production management information systems; processing and marketing information systems; and yield mapping, geographic information system data handling, and software options.

AGRI 202 Animal Production Facilities 3 Credits

Prerequisite: AGRI 113. Principles of choosing, operating, and maintaining machines and equipment used in farm animal production. Emphasizes basics of electrical and hydraulic machines and common operating techniques and practices. Includes use of computer software and hardware to manage feed, health maintenance, and waste management. Special focus on operator and animal safety and environmental quality maintenance.

AGRI 203 Livestock Selection and Evaluation 3 Credits

Prerequisite: AGRI 113. Principles of selection and evaluation of breeding and market livestock; emphasis on modern breeds and types of livestock. Performance programs available for producers to improve livestock to meet economic, market, and consumer needs. Students participate in field trips and may participate in intercollegiate livestock judging contests to gain skill in livestock selection/evaluation.

AGRI 204 Agriculture Salesmanship 3 Credits

Prerequisite: ENGL 025 AND ENGL 032. Role, dynamics, and principles of sales communications as related to food and agriculture; methods for analyzing, setting objectives, planning, conducting, and evaluating sales communications efforts; sales presentations

AGRI 205 Animal Nutrition and Livestock Disease 3 Credits

Prerequisite: AGRI 113. Basic principles of managing animal diets to maximize health and minimize or prevent disease in animals and humans. Includes nutrient classes and functions, digestive processes, symptoms of nutrient deficiency, characterization of feed products, diet formulation and management. Familiarizes students with disease processes and mechanisms and recognition and management of insects of animals.

AGRI 206 Animal Anatomy and Physiology 3 Credits

Prerequisite: AGRI 113. Principles of organ and tissue structure,

operation, function, regulation, and integration of domestic farm animals. Examines mechanisms and processes of growth and development, reproduction, and lactation, and effects of environmental conditions. Includes basic genetic principles and theory, and their applications to physiological development and reproduction.

AGRI 207 Marketing Agricultural Products 3 Credits

Prerequisite: AGRI 110. Includes principles of demand, supply and price determination in agricultural markets. Examines effects of costs and margins, market structure, marketing channels and systems, horizontal and vertical integration, government regulations, government programs, and cooperatives on farm marketing decisions. Also examines the difference between marketing commodities and differentiated products.

AGRI 208 Agriculture Financial Records 3 Credits

Prerequisite: AGRI 110. Application of principles of financial and cost accounting, finance, and management to recording the farm's input, cost, production, price, and revenue information. Use and organization of financial data to assist farm management and decision-making, such as financial analysis, budgeting, strategic decisions for evaluating and improving operations, credit needs, and tax liabilities.

AGRI 209 Agricultural Commodity Marketing 3 Credits

Prerequisite: AGRI 110. Fundamentals of the mechanics of commodity futures and options, for both grain and livestock. Examine how these markets connect to the cash market and influence risk management and pricing of commodities. Fundamentals of the cash market pricing alternatives available and development of marketing plans.

AGRI 210 Management Methods for Agricultural Business 3 Credits

Prerequisites: AGRI 110, AGRI 111 and AGRI 114. Examines the management of non-farm, agriculturally related businesses. Topics include tools for management decision making, legal forms of business organization, basics of accounting, and important financial management techniques. Incorporates case studies and computer simulation game.

AGRI 211 Swine Production 3 Credits

Prerequisite: AGRI 113. The principles, skills, and practices of handling swine and managing commercial swine production and production of pork products. Includes breeding, selection, feeding, and health of swine. Provides concepts of animal and animal-human interactions and animal behavior and practices to ensure animal and human well-being.

AGRI 212 Environmental Systems Management 3 Credits

Prerequisite: AGRI 114 and AGRI 117. Principles of using, storing, controlling and disposing of agricultural waste, chemicals, and other haz-

ardous materials, and using and maintaining application equipment, to maintain human and animal health and environmental quality. Includes basis for and knowledge of state and federal regulatory requirements. May include instruction for certification in hazardous materials management or private pesticide applicator licensing.

AGRI 213 Agriculture Equipment Power Systems 3 Credits

Prerequisite: AGRI 114. An introduction to power generation and transfer in mechanical and fluid power systems. Internal combustion engines, fuels, and cycles are introduced. Clutches, mechanical transmissions, automatic transmissions, hydrostatic transmissions, and final drives are discussed. Principles of hydraulics, fluids, cylinders, pumps, motors, valves, hoses, filters, reservoirs, and accumulators are studied.

AGRI 216 Disease and Insect Identification 3 Credits and Control

Prerequisite: AGRI 111. Identification and control of the economically important diseases and insects that impact agricultural production in the U.S. Emphasis is placed on disease pathogens and insects that affect grain and forage production in the Midwest. Current technologies in chemical control as well as integrated pest management will be explored with emphasis on environmental and personal safety.

AGRI 217 Soil Fertility 3 Credits

Prerequisite: AGRI 117. Use of fertilizers for peak production at optimum cost; evaluation and comparison of different forms of macro- and micro-nutrients, their manufacture, handling, and application; plant and soil chemistry.

AGRI 218 Weed Identification and Control 3 Credits

Prerequisite: AGRI 111. Identification and control of the economically important broadleaf and grass weeds that impact agricultural production in the U.S. Identification of seeds, seedlings and full-grown plants is addressed. Weed control programs are examined in the context of herbicide chemistry, timing and economics. Emphasis is placed on pesticide formulations, application methods, rate calibration, environmental concerns, safety, laws and regulations. Students will participate in training for and receive a Certified Pesticide Applicators Permit as part of the course requirements.

AGRI 219 Crop Machinery and Equipment 3 Credits

Prerequisite: AGRI 111 and AGRI 114. Principles of choosing, operating, and maintaining machines and equipment used in production of field crops. Emphasizes basics of electrical and hydraulic machines and common operating techniques and practices. Includes use of computer software and hardware and GIS to manage planting, tilling, and fertilizer and pesticide applications. Special focus on operator safety and environmental quality maintenance.

AGRI 280 Internship 1 – 5 Credits

Prerequisite: AGRI 100 and AGRI 111. Placement in agricultural business for 80 – 400 hours of work in career exploration, developing skill requirements, and occupational opportunities. Dual supervision by college staff and cooperating businesses.

AMSL 101 American Sign Language I 3 Credits

Prerequisite: None. American Sign Language I is an introduction to ASL as it is used within the Deaf culture. Instruction in the basic structure of the language and development of its use. Skill development practice. Introduction to the history of deaf culture and the language. Introduction to the deaf perspective on the establishment of deaf communities and ASL.

AMSL 102 American Sign Language II 3 Credits

Prerequisite: AMSL 101. American Sign Language II is designed to provide a continuation of the introductory course. Students will increase their knowledge of the deaf community, culture, and deaf education in a hearing world. The deaf perspective on traditional employment of deaf people in a hearing society will be explored. In language development, complex grammar functions, expanded vocabulary, and skill development are incorporated into the use of sign production. The course will provide an opportunity for students to improve and enhance their ability to communicate in American Sign Language.

ANTH 154 Cultural Anthropology 3 Credits

Prerequisites: Demonstrated competency through appropriate assessment or earning a grade of "C" or better in ENGL 025, ENGL 032, and MATH 044. The scientific study of human culture. Variations in patterns of human behavior are holistically examined in their relationship to such factors as biological evolution, socialization, kinship, economy, religion, education, personality, art, music, dance, and cultural change.

ANTH 254 Introduction to Archaeology 3 Credits

Prerequisites: Demonstrated competency through appropriate assessment or earning a grade of "C" or better in ENGL 025, ENGL 032, and MATH 044. The scientific study of the material artifacts of human culture remains. Provides insight into the earliest patterns of human behavior and its subsequent evolution into more complex forms. Acquaints the student with archaeological methods and with major findings of the archaeological record from selected culture areas.

APHY 067 Introduction to Anatomy and Physiology 3 Credits

Prerequisites: Demonstrated competency through appropriate assessment or earning a grade of "C" or better in ENGL 031 and MATH 044. Introduces basic concepts and terminology used in Anatomy and Physiology. Prepares entering students who took no high school life science or took it several years ago for APHY 101 and

APHY 102 or APHY 203 and 204). Provides a general introduction to chemistry, cells, tissues, body systems, and basic physiological processes.

APHY 101 Anatomy and Physiology I 3 Credits

Prerequisites: Demonstrated competency through appropriate assessment or earning a grade of "C" or better in ENGL 025, ENGL 032, and MATH 050. Develops a comprehensive understanding of the close inter-relationship between anatomy and physiology as seen in the human organism. Introduces students to the cell, which is the basic structural and functional unit of all organisms, and covers tissues, integument, skeleton, muscular and nervous systems as an integrated unit. Includes lab.

APHY 102 Anatomy and Physiology II 3 Credits

Prerequisites: APHY 101. Continues the study of the inter-relationships of the systems of the human body. Introduces students to the study of the endocrine, cardiovascular, lymphatic, respiratory, digestive, urinary and reproductive systems. Includes lab.

APHY 201 Advanced Human Physiology 4 Credits

Prerequisites: Successful completion of APHY 101 and APHY 102, or equivalent. Provides a study of human physiology for students entering health-oriented fields. Emphasizes the study of the function of cells, the nervous, muscular, circulatory, respiratory, urinary, digestive and endocrine systems, and their homeostatic mechanisms and system interaction. Focuses laboratory exercises on clinically relevant measurement of human function. Includes lab.

APHY 203 Human Anatomy and Physiology I 5 Credits

Prerequisites: Demonstrated competency through appropriate assessment or earning a grade of "C" or better in ENGL 025, ENGL 032 and MATH 044. Provides a comprehensive study of the interrelationship between anatomy and physiology from chemical to cellular to organ interactions. Provides an in-depth study of each system of the body from a viewpoint of structure as well as function. Includes lab.

APHY 204 Human Anatomy and Physiology II 5 Credits

Prerequisites: APHY 203 and demonstrated competency through appropriate assessment or earning a grade of "C" or better in MATH 050. Provides the remaining comprehensive study of the inter-relationship between anatomy and physiology from chemical to cellular to organ interactions. Provides an in-depth study of each system of the body from a viewpoint of structure as well as function: endocrine, cardiovascular, lymphatic, respiratory, digestive, urinary, and reproductive systems. Includes lab.

ARTH 101 Survey of Art and Culture I 3 Credits

Prerequisites: Demonstrated competency through appropriate assessment or earning a grade of "C" or better in ENGL 025 and ENGL 032. Surveys painting, sculpture, and architectural styles from

ancient cultures to the proto-Renaissance era. Emphasizes the historical context of art movements as well as analysis of the work of individual artists.

ARTH 102 Survey of Art and Culture II 3 Credits

Prerequisites: Demonstrated competency through appropriate assessment or earning a grade of "C" or better in ENGL 025 and ENGL 032. Surveys painting, sculpture, and architectural styles from the Renaissance to the present. Emphasizes the historical context of art movements as well as analysis of the work of individual artists.

ARTH 110 Art Appreciation 3 Credits

Prerequisites: Demonstrated competency through appropriate assessment or earning a grade of "C" or better in ENGL 025 and ENGL 032. An introductory course in art which explores the creative processes of humankind, its usage of specific traditional and contemporary media for communication and the study of periods and styles in art as they relate to the human condition. The course will explore the nature of art, the evaluation of art, and the processes and materials of art. The students will examine the formal elements of design and look at a wide variety of both two and three-dimensional artworks and will learn about the processes and tools involved in their creation.

ARTS 100 Life and Object Drawing I 3 Credits

Prerequisites: Demonstrated competency through appropriate assessment or earning a grade of "C" or better in ENGL 025 and ENGL 032. This introductory course will result in the advancement of basic drawing skills utilizing the human figure, natural and manufactured objects. Basic techniques and creative processes will be explored through expressive use and exploration of a variety of materials and techniques. Emphasis will be placed on developing a higher level of quality draftsmanship with a focus on proportion and structure.

ARTS 101 Life and Object Drawing II 3 Credits

Prerequisites: ARTS 100. Rendering abilities will continue to advance with drawing techniques utilizing the human figure, natural and manufactured objects, specifically from life (not photographs). More advanced techniques and creative processes will be explored through expressive use and exploration of a variety of materials and techniques. Emphasis will be placed on developing a higher level of quality draftsmanship with a focus on proportion and structure.

ARTS 102 Color and Design Theory 3 Credits

Prerequisites: Demonstrated competency through appropriate assessment or earning a grade of "C" or better in ENGL 025 and ENGL 032. A critical thinking course that delves into the thought processes and manual skills needed in design and its application in the realm of two-dimensional fine arts. Intermediate to advanced design and color theory will be addressed through the manipulation of imagery

in two-dimensional media. Critical thinking, problem-solving and manual techniques will be emphasized equally.

ARTS 103 Three-Dimensional Design 3 Credits

Prerequisites: Demonstrated competency through appropriate assessment or earning a grade of "C" or better in ENGL 025 and ENGL 032. An introductory course into the thought processes and manual skills needed in three-dimensional design. Basic techniques and creative processes will be explored through expressive use and exploration of a variety of materials and techniques. Critical thinking, problem-solving and manual techniques will be emphasized equally.

ARTS 104 Contemporary Art History 3 Credits

Prerequisites: Demonstrated competency through appropriate assessment or earning a grade of "C" or better in ENGL 025 and ENGL 032. This course chronologically surveys painting, sculpture, architectural styles and the minor arts for contemporary art. Emphasis is on the historical context of art movements as well as analysis of the work of individual artists. This course will provide the basic knowledge of art with grounding in technique and vocabulary along with dealing with current issues, multicultural dimensions of art and making a connection between art history and art making. Contemporary art has a vocabulary all of its own and this course provides the introductory tools to appreciate all art forms over the last three decades. Major movements will be introduced with characteristic works including performance, painting, sculpture, printmaking, environmental, photography and computer graphics.

ARTS 105 Foundation I 3 Credits

Prerequisites: Demonstrated competency through appropriate assessment or earning a grade of "C" or better in ENGL 025 and ENGL 032. This course introduces students to the fundamentals of art and design through a survey of art processes and techniques. Exposing students to broad subject matter and using four or five material specific exercises to emphasize additive and subtractive processes.

ARTS 106 Foundation II 3 Credits

Prerequisites: ARTS 105. Continues to expose students to broad subject matter by utilizing four or five material specific exercises to emphasize additive and subtractive processes at an advanced level. Students will also be exposed to the variety of artistic possibility through multiple art processes and techniques by working with the instructor and visiting artists.

ARTS 200 Intermediate Drawing I 3 Credits

Prerequisites: ARTS 101. This intermediate course will continue the advancement of drawing skills utilizing the human figure, natural and manufactured objects. There will be a thorough investigation of nature and the human figure through drawing. Techniques and creative processes will be explored through expressive use and exploration of a variety of materials and techniques. Emphasis will be

placed on quality draftsmanship with a focus on structure, line, gesture, and movement.

ARTS 201 Intermediate Drawing II 3 Credits

Prerequisites: ARTS 200. This intermediate course will continue the advancement of drawing skills utilizing the human figure, natural and manufactured objects. There will be a thorough investigation of nature and the human figure through drawing. Techniques and creative processes will be explored through expressive use and exploration of a variety of materials and techniques. Emphasis will be placed on quality draftsmanship with a focus on structure, line, gesture, and movement.

ARTS 204 Women in Art 3 Credits

Prerequisites: ARTH 101 or ARTH 102 or ARTS 104. This course will survey painting, sculpture, and architectural styles created by women from medieval cultures to the present. Contemporary approaches to women's art will also be explored and emphasized.

ARTS 211 Sculpture I 3 Credits

Prerequisites: ARTS 103. This is a basic course in the consideration of three-dimensional form in sculptural concept. Students will be exposed to various related materials, techniques, and processes. Emphasis will be on composition, positive and negative space and craft of material technique.

ARTS 212 Sculpture II 3 Credits

Prerequisites: ARTS 211. This is a continuation of Sculpture I resulting in intermediate use of three-dimensional design skills, applications and materials. Emphasis will be on intermediate techniques and advancing compositional skill.

ARTS 223 Printmaking I: Intaglio 3 Credits

Prerequisites: ARTS 100. Beginning course in printmaking, which introduces students to a variety of traditional techniques. Students are instructed in basic printing processes and in use of the presses. Emphasis will be on composition, craft, technical processes and translation of line to print.

ARTS 224 Printmaking II: Serigraphy 3 Credits

Prerequisites: ARTS 100. Beginning course in printmaking, which introduces students to the traditional techniques of serigraphy or silkscreen printmaking. Students are instructed in basic printing processes and in use of the screens. Emphasis will be on composition, craft, technical processes and translation of multiple types of content to print.

ARTS 225 Printmaking III: Relief and Monotype 3 Credits

Prerequisites: ARTS 100. Beginning course in printmaking, which introduces students to the traditional techniques of relief, collagraph and monotype. Students are instructed in basic printing processes

and in use of the presses. Emphasis will be on composition, craft, technical processes and translation of multiple types of content to print.

ARTS 226 The Art of the Book 3 Credits

Prerequisites: ARTS 100. Introduces the techniques, processes and aesthetic concerns of book arts as a studio art medium. Students will complete a number of original works using folding, cutting, and traditional fabrication as well as adhesive and non-adhesive books with sewn spines. Technique, concept and aesthetics will be discussed and used as a foundation for composition, execution and formal analysis in critiques.

ARTS 227 Papermaking 3 Credits

Prerequisites: ARTS 100. Introduces the techniques, processes and aesthetic concerns of papermaking as a studio art medium. Students will complete a number of original works using handmade pulp as well as paper sheets, forms, paintings and other techniques. Technique, concept and aesthetics will be discussed and used as a foundation for composition, execution and formal analysis in critiques.

ARTS 231 Painting I 3 Credits

Prerequisites: ARTS 101 and ARTS 102. An introductory course aimed at the development of painting skills, techniques, and aesthetic sensibilities. Explores and experiments with basic painting mediums, which may include: watercolors, acrylics, and oils in varying degrees. Builds visual thinking skills and methods for channeling creative energies that enable a lifetime of personal artistic expression.

ARTS 232 Painting II 3 Credits

Prerequisites: ARTS 231. An extension of the skills and concepts introduced in Painting I. Emphasis is on individual experimentation and the development of more advanced critical and technical skills in the discipline. Course continues to build visual thinking skills and methods for channeling creative energies that further enable a lifetime of personal artistic expression.

ARTS 241 Ceramics: Handbuilding I 3 Credits

Prerequisite: ARTS 103. This course is designed to introduce the techniques, processes and aesthetic concerns of ceramics as a studio art medium. Students will complete a number of original works using basic hand building techniques, as well as earthenware glazing and firing processes. Technique, concept and aesthetics will be discussed and used as a foundation for composition, execution and formal analysis in critiques.

ARTS 250 Senior Seminar 3 Credits

Prerequisites: Permission of Program Chair. Final course of program before graduation that prepares the student for transfer to another University environment and to begin exhibiting and working professionally. Course covers artist resume development, artist statement, artwork presentation: digital and in-hand, along with some of the

business aspects of being an artist. A polished presentation with portfolio is the final for this course.

ASTR 101 Solar System Astronomy Transferin 3 Credits

Prerequisites: Demonstrated competency through appropriate assessment or earning a grade of "C" or better in ENGL 025, ENGL 032, and MATH 044. Survey of the history of astronomy, astronomical cycles and phenomena, astronomical instruments, formation and evolution of the planets and their satellites, comparative planetology, asteroids, comets, meteors, the sun, origin of the solar system and its place in the galaxy and the universe.

AUBR 101 Body Repair 3 Credits

Prerequisites: None. Corequisite: AUBR 125. Examines the characteristics of body metals and includes the installation of moldings, ornaments, and fasteners with emphasis on sheet metal analysis and safety.

AUBR 103 Automotive Paint Fundamentals 3 Credits

Prerequisites: None. Introduces auto paint considerations with emphasis on the handling of materials and equipment in modern automotive technologies.

AUBR 104 Collision Damage Analysis and Repair 3 Credits

Prerequisites: None. Provides instruction in analyzing extensive body damage and determining the tools and procedures needed to replace panels.

AUBR 105 Conventional Frame Diagnosis and Correction 3 Credits

Prerequisites: AUBR 125 or Program Advisor Approval. Covers the use of tools, frame machines and equipment for frame and chassis repair. Includes study of terms pertaining to front suspension and rear axle. Describes uses of frame gauges and other measuring devices.

AUBR 110 Auto Body Power Tools 3 Credits

Prerequisites: None. Covers diagnosis of problems associated with the use of power tools in auto body work.

AUBR 111 Auto Body Hydraulic Tools 3 Credits

Prerequisites: None. Provides instruction in the selection, use and maintenance of hydraulic tools for auto body repair.

AUBR 114 Collision Damage Lab 1 Credit

Prerequisites: AUBR 104. Provides opportunities to develop skills and knowledge in the area of collision damage analysis and repair.

AUBR 115 Auto Body Circuits 3 Credits

Prerequisites: None. Includes fundamentals of electrical theory, automotive components and circuits, and troubleshooting techniques. Emphasizes battery construction, function and operation.

AUBR 117 Auto Paint Lab 1 Credit

Prerequisites: AUBR 103 and AUBR 107. Develops auto-painting skills with emphasis on materials and equipment handling.

AUBR 121 Unibody Repair Lab 1 Credit

Prerequisites: None. Develops skills and knowledge in the area of unibody structural analysis and repairs.

AUBR 122 Conventional Frame and Unibody Structural Analysis 3 Credits

Prerequisites: None. Includes the use of tools, frame machines and equipment for frame and chassis repair. Includes study of terms pertaining to front suspension and rear axle. Describes the uses of frame gauges, tram identification and other measuring and fixturing systems; straightening systems and techniques; mechanical component service and knowledge of suspension and steering systems on front wheel drive unibody vehicles.

AUBR 125 Automotive Body Welding 3 Credits

Prerequisite: None. Provides basic skills and fundamental knowledge in oxy-fuel welding, cutting, brazing and plasma cutting, gas metal arc welding, squeeze type resistance welding, exterior panel welding and J-CAR welding test preparation. This course is designed for auto service and body technicians. Emphasizes safe practices in ox-fuel and specific welding processes in the automotive body repair field.

AUBR 206 Automotive Body Welding 3 Credits

Prerequisites: AUBR 101. Introduces fundamentals of using hand and power tools in the repair of minor collision damage, with emphasis on safety.

AUBR 207 Automotive Painting Technology 3 Credits

Prerequisites: AUBR 103. Provides instruction on the total refinishing of an automobile with emphasis on advanced and specialty painting techniques.

AUBR 208 Unibody Structural Analysis and Repair 3 Credits

Prerequisites: None. Covers unibody repair, identification and analysis of damage, measuring and fixing systems, straightening systems and techniques, mechanical component service and knowledge of suspension and steering systems on front-wheel-drive unibody vehicles.

AUBR 209 Collision Damage Appraising 3 Credits

Prerequisites: None. Provides instruction in analyzing extensive body damage and determining the tools and procedures needed to replace panels.

AUBR 220 Fiberglass Plastic Repair 3 Credits

Prerequisites: None. Introduces types of fiberglass and plastic materials used in auto body repair. Covers both interior and exterior applications.

AUBR 227 Custom Paint Applications 3 Credits

Prerequisite: AUBR 103. Provides instruction and interaction on application of custom finishes to metal and composite materials.

AUTC 101 Steering and Suspension 3 Credits

Prerequisites: None. The objective of this course will be to study different steering and suspension systems used on vehicles. Students will study steering and suspension components, power steering units, principles of four-wheel alignment, tire repair and wheel balancing. The course will emphasize professional methods of diagnosis and repair for related components.

AUTC 102 Two and Four Wheel Alignment 3 Credits

Prerequisites: None. Covers the principles of two- and four-wheel alignment and wheel balance. Emphasizes practical work experience in the lab covering all the alignment angles.

AUTC 103 Principles of Alternative/Renewable Energies 3 Credits

Prerequisites: None. Covers basic principles and history of alternative energy sources. Industry and government status of geothermal, wind, solar, biomass, fuel cells and other energy sources will be highlighted. Alternative and traditional energies will be defined and compared in terms of today's use. The evolving energy career areas will be discussed.

AUTC 104 Liquid Propane Gas (LPG) 3 Credits

Prerequisites: AUTC 107. First in a series of two that focuses on the use of liquefied propane gas as an alternative fuel, and how it is used in material handling, automobiles and light duty trucks. Additionally, the theory of operation, installation, diagnosis and current safety regulations of the use of LPG will be covered in this class.

AUTC 106 Compressed Natural Gas I 3 Credits

Prerequisites: AUTC 107. Introduces students to the role, function and application of compressed natural gas (CNG) as an alternative fuel for today's internal combustion engine. Course prepares students to take the ASE F1 exam.

AUTC 107 Engine Principles and Vehicle Service 3 Credits

Prerequisites: None. This course introduces engine dynamics, theory of engine operation and characteristics of engine design. Studies will include component removal and replacement, visual inspection, precision measuring, gaskets, lubricants, sealants, and coolants. Under hood maintenance and service will also be covered.

AUTC 108 Biomass, Biogas, Micro-turbine 3 Credits Technology

Prerequisites: Demonstrated competency through appropriate assessment or earning a grade of "C" or better in ENG 025 and ENG

032. Focuses on the release of chemical energy by accelerating the naturally occurring carbon dioxide cycle and the use of this energy to power engines and generators. Natural fuels, fuels made from plant materials and garbage will be discussed. Engine efficiency and its impact on lower emissions will be discussed.

AUTC 109 Engine Performance I 3 Credits

Prerequisites: None. The first in a series of three courses that covers the operating systems of an internal combustion engine. The basic theory and operation of ignition, fuel, emission, and mechanical systems will be presented. Basic test procedures will be introduced. Computer engine system basics will be explained. Basic service and replacement procedures and techniques will also be covered.

AUTC 111 Alternative Fuels Installation and Application 3 Credits

Prerequisites: AUTC 103, AUTC 104, and AUTC 106. Focuses on shop safety, gaseous fuel handling, federal fuel standards and industry standards related to the conversion and installation processes of alternative fuel system components/systems to current vehicles.

AUTC 112 Liquid Propane Gas II (LPG) 3 Credits

Prerequisites: AUTC 104. Second course in the series covering liquid propane gas. LPG II continues with in-depth topics in maintenance, diagnosis and repair as well as conversions and installation using the liquid propane system.

AUTC 113 Electrical and Electronics I 3 Credits

Prerequisites: None. This first of three electrical classes introduces the fundamentals of electricity and automotive electronics. Digital multi-meters and circuit troubleshooting is covered. Emphasis is placed on understanding and utilizing electrical diagrams. Batteries, starting and charging systems are covered.

AUTC 114 Compressed Natural Gas II 3 Credits

Prerequisites: AUTC 106. Applies skills gained from AUTC 106 and expands them in theory and application. The course focuses on the advanced maintenance, diagnosis and repair, as well as conversion and installation of the compressed natural gas fuel system.

AUTC 121 Braking Systems 3 Credits

Prerequisites: None. This introductory course teaches theory, service and repair of automotive braking systems and their components. Emphasis is given to hydraulic theory, repair, and service of system components, including anti-lock and traction control systems.

AUTC 123 Electrical and Electronics II 3 Credits

Prerequisites: AUTC 113 and demonstrated competency through appropriate assessment or earning a grade of "C" or better in MAT 040. This second in a series of three courses will study electrical circuit theory and diagnostic procedures. The topics for this course include principles of operation and diagnostics for the various auto-

otive electrical and electronic systems. This course introduces body controllers and multiplexing.

AUTC 125 Manual Drivetrains 3 Credits

Prerequisites: None. This course covers theory, diagnosis, and overhaul procedures related to manual transmission/transaxes, clutches, transfer cases, and differential assemblies.

AUTC 127 Engine Repair 3 Credits

Prerequisites: None. A study of precision tools, equipment, and procedures needed to repair today's automotive engines

. Focus is placed on proper repair, assembly, and installation techniques applicable to the modern engine.

AUTC 135 Automatic Transmission 3 Credits

Prerequisites: None. A study of automatic transmission theory of operation, diagnosis, testing, and repair procedures. Theory and diagnosis of computer-controlled transmissions will also be covered.

AUTC 145 Powertrain Service 3 Credits

Prerequisites: None. A study of driveline theory and in-car service procedures. Theory and overhaul procedures related to the drive-shaft and axle assemblies for front and rear wheel drive vehicles are included. Removal and installation of transmissions and transaxes are covered. Transmission/driveline diagnosis and in car repair is also included.

AUTC 149 Introduction to Motor Sports 3 Credits

Prerequisites: None. Provides an overview of the various racing/motor sports venues in the U. S. Students will gain an understanding of various racing venues and their operations. Emphasis will be placed on professional level racing, although sportsman and semi-professional venues will also be discussed. Students will learn about the various careers available throughout the motor sports industry.

AUTC 150 Small Engine Maintenance 3 Credits

Prerequisites: None. Covers disassembly, inspection, measuring, cleaning, machine repair and proper assembly techniques applicable to small gas engine overhaul. Includes overhaul of carburetor and ignition systems as well as maintenance procedures on two-cycle and four-cycle engines.

AUTC 152 Diesel Engine Theory 3 Credits

Prerequisites: None. Operation of the diesel engine and the differences between a diesel and gas engine. Also includes instruction on shop equipment, fuels, oils, seals, bearings, lubrication and cooling system.

AUTC 201 Climate Control Systems 3 Credits

Prerequisites: AUTC 113. This course covers air conditioning and heating systems used on modern vehicles. Emphasis is given to the

operation and theory of the air conditioning and its components. Vacuum and electronic control circuits are included. Federal regulations for handling and recycling of all refrigerants will be stressed. Automatic climate control systems are also covered.

AUTC 209 Engine Performance II 3 Credits

Prerequisites: AUTC 109. This second in a series of three classes covers the diagnosis and repair of ignition, fuel, emission, and computer systems. Extensive coverage is given to manufacturer specific computer engine control and fuel injection systems. Topics will include OBD I, OBD II, and future on-board diagnostic systems.

AUTC 210 Hybrid Systems 3 Credits

Prerequisites: AUTC 106. Teaches students the fundamentals of troubleshooting, diagnosing and repairing gas-electric hybrid vehicles. The student will become a multi-skilled technician in preventive maintenance, refueling procedures, and problem solving on a wide range of skills to service a hybrid vehicle.

AUTC 219 Engine Performance III 3 Credits

Prerequisites: AUTC 209. This third in a series of three courses covers advanced concepts in the diagnosis and repair of ignition, fuel, emission, and computer systems. Coverage of manufacturer specific computer engine control and fuel injection systems will be stressed. Federal and state emission requirements will be covered with a focus on 5-g exhaust analysis. Hybrid and alternative fuel technology will also be covered.

AUTC 221 Vehicle Diagnosis and Service 4 Credits

Prerequisites: AUTC 101, AUTC 121, AUTC 123, AUTC 135, AUTC 201. This applied service course is designed to enhance a student's hands-on skills to diagnose and repair vehicle concerns across a variety of areas. Emphasis will be placed on Braking Systems, Steering and Suspension Systems, Climate Control Systems, and Automatic Transmissions.

AUTC 229 Driveability Diagnosis 3 Credits

Prerequisites: AUTC 219. This advanced course is designed to develop a student's ability to diagnose and repair complex driveability concerns. Emphasis will be placed on learning and following systematic diagnostic procedures. Students will utilize the advanced capabilities of diagnostic equipment provided.

AUTC 243 Advanced Electronics 3 Credits

Prerequisites: Program Advisor Approval. This course presents advanced theory and diagnosis of automotive electronic systems. Emphasis is placed on the testing and repair of these systems. This course uses lab scopes, scan tools, and graphing multi-meters. This is the capstone course for automotive technology.

AUTC 250 Motor Sports Fabrication I 3 Credits

Prerequisites: None. Introduces the fundamentals of motor sports

fabrication and the required tools and equipment. Students will learn to cut, weld and form metal for use in race car fabrication. Sheet metals brakes, bead rollers, tube benders, tubing notchers and a variety of welding process will be covered. Students will demonstrate knowledge through project/task completion.

AUTC 251 Motor Sports Fabrication II 3 Credits

Prerequisites: AUTC 250, WELD 207, and WELD 208. Builds on the fundamentals learned in AUTC 250 Motors Sports Fabrication I. Students will learn the basic machining process using mills, metal lathes and CNC processes. English wheels, planishing hammers, sheet metals brakes, bead rollers, tube benders, tubing notchers and a variety of welding process will be utilized. Students will demonstrate knowledge through project/task completion.

AUTC 253 Service Organization and Parts 3 Credits

Prerequisites: None. Facility and personnel requirements for efficiently run parts and service departments. Emphasis on principles, practices and procedures necessary to effectively operate the departments. Includes manufacturer catalogs and component numbering systems, methods of scheduling time and techniques for obtaining maximum work efficiency from technicians and specialists.

AUTC 254 High Performance Engines/ Systems I 3 Credits

Prerequisites: None. Covers the fundamentals, construction, components and design of high performance engines/systems for various racing venues. The course will also cover related systems; cooling, lubrication, suspension and braking. Students will study the theory, design and requirements of high performance engines/systems and then design their own modified engine which they will run and evaluate using the computer dynamometer simulation program. Emphasis in this course is placed on bolt on performance modifications/power adders.

AUTC 255 High Performance Engines/ Systems II 3 Credits

Prerequisites: AUTC 254. Covers the assembly/blueprinting of a competition engine. The course will focus on the basics of block and component preparation and clearancing, cylinder head porting, intake port matching and component balancing. Students will measure all critical clearances during assembly including but not limited to: deck heights, piston to valve clearances, chamber volumes, bearing clearances, piston to wall clearances, rod side clearances.

AUTC 257 Composite Fabrication I 3 Credits

Prerequisites: AUTC 250. Introduces the fundamentals of motor sports fabrication utilizing composite materials and the required tools and equipment. Students will learn to cut, lay up, form and cure materials for use in race car fabrication. Emphasis will be placed on Carbon Fiber and Fiberglass fibers with epoxy and poly-

ester resin materials. Students will demonstrate knowledge through project/task completion.

AUTC 258 Motor Sports Kit Car Building 3 Credits

Prerequisites: None. Covers the design and building of the cobra kit car. Emphasis will be placed on proper assembly/fabrication/improvement of the various subassemblies required to build this vehicle. Tire and wheel combinations, exhaust systems and other accessory options will also be discussed. Students will learn to cut, weld and form metal as needed for use in the kit car assembly. Students will demonstrate knowledge through project/task completion.

AUTC 261 Dynamometer Testing and Analysis 3 Credits

Prerequisites: Program Advisor Approval. Covers chassis dynamometer operation and analysis of the software generated data. Students should have a background in high performance vehicles. The effects of modifications to vehicles will be stressed.

AUTC 263 Blueprint and CAD Basics for Motor Sports 3 Credits

Prerequisites: None. Introduces basic blueprint reading skills commonly used in the racing parts fabrication and customization. Areas of study include: Interpretation of drawings dimensioned and noted to ANSI standards for machining, welding, and fabrication applications, inspection techniques, and CAD (Computer Assisted Design) fundamentals using AutoCAD® to create shop floor drawings. This course also introduces reverse engineering, automated inspection, and rapid prototyping techniques.

AUTC 264 Motorsports Machining 3 Credits

Prerequisite: None. This entry level course will cover machine shop safety, print reading and machining processes used in the fabrication and customization of racing parts. Machines used in this course are: manual with numerical control, vertical milling machines, engine lathes, pedestal grinders, and surface grinders.

AUTC 267 Motorsports Project 3 Credits

Prerequisite: AUTC 250, AUTC 251, AUTC 254. This capstone course is designed to provide students with an opportunity to apply their knowledge and skills to an actual Motorsports project in a production type environment. Projects will vary between work on actual race cars and work on supporting tools and equipment for the Motorsports Industry.

AUTC 271 Cooperative – Drivelines 3 Credits

Prerequisites: Program Advisor Approval. Provides qualifying students an opportunity to work at a job site and complete the requirements for driveline service. Provides on-the-job experience while earning credit toward an associate degree.

AUTC 272 Cooperative – Suspension 3 Credits

Prerequisites: Program Advisor Approval. Provides qualifying stu-

dents an opportunity to work at a job site and complete the requirements for chassis and suspension service. Provides on-the-job experience while earning credit toward an Associate's degree.

AUTC 273 Cooperative – Brakes 3 Credits

Prerequisites: Program Advisor Approval. Provides qualifying students an opportunity to work at a job site and complete the requirements for braking systems. Provides on-the-job experience while earning credit toward an associate degree.

AUTC 274 Cooperative – Electrical Systems 3 Credits

Prerequisites: Program Advisor Approval. Provides qualifying students an opportunity to work at a job site and complete the requirements for electrical systems service. Provides on-the-job experience while earning credit toward an associate degree.

AUTC 275 Cooperative – Engine Repair 3 Credits

Prerequisites: Program Advisor Approval. Provides qualifying students an opportunity to work at a job site and complete the requirements for engine repair. Provides on-the-job experience while earning credit toward an Associate degree.

AUTC 276 Cooperative – Engine Performance 3 Credits

Prerequisites: Program Advisor Approval. Provides qualifying students an opportunity to work at a job site and complete the requirements for engine performance. Provides on-the-job experience while earning credit toward an associate degree.

AUTC 279 Service Shop Operations 3 Credits

Prerequisites: Program Advisor Approval. Introduces students to the "Real World" atmosphere of the automotive workplace. Additionally, the course presents historical and future trends with emphasis in career/placement requirements. Safety, OSHA, EPA, and environmental standards are presented. Introduction to the eight areas of ASE Technician Certification and related tools are presented. Students will rotate the roles of Service Manager, Service Writer, Parts Manager, and Team Leader. Each student will also experience the following technician roles: general technician, alignment technician, brake technician, and diagnostic technician. Students will work on customer vehicles and gain a more clear understanding of what the expectations are for today's Automotive Service Technician.

AUTC 280 Co-Op or Internship 1 Credit

Prerequisites: Program Advisor Approval. Provides qualifying students an opportunity to work at a job site that is specifically related to their career objective. This class will provide on-the-job experience while earning credit toward an associate degree.

AUTC 299 ASE Certification Review 3 Credits

Prerequisites: None. Prepares the professional automotive technician to attempt the National Institute for Automotive Service Excellence certification tests. All eight areas of testing will be reviewed and

sample certification tests given. Lectures will stress theory of operation and diagnostic logic.

AVIT 141 Aviation Basics I 3 Credits

Prerequisites:None. Provides familiarization with aviation drawings and blueprint reading. The student learns the proper methods to weigh various aircraft and the requirements for weight-and-balance reporting. Fabrication of fluid lines for hydraulic, oxygen, and fuel systems is also covered.

AVIT 142 Aviation Basics II 3 Credits

Prerequisites:None. A math and physics review course with practical applications for aviation. The student reviews basic mathematical operations, determines areas of wing plan forms, and volumes of fuel tanks. Ratios and proportions are discussed as they apply to wings and aircraft engines. The operation of simple machines, aircraft nomenclature, and basic aerodynamics are also covered.

AVIT 144 Aircraft Electricity 5 Credits

Prerequisites:None. Introduces the student to the principles of basic electricity. The student learns Ohm's Law and the relationships of voltage, current, resistance, and power in DC electrical circuits. The relationships between RMS values of voltage and current, true and apparent power, reactance, and impedance using vector algebra in AC circuits are discussed. Electrical wiring in the aircraft, proper test equipment, basic troubleshooting, and battery servicing are also covered.

AVIT 145 Aircraft Ground Servicing 2 Credits

Prerequisites:None. Focuses on the proper methods and safety procedures involved in working with aircraft on the ground. The student learns identification of aircraft fuels and refueling procedures and how to properly clean, inspect, and treat corrosion. Standard hand signals used with marshalling aircraft, engine run-up and taxiing procedures and ramp safety are also included.

AVIT 146 Aviation Regulations 2 Credits

Prerequisites:None. Introduces the student to the Federal Aviation Regulations (FARs) pertaining to aviation maintenance (FAR Parts 23, 43, and 65), the Advisory Circulars (ACs) that expand upon these regulations, and proper record keeping for maintenance tasks performed on civil aircraft. Included are the format of technical publications and the various media (paper, microfiche, and CDROM) on which they are published.

AVIT 148 Aviation Materials and Processes 3 Credits

Prerequisites:None. Provides an overview of aviation manufacturing and inspection methods. The student is introduced to processes and special tools used in aviation quality assurance.

AVIT 222 Non Metallic Structures 6 Credits

Prerequisites:None. Introduces the student to inspecting and evaluating honeycomb and laminated structural damage as well as damaged transparent acrylic materials structures. The student becomes

familiar with the methods involved in removing and repairing damaged honeycomb and laminated structural materials and repairing acrylic materials.

AVIT 226 Airframe Electrical Systems 3 Credits

Prerequisites:None. Presents the theory of operation and proper methods of inspecting, servicing, troubleshooting, and repairing the various electrically powered aircraft systems. Included are power distribution systems for light and transport aircraft, power generation and regulation. Proper wiring techniques and connector repair. Speed and configuration warning systems areas are also covered.

AVIT 227 Aircraft Sheetmetal 8 Credits

Prerequisites:None. Introduces the basic techniques necessary to perform sheet metal repairs on aircraft structures. Students develop skills in these areas: using sheet metal tools, laying out parts, forming parts with bending machines, and repairing various structural airframe components.

AVIT 228 Aircraft Instruments and Avionics 3 Credits

Prerequisites:None. Covers the inspection, troubleshooting, and servicing of avionics and aircraft instruments installed in both general aviation and transport category aircraft. Included are basic theory of operation and the regulations pertaining to maintenance of instruments and avionics.

AVIT 231 Reciprocating Powerplants 7 Credits

Prerequisites:None. Covers overhaul, inspection, and removal of reciprocating engines. Students will perform a receiving inspection on an aircraft engine and perform a complete overhaul to operational condition. Students will also learn inspection and repair procedures specific to radial engines.

AVIT 232 Turbine Powerplants 5 Credits

Prerequisites:None. Covers the overhaul of a turbine engine; and the inspection, checking, servicing, repair, and removal/installation of turbine engines. Students will perform a receiving inspection on an aircraft engine and perform a complete overhaul.

AVIT 233 Powerplant Fuel and Induction Systems 3 Credits

Prerequisites:None. Studies fuel metering systems in reciprocating powerplants. Airflow through turbines, superchargers and carburetors are discussed. Students overhaul carburetors to supplement the theory discussions in this area. Engine cooling systems are also covered.

AVIT 235 Powerplant Fluid and Indicating Systems 3 Credits

Prerequisite:None. Covers lubricating systems in reciprocating and turbine engines. Indicating systems, reciprocating and turbine-engine electrical systems and engine instruments are also covered. Students inspect, check, troubleshoot, and repair engine fire detection systems.

AVIT 237 Propellers 4 Credits

Prerequisites:None. Covers the inspection, repair, and troubleshooting of propeller control systems. The removal, installation, and balancing of propellers are also covered.

AVIT 241 Aircraft Fuel System and Welding Practices 3 Credits

Prerequisite:None. Introduces the student to aircraft welding methods. These methods will include the welding of magnesium, titanium, stainless steel, and aluminum as well as fabrication of tubular structures. An additional major emphasis is aircraft fuel systems. This will include fuel dump systems, transfer systems, pressure fueling, and fluid quantity indicating. Transfer and troubleshooting of systems is also covered.

AVIT 242 Aircraft Inspection and Rigging 3 Credits

Prerequisite:None. Introduces the student to aircraft assembly, rigging and airframe inspection. This will include the rigging of fixed wing aircraft and rotary wing aircraft. Students will be instructed in the alignment of structures, assembly of aircraft components including flight control surfaces, balance and rigging of moveable control surfaces. In addition they will do airframe inspection and conformity inspection.

AVIT 243 Aircraft Hydraulic and Pneumatic Systems 3 Credits

Prerequisite:None. Present the theory and practical application of aircraft hydraulic and pneumatic systems as it relates to landing gear. Wing de-ice, and environmental systems is also covered.

AVIT 244 Aircraft Landing Gear Systems 3 Credits

Prerequisites:None. Introduces the student to safely putting an aircraft on jack stands for service. Also covers the inspection, service and repair of landing gear and retraction systems, shocks, struts, brakes, wheels, tires and steering systems. In addition student will learn to inspect, troubleshoot and service landing gear position and indicating warning systems.

AVIT 245 Aircraft System 3 Credits

Prerequisite:None. Introduces the student to various aircraft cabin atmosphere systems. Students will be introduced to instrument static pressure leak checks. They will also work on and be introduced to various warning systems, electric brake control, and anti-skid systems.

AVIT 251 Engine Cooling and Exhaust 3 Credits

Prerequisite:None. Introduces students to various methods of engine cooling on piston and turbine engines. This will also introduce superchargers, heat exchangers, mufflers, repairing cylinders on piston engines and the use of thruster reversers on turbine engines.

AVIT 252 Engine Install, Conformity, and Ignition**3 Credits**

Prerequisites: None. Students will remove and install piston and turbine engines. They will learn how to pre oil an engine after rebuild. They will troubleshoot, service, turbine engine exhaust nozzles. They will learn ignition harnesses, turbine engine ignitions and magneto overhaul.

AVIT 253 Engine Starting System**3 Credits**

Prerequisites: None. Introduces reciprocating and turbine engine electrical systems. Students will inspect, service, troubleshoot, and repair turbine pneumatic starting systems and turbine ignitions.

BANK 101 Principles of Banking**3 Credits**

Prerequisites: Demonstrated competency through appropriate assessment or earning a grade of "C" or better in ENGL 025, ENGL 032 and MATH 044. Discussion ranges from fundamentals of negotiable instruments to contemporary issues and developments within the industry.

BANK 102 Law and Banking: Applications and Principles**3 Credits**

Prerequisites: Demonstrated competency through appropriate assessment or earning a grade of "C" or better in ENGL 025, ENGL 032 and MATH 044. Introduces laws pertaining to secured transactions, letters of credit and the bank collection process. Provides a banker's guide to law and legal issues with special emphasis on the Uniform Commercial Code.

BANK 103 Consumer Lending**3 Credits**

Prerequisites: Demonstrated competency through appropriate assessment or earning a grade of "C" or better in ENGL 025, ENGL 032 and MATH 044. Presents an insider's view of consumer lending, offering essential information about the maze of regulations that govern credit practices, and reviews loan processing, cross selling and collections.

BANK 216 Analyzing Financial Statements**3 Credits**

Prerequisites: ACCT 101. Provides a practical introduction to financial analysis from the viewpoint of the commercial loan officer and develops skills needed to effectively assess a borrower's ability to repay loans.

BANK 219 Bank Management**3 Credits**

Prerequisites: BANK 101. Provides a complete introduction to the handling of day-to-day bank activities and incorporates case studies to help acquire bank management skills.

BANK 220 Trust Operations**3 Credits**

Prerequisites: ACCT 101 and BANK 101. Provides a broad, information framework intended to introduce students to quality trust operations workmanship in a time of accelerating change in the industry. The course presents the basics of trust operations providing an

overview of the Securities Industry and the reasons for its existence; the participants and terminology in the securities industry; Trust services, includes the types of trust accounts and the management and operations of trust services; Trust accounting principals, concepts, functions and controls; and the relationship between the Bank and the trust department.

BCOM 102 Construction Graphics and Print Reading**3 Credits**

Prerequisites: Demonstrated competency through appropriate assessment or earning a grade of "C" or better in ENGL 025, ENGL 032 and MATH 044. An introduction to drawing skills and techniques necessary to produce basic construction drawings. Emphasis is placed on the interpretation of the requirements of contract drawings, understanding terminology, symbols, and conventions used in residential, commercial, and industrial drawings, including architectural, structural, mechanical, electrical plans and sections.

BCOM 103 Green Construction**3 Credits**

Prerequisite: Demonstrated competency through appropriate assessment or earning a grade of "C" or better in ENGL 025 and ENGL 032. Students gain knowledge and understanding of sustainable and economically justifiable construction in the new "green" environment. The course focuses on various trends in the use of alternative materials and designs in both the residential and commercial/industrial markets. These are compared to traditional methods and will compare the impact to energy and environmental. As part of the energy impact both the initial and ongoing costs are reviewed. The various trade groups and their platforms are reviewed and discussed in relation to economically justifiable approaches. Finally the impact of new verses remodeled/renovated construction is evaluated.

BCOM 104 Commercial and Industrial Construction**3 Credits**

Prerequisites: BCOM 102. An introduction to steel, concrete, and composite material buildings found in heavy construction projects. Students will study steel frame, concrete structures, Bent Surface Structures, Space Frames, and other construction types used in heavier commercial and industrial buildings.

BCOM 105 Concrete and Soils**3 Credits**

Prerequisites: Demonstrated competency through appropriate assessment or earning a grade of "C" or better in ENGL 024, ENGL 031 and MATH 044. An introductory study of the properties and uses of concrete in construction. Emphasis is placed on quality control in the field. Other topics include: design and methods of form work, placing, curing, and finishing. 25% of the course content will cover the properties and behavior of soils including compaction, permeability, compressibility, and shear strength. Course content is consistent with principles and standards as determined by the Portland Cement Association (PCA), the American Concrete Institute (ACI), the

Construction Specifications Institute (CSI), and the American Society for Testing Materials (ASTM).

BCOM 115 Construction Management Practices**3 Credits**

Prerequisites: Demonstrated competency through appropriate assessment or earning a grade of "C" or better in ENGL 025 and ENGL 032. Students gain knowledge and understanding of the management functions in the construction industry including the project cycle, company and project organization, financial and budgeting considerations, documentation, monitoring, cost control, etc. Emphasis is placed on the responsibilities of managers and their relationship to other agents involved in a construction project.

BCOM 206 Construction Estimating**3 Credits**

Prerequisites: BCOM 102 and demonstrated competency through appropriate assessment or earning a grade of "C" or better in MATH 050. The first in a series of two estimating courses. Students will study fundamentals of performing construction estimates including making material quantity take-offs and labor estimates. The Construction Specifications Institute (material divisions) will be used to organize the estimating process. Emphasis is placed on interpreting plans and specifications to determine accurate material quantities and labor estimates, selection of appropriate material grades and types, and other miscellaneous cost associated with successful completion of a building project.

BCOM 208 Construction Business Management**3 Credits**

Prerequisite: Demonstrated competency through appropriate assessment or earning a grade of "C" or better in ENGL 025 and ENGL 032. Students gain knowledge and understanding of the business management functions in the construction industry and describes the functions of managers, including the management of activities, finances business development and personnel. The course focuses on application of guiding principles in construction management. It introduces the basic principles of accounting including debit and credit, balance sheets and income statements. In addition it addresses marketing in relation to market analysis, plans and acquisition of work.

BCOM 210 Codes and Specifications**3 Credits**

Prerequisites: Demonstrated competency through appropriate assessment or earning a grade of "C" or better in ENGL 025 and ENGL 032. A study of the interpretation of technical building specifications, codes, and contract documents as they affect the selection and application of materials and equipment. The course will emphasize understanding of local, state, and national codes, and explore contractual relationships and considerations.

BCOM 220 Project Planning and Control**3 Credits**

Prerequisites: Program Advisor Approval Covers the concepts and

techniques for scheduling and control systems for effectively managing a construction project. Students will obtain the skills and knowledge necessary to effectively plan and schedule a project, to monitor and control all project aspects, and to anticipate and resolve problems as they occur.

BCOM 223 Advanced Estimating 3 Credits

Prerequisites: BCOM 102 and BCOM 206. The second of two estimating courses with emphasis on using specialized software to perform estimating and cost control tasks. Estimating projects are focused on commercial and industrial construction.

BCOM 230 Construction Equipment 3 Credits

Prerequisites: Demonstrated competency through appropriate assessment or successful completion of MATH 111. Introduces principles and techniques for selecting and managing construction equipment. Identification and evaluation of types of site equipment including hand tools, power equipment, earthmoving/excavation equipment, etc. Emphasis is placed on estimating and analysis of equipment productivity, ownership and operating cost.

BCOM 235 Safety and Risk Management 3 Credits

Prerequisites: Demonstrated competency through appropriate assessment or earning a grade of "C" or better in ENGL 025 and ENGL 032. Emphasis is placed on identifying and reducing safety risk on the job site. Students will study OSHA standards, accident and fire prevention, protection from hazardous materials, use of protective equipment and clothing, construction equipment and other safety concerns. The role of managers, workers, sub-contractors and others is stressed. Students will gain an appreciation for how accidents and safety concerns affect morale and productivity.

BCOM 240 Professional Internship 3 Credits

Prerequisites: Program Advisor Approval. Major focus is to provide practical on-the-job experience working with a construction company. Student interns might work in the areas of print reading, estimating, equipment management, project supervision, or other management related activities and tasks.

BCOT 104 Floor and Wall Layout and Construction 3 Credits

Prerequisites: None. Examines the design and construction of floor and wall systems. Student develops the skill needed for layout and construction of floor and wall systems from blueprints and professional planning documents.

BCOT 105 Roof Construction 3 Credits

Prerequisites: None. Studies the design and construction of roof systems. Emphasizes use of the framing square for traditional rafter and truss roofing. Instruct students in additional up-to-date techniques.

BCOT 107 Electrical Blueprint Reading/NEC 3 Credits

Prerequisites: CONT 127. An introduction to the skills in basic electrical

print interpretation and understanding electrical symbols, presenting the student with the electrical design problems and related calculations in accordance with the most current NEC. Emphasis is placed on reading blueprints and specifications for a single-family dwelling, multi-family dwelling, commercial and industrial applications and hazardous locations. The student will be using a new computer assisted program to assist with estimating a project. Emphasis will be placed on understanding residential and commercial standards and the proper development of mechanical engineering drawings.

BCOT 110 Cabinetry 3 Credits

Prerequisites: None. Develops knowledge and skills in building of cabinets, including methods of construction, necessary hardware and installation; also use of portable power tools and stationary power tools.

BCOT 113 Interior Trim 3 Credits

Prerequisite: CONT 101. Develops basic knowledge, skills, and awareness of interior trim. Provides training in installation of drywall, moldings, interior doors, kitchen cabinets, and baseboard moldings.

BCOT 114 Exterior Trim 3 Credits

Prerequisites: CONT 101. Develops necessary skills in the finishing of the exterior of a building. The student obtains skills in the installation of the cornice, windows, doors and various types of sidings used in today's market place.

BCOT 115 Auxiliary Building Design and Construction 3 Credits

Prerequisites: CONT 101. Develops carpentry skills in construction of garages, storage buildings, wood decks, patios, privacy fences and gazebos.

BCOT 120 Woodworking Fundamentals 3 Credits

Prerequisites: None. An introductory study of the basic skills in woodworking. Emphasis is placed on safety, tool set-up and machine operations. Other topics include proper joinery and material selection.

BCOT 121 Furniture Design and Construction 3 Credits

Prerequisites: BCOT 120. Develops skills in the design, layout, and construction of furniture. Students are introduced to furniture styles, types of materials used, and methods of construction.

BCOT 122 Woodworking Jig Layout 3 Credits

Prerequisites: BCOT 120. Develops skills in the design, layout and construction of holding devices, called jigs, used for special setups on the table saw, joiner band saw, and other woodworking machines. Each jig can be a single function, or a multi-functioning jig.

BCOT 123 Furniture Framework 3 Credits

Prerequisites: None. Introduces the basic skills and technology of fur-

niture construction, focusing on case construction, face frames and furniture legs.

BCOT 124 Millwork 3 Credits

Prerequisites: BCOT 120. Introduces the basic skills and technology of the production of wood products and focuses on machinery set-up and operations for making moldings, doorframes and picture frames.

BCOT 125 Furniture Finishing and Repair 3 Credits

Prerequisites: None. Develops knowledge and skills in the technology of refinishing and repairing furniture. Introduces procedures used in stripping, bleaching, caning, veneering and wood fillers.

BCOT 126 Furniture Door and Drawer Assembly 3 Credits

Prerequisites: BCOT 120. An advanced class that develops skills in the design, layout, and construction of doors, drawers, and table tops. Students are introduced to various types of hardware and installation methods.

BCOT 127 Basic Theory of Paint and Stain 3 Credits

Prerequisites: None. Introduces the basic skills and techniques of finishing wood products, including proper preparation, staining and finishing procedures.

BCOT 128 Woodworking Hobbies and Crafts 3 Credits

Prerequisites: None. Introduces the basic skills and techniques in layout and construction of small projects such as bookcases, file cabinets, and mantels. Introduces the skills in layout and assembly of small hobby projects such as kitchen accessories, and living room, bedroom decorations.

BCOT 130 Home Inspection 3 Credits

Prerequisite: None. This course is designed to review the way buildings are designed and constructed, which areas of buildings should be inspected, and how to inspect them. Students will learn to prepare an inspection report; reports designed to meet the specifications of lending institutions and other organizations requiring home inspection services.

BCOT 131 Residential Building Codes 3 Credits

Prerequisite: None. Introduces the students to building code requirements in Indiana. Students will become familiar with the current code book and how to use it. Emphasis will be placed on examining those provisions that apply to general contractors.

BCOT 201 Residential Wiring 3 Credits

Prerequisites: CONT 127. Covers the practice of residential wiring, including electrical service, metering equipment, lighting, switches, outlets and other common components, and methods of installation and maintenance of the residential wiring system in accordance with the current National Electrical Code.

BCOT 202 Plumbing Fundamentals **3 Credits**
Prerequisites:None.Studies the operation and function of the home plumbing system.Introduces pipe drawings and pipe layout and Isometric blueprint reading symbols.Demonstrates how to rough in plumbing and install drainage,water systems, fixtures and water heaters in compliance with the plumbing code.

BCOT 203 Masonry Concrete Fundamentals **3 Credits**
Prerequisites:None.Covers materials and methods of construction with concrete block, brick, and forming for poured concrete.Includes study in the preparation of the building site.

BCOT 205 Advanced Projects in Building Construction I **3 Credits**
Prerequisites:CONT 101 and CONT 106.Applies problem solving to common problems in construction.Emphasizes the cooperation between several trades in the construction industry.

BCOT 206 Advanced Projects in Building Construction II **3 Credits**
Prerequisites:BCOT 205. Applies problem-solving skills to common challenges in construction.Emphasizes the cooperation between several trades in the construction industry allowing students to practice necessary skills to resolve the problem. Concentrates on decision-making skills.

BCOT 207 Carpentry-Light Commercial **3 Credits**
Prerequisites:None.Introduces carpentry skills required in light commercial construction.Focuses on construction methods and materials used for office buildings, clinics, small churches and other non-residential structures.

BCOT 208 Electrical Estimating **3 Credits**
Perquisite: CONT 127.This course presents the student with the electrical estimating process for residential and light commercial construction. Emphasis is placed on reading blueprints and specifications, estimating labor, materials, and associated costs. The student will be using a new computer assisted program to assist with estimating a project.

BCOT 211 Construction Organization and Procedures **3 Credits**
Prerequisites:None.Introduces organization and management procedures focusing on subcontracting, equipment and tool inventories, job materials, codes, inspections and permits.

BCOT 213 Motors and Motor Controls **3 Credits**
Prerequisites:CONT 127.Studies the wiring and design of motor control circuits, including circuit and conductor calculations, motor circuits and controls.Includes control transformers and service, circuit layout for motor controls and machine tool hookup and control.

BCOT 214 Wall and Floor Coverings **3 Credits**
Prerequisites:None.Covers modern materials and techniques of interior floor and wall coverings.Provides instruction on assessing the durability and maintenance of materials and techniques in correct installation procedures.

BCOT 216 Advanced Residential Design **3 Credits**
Prerequisites:Program Advisor Approval. Studies residential floor plans and elevation.Analyzes contemporary living patterns, cost, privacy, convenience and efficiency, coordinated with needs. Compares exterior styles for cost and aesthetic values.Studies multiple housing, duplex arrangements, apartments and condominiums. Provides students with opportunities to do floor plans, elevations, and perspective drawings to incorporate the conclusions reached from the above research.

BCOT 219 Survey and Measurement **3 Credits**
Prerequisites:CONT 106 and demonstrated competency through appropriate assessment or earning a grade of "C" or better in MATH 050. Presents fundamentals of surveying, including use of transit, reading angles, land description, restrictions and legal problems. Covers topographical maps and their use.

BCOT 220 Electrical Troubleshooting Techniques **3 Credits**
Prerequisites:CONT 127.Presents methods and techniques for troubleshooting appliances,motors,motor controls, relay wiring, commercial wiring and industrial wiring systems.

BCOT 222 Commercial/Industrial Wiring **3 Credits**
Prerequisites:CONT 127.Covers wiring methods and material selection for commercial and industrial wiring systems.Studies include mechanical installation of hardware as well as electrical design and layout.Focuses on tool use,material selection, and installation of machines in the industrial setting.

BCOT 223 Plumbing Design and Installation **3 Credits**
Prerequisites:BCOT 202.Provides techniques for working with pipes and fittings.Studies residential and commercial electrical hot water heating systems, private well water systems and electrical components of plumbing systems.

BCOT 225 Fabrication **3 Credits**
Prerequisites:Program Advisor Approval.Studies concepts and techniques of industrialized housing.Covers pre-fabrication, fabrication, jigs and rigging, including manufactured housing, sectional homes and modular homes.

BCOT 228 Advanced Woodworking **5 Credits**
Prerequisites:BCOT 120.Applies problem-solving solutions in furni-

ture construction,as well as cabinetry construction and installation.

BIOL 065 Basic Life Sciences **3 Credits**
Prerequisites:None.Corequisite:Demonstrated competency through appropriate assessment or earning a grade of "C" or better in ENGL 031 and MATH 044.Introduces the scientific method and the basic concepts and terminology used in biology, microbiology, anatomy, physiology and organic chemistry which is related to life sciences. Prepares entering students who took no high school science or who took science several years ago for general education life sciences courses.Includes lab.

BIOL 100 Human Biology **Transfer IN 3 Credits**
Prerequisites:Demonstrated competency through appropriate assessment or earning a grade of "C" or better in ENGL 025, ENGL 032 and MATH 044. This course is a study of the biology of the human organism.It includes an examination of organizational complexity, development, health, and the place of humans in the natural world. Includes lab.

BIOL 101 Introductory Biology **Transfer IN 3 Credits**
Prerequisites:Demonstrated competency through appropriate assessment or earning a grade of "C" or better in ENGL 025 ENGL 032 and MATH 050.Introduces the basic concepts of life.Includes discussion of cellular and organismal biology, genetics, evolution, ecology and interaction among all living organisms.Addresses applications of biology to society. Includes lab.

BIOL 105 Biology I **Transfer IN 5 Credits**
Prerequisites:Demonstrated competency through appropriate assessment or earning a grade of "C" or better" in ENGL 025, ENGL 032 and MATH 050.An in-depth overview of the principles of molecular and Mendelian genetics, concepts of Natural Selection in relation to evolution, and principles of population ecology and their effects on organismal diversity. Includes lab.

BIOL 107 Biology II **Transfer IN 5 Credits**
Prerequisites: Demonstrated competency through appropriate assessment or earning a grade of "C" or better" in ENGL 025, ENGL 032 and MATH 050.An in-depth overview of the principles of basic biochemistry, concepts of cell structure, cell metabolism, and cellular respiration, processes of DNA replication and gene expression, fundamentals of plant structure and function, principles of animal reproduction and development, and an overview of vertebrate anatomy. Includes lab.

BIOL 110 Entomology **3 Credits**
Prerequisites:Demonstrated competency through appropriate assessment or earning a grade of "C" or better in ENGL 025, ENGL 032, and MATH 050.This course will cover basic entomological concepts, including structure and function, behavior, evolution and ecol-

ogy, Review of insect order and look at how insects interact with human societies. Includes lab.

BIOL 121 General Biology I **4 Credits**

Prerequisites: Demonstrated competency appropriate assessment or earning a grade of "C" or better in ENGL 025, ENGL 032 and MATH 050. Also, demonstrated competency in chemistry through appropriate assessment or successful completion of CHEM 061. An introduction to those biological and chemical principles associated with cell structure and function, cell division, molecular and Mendelian genetics, enzyme function and energetics. An overview of natural selection, the structure, lifecycle and classification schemes of vascular plants will also be presented. Includes lab.

BIOL 122 General Biology II **4 credits**

Prerequisites: Demonstrated competency through appropriate assessment or earning a grade of "C" or better in ENGL 025, ENGL 032, and MATH 050. An introduction to those principles associated with evolution, form and function of plants and animals and ecology. The course will trace the evolution of organisms and explore plant structures, development and interaction with their environment. Students will look at anatomy, physiology, development and behavior of animals and will learn aspects of conservation biology. Includes lab.

BIOL 201 General Microbiology **4 Credits**

Prerequisites: BIOL 101, BIOL 105 or APHY 101 and earning a grade of "C" or better in MAT 050. Presents an in-depth overview of microbiology, including fundamental structures of microorganisms, their metabolism, classification and interaction with other living things, and the laboratory techniques for their study. Introduces industrial and clinical applications of microbiology and clinically related areas of bacterial, viral, fungal, and parasitic involvement. Includes lab.

BIOL 202 General Microbiology II **2 Credits**

Prerequisites: BIOL 201 or BIOL 211. A secondary study of microorganisms, including the characterization of bacterial growth and techniques of controlling microbial growth. Provides in-depth coverage of analytical and serological techniques commonly encountered in the microbiology laboratory. Includes lab.

BIOL 211 Microbiology I **Transfer IN 3 Credits**

Prerequisites: BIOL 101 or APHY 101 and earning a grade of "C" or better in MATH 050. An overview of microbiology including fundamental structures of microorganisms, their metabolism, classification and interaction with other living things, and the laboratory techniques for their study. Introduces industrial and clinical applications of microbiology. Includes lab.

BIOL 212 Microbiology II **2 Credits**

Prerequisites: BIOL 211 and APHY 101. Presents a secondary study of bacteria, viruses, fungi, rickettsia, and parasites. Emphasizes the study of bacterial growth and control demonstrated by serological techniques. Includes lab.

BIOL 220 Environmental Science **3 Credits**

Prerequisites: Demonstrated competency through appropriate assessment or earning a grade of "C" or better in ENGL 025, ENGL 032 and MATH 044. Survey of the basic concepts of ecology, natural resources and ecosystems, relationships between humans and their natural environment, and the magnitude and scope of global environmental problems. Includes lab.

BIOL 221 Molecular Biology **3 Credits**

Prerequisites: BIOL 121 or BIOL 107. Corequisites: CHEM 101 or CHEM 105. An introduction to DNA, RNA and proteins and a review of their structures and functions, including their physical and chemical properties and their roles in cellular metabolism. The course will include an in-depth look at the synthesis of these molecules, as well as DNA replication, transcription and translation. Includes lab.

BIOT 100 Survey of Biotechnology **3 Credits**

Prerequisites: Demonstrated competency through appropriate assessment or earning a grade of "C" or better in ENGL 025, ENGL 032 and MATH 044. Presents an in-depth overview of biotechnology emphasizing basic molecular techniques of manipulating DNA; processes involved in protein purification and analysis; microbial, plant, aquatic, medical and animal biotechnology; regulations and ethics of the biotechnology industry.

BIOT 101 Introduction to Biotechnology **4 Credits**

Prerequisites: BIOL 121. Presents a basic overview of biotechnology emphasizing current DNA and RNA technologies and structure and function of biomolecules. The application of these techniques in the field of medicine, agriculture, forensics and environment is emphasized. Scientific methods, lab safety and regulations and ethics of the biotechnology industry will also be covered. Includes lab.

BIOT 103 Safety and Regulatory Compliance for Biotechnology **3 Credits**

Prerequisites: BIOL 105 or BIOL 121 or CHEM 101 or CHEM 105 or CHEM 111. Overview of laboratory safety procedures and precautions, biosafety, radiation safety, compliance standards of regulatory agencies. Emphasis will be placed on understanding the regulatory environment of pharmaceutical, diagnostic and agricultural research and manufacturing. Students will be introduced to the agencies in the U.S. responsible for regulatory oversight of biotechnology. Concepts of current good laboratory practices (cGMP), current good manufacturing practices (cGMP), standard operating procedures (SOP) and validation will be addressed as they apply to industry.

BIOT 104 cGMP and Quality Compliance **3 credits**

Prerequisites: BIOL 121 or Program Chair Approval. Overview of current good manufacturing practices in the global pharmaceutical industry. Emphasis will be placed on the understanding of the similarities and differences between the good manufacturing practice requirements in the United States, Europe, Canada and Japan.

Students will also explore the different quality systems and processes needed in the pharmaceutical industry.

BIOT 105 Survey of Regulatory Affairs **3 Credits**

Prerequisite: Program Chair's Approval. This course provides an entry level introduction to the laws and regulations that govern the development, marketing and commercial distribution of drugs, biological and medical device products and how they relate to the pharmaceutical, biotechnology and medical device industry. This course is intended to provide individuals with a greater understanding of regulatory affairs, specifically providing an understanding of how their actions are controlled by regulations and how to interact with FDA or global regulatory agencies.

BIOT 117 Quality Control Techniques **3 Credits**

Prerequisite: BIOT 101. Students will be introduced to those principles associated with quality control from a life sciences perspective. Students will learn about common microbial contaminants and how to prevent them. Students will also gain experience with common monitoring techniques used in the biotech industry.

BIOT 171 Survey of Biotechnology Manufacturing **3 Credits**

Prerequisite: Program Chair Approval. Students will be introduced to the basics of biotechnology and the biology required to understand biotechnology. Students will then learn about the local biotech industry and some of the general practices shared by all biotech industries. Students will spend the second half of the course focusing on the specifics of either biomanufacturing or medical device manufacturing, earning a certificate in the area of their focus.

BIOT 172 Survey of Regulatory Affairs **3 Credits**

Prerequisites: Program Chair's Approval. This course provides an entry level introduction to the laws and regulations that govern the development, marketing and commercial distribution of drugs, biological and medical device products and how they relate to the pharmaceutical, biotechnology and medical device industry. This course is intended to provide individuals with a greater understanding of regulatory affairs, specifically providing an understanding of how their actions are controlled by regulations and how to interact with FDA or global regulatory agencies.

BIOT 201 Cell Culture and Cellular Processes **4 Credits**

Prerequisites: BIOT 101 and CHEM 105 or CHEM 111. An introduction to major biochemical pathways, cellular structure and function at a molecular level. Topics to be considered include the structure and function of the cell membrane, cytoskeleton and various organelles. Cellular respiration will be discussed. Protein synthesis, processing and export will be examined. Those processes involved in cell division will also be investigated and related to cancer. The laboratory will center upon techniques involving animal, plant, fungi and bac-

terial cell cultures. Students will be taught how to isolate, culture and preserve prokaryotic organisms. Students will be taught how to maintain and preserve eukaryotic cell cultures. Students will learn to procure cell cultures from ATCC and other repositories. Includes lab.

BIOT 211 Analytic Methods in Biotechnology I 3 Credits

Prerequisites: BIOT 101 and CHEM 105 or CHEM 111. Theory and application of many analytical methods currently utilized in the field of biotechnology. These methods will include: ELISA and immunoaffinity techniques; methods for determining enzymatic activity; spectrophotometric methods; chromatographic methods; electrophoresis; light and electron microscopy. When feasible, techniques will be practiced in the laboratory setting. Methods utilizing radioactive isotopes will be discussed. Considerable emphasis will be placed on proper methods for data recording, analysis and presentation. Includes lab.

BIOT 212 Analytic Methods in Biotechnology II 3 Credits

Prerequisites: BIOT 211. Theory and application of many analytical methods currently utilized in the field of biotechnology. These methods will include: centrifugation, light and electron microscopy, restriction endonuclease digestion, agar and acrylamide electrophoresis of nucleic acids, Southern and Northern blotting, polymerase chain reaction and bioassays. When feasible, techniques will be practiced in the laboratory setting. Methods utilizing radioactive isotopes will be discussed. Considerable emphasis will be placed on proper methods for data recording, analysis and presentation. Includes lab.

BIOT 214 Food and Drug Law 3 Credits

Prerequisite: BIOT 101. This course provides a basic introduction to the laws and regulations that govern the development, marketing and commercial distribution of drugs, biological and medical device products and how they relate to the pharmaceutical, biotechnology and medical devices industry. This course is designed to provide students with an overall landscape of U.S. and International laws regulating the drug, biotechnology and medical device industry.

BIOT 215 Clinical Trials 3 Credits

Prerequisite: BIOT 101. This course provides a basic introduction to clinical trials, including their design, how they are conducted, and concepts of current good clinical practices (cGCPs). This course is designed to provide students with an overall landscape of the clinical trial process, FDA regulations and ICH guidelines pertaining to that process.

BIOT 216 Risk Management for Drugs and Medical Devices 3 Credits

Prerequisite: BIOT 10. This course provides a basic introduction to risk management strategy application of best practices and risk management for both the drug and medical device industry. This course is designed to provide students with an overall understanding of

this growing discipline to improve patient safety and the regulatory mandates and laws.

BIOT 217 Biotechnology Manufacturing Processes 3 Credits

Prerequisites: Program Advisor Approval. Introduction to the processes and procedures involved in the manufacture of biological molecules on both large- and small-scales. The student will learn the function of commonly used manufacturing equipment associated with biotechnology and understand the cGMP's associated with the use of such equipment. The regulatory environment associated with most biotechnology endeavors will be reviewed including those mandated by FDA, USDA and OSHA.

BIOT 218 Product Life Cycle 3 Credits

Prerequisite: BIOT 101. This course provides a basic introduction to the basic life cycle of both drug and medical device life cycles, from discovery through preclinical, clinical trials, and post production concerns.

BIOT 220 Molecular Biology Lectures 3 Credits

Prerequisites: BIOL 121 and CHEM 106. Introduces DNA, RNA and proteins and review their structures and functions, including their physical and chemical properties and their roles in cellular metabolism. The course will include an in-depth look at the synthesis of these molecules, as well as DNA replication, transcription and translation.

BIOT 221 Microbiology 3 Credits

Prerequisites: BIOL 121 and CHEM 106. Corequisites: BIOT 222. Presents an overview of microbiology including fundamental structures of microorganisms, their growth, metabolism, interaction with other living things, and classification. Emphasis placed on industrial applications of microbiology.

BIOT 222 Microbiology Laboratory 2 Credits

Prerequisites: BIOL 121 and CHEM 106. Corequisites: BIOT 221. A conventional laboratory of exercises, demonstrations and discussions. Laboratory exercises are designed to enable students to achieve proficiency in the principles and techniques necessary for cultivation of microorganisms using aseptic techniques and for performing and interpreting biochemical tests. The laboratory exercises will be filled out weekly and turned in to be graded.

BIOT 227 Genetic Engineering and DNA Analysis 4 Credits

Prerequisites: BIOT 201 or BIOT 211. The essential concepts and techniques in genetic engineering. Students will practice essential gene cloning procedures: isolation of DNA, restriction endonuclease digestion, agarose gel electrophoresis analysis, DNA ligation, and transformation into a host strain. Other essential techniques such as PCR, construction and screening of genomic or cDNA libraries, Southern and Northern blot analyses will be practiced. Students will understand the principles and ethical issues of animal or human

cloning practices. Current methods for transfer and propagation of genes into plants and animals will be discussed. Various gene knock-out techniques such as homologous gene recombination, site-directed mutagenesis, and RNAi will be introduced. The topics in genomics, proteomics, and bioinformatics will be discussed. Includes lab.

BIOT 231 Industrial Processes and Fermentation 4 Credits

Prerequisites: Program Advisor Approval. An introduction to fermentation processes used for commercial purposes and the operation of small- and large-scale fermentors. Methods used to harvest product from fermentors and the regulatory requirements associated with commercial fermentation will also be explored. Includes lab.

BIOT 233 Protein Analysis and Purification 4 Credits

Prerequisites: BIOT 201 or BIOT 211. Students will review the biochemical properties of amino acids and proteins, then study techniques of cell disintegration and extraction, protein separation, and analysis. Students will be taught to determine which method is most applicable in various situations and why that method should be utilized. When possible, students will be given an opportunity to perform these techniques in the laboratory. Includes lab.

BIOT 235 Biotechnology Laboratory 3 Credits

Prerequisites: BIOL 107 and CHEM 105. Corequisites: BIOL 221. Presents an in-depth overview of basic biotechnology laboratory skills emphasizing chromatography techniques, methods of DNA and protein electrophoresis, processes of immunoassays, data management skills, recombinant DNA technology, and the polymerase chain reaction.

BIOT 241 Immunology and Immunological Processes 4 Credits

Prerequisites: BIOT 211. A brief survey of the components of the immune system and how they interact. The topics covered will include B and T cell development, activation and culture, the role of cytokines, their production and purification, signal transduction processes in B-cell activation, the role of MHC complexes, immunoglobulin synthesis and origins of diversity, antigen/antibody interactions, practical aspects of raising and purifying polyclonal and monoclonal antibodies, handling and labeling of antibodies, applications of antibodies including Western blotting, ELISA, and immunohistochemistry. Includes lab.

BIOT 280 Co-op/Internship 2-6 Credits

Prerequisites: Program Advisor Approval. Provides students with the opportunity to work at a job site that is specifically related to their career objectives. Provides on-the-job experience while earning credit toward an associate degree.

BUSN 101 Introduction to Business Transfer 3 Credits

Prerequisites: Demonstrated competency through appropriate

assessment or earning a grade of "C" or better in ENGL 025, ENGL 032 and MATH 044. Examines the American business system in relation to the economic society. Studies business ownership, organization principles and problems, management, control facilities, administration, and development practices of American business enterprises.

BUSN 102 Business Law 3 Credits

Prerequisites: Demonstrated competency through appropriate assessment or earning a grade of "C" or better in ENGL 025 and ENGL 032. Describes the judicial system and the nature and sources of law affecting business. Studies contracts, sales contracts with emphasis on Uniform Commercial Code Applications, remedies for breach of contract and tort liabilities. Examines legal aspects of property ownership, structures of business ownership, and agency relationships.

BUSN 104 Investment 3 Credits

Prerequisites: Demonstrated competency through appropriate assessment or earning a grade of "C" or better in ENGL 025 and ENGL 032. An introduction to the fundamentals of investing. Presents the basis of investing, with attention to the various ways in which investment vehicles operate.

BUSN 105 Principles of Management 3 Credits

Prerequisites: Demonstrated competency through appropriate assessment or earning a grade of "C" or better in ENGL 025, ENGL 032 and MATH 044. Describes the functions of managers, including the management of activities and personnel. Focuses on application of guidance principles in management.

BUSN 106 Customer Service 3 Credits

Prerequisites: Demonstrated competency through appropriate assessment or earning a grade of "C" or better in ENGL 025, ENGL 032, and MATH 044. Focuses on the importance of providing superior customer service to the organization as well as the customer service representative. Fundamental customer service techniques applicable to a variety of situations are presented.

BUSN 108 Personal Finance 3 Credits

Prerequisites: Demonstrated competency through appropriate assessment or earning a grade of "C" or better in ENGL 025, ENGL 032, and MATH 044. Emphasizes management of individual financial resources for growth and maintenance of personal wealth. Covers home buying and mortgage financing, installment financing, life and health insurance, securities, commodities and other investment opportunities.

BUSN 110 Introduction to Logistics 3 Credits

Prerequisite: None. A study of the basic concepts included in the field of logistics and supply chain management. Topics covered include: supply chain management, customer service, transportation, purchasing and inventory and warehouse management.

BUSN 120 Business Ethics and Social Responsibility 3 Credits

Prerequisites: BUSN 101. An examination of individual, organizational and societal ethical issues and the social responsibility of business organizations in the resolution of these issues. Critical thinking and informed decision making are emphasized.

BUSN 202 Human Resource Management 3 Credits

Prerequisites: BUSN 105. Focuses on the activities of human resource management, with emphasis on employer-employee relations, job analysis and evaluation, salary administration, work measurement and standards, performance appraisal and legal compliance.

BUSN 203 Business Development 3 Credits

Prerequisites: BUSN 105, MKTG 101 and ACCT 101. Explores business operations for the self-employed or as a manager of a small business enterprise. The course includes: covering the role of entrepreneur and manager; selecting the appropriate business organization; developing plans and strategies for small, medium, and growing firms; securing financing for start-up and growing operations; exploring growth opportunities; and successfully managing human and material resources.

BUSN 204 Case Problems in Business 3 Credits

Prerequisites: Program Chair Approval. Applies business concepts and principles to specific case studies or problems.

BUSN 205 Risk Management 3 Credits

Prerequisites: BUSN 101, BUSN 102 and MATH 050. Examines the risks faced by businesses and individuals; it then considers ways of handling them. Topics covered include property, liability and personal losses that may result due to assuming these risks. Much attention is paid to the use of insurance contracts in reducing the impact of the possible losses. Specific areas include automobile, home, life, health, and pension insurance as well as public policy, government regulations, and social insurance programs.

BUSN 206 Crisis Management 3 Credits

Prerequisite: None. Explores how to manage business crises, how best to avoid them, and what managers can learn from the experience.

BUSN 207 Introduction to International Business 3 Credits

Prerequisites: BUSN 101. Provides an overview of the international environment in which business operates today. Demonstrates the global relationships between business activities and how events in one part of the world can influence business decisions and activities in other parts of the world.

BUSN 208 Organizational Behavior 3 Credits

Prerequisites: BUSN 105. Studies human behavior in organizations at the individual and group level, including the effects of organization-

al structure on behavior. Focuses on using organizational behavior concepts for developing and improving interpersonal behavior.

BUSN 209 Introduction to e-Business 3 Credits

Prerequisites: BUSN 101 and CINS 101. Focuses on how e-business is being conducted and managed, its major opportunities, limitations, issues and risks. E-business applications to be discussed include those of business to consumer, business to business, and intra-business. Because e-business is interdisciplinary, subject matter will be directed at managers, professionals, and students who wish an overview of the e-business potential.

BUSN 210 Managerial Finance 3 Credits

Prerequisites: ACCT 101 and BUSN 101, and MATH 111 or higher. An introductory course in the principles of financial management. Develops decision-making skills related to the financial resources of a firm. Includes techniques of financial analysis, time value of money, capital budgeting, risk and return.

BUSN 212 Principles of Leadership 3 Credits

Prerequisites: BUSN 105. Introduction and overview of fundamental concepts of effective leadership in formal organizations.

BUSN 213 Management in Non-Profit Organization 3 Credits

Prerequisites: BUSN 105. This course is designed to introduce the student to the purpose and function of non-profit organizations. Students will apply planning, organization, leadership and control techniques as they apply to the non-profit sector.

BUSN 220 Conference Leadership Training 3 Credits

Prerequisites: None. Stresses the importance of the conference in business and industry. Emphasizes the practical application of the various techniques of conference leadership and an understanding of group dynamics in the conference setting.

BUSN 221 Principles of Employment 3 Credits

Prerequisites: BUSN 202. An in-depth look at the employment process. Emphasis will be placed on the role of recruiting, selecting and training of employees. Techniques in job analysis, behavioral interviewing and on-the-job training will be studied in much detail.

BUSN 222 Benefits Administration 3 Credits

Prerequisites: BUSN 202. Provides an in-depth look at benefit administration. Topics include vacations, holiday pay, insurance, retirement programs and other employee inducements. Emphasis will be placed on cost of benefits in relationship to the overall compensation package. The course will also look at the relevance of reward and recognition and pay structures.

BUSN 223 Occupational Safety and Health 3 Credits

Prerequisites: BUSN 105. A look at the importance of safety and health in the workplace. The Occupational Safety and Health Act of

1970 will be examined in depth with relationship to businesses and their employees. Emphasis will be placed on effective practices, costs, labor and management responsibilities, health hazards, alcohol and drug abuse, worker's compensation, physical conditions and training.

BUSN 227 Logistics/Supply Chain Management 3 Credits

Prerequisites: BUSN 101. A study of the strategic supply chain concepts included in the field of logistics and supply chain management. Topics covered include: supply chain strategy, planning and design, customer service, transportation, purchasing, forecasting, inventory and warehouse management, global supply chain management, managing supply chain risk, and financial control of logistics performance.

BUSN 228 Principles of Purchasing 3 Credits

Prerequisites: BUSN 101. Designed to teach the basics of purchasing management. Topics covered include: the challenge of purchasing and materials management, objectives and organization, function, specification, quality control and inspection, supplier evaluation, selection, and measurement, supplier development, strategic cost management, contracts and negotiation, purchasing relationships, purchasing transportation, purchasing laws and ethics, and global sourcing.

BUSN 229 Transportation Systems 3 Credits

Prerequisites: BUSN 101. Examines the structure and importance of the commercial transportation industry in the logistics sector of business. Topics covered include an in-depth examination of the various modes of transportation including discussions of regulations, economics, characteristics, and development in major transportation modes. Also discussed are costing and pricing issues in transportation and relationship management between buyers and sellers of transportation.

BUSN 230 Business Statistics 3 Credits

Prerequisites: BUSN 101 and MATH 111 or higher. Designed to build student competence in the areas of descriptive and inferential statistics, through emphasis on the application of these statistical methods. Includes an examination of data, probability of occurrence, and basic sampling processes. Uses statistical methods to model results and uses these models for forecasting. Tests to examine the appropriateness of these techniques are introduced.

BUSN 231 Business Statistics II 3 Credits

Prerequisites: BUSN 230. **Corequisites:** MATH 201. Focuses on Chi-Square applications, linear regression, multiple regression, and an analysis of variance. Students will be expected to apply a statistical package to topical applications.

BUSN 235 SHRM Certification Preparation 3 Credits

Prerequisites: Program Advisor Approval. Prepares students to sit for the Professional in Human Resources (PHR) certification exam sponsored by the Society for Human Resource Management.

BUSN 271 Lessons in Leadership 3 Credits

Prerequisite: BUSN 105. Leadership styles and strategies of historical leaders and/or modern day leaders are analyzed and applied to 21st century business scenarios. Modern management theories are discussed in relationship to actual events in historical events to legitimize the theories in a practical application.

BUSN 280 Co-op/Internship 1-6 Credits

Prerequisites: Program Advisor Approval. Gives students the opportunity to work at a job site that is specifically related to their career objectives. Provides on-the-job experience while earning credit toward an associate degree.

CATX 101 Physical Principles, Clinical Applications and Quality Control I 3 Credits

Prerequisite: Must hold a current registered radiological technologist license. This class will introduce the student to the physical principles of Computed Tomography (CT) and how it relates to the clinical applications for both adults and children. This class introduces the foundation for the practice of CT scanning. This class will also cover radiation dose and quality control.

CATX 102 Cross Sectional Anatomy I 3 Credits

Prerequisite: Must hold a current registered radiological technologist license. This class introduces the student to cross sectional anatomy. It will cover the terminology related to sectional anatomy. This class will discuss different planes of the body and associate them with the quality of images that will be encountered in clinical practice. It will cover the difference between all post processing options. The class covers anatomy in the head, cranium, facial area and neck in cross sectional plane and all structures and functions pertaining to the related anatomy. Discusses common pathologies related to the anatomy presented.

CATX 201 Physical Principles, Clinical Applications and Quality Control II 3 Credits

Prerequisite: Must hold a current registered radiological technologist license. This class will conclude on previous class the physical principles of Computed Tomography (CT) in regards to volume scanning (spiral/helical CT) and the fundamentals of volume scanning. This class will discuss advances in spiral CT and 3D CT and impact on patients.

CATX 202 Cross Sectional Anatomy II 3 Credits

Prerequisite: Must hold a current registered radiological technologist license. This class builds on the prior class and discusses 3D images in more depth. It will cover the difference between all post processing options. The class covers anatomy in the thorax, abdomen, pelvis and extremities as well as CT angiography in cross sectional plane and all structures and functions pertaining to the related anatomy. Discusses common pathologies related to the anatomy presented.

CEPM 101 Introduction to Homeland Security 3 Credits

Prerequisites: None. The course provides students and practitioners with a comprehensive account of past and current homeland security practices, policies, and programs in relation to the government restructure. Topics include workplace security, weapons of mass destruction, domestic and international terrorism, and preparedness.

CEPM 102 Principles of Emergency Management and Planning 3 Credits

Prerequisites: None. The purpose of this course is two-fold: to introduce concepts and basic descriptive information about the political system within the context of disaster policy and to demonstrate how political factors play a role in all phases of emergency management—regardless of the type or nature of the disaster event. To achieve these goals the course provides practical information drawn from disaster policy studies and case studies. This information is (wherever possible) reviewed for findings that can be generalized, that is, for lessons that are applicable to future disasters and emergencies.

CEPM 103 Basic Skills in Emergency Program Management 3 Credits

Prerequisites: None. The purpose of this course is to teach those considering a career in emergency management about the nature and reasons for the public's awareness of hazards and preparedness for disasters. The variety of actions taken by individuals, private and voluntary organizations, and the government to both prepare the public for the impact of disasters and provide realistic strategies to mitigate their adverse consequences.

CEPM 104 Disaster and Terrorism Awareness 3 Credits

Prerequisites: None. This course is an introduction to political terrorism, ranging from low-level acts of threats and acts of violence that may represent significant risk to human life and property to largescale acts of violence using "weapons of mass destruction" that may have devastating, long-term effects. The course will address the following, the nature of terrorism and its many forms, policies and programs to reduce the risk that terrorism presents to society, and policies and programs to manage terrorist events, and how to manage the consequences of terrorist violence.

CEPM 105 Introduction to Mitigation 3 Credits

Prerequisites: None. The course is designed to provide an understanding of the principles and practice of hazard mitigation in the United States at the local, state, regional, and federal levels of governance, emphasizing the importance of avoiding or preventing future and recurring losses of life and damage to public and private property. A further objective is to familiarize students with the tools, techniques, resources, programs, intergovernmental relationships, and broader social context involved in planning for and implementing hazard mitigation.

**CEPM 106 Disaster Response and Recovery 3 Credits
Operations**

Prerequisites: None. This course addresses future approaches to reducing damage from natural hazards, aimed at breaking the vicious cycle of disaster/rebuilding/disaster through pre-disaster hazard mitigation programs and policies. These proactive approaches seek to stem the tide of losses from repetitive damage incurred by development within known hazard areas, such as floodplains, storm surge areas, and earthquake fault zones. We will also look at disaster policy that focus on preparing for an imminent disaster, through evacuation and temporary property protection; responding to a disaster that has occurred, through search and rescue and debris clearance; and recovering from a past disaster, through rebuilding damaged structures.

**CEPM 107 Exercise Program Design, 3 Credits
Planning and Evaluation**

Prerequisites: None. This course is designed to introduce you to the fundamentals of exercise design and to prepare you to design and conduct a small functional exercise. The concept of the Exercise Design Course is based on one important premise: emergency exercises are worth the effort. Experience and data show that exercises are a practical, efficient, and cost-effective way for a community to prepare for disasters. It includes: the value of conducting exercises, the components of a comprehensive exercise program, and the exercise development process—development tasks, organization of the design team, exercise documentation, and the steps in designing an exercise. The course will also cover the purpose, characteristics, and requirements of three main types of exercises, table top, functional, and full scale exercises and the evaluation of the exercise.

**CEPM 210 Understanding and Combating 3 Credits
Terrorism**

Prerequisites: None. This course is designed to introduce the hazards of terrorism, the history and nature of terrorism. The response to terrorism and the duties and functions of the emergency manager will be explored. The course will also look at current U.S. efforts of homeland security and its impacts on the field of emergency management. We will discuss the basic aspects of nuclear, chemical and biological terrorism.

**CEPM 212 Homeland Security Intelligence 3 Credits
Operations and Tactical Skills**

Prerequisites: None. This course is designed to explore the role of intelligence and law enforcement, collection methods, cycle, management operations, classification, production and analysis, assessment of targets and threat vulnerability, source development and adjudication as it relates to Homeland Security and Terrorism.

**CEPM 213 Weapons of Mass Destruction 3 Credits
and Hazardous Materials**

Prerequisites: None. Unique features of terrorist attacks include psychogenic casualties, significant risk to responding personnel, multiple jurisdictions and the criminal nature of the event. This course will prepare the emergency manager to better understand the threat created by terrorism and weapons of mass destruction. The successful emergency manager must recognize the threat of terrorism and WMD and be able to mitigate and prepare for such disasters to bring order to potential chaos. We will also look at various types of biohazards.

**CEPM 214 Understanding the Incident 3 Credits
Command System**

Prerequisites: None. This class will emphasize command and control of major emergencies operations at an advanced level, linking operations and safety. Areas of study include: Incident Management System, Pre-incident planning, Size up, command Systems, Sectoring Functions, Staging, Safety Officer, Command Post, Communications, News Media, Computer Aided Resources. We will utilize simulated incidents, requiring the applications of appropriate solutions to resolve the incident.

**CEPM 215 Contingency Planning and 3 Credits
Incident Command**

Prerequisites: None. This course is designed to teach the students how to develop an emergency response contingency plan for a facility or community. Preparedness includes analyzing the hazards, writing and implementing the contingency plans, training employees for an emergency, and evaluating the effectiveness of the contingency plan.

CEPM 216 Public Information Officer Course 3 Credits

Prerequisites: None. The Public Information Officers Course is aimed at the new or less experienced PIO including those individuals who have function as a secondary responsibility. Course topics include an overview of the job of the PIO, understanding the media, interview techniques, writing a news release and conducting public awareness campaigns. Additional application of public information skills to a major emergency or disaster situation will be discussed. This is accomplished with a series of lecture presentations and exercises over the course.

CEPM 257 Preparedness Practicum 3 Credits

Prerequisites: None. This course is designed to address recently identified current events, skills, knowledge and behaviors pertinent to the technology or occupation and relevant to the professional development of the student. The student will demonstrate an understanding of the vocabulary, terminology and appropriate planning/administrative controls specific to the field.

CHEM 061 Basic Chemistry 3 Credits

Prerequisites: Demonstrated competency through appropriate assessment or earning a grade "C" or better in ENGL 032 and MATH 050. Provides students with an introduction to chemistry basics. Provides instruction for students with little or no recent chemistry background, especially those desiring to continue in more advanced chemistry courses or other science courses. Includes lab.

CHEM 101 Introductory Chemistry I Transfer IN 3 Credits

Prerequisites: Demonstrated competency through appropriate assessment or earning a grade of "C" or better in ENGL 025, ENGL 032 and MATH 050. An introductory course that includes the science of chemistry and measurement, atomic theory and the periodic table, chemical bonding, equation writing and balancing, stoichiometry, and gases. Includes lab.

CHEM 102 Introductory Chemistry II 3 Credits

Prerequisites: CHEM 101. Includes liquids and solids, solutions and solution concentrations, acids and bases, equilibrium, nuclear chemistry, and organic and biochemistry. Includes lab.

CHEM 105 General Chemistry I Transfer IN 5 Credits

Prerequisites: MATH 111 and demonstrated competency through appropriate assessment or earning a grade of "C" or better in ENGL 025 and ENGL 032. Corequisite: MATH 132 or MATH 133 or MATH 136. The first in a series of two introductory courses designed to cover general chemistry including measurement, atoms, molecules and ions, stoichiometry, chemical reactions, solids, liquids, and gases thermochemistry, atomic structure, and molecular bonding. Includes lab.

CHEM 106 General Chemistry II Transfer IN 5 Credits

Prerequisites: CHEM 105 and MATH 132 or MATH 133 or MATH 136. The second in a series of two introductory courses designed to cover general chemistry including kinetics, equilibria, acid/base chemistry, thermodynamics, electrochemistry, nuclear chemistry, organic chemistry and descriptive inorganic chemistry. Includes lab.

CHEM 111 Chemistry I 4 Credits

Prerequisites: MATH 111 and demonstrated competency through appropriate assessment or earning a grade of "C" or better in ENGL 025 and ENGL 032. An introductory course that includes the science of chemistry and measurement, atomic theory and the periodic table, chemical bonding, stoichiometry, liquids and solids, gases and the ideal gas law, solutions, and acids and bases. Includes lab.

CHEM 112 Chemistry II 4 Credits

Prerequisites: CHEM 111 or CHEM 101. Further explores concepts of equilibrium. Includes chemistry of metals and nonmetals, environmental chemistry, nuclear chemistry, organic and biochemistry. Includes lab.

CHEM 113 Introductory Organic and Biochemistry Transfer IN 3 Credits

Prerequisites: CHEM 101 or CHEM 111. The basic principles of organic and biochemistry are discussed. This will include the basic concepts of nomenclature and reaction equations that are necessary for understanding biochemistry. The ability to name and draw chemical structures and to write reactions for organic equations will be evaluated. Elements of biochemistry will include the basic analysis of biochemical structures and the reactions involved in the metabolic processes. Includes lab.

CHEM 204 Lectures in Organic Chemistry 3 Credits

Prerequisites: CHEM 106.A one-semester survey course designed to introduce organic chemistry including nomenclature, spectroscopy, stereochemistry, reactions, and mechanisms.

CHEM 211 Organic Chemistry I 5 Credits

Prerequisites: CHEM 106. The first in a series of two courses designed to cover organic chemistry including the properties, syntheses, and reactivity of aliphatic and aromatic compounds. The course includes an introduction to organic chemistry lab techniques covering the synthesis, purification, and characterization of organic compounds. Includes lab.

CHEM 212 Organic Chemistry II 5 Credits

Prerequisites: CHEM 211. The second in a series of two courses designed to cover an understanding of organic chemistry including the properties, syntheses, and reactivity of aliphatic and aromatic compounds, polyfunctional natural products such as carbohydrates, and peptides. The course includes various organic chemistry lab techniques covering the synthesis, purification, and characterization of organic compounds. Includes lab.

CHMT 101 Industrial Laboratory Techniques 3 Credits

Prerequisites: None. Introductory course dealing with basic skills needed in the industrial laboratory such as basic lab safety, identification, care and operation of basic laboratory equipment including pH meters, spectrophotometers, glassware, and definition and preparation of reagents. Includes laboratory exercises in the use of selected equipment. Includes lab.

CHMT 170 Success in Science 1 Credit

Prerequisites: None. Introductory course covering the basics of the chemical process industry including career paths, business components and ethical standards. Scientific literature searches and safety issues are discussed.

CHMT 201 Industrial Instrumentation and Techniques I 3 Credits

Prerequisites: CHMT 101 and CHEM 101. Addresses theoretical

aspects of industrial laboratory instrumentation, including gas and liquid chromatography (GC and LC), high performance liquid chromatography (HPLC), infra-red (IR) spectrophotometry and atomic absorption (AA). Presents theories and laws that govern the way instruments operate. Includes student experimentation on various analytical instruments. Includes lab.

CHMT 202 Industrial Instrumentation and Techniques II 3 Credits

Prerequisites: CHMT 201. Continues the theoretical study of CHMT 201 by addressing industrial applications of laboratory instrumentation, including gas and liquid chromatography (GC and LC), high performance liquid chromatography (HPLC), infra-red (IR) spectrophotometry and atomic absorption (AA). Presents automation techniques, including sampling, data collection and analysis. Covers the laws that govern the way instruments operate. Includes student experimentation on various analytical instruments. Includes lab.

CHMT 204 Presentation of Technical Issues 3 Credits

Prerequisites: Program Advisor Approval. Focuses on solving problems in chemical technology settings including the analysis of the problem, generation of creative solutions and effective presentation of proposed solutions. Includes lab.

CHMT 207 Food, Drugs and Polymers 3 Credits

Prerequisites: CHEM 102 and CHMT 101. A survey course designed for advanced students, this course covers the basics of Food Science, Polymer Science and Pharmaceuticals. Includes lab.

CHMT 210 Quantitative Analysis 3 Credits

Prerequisites: CHEM 101 and CHEM 102. Investigates techniques for quantitative analysis of samples including their applications in industrial settings. Includes techniques such as gravimetric analysis, neutralization, oxidation-reduction titrations, potentiometric measurements and complexing titrations. Includes lab.

CHMT 270 Professional Development 1 Credit

Prerequisites: CHMT 101. Designed to be taken the semester before students begin looking for a job. Its purpose is to help students with the professional skills required in scientific industries.

CHMT 280 Internship 3 Credits

Prerequisites: Advisor Approval. Students work at a job site that is specifically related to his/her career objectives. Provides extensive job experience while earning credit towards an associate degree. Students will also participate in a once a week seminar.

CIMG 102 Introduction to Robotics 3 Credits

Prerequisites: None. Corequisite: TEC 104. Introduces students to robotics and automated systems and their operating characteristics. Covers robotics principles of operation and work envelopes.

Teaches coordinate systems and how hydraulic, pneumatic and electromechanical systems function together as a system. Covers servo and non-servo controls, system capabilities and limitations and safety.

CIMG 202 Work Cell Design and Integration 3 Credits

Prerequisites: CIMG 102. An advanced course which provides instruction in selecting equipment, writing specifications, designing fixtures and interconnects, integrating systems, providing interfaces and making the assigned systems operational.

CIMG 203 Automation Electronics 3 Credits

Prerequisites: INDT 205. Interface Programmable Controllers (PLCs) with analog I/O devices. Tune Proportional Integral Derivative (PID) loops. Analyze 4-20 mA current circuitry of a thermal process. Achieve process control with PLC analog input/output controls using a human machine interface. Program on-line and off-line via PLC networking.

CIMG 205 Automated Manufacturing Systems 3 Credits

Prerequisites: CIMG 202 and CIMG 203. Covers basic principles and applications for planning and controlling production operations and improvement programs. Includes system characteristics and solutions for production process and service operation problems; methods analysis; cost estimating; facilities planning, tooling and services acquisition and maintenance; production, project and program scheduling; materials and inventory management; safety and loss prevention; decision-making tools and evaluation of alternatives.

CINS 074 Computer Literacy 3 Credits

Prerequisites: None. Provides a general survey of computer basics. Includes the survey and analysis of microcomputer components, compares and contrasts computer applications, investigates software options, expose students to hardware peripherals and introduces students to Windows and office applications.

CINS 100 Using Windows Environment 1 Credit

Prerequisites: None. Introduces the basic concepts of Windows and Windows-based applications. The student will acquire the necessary concepts for accomplishing the most commonly used tasks, such as creating folders, copying, deleting and moving files from one folder to another or from a folder to an auxiliary storage medium. The student will also be introduced to Windows applets. The course includes Internet and e-mail operations and an introduction to simple word processing and spreadsheet applications.

CINS 101 Introduction to Microcomputers Transfer IN 3 Credits

Prerequisites: Demonstrated competency through appropriate assessment or earning a grade of "C" or better in ENGL 031. Introduces the physical components and operation of microcomput-

ers. Focuses on computer literacy and provides hands-on training in four areas of microcomputer application software: word processing, electronic spreadsheets, database management and presentation software. Use of a professional business integrated applications package is emphasized.

CINS 102 Information Systems Fundamentals 3 Credits

Prerequisites: Demonstrated competency through appropriate assessment or earning a grade of "C" or better in ENGL 031. Introduces information processing and programming with emphasis on hands-on computer experience. Examines the role of information processing in an organization including: information processing applications, computer hardware and software, internal data representation, stored program concepts, systems and programming design, flowcharting, and data communications. Review the history of computers, related computer careers, the social impact of computers, and computer security.

CINS 107 Microcomputer Programming 3 Credits

Prerequisites: CINS 102. Corequisite: CINS 113. Introduces a structured microcomputer language. Concepts in input/output commands, arithmetic expressions, conditional control, iteration techniques and subroutines will be stressed. Concepts will be incorporated into the application of solving business problems.

CINS 111 Computer Business Applications 3 Credits

Prerequisites: CINS 125 and COMM 101 or CINS 125 and COMM 102. Corequisites: CINS 203. Requires students to apply business, microcomputer and communication skills within business applications. Emphasizes application of several forms of computerized information processing including data processing, word processing, spreadsheets, graphics and communications. Analyzes the effects of automation on the office worker, management, and the work environment, and requires written and oral presentations.

CINS 112 Introduction to Simulation and Game Development 3 Credits

Prerequisites: CINS 113. Provides a basic understanding of the fundamentals of creating simulation and game design and programming. Discussions will include use for simulations and game programming, using game libraries, and interfaces used in programming. This course focuses on 2D simulations and games which include many real-time and turn-based strategy games.

CINS 113 Logic, Design and Programming 3 Credits

Prerequisite: Demonstrated competency through appropriate assessment or earning a grade of "C" or better in ENGL 031. Introduces the structured techniques necessary for efficient solution of business-related computer programming logic problems and coding solutions into a high-level language. Includes program flowcharting, pseudocoding, and hierarchy charts as a means of solving

these problems. The course covers creating file layouts, print charts, program narratives, user documentation, and system flowcharts for business problems. Reviews algorithm development, flowcharting, input/output techniques, looping, modules, selection structures, file handling, object-oriented programming, menu systems and graphical user interfaces. Offers students an opportunity to apply skills in a laboratory environment.

CINS 114 Principles of Management Information Systems 3 Credits

Prerequisites: CINS 102 and BUSN 101. Examines the functions and operations required to manage information for business decisions. Focuses on the use of various information technologies and tools that support transaction processing, decision-making and strategic planning. The diverse information needs of different organizations within a business will be used as examples of practical applications of MIS technology.

CINS 118 Introduction to COBOL 3 Credits

Prerequisites: Program Advisor Approval. Provides an introduction to COBOL (Common Business Oriented Language) with major emphasis on developing structured programming skills. Develops proficiency in applying the programming development cycle to elementary business problems.

CINS 121 C/C++/C# Programming 3 Credits

Prerequisites: CINS 113. Provides a basic understanding of the fundamentals of procedural program development using structured, modular concepts. Emphasizes logical program design involving user-defined functions and standard structure elements. Discussions will include the role of data types, variables, structures, addressable memory locations, arrays and pointers. Data file access methods are also presented.

CINS 122 RPG Programming Fundamentals 3 Credits

Prerequisites: CINS 102 and CINS 113. Provides a general introduction to the RPG programming language with emphasis on hands-on programming experience. Presents the most important features of the RPG language from input/output processing to applications requiring handling. Introduces language concepts in class lecture. Includes programming lab assignments.

CINS 123 Assembler Language Programming 3 Credits

Prerequisites: CINS 102 and CINS 113. Gives students a basic understanding of the assembler process using IBM mainframe computers. Stresses the importance of byte-wise manipulation of data fields when using low-level languages. Emphasizes the actual workings of a computer during the execution of a computer program. Discusses the role of data types, EBCDIC format of data storage and addressable memory locations.

CINS 124 Pascal Programming 3 Credits

Prerequisites: CINS 113. Provides a basic understanding of the structured programming process necessary for successful Pascal programming. Emphasizes top-down program design and modularity using Pascal procedures, functions and independent subprograms. Discuss simple and advanced data types and program control aids, algorithm development and program debugging. Provides students with a fundamental understanding of good programming technique and a basic knowledge of Pascal syntax and structure.

CINS 125 Database Design and Management 3 Credits

Prerequisites: Demonstrated computer proficiency through appropriate assessment or successful completion of CINS 101. Introduces program applications in a database environment and includes discussion of data structures; indexed and direct file organizations; data models, including hierarchical, network, and relational; storage devices, data administration and analysis; design and implementation. Using database software, students have hands-on experience creating, modifying, retrieving and reporting from databases. Students may also develop a business application using a database language.

CINS 126 Shell Command Language for Programmers 3 Credits

Prerequisites: CINT 109 or CINT 201. Teaches students how to write, test and debug shell procedures on a computer utilizing a UNIX operating system. Presents the shell and how it works, shell processes, variables, keyword and positional parameters, control constructs, special substitutions, pipelines, debugging aids, error/interrupt processing and shell command line. Offers students the opportunity to apply skills in a laboratory environment.

CINS 127 Midrange/Mainframe Database Management Systems 3 Credits

Prerequisites: Demonstrated computer proficiency through appropriate assessment or successful completion of CINS 101 and CINS 102. Presents an overview of relational database models with emphasis on midrange/mainframe management systems (DBMS). Using a variety of database tools, the student receives practical experience in creating, modifying, retrieving and reporting from databases. Students also develop business applications using the database language.

CINS 130 Seminar I 1 Credit

Prerequisites: Program Advisor Approval. Discusses topics of current interest in computerized information management with emphasis on applications of information management skills during lab time. Identifies and offers various seminar topics each term under this course number.

CINS 131 Structured Query Language 3 Credits

Prerequisites: CINS 125 or CINS 127. SQL is now a dominant lan-

uage used in mainframe, mini, and microcomputer databases (Access, dBASE, paradox, DB2, FoxPro, Oracle, SQL Server, and Btrieve) by diverse groups such as home computer owners, small businesses, large organizations, and programmers. It acts as a bridge between the user, the database management system, the data tables and transactions involving all three.

CINS 132 Graphical User Interface: Windows 3 Credits

Prerequisites: Program Advisor Approval. Provides a foundation of fundamental concepts in the use of GUI — type software. Explores the Windows operating system, accessories, and various operating system applications. Develops proficiency with Windows operations including customizing the environment, integrating operating systems applications, and managing files.

CINS 136 Introduction to Java Programming 3 Credits

Prerequisites: CINS 113. Provides a basic understanding of the fundamental concepts involved when using a member of a Java programming development language. The emphasis is on logical program design using a modular approach involving task oriented program functions. Java allows the design of an Internet user interface. The application is built by selecting forms and controls, assigning properties and writing code.

CINS 137 Visual Basic Programming 3 Credits

Prerequisites: CINS 113. A basic understanding of the fundamental concepts involved when using a member of a Windows programming development language. The emphasis is on logical program design using a modular approach involving task oriented program functions. Visual Basic applications are built by selecting forms and controls, assigning properties, and writing code.

CINS 139 Introduction to Computer Forensics 3 Credits

Prerequisites: CINS 101 and CINT 106. Presents an overview of computer forensics used in corporate and criminal investigations. Digital forensics professionals work both in computer network security and in the investigation of crimes involving the use of computers and networks. This course presents methods and software used to properly conduct a computer forensics investigation.

CINS 151 Integrated Business Software 3 Credits

Prerequisites: Demonstrated computer proficiency through appropriate assessment or successful completion of CIS 101. Presents knowledge of integrated microcomputer software concepts. Students design a complete business system utilizing all parts of an integrated microcomputer software package which can share the same data and manipulate it. Includes use of word processing, electronic spreadsheets, graphics, databases and command languages.

CINS 157 Web Site Development 3 Credits

Prerequisites: CINS 102. There is a combination of technical and non-technical skills required in those interested in Web site development. The range of skills includes those required for a designer, a

developer, and an administrator. This course provides a basic understanding of the essential Web development skills and business practices that directly relate to Internet technologies used in Web site development. This course provides the basic knowledge required to sit for the CIW Site Development Foundations certification exam.

CINS 203 Systems Analysis and Design 3 Credits

Prerequisites: Minimum of 21 CINS credits successfully completed. In this course the student will learn methodologies pertinent to the assessment, design and implementation of business computer information systems.

CINS 205 Database Design 3 Credits

Prerequisites: CINS 125. Introduces program applications in a database environment with emphasis on loading, modifying, querying the database by means of a host language. Discusses data structures; indexed and direct file organizations; models of data, including hierarchical, network and relational; storage philosophies, data administration and analysis; design; and implementation.

CINS 206 Project Development with High-Level Tools 3 Credits

Prerequisites: Program Advisor Approval. Analyzes established and evolving methodologies for the development of business-oriented computer information systems. Develops competencies in techniques that apply modern software tools to generate applications directly, without requiring detailed and highly technical program writing efforts.

CINS 215 Field Study 1-4 Credits

Prerequisites: None. A field study class is comparable to on-the-job training activities directly related to the CIS program of study. This must be approved by the program chair and the student must be in his/her last semester. A student must have a GPA of 3.0 to apply for this study position.

CINS 218 Advanced COBOL Programming 3 Credits

Prerequisites: CINS 118. Continues topics introduced in CIS 104 with more logically complex business problems. Develops a higher level of COBOL proficiency as well as greater familiarity with debugging techniques. Uses the structured approach through class instruction and laboratory experience.

CINS 221 Advanced C/C++/C# Programming 3 Credits

Prerequisites: CINS 212. Continues those topics introduced in C Language Programming with emphasis on array processing, advanced debugging techniques, dynamic memory allocation, and classes. Introduces Windows programming in C++ using MFC. Provides the opportunity to apply skills in a laboratory environment. Students will be introduced to Object Oriented Design and Programming concepts using C++ language features. Differences between C++ and classical C programming will be addressed.

CINS 222 Advanced RPG Programming 3 Credits

Prerequisites: CINS 122. Offers advanced study in the use of RPG compiler language in solving business problems. Focuses on the file processing methods and a working knowledge of advanced features and techniques through laboratory experience.

CINS 225 Advanced Database Management 3 Credits Systems

Prerequisites: CINS 201 or CINS 207. Emphasizes the development of advanced applications in database management.

CINS 227 Topics in Information Management 3 Credits

Prerequisites: CINS 114. Discusses topics of current interest in information management. Includes examples from production, operations, accounting, finance, marketing, sales and human resources. Focuses on special interest projects. Utilizes field trips, guest speakers, audio-visual activities and seminars.

CINS 230 Seminar II 2 Credits

Prerequisites: Program Advisor Approval. Discusses topics of current interest in computerized information management with emphasis on applications of information management skills during lab time. Identifies and offers various seminar topics each term under this course number.

CINS 236 Advanced Java Programming 3 Credits

Prerequisites: CINS 136. Continues those topics introduced in CIS 136 with emphasis on arrays, graphics, inheritance, the Abstract Windows Toolkit (AWT), using layout managers, and other various Java tools and concepts. Provides the opportunity to apply skills in a laboratory environment.

CINS 237 Advanced Visual Basic Programming 3 Credits

Prerequisites: CINS 137. Continues those topics introduced in CIS 232. The emphasis is on data file design, data handling, database access, ActiveX, menus, variable arrays, and Visual Basic. Students will use advanced features to increase their level of proficiency in developing Visual Basic applications.

CINS 238 Advanced Simulation and Game Development 3 Credits

Prerequisites: CINS 112. Includes in-depth discussions on creating 2D and 3D simulations and games using game libraries, timers, interrupt handlers, and multi-threading.

CINS 239 Advanced Computer Forensics 3 Credits

Prerequisites: CINS 139. Presents a continuation of the concepts learned in CINS 139, Introduction to Computer Forensics. Incidents of computers being used in the commission of crimes is increasing, making this a particularly high-demand field. This course presents advanced methods to properly conduct a computer forensics investigation for both criminal and corporate cases.

CINS 253 Graphic Image Lab 3 Credits

Prerequisites: CINS 102.A fundamental course that introduces students to computer design graphic software. The focus of the course is on understanding basic computer graphics terminology, the mastering of fundamental photo editing and basic design skills and development of efficient working styles.

CINS 257 Advanced Web Site Development 3 Credits

Prerequisites: CINS 157. There is a combination of technical and non-technical skills required for those interested in Web site development. The range of skills includes those required for a designer, a developer, and an administrator. This course provides a basic understanding of the essential Web designer skills including a review of site development essentials, an in-depth analysis of Web design elements, basic Web technologies, and advanced Web technologies. This course provides the basic knowledge required to sit for the CIW Site Designer certification exam.

CINS 258 Web Applications Programming 3 Credits

Prerequisite: CINS 157. This course will provide a basic understanding of the fundamental concepts involved when designing applications with a server-side programming language and an SQL database. There is an emphasis on logical program design using a modular approach involving task oriented program functions. Students will receive hands-on experience creating, modifying, retrieving and reporting from databases. Students will also develop a business application using a Web-oriented programming language and SQL.

CINS 259 Web Administration 3 Credits

Prerequisites: CINS 157, CINT 121, CINT 201. Gives the basics covered in the CIW Server Administrator Certification Exam. Students will learn to configure and manage corporate Internet and intranet infrastructure, monitor and tune Web, FTP, news and mail servers and configure and deploy e-business solutions servers for midsize to large businesses.

CINS 279 Capstone Course 1 Credit

Prerequisites: Program Advisor Approval. Prepares the student for entry into the Information world. Reviews procedures for interviewing, team participation, and ethical and productive job performance. Provides for taking program outcomes assessments.

CINS 280 Co-op/Internship 1-6 Credits

Prerequisites: Program Advisor Approval. Provides students with the opportunity to work at a job site that is specifically related to their career objectives. Provides on-the-job experience while earning credit toward an associate degree. Fourth semester standing and a cumulative GPA of 2.0 or better is recommended for Internship students.

CINT 105 Operating Systems 3 Credits

Prerequisites: Demonstrated computer proficiency through appropriate

assessment or successful completion of CINS 101. Studies of computer operating systems, purposes, structure and various functions. Provides general understanding of how comprehensive sets of language translators and service programs, operating under supervisory coordination of an integrated control program, form the total operating systems of a computer.

CINT 106 Microcomputer Operating Systems 3 Credits

Prerequisites: Demonstrated computer proficiency through appropriate assessment or successful completion of ENGL 031. Introduces the organization, structure, and functions of an operating system for a microcomputer. Presents the student with operating system concepts such as commands, error messages, interrupts, function calls, device drivers, structure, files and organization. Incorporates concepts into practical applications.

CINT 109 UNIX Operating Systems 3 Credits

Prerequisites: CINT 106. Studies the UNIX operating system and its use as a time-sharing operating system. Includes basic UNIX commands, use of the visual editor, the UNIX directory structure and file management with SHELL commands. Offers opportunities to apply skills and knowledge in a laboratory environment.

CINT 110 Hardware and Software Troubleshooting 3 Credits

Prerequisites: CINT 106. Presents an in-depth analysis of the components of a computer system and their relationship to each other. Includes concepts of parallel and serial connectivity, installation and maintenance of software, peripheral devices, interface cards, and device drivers. The student will analyze realistic hardware/software problems encountered in the workplace and learn techniques and procedures to implement solutions.

CINT 120 Data Communications 3 Credits

Prerequisites: CINS 102. Introduces the evolution of telecommunications and its affect on data communication systems. Topics covered will include the basic components of a communications system, a study of electrical signals used to represent data, the importance of error control when transmitting information, and the functions of network systems and their role in the communication of information. Students will also have an opportunity to explore data communications topics through research.

CINT 121 Network Fundamentals 3 Credits

Prerequisites: CINT 106. A study of local area networks, their topologies and their functions and provides a general understanding of the basic LAN protocols. Topics covered include: fundamental concepts and terminology, the IEEE/ISO Logical Link Control standard, construction of a LAN, and LAN data links for internet works.

CINT 125 Windows Client Operating System 3 Credits
Prerequisites: CINT 120 or CINT 121. Provides instruction to demonstrate the ability to implement, administer, and troubleshoot information systems that incorporate Microsoft Windows. This course is designed to follow a preparation path towards the appropriate Microsoft certification series.

CINT 135 Novell Administration 3 Credits

Prerequisites: CINT 121. Introduces the organization, structure, functions, and administration of a network operating system. This course is designed to train the student in administration of a local area network. Presents network operating system concepts such as file and shared printing, data protection, application installation, and electronic messaging. Concepts will be incorporated into practical applications.

CINT 136 Novell Advanced Administration 3 Credits

Prerequisites: CINT 135. Provides students with the knowledge and skills needed to design, configure, and administer a complex network. The course is designed to provide students with an advanced skill set.

CINT 140 Cisco Discovery: Networking for Home and Small Businesses 4 Credits

Prerequisite: CINT Program Advisor Approval. The goal of this course is to introduce you to fundamental networking concepts and technologies. This course provides a hands-on introduction to networking and the Internet using tools and hardware commonly found in the home and small business environment. These online materials will assist you in developing the skills necessary to plan and implement small networks across a range of applications. This course prepares you with the skills needed to obtain entry-level Home Network Installer jobs. It also prepares you for some of the skills needed for Network Technician, Computer Technician, Cable Installer, and Help Desk Technician jobs.

CINT 141 Cisco Discovery: Working at a Small-to-Medium Business or ISP 4 Credits

Prerequisite: CINT 140 or CINT Program Advisor Approval. The goal of this course is to assist students in developing the skills necessary to provide customer support to users of small-to-medium-sized networks and across a range of applications. The course provides an introduction to routing and remote access, addressing and network services. It will also familiarize students with servers providing email services, web space, and Authenticated Access. This course prepares students with the skills required for entry-level Help Desk Technician and entry-level Network Technician jobs.

CINT 160 Cisco Exploration: Network Fundamentals 4 Credits

Prerequisite: CINT Program Advisor Approval. The focus of this course is on learning the fundamentals of networking. In this course, stu-

students learn both the practical and conceptual skills that build the foundation for understanding basic networking. Human versus network communication are compared, and the parallels between them are presented. Students are introduced to the two major models used to plan and implement networks: OSI and TCP/IP. The OSI and TCP/IP functions and services are examined in detail. Various network devices, network addressing schemes and the types of media used to carry data across the network are also presented.

CINT 161 Cisco Exploration: Routing Protocols and Concepts 4 Credits

Prerequisite: CINT 160 or CINT Program Advisor Approval. The primary focus of this course is on routing and routing protocols. The goal is to develop an understanding of how a router learns about remote networks and determines the best path to those networks. This course includes both static routing, and dynamic routing protocols. By examining multiple routing protocols, students will gain a better understanding of each of the individual routing protocols and a better perspective of routing in general. Developing an understanding of routing concepts is critical for implementing, verifying, and troubleshooting routing operations.

CINT 170 Seminar I 1 Credit

Prerequisites: Program Advisor Approval. Discusses topics of current interest in computerized information management with emphasis on applications of information management skills during lab time. Identifies and offers various seminar topics each term under this course number.

CINT 171 Cisco Network Security 3 Credits

Prerequisite: None. The Fundamentals of Network Security course focuses on the overall security process based on a security policy with an emphasis on hands-on skills in the areas of secure perimeter, secure connectivity, security management, identity services, and intrusion detection. This course prepares students to take the Cisco 642-502 SNRS (Securing Networks with Cisco Routers and Switches) and the Cisco 642-522 SNPA (Securing Networks with PIX and ASA) Exams.

CINT 201 Advanced Operating Systems: LINUX 3 Credits

Prerequisites: CINT 106. Studies advanced topics in operating systems as they apply to networking applications. Provides data relating to the different types of operating systems including workstation and server. This course will provide the necessary information in preparation for the CompTIA Linux+ Certification Exam.

CINT 210 PC Technology Essentials 3 Credits

Prerequisites: CINT 106. Includes identification of basic terms, concepts and functions of system modules, and basic procedures for adding and removing field replaceable units. Reviews of portable system components, identification of system resources, and other

detailed information concerning PC architecture, hardware and standards. Includes identification of basic terms, concepts and function of operating systems in microcomputers and basic procedures for installation, upgrade and utilization. Reviews of basic concepts and procedures for creating, viewing, and managing files, using utility programs and understanding normal operation and symptoms relating to common problems.

CINT 211 IT Technician 3 Credits

Prerequisites: CINT 210. Includes the understanding of more advanced PC terminology, concepts, functions of system modules, and more complex procedures for troubleshooting issues regarding PCs. Includes complete analysis of portable system components, an indepth study of system resources, and other more detailed information concerning PC architecture, hardware, software, and standards. Includes a more sophisticated study of advanced terminology, concepts and functions of systems software in microcomputers and basic procedures for installation, upgrade and utilization. Reviews of more complex concepts and procedures for the administration of files using utility programs and understanding normal operation and symptoms relating to common troubleshooting issues with systems software.

CINT 212 Application User Support and Troubleshooting 3 Credits

Prerequisites: CINT 210. Through lectures, discussion, demonstrations, textbook exercises, and classroom labs students will learn the skills and knowledge necessary to support end users with their operating systems and software applications. The course will contain key concepts of end user and computer management including configuring and troubleshooting. The student will learn techniques in resolving issues with usability and customization of the operating system and applications.

CINT 213 Hardware Support and Troubleshooting 3 Credits

Prerequisites: CINT 210 and CINT 211. The student will learn through lectures, discussions, demonstrations, textbook exercises, and classroom labs the skills and knowledge necessary to support end users who use microcomputers in a corporate, small business, or home environment. The course will focus on key concepts of computer management including installing and updating operating systems, support local users and groups, manage hardware, and configure file and folder access. The student will learn techniques in resolving issues with hardware and operating systems, printers, and network connectivity.

CINT 214 Help Desk Tools and Technologies 3 Credits

Prerequisites: CINT 210. The student will study a broad range of topics that user support specialists need when working in the support

industry. The student will learn troubleshooting and problem solving in working with end users.

CINT 217 Preventative Maintenance and Data Recovery 3 Credits

Prerequisites: CINT 201 and CINT 225. Through lectures, discussion, demonstrations, textbook exercises, and classroom labs students will learn the skills and knowledge necessary to conduct maintenance on personal computers. This course will contain key concepts on computer management of preventative maintenance and troubleshooting of hardware and software. The student will learn techniques of data recovery due to equipment failure, disaster, or end user mismanagement.

CINT 220 Network Server Technologies 3 Credits

Prerequisites: CINT 120 or CINT 121. A study of network servers, particularly the hardware and software necessary to efficiently maintain a modern network. This course focuses on installation, configuration, administration, and troubleshooting of network servers. In addition it deals with site preparation, performance monitoring, and disaster recovery. The course provides support and guidance for preparation of the student to take the Server+ certification exam, a COMPTIA vendor neutral test which can apply to Microsoft's MCSA, or stand on its own merit. This course contains elements above basic hardware fundamentals of a standard PC and so the certification is considered more advanced than the A+. In addition this course deals with Industry Standard Server Architecture (ISSA) issues, such as RAID, SCSI, multiple CPUs, SANs and other networking server issues.

CINT 225 Windows Network Operating Systems 3 Credits

Prerequisites: CINT 120 or CINT 121. Provides instruction to demonstrate the ability to implement, administer, and troubleshoot information systems that incorporate Microsoft Windows Server. This course is designed to follow a preparation path towards the appropriate Microsoft certification series.

CINT 226 Implementing and Administering a Windows Network Infrastructure 3 Credits

Prerequisites: CINT 125 or CINT 225. Provides instruction to demonstrate the ability to install, manage, monitor, configure, and troubleshoot DNS, DHCP, Remote Access, Network Protocols, IP Routing, and WINS in a Windows network infrastructure. In addition, this course builds the skills required to manage, monitor, and troubleshoot Network Address Translation and Certificate Services. This course is designed to follow a preparation path towards the appropriate Microsoft certification series.

CINT 227 Managing a Windows Network 3 Credits
Prerequisites: CINT 125 or CINT 225. Provides instruction to demonstrate the ability to administer, support, and troubleshoot information systems that incorporate Microsoft Windows. This course is designed to follow a preparation path towards the appropriate Microsoft certification series.

CINT 228 Administering Windows Directory Services 3 Credits
Prerequisites: CINT 225. Provides instruction to demonstrate the ability to install, configure, and troubleshoot the Windows Active Directory™ components, DNS for Active Directory, and Active Directory security solutions. In addition, this test measures the skills required to manage, monitor, and optimize the desktop environment by using Group Policy. This course is designed to follow a preparation path towards the Microsoft exam 70-217: Implementing and Administering a Microsoft Windows 2000 Directory Services Infrastructure.

CINT 235 Networking Technology Concepts 3 Credits
Prerequisites: CINT 121. Provides students with an excellent foundation upon which to build their network training. The course covers the basics of computer networking, including terms and concepts. Networking technology—how it works, and why it works—is made clear in this course, where concepts like contemporary network services, transmission media, and protocols are explained. Students learn how protocols are used in networking implementations from many vendors, especially those most common in today's LANs and WANs.

CINT 236 Novell Hardware Service and Support 3 Credits
Prerequisites: CINT 135. Focuses on the prevention, diagnosis, and resolution of hardware-related problems encountered when working with NetWare. While the course assumes the use of NetWare, the skills learned will have a great deal of practical value to network administrators as they optimize and maintain systems while using many other Novell products. The course explores a number of research tools that will assist the network administrator in acquiring the information needed to solve "real-world" problems. It includes extensive hands-on exercises, which make up approximately 60% of all class time. The course materials are designed to provide a continuing reference that will be useful back at the student's worksite.

CINT 237 Novell Administration III 3 Credits
Prerequisites: CINT 135. How to design and implement Novell eDirectory trees and related components in any type of organization for different types of organizational goals using different types of network operating systems.

CINT 240 Cisco Discovery: Introducing Routing and Switching in the Enterprise 4 Credits
Prerequisite: CINT 141 or CINT Program Advisor Approval. The goal of this course is to assist students in developing the skills necessary to use protocols to maximize enterprise LAN and WAN performance. The course provides more advanced configurations of switching and routing protocols, configuration of access control lists, and basic implementation of WAN links. It also provides detailed troubleshooting guidance for LAN, WAN, and VLAN implementations. This course prepares students with the skills required for entry-level Network Technician, Help Desk Technician and Computer Technician jobs.

CINT 241 Cisco Discovery: Designing and Supporting Computer Networks 4 Credits
Prerequisite: CINT 240 or CINT Program Advisor Approval. The goal of this course is to assist students in developing the skills necessary to design small Enterprise LANs and WANs. The course provides an introduction to collecting customer requirements, translating those requirements into equipment and protocol needs, and creating a network topology which addresses the needs of the customer. It will also familiarize students with how to create and implement a design proposal for a customer. This course prepares students with the skills required for entry-level Pre-Sales Support and entry-level Network Design jobs.

CINT 251 Introduction to Systems Security 3 Credits
Prerequisites: CINT 106, CINT 121 and CINT 225. Provides a fundamental understanding of network security principles and implementation. The student will learn the technologies used and principles involved in creating a secure computer networking environment including authentication, the types of attacks and malicious code that may be used against a network, the threats and countermeasures for e-mail, web applications, remote access, and file and print services.

CINT 252 Routers and Firewalls 3 Credits
Prerequisites: CINT 251. Provides a basic understanding of the fundamental concepts involved in firewalls, intrusion detection and VPNs. This course prepares students to take the Check Point certification test 156-210.4 (Check Point Certified Security Administrator NG, Management I).

CINT 253 Microsoft Network Security 3 Credits
Prerequisites: CINT 125, CINT 225, and CINT 227. This course teaches the fundamentals of implementing and administering security on Windows Server 2003 networks. This course will provide instruction to demonstrate the ability to implement, administer, and troubleshoot information systems that incorporate Microsoft Windows Server. This course is designed to follow a preparation path towards the Microsoft exam 70-298 Designing Security for a Microsoft Server 2003 Network

CINT 254 Linux/Networking Security 3 Credits
Prerequisites: CINT 201 or Program Advisor Approval. Introduces concepts of security for Linux servers for computer students to build a foundation of knowledge about server systems and server applications security.

CINT 260 Cisco Exploration: LAN Switching and Wireless 4 Credits
Prerequisite: CINT 161 or CINT Program Advisor Approval. The primary focus of this course is on LAN switching and wireless LANs. The goal is to develop an understanding of how a switch communicates with other switches and routers in a small- or medium-sized business network to implement VLAN segmentation. This course focuses on Layer 2 switching protocols and concepts used to improve redundancy, propagate VLAN information, and secure the portion of the network where most users access network services. This course goes to great lengths to explain the underlying processes of the common Layer 2 switching technologies.

CINT 261 Cisco Exploration: Accessing the WAN 4 Credits
Prerequisite: CINT 260 or CINT Program Advisor Approval. The primary focus of this course is on accessing wide area networks (WAN). The goal is to develop an understanding of various WAN technologies to connect small- to medium-sized business networks. The course introduces WAN converged applications and quality of service (QoS). It focuses on WAN technologies including PPP, Frame Relay, and broadband links. WAN security concepts are discussed in detail, including types of threats, how to analyze network vulnerabilities, general methods for mitigating common security threats and types of security appliances and applications. The course then explains the principles of traffic control and access control lists (ACLs) and describes how to implement IP addressing services for an Enterprise network, including how to configure NAT and DHCP/IPv6 addressing concepts are also discussed. During the course, students will learn how to use Cisco Router and Security Device Manager (SDM) to secure a router and implement IP addressing services. Finally, students learn how to detect, troubleshoot and correct common Enterprise network implementation issues.

CINT 270 Seminar II 2 Credits
Prerequisites: Program Advisor Approval. Discusses topics of current interest in computerized information management with emphasis on applications of information management skills during lab time. Identifies and offers various seminar topics each term under this course number.

CINT 271 Field Study 3 Credits
Prerequisites: None. A field study class is comparable to on-the-job training activities directly related to the CINS program of study. This must be approved by the program chair and the student must be in his/her last semester. A student must have a GPA of 3.0 to apply for this study position.

CINT 272 Fundamentals of Wireless LANs 4 Credits
Prerequisite: CINT 260. CISCO 3 Cisco Exploration LAN Switching. This introductory course to Wireless LANs focuses on the design, planning, implementation, operation and troubleshooting of Wireless LANs. It contains a comprehensive overview of technologies, security, and design best practices with particular emphasis on hands on skills.

CINT 273 PC Parts Acquisition & Assembly 3 Credits
Prerequisite: CINT 210 or Instructor Approval. Provides a review of all the basic PC components including case, power supply, system board, CPU, RAM, video and peripheral devices. Component compatibility and the dollars versus performance tradeoff are covered in the course. Students will gain hands-on experience building and modifying their own computer system which will be purchased through the class. The experience will provide instruction in handling, assembling, and making standard connections. Common pitfalls and troubleshooting will be investigated.

CINT 274 Certified Wireless Network Administrator 3 Credits
Prerequisite: CINT 121. This course includes the understanding of the fundamentals of RF behavior, ability to describe the features and functions of wireless LAN components, and knowledge of the skills needed to install, configure, and troubleshoot wireless LAN hardware peripherals and protocols.

CINT 279 Capstone Course 1 Credit
Prerequisites: Program Advisor Approval. Prepares the student for entry into the Information world. Reviews procedures for interviewing, team participation, and ethical and productive job performance. Provides for taking program outcomes assessments.

CINT 280 Co-op/Internship 1-6 Credits
Prerequisites: Program Advisor Approval. Provides students with the opportunity to work at a job site that is specifically related to their career objectives. Provides on-the-job experience while earning credit toward an associate degree. Fourth semester standing and a cumulative GPA of 2.0 or better is recommended for Internship students.

COMM 101 Fundamentals of Transfer IN 3 Credits Public Speaking
Prerequisites: Demonstrated competency through appropriate assessment or earning a grade of "C" or better in ENGL 025 and ENGL 032. Introduces fundamental concepts and skills for effective public speaking, including audience analysis, outlining, research, delivery, critical listening and evaluation, presentational aids, and use of appropriate technology.

COMM 102 Introduction to Transfer IN 3 Credits Interpersonal Communication
Prerequisites: Demonstrated competency through appropriate assess-

ment or earning a grade of "C" or better in ENGL 025 and ENGL 032. Focuses on the process of interpersonal communication as a dynamic and complex system of interactions. Provides theory, actual practice, and criticism for examining and changing human interactions in work, family, and social contexts. Includes topics such as perception, self-concept language, message encoding and decoding, feedback, listening skills, conflict management, and other elements affecting interpersonal communication.

COMM 201 Introduction to Mass Communication 3 Credits
Prerequisites: ENGL 111. A survey of the print and electronic media that compose the mass media industry. Included in the survey are the history, technology, utilization and influence of each of the mediums as well as their symbiotic relationship to each other.

COMM 202 Small Group Communication 3 Credits
Prerequisites: ENGL 111. An introduction to communication principles and practices that enable small groups, such as committees, conferences and public discussions, to function effectively as well as the practices which limit small group effectiveness. The course is pragmatic in approach, and the student will learn small group dynamics through participation.

COMM 203 Oral Interpretation of Literature 3 Credits
Prerequisites: ENGL 111. Designed to develop the student's ability to select, analyze, interpret and communicate various types of literature to diverse audiences and to enhance the student's appreciation of literature.

COMM 204 Voice and Articulation 3 Credits
Prerequisites: COMM 101. Designed to improve the student's vocal abilities by providing a body of knowledge about voice production and diction and enabling the student to use this knowledge for his/her self-improvement.

COMM 211 Introduction to Public Relations 3 Credits
Prerequisites: ENGL 111. The course provides an introduction to the concepts, principles, and practices of public relations, from the historical to the contemporary, including public relations philosophy and theory. The course will focus on topics such as the origins of public relations, the functions and practices of public relations from past to present, ethics and law, message strategies, and research methods pertaining to public relations.

CON 101 Introduction to Construction Technology 3 Credits
Prerequisites: None. Presents history of building construction to present-day applications emphasizing future trends and construction as a career. Provides practice in the operation, maintenance and safety of various tools including the builder's level and transit.

CON 102 Construction Materials 3 Credits
Prerequisites: None. Develops skills in identifying building materials commonly used in modern building construction. Provides experience in the application of locally accessible materials.

CON 106 Construction Blueprint Reading 3 Credits
Prerequisites: None. Provides instruction and practice in the use of working drawings and applications from the print to the work. Includes relationship of views and details, interpretation of dimension, transposing scale, tolerance, electrical symbols, sections, materials list, architectural plans, room schedules and plot plans.

CON 127 Electrical Basics 3 Credits
Prerequisites: None. An introductory course covering both AC and DC circuits. Studies include electron theory, Ohm's Law, Watt's Law, Kirchoff's Law, series circuits, series-parallel circuits, electromagnetic induction, current, voltage, resistance, power, inductance, capacitance, and transformers. Stresses the use of electrical equipment, troubleshooting, installation of hardware, metering equipment, lights, switches, and safety procedures and practices.

CON 204 Estimating and Specifications 3 Credits
Prerequisites: CON 106. Involves the students with the estimating process for residential construction. Emphasizes reading blueprints and specific cations, estimating labor costs, materials take-off and pricing.

CON 280 Co-op/Internship 1-6 Credits
Prerequisites: Program Advisor Approval. Gives students the opportunity to work at a job site that is specifically related to their career objectives. Provides on-the-job experience while earning credit toward an associate degree.

CRIM 101 Introduction to Criminal Transfer IN 3 Credits Justice Systems
Prerequisites: Demonstrated competency through appropriate assessment or earning a grade of "C" or better in ENGL 025 and ENGL 032. An introductory and fundamental course that covers the purposes, functions, and history of the three primary parts of the criminal justice system: law enforcement, courts, and corrections. This course further explores the interrelationships and responsibilities of these three primary elements of the criminal justice system.

CRIM 103 Cultural Awareness 3 Credits
Prerequisites: Demonstrated competency through appropriate assessment or earning a grade of "C" or better in ENGL 025 and ENGL 032. Emphasizes the study of American criminal justice problems and systems in historical and cultural perspectives, as well as discussing social and public policy factors affecting crime. Multidisciplinary and multicultural perspectives are emphasized.

CRIM 105 Introduction to Criminology 3 Credits
Prerequisites: Demonstrated competency through appropriate assessment or earning a grade of "C" or better in ENGL 025 and ENGL 032. Critically examines the history and nature of the major theoretical perspectives in criminology, and the theories found within those perspectives. Analyzes the research support for such theories and perspectives, and the connections between theory and criminal justice system practice within all the major components of the criminal justice system. Demonstrates the application of specific theories to explain violent and non-violent criminal behavior on both the micro and macro levels of analysis.

CRIM 110 Introduction to Law Enforcement 3 Credits
Prerequisites: CRIM 101. Introduces fundamental law enforcement operations and organization. Includes the evolution of law enforcement at federal, state, and local levels.

CRIM 111 Introduction to Traffic Enforcement and Investigation 3 Credits
Prerequisites: CRIM 101. Examines the role of law enforcement in traffic safety, traffic administration, traffic laws, accident investigation, police safety, and patrol practices.

CRIM 113 Criminal Investigation 3 Credits
Prerequisites: CRIM 101. A study of the elements and techniques of criminal investigations. Primary aspects include crime scene examination, collection of evidence and search for witnesses, developing and questioning suspects, and protecting the integrity of physical evidence found at the scene and while in transit to a forensic science laboratory. Procedures for the use and control of informants, inquiries keyed to basic leads, and other information-gathering activity and chain of custody procedures will also be reviewed.

CRIM 117 Introduction to Forensics 3 Credits
Prerequisites: Demonstrated competency through appropriate assessment or earning a grade of "C" or better in ENGL 025 and ENGL 032. Studies the organization and analysis of investigative evidence, basic considerations in preparing evidential documentation for presentation in court, collection and preservation of physical evidence, and elements of legal proof in submission of evidence.

CRIM 120 Introduction to Courts 3 Credits
Prerequisites: CRIM 101. Introduces topics related to the adjudication process in criminal cases, including arraignments and preliminary hearings, suppression hearings, trials, sentencing, juvenile court, and probation and parole. Reviews the role of criminal justice personnel in court processes.

CRIM 130 Introduction to Corrections 3 Credits
Prerequisites: CRIM 101. Examines the American correctional system; the study of administration of local, state, and federal correc-

tional agencies. Includes the history and development of correctional policies and practices, criminal sentencing, jails, prisons, alternative sentencing, prisoner rights, rehabilitation, and community corrections including probation and parole. Current philosophies of corrections and the debates surrounding the roles and effectiveness of criminal sentences, institutional procedures, technological developments, and special populations are discussed.

CRIM 150 Juvenile Justice System 3 Credits
Prerequisites: CRIM 101. Examination of the philosophy and theory behind the juvenile justice system and its component parts or systems. Analysis of the police response to juvenile delinquency followed by the role of the prosecuting attorney, the juvenile court, juvenile correctional facilities, and community-based programs designed for juvenile offenders. The primary focus of attention will be on the level of integration of these systems into a coherent system of justice that effectively and equitably responds to juvenile crime. The level of cooperation and coordination existing between the various component parts of the juvenile justice system will be critiqued, and the effectiveness of the juvenile system as a whole will be evaluated. Special attention will be given to the role of the juvenile justice system within the context of social, political, and economic inequality.

CRIM 171 Drugs and Justice 3 Credits
Prerequisite: CRIM 101. This course introduces students to an examination of Drugs and Justice, with special emphasis on policing investigative and enforcement response. The course surveys issues of drug use, abuse, and criminal justice policy in our society.

CRIM 201 Ethics in Criminal Justice 3 Credits
Prerequisites: CRIM 101. A discussion of ethical theories and their considerations in the administration of criminal justice as well as the application to contemporary institutions and problems.

CRIM 204 Interview and Interrogation 3 Credits
Prerequisites: CRIM 101. Introduces students to the art of interviewing and interrogation, and further introduces them to the individual personality of the witness and/or suspect, and the means in which to secure valid information, admissions, and confessions, obtained legally and ethically, that are corroborative in nature, and that can be used to solve crimes and be introduced as evidence in court proceedings.

CRIM 205 Procedural Criminal Law 3 Credits
Prerequisites: CRIM 101. Covers the theory and practice of procedural criminal law and introduces the student to the laws of arrest, search and seizure, probable cause, due process, confessions, suspect identification and the many types of surveillances, all the while emphasizing Indiana Criminal Law.

CRIM 210 Police and Community Relations 3 Credits
Prerequisites: CRIM 101. Introduces police-community relations,

examines trends, practices, social and individual effects of police work. Emphasis on police line and support operations. Analysis of operations, enforcement policy, operations during civil disorders and disaster, as well as the role of the police officer in achieving and maintaining public support, human relations, and relationship with violators and complainants.

CRIM 212 Use of Force 3 Credits
Prerequisite: None. Provides hands on training in use of various forms of force in the performance of police duties in the field. Students will receive instruction in the use of physical force, use of chemical agents, use of firearms, defensive tactics, and working with police dogs. Students will also receive live firearms operation instruction and live-fire qualification testing.

CRIM 213 Field Practice 3 Credits
Prerequisite: None. Provides hands on training in how to handle various situations encountered by law enforcement agents in the field. The student will study the considerations and intervention techniques used by police in dealing with various types of incidents: suicide management, conflict management, elderly abuse, domestic violence, critical incidents, dealing with street gangs, hate crimes, sexual assault, and criminal profiling, etc.

CRIM 215 Police Administration and Organization 3 Credits
Prerequisites: CRIM 101. Introduction to the basic principles of law enforcement administration and organizational structure, their function and activities, records, communication, public relations, personnel and training, policy formation, evaluation of personnel and complaint processing and planning. The student who successfully completes this course will have an understanding of traditional and contemporary management approaches and techniques.

CRIM 220 Criminal Evidence 3 Credits
Prerequisites: CRIM 101. Examines the rules of evidence as applied in criminal investigation and criminal court with a discussion of relevant issues and legal standards.

CRIM 230 Community-Based Corrections 3 Credits
Prerequisites: CRIM 101. Reviews programs for convicted offenders that are alternatives to incarceration, including diversion, house arrest, restitution, community service, and other topics. Reviews post-incarceration situations, probation and parole.

CRIM 231 Special Issues in Corrections 3 Credits
Prerequisites: CRIM 101. Investigates topics of special interest related to corrections with an emphasis on the classification and treatment of inmates. Topics may vary to reflect contemporary corrections issues.

CRIM 240 Criminal Law and Procedure 3 Credits

Prerequisites: PARA 101 or CRIM 101. A theoretical and practical survey of the statutory law of crimes, evidence, and criminal procedure in Indiana, including an examination of sample pleadings and motions. Topics include the elements of specific crimes, formal procedures from pre-trial to post-trial, actual courtroom strategies, and the practical concerns involved in both the prosecution and defense of criminal cases.

CRIM 246 Legal Issues in Corrections 3 Credits

Prerequisites: HUMS 10S or CRIM 101. Examines the four historical stages of development of the American prison system, and the six major rationales for punishment associated with those stages. Identifies the criminological perspectives that inform the rationales for punishment, and the correctional policy implications relative to each rationale. Analyzes the research support for each of the six rationales for punishment, and the policy implications associated with them. Connects relevant legal issues to the correctional policy implications relative to each rationale for punishment. Locates appellate court decisions relative to correctional policy within the context of contemporary social, economic, and political conditions and controversies. Identifies the specific rights of prisoners and the responsibilities of the state with respect to the conditions of confinement.

CRIM 250 Juvenile Law and Procedures 3 Credits

Prerequisites: CRIM 123. Examination of the philosophy and theory behind the juvenile justice system and how juvenile law reflects that philosophy. Examination of the development of juvenile law and procedures, early juvenile law, landmark Supreme Court cases in juvenile justice, issues in juvenile law, and juvenile adjudicatory proceedings.

CRIM 251 Special Issues in Youth Services 3 Credits

Prerequisites: CRIM 150. Examines issues commonly experienced in the youth care field.

CRIM 252 Juvenile Delinquency 3 Credits

Prerequisites: CRIM 150. Provides an overview of the concepts, definitions, theories and measurements of juvenile delinquency. Looks at the role of environmental influences (peers, gangs, school and drugs). Develop a working knowledge of the concepts of delinquency and the concern for children of our society. Discusses an overview of the history and philosophy of the juvenile justice systems as well as ways to control and treat juvenile offenders.

CRIM 260 Research Methods in Criminal Justice 3 Credits

Prerequisites: CRIM 101 and demonstrated competency through appropriate assessment or earning a grade of "C" or better in MATH 050. Familiarizes students with the basic concepts, techniques, and problems associated with conducting research in criminal justice.

Provides students with the analytical and critical thinking skills required to understand empirical research. Students will also acquire the necessary tools to conceptualize and conduct a research project. Students will examine the advantages and limitations of decisions that are made in the process of conducting research. Problems specific to research in criminal justice will be explored.

CRIM 271 Terrorism 3 Credits

Prerequisite: Advisor Approval. This course introduces students to an examination of terrorism and America's criminal justice system, with special emphasis on policing investigative response. The course surveys the meaning and historical overview of terrorism in the United States, a synopsis of global terrorism, and the functional and organizational preparedness and response to this global threat by America's criminal justice system.

CRIM 280 Internship 4 Credits

Prerequisites: Program Advisor Approval. Provides fieldwork experience in an approved social, educational, law enforcement, corrections or other criminal justice organization.

CSTC 101 Infection Control Procedures 4 Credits

Prerequisites: Demonstrated competency through appropriate assessment or earning a grade of "C" or better in ENGL 025, ENGL 032, and MATH 050. Provides the fundamentals of central processing, supply and processing distribution. Designed to give instruction and practice in aseptic technique and infection control measures necessary for central service. This course includes an in-depth practice of numerous sterilization techniques. The student develops skills and becomes proficient in the functions of cleaning, decontaminating, processing, and sterilizing of reusable patient care supplies and equipment.

CSTC 102 Surgical Instrumentation 2 Credits

Prerequisites: CSTC 101. Prepares the student to identify surgical instruments by category, type and use. Emphasis on quality assurance enables the student to inspect, assemble and prepare instrumentation for packaging.

CSTC 103 Fundamentals of Health Careers 3 Credits

Prerequisites: CSTC 101. Emphasizes legal and ethical considerations of health care delivery. The student practices workplace safety measures including body mechanics, infection control and environmental safety. Employability skills to gain and keep employment are practiced.

CSTC 104 Clinical Applications I 3 Credits

Prerequisites: CSTC 102. Provides 100 of the 400 hours necessary for the student to take the IAHCSSM Technical Certification Exam. Emphasis is placed on the basics of patient care equipment and general cleaning and wrapping of instruments.

CSTC 105 Fundamentals of Central Service Technician Skills 4 Credits

Prerequisites: CSTC 104. Introduces the field of central service and the personnel within the department. The principles and importance of the flow of materials are determined. The student learns about environmental control factors affecting the central service department. The student will differentiate between equipment management systems and compare out-sourcing and insourcing. Various types of purchasing issues and inventory methods will be explored.

CSTC 106 Clinical Applications II 3 Credits

Prerequisites: CSTC 104. Provides 160 of the 400 hours necessary for the student to take the IAHCSSM Technical Certification Exam. Emphasis will be placed on the basics of linen folding, assembling instrument and procedure trays, and sterilization.

CSTC 107 Application of Central Service Technician Skills 3 Credits

Prerequisites: CSTC 104. Emphasizes the practice of high and low sterilization methods. Students differentiate among the various sterilization methods in theory and practice.

CSTC 108 Clinical Applications III 4 Credits

Prerequisites: CSTC 107. Provides 192 of the 400 hours necessary for the student to take the IAHCSSM Technical Certification Exam. Emphasis will be placed on clean and sterile storage, case carts, and distribution.

DENT 102 Dental Materials and Lab I 3 Credits

Prerequisites: Admission to the Dental Assistant program. The first in a series of two courses that reviews in-depth the properties of dental materials, proper modes of manipulation, necessary armamentarium used, and technical duties dental assistants can perform. Stresses clinical behavior of materials and biological factors of importance to dental assistant.

DENT 115 Preclinical Practice I 4 Credits

Prerequisites: Admission to the Dental Assistant program. The first in a series of two courses that introduce in-depth qualification and legal/ethical requirements of the dental assistant. Surveys history and professional organizations. Emphasizes clinical environment and responsibilities, chairside assisting equipment and instrument identification, tray setups, sterilization, characteristics of microorganisms and disease control.

DENT 116 Dental Emergencies/Pharmacology 2 Credits

Prerequisites: Admission to the Dental Assistant program. An in-depth course that surveys the most commonly utilized and required first aid measures for emergencies. Examines proper techniques and procedures as well as equipment, medications and positioning for care of the patient. Reviews anatomy/physiology and cardiopulmonary rescue as provided by the American Heart Association.

DENT 117 Dental Office Management 2 Credits
Prerequisites: DENT 123. Focus on the principles of administrative planning, bookkeeping, recall programs, banking, tax records, computer software, insurance, office practice and management as related to the dental office. Attention is given to techniques of appointment control, record keeping and credit and payment plans.

DENT 118 Dental Radiography 4 Credits
Prerequisites: DENT 115 and DENT 123. An in-depth course that focuses on the principles, benefits, effects, and control of X-ray production. Covers history, radiation sources, modern dental radiographic equipment and techniques, anatomical landmarks, dental films and processing. Emphasizes avoidance of errors while exposing and processing dental radiographs.

DENT 122 Clinical Practicum I 1 Credit
Prerequisites: DENT 102, DENT 115, DENT 116 and DENT 123. An in-depth course that focuses on the performance of chairside skills that are applied in a clinical office situation on live patients.

DENT 123 Dental Anatomy 2 Credits
Prerequisites: Admission to the Dental Assistant program. An in-depth course that focuses on oral, head and neck anatomy, basic embryology, histology, tooth morphology and charting dental surfaces related to the dental field. Includes dental anomalies, pathological conditions and terminology relevant to effective communication.

DENT 124 Preventive Dentistry/Diet and Nutrition 2 Credits
Prerequisites: DENT 115 and DENT 123. An in-depth course that emphasizes the importance of preventive dentistry and the effects of diet and nutrition on dental health techniques of assisting patients in the maintenance of good oral hygiene.

DENT 125 Preclinical Practice II 3 Credits
Prerequisites: DENT 102, DENT 115, DENT 116 and DENT 123. The second in a series of two in-depth courses that continues Preclinical Practice I. Anesthesia is presented. The following dental specialties are presented: Oral and Maxillofacial Surgery, Periodontics, Endodontics, Pediatric Dentistry, Orthodontics, Prosthodontics, and Dental Public Health.

DENT 129 Dental Materials and Lab II 3 Credits
Prerequisites: DENT 102. The second in a series of two in-depth courses that reviews the properties of dental materials, proper modes of manipulation, necessary armamentarium used, and technical duties dental assistants can perform. Stresses clinical behavior of materials and biological factors of importance to dental assistant.

DENT 130 Clinical Practicum II 5 Credits
Prerequisites: All DENT Courses. An in-depth clinical learning experience that provides increased practical chairside dental assisting

experience to be gained from private dental practices in general and specialty areas of dentistry. Opportunity for increased skill development in clinical support and business office procedures also provided. Weekly seminars are included as an integral part of the learning experience. Simulated exams are administered to review for the national certification exam.

DENT 131 Basic Integrated Science 2 Credits
Prerequisites: Admission to the Dental Assistant program. An introductory course that examines human body as integrated unit; includes anatomy, physiology and medical terminology.

DENT 132 Expanded Functions for Dental Assistants 3 Credits
Prerequisite: DENT 129, DENT 125, DENT 122, DENT 123. Applies theory and techniques at the laboratory competency level of restorative dentistry to facilitate increased production potentials in the dental office. Students are instructed in the various extended functions as allowed by the Indiana Dental Law and the Board of Dental Examiners.

DENT 171 Introduction to Dental Terminology 3 Credits
Prerequisite: None. Addresses basic terminology required for allied health professionals, with a focus on dental assisting. Provides a review of terms associated with anatomy and physiology, pathology, special procedures, laboratory procedures, and pharmacology. Emphasis is on forming a foundation for a dental vocabulary including meaning, spelling, and pronunciation. Dental abbreviations, signs, and symbols are integrated.

DESN 100 Introduction to Design Technology 3 Credits
Prerequisites: None. Provides the beginning design technology student with the basic tools necessary for success in their chosen program.

DESN 102 Technical Graphics 3 Credits
Prerequisites: None. Provides students with a basic understanding of the detailing skills commonly used by a drafting technician. Areas of study include: lettering, sketching, proper use of equipment, geometric constructions with emphasis on orthographic (multi-view) drawings that are dimensioned and noted to ANSI standards.

DESN 103 CAD Fundamentals 3 Credits
Prerequisites: None. Provides students with a basic understanding of the features and considerations associated with the operation of a computer-aided design (CAD) system. Students will gain valuable hands-on experience using CAD software. They will be expected to complete several projects (increasing in difficulty) relating to command topics covered on a weekly basis.

DESN 104 Mechanical Graphics 3 Credits
Prerequisites: DESN 103. Covers working drawings both in detailing and assembly. Presents fastening devices, thread symbols and nomenclature, surface texture symbols, classes of fits, and the use of

parts lists, title blocks and revision blocks.

DESN 105 Architectural Design I 3 Credits
Prerequisites: DESN 103 OR PLTW IED AND PLTW POE. Presents a history and survey of architecture and focuses on creative design of buildings in a studio environment. Covers problems of site analysis, facilities programming, space planning, conceptual design, proper use of materials, selection of structure and construction techniques. Develops presentation drawings, and requires oral presentations and critiques. Generation of form and space is addressed through basic architectural theory, related architectural styles, design strategies, and a visual representation of the student's design process.

DESN 106 Descriptive Geometry 3 Credits
Prerequisites: TECH 102. Introduces fundamental principles in developing graphical solutions to engineering problems. Topics covered in this course include true length, piercing points on a plane, line intersections, true shapes, revolutions, and developments using successive auxiliary views.

DESN 107 History of Architecture 3 Credits
Prerequisites: Demonstrated competency through appropriate assessment or earning a grade of "C" or better in ENGL 025, ENGL 032 and MATH 044. Studies the ingenuity and imagination of the human spirit in shaping the built environment related to cultural, political, social, and technological history. Presents a survey of architectural styles, architects, design philosophies, and building materials used by time, period, country, region and city. Requires oral presentations, essays, term papers, research and small projects. Field trips to historical architectural sites are a part of this course.

DESN 108 Residential Design 3 Credits
Prerequisites: DESN 103. Covers residential design and drafting. Includes interior space planning, structural design and development of working drawings. Provides opportunity for students to design a residence using accepted building standards.

DESN 109 Construction Materials and Specifications 3 Credits
Prerequisites: None. Introduces various construction materials, composition and application. Studies specifications of materials, construction contracts, and applications required in the building industry.

DESN 110 Architectural Rendering 3 Credits
Prerequisites: TECH 102. Presents a survey and history of pictorial drawings. Studies light and color, rendering media, and application of different architectural rendering techniques and media through a series of exercises.

DESN 113 Intermediate CAD 3 Credits
Prerequisites: DESN 103. Improves the student's CAD ability by presenting intermediate CAD commands, which will lead to the creation

of advanced prototype drawings, graphic manipulation of symbol libraries, the utilization of advanced dimensioning techniques, and application of data sharing techniques. Detailed plotting instruction will also be covered. Students will be expected to complete several projects relating to command topics covered on a weekly basis.

DESN 130 Fundamentals of Computer Graphics 3 Credits

Prerequisites: None. Introduces students to raster & vector based applications as they relate to the CAD field. Demonstrates the knowledge of devices used in the creation and for the output of drawings. Understand the importance of graphics in the design process and how it impacts the design field. These skills are developed by producing work from related applications.

DESN 131 Industrial Sketching 3 Credits

Prerequisites: None. Combines fundamental computer graphics concepts of design, visualization, communication and display within an industrial sketching metaphor. Exercises and projects in graphic theory, problem solving and sketching skill development provide students with activities that focus on further development within CADD, vector imaging, raster imaging and other related formats. A variety of sketching techniques are used to gather critical information and transform graphical data into effective design communication instruments. Produces samples for student portfolios.

DESN 132 Raster Imagine Fundamentals 3 Credits

Prerequisites: None. Provides intermediate instruction in illustration techniques using computer software designed for creating illustrations, technical, drawing, logos, packaging, maps, charts, and graphs utilizing CADD data. Emphasis is on preparing effective, creative illustrations for various media applications in an efficient, productive manner. Produces samples for student portfolios.

DESN 133 Vector Imaging Fundamentals 3 Credits

Prerequisites: DESN 103. Provides fundamental instruction in working with vector images (CAD drawings) while applying elements and principles of design to illustrations for various output. Combines color theory, creativity, type and layout design for renderings.

DESN 138 2D Animation 3 Credits

Prerequisites: DESN 131 and DESN 133. Provides fundamental instruction how animation scripts are developed as well as how visual stories are told through technical elements such as composition, lighting, framing and perspective. Exploring how to tap into creativity and create interesting original animations.

DESN 201 Schematics 3 Credits

Prerequisites: TECH 102 and DESN 103. Includes the layout of the various types of schematic drawings. Students will prepare finished

drawings for the manufacture or installation of plumbing, heating, electrical, electronic and fluid power drawings.

DESN 202 CAD Customization and Programming 3 Credits

Prerequisites: DESN 103. Covers customizing of a CAD system. Covers methods used to make CAD system more efficient for the individual user.

DESN 204 Architectural Design II 3 Credits

Prerequisites: DESN 105. Presents advanced computer-aided design topics in architectural design. Utilizes current (UBC) information for project design. Includes all necessary drawings needed for the construction process.

DESN 206 Mechanical and Electrical Equipment 3 Credits

Prerequisites: DESN 103 and 100-level Mathematics course. Focuses on mechanical and electrical requirements for buildings. Studies electrical load calculations, wire sizing and circuits, plumbing requirements, fixture units and pipe sizing. Includes heating systems, duct layout and sizing.

DESN 207 Die Design 3 Credits

Prerequisites: DESN 104 and TECH 101. Studies the detailing and design of blanking, piercing, and forming dies. Covers material reaction to shear, cutting clearances and net gauging.

DESN 208 Structural Design and Detailing 3 Credits

Prerequisites: DESN 109, DESN 103 and 100-level Mathematics course. Focuses on the design and detailing of commercial structural members, their connections, materials and methods of construction. Concentrates on traditional materials such as reinforced concrete, masonry, steel, and timber. Develops understanding of element behavior, its significance to detailing, and establishes the ability to prepare working drawings for structural projects.

DESN 209 Estimating 3 Credits

Prerequisites: DESN 109. This course provides students with an understanding of building an estimate of the probable construction costs for any given project. To prepare an estimate of quantities, the student estimator must become familiar with working drawings, specifications, and various bid documents. While computerized estimating software is commonplace in industry, it is also essential that the student is able to apply the math theory behind quantification.

DESN 210 Surveying 3 Credits

Prerequisites: MATH 121 or MATH 131 or MATH 134. Provides students with a basic understanding of surveying equipment, procedures for performing measurements, turning angles, determining grades and other field applications. Surveying techniques and computations using the level, chain, and transit in calculating areas,

lines, and grades will be covered in this course.

DESN 211 Commercial Structures I 3 Credits

Prerequisites: DESN 204 and 100-level Mathematics course. Presents the design and drawing of commercial structures utilizing the Uniform Building Code (UBC). Focus is directed to structural systems and details of commercial structures including wood, steel, and concrete. Provides architecture students with essential skills to perform structural analysis of buildings.

DESN 212 Commercial Structures II 3 Credits

Prerequisites: DESN 211. Focuses on the planning and drawing of commercial structures. Uses working drawings for pre-engineered and concrete/steel structures. Applies lessons learned from DCT 211 to new structure(s).

DESN 213 CAD Mapping 3 Credits

Prerequisites: DESN 103. Covers the concepts of map-making with CAD software and typical media found in the industry. Civil application of mapping procedures including profiles, topography, and site plans will also be discussed.

DESN 214 Kinematics of Machinery 3 Credits

Prerequisites: DESN 104 and MATH 121 or MATH 131 or MATH 134. This noncalculus based course studies the application of kinematics theories to real world machinery. Static and motion applications will be studied.

DESN 215 Electronic Schematics 3 Credits

Prerequisites: TECH 102 and DESN 103. Introduces students to electronic schematics, standardized symbols, and acceptable practices in creating various electrical and electronic drawings. Emphasizes the creation and manipulation of basic symbols, connection diagrams, block and logic diagrams, including the use of figure parts and data extraction. Introduction to analog and digital multimeters and other electronic measuring instruments.

DESN 216 Jig and Fixture Design 3 Credits

Prerequisites: DESN 104 and TECH 101. The processes of drafting and design as applied to tooling. Emphasizes tooling, locators, supports, holding devices, clearances and design as it pertains to jig and fixtures.

DESN 217 Design Process and Applications 3 Credits

Prerequisites: DESN 104. Provides the student an opportunity to apply all previously acquired knowledge in the design of a new or existing consumer product. Students will study the design processes with consideration given to the function, aesthetics, cost economics and marketability of the product. A research paper and product illustration is required in this course.

DESN 220 Advanced CAD 3 Credits

Prerequisites: TECH 102 and DESN 103. Focuses on advanced CAD fea-

tures, including fundamentals of three-dimensional modeling for design. Includes overview of modeling, graphical manipulation, part structuring, coordinate system, and developing strategy of modeling. Advanced CAD will enable the student to make the transition from 2D drafting to 3D modeling.

DESN 221 Statics 3 Credits

Prerequisites: MATH 121 or MATH 131 or MATH 134. Studies applied mechanics dealing with bodies at rest without the use of calculus. Covers units, vectors, forces, equilibrium, moments and couples, planar force systems, distributed forces, analysis of structures, and friction.

DESN 222 Strength of Materials 3 Credits

Prerequisites: DESN 221. Studies internal stresses and physical deformations caused by externally applied loads to structural members. Covers stress and strain, shear stress, properties of areas, shearing force and bending moment, deformation of beams, columns and combined stresses. Studies various materials' physical and mechanical properties.

DESN 223 Parametric Solid Modeling 3 Credits

Prerequisite: This course builds upon previous CAD experience and focuses on solid modeling techniques and design intent utilizing parametric solid modeling CAD software. Students will use parametric CAD software to create solid geometry for individual parts, create assemblies from the individual parts and then produce engineering working drawings from the solid models. Topics include sketching, part modeling, and assemblies.

DESN 225 Portfolio Preparation 3 Credits

Prerequisites: DESN 220. Focuses on the student's final portfolio for graduation and preparation for the job interview. Finalizes design project work demonstrating the required knowledge and skills for degree achievements along with resume and cover letter preparation. A presentation for the portfolio is required in this class. Every student must submit a copy of the final portfolio for departmental archives upon graduation.

DESN 227 Geometric Dimensioning and Tolerancing 3 Credits

Prerequisites: TECH 102 or INDT 102. Introduces the fundamental principles of geometric dimensioning and tolerancing according to the latest ANSI standards. Students will apply geometric dimensioning and tolerancing symbols along with tolerances of form, profile, orientation, run-out, and location to mechanical problems.

DESN 228 Civil I 3 Credits

Prerequisites: DESN 103 and 100-level Mathematics course. Presents an overview of the basics of infrastructure related design topics, including the study of roadway and drainage systems. Emphasizes the preparation of drawings pertaining to infrastructure design and site development. Numerical calculations related to the design topics will be discussed.

DESN 229 Civil II 3 Credits

Prerequisites: DESN 228. Presents advanced infrastructure related design topics, including highway structures, pavement types and geotechnical considerations. Emphasizes the preparation of drawings pertaining to various types of bridges. Drawing presentation of geotechnical site studies and pavement designs is also reviewed. Numerical calculations related to the design topics will be explained.

DESN 230 Computer Modeling and Animation 3 Credits

Prerequisites: DESN 103. Contains an historical overview of the development of computer-generated imagery, including CADD, computer animation, computer art and visualization. This course will cover various aspects of 3-Dimensional modeling, lighting, and camera placement, as well as compositional and design aspects for presentation. Computer animation techniques such as keyframing, inverse kinematics, and simulation will be introduced. The course also includes an overview of storyboarding, scene composition, and lighting.

DESN 250 Vector Mechanics-Statics 3 Credits

Prerequisites: MATH 218. Includes resolution and composition of forces, moments, principles of equilibrium and application to trusses and jointed frames, friction, center of gravity and second moments of areas. Uses vector analysis throughout.

DESN 251 Dynamics 3 Credits

Prerequisites: DESN 250. Covers rectilinear and curvilinear motions, force, mass and acceleration, projectiles, pendulums, inertia forces in machines, work and energy, impulse and momentum and impact.

DESN 252 Mechanics of Solids 4 Credits

Prerequisites: DESN 250. Covers general principles of stress and strain, including elastic and inelastic behavior, shear, torsion, stresses in beams and deflection of beams and columns. The lab portion will be used to determine various materials' physical and mechanical properties.

DESN 271 Introduction to Solidworks 3 Credits

Prerequisite: DESN 103. Introduction of the fundamental features of Solidworks design software and its major applications in industries. Students will get knowledge and skill on technical drawing making, communication and drawing management utilizing Solidworks.

DESN 272 Advanced Solid Modeling 3 Credits

Prerequisite: DESN 220. This course covers the modeling of complex parts, complex surfaces, rapid prototyping, sheet metal parts, stress analysis, automatic bill of materials generation, and other advanced modeling techniques as time permits.

DESN 280 Co-Op/Internship 3 Credits

Prerequisites: Program Advisor Approval. Gives students the opportunity to work at a job site that is specifically related to their career

objectives. Provides on-the-job experience while earning credit towards an associate's degree.

DHYG 101 Fundamental of Dental Hygiene 2 Credits

Prerequisite: Admission into the Dental Hygiene Program. Corequisite: DHYG 102. Introduction to the dental and dental hygiene profession, including principles of infection control, instrumentation, instrument design and fundamental dental hygiene skills necessary to perform in subsequent courses. This course will have a corresponding lab to allow for application of principles learned in this course.

DHYG 102 Fundamentals of Dental Hygiene Clinic 2 Credits

Prerequisite: Admission into the Dental Hygiene Program. Corequisite: DHYG 101. Introduction to basic procedures used in dental hygiene practice, with primary emphasis on the techniques of instrumentation used in performing diagnostic, preventive, and therapeutic services. CREDIT HOURS: 2; CONTACT HOURS: 6; CLINICAL HOURS: 6

DHYG 103 Dental Radiography 2 Credits

Prerequisite: Admission into the Dental Hygiene Program. Comprehensive study of the principles of ionizing radiation and application of radiographic theory in dental hygiene practice. Radiation safety for operator and patient is emphasized.

DHYG 104 Dental Anatomy 2 Credits

Prerequisite: Admission into the Dental Hygiene Program. An in-depth course that focuses on the morphology, structure, and function of deciduous and permanent teeth and surrounding tissues.

DHYG 105 Nutrition and Oral Health 2 Credits

Prerequisite: Admission into the Dental Hygiene Program. Introduction of the concepts of biochemistry and nutrition and their relationship to concepts in dentistry, health and disease and their application to the practice of dental hygiene.

DHYG 106 Oral Histology and Embryology 1 Credit

Prerequisite: Admission into the Dental Hygiene Program. The study of histological and embryonic development of the head, face, and hard and soft tissues of the oral cavity to include developmental abnormalities.

DHYG 107 Head and Neck Anatomy 1 Credit

Prerequisite: Admission into the Dental Hygiene Program. Anatomy and Physiology of the head and neck are studied with special emphasis on nerves, muscles and their attachments, bone structures, and functions of the oral cavity.

DHYG 109 Preventive Dentistry 1 Credit

Prerequisites: :DHYG 101, 102, 104, and 105. Oral diseases and preventable conditions will be reviewed and evaluated in terms of their causes, assessment of individual risk factors, epidemiological distribu-

tions in populations, clinical detection, and evidence-based approaches to prevention. Preventive methods including fluoride, sealants, mouth guards, and plaque control measures, will be discussed in terms of their utilization, effectiveness, method of delivery, and cost.

DHYG 113 Dental Radiography Clinic I 1 Credit

Prerequisites: DHYG 103, DHYG104, DHYG107. Corequisite: DHYG 114 Clinical applications of principles and theories learned in DHYG 103, Dental Radiography. Exposure, processing and management of intra and extra-oral radiographs:

DHYG 114 Dental Hygiene Clinic I 5 Credits

Prerequisite: DHYG 101, 102, 104. Corequisite: DHYG 113. Patient assessment, treatment planning, writing, and communicating of dental hygiene treatment plans. The implementation of various dental hygiene treatment modalities including information pertaining to patients with special needs.

DHYG 120 Pharmacology 2 Credits

Prerequisite: Admission into the Dental Hygiene Program. A study of drugs with emphasis on the classification of drugs, their uses, actions, interactions, side effects, contraindications and oral manifestations with emphasis on dental applications. A study of dental anesthetics is included.

DHYG 121 Medical and Dental Emergencies 1 Credit

Prerequisite: Admission into the Dental Hygiene Program. The prevention, diagnosis and management of common medical emergencies in the dental setting.

DHYG 122 General Pathology 1 Credit

Prerequisite: Admission into the Dental Hygiene Program. Principles of general pathology, oral pathology and oral medicine related to the etiology, progression, recognition and treatment of numerous pathological conditions. Course content focuses oral manifestations of systemic diseases, and pathologic identification of infectious diseases. Emphasis is placed on the importance of early recognition by the dental hygienist of abnormal oral conditions.

DHYG 201 Community and Public Health 3 Credits

Prerequisites: DHYG 109, DHYG 113, DHYG 114, DHYG 120, DHYG 121, DHYG 122. Corequisites: DHYG 203, DHYG 222, DHYG 224. A study of the principles and methods used in assessing, planning, implementing and evaluating community dental health programs. Topics include epidemiology, research methodology, biostatistics, preventive dental care, dental health education, program planning, and financing and utilization of dental services. Upon completion, students should be able to assess, plan, implement and evaluate a community dental health program.

DHYG 203 Dental Materials 2 Credits

Prerequisites: DHYG 109, DHYG 113, DHYG 114, DHYG 120, DHYG 121,

DHYG 122. Corequisites: DHYG 201, DHYG 222, DHYG 224. Study of physical and chemical properties, identification, characteristics and manipulation of dental materials.

DHYG 204 Pain Management 2 Credits

Prerequisites: DHYG 108, DHYG 109, DHYG 113, DHYG 114, DHYG 120, DHYG 121, DHYG 122. Corequisites: DHYG 201, DHYG 222, DHYG 224. Provides the dental hygiene student with both the theoretical knowledge and the practical clinical skills to successfully perform the appropriate pain control measures to maintain patient safety and comfort. This includes the prevention and management of emergencies.

DHYG 208 Periodontology 2 Credits

Prerequisites: DHYG 201, DHYG 203, DHYG 222, DHYG 224. Corequisites: DHYG 230, DHYG 234. A study of the normal and diseased periodontium to include the structural, systemic, functional and environmental factors. Emphasis on therapeutic and preventive periodontics, etiology, pathology, and treatment modalities.

DHYG 222 Oral Pathology 2 Credits

Prerequisites: DHYG 201, DHYG 203, DHYG 208, DHYG 224. Corequisites: DHYG 230, DHYG 234. The study of oral diseases, oral manifestations of systemic disease, and the processes of inflammation, wound healing, repair and immunological responses. Emphasis will be placed on the recognition of oral abnormalities and differential diagnosis of oral lesions.

DHYG 224 Dental Hygiene Clinic II 5 Credits

Prerequisites: DHYG 109, DHYG 113, DHYG 114, DHYG 120, DHYG 121, and DHYG 122. Corequisites: DHYG 201, DHYG 222, and DHYG 203. Applies theory and techniques of oral hygiene therapy in a clinical environment. Advanced instrumentation skills will be introduced. Clinical application of principles and theories learned in previous Dental Radiography I. Meet patients will be placed on accuracy of placing radiographs to meet patients needs.

DHYG 228 Dental Hygiene Clinical Procedures 1 Credit

Prerequisite: DHYG 113, DHYG 114, DHYG 120, DHYG 121, DHYG 122 and DHYG 208. Corequisite: DHYG 204. This clinical course will focus on the continued development and refinement of dental hygiene skills learned in DHYG 114. Incorporation of dental radiographs into the dental hygiene treatment plan will be included.

DHYG 230 Clinical Seminar 2 Credits

Prerequisites: DHYG 204, DHYG 233, and DHYG 234. Corequisites: DHYG 201, DHYG 203, DHYG 222, and DHYG 224. Provides information related to ethics, jurisprudence including a study of the state practice act. Practice management principles and employment opportunities for the dental hygienist, resume writing and interviewing will also be covered.

DHYG 234 Dental Hygiene Clinic III 6 Credits

Prerequisites: DHYG 201, DHYG 203, DHYG 208, DHYG 222, and DHYG 224. Corequisites: DHYG 204 and DHYG 230. Allows for the refinement of clinical skills and application of technology and current procedural practices of the dental hygienist with emphasis on self-evaluation and quality assurance.

DMSI 101 Ultrasound Physics I 3 Credits

Prerequisites: None. Designed to provide fundamental principles of ultrasound physics and instrumentation. The essential concepts of how ultrasound is created and it's interaction with tissue are introduced.

DMSI 102 Abdominal Sonography I 3 Credits

Prerequisites: None. Introduces and familiarizes the student with the basic anatomy and physiology related to abdominal sonography. The student will also learn to identify cross sectional and sonographic anatomy.

DMSI 103 OB/Gyn Sonography I 3 Credits

Prerequisites: None. Introduces and familiarizes the student with the basic anatomy and physiology related to gynecologic and obstetric sonography. The student will also learn to identify cross sectional and sonographic anatomy.

DMSI 104 Vascular Imaging I 3 Credits

Prerequisite: One year prior experience in the area of study. This course focuses on the performance and interpretation of noninvasive ultrasound vascular studies. Topics of study will include anatomy, physiology, hemodynamics of the vascular system, direct and indirect testing methods, B-Mode imaging, pulsed Doppler, spectral analysis, color flow Doppler, and preliminary interpretation. The anatomy, physiology, and pathology of the arterial and venous circulation systems and the imaging protocols and techniques for these systems will be covered in this course.

DMSI 201 Ultrasound Physics II 3 Credits

Prerequisite: DMSI 101. Designed to build on basic fundamentals of ultrasound physics. The principles of Doppler, Color flow, 3D, and 4D ultrasound are presented.

DMSI 202 Abdominal Sonography II 3 Credits

Prerequisites: DMSI 102. Continues to build on the knowledge acquired in Abdominal Sonography I along with learning pathologic indications.

DMSI 203 OB/Gyn Sonography II 3 Credits

Prerequisite: DMSI 103. Continues to build on the knowledge acquired in OB/Gyn Sonography I along with learning pathologic indications.

DMSI 204 Vascular Imaging II**3 Credits**

Prerequisite: One year prior experience in the area of study. This course will build upon concepts and studies of Vascular Imaging I and include focus on the performance and interpretation of noninvasive ultrasound vascular studies. Topics of study will include anatomy, physiology, hemodynamics of the vascular system, direct and indirect testing methods, B-Mode imaging, pulsed Doppler, spectral analysis, color flow Doppler, and preliminary interpretation. The anatomy, physiology, and pathology of the arterial and venous systems, concentrating on upper and lower extremity venous studies, and abdominal vascular studies, and the imaging protocols and techniques for these systems will be covered.

ECED 100 Introduction to Early Childhood Education**3 Credits**

Prerequisites: None. Entry level course for Early Care and Education teachers. Provides an overview of the history, theory, and foundations of early childhood education as well as exposure to types of programs, curricula and services available to young children. Opportunities to explore a variety of opportunities in the field through lecture, activities, and classroom observations.

ECED 101 Health, Safety, and Nutrition**3 Credits**

Prerequisites: None. Examines basic principles of child development, Developmentally Appropriate Practices (DAP), importance of family, licensing, and elements of quality care of young children with an emphasis on the learning environment related to health, safety, and nutrition. Entry-level course for early care and education teachers.

ECED 103 Curriculum in Early Childhood Classroom**3 Credits**

Prerequisites: None. Entry level course for Early Care and Education teachers. Examines developmentally appropriate environments and activities in various childcare settings. Explores the varying developmental levels and cultural backgrounds of children.

ECED 105 CDA Process**3 Credits**

Prerequisites: Program Chair Approval. Prepares the student for the verification process for the Child Development Associate (CDA) credential. Students are provided opportunities for practical experience through supervised participation in early care and education settings.

ECED 107 Introduction to Teaching**3 Credits**

Prerequisites: None. An introductory course which explores philosophical and historical foundations of the American educational system. Examines the ecological factors that impact the classroom. Defines the characteristics of the competent teacher. Provides opportunities for observations, hands on learning experiences and volunteer service.

ECED 110 Infant/Toddler Growth and Development**3 Credits**

Prerequisites: Demonstrated competency through appropriate

assessment or earning a grade of "C" or better in ENGL 025 and ENGL 032. Studies the physical, social, emotional, cognitive, and language development of infants and toddlers from conception through age three. Examines the crucial role of brain development and ecological systems during the first three years. Responsive care by adults is recognized as crucial to the development of the infants and toddlers. Quality child care is defined.

ECED 111 Environments for Infants and Toddlers**3 Credits**

Prerequisites: None. Examines physical, human and time environmental factors essential for providing quality early care and education. Discovers and assesses the various settings for infants and toddlers from the perspectives of quality and family issues. Adult-child relationships and adult-adult relationships within the environments are explored. Community resources and child advocacy efforts are examined.

ECED 115 Indiana Youth Development (IYD) Process**3 Credits**

Prerequisites: Program Chair approval. Prepares the student for the verification process for the Indiana Youth Development Credential (IYD). Students are provided opportunities for practical experience through supervised participation in programs for school age and youth educational settings.

ECED 120 Child Growth and Development**3 Credits**

Prerequisites: Demonstrated competency through appropriate assessment or earning a grade of "C" or better in ENGL 025 and ENGL 032. Studies the physical, social, emotional, cognitive, and moral development of children from conception to age twelve. Theories of child development, biological and environmental foundations, prenatal development, the birth process, and the newborn baby are discussed. Influences of family, community, media, and culture are considered.

ECED 130 Developmentally Appropriate Guidance in a Cultural Context**3 Credits**

Prerequisites: Demonstrated competency through appropriate assessment or earning a grade of "C" or better in ENGL 025 and ENGL 032. Analyzes developmentally appropriate guidance, theory and implementation for various early care and education settings. Provide a basic understanding of the anti-bias/multicultural emphasis in the field of early childhood.

ECED 200 Family-Teacher Partnerships**3 Credits**

Prerequisites: Demonstrated competency through appropriate assessment or earning a grade of "C" or better in ENGL 025 and ENGL 032. Examines the family-teacher partnership, recognizing the need to work as a team to enhance the child's development. Promotes awareness of the family as the child's first teacher, foundation, and framework for culture, language, attitudes, and values. Provides the

structure for creating practices that establish active family participation. Explores issues and resources for families.

ECED 201 Skills for Parenting**3 Credits**

Prerequisites: Demonstrated competency through appropriate assessment or earning a grade of "C" or better in ENGL 025 and ENGL 032. Focuses on skill development in parents that provides knowledge regarding healthy development in young children, building self-esteem, communicating with young children, setting appropriate boundaries and nurturing emotional and social development in children. Examines models of parent education, parenting styles, and the need for parent empowerment. Analyzes the effects of parent involvement in children's educational experiences.

ECED 204 Families in Transition**3 Credits**

Prerequisites: ENGL 111 and SOCI 111. Examines the stages of the family life cycle and interpersonal relationships among family members. Recognizes the impact of context and culture on the family's ability to function.

ECED 205 Early Care Practicum**3 Credits**

Prerequisites: Program Chair Approval. Provides opportunity for practical experience through observation and supervised participation in childcare settings. This practicum offers experiences with ages infant through school age and requires 144 hours of field experience in an approved early care setting.

ECED 210 Early Childhood Administration**3 Credits**

Prerequisites: ECED 100, ECED 120, ENGL 111 and demonstrated competency through appropriate assessment or earning a grade of "C" or better in MAT 050. Introduces principles of managing an early care and education program; emphasizes the role of the manager to include personnel and program administration and fiscal management. Explores client-community relations.

ECED 213 Infant and Toddler Programming**3 Credits**

Prerequisites: ECED 110 or ECED 120. Studies the program planning and operation for quality infant and toddler care and education. The students examine the teacher's role in establishing positive and productive relationships with families. Exploration of essential skills and dispositions in managing an effective program are considered. The students will broaden their knowledge base of appropriate instructional strategies to enhance infant/toddler development. Students will develop activities to enhance the physical, social, emotional and cognitive development of the child, 0-36 months. Students will complete observations and field experiences with children of this age.

ECED 215 The Business of Child Care**3 Credits**

Prerequisites: ECED 100, ECED 101, ECED 103, ECED 105, demonstrated competency through appropriate assessment or earning a grade of "C" or better in ENGL 024 and ENGL 031. An introduction to the principles of child care management, emphasizing the role of the

business manager including personnel and program administration and fiscal management. Explores the concept of starting your own child care business including determining the need, client-community relations and marketing strategies.

ECED 216 Curriculum Planning For Early Childhood Administrators 3 Credits

Prerequisites: ENGL 111, demonstrated competency through appropriate assessment or earning a grade of "C" or better in MATH 050 and 18 credit hours of ECED coursework. Overview of cognitive and creative curriculum from a developmentally appropriate perspective. Examines early childhood curriculum models with an emphasis on planning and evaluating curriculum to meet the comprehensive needs of the young child. Course places emphasis on staff and family involvement in curriculum planning, implementation, and assessment.

ECED 218 Leadership and Mentoring in Early Childhood 3 Credits

Prerequisites: ENGL 111, 9 credit hours of Early Childhood Education coursework and Program Chair Approval. A basic introduction to the concept of leadership. Includes theories of leadership and teamwork and provides an opportunity for students to present a workshop to Early Childhood professional and to establish a relationship with a protégé.

ECED 220 Adolescent Growth and Development 3 Credits

Prerequisites: Demonstrated competency through appropriate assessment or earning a grade of "C" or better in ENGL 025 and ENGL 032. Examines the physical, social, emotional, cognitive, and moral development of the child age eight through adolescence. Influences of family, school, peers, community, media, and cultures are discussed. Issues such as health, puberty, school issues, peers and youth culture, and personal, including substance abuse, eating disorders, pregnancy, depression, and suicide is considered.

ECED 223 School Age Programming 3 Credits

Prerequisites: None. Examines environments, materials, methods and teaching styles for providing creative experiences for the school age child. Offers appropriate experiences in music, movement, art and drama as well as methods to assist students in identification and pursuit of specific personal interest areas in a school age child care setting. Review theories of adolescent growth and development, establishment of partnerships with families and positive guidance techniques for school age children.

ECED 225 Infant Toddler Practicum 3 Credits

Prerequisites: Program Chair Approval. Provides opportunity for practical experiences through observation, assessment and supervised participation in an infant/toddler setting. Students develop,

implement and assess appropriate environments and activities for children 6-36 weeks. Requires 144 hours of field experience.

ECED 230 The Exceptional Child 3 Credits

Prerequisites: ECED 120 and ENGL 111. Provides an introduction to caring for each exceptional child. Includes theories and practices for producing optimal developmental growth. Develops teaching techniques and explores public policy including legislative mandates. Explores the types of special needs and provides methods for assistance.

ECED 233 Emerging Literacy 3 Credits

Prerequisites: ECED 103 and ENGL 111. Provides for understanding of the development of children's language arts behaviors, concepts, and skills that precede and can develop into literacy, which includes reading and writing skills. Provides understanding and skills on how the acquisition of language for young children develops into optimum literacy growth through the materials and the environments that are provided for the young children. Students will explore and evaluate literature for young children. The course introduces technology materials and techniques, which are utilized in early childhood programs. In the course the students will research, examine and evaluate various screening and assessment tools related to literacy in the early childhood.

ECED 235 Preschool Practicum 3 Credits

Prerequisites: Program Chair Approval. Provides opportunity for practical experience through observation and supervised participation in early care and education setting with children ages 3-5. Students will develop and implement developmentally appropriate environments and activities.

ECED 240 Introduction to Care in the Home 3 Credits

Prerequisites: None. Examines environments, materials, methods and teaching styles appropriate to child care in the home. Offers appropriate experiences in all curricular areas as well as suggestions for designing and operating a program that serves all ages. Reviews theories of growth and development, establishment of partnerships with families and positive guidance techniques for infants and children from birth through age twelve. Reviews Indiana family child care licensing regulations.

ECED 243 Cognitive Curriculum 3 Credits

Prerequisites: ECED 103, ECED 120 and demonstrated competency through appropriate assessment or earning a grade of "C" or better in MATH 050. Review cognitive theories of development in relation to the domains of early learning. Analyze appropriate problem solving, math, science, and social studies curriculum in early childhood settings. Create and implement curriculum in the domains of early learning with appropriate child outcomes assessment. Reflect upon implementation of activities and assessment with children.

ECED 245 School Age Practicum 3 Credits

Prerequisites: Program Chair Approval. Provides opportunities for practical experience through observation and supervised participation and assessment in a school-age setting. Students will develop and implement appropriate environments and activities. Requires 144 hours of field experience.

ECED 255 Generalist Practicum 3 Credits

Prerequisites: Program Chair Approval. Provides opportunity for practical experience through observation and supervised participation and assessments in an early childhood setting. Students will develop and implement appropriate program plans and activities. Requires 144 hours of field experience.

ECED 260 Early Childhood Professional 3 Credits

Prerequisites: Program Chair Approval. Surveys and further examines early childhood philosophies, theories and theories. Encourages students to form their own theories for learning, discipline, family involvement, and self-concept development. Guides students in the development of a professional graduation portfolio. This is a capstone course and requires program chair approval.

ECHO 101 Introduction to Echocardiography 3 Credits

Prerequisites: Demonstrated competency through appropriate assessment or earning a grade of "C" or better in MATH 050, MATH 070 or MATH 080, APHY 102, ENGL 111 and Advisor Approval. This course focuses on cardiac anatomy, circulatory pathway, blood flow diagrams, cardiac pressures, cardiac murmurs, basic ECG concepts and chest roentgenography. Includes discussion of essential modes of echocardiography such as 2D, M-mode, Doppler, color flow Doppler and related hemodynamic calculations. Course emphasizes identification and description of normal cardiac structures in selected media including graphic illustrations, anatomic models, and ultrasound images.

ECHO 102 Adult Echocardiography I 3 Credits

Prerequisites: Demonstrated competency through appropriate assessment or earning a grade of "C" or better in MATH 050, MATH 070 or MATH 080, APHY 102, ENGL 111 and Advisor Approval. Course emphasis on techniques utilized to perform a segmental adult echocardiogram, including explanation and practice in standard imaging planes and positions. Reviews normal cardiac anatomy for application in interpretation and categorizing basic cardiac pathophysiology.

ECHO 103 Cardiac Physics and Instrumentation I 3 Credits

Prerequisites: Demonstrated competency through appropriate assessment or earning a grade of "C" or better in MATH 050, MATH 070 or MATH 080, APHY 102, ENGL 111 and Advisor Approval. This course presents required Doppler principles modeled after the

American Registry of Diagnostic Medical Sonographers (ARDMS) guidelines. Topics include history, principles, flow measurements, and signal processing of Doppler diagnostics. Selected topics include machine instrumentation, elements of a transducer, routine Doppler examination and sound wave properties.

ECHO 104 Echocardiography Clinical I **5 Credits**

Prerequisites: Demonstrated competency through appropriate assessment or earning a grade of "C" or better in MATH 050, MATH 070 or MATH 080. APHY 102, ENGL 111 and Advisor Approval. Current CPR AHA Health Care Provider or equivalent; additional documentation for clinical affiliates as required. Provides practice in a clinical echocardiography laboratory setting. Learning environments will include clinical care, emergency room, surgery, and cardiac telemetry units. Emphasis will be performance of adult echocardiograms with a trained cardiac sonographer, including essential patient care functions. Students will observe transesophageal, stress and contrast echocardiograms. Course includes required hospital orientation and 2 day electrocardiography course. Additional class fee for ECG course will apply.

ECHO 201 Advanced Professional Growth and Development **3 Credits**

Prerequisites: ECHO 101, ECHO102, ECHO 103, and ECHO 104. This course presents the role of the professional sonographer, including typical day-to-day responsibilities. Topics include maintaining proper scanning positions, lab setup, quality assurance, charging, ethics, patient confidentiality, safety and the significance of the team concept in contemporary healthcare settings. Capstone project emphasizes the essential role of life-long learning.

ECHO 202 Adult Echocardiography II **3 Credits**

Prerequisite: ECHO 102. This course is a continuation of Adult Echocardiography I discussing pathophysiology commonly seen in the adult heart, including post operative findings such as prosthetic valves and heart transplantations, pacemaker wires, internal defibrillator wires, and central lines. Selected topics include identification and significance of tumors, missiles, myxomas, masses, contrast agents, and adult congenital heart diseases. Advanced ultrasound modalities such as 3D echocardiography, cardiac resynchronization therapy, and atrial septal defect closure devices will be discussed.

ECHO 203 Cardiac Physics and Instrumentation II **3 Credits**

Prerequisite: ECHO 103. This course is a continuation of Cardiac Physics and Instrumentation I, emphasizing instrumentation variables, artifacts, and bioeffects.

ECHO 204 Echocardiography Clinical II **5 Credits**

Prerequisite: ECHO 104. Provides additional supervised experience focused on development of skills to competently perform echocar-

diography procedures in adult patients, and assist cardiologists in various clinical environments. Rotations through other departments will include ECG, Cardiopulmonary Rehabilitation, Cath Lab, and the Operating Room for observation of selected cardiac surgical procedures. Observation and interaction with cardiologists during interpretation and dictation of echocardiograms is included. Continuing certification in CPR is required.

ECON 101 Economics Fundamentals **Transferlin 3 Credits**

Prerequisites: Demonstrated competency through appropriate assessment or earning a grade of "C" or better in ENGL 025, ENGL 032 and MATH 050 or MATH 080. Provides a survey of microeconomics, macroeconomics, international economics, comparative economic systems, historical development of economic thought, and their application to current economic problems. An introductory course intended primarily for students who need only one semester of economics.

ECON 201 Principles of Macroeconomics **Transferlin 3 Credits**

Prerequisites: ENGL 111 and demonstrated competency through appropriate assessment or earning a grade of "C" or better in MATH 050 or MATH 080. A descriptive and analytical study of fundamental concepts of national economics. It includes an analysis of the determination and fluctuations in national income and employment, monetary and fiscal policy, and international trade and finance. Economic analysis of monetary and fiscal policies is stressed.

ECON 202 Principles of Microeconomics **Transferlin 3 Credits**

Prerequisites: ENGL 111 and demonstrated competency through appropriate assessment or earning a grade of "C" or better in MATH 050 or MATH 080. A descriptive and analytical study of the market economy and how it allocates resources. Emphasis is placed on consumer behavior, market structure, pricing, and distribution and determination of wealth and income.

EDUC 101 Introduction to Teaching **3 Credits**

Prerequisites: Demonstrated competency through appropriate assessment or earning a grade of "C" or better in ENGL 025, ENGL 032 and MATH 044. An introductory course which provides a general introduction to the field of teaching. Students will explore educational careers, teaching preparation and professional expectations as well as requirements for teacher certification. Current trends and issues in education will be examined. A 20 hour supervised observational experience component is required for successful completion of this course.

EDUC 103 Personal Health **3 Credits**

Prerequisites: Demonstrated competency through appropriate assessment or earning a grade of "C" or better in ENGL 025 and ENGL 032. Introduces prospective teachers to the health issues children

face. This course includes approaches to health appraisal, intervention strategies, and follow-up to health care issues for children. Special emphasis is placed on the physiological and psychological issues for children's health presented by AIDS, substance abuse, child abuse, eating disorders, suicide, and violence in the schools.

EDUC 104 Movement for Children **2 Credits**

Prerequisites: None. Introduces principles of developmentally appropriate movement programs for elementary students.

EDUC 111 Spanish for Classroom Teachers I **4 Credits**

Prerequisite: None. Develops communication skills in the Spanish language and prepares future teachers for Spanish-only interactions with Spanish-speaking ESL students and their families. Knowledge of the language is gained through vocabulary and grammar instruction. Acquisition of the language takes place in meaningful contextualized classroom-oriented activities. Class time is divided between these two major components.

EDUC 112 Spanish for Classroom Teachers II **4 Credits**

Prerequisite: EDUC 111. Develops intermediate communication skills in the Spanish language and prepares future teachers for Spanish-only interactions with Spanish-speaking ESL students and their parents. Knowledge of the language is gained through continued vocabulary and grammar instruction. Acquisition of the language takes place in meaningful contextualized classroom-oriented activities. Class time is divided equally between these two components.

EDUC 121 Child and Adolescent Development **3 Credits**

Prerequisites: Demonstrated competency through appropriate assessment or earning a grade of "C" or better in ENGL 025 and ENGL 032. Examines the physical, social, emotional, cognitive, and moral development of the child/birth through adolescence with a focus on the middle years through adolescence. Basic theories of child development, biological and environmental foundations of development, and the study of children through observation and interviewing techniques are explored. The influence of parents, peers, the school environment, culture and the media are discussed. Up to 10 hours of observation/service learning may be required.

EDUC 130 Introduction to Multicultural Teaching **3 Credits**

Prerequisites: EDUC 101, ENGL 111 and demonstrated competency through appropriate assessment or a grade of "C" or higher in MATH 050. This course examines social and cultural conditions that influence education. The purpose is to assist students in understanding diversity and how to use this knowledge effectively within the schools and community. The course pursues an in-depth study of self, familial cultural heritage, and awareness of cultural differences. The course examines inclusive methods of teaching.

EDUC 156 Transition to Baccalaureate Education **1 Credit**

Prerequisites: None. This course is designed to prepare the student to

fulfill requirements of the education profession, working with children in both instructional and non-instructional settings. The requirements of the teaching profession will be addressed. Appropriate completion of such requirements will be attained as skill development focuses on preparation for professional entrance exams and for transition to a Baccalaureate Degree program.

EDUC 200 Education and the Community 3 Credits

Prerequisites: EDUC 101 and SOCI 111. Focuses on the community, school, and family partnerships, including curriculum, philosophies, and partner's role in these areas. The course promotes awareness of families as the children's first teacher, as well as culture, values, language, and attitudes. Addresses ways to design and deliver parent teacher conferences, parent education, and parent involvement in schools and community.

EDUC 201 Using Computers in Education 3 Credits

Prerequisites: EDUC 101. Introduction to instructional computing and educational computing literature. Provides hands-on experience with educational software, utility packages, and commonly used microcomputer hardware.

EDUC 224 Introduction to Scientific Inquiry 3 Credits

Prerequisites: EDUC 101 and ENGL 111. Provides the education major with background in the science process skills. Students will explore science through active participation and reflect on content, skills, and dispositions as a member of a learning community. Students will learn how to ask inquiry questions related to the natural world, plan investigations and formulate explanations.

EDUC 230 The Exceptional Child 3 Credits

Prerequisite: EDUC 101 or Program Chair Approval. Provides an introduction to caring for the exceptional child. Includes theories and practices for producing optimal developmental growth. Develops teaching techniques. Explores public policy, inclusion, early intervention, and IEP's (laws). Explores the types of special needs and provides opportunities through field experience to practice methods for helping children within special education and gifted/talented programs. Up to 20 hours of observation/service learning may be required.

EDUC 240 Introduction to Physical and Health Education for Elementary Teachers 3 Credits

Prerequisite: EDUC 101. This course provides the elementary education major with a foundation in physical and health education. Knowledge and skills for planning and implementing health and physical education curriculum to promote physical fitness and healthy living for children Pre-K through 6th grade will be covered in the course. An observational experience is required for successful completion of this course.

EDUC 241 Math Methods for Early/Middle Childhood Classrooms 3 Credits

Prerequisite: Math 111. This methods course, for early childhood

and elementary education teachers, focuses on understanding and application of developmentally appropriate math environments and activities for children from early childhood through elementary school. A thorough understanding of the developmental sequence of acquisition of math concepts and skills, as well as, application and assessment of the standards developed by both the NAEYC and NCTM are the foundation of this course.

EDUC 250 Educational Psychology 3 Credits

Prerequisites: EDUC 101 and PSYC 101. Focuses on the study and application of psychological concepts and principles as related to the teaching-learning process. Topics covered include educational research methods, cognitive and language development, personal, social, and moral development, behavioral learning, motivation, effective teaching, and measurement and evaluation. Up to 20 hours of observation/service learning may be required.

EDUC 261 Practicum 3 Credits

Prerequisites: Program Chair Approval. Provides opportunities for practical experience through observation and supervised participation and assessment in a school-age setting. Students will develop and implement appropriate environments and activities. Requires 144 hours of field experience.

EDUC 270 Contemporary Issues in Education 3 Credits

Prerequisites: Program Chair Approval. Surveys and further examines educational philosophies, theories and theorists. Encourages students to form their own theories for learning, discipline, family involvement and self-concept development. Guides students in the development of a professional graduation portfolio. This is a capstone course and requires program chair approval.

EECT 101 Introduction to Electronics and Projects 3 Credits

Prerequisites: None. The material will concentrate on the physical world of electricity and electronics. Practical techniques for proper and safe use of basic hand and machine tools are introduced. Techniques for connecting various types of circuits are also covered. The process of fabricating printed circuit boards is presented. Communication skills are utilized to report project progress and results.

EECT 103 Soldering 1 Credit

Prerequisites: None. Students practice and develop skills soldering and desoldering through-hole and surface mount components. Students will use and maintain commercial grade solder/desolder stations. Also students will be introduced to basic fabrication techniques.

EECT 105 Introduction to National Electrical Code 3 Credits

Prerequisites: None. Introduces the role and use of the National

Electrical Code Book. Provides an overview of interpretation, calculations, and revisions of the codebook.

EECT 107 - Introduction to Home Automation Technology 3 Credits

Prerequisites: None. An introduction to the installation and troubleshooting of home automated systems like home security, audio/video, computer networks, electrical wiring, cable and satellite systems.

EECT 111 Introduction to Circuits Analysis 4 Credits

Prerequisites: MATH 111. Voltage, current, resistance, Ohm's law, Kirchhoff's laws, resistance combinations, and Thevenin's, Norton's, and superposition theorems are studied. DC and AC circuits are studied and utilized with basic AC terminology described. The performance of ideal transformers, capacitors and inductors, and first order RLC circuits are investigated. Fundamental analog electronic circuits are utilized in the lecture and laboratory to enhance the understanding of basic laws and theorems.

EECT 112 Digital Fundamentals 3 Credits

Prerequisites: Demonstrated competency through appropriate assessment or earning a grade of "C" or better in MATH 050. Introduces basic gate and flip-flop logic devices and their application in combinational and sequential digital circuits. Topics include decoders, displays, encoders, multiplexers, demultiplexers, registers, and counters. Logic circuit analysis, implementation of circuits using standard IC chips or programmable logic devices, circuit testing and troubleshooting are emphasized.

EECT 115 Home Technology Integration 3 Credits

Prerequisites: EECT 107. Provides the student with an in-depth understanding and knowledge required for the installation and troubleshooting of home integration and security systems including HVAC systems, water systems, video/audio surveillance, and computer networks to prepare for the Home Technology Integration (HTI) certification exam.

EECT 119 Introduction to Lasers 3 Credits

Prerequisites: MATH 131 or MATH 134 or MATH 137. Introduces laser action, laser beam characteristics, types of lasers, safety considerations, general laser applications, laser and optical equipment. Teaches basics of laser systems and prepares beginning laser students for future courses. Includes an overview of lasers, physical basics, how lasers work, laser characteristics, laser accessories, gas lasers, solid-state lasers, semiconductor lasers, and other types of lasers. It also includes a brief overview of low-power laser and high-power applications.

EECT 121 Electronics Circuits Analysis 4 Credits

Prerequisites: EECT 111. Capacitors, inductors, switching circuits, transformers, rectifiers, linear regulators, dependent sources, opera-

tional amplifiers, BJT and MOSFET based small signal amplifiers, waveform generation, and programmable analog devices are studied. Circuit fundamentals such as Kirchhoff's laws are utilized in analysis and design circuits. Computer simulation is used.

EECT 122 Digital Applications 4 Credits

Prerequisites: EECT 112. This course continues the study of combinational and sequential digital applications. The input and output characteristics of the various common logic families and the appropriate signal conditioning techniques for on/off power interfacing are discussed. Also stressed are standard logic function blocks, digital and analog signal interfacing techniques, and memory devices.

EECT 127 Industrial Electronics 3 Credits

Prerequisites: EECT 126. Presents an overview of electronics in the industrial setting. Instruct students in how electronics is applied to industrial systems. Introduces power machines, polyphase systems, solid-state controls, transducers and industrial computer systems.

EECT 128 Introduction to C Programming 3 Credits

Prerequisites: Demonstrated competency through appropriate assessment or earning a grade of "C" or better in MATH 050. An introduction to the "C" programming language. No programming experience is needed. After completing this course, the students will have a good understanding of programming concepts and terminology and should be able to pick up another programming language if interested. The course is designed to prepare students to use C to solve technical and engineering problems such as programming microprocessors.

EECT 130 Fiber Optics 3 Credits

Prerequisites: EECT 122. Presents overview of fiber optics. Studies uses for fiber optics, advantages, cable details, connectors, splices, sources, detectors and fiber optic systems.

EECT 140 Networking 3 Credits

Prerequisites: Demonstrated competency through appropriate assessment or earning a grade of "C" or better in ENGL 025 and ENGL 032 and MATH 050. Study of types of protocols used in data communication systems. Includes an overview of networking, networking control, and interfacing. Areas of emphasis includes protocols, packet switching systems, local area networks, and the OSI model.

EECT 209 Industrial Computer Control 3 Credits

Prerequisite: EECT 101 or equivalent. **Corequisite:** EECT 112 or equivalent. An introduction to the field of industrial controls as it relates to a computer control systems, process control and industrial networking. Covers the principles of control systems as applied to a production system to achieve automation. PLCs will be covered as the mainstay of industrial computer control. Troubleshooting of production control systems are covered.

EECT 211 AC Circuit Analysis 4 Credits

Prerequisites: EECT 121 and MATH 131 or MATH 134 or MATH 137. AC circuits, including the j operator, phasors, reactance, and impedance are studied. Circuit laws, network theorems, and the fundamental concepts of Fourier analysis are applied and used in the study of topics such as passive filters, IC filters, amplifiers, resonant circuits, single phase and three phase circuits. Computer aided analysis of circuits is used.

EECT 213 Introduction to Industrial Controls 3 Credits

Prerequisites: EECT 221 and EECT 223. Studies basics of controls related to industrial electronics. Includes basic and pilot control devices such as circuit layouts, industrial schematics, reduced voltage starters, multispeed controllers, and solid-state controls. Covers transformer hookups and circuit protection.

EECT 214 Industrial Instrumentation 3 Credits

Prerequisites: EECT 126. Provides a system view of manufacturing and automated production emphasizing the devices used in control and measurements. Areas covered include pressure, strain, force, flow, and level considerations. Principles of process control are introduced, incorporating the usage of probes, sensors, transducers, and various final control devices. Computer software, hardware, and interfacing are examined in regards to data acquisition, manufacturing control, and summarization of industrial data.

EECT 219 Biomedical Electronics I 3 Credits

Prerequisites: APHY 101 or BIOL 100 and HLHS 101 and EECT 126. Offers study of medical electronics equipment, including ECG, EEG, defibrillators, heart monitors and other monitoring and respiratory equipment.

EECT 220 Biomedical Electronics II 3 Credits

Prerequisites: EECT 219. Studies medical support systems including X-ray equipment, respirators and analyzers, and their maintenance. Studies medical ultrasound, electro surgery units and mechanical recorders. Prepares students for licensing and certification.

EECT 221 Solid State 3 Credits

Prerequisites: EECT 121. Continues the study of bipolar transistors with additional circuit configurations including the emitter follower and the Darlington. Studies power amplifiers, amplifier classifications, unipolar transistors, and thyristors. Includes discrete FETs, SCRs, UJTs, oscillators, linear regulated power supplies, and switching regulators. Discusses frequency effects and response of amplifiers.

EECT 222 Introduction to Microcontrollers 4 Credits

Prerequisites: EECT 122 and EECT 128. An introduction to microcontroller hardware and software, focusing on embedded control applications. Interconnections of components, peripheral devices, bus timing relationships, structured C-language programming, debug-

ging, input/output techniques, and use of PC-based software development tools are studied.

EECT 223 Electrical Machines 3 Credits

Prerequisites: EECT 111. Provides an overview of electrical machines and how they relate to industrial electronics. Gives industrial electronics technicians insight into electrical power generation, polyphase system, transformers, all types of electrical motors, power factor and power factor correction, back-up power and electrical power monitoring.

EECT 224 Peripherals 3 Credits

Prerequisites: EECT 112. Studies peripherals commonly used with computers and microcomputers and the interfacing with those peripherals. Includes printers, scanners, modems, NICs, video adapters and displays, keyboards and mouse, sound systems, and CD-ROM and DVDROM drives. Also includes a study of data communications hardware and techniques. Studies techniques for logical troubleshooting of microcomputer systems.

EECT 226 Computer Troubleshooting 3 Credits

Prerequisites: EECT 112. A study of techniques for logical troubleshooting of microcomputer systems. Emphasizes basic system components including power supplies, motherboards, memory, floppy and hard disk drives, operation of video displays, and keyboard and mouse connections. Emphasizes system-oriented troubleshooting procedures.

EECT 228 Communications Electronics 3 Credits

Prerequisites: EECT 121. Analyzes communication circuits with emphasis on AM, FM, SSB, transmitters and receivers, transmission lines, antennas, and wave propagation. Includes dB gain and attenuation, noise, modulation and demodulation principles, phase-locked loop, RF amplifiers, automatic gain control, detectors, limiters and discriminators. Offers hands-on lab exposure to analog circuits utilizing analysis and troubleshooting techniques.

EECT 229 Telecommunications 3 Credits

Prerequisites: EECT 112. Presents an in-depth view of the telecommunication industry from the very beginning to today's cellular, Internet, and broadband technologies. Examines various methods in transmitting digital data from one location to another. Covers transmission medias, time and frequency multiplexing, modulation applications, routing networks, communications hardware, protocols, telephone networks, and Internet systems. Cellular, cable broadband, and emerging technologies are also introduced.

EECT 230 Advanced Communications Electronics 3 Credits

Prerequisites: EECT 228. The basics of antenna principles and wave propagation together with an in-depth study of matching techniques for transmission lines. Includes the Smith Chart and a thor-

ough study of television operation. Radiation patterns will be measure with different antenna arrays. Signal tracing troubleshooting techniques will be practiced on a color TV set.

EECT 233 Industrial Motors and Controls 3 Credits

Prerequisites: EECT 111. Provides a complete understanding of basic ladder and wiring diagrams used in the control of electric motors. Includes the various electrical components and their functions as applied to motor controls. Topics include the various types of motors used in applying electro-mechanical power, ranging from small AC shaded-pole fan motors through larger three-phase motors. Motor starting components, protective devices, heat dissipation, motor slipage and frequency and multiplex motors are discussed. Lab assignments allow the student a hands-on approach to wiring various control components in the operation of three-phase motors.

EECT 235 Process Control 3 Credits

Prerequisites: EECT 121. Presents an in-depth view of process control theory and applications. Topics covered are open and closed loop systems, feedback concepts, signal conditioning, standards and terminology, controller principles and loop characteristics. Concepts of thermal, mechanical, optical sensor devices are emphasized as measurement control. Transducers and final control actuators are examined.

EECT 237 Calibration 3 Credits

Prerequisites: EECT 121. Provides an introductory overview of procedural calibration for instruments (electronic and pneumatic) found in today's controlling environments and industry. Instrument evaluation, installation, and calibration are the emphasis for this course. Dismantling and calibration of DP cells, gauges, valve positioners, thermocouple circuits, control elements, and other industrial instruments are incorporated throughout the course.

EECT 238 Process Instrumentation 3 Credits

Prerequisites: EECT 121. Presents the concepts and fundamentals of measurement instrumentation and its application to industrial process control. Introduces basic device symbols and instrumentation terminology. Includes measurement principles and techniques involving temperature, pressure, flow, level, displacement, strain, load, torque, vibration, humidity, density/specific gravity, gas analysis, and conductivity. Discusses open versus closed loop control and the application of combinations of proportional, integral, and derivative control methods. Includes chart.

EECT 279 Advanced Problem Solving 3 Credits

Prerequisites: EECT 121 and EECT 122. Introduces logical troubleshooting of electronic circuits and systems with emphasis on systematic diagnostic methods and technical reference research. Provides further experience in the use of test equipment and proper repair techniques. Includes job preparedness skills and preparation for appropriate certification testing.

EECT 280 Co-Op/Internship 3 Credits

Prerequisite: Program Advisor Approval. Gives students the opportunity to work at a job site that is specifically related to their career objectives. Provides on-the-job experience while earning credit towards an associate's degree.

EECT 221 Electrical Power and Controls 4 Credits

Prerequisite: EECT 121 and PHYS 101. The introduction of magnetic materials is followed by analysis of transformers and power conditioning equipment. Also covered are induction motors and single phase and three-phase systems. Motor control devices, programmable logic controllers, PLC input and output devices, and power systems communications and monitoring are introduced.

EECT 223 Power and RF Communications 4 Credits

Prerequisite: EECT 121 and MATH 221. This course is a study of the application of circuit analysis techniques to amplifiers used in power and RF electronics, including bipolar junction transistors, power MOSFETs, thyristors, RF amplifiers, phase lock loops, switching power supplies, and appropriate applications. Computer-aided analysis of circuits is used.

EECT 225 Electronic Prototype Development 4 Credits

Prerequisite: EECT 101 and EECT 122. Basic concepts in the development of an electronic prototype are covered. The student utilizes electronic design automation, design for testing, surface mount technology, design for manufacturability, component characteristic selection techniques, and basic failure predictions. The final prototype is presented in a written and/or oral report.

ENGL 001 Elementary English for Speakers of Other Languages 3 Credits

Prerequisites: Demonstrated ability to write and understand simple statements and questions on familiar topics. The suggested range on the English Placement Test is 20-35. Emphasizes writing elementary statements, reading and understanding elementary materials, and expanding competence in speaking and listening.

ENGL 002 Intermediate English for Speakers of Other Languages 3 Credits

Prerequisites: Demonstrated intermediate competency in English with ability to read, write, and speak using basic language skills. The suggested range on the English Placement Test is 36-52. Emphasizes writing, reading and speaking with increasing competence in academic and social situations.

ENGL 003 Pre-academic English for Speakers of Other Languages 3 Credits

Prerequisites: Demonstrated fair control of most sentence structure, expository materials, statement, and conversation in social and academic settings. The suggested range on the English Placement Test

is 53-68. Emphasizes paragraph organization, reading and understanding expository and academic materials through vocabulary development. Develops comprehension of social and academic conventions and lectures.

ENGL 004 Academic English for Speakers of Other Languages 3 Credits

Prerequisites: Demonstrated ability to write with some ease, understand expository and academic reading material, understand lectures, and converse in academic and social situations. The suggested range on the English Placement Test is 69-83. Emphasizes expository writing, finding main ideas and details in academic texts, and understanding and speaking in academic settings.

ENGL 007 Spelling 1 Credit

Prerequisites: None. Improves basic spelling competencies through practice and attention to spelling rules and exceptions.

ENGL 010 English for Speakers of Other Languages—Reading I 3 Credits

Prerequisites: CASAS/IRCA Pre-enrollment Appraisal. Develops basic reading skills in English using texts on subjects relating to life skills and cultural values. Emphasizes vocabulary acquisition, dictionary use, and reading strategies for basic comprehension and interpretation.

ENGL 011 English for Speakers of Other Languages—Reading II 3 Credits

Prerequisites: None. Stresses comprehension skills and reading strategies using materials which focus on personal and cultural values. Focuses on vocabulary expansion, comprehension and interpretation strategies, and experience with a variety of reading styles. Provides practice in increased reading proficiency.

ENGL 012 English for Speakers of Other Languages—Reading III 3 Credits

Prerequisites: None. Stresses comprehension skills and reading strategies with academic materials. Focuses on vocabulary expansion, transitional development, and critical analysis of academic writing. Provides practice in increased reading proficiency.

ENGL 013 English for Speakers of Other Languages—Listening/Speaking I 3 Credits

Prerequisites: CASAS/IRCA Pre-enrollment Appraisal. Focuses on listening and speaking strategies for comprehensible input. Provides practice recognizing and producing speech patterns of American English. Allows for conversational practice on topics of cultural values and behaviors.

ENGL 014 English for Speakers of Other Languages—Listening/Speaking II 3 Credits

Prerequisites: Level I ESL Listening/Speaking Mastery. Provides prac-

time in recognizing and producing speech patterns of American English. Allows for conversational practice with emphasis on cross-cultural values and behaviors and the use of idioms.

ENGL 015 English for Speakers of Other Languages-Listening/Speaking III **3 Credits**

Prerequisites: Level II ESL Listening/Speaking Mastery. Provides experience in recognizing and producing speech patterns of American English. Allows for conversational practice relating to academic and cultural subjects, with an emphasis on critical thinking skills expressed verbally. Gives the student ample exposure to language use from sources both in and out of the classroom. Language tasks which require problem solving by interpersonal communications.

ENGL 016 English for Speakers of Other Languages – Grammar/Structure I **3 Credits**

Prerequisites: CASAS/IRCA Pre-enrollment Appraisal. Focuses on the acquisition of basic patterns of structure and syntax for controlled communication. Emphasizes form, meaning, and use of basic structures in American English. Provides practice through extensive and varied communicative activities.

ENGL 017 English for Speakers of Other Languages – Grammar/Structure II **3 Credits**

Prerequisites: Level I ESL Grammar/Structure Mastery. Focuses on the study and acquisition of patterns of advanced structure and syntax. Emphasizes the acquisition of sentence structure for verbal and written communication of ideas and their relationship.

ENGL 018 English for Speakers of Other Languages-Grammar/Structure III **3 Credits**

Prerequisites: ENGL 017. Focuses on the acquisition of more advanced patterns of structure and syntax. Emphasizes the development of competent verbal and written expression in critical analysis for academic purposes.

ENGL 019 English for Speakers of Other Languages – Writing I **3 Credits**

Prerequisites: CASAS/IRCA Pre-enrollment Appraisal. Focuses on conventions for basic written communication in English, emphasizing sentence construction and paragraph development. Uses writing strategies to produce coherent expression in journals, free writing exercises, paraphrasing, and short essays. Student collaboration is part of the learned writing process.

ENGL 020 English for Speakers of Other Languages – Writing II **3 Credits**

Prerequisites: Level I ESL Writing Mastery. Focuses on techniques of written communication for coherent expression of ideas, through paragraph development and essay writing. Emphasizes the writing process using strategies for pre-writing, development, and revision

through peer collaboration. Highlights the structure and syntax of written expression for effective communication

ENGL 021 English for Speakers of Other Languages – Writing III **3 Credits**

Prerequisites: Level II ESL Writing Mastery. Focuses on techniques of written communication for the analysis and elaboration of academic material through paragraph and essay writing. Emphasizes the strategies of the writing process through rhetorical modes of composition for varied purposes. Stresses the extended use of syntax and structure for thoroughly coherent expression.

ENGL 024 Introduction to College Writing I **3 Credits**

Prerequisites: Demonstrated competency through appropriate assessment. Enables the beginning college writer to develop control of the writing process by focusing on paragraph development. Requires students to demonstrate proficiency in basic standard writing conventions, including grammar and mechanics. Prepares students for entry into ENGL 025.

ENGL 025 Introduction to College Writing II **3 Credits**

Prerequisites: Demonstrated competency through appropriate assessment or earning a grade of "C" or better in ENGL 024. Builds on the competencies learned in ENGL 024 and prepares students for entry into college level composition by focusing on essay development. Enables beginning college writers to expand control of the writing process. Requires students to demonstrate increased proficiency in the use of standard writing conventions. Introduces the processes of research and documentation.

ENGL 028 Vocabulary Building **1 Credit**

Prerequisites: None. Focuses on developing general English vocabulary. Includes dictionary skills, context skill and word structure analysis.

ENGL 031 Reading Strategies for College I **3 Credits**

Prerequisites: Demonstrated competency through appropriate assessment. Increases performance in reading flexibility, vocabulary, and comprehension. Introduces critical reading skills and study strategies and their applications.

ENGL 032 Reading Strategies for College II **3 Credits**

Prerequisites: Demonstrated competency through appropriate assessment or earning a grade of "C" or better in ENGL 031. Advances performance in reading flexibility, vocabulary, and comprehension. Emphasizes critical reading and strategies for effective study of college level text.

ENGL 111 English Composition **TransferN 3 Credits**

Prerequisites: Demonstrated competency through appropriate assessment or earning a grade of "C" or better in ENGL 025 and ENGL 032. Designed to develop students' abilities to think, organize, and express their ideas clearly and effectively in writing. This course incor-

porates reading, research, and critical thinking. Emphasis is placed on the various forms of expository writing such as process, description, narration, comparison, analysis, persuasion and argumentation. A research paper is required. Numerous in-class writing activities are required in addition to extended essays written outside of class.

ENGL 112 Exposition and Persuasion **TransferIN 3 Credits**

Prerequisites: A grade of "C" or better in ENGL 111. Builds on the writing skills taught in ENGL 111 and emphasizes research-based analytic and argumentative writing.

ENGL 202 Creative Writing **TransferIN 3 Credits**

Prerequisites: ENGL 111. This course introduces students to opportunities for self-expression in one or more literary genres - fiction, poetry, drama, and the creative essay.

ENGL 206 Introduction to Literature **3 Credits**

Prerequisites: ENGL 111. Development of basic strategies for critically reading and interpreting poetry, fiction, and drama; introduction to the premises and motives of literary analysis and critical methods associated with various literary concerns through class discussion and focused writing assignments.

ENGL 210 Literature and Life: Thematic **3 Credits**

Prerequisites: ENGL 111. A thematic introductory literature course. Students will read American and/or English literature in relation to a specific cultural problem or theme. Students will be introduced to critical/literary approaches, draw conclusions about similarities and differences between texts (both in terms of content and technique), and practice written response to the texts.

ENGL 211 Technical Writing **TransferIN 3 Credits**

Prerequisites: A grade of "C" or better in ENGL 111. Builds on the writing skills taught in ENGL 111. Requires students to prepare technical reports and correspondence for various purposes using standard research techniques, documentation, and formatting as appropriate. May require students to demonstrate both written and oral competencies.

ENGL 212 Western Literature I **3 Credits**

Prerequisites: ENGL 111. Introduces Western Classical Literature from Antiquity to Chaucer. Presents representative texts and stresses reflective and intensive reading from the major historical periods. Emphasizes aesthetic appreciation of literature, cultural and philosophical issues of its emergence.

ENGL 213 Western Literature II **3 Credits**

Prerequisites: ENGL 111. Introduces Western Classical Literature from Shakespeare to the Modern Era. Presents representative texts and stresses reflective and intensive reading from the major historical periods. Emphasizes aesthetic appreciation of literature, and cultural

and philosophical issues of its emergence.

ENGL 214 Introduction to Poetry 3 Credits

Prerequisites: ENGL 111. Provides an introduction to the art and history of poetry. Emphasizes a greater appreciation and understanding of the genre through critical analysis of various poetic forms and literary devices.

ENGL 220 Introduction to World Literature I Transferin 3 Credits

Prerequisites: ENGL 111. A survey of literature course designed to acquaint the student with influential works from the ancient Greeks to Shakespeare. Included in assigned readings will be epic poetry, the sonnet, drama, and the philosophic essay. Combines practice in advanced expository writing with literary study.

ENGL 221 Introduction to World Literature II Transferin 3 Credits

Prerequisites: ENGL 111. A survey of literature course designed to acquaint the student with influential works from Shakespeare to the present. Included in assigned readings will be work by the Eastern, Continental, British, and American authors. Instruction in research techniques and writing research papers is combined with literary study.

ENGL 222 American Literature I Transferin 3 Credits

Prerequisites: ENGL 111. This course is designed to survey major American poets and prose writers from the early Colonial period to the time of the Civil War. Included will be a discussion of the major historical, cultural, intellectual, and political events which influenced the authors.

ENGL 223 American Literature II Transferin 3 Credits

Prerequisites: ENGL 111. This course is designed to survey major American poets and prose writers from the Civil War to the present. Included will be a discussion of the major historical, cultural, intellectual, and political events which influenced the authors.

ENGL 224 Survey of English Literature I 3 Credits

Prerequisites: ENGL 111. Survey of English Literature I introduces the student to British literature from Beowulf to the eighteenth century. Included will be a discussion of the major historical, cultural, intellectual, and political events which influenced the development of British literature.

ENGL 225 Survey of English Literature II 3 Credits

Prerequisites: ENGL 111. Survey of English Literature II introduces the student to British literature from the Romantic, Victorian, and modern periods. Included will be a discussion of the major historical, cultural, intellectual, and political events which influenced the development of British literature.

ENGL 227 Introduction to World Fiction 3 Credits

Prerequisites: ENGL 111. This general survey course introduces the genre of fiction through a focus on world authors. It examines themes and literary devices present in novels and short stories.

ENGL 240 Children's Literature Transferin 3 Credits

Prerequisites: ENGL 111. This course provides a survey and analysis of classic and modern children's literature for students interested in understanding literature read to/by children preschool-middle school. The course focuses on different genres of literature and may include picture books, folk tales, poetry, short stories, and novels. In addition, the role of art, illustrations, and media adaptations will be examined in conjunction with children's literature throughout the years.

ENGL 245 Literature of the Old Testament 3 Credits

Prerequisites: ENGL 111. Surveys the Old Testament/Hebrew Scripture as a literary work. Emphasizes history, composition, structure, cultural context, and recognizing the contribution it has made to human development.

ENGL 249 Linguistics 3 Credits

Prerequisites: ENGL 111. Designed to introduce students to the various disciplines which comprise the scientific study of language. These include a survey of applied, comparative, descriptive, and historical linguistics. The course will primarily focus on the English language.

ENGL 250 English Grammar 3 Credits

Prerequisites: ENGL 111. An in-depth study of the grammatical structures of American English. A course designed to acquaint students with descriptions of modern English syntax.

ENGR 116 Geometric Modeling for Visualization 2 Credits

Prerequisites: MATH 050. This is a fundamental course which introduces students to geometric modeling for visualization and communication. Including construction techniques to produce computer models for graphic visualization and communication will be explained and used.

ENGR 140 Engineering Software Tools I 3 Credits

Prerequisites: MATH 133 and MATH 134 or MATH 136 and MATH 137. This course introduces the students to the engineering profession and to computer programming. The programming techniques which will be introduced are applicable to all computer languages. The C programming language will also be introduced. Examples and engineering applications will be used to illustrate programming concepts.

ENGR 160 Engineering Software Tools II 3 Credits

Prerequisites: MATH 133 and MATH 134 or MATH 136 and MATH 137. Introducing students to object-oriented programming and design. Emphasis on engineering application.

ENGR 190 Introduction to Engineering Design 2 Credits

Prerequisites: MATH 133 and MATH 134 or MATH 136 and MATH

137. This introductory course provides the student an opportunity to be introduced with fundamentals of the design process from mechanical and electrical aspects.

ENGR 251 Electrical Circuits I 4 Credits

Prerequisites: MATH 211. Provides an integrated lab/lecture sequence in which students are introduced to the fundamentals of circuit analysis. Topics include resistive, capacitive, and inductive circuit elements, nodal and mesh analysis, transient response of RLC circuits, steady state sinusoidal response, operational amplifiers, and an introduction to diodes and transistors.

ENGR 252 Electrical Circuits II 4 Credits

Prerequisites: ENGR 251. An integrated lab/lecture course which continues ENGR 251. This course covers sinusoidal steady state analysis, Laplace and Fourier analysis, transistors, diodes, op-amps, and three-phase systems. An introduction to computer aided design and analysis is provided.

ENGR 260 Vector Mechanics-Statics 3 Credits

Prerequisites: MATH 212. Includes resolution and composition of forces, moments, principles of equilibrium and application to trusses and jointed frames, friction, center of gravity and second moments of areas. Uses vector analysis throughout.

ENGR 261 Dynamics 3 Credits

Prerequisites: ENGR 260. Covers rectilinear and curvilinear motions, force, mass and acceleration, projectiles, pendulums, inertia forces in machines, work and energy, impulse and momentum and impact.

ENGR 270 Engineering Project Management 3 Credits

Prerequisites: After 45 credit hours in the program. An introduction to principles of engineering project management and techniques. Topics include technical feasibility studies, project specifications, scheduling, validation, life cycle costing, and economic analysis. The focus is on managing an engineering project through scheduling, budgeting, resource management, execution and control.

ENRG 101 Introduction to the Energy Industry 1 Credit

Prerequisites: None. This course introduces the student to the energy industry. Students will visit various energy utilities, such as a power plant, a switchyard, a substation, a natural gas regulator station, welding facilities, ethanol plants, biodiesel plants, and other renewable energy sites.

ENRG 102 Climbing 3 Credits

Prerequisites: None. Corequisites: ENGR 109 Rigging for Line Workers. The student will gain the knowledge of the proper care of climbing tools, and the mastering of climbing wood pole structures. The student must master climbing wood pole structures with and without the use of a pole safety strap. Upon completion of this course the student will also be able to determine the proper aspects of pole inspection, and be able to recognize the hazards of climbing. Upon successful completion of this course, the student will be qualified in

two methods of pole rescue. An introduction to aerial pole framing is included in this discipline.

ENRG 103 Electrical Essentials for Power Line Workers 3 Credits

Prerequisites: None. An introduction to the electrical principles required for installation, maintenance and troubleshooting of power line. Topics include electrical units, power systems overview, ac current and voltage, single and three phase circuits, conductors and cables, transformers, grounding, protective equipment.

ENRG 107 Transmission and Distribution of Electric Power 3 Credits

Prerequisites: None. A study of the principles and components required for the transmission and distribution of electric power. To provide the student with an understanding of high voltage systems, single and three phase circuits, voltage regulation, power grids. Overhead and underground distribution. Safety, buying and selling of power.

ENRG 109 Rigging for Line Workers 3 Credits

Prerequisites: None. Corequisite: ENRG 102 Climbing. The student will gain the knowledge of rigging gear inspection, safe rigging procedures and load control, using almost any vertical or horizontal rigging system. Students will tie the knots. Splice rope, install block and lines or power lines for hoisting purposes, as well as calculate hook strain and haul line tension for safe working loads. Wire and chains will also be covered.

ENRG 203 Electric Line Distribution and Construction Practices I 3 Credits

Prerequisites: ENRG 103 Electrical Essentials for Power Line Workers, ENRG 109 Rigging for Line Workers. This course offers an introduction to basic field practices for electric distribution employees, such as managing risk in power line work, working with conductors and cables, and operating switchgear. The various connections of transformers, troubleshooting transformers, and maintaining voltage levels to the customer will be covered.

ENRG 205 Electric Line Distribution and Construction Practices II 3 Credits

Prerequisites: ENRG 203 Electric Line Distribution and Construction Practices I. This course covers rigging in power line work, working with aerial devices and digger derricks, installing protective grounds, working with live electrical circuits, working with revenue metering, and maintaining streetlights.

ENRG 211 Underground Distribution 3 Credits

Prerequisites: None. This course introduces the student to underground systems including drawings, materials, and installation practices. Installing, splicing, and terminating cables. Fusing, system

maintenance, troubleshooting, and job site safety issues.

ENVM 101 Introduction to Environmental Technology 3 Credits

Prerequisites: None. Designed to introduce the student to environmental technology, the EPA, toxics, hazardous materials, and other waste topics. The course will touch on the subjects of weapons of mass destruction, chemistry, birth defects, and some other common ailments. Biological warfare topics will be discussed, protection for the hazardous materials situations, and protection for the fire fighting personnel in the event of an emergency.

ENVM 102 Environmental Management 3 Credits

Prerequisites: None. Designed to introduce the student to environmental management, how the environmental regulations evolved, the EPA, OSHA, NIOSH, and ADA. Environmental crimes will be discussed, how the government is enforcing the rules, weapons of mass destruction, biological warfare, and treatment and disposal of the toxic wastes.

ENVM 104 Plant Operations – Sanitary 3 Credits

Prerequisites: Program Advisor Approval. Provides the basic principles of aerobic and anaerobic biological treatment processes, including activated sludge, trickling filters, lagoons, sludge handling and disinfection. Reviews state and federal regulations related to wastewater plants.

ENVM 105 Air Quality Management 3 Credits

Prerequisites: CHEM 101. This course is designed to introduce the student to environmental air quality problems experienced, laws enforced and enacted by the EPA as well as others, toxicity, noise pollution, global air pollution, and a brief history of the EPA, and some of their accomplishments.

ENVM 106 Water Quality Management 3 Credits

Prerequisites: CHEM 101. This course is designed to introduce the student to water management, how the environmental regulations evolved, the EPA, OSHA, NIOSH, and ADA. Environmental crimes will be discussed, how the government is enforcing the rules, weapons of mass destruction, biological warfare, and treatment and disposal of the toxic wastes. Water resources, contamination, and what is happening to clean the water we drink.

ENVM 110 Environmental Toxicology 3 Credits

Prerequisites: None. This course is designed to introduce the student to environmental toxicology, how it affects our bodies, our breathing, our environment we live in, the places we work, eat, and live. This course also tries to explain some of the conditions in industries, various laws that have been enacted and passed to protect the general population.

ENVM 208 Plant Operations – Industrial 3 Credits

Prerequisites: Program Advisor Approval. Covers wastewater treatment

processes including coagulation, sedimentation, activated sludge, neutralization, equalizations and cyanide and chromate removal. Presents instrumentation, maintenance and troubleshooting. Includes operations, laboratory testing and associated mathematics.

FIRE 100 Fire Suppression 3 Credits

Prerequisites: None. Designed for non-firefighters. An introduction to the fire service. Terminology, history and basic firefighting skills are applied.

FIRE 101 Fire Technology 3 Credits

Prerequisites: None. A general introduction to the study of fire science. This course examines the history and growth of the fire service from its beginning to modern day firefighting. Students will cover the life safety code (NFPA-101), fire protection systems, firefighter safety and survival, along with identifying and analyzing the fire problems we face in the fire service today. This course will also cover what fire is, the chemical hazards of combustion and related by-products of fire. Fire department organization, administration, operations, and basic strategies and tactics will be covered.

FIRE 102 Fire Apparatus and Equipment 3 Credits

Prerequisites: None. Examines in detail the various types of apparatus on the market today. Study is made of pumps, aerials, elevating platforms and special apparatus. The students utilizing NFPA standards 1901, 1904, and 1500, will identify the proper chapters on a given situation. Topics will include: apparatus placement on an emergency incident, types of pumps, tests, equipment, drafting, relay, nozzles, fittings and hose lays, and maintenance on various types of apparatus.

FIRE 103 Fire Fighting Strategy and Tactics 3 Credits

Prerequisites: None. Prepares students to make responsible decisions concerning fire ground strategies and tactics at the company level. Areas covered include pre-incident planning and size up. Also, the student will learn basic building construction, fire-behavior, fire control, fireground factors, fire stream management and support activities. Responsibilities of engine and ladder companies are discussed. Emphasis is placed on safety in all the above areas. Command scenarios are used throughout the course.

FIRE 104 Building Construction Fire Service 3 Credits

Prerequisites: None. Examines the design principles involved in the protection of a structure from fire involvement. Additionally, the signs, symptoms, and indicators of partial or total building collapse during fire-fighting operations are studied. The course includes the study of legislative codes and laws concerning the following: building design, building fire safety, classification of building construction, blueprint reading, plan review and in-house fixed fire protection.

FIRE 106 Fire/Arson Investigator 3 Credits

Prerequisites: Demonstrated competency through appropriate

assessment or earning a grade of "C" or better in MATH 040 and ENGL 032. Focuses on the responsibility of the firefighter, the investigator, and the department in fire scene investigations. Fire cause and loss, collection and preservation of evidence and determination of fire origin will be studied. Emphasis will be placed on the application of various scientific aids that assist in investigations. Hands on labs with property and vehicle investigations will be included. On completion of this course the student is eligible to take the national testing certification for Fire Investigator I.

FIRE 108 Fire Inspection/Code Enforcement 3 Credits

Prerequisites: None. Examines the function of the fire inspector and organization of the fire prevention unit. Emphasizes the identification of the various codes and regulations utilized by the inspector, with special attention given to the Indiana Fire Code and IFSTA Fire Inspection and Code Enforcement. Includes the legal authority governing fire prevention, applications of the firecode, and management's principles as applied to a bureau.

FIRE 109 Fire Department Specifications 3 Credits

Prerequisites: None. Specifications for firefighting apparatus, equipment, protective clothing, facilities and other sources of materials necessary to a fire department. The student will have a better understanding of NFPA Standards 1500 and 1901.

FIRE 116 Fire Fighter I 3 Credits

Prerequisite: None. **Corequisite:** FIRE 117. This course is designed to be an entry level training program coupled with Fire Fighter II. Introduces the student to the fire service, terminology, history and basic firefighting skills needed to complete and pass the requirements as designed by the Department of Homeland Security for Basic, Mandatory and Fire Fighter I.

FIRE 117 Fire Fighter II 3 Credits

Prerequisite: None. **Corequisite:** FIRE 116. This is a companion course to Fire Fighter I and expands upon the principles and techniques of fire fighting. Students will study fire protection systems, firefighter safety and survival. This course will also cover what fire is, the chemical hazards of combustion and related by-products of fire. Fire department organization, administration, operations, and basic strategies and tactics will be covered.

FIRE 201 Fire Protection Systems 3 Credits

Prerequisites: None. Provides a general introduction into fire alarm monitoring devices and extinguishing systems. A strong base for application to either fire protection or a commercial application can be developed. Technical areas to be covered will be: fire extinguishing agents, portable fire extinguishers, carbon dioxide systems, dry chemical systems, halogenated systems/foam systems, explosive suppression systems, thermal/smoke/flame detection systems, and

building monitoring systems. Standpipe and sprinkler systems will be covered in detail.

FIRE 202 Fire Service Management 3 Credits

Prerequisites: None. Principles and functions of administrative and management personnel in the fire service. Topics discussed include: departmental organization, administrative and management procedures, personnel selection, line and staff functions, communications, the fire company unit, public relations, and current problems in administration.

FIRE 204 Fire Service Hydraulics 3 Credits

Prerequisites: Demonstrated competency through appropriate assessment or earning a grade of "C" or better in ENGL 032 and MATH 050. A study of compressible fluids including: fluid properties, principles of fluid statics, flow system principles, pipe friction and head loss, flow measurements, pumps, and other appliances and hydraulic devices. Applications are related to fire protection systems, water supply systems and foam systems.

FIRE 205 Aircraft Firefighting 3 Credits

Prerequisites: None. Examines the hazards associated with aircraft firefighting. Emphasis will be placed on lecture and practical use of airport firefighting equipment, extinguishing agents, strategy and tactics, rescue methods, and aircraft design and construction.

FITN 100 Lifetime Fitness and Wellness 2 Credits

Prerequisites: None. Educates students about the importance of fitness/wellness in their everyday lives. Students will have the opportunity to customize their own behavioral plans for fitness/wellness.

FORN 101 Introduction to Forensic Science 3 Credits

Prerequisites: Demonstrated competency through appropriate assessment or earning a grade of "C" or better in MATH 050, ENGL 025 and ENGL 032. Introductory course dealing with the basic concepts in Forensic Science. Includes lab.

FORN 203 Crime Methods and Techniques 4 Credits

Prerequisites: FORN 101 and CHMT 101. Advanced course addressing laboratory techniques used in Forensic Science. Includes lab.

FREN 101 French Level I Transfer IN 4 Credits

Prerequisites: Demonstrated competency through appropriate assessment or earning a grade of "C" or better in ENGL 025 and ENGL 032. An introductory course in French. Introduces the French language and Francophone culture through communicative activities intended to develop oral communication skills and listening comprehension skills. Emphasis is placed on learning basic grammar and vocabulary necessary for successful communication while laying a foundation for further study.

FREN 102 French Level II Transfer IN 4 Credits

Prerequisites: FREN 101 French Level I or demonstrated competency

in French through appropriate assessment; demonstrated competency in reading and writing through appropriate assessment or earning a grade of "C" or better in ENGL 025 and ENGL 032. Continues the study of French for students who have had the equivalent of one semester of college-level French. Introduces additional grammatical structures and vocabulary to further develop listening, speaking, reading, and writing skills as well as an appreciation of the cultures of the Francophone world.

FREN 201 French Level III 4 Credits

Prerequisites: FREN 102 French Level II or demonstrated competency in French through appropriate assessment; demonstrated competency in reading and writing through appropriate assessment or earning a grade of "C" or better in ENGL 025 and ENGL 032. French is the primary medium of instruction. The goal of the course is to continue the development and reinforcement of the skills of the target language: listening, speaking, reading and writing at an intermediate level. The course continues the study of grammar/syntax and vocabulary building and introduces French civilization through conversation coordinated with the reading of cultural and literary texts as well as written and oral reports.

FREN 202 French Level IV 4 Credits

Prerequisites: FREN 201 French Level III or demonstrated competency in French through appropriate assessment; demonstrated competency in reading and writing through appropriate assessment or earning a grade of "C" or better in ENGL 025 and ENGL 032. French is the primary medium of instruction. The goal of the course is to continue the development and reinforcement of the skills of the target language: listening, speaking, reading and writing at an advanced intermediate level. The course continues the study of grammar/syntax and vocabulary building and continues the study of French and Francophone civilizations through readings, both journalistic and literary, and reinforced through class discussions as well as written and oral reports.

GEOG 207 World Geography 3 Credits

Prerequisites: Demonstrated competency through appropriate assessment or earning a grade of "C" or better in ENGL 025, ENGL 032 and MATH 044.A geographical analysis of the major physical, cultural, political and economic divisions of the world along with their characteristics, locations, human activities, and inter-relationships.

GRAM 101 Graphic Media Fundamentals 3 Credits

Prerequisites: None. Explores the fundamentals of graphic art production. Provides hands-on training in manual page layout, and an introduction to electronic layout. Presents the concepts and fundamentals of measurement and typography. Problem-solving and laboratory assignments will reinforce concepts in the reading and lecture experience.

GRAM 102 Introduction to Machine Printing 3 Credits
Prerequisites: GRAM 104 and GRAM 201. Provides a history and overview of the interrelationship of various printing processes. Course offers instructions in basic press operations. Covers materials and techniques utilizing equipment and tools necessary to operate a basic offset press.

GRAM 104 Art and Copy Preparation 3 Credits
Prerequisites: None. Corequisites: GRAM 201. Provides a foundation in design, typographic and communications concepts. Presents traditional techniques as well as computer aided technologies in the consideration of color, format and use of visuals in illustration. Emphasizes problem solving with assignments executed through strip-up of the negative into a flat and proofing.

GRAM 106 Introduction to Color Printing 3 Credits
Prerequisites: GRAM 104 and GRAM 201. Corequisites: GRAM 102 and GRAM 202. Studies basic color theory, materials and methods used in the reproduction of color in printed materials. Covers techniques and materials with assignments utilizing different processes including four-color as well as spot color. Pre-separated negatives, halftones, registration and runs are covered. Includes in depth study of inks and color inking systems. Also covers digital color separations.

GRAM 201 Photomechanical Reproduction 3 Credits
Prerequisites: None. Corequisites: GRAM 104. Introduces image conversion in black and white and color theory. Examines photochemistry, halftones, darkroom techniques and diffusion transfers. Uses large format stat cameras.

GRAM 202 Science of Color 3 Credits
Prerequisites: None. Covers the physical properties of light and color and the psychological aspects of color perception and color relationships. It develops an acute awareness of the use of color and color theories in various visual and written terms. It covers primary, secondary and tertiary colors, their creation and use through a series of hands on projects.

GRAM 213 Desktop Publishing 3 Credits
Prerequisites: VISC 115. This course covers computer techniques in preparatory and preparatory composing procedures including electronic layout and typographic concepts. Emphasizes computer skills and output.

GRAM 214 Screen Printing 3 Credits
Prerequisites: None. This course introduces the students to the basics of the Screen Printing process. Students will learn a process for reproducing graphic images on a wide variety of objects, from paper to wooden signs and ceramic objects. This course covers inking, substrates and transfer processes.

GRAM 215 Computer Graphics II 3 Credits
Prerequisites: VISC 115. This course will showcase the design tricks and techniques of vector graphics use. It is assumed that students will already know computer basics and can take assigned projects from basic idea to completed artwork.

GRDN 110 Fundamentals of Gardening 3 Credits
Prerequisites: None. Studies the horticulture principles of garden plant structure, growth and development and soil science. Includes cultural practices, propagation techniques, plant care, nutrition, maintenance, and disease and insect control.

GRDN 111 Arboriculture: Trees and Shrubs 3 Credits
Prerequisites: None. Studies the identification, selection criteria, growth habits, growing conditions, installation techniques and maintenance requirements for woody plantings, including evergreen and deciduous shade and ornamental trees, shrubs and vines.

GRDN 112 Floriculture: Annuals and Perennials 3 Credits
Prerequisites: None. Studies the identification, selection and design criteria for herbaceous ornamentals found in garden beds, borders and containers. Students will research the growing conditions, planting techniques and maintenance requirements for perennial and annual plantings.

GRDN 113 Turf Management: Grasses and Groundcovers 3 Credits
Prerequisites: None. Introduces the identification and selection criteria for grasses and groundcovers. Includes the growing conditions, installation techniques and maintenance requirements for a healthy lawn and landscape.

GRDN 114 Garden Design I 3 Credits
Prerequisites: None. Survey of basic garden landscape design. Includes topics on plant types and uses, client requirements, design concepts, site analysis, and garden planting plans and project presentation methods. Emphasizes the principles and techniques for designing outdoor gathering and living places.

GRDN 115 History of Garden Design 3 Credits
Prerequisites: None. An overview of the history of garden design and landscape architecture from antiquities through the 21st century. Students will research influential garden designers, landscape architects, garden restoration and current trends.

GRDN 116 Theme Gardening 3 Credits
Prerequisites: None. Introduction to garden styles and border design. Students will create theme gardens with an emphasis on plant combinations, color, function and aesthetics. Includes studies in water, shade, wildlife, native, low-maintenance and container gardens.

GRDN 231 Garden Design II 3 Credits
Prerequisites: INTD 102 and GRDN 114. Continuation of GRDN 114. An advanced study of design principles, concept development, creative problem solving and planning skills through a master plan approach. Emphasizes the formation of working drawings and contract documents, barrier-free applications, business practices, project facilitation and the relationship between individuals and their surroundings.

GRDN 232 Garden and Landscape Design III 3 Credits
Prerequisites: INTD 105 and INTD 216 and GRDN 231. Continuation of GRDN 231. Students will define and develop a program for an advanced landscape design problem from concept development through professional presentation. Emphasis is on research methodology and project comprehension and management.

HAZM 100 OSHA Regulations 3 Credits
Prerequisites: None. This course provides a study of the U.S. Occupational Safety and Health Administration's (OSHA) regulations that pertain to protecting workers from exposure to occupational hazards. Students concentrate on researching, interpreting, summarizing, and applying the OSHA regulations.

HAZM 200 EPA Regulations 3 Credits
Prerequisites: None. This course provides a detailed study of the U.S. Environmental Protection Agency (EPA) regulations pertaining to hazardous waste management, with an emphasis on the requirements of the Resource Conservation and Recovery Act of 1976, the Comprehensive Environmental Response, Compensation, and Liability Act of 1980 and the Superfund Amendments and Reauthorization Act of 1986.

HAZM 201 Contingency Planning 3 Credits
Prerequisites: None. How to develop an emergency response contingency plan for a facility of community. Preparedness includes analyzing the hazards, writing and implementing the contingency plans, training employees for an emergency, and evaluating the effectiveness of the contingency plan.

HAZM 203 Sampling Procedures 3 Credits
Prerequisites: None. A variety of sampling procedures used in industrial settings for emergency response. Topics to be covered include: sampling and monitoring devices, industrial hygiene monitoring, water and waste stream monitoring, outside air sampling, soil and radiation sampling. Emphasis will be placed on collecting and preserving representative samples, interpreting laboratory results, and on complying with relevant federal regulations.

HAZM 205 DOT Regulations 3 Credits
Prerequisites: HAZM 100. A detailed study of the U.S. Department of Transportation (DOT) regulations. Students shall be introduced to

certain Nuclear Regulatory Commission and Environmental Protection Agency regulations pertinent to hazardous materials transportation.

HAZM 220 Hazardous Materials Recovery, Incineration and Disposal 3 Credits

Prerequisites: HAZM 100. The methods of recovery, incineration and/or disposal of hazardous waste. Topics include contracting qualified disposal organizations, obtaining permits and ensuring regulatory compliance of hazardous waste. Topics include contracting qualified disposal organizations, obtaining permits and ensuring regulatory compliance of hazardous waste.

HCMG 125 Health Care Systems and Trends 3 Credits

Prerequisites: Demonstrated competency through appropriate assessment or earning a grade of "C" or better in ENGL 025, ENGL 032 and MATH 044. An introduction to the health care industry emphasizing the systems approach to health care and the current trends facing the industry. Gives special attention to managed care organizations.

HCMG 225 Finance and Budgeting for Health Care 3 Credits

Prerequisites: ACCT 101. Importance is placed on the development and use of departmental budgets. Financial statements will be used to project future expenses and revenues for an organization and/or department. Emphasizes the reimbursement process for a managed care environment and purchasing procedures.

HCMG 226 Organizational Development in Health Care 3 Credits

Prerequisites: BUSN 105 and HCMG 125. Examines organizational structure in health care organizations, including traditional structures and reengineering of the health care industry. Covers staff development, training, job analysis and design, and departmental staffing. Discusses medical ethics.

HIMT 101 Health Information Systems 3 Credits

Prerequisites: Program Advisor Approval. Provides opportunity for a health information management profession. Presents the origination, content, and development of patient indices and patient records. Overview of the design, maintenance and use of manual and computerized health information systems for filing, numbering, and storage of patient information.

HIMT 102 Health Data Content and Structure 2 credits

Prerequisites: Program Advisor Approval. Introduction to health data collections methods for health information systems. Study of the datasets and databases used in various healthcare settings. Overview of the creation and maintenance of health information disease registries and indexes. Overview of concepts influencing electronic and computerized patient records and automation of health information management functions.

HIMT 104 Health Information and the Law 3 credits

Prerequisites: Program Advisor Approval. Presents the substantial changes brought about by HIPAA and the growth of electronic health records systems and electronic data networks. Discusses the state laws affecting the use and disclosure of health information and the complex interplay of federal and state health information privacy laws. Addresses the challenging area of how patient information may be used in connection with medical research.

HIMT 105 Healthcare Organizations and Delivery Systems 3 credits

Prerequisites: Program Advisor Approval. Provides an overview of the organization of healthcare delivery, including the various types of healthcare institutions, accreditation standards, licensure and regulatory agencies, and payment and reimbursement systems. Emphasizes the maintenance of data accuracy, security, privacy, and confidentiality in manual and computerized information systems.

HIMT 201 Reimbursement Systems 3 credits

Prerequisites: HIMT 101, HIMT 102 and HIMT 105. Presents data elements that apply to prospective payment systems. Enables students to gain knowledge of reimbursement systems and to identify issues and patient characteristics in meeting medical necessity guidelines.

HIMT 202 Healthcare Data Literacy and Statistics 3 credits

Prerequisites: HIMT 101, HIMT 102 and MATH 115. Compilation and usage of various types of administrative and healthcare statistics including vital records. Includes an overview of the health information research process and the use of computers for data management.

HIMT 203 ICD Coding 3 credits

Prerequisites: HIMT 101, HIMT 102 and HIMT 210. Includes International Classification of Diseases (ICD) assignment and sequencing of codes in accordance with approved guidelines.

HIMT 204 Quality Assessment and Improvement 2 credits

Prerequisites: HIMT 101, HIMT 102 and HIMT 105. Presents the history and development of quality assurance in various healthcare facilities. Includes quality assessment techniques, utilization management, risk management, credentialing, and medical staff services as related to health information management.

HIMT 205 Organization and Supervision 2 credits

Prerequisites: HIMT 101, HIMT 102 and HIMT 105. Includes principles and practices essential to the efficient supervision and management of health information departments including planning, organizing, directing, and controlling health information processes, personnel, finances, and space.

HIMT 207 Health Information Externship I 1 credit

Prerequisites: Program Advisor Approval. Provides the student with the opportunity to apply acquired health information technical knowledge in healthcare settings.

HIMT 208 Health Information Externship II 1 credit

Prerequisites: Program Advisor Approval. Provides the student with the opportunity to apply acquired health information technical knowledge in healthcare settings.

HIMT 210 Pathophysiology and Pharmacology I 3 credits

Prerequisites: APHY 102 and HLHS 101. Covers etiology, treatment, pharmacology, and prognosis of diseases associated with body systems.

HIMT 213 CPT Coding 3 credits

Prerequisites: HIMT 101, HIMT 102, HIMT 105 and HIMT 210. Introduces Current Procedural Terminology (CPT) coding as applied in facility and physician perspectives. Includes the general content, coding guidelines, and the role of CPT coding in healthcare reimbursement. Applies codes to basic medical and surgical services including the use of modifiers. Ethical coding and compliance issues are emphasized.

HIMT 219 Pathophysiology and Pharmacology II 3 Credits

Prerequisites: HIMT 210. Continuation of HIMT 210 to cover the etiology, treatment, pharmacology and prognosis of disease associated with body systems.

HIST 101 Survey of American History I Transfer/N 3 Credits

Prerequisites: Demonstrated competency through appropriate assessment or earning a grade of "C" or better in ENGL 025 and ENGL 032. Covers major themes and events in history including exploration of the New World; the colonial period; causes and results of the American Revolution; the development of the federal system of government; the growth of democracy; early popular American culture; territorial expansion; slavery and its effect; reform movements, sectionalism; causes and effects of the Civil War.

HIST 102 Survey of American History II Transfer/N 3 Credits

Prerequisites: Demonstrated competency through appropriate assessment or earning a grade of "C" or better in ENGL 025 and ENGL 032. Covers major themes including the post Civil War period, western expansion, industrial growth of the nation and its effects, immigration and urban discontent and attempts at reform, World War I, the Roaring Twenties, social and governmental changes of the thirties, World War II and its consequences, the growth of the federal government, social upheaval in the sixties and seventies, and recent

trends in conservatism, globalization, and cultural diversity.

HIST 125 History of American Technology 3 Credits

Prerequisites: Demonstrated competency through appropriate assessment or earning a grade of "C" or better in ENGL 025 and ENGL 032. Examines the technological development of the United States. Emphasis will be given not only to the inventions themselves but the reasons why such technology was needed and what influence the technology has had on American society.

HIST 235 World Civilization I 3 Credits

Prerequisites: Demonstrated competency through appropriate assessment or earning a grade of "C" or better in ENGL 025 and ENGL 032. Presents the key individuals, events and schools of thought, which have most greatly impacted societal development and world history up to 1650. The target civilizations of study include Oriental, the Middle East, Western Europe, Africa, and the Americas. Discusses the political, economic, social and cultural evolution of human civilization.

HIST 236 World Civilization II 3 Credits

Prerequisites: Demonstrated competency through appropriate assessment or earning a grade of "C" or better in ENGL 025 and ENGL 032. Presents the key individuals, events and schools of thought, which have most greatly impacted societal development and world history since 1500. Key movements and events of the periods will be studied. Discusses the political, economic, social and cultural evolution of civilization.

HLHS 100 Introduction to Health Careers 3 Credits

Prerequisites: None. Presents information on the health care system and employment opportunities at a variety of entry levels. Includes an overview of health care development, how health delivery systems are organized, legal and ethical considerations of health care delivery, and an overview of various health care professions. Students are encouraged to explore health professions through assignments, observations and interviews.

HLHS 101 Medical Terminology Transfer IN 3 Credits

Prerequisites: Demonstrated competency through appropriate assessment or earning a grade of "C" or better in ENGL 025 and ENGL 032. Addresses basic terminology required of the allied health professional and provides a basic knowledge of anatomy and physiology, pathology, special procedures, laboratory procedures, and pharmacology. Greek and Latin prefixes, suffixes, word roots, and combining forms are presented. Emphasis is on forming a foundation for a medical vocabulary including meaning, spelling, and pronunciation. Medical abbreviations, signs, and symbols are included.

HLHS 103 Dosage Calculation 1 Credit

Prerequisites: Demonstrated competency through appropriate assessment or earning a grade of "C" or better in ENGL 031 and

MATH 050. Introduces the mathematical concepts required of the allied health professional to accurately administer medication.

HLHS 104 CPR/Basic Life Support 0.5 credit

Prerequisites: None. Provides students with information necessary to recognize the need for one and two-person cardiopulmonary resuscitation (CPR) as it relates to adults, children and infants. Requires students to safely perform CPR and the use of Automated External Defibrillator (AED).

HLHS 105 Medical Law and Ethics 3 Credits

Prerequisites: Demonstrated competency through appropriate assessment or earning a grade of "C" or better in ENGL 025 and ENGL 032. Provides an overview of law and ethics for allied health professionals functioning in a variety of settings. Topical areas include: the legal system, standards and scope of care and practice, physician patient relationships, standards of professional conduct, public duties, documentation, employment laws and practices, pertinent federal/state statutes, ethical codes, and bioethical issues. The content will provide an understanding of ethical and legal obligations to self, patients, and employer.

HLHS 107 CNA Preparation 5 Credits

Prerequisites: Regulations per the Indiana State Department of Health and Program Advisor Approval. Prepares individuals desiring to work as nursing assistants with the knowledge, skills and attitudes essential for providing basic care in extended care facilities, hospitals and home health agencies under the direction of licensed nurses. Presents information on the health care system and employment opportunities at a variety of entry levels. Includes an overview of the health care delivery systems, health care teams and legal and ethical considerations. Individuals who successfully complete this course are eligible to apply to sit for the Indiana State Department of Health (ISDH) certification exam for nursing assistants. This course meets the minimum standards set forth by the ISDH for Certified Nursing Assistant training.

HLHS 108 Advanced Cardiac Life Support 1 credit

Prerequisites: Successful completion of American Heart Association Basic Life Support Course including CPR for Adult, Child, Infant and AED. Provides students with information necessary to provide advanced cardiac life support safely using case scenarios, mock codes and following American Heart Association protocol and algorithms.

HLHS 109 Pediatric Advanced Life Support 1 credit

Prerequisites: Successful completion of American Heart Association Basic Life Support Course including CPR for Adult, Child, Infant and AED. Provides healthcare providers with sufficient knowledge to initiate advanced life support in a pediatric emergency, either in or out of hospital. Enhances the students' skills in evaluation and management of an infant or child respiratory and cardiac emergencies

including cardiac arrest according to the 2005-2006 standards/guidelines of the American Heart Association.

HLHS 110 Tuberculosis Training 0.5 credit

Prerequisites: None. Provides instruction to the participant on the classifications of tuberculosis, the incidences of tuberculosis and disease, the common diagnostic procedures for tuberculosis, the common treatment regimens for tuberculosis, the correct techniques for administering a Mantoux skin test and the correct method of reading and recording the results of a Mantoux skin test. The students will be given a validation card from the ISBH (Indiana State Board of Health) and the ALA (American Lung Association) after successful completion of the course according to criteria set forth by both of the validating agencies.

HLHS 111 Health and Wellness for Life 3 Credits

Prerequisites: Demonstrated competency through appropriate assessment or earning a grade of "C" or better in ENGL 025 and ENGL 032. This course promotes the development and maintenance of health and wellness throughout life. Current topics of interest such as stress management, nutrition, fitness, environmental health, and changing needs during various stages of life are explored. Students evaluate their own health and risk factors associated with modern lifestyles.

HLHS 202 Community Resources 3 Credits

Prerequisites: Demonstrated competency through appropriate assessment or earning a grade of "C" or better in ENGL 025 and ENGL 032. Introduction to social service record keeping and community resources. Emphasis will be given to universal documents found in most agencies, as well as record content, format, sequence and structure; overview of common community agencies and typical services provided by each. Emphasis is on identifying and discussing the uses and applications of community resources in supporting patients and their families. Students will learn and simulate techniques for interacting with patients and their families, and will examine collaborative strategies for interdisciplinary healthcare team efforts.

HLHS 211 Nutrition 3 Credits

Prerequisites: Demonstrated competency through appropriate assessment or earning a grade of "C" or better in ENGL 025 and ENGL 032 and HLHS 111. Introduces the principles of nutrition and diet therapy for various age groups. Considers socioeconomic, ethnic, and religious factors related to diet. Also focuses on nutritional issues often presented in a healthcare setting, such as weight management, diabetes education, nutritional deficiencies and recommended treatments, nutritional assessment techniques, and the special nutritional needs of individuals with specific health disorders.

HOSP 100 Introduction to Culinary® 1 Credit

Prerequisites: ENGL 025, ENGL 032 and MATH 044 This is the begin-

ning course in Culinary[®] designed to familiarize the student with the breadth and scope of Culinary[®] as a new discipline, encompassing both culinary arts and food science. Students will gain an overview of the role of the Culinologist[®], and how the blending of taste and technology enhances the food product development process. The course will include tours, presentations, and guest speakers from the industry.

HOSP 101 Sanitation and First Aid 2 Credits

Prerequisites: Demonstrated competency through appropriate assessment or earning a grade of "C" or better in ENGL 025 and ENGL 032. Corequisites: Demonstrated competency through appropriate assessment or enrollment in MATH 044. This course will help students learn basic principles of sanitation and safety in order to maintain a safe and healthy food service environment. It presents laws and regulations related to safety, fire, and sanitation and how to adhere to them in the food service operation.

HOSP 102 Basic Food Theory and Skills 3 Credits

Prerequisites: None. Corequisites: HOSP 101. Fundamentals of food preparation, service procedures, and safety practices in the food service industry including proper operation techniques for equipment. This course also provides a background and history of the hospitality industry and introduces the student to the broad spectrum of hospitality/ food service organizations and career opportunities. Students will be familiarized with the organizational structure and basic functions of departments.

HOSP 103 Soups, Stocks, and Sauces 3 Credits

Prerequisites: HOSP 101 and HOSP 102. How to prepare the four major stocks, the five mother sauces (in addition to smaller sauces) and various soups. Additional emphasis is placed on the further development of the classical cooking methods.

HOSP 104 Nutrition 3 Credits

Prerequisites: Demonstrated competency through appropriate assessment or earning a grade of "C" or better in ENGL 025, ENGL 032 and MATH 044. The characteristics, functions and food sources of the major nutrient groups and how to maximize nutrient retention in food preparation and storage. Students will be made aware of nutrient needs throughout the life cycle and to apply those principles to menu planning and food preparation.

HOSP 105 Introduction to Baking 3 Credits

Prerequisites: None. Corequisites: HOSP 101. Fundamentals of baking science, terminology, ingredients, weights and measures, and proper use and care of equipment. Students will produce yeast goods, pies, cakes, cookies, and quick breads.

HOSP 106 Pantry and Breakfast 3 Credits

Prerequisites: HOSP 102 and HOSP 105. The techniques and skills

needed in breakfast cookery as well as insight into the pantry department. Various methods of preparation of eggs, pancakes, waffles and cereals will be discussed. Students will receive instruction in salad preparation, salad dressing, hot and cold sandwich preparation, garnishes and appetizers.

HOSP 108 Human Relations Management 3 Credits

Prerequisites: Demonstrated competency through appropriate assessment or earning a grade of "C" or better in ENGL 025, ENGL 032, and MATH 044. The necessary skills for proper recruiting, staffing, training, and management of employees at various levels. The course will help prepare the student for the transition from employee to supervisor. Additionally, it will help the student evaluate styles of leadership, and develop skills in human relations and personnel management.

HOSP 110 Meat Fabrication 3 Credits

Prerequisites: HOSP 101 and HOSP 102. An in-depth look at meats and poultry. An emphasis will be placed on recognizing and understanding meat types and cuts to allow them to be well and profitably prepared/cooked. The course will provide discussion of grading and inspection, basic cuts, purchasing and receiving, aging, classification, and appropriate cooking and storage methods. The student will be responsible for the fabrication of meats and poultry for final preparation.

HOSP 111 Yeast Bread I 3 Credits

Prerequisites: HOSP 105. The first of two courses which prepare students to produce a variety of yeast-raised breads and rolls using both straight dough and sponge dough methods. The course emphasizes proper mixing, fermentation, make-up proofing, and baking.

HOSP 112 Yeast Bread II 3 Credits

Prerequisites: HOSP 111. To advance the student in proficiency in the production of artisan yeast-raised products from around the world. The ingredients, methods, and equipment utilized in the production of these products will be emphasized.

HOSP 113 Baking Science 3 Credits

Prerequisites: HOSP 105. To help students understand the science of baking and the different reactions that take place based on the ingredients, temperatures, and equipment in relation to the final product.

HOSP 114 Introduction to Hospitality 3 Credits

Prerequisites: Demonstrated competency through appropriate assessment or earning a grade of "C" or better in ENGL 025, ENGL 032 and MATH 044. Developing an understanding of the hospitality industry and career opportunities, and responsibilities in the food service and lodging industry. Introduces procedures for decision making which affects operation management, products, labor, and revenue.

HOSP 115 Diet Therapy 4 Credits

Prerequisites: Demonstrated competency through appropriate assess-

ment or earning a grade of "C" or better in ENGL 025, ENGL 032, and MATH 044. The basic principles of nutrition; the role nutrients play in maintaining good health as well as their effect on certain disease states. Students will learn to modify diets to meet various nutritional needs and to plan menus using modified diet principles.

HOSP 116 Dietary Management I 4 Credits

Prerequisites: Demonstrated competency through appropriate assessment or earning a grade of "C" or better in ENGL 025, ENGL 032 and MATH 044. The basic principles of management and supervision. The course is designed to teach skills necessary to goals of a person wishing to become a dietary manager.

HOSP 117 Dietary Management II 4 Credits

Prerequisites: Demonstrated competency through appropriate assessment or earning a grade of "C" or better in ENGL 025, ENGL 032 and MATH 044. The basic principles of management and supervision for the dietary professional. Skills learned through this course and included practice are applicable to management level positions.

HOSP 118 Resident Clinical Assessment Practicum 4 Credits

Prerequisites: HOSP 117. Developing an in-depth understanding of the principles of diet therapy. Students will learn to assess patients' nutritional needs, develop care plans, and implement a delivery system. Students will also learn documentation skills required by HCFA.

HOSP 144 Travel Management 3 Credits

Prerequisites: Demonstrated competency through appropriate assessment or earning a grade of "C" or better in ENGL 025, ENGL 032, and MATH 044. A systematic overview of the travel industry. The class provides comprehensive and critical information on a broad range of travel services, products, and issues.

HOSP 171 Introduction to Convention/ Meeting Management 3 Credits

Prerequisites: Demonstrated competency through appropriate assessment or earning a grade of "C" or better in ENGL 025, ENGL 032, and MATH 044. A comprehensive understanding of the convention, meeting management industry including the roles of various service providers, space requirements, and uses of convention facilities.

HOSP 172 The Development and Management of Attractions 3 Credits

Prerequisites: Demonstrated competency through appropriate assessment or earning a grade of "C" or better in ENGL 025, ENGL 032 and MATH 044. The process of developing visitor attractions and provides for a discussion of the issues involved in their management.

HOSP 201 Hospitality Purchasing and Cost Control 3 Credits

Prerequisites: MATH 111 or MATH 118. Presents the essentials of

effective food and beverage control while establishing systems for sale values of food and beverages that are outlined. This course addresses the application of the four-step control process to the primary phases of foodservice operations: purchasing, receiving, storing, issuing and production. Labor costs and sales forecasting are analyzed.

HOSP 202 Fish and Seafood 3 Credits

Prerequisites: HOSP 101, HOSP 102 and HOSP 103. Emphasizes the importance of fish and seafood in today's market. The student will become familiar with the different varieties and characteristics of fish and seafood. Students will learn the basic principles of structure, handling, and cooking to utilize the many varieties of seafood in a systematic way. The course will cover proper buying, storage, preparation and merchandising of fish and seafood. The course provides hands-on experience in boning, cutting, and cooking methods appropriate for seafood.

HOSP 203 Menu, Design and Layout 2 Credits

Prerequisites: HOSP 201. Applying the principles of menu planning, pricing, and layout to the development of menus for a variety of types of facilities and service. The major project will be to develop a menu, design and layout of a hospitality facility.

HOSP 207 Table Service 3 Credits

Prerequisites: HOSP 101 and HOSP 102. Provides students with practical knowledge and skills of restaurant operations. Knowledge and appreciation of the relationship between "front" and "back" of the house is emphasized through operation of an actual food service environment. Quality of service is emphasized through management of the guest experience. Additional course work will include tableside cookery and the study of beverages and wines.

HOSP 208 Cakes, Icings, and Fillings 3 Credits

Prerequisites: HOSP 105. Requires students to produce and finish a variety of cakes. The course emphasizes application techniques, color coordination, and the flavor and texture of fillings. Students will practice the techniques of basic cake decorating.

HOSP 209 Advanced Decorating and Candies 3 Credits

Prerequisites: HOSP 208. The second in a series in decorating techniques and candy making. Students will construct classical and contemporary candy products including centerpieces and/or showpieces made with selected confectionery mediums.

HOSP 210 Classical Cuisine 3 Credits

Prerequisites: Program Advisor Approval. Presents advanced and sophisticated classical culinary methods following the principles and techniques of Escoffier. Students will advance cooking techniques, timing, and presentation and learn history and terms pertaining to classical foods and menus with emphasis on French cuisines.

HOSP 211 Specialized Cuisine 3 Credits

Prerequisites: HOSP 106, HOSP 110, and HOSP 207. Students will be introduced to foods from various cultures. Students will gain a sense of the history of foods from various countries as well as develop skills in preparation of these foods. Students will advance skills in table service as well as tableside preparation.

HOSP 212 Garde Manger 3 Credits

Prerequisites: HOSP 106. Helps students develop skills in producing a variety of hot - served cold food products as it relates to the garde manger area. Students will prepare items appropriate for buffet presentation, including decorative pieces such as tallow and ice sculptures.

HOSP 213 Classical Pastries and Chocolates 3 Credits

Prerequisites: 30 hours of program studies including HOSP 105. This course address classical French and European desserts, including the preparation of goods such as Napoleons, Gateau St. Honoré, petit fours and petit fours sec, ganaches, pastry creams and fillings, sauces, flans and tarts, and European sponges. The course also includes instruction in tempering of chocolates, molding, and chocolate plastique, preparation of truffles, pastillage and marzipan, short doughs, and meringues. The student will be instructed in the latest preparation methods, innovative ideas for impressive plate presentations, and techniques that utilize specialized equipment and tools to make high-tech, novelle creations.

HOSP 215 Front Office 3 Credits

Prerequisites: HOSP 114 and MKTG 101. Presents a systematic approach to front office procedures, detailing the flow of business through a hotel beginning with the reservation process and ending with billing and collection procedures within the context of the overall operation of a hotel. Students will examine front office management, the process of handling complaints and concerns regarding hotel safety and security. Students will become involved in the processes for forecasting future business, sales, and rate structure of the hotel as well as methods for budgeting hotel finances for success.

HOSP 217 Housekeeping 3 Credits

Prerequisites: HOSP 114 and MKTG 101. Introduces the fundamentals of housekeeping operations. Emphasis is placed on employee development, management skills, OSHA standards and property maintenance and up-keep. Budgeting, cost controls, proper staffing and planning a fiscal budget are also emphasized in this course.

HOSP 220 Biology and Chemistry of Food Manufacturing 3 Credits

Prerequisites: BIOL 121 and CHEM 105. An introduction to basic biology and chemistry that contribute to the success of modern food production. Emphasis will be given to the science behind the manufacturing of food products from basic microbiology in fermentation

to future contributions of genetic engineering. In addition, the student will learn the rationale behind food spoilage, good quality control, and sanitary methodology in food production environments.

HOSP 221 Catering Administration 3 Credits

Prerequisites: Program Advisor Approval. Provides instruction in the fundamentals of catering; including the business of supplying food, goods, and organized service for public and private functions. Subjects to be covered include staffing, equipment, transportation, contracting, special arrangements, beverage service and menu planning. Students will practice techniques of setting up banquets and buffets. Students are required to plan, budget, cost, test recipes and formats, plan décor, service and entertainment for catered events.

HOSP 230 Wedding Cake Production I 3 Credits

Prerequisite: HOSP 208. This course will introduce the student to the fundamentals of wedding cake production. It will engage the student in elementary, handmade production of various styles of products including stacked and separated tiered cakes. In addition, this course will review and expand upon decorating techniques covered in HOSP 208. It further engages the student in decorative techniques of select cakes. The student will apply the basic principles of sanitation and safety in the foodservice operation. Student will apply the fundamentals of baking science to the preparation of a variety of wedding cakes, icings, and fillings.

HOSP 231 Wedding Cake Production II 3 Credits

Prerequisite: HOSP 208, HOSP 230. This course will build on the fundamentals of wedding cake production acquired in Wedding Cake Production I. It will engage the student in advanced, handmade production of various styles of advanced decorating techniques including rolled fondant, gum paste decorations, and pastillage and piping techniques. Successful completion of this class should provide the student with sufficient skills to acquire and excel in a job as an advanced wedding cake decorator.

HOSP 232 Plated Desserts and Pastry Salon Work 3 Credits

Prerequisite: HOSP 209, HOSP 230. This course will build on the fundamentals mastered in Classical Pastries and Advanced Decorating and Candies. The class will focus on developing plated desserts that are appropriate for restaurant and hotel menus. Themes include: balancing a dessert menu with flavors, textures, temperatures and visual appeal, seasonality of ingredients. Emphasis will be placed on creative plate presentation and artistry. The class will look at the production restrictions that may be present under different shop conditions. It will take into account challenges presented by staffing, facility and service volume. The salon portion of the class will give an overview of competitive pastry work based on ACF student standards. Final project will be an intra-class, team, salon competition.

HOSP 270 Bakery Merchandising 3 Credits

Prerequisites: HOSP 112. Education and practice in merchandising techniques with an emphasis on the baking and pastry field. The majority of a student's time will be spent in all pertinent phases of retail bakeshop operation or in the field observing merchandising in action.

HOSP 271 The Mechanics of Meeting Planning 3 Credits

Prerequisites: HOSP 171. An in-depth examination of the meetings and conventions industry, this class will focus on the operational aspects of the various industry segments and the intra-industry interactions of each. The course will provide an in-depth study and application of the techniques used for successful meetings, conventions and expositions. The text used is one of the main components used to study for the Certified Meeting Professional (CMP) examination – the highest level of expertise in meetings management. Class activity will help prepare the student for the CMP examination.

HOSP 272 The Tourism System 3 Credits

Prerequisites: Demonstrated competency through appropriate assessment or earning a grade of "C" or better in ENGL 025, ENGL 032 and MATH 050. Designed to develop an understanding of travel trends and modes and the social, environmental, and economic impact on destination areas. The course explores major concepts in tourism, what makes tourism possible, and how tourism can become an important factor in the wealth of any nation. Emphasis is given to local, regional, and national tourism.

HOSP 280 Co-op/Internship 3 Credits

Prerequisites: Program Advisor Approval. A practical experience in a commercial/non-commercial foodservice or hotel establishment in order to build specialized skills. This work-based experience provides an opportunity for students to transfer their academic preparation into actual work-based learning by acquiring "real world" skills and building ties with the business/professional community. (Students should have a site in mind prior to registering for this course—coordinator will assist.)

HPER 205 Structural Kinesiology 3 Credits

Prerequisites: Demonstrated competency through appropriate assessment or earning a grade of "C" or better in ENGL 025, ENGL 032 and MATH 044. Fundamental concepts concerning the interaction of biological and mechanical aspects of the musculoskeletal and neuromuscular structures. Emphasis on practical application to study and teaching of skilled human movement. Laboratory sessions focus on anatomy of the musculoskeletal system with application to human movement in sport, physical education, and daily activities.

HPER 211 Introduction to Sport Management 3 Credits

Prerequisites: Demonstrated competency through appropriate assessment or earning a grade of "C" or better in ENGL 025, ENGL 032 and

MATH 044. An examination of the broad spectrum of career opportunities available in the sport management profession. Includes career planning, sport management terminology, and an overview of specific skills and courses required for professional preparation in sport management. Fundamental aspects of the management functions as each relates to sport and fitness organizations. A preliminary investigation of managerial roles and skills, and their effects on interpersonal, group, and organizational relationships.

HPER 212 Introduction to Exercise Science 3 Credits

Prerequisites: Demonstrated competency through appropriate assessment or earning a grade of "C" or better in ENGL 025, ENGL 032 and MATH 044. An introduction to the science of exercise and human movement. Special topics in exercise physiology, sport biomechanics, sports medicine, and motor integration.

HPER 216 Current Concepts in Physical Fitness 3 Credits

Prerequisites: Demonstrated competency through appropriate assessment or earning a grade of "C" or better in ENGL 025, ENGL 032 and MATH 044. Introduction to physical fitness and the role of exercise in health and wellness. Understanding the concepts, principles, and guidelines for fitness exercise and related activities. Use of physical fitness assessment data to plan and carry out a personal fitness program.

HUMA 100 Theatre Appreciation TransferIN 3 Credits

Prerequisites: Demonstrated competency through appropriate assessment or earning a grade of "C" or better in ENGL 025 and ENGL 032. Developing understanding, appreciation and critical perceptions of the theatrical event. The course will approach theatre as an art form, an entertainment medium and as a vehicle for self-expression. Emphasis will be placed on the history of theatre, acting, directing, playwrighting, theatre technology, costume design, scenic design, and lighting design. Active participation in the playwrighting, acting, directing and designing processes will be provided. The course will also require attendance at theatrical events to offer first-hand experience in theatre arts.

HUMA 117 Introduction to Music Theory 3 Credits

Prerequisites: Demonstrated competency through appropriate assessment or earning a grade of "C" or better in ENGL 025 and ENGL 032. Emphasizes the practical learning of basic music skills and will cover fundamental music terminology, notation and structure. Sight singing and listening skills will also be developed through examples drawn from a wide variety of musical styles.

HUMA 118 Music Appreciation TransferIN 3 Credits

Prerequisites: Demonstrated competency through appropriate assessment or earning a grade of "C" or better in ENGL 025 and ENGL 032. Introduces the student to music with an emphasis on critical listening. Surveys a variety of genres, composers and their composi-

tions. No previous background in music required.

HUMA 201 Introduction to Humanities I 3 Credits

Prerequisites: ENGL 111. Introduces the student to a wide variety of unique creations of the individual imagination. The overall purpose of the course is to deepen and broaden the student's enjoyment of the humanistic disciplines at both the level of feeling and the level of understanding from pre-history to the Renaissance.

HUMA 202 Introduction to Humanities II 3 Credits

Prerequisites: ENGL 111. Introduces the student to a wide variety of unique creations of the individual imagination. The overall purpose of the course is to deepen and broaden the student's enjoyment of the humanistic disciplines at both the level of feeling and the level of understanding from the Renaissance to the present.

HUMS 101 Introduction to Human Services 3 Credits

Prerequisites: Demonstrated competency through appropriate assessment or earning a grade of "C" or better in ENGL 025 and ENGL 032. Explores the history of human services, career opportunities, and the role of the human service worker. Focuses on target populations and community agencies designed to meet the needs of various populations.

HUMS 102 Helping Relationship Techniques 3 Credits

Prerequisites: Demonstrated competency through appropriate assessment or earning a grade of "C" or better in ENGL 025 and ENGL 032. Provides opportunities to increase effectiveness in helping people. Examines the helping process in terms of skills, helping stages, and issues involved in a helping relationship. Second in a series of three introductory human services courses.

HUMS 103 Interviewing and Assessment 3 Credits

Prerequisites: HUMS 101 and HUMS 102 or CRIM 101 and CRIM 103. Introduces and develops basic interviewing skills. Includes assessment strategies and treatment planning. Third in a series of three introductory human services courses.

HUMS 104 Crisis Intervention 3 Credits

Prerequisites: Demonstrated competency through appropriate assessment or earning a grade of "C" or better in ENGL 025 and ENGL 032. Provides beginning training for people who anticipate or are presently working with people in crisis situations.

HUMS 105 Introduction to Correctional Rehabilitation Services 3 Credits

Prerequisites: HUMS 101 or CRIM 101. Includes a study of crime and how society is affected.

HUMS 106 Physiology of Aging 3 Credits

Prerequisites: Demonstrated competency through appropriate assessment or earning a grade of "C" or better in ENGL 025 and ENGL 032. Focuses on the physical changes and common pathologies

associated with the aging process. Includes the psychological and social implications of changes for human behavior. Focuses on health promotion and disease prevention.

HUMS 107 Human Services Topical Seminar 3 Credits

Prerequisites: Program Advisor Approval. Discusses topics of current interest in human services. Focuses on special interest projects for students in human services. Utilizes field trips, guest speakers, audiovisual activities and seminars.

HUMS 108 Psychology of Aging 3 Credits

Prerequisites: PSYC 101. Covers the major behavioral changes in adulthood and aging. Students explore their own feelings about aging as well as the attitudes of society.

HUMS 109 Understanding Diversity 3 Credits

Prerequisite: Demonstrated competency through appropriate assessment or earning a grade of "C" or better in ENGL 025 and ENGL 032. Introductory course that encourages cultural awareness and appreciation of diversity. Focuses on cultural variations in attitudes, values, language, gestures, and customs. Includes information about major racial and ethnic groups in the United States.

HUMS 110 Women's Issues 3 Credits

Prerequisites: Demonstrated competency through appropriate assessment or earning a grade of "C" or better in ENGL 025 and ENGL 032. Major issues and social problems related to women through an interdisciplinary analysis of social institutions and movements for social change as they affect women. Focus is on 21st century trends in institutions such as the family, law, medicine, education and other social interaction.

HUMS 112 Recreation for Special Populations 3 Credits

Prerequisites: Demonstrated competency through appropriate assessment or earning a grade of "C" or better in ENGL 025 and ENGL 032. Studies the nature and etiology of impairments including developmental disabilities, mental illness, physical disabilities, and geriatrics and their potential impact upon an individual's ability to participate in recreational activities. Explores techniques needed to conduct a recreation program that allows successful participation by an individual with a disability.

HUMS 113 Problems of Substance Abuse in Society 3 Credits

Prerequisites: Demonstrated competency through appropriate assessment or earning a grade of "C" or better in ENGL 025 and ENGL 032. Introductory course that provides basic information about the problems of alcohol and other drug abuse. Explores symptoms and effects of abuse and dependence on individuals, families, and society. Class can be used toward ICAADA certification.

HUMS 114 Social Services in Long-Term Care 3 Credits

Prerequisites: None. Provides practical and useful information about aging and institutionalization. Focuses on the role of social services within the long-term care facility. Indiana State Department of Health State Certification requires 48 hours of attendance.

HUMS 116 Introduction to Disabilities 3 Credits

Prerequisites: None. Provides background knowledge of the field of mental retardation/developmental disabilities and issues pertaining to the field.

HUMS 117 Foundations of Direct Support Professionals 2 Credits

Prerequisites: None. A broad overview of the major concepts associated with providing support to individuals with disabilities in the community. The curriculum meets state and federal guidelines for direct support staff training. Students successfully completing the course will receive a state sanctioned certificate.

HUMS 120 Health and Aging 3 Credits

Prerequisites: Demonstrated competency through appropriate assessment or earning a grade of "C" or better in ENGL 025 and ENGL 032. Presents an overview of the physical changes and common pathologies associated with the aging process. Focuses on the psychological and social implication of such changes for human behavior. Throughout the course there is a focus on health promotion and disease prevention during the later years.

HUMS 122 Youth and Family Treatment 3 Credits

Prerequisites: Demonstrated competency through appropriate assessment or earning a grade of "C" or better in ENGL 025 and ENGL 032. Designed to allow the student exposure to applications of theories and practical solutions to the challenges facing residential childcare workers. Introduction of the impact of cultural differences within the residential setting. Introduction to the job performance expectations of residential childcare workers, including working with placing agencies and families of the residents in the facility.

HUMS 123 Health and Wellness/Disabilities 3 Credits

Prerequisites: None. Introduces the health and medical aspects of assisting people with disabilities. Upon completion, students should be able to identify and implement strategies to promote wellness and manage health conditions.

HUMS 124 Activity Director Basic 6 Credits

Prerequisites: None. Explores the philosophy and investigates the development of therapeutic activity programs for older persons. Focuses on activities that will meet the individual's physical, social, and emotional needs.

HUMS 126 Community Integration 3 Credits

Prerequisites: None. Introduces students to the knowledge, skills and attitudes necessary for a direct support professional to success-

fully support persons with developmental disabilities in inclusive community settings

HUMS 127 Positive Personal Support 3 Credits

Prerequisites: HUMS 116. Designed for Direct Service Provide to help those with disabilities achieve independent living behaviors.

HUMS 128 Disability Support Teams 3 Credits

Prerequisites: HUMS 117 and HUMS 116. Introduces the student to the essential characteristics of an effective team as well as the strategies they can use to be an active member of the team.

HUMS 130 Social Aspects of Aging 3 Credits

Prerequisites: Demonstrated competency through appropriate assessment or earning a grade of "C" or better in ENGL 025 and ENGL 032. Covers major theories and patterns of aging in American society. Covers social institutions and cultural factors that affect the aging process.

HUMS 135 Love, Romance and Relationships 3 Credits

Prerequisites: Demonstrated competency through appropriate assessment or earning a grade of "C" or better in ENGL 025 and ENGL 032. Examines the key elements of healthy relationships. Explores the main problems that damage relationships. Presents research findings on successful and unsuccessful relationships. Examines how couples can improve intimacy, romance, and emotional connection. Explores the impact of one's emotional and relationship history on current and future romantic relationships. Presents practical, scientific-based skills for improving relationships.

HUMS 140 Loss and Grief 3 Credits

Prerequisites: Demonstrated competency through appropriate assessment or earning a grade of "C" or better in ENGL 025 and ENGL 032. Introductory course that provides practical and useful information for people who have experienced loss. Students have the opportunity to evaluate their own experiences and attitudes toward loss and grief.

HUMS 180 Ethics in Helping Professions 3 Credits

Prerequisites: Demonstrated competency through appropriate assessment or earning a grade of "C" or better in ENGL 025 and ENGL 032. Introductory level course provides overview of legal and ethical aspects in the field of workers in social service settings. Includes topics such as personal schema and how it influences working with others, confidentiality, and laws regarding reporting of neglect and abuse.

HUMS 200 Substance Abuse Internship 4 Credits

Prerequisites: HUMS 113, HUMS 208, HUMS 209, and HUMS 210. Field work experiences in approved substance abuse services agency. The student will complete 160 hours under the supervision of an agency professional and a college faculty member. The classroom component will include small group discussion and analysis of the internship experience.

HUMS 201 Internship I **4 Credits**

Prerequisites: HUMS 101, HUMS 102, and HUMS 103. The first of two fieldwork experiences in approved human service agencies. The student will complete 160 hours under the supervision of an agency professional and a college faculty member. The classroom component will include small group discussion and analysis of the internship experience.

HUMS 202 Internship II **4 Credits**

Prerequisites: HUMS 201, HUMS 205 and HUMS 206. The second of two fieldwork experiences in approved human service agencies. The student will complete 160 hours under the supervision of an agency professional and a college faculty member. The classroom component will include small group discussion and analysis of the internship experience.

HUMS 205 Behavior Modification/Choice Theory **3 Credits**

Prerequisites: HUMS 103 or CRIM 255 and PSYC 101. Advanced level course focusing on theories of behavioral and reality approaches. Develops understanding of terms and practical applications of the behavioral and reality approaches used in working with people.

HUMS 206 Group Process and Skills **3 Credits**

Prerequisites: HUMS 101, HUMS 102 and HUMS 103. Studies group dynamics, issues and behavior. Includes group functioning and leadership, guidelines on working effectively with a co-leader, and practical ways of evaluating the group processes.

HUMS 207 Program Planning and Policy Issues **3 Credits**

Prerequisites: HUMS 101, HUMS 102, HUMS 103 and demonstrated competency through appropriate assessment or earning a grade of "C" or better in MATH 044. Concentrates on the components of administration of human service agencies. Addresses practitioner skills needed by an administrator or supervisor. Discusses social policy and its impact on human services.

HUMS 208 Treatment Models of Substance Abuse **3 Credits**

Prerequisites: HUMS 113. Describes the various treatment models used with chemically dependent clients. Discussion centers on intervention and treatment models for chemical dependency and their role in the recovery process. Course can be applied toward hours for ICAADA certification.

HUMS 209 Counseling Issues in Substance Abuse **3 Credits**

Prerequisites: HUMS 113. Explores practice strategies for the worker who counsels chemically dependent clients. Course can be applied toward hours for ICAADA certification.

HUMS 210 Issues of Substance Abuse in Family Systems **3 Credits**

Prerequisites: HUMS 113. Introduction to the characteristics and dynamics of families, couples, and significant others affected by substance abuse. Examines models of intervention and engagement in the treatment and recovery process. Explores the interaction between the family system and substance use behaviors.

HUMS 212 Family and Child Welfare **3 Credits**

Prerequisites: HUMS 101. Examines contemporary problems facing families and children. Evaluates the adequacy of policies, programs, and services in the context of changing lifestyles and social forces impacting the quality of life.

HUMS 215 Juvenile Delinquency **3 Credits**

Prerequisites: HUMS 101 or CRIM 105. Provides an overview of the concepts, definitions, and measurements of juvenile delinquency. Explores various theories that attempt to explain the causes of delinquency. Looks at the role of environmental influences (peers, gangs, school, drugs) as they contribute to delinquency. Discusses an overview of the history and philosophy of the juvenile justice system as well as ways to control and treat juvenile delinquents.

HUMS 220 Issues and Ethics in Human Services **3 Credits**

Prerequisites: HUMS 101, HUMS 102 and HUMS 103. Advanced level course provides an overview of legal and ethical aspects in the field of human services with implications for the human service worker. Includes topics such as confidentiality, rights of clients, client records, equal protection for staff and clients, and discrimination. The Human Service Ethical Code and related codes are covered with an overview of ethical dimensions of practice.

HUMS 240 Rehabilitation Process: Probation and Parole **3 Credits**

Prerequisites: HUMS 105. Provides an understanding of probation and parole as an integral part of the criminal justice system with special emphasis on current and future trends in this area. Explores the role of community corrections and its impact on the role of probation and parole in our society in view of the increase in the number of offenders.

HUMS 270 Multicultural Practice **3 Credits**

Prerequisites: HUMS 101, HUMS 102, and HUMS 103. This course examines, from a theoretical and experiential social work perspective, the personal behaviors and institutional factors that have led to oppression of ethnic minorities, persons of color or other oppressed populations and those practices that serve to maintain inter-group tensions. Attention is given to discriminatory practices as related to gender, age, religion, disablement, sexual orientation, culture, etc. It will explore the strategies that the various groups have employed to

deal with discrimination. Implications to the individual, society and the profession are explored.

HUMS 279 Human Services Social Work Bridge Course **1 Credit**

Prerequisites: HUMS 201. Orientation to the profession of social work. Course addresses origins, ethics, accreditation, theoretical foundations, fields of social work, populations served and diversity. Course builds on material already covered in HUMS 101: Introduction to Human Services. Course will meet both at Ivy Tech and the related campus. Course will provide an orientation to the School of Social Work.

HVAC 101 Heating Fundamentals **3 Credits**

Prerequisites: None. Introduces fundamentals applicable to the heating phase of air conditioning. Includes types of units, parts, basic controls, functions, and applications. Emphasizes practices, tool and meter use, temperature measurement, heat flow, the combustion process and piping installation practices. Covers the basic sequence of operation for gas, oil and electric furnaces.

HVAC 103 Refrigeration I **3 Credits**

Prerequisites: None. Introduction to compression systems used in mechanical refrigeration including the refrigeration cycle and system components. Introduces safety procedures, proper use of tools used to install and service refrigeration equipment, refrigerant charging and recovery, system evacuation, calculating superheat and subcooling and using a refrigerant temperature/pressure chart.

HVAC 107 Duct Fabrication and Installation **3 Credits**

Prerequisites: None. Emphasizes reading blueprints common to the sheet metal trade, floor plans, elevations, section, detail and mechanical plans. Requires students to develop a layout of an air conditioning duct system and fittings. Fabrication of these parts, including proper use of hand-tools and shop equipment used to fabricate duct systems and fittings.

HVAC 120 Basic Carpentry and Building Maintenance **3 Credits**

Prerequisites: None. Includes carpentry basics, power tool and hand tool safety and use, framing, hanging doors and windows, trim basics, drywall basics, and painting basics.

HVAC 122 General Maintenance **3 Credits**

Prerequisites: None. Covers required record keeping, plumbing basics (fixture repair and replacement, piping, basic plumbing code, etc.), major appliance installation and repair, chemical usage and storage. MSDS files, ADA compliance and safety and liability topics.

HVAC 201 Cooling Service **3 Credits**

Prerequisites: HVAC 103. Covers procedures used to diagnose electrical, control, mechanical and refrigeration problems common to cooling systems. Familiarizes students with using the refrigeration cycle

and temperature/pressure charts as diagnostic tools in troubleshooting refrigeration system problems. Includes various methods of checking refrigerant charges, methods for charging air conditioning and refrigeration systems, electrical and refrigeration system components, and schematic and pictorial diagrams.

HVAC 202 Electrical Circuits and Controls 3 Credits

Prerequisites: INDT 113. Studies heating, air conditioning and refrigeration controls typically found on residential and light commercial heating and air conditioning equipment. Includes gas, oil and electric heating controls, cooling controls, thermostats, humidistats, aquastats, and electronic controls. Covers operation of controls, integration of controls into control systems, reading schematic and pictorial diagrams, and component troubleshooting and testing.

HVAC 203 Heat Loss and Gain Calculation 3 Credits

Prerequisites: Demonstrated competency through appropriate assessment or earning a grade of "C" or better in MATH 044. Introduces the student to calculating structural and other heat losses for winter heating, and structural and other heat gains for summer air conditioning using an industry standard method of heat loss and heat gain calculation. Discusses building construction techniques, energy consumption reduction methods and equipment selection.

HVAC 204 Commercial Refrigeration 3 Credits

Prerequisites: HVAC 221. Examines air conditioning and refrigeration systems for commercial use, including medium and low temperature applications. Includes specialized commercial refrigeration and A/C accessories, metering devices, setting pressure controls for direct temperature control, fan cycling and pump down, commercial ice production, methods of low ambient control, and advanced control arrangements.

HVAC 205 Heat Pump Systems 3 Credits

Prerequisites: HVAC 103. Familiarizes students with the refrigeration cycle as it applies to the heat pump system and the different types of heat pump systems. Covers procedures used to diagnose electrical, control, mechanical and refrigeration problems common to heat pump. Includes sizing of heat pumps, specialized heat pump refrigeration components and electrical controls, the air-to-air heat pump defrost cycle, and schematic and pictorial diagrams.

HVAC 206 Advanced Cooling System 3 Credits

Prerequisites: HVAC 106. Studies methods of troubleshooting electrical and mechanical components of air conditioning and refrigeration systems.

HVAC 207 HVAC Codes 3 Credits

Prerequisites: None. Study of state and local codes covering installation, repair, alteration, relocation, replacement and erection of heat-

ing, ventilation, cooling and refrigeration systems. Includes job-related costs of material and equipment, labor, warranty, taxes, permits and subcontracts. Students will estimate service and maintenance contracts.

HVAC 208 Heating Service 3 Credits

Prerequisites: HVAC 101. Covers procedures used to analyze mechanical and electrical problems encountered when servicing heating systems. Covers electrical schematics and connection diagrams, combustion testing, venting and combustion air requirements, sequence of operation, heating controls, troubleshooting techniques, installation practices, basic codes applying to furnace codes, and service procedures.

HVAC 209 Psychrometrics/Air Distribution 3 Credits

Prerequisites: Demonstrated competency through appropriate assessment or earning a grade of "C" or better in MATH 044. Studies the properties of air during the operational variations of temperature and humidity. Discusses the atmospheric conditions and the impact of those conditions on the heating-cooling and ventilation processes and the design of systems for residential and commercial structures. Includes the sizing and configurations of air delivery duct systems and system design methods.

HVAC 211 Refrigeration II 3 Credits

Prerequisites: HVAC 103 and INDT 113. Continues the study of air conditioning and refrigeration with further study of compressors, metering devices, system charging, refrigerant recovery, equipment installation and an introduction to troubleshooting procedures (electrical, mechanical and refrigeration). Includes clean-up procedures following compressor burnout and analysis of how a single problem affects the rest of the system. Introduces electrical control systems and electrical motor basics as they apply to air conditioning and refrigeration including motor types, starting components, and motor troubleshooting basics.

HVAC 212 Advanced HVAC Controls 3 Credits

Prerequisites: INDT 113. Covers control systems beyond ordinary residential and single zone commercial applications. Includes solid state controls, 0-10 volt DC and 4-20 milliamp control signals, zoning controls, modulating controls, low ambient controls, heat recovery and energy management controls, economizer controls, 3-phase motor protection modules, variable frequency drives (VFDs), remote sensing electronic thermostats, electronically commutated DC motor control, Direct Digital Control (DDC) systems, multiple-stage heating/cooling controls, PLC control of HVAC/R equipment and pneumatic controls.

HVAC 213 Sales and Service Management 3 Credits

Prerequisites: None. Encompasses the use of blueprints, specifications, application data sheets, bid forms and contracts in estimat-

ing materials and labor in the HVAC business. Includes advertising, direct labor, indirect labor, overhead, warranty costs, taxes, permits, subcontracts, margins, mark-ups and profit. Provides students with the opportunity to estimate service contracts and study service organization, service procedures, record keeping, parts inventory control, and liability insurance.

HVAC 214 Applied Design 3 Credits

Prerequisites: None. Provides students with the opportunity to design and lay out complete HVAC systems.

HVAC 220 Distribution Systems 3 Credits

Prerequisites: Demonstrated competency through appropriate assessment or earning a grade of "C" or better in MATH 044. Covers methods used in calculating building heat loss and gain plus how to use this data in sizing equipment and duct systems for residential and light commercial applications. Includes discussion of methods to reduce building heating/cooling loads, air flow principles, air delivery system design methods, and introduces using a psychrometric chart to solve air mixture problems.

HVAC 271 HVAC Service Projects 3 Credits

Prerequisite: Advisor Approval. This course will focus on two projects (or more depending on the time involved) directly related to the HVAC trades. Students will work around other tradesmen of the field. We will incorporate into the class the principles of Service Learning and Civic Responsibility.

HVAC 272 EPA Refrigerant Certification Course 1 Credit

Prerequisite: None. This course will prepare a student to take an EPA approved refrigerant certification course.

IMTC 106 Millwright I 3 Credits

Prerequisites: Demonstrated competency through appropriate assessment or earning a grade of "C" or better in MATH 044. Introduces the proper use of hand and power tools and measuring instruments in carpentry, blacksmithing, rigging and equipment, machinist and general shop. Includes structural steel and fabricating terms.

IMTC 107 Preventative Maintenance 3 Credits

Prerequisites: None. Introduces the major purpose of preventive maintenance: to save time and to cut costs. The course will study goals such as, reducing losses, improving product quality, boosting production efficiency, and increasing profits. Includes an introduction to sound planning, effective scheduling, competent inspection, control and actions at the worksite, and follow-up reporting. Lab projects will be designed to organize materials, tool control, transportation of equipment, sizing up labor requirements.

IMTC 108 Measure and Calibration 3 Credits

Prerequisites: INDT 113. Provides instruction in the purpose, function and application of oscilloscopes and related instruments.

IMTC 110 Coupling and Alignment

3 Credits
Prerequisites: Demonstrated competency through appropriate assessment or earning a grade of "C" or better in MATH 044. Introduces the concepts of correct alignment of industrial process machinery. Provides instruction in troubleshooting and repair of coupled machines.

IMTC 111 Rigging

3 Credits
Prerequisites: None. Introduces the proper techniques of moving industrial machinery and equipment. Emphasis is placed on proper installation, inspection, safety requirements, and load calculations.

IMTC 112 Sheet Metal Layout and Design

3 Credits
Prerequisites: Demonstrated competency through appropriate assessment or earning a grade of "C" or better in MATH 040. Examines the procedures used to layout sheet metal components. Presents the proper use of hand and machine tools to fabricate sheet metal projects.

IMTC 121 Industrial Safety

3 Credits
Prerequisites: None. Introduces occupational safety and health standards and codes with emphasis on applications of codes to typical work situations and MSDS requirements. Includes emergency first aid, safety protection, eye protection and chemicals handling. Covers employer and employee rights as well as violations, citations, penalties, variances, appeals and record keeping.

IMTC 122 Electrical Wiring Fund

3 Credits
Prerequisites: INTD 113. Introduces the student to the National Electrical Code and its application in designing and installing electrical circuits, selecting wiring materials and devices, and choosing wiring methods. Includes electrical safety, terminology, interpretation of electrical symbols used in construction blueprints, branch circuit layout, over current protection, conductor sizing, grounding, GFCI & AFCI protection, tool usage, and material/device selection.

IMTC 271 Industrial Electrical Troubleshooting

3 Credits
Prerequisite: INTD 113. This course presents methods and techniques for troubleshooting appliances, motors, motor controls, relay wiring, residential wiring, commercial wiring, and industrial wiring.

INTD 101 Shop Mathematics

3 Credits
Prerequisites: None. Provides a review of basic operations with numbers, fractions and decimals as a basic foundation. It presents the range of practical mathematics that every machinist is expected to use in the classroom and later in the shop in the creation and maintenance of tools, fixtures and industrial devices. The last group of practical topics applies math to special calculations as: taper angles, gearing ratios, gearing systems, and cutting speeds and feeds. Included are applications that three dimensional in nature such as angled holes and surfaces that are utilized concepts found in solid geometry and trigonometry.

INTD 102 Introduction to Print Reading

3 Credits
Prerequisites: Demonstrated competency through appropriate assessment or earning a grade of "C" or better in MATH 040. Provides an introduction to reading and interpreting machine shop symbols, welding blueprints and working drawings used in trades and crafts. Focuses on dimension, shape, fabrication and assembly. Applies basic mathematics to the solution of print and performance problems.

INTD 103 Motors and Motor Controls

Prerequisite: INTD 113. A general understanding of common types of electric motors, extending from the small shaded pole fan motors to the large three-phase motors. Topics covered will include motor theory, magnetism and how it affects motor rotation, motor starting components and protective devices for motor circuits. Heat dissipation from a motor, motor slippage, how they are wired to obtain different speeds, and how capacitors affect a motor circuit will be included.

INTD 104 Fluid Power Basics

3 Credits
Prerequisites: Demonstrated competency through appropriate assessment or earning a grade of "C" or better in MATH 040. Introduces fluid power principles and components. Teaches basic circuit design through the use of symbols and schematic diagrams to build a foundation for career work in fluid power technology.

INTD 105 Industrial Solid State Fundamentals

3 Credits
Prerequisites: INTD 103 and INTD 113. Studies the fundamentals of solid-state active devices that are used in automated systems. Introduces the student to the theory of basic solid-state devices such as diodes, transistors, and SCR's and applications such as amplifiers, op amps, and switching power supplies. Prepares students to diagnose, repair, verify, and install electronic circuits and systems.

INTD 106 Introduction to the Workplace and Safety

3 Credits
Prerequisites: None. Introduces basic safety instruction including OSHA requirements and other concerns (MSDS, confined space, lock out/tag out, zero energy state, hazardous materials, storage of flammable materials, storage of fuel gas and high pressure gas cylinders, portable powered tool safety, hand tool safety, record keeping, training, employer enforcement of safety regulations, right to know, etc.). Includes an introduction to measuring instruments, hand tools, portable powered tools, and procedures that are pertinent to the mix of specialties on the campus. Lab projects will be designed to reinforce safety procedures and develop competency levels in using the measuring instruments, hand tools and portable powered tools introduced in the course.

INTD 107 Heating and Air Conditioning Basics

3 Credits
Prerequisites: None. Presents fundamentals of heating and compression systems used in mechanical refrigeration. Includes combustion process, heat flow, temperature measurement, gas laws, heating and refrigeration cycles and components used in systems.

INTD 108 Metrology

3 Credits
Prerequisites: Demonstrated competency through appropriate assessment or earning a grade of "C" or better in MATH 050. Instructs a student in mechanical precision measurement techniques and applications. Provides instruction and laboratory experiences in surface plate inspections, optical comparators, hardness testing, and coordinate measuring machines (CMM). Discusses calibration and measurement system analysis.

INTD 110 History of Interiors and Furniture

3 Credits
Prerequisite: Demonstrated competency through appropriate assessment or earning a grade of "C" or better in ENGL 025 and ENGL 032. Survey development of the interrelationship of architecture, interiors, furniture, and decorative arts from antiquity through the ages.

INTD 113 Basic Electricity

3 Credits
Prerequisites: Demonstrated competency through appropriate assessment or earning a grade of "C" or better in MATH 044. The study of electrical laws and principles pertaining to DC and AC circuits is the focus of the course. This includes current, voltage, resistance, power, inductance, capacitance, and transformers. Stresses the use of standard electrical tests, electrical equipment, and troubleshooting procedures. Safety procedures and practices are emphasized.

INTD 114 Introductory Welding

3 Credits
Prerequisites: None. Provides basic skills and fundamental knowledge in oxy-fuel welding, cutting and brazing. Shield Metal Arc welding, Gas Metal Arc welding and Gas Tungsten Arc welding. This course is designed for beginning welders, auto service and body technicians, and individuals in the HVAC industry. Emphasizes safe practices in oxy-fuel and Arc welding processes.

INTD 120 Metallurgy Fundamentals

3 Credits
Prerequisites: None. Studies the fundamentals of thermodynamics and reactions occurring in metals subjected to various kinds of heat treatment. Includes classification and properties of metals, chemical and physical metallurgy, theory of alloys, heat treatment principles as applied to ferrous and non-ferrous materials, test to determine uses, heat treatment for steels, special steels, and cast iron, powder metallurgy, and use of gas and electric furnaces and their controls.

INTD 131 Introduction to Process Technology

3 Credits
Prerequisite: None. Introduction to power plant systems including boiler, turbine, generator, condenser, pumps, and auxiliary equip-

ment. Emphasizes the use of schematics and diagrams in discussing plant systems. Includes plant safety training.

INDT 132 Process Technology I (Equipment) 3 Credits

Prerequisites: INDT 131. Provides an overview of the equipment and tools used in the process industry; including piping, tubing, hoses and fittings, valves, pumps, compressors, turbines, motors and engines, power transmission and lubrication, heat exchangers, cooling towers, furnaces and boilers, filters and dryers, vessels, and process diagrams. Students will be introduced to many process-related equipment concepts, such as purpose, components, operation, and the process technician's role for operating and troubleshooting the equipment.

INDT 133 Process Technology II (Systems) 3 Credits

Prerequisites: INDT 131. Provides an overview of the equipment and tools used in the process industry; including piping, tubing, hoses and fittings, valves, pumps, compressors, turbines, motors and engines, filters and dryers, vessels, and process diagrams. Students will be introduced to many process-related equipment concepts, such as purpose, components, operation, and the process technician's role for operating and troubleshooting the equipment.

INDT 134 Process Technology III (Operations) 3 Credits

Prerequisites: INDT 133. Provides an overview of the field of operations within the process industry. Students will use existing knowledge of equipment, system, and instrumentation to understand the operation of an entire unit. Students study concepts related to commissioning, normal startup, normal operations, normal shutdown, turnarounds, and abnormal situations as well as the process technician's role in performing the tasks associated with these concepts within an operating unit.

INDT 201 Fluid Power Systems (Hydraulics/Pneumatics) 3 Credits

Prerequisites: INDT 104. Introduces the student to more complex fluid power circuits. Requires students to design, analyze and troubleshoot complex circuits using schematic diagrams. Studies detailed construction of typical industrial fluid power components. Teaches students to disassemble and evaluate fluid power components in the lab.

INDT 203 Machine Maintenance/ Installation 3 Credits

Prerequisites: Demonstrated competency through appropriate assessment or earning a grade of "C" or better in MATH 044. Examines the procedures for the removal, repair and installation of machine components. The methods of installation, lubrication practices, and maintenance procedures for industrial machinery are analyzed. Also presented are the techniques involved in the calibration and repair of mechanical devices and the practice in computations pertaining to industrial machinery.

INDT 204 Electrical Circuits 3 Credits

Prerequisites: INDT 113. This course is designed to provide an understanding of circuits using alternating current and the motor operation. Provides fundamentals of single- and three-phase alternating current. Analysis of series and parallel circuits, containing resistance, inductance, and capacitance will be covered. Transformer applications both single phase and three-phase along with power distribution will be covered. This course will give each student a general understanding of common types of electric motors, extending from the small shaded pole fan motors to the large three-phase motors. Direct current motors will also be covered. The student will receive an education in motor theory, magnetism and how it affects motor rotation, and how capacitors affect a motor circuit will be included.

INDT 205 Programmable Controllers I 3 Credits

Prerequisites: INDT 113, ADMF 113, DR EECT 101. Introduces the basic theory, operation and programming of programmable logic controllers. Demonstrates programming examples, set-up examples and troubleshooting, as well as PLC timing, counting, arithmetic and logic and sequencers.

INDT 206 Programmable Controllers II 3 Credits

Prerequisites: INDT 205. Serves as a further introduction to the field of industrial controls. Students will learn the principles of control systems and how they are applied to a production system to achieve automation. Systems included in the courses are stepper motors, programmable logic controllers, microprocessors, computers and feedback systems. Emphasis is placed on programmable logic controllers and the local area network.

INDT 207 Process Control and Automation I 3 Credits

Prerequisites: CIMG 102, MATH 111, INDT 102, INDT 103, INDT 203, INDT 207 and INDT 206. Introduces the student to Process Control and Automation, combining the elements of the prerequisite classes into a culmination of a complete manufacturing process. Basic elements of the automation system and programming fundamentals are studied and individual systems are examined.

INDT 208 Process Control and Automation II 3 Credits

Prerequisites: INDT 207. Continues to explore the Process Control and Automation system combining the new elements with previous classes into the culmination of a more complex manufacturing process. The student will study hardware elements of the automation system and intermediate programming fundamentals for individual systems.

INDT 209 Process Control and Automation III 3 Credits

Prerequisites: INDT 208. Finalizes the Process Control and Automation system by employing new hardware and software elements to complete process. The student will build, operate and troubleshoot the process system to simulate manufacturing procedures.

INDT 210 Pumps 3 Credits

Prerequisites: INDT 104. Covers the construction and operation of centrifugal, reciprocating, metering, special, and rotary pumps and their components. Includes procedures of troubleshooting, installation and maintenance.

INDT 211 Industrial Instrumentation 3 Credits

Prerequisites: INDT 113 and demonstrated competency through appropriate assessment or earning a grade of "C" or better in MATH 050. Provides instruction in the purpose, function, and application of process control instruments relative to manufacturing and industrial technology.

INDT 212 Programmable Controllers III 3 Credits

Prerequisites: INDT 206. Serves as an introduction to advance topics the field of programmable controllers. Use of the latest technology and software will be stressed. ControlLogix, Operator Interfaces, and Networking will be some of the areas covered. In addition use of special high level functions and I/O modules will be covered such as PID loops, servo control, and use of multiple processors.

INDT 213 Pipe Fitting Basics 3 Credits

Prerequisites: INDT 102 or CONT 106. Acquaints the maintenance technician with a basic foundation and pipe fitting skills necessary to make repairs or layout new pipe. Includes determination of the type and quantity of material needed to complete a task and joining those materials in the proper manner with a minimum of supervision.

INDT 214 Advanced Industrial Mechanics I 3 Credits

Prerequisites: INDT 203. Examines the operation and design of mechanical systems including belt drives, chain drives, gearboxes, and bearings. Includes the proper use of portable tools and the study of different metals.

INDT 215 Advanced Industrial Mechanics II 3 Credits

Prerequisites: INDT 203 and INDT 103. Teaches advanced mechanical maintenance skills which specifically include vibration analysis, laser shaft alignment, lubrication oil analysis, pumps, seals, gaskets, and couplings. Half of the semester is also devoted to teaching the basics of heating and air conditioning.

INDT 216 Industrial Automation 3 Credits

Prerequisites: HVAC 105, INDT 207 and TECH 104. Covers the field of industrial automation. Introduces the principles of control systems both analog and digital based. Covers instrumentation and sensors; position, speed, thermal, pressure, flow, and level. Develop an understanding of analog and digital signal conditioning as applied to automated systems. Covers the principles of process controllers both analog and digital. Understand control loop characteristics and tuning.

INDT 217 Advanced Motor Drives 3 Credits

Prerequisites: INDT 103 and HVAC 105. Covers the field of industrial motor drives, dc, ac, servo and stepper motors. Introduces students to

variable voltage dc drives and variable frequency ac drives. Topics covered will include installation, setup, maintenance, and troubleshooting of drive systems.

INDT 218 Power Plant Mechanics 3 Credits

Prerequisites: INDT 207 and MATH 111. Presents the basic elements in the power plant, the function, their mode of operation, and the mechanics, with emphasis on the construction and repair of power plant mechanics. The student selects, troubleshoots, and repairs power plant mechanics.

INDT 231 Safety, Health, and Environment I 2 Credits

Prerequisite: None. Provides an introduction to the field of safety, health, and environmental concerns within the process industry. Within this course, you will be introduced to various types of plant hazards, safety and environmental systems and equipment, and the regulations under which processing plants are governed.

INDT 232 Principles of Quality 3 Credits

Prerequisite: INDT 131. Provides an introduction to the field of quality within the process industry. Students will be introduced to many process industry-related quality concepts including operating consistency, continuous improvement, plant economics, team skills, and statistical process control (SPC).

INDT 233 Process Instrumentation I 3 Credits

Prerequisite: INDT 131. Provides an introduction to the field of instrumentation and covers process variables and the various instruments used to sense, measure, transmit, and control those variables. This course also introduces control loops and the elements that are found in different types of loops, such as controllers, regulators, and final control elements. The course concludes with a study of instrumentation drawings and diagrams and a unit on troubleshooting instrumentation.

INDT 234 Process Troubleshooting 2 Credits

Prerequisite: INDT 132. Course involves instruction in the different types of process technology troubleshooting techniques, procedures, and methods used to solve process problems. Topics include application of data collections and analysis, cause-effect relationships, and reasoning.

INDT 260 Problem Solving and Teamwork 3 Credits

Prerequisites: ENGL 111 and MATH 111, or MATH 118 and Program Advisor Approval. Covers critical thinking skills, collection and analyzing data, and quality control overview, teamwork, problem solving and decision making techniques as they apply to a technological environment. As a capstone course for the Manufacturing and Industrial Technology program, this course is designed to reinforce and apply the knowledge and skills learned in previous communication, mathematics and technical courses and foster team and individual skills through experiments, case studies, problem solving projects, and a writing project.

INDT 272 Control Logic 3 Credits

Prerequisite: None. This course serves as a further introduction to the field of industrial controls. Students will learn the principles of control systems and how they are applied to a production system to achieve automation. Systems included in the courses are stepper motors, programmable logic controllers, microprocessors, computers and feedback systems. Emphasis is placed on programmable logic controllers and the local area network.

INDT 273 Electrical Troubleshooting 3 Credits

Prerequisite: None. Presents methods and techniques for troubleshooting appliances, motors, motor controls, relay wiring, commercial wiring and industrial wiring systems.

INDT 274 Flux Core Arc Welding 3 Credits

Prerequisite: INDT 114 or background in GMAW or Instructor's Approval. Provides basic skills and fundamental knowledge in Flux Core Arc Welding (FCAW). Gas shielded wire as well as Innershield wires are utilized in the course. Safe lab practices include oxy-fuel cutting, plasma arc cutting (P.A.C.), and storage and handling of high pressure cylinders.

INDT 280 Co-op/Internship 1-3 Credits

Prerequisite: Program Advisor Approval. Gives students the opportunity to work at a job site that is specifically related to their career objectives. Provides on-the-job experience while earning credit toward an associate degree.

INSC 101 Introduction to Insurance 3 Credits

Prerequisite: None. Presents an introduction to the profession of insurance. The course includes an overview of the insurance industry, types of coverage that exist, insurance processes and expected outcomes.

INSC 210 Property and Liability Insurance Principles 3 Credits

Prerequisite: Demonstrated competency through appropriate assessment or earning a grade of "C" or better in ENGL 025, ENGL 032, and MATH 044. Provides overview of the insurance business and an understanding of basic principles of property and liability insurance.

INSC 220 Personal Insurance 3 Credits

Prerequisite: INSC 210 or Advisor Approval. Analyzes personal loss exposures and insurance including homeowners and other dwelling coverage, personal liability, inland marine, auto, life, health insurance, and financial planning.

INSC 230 Commercial Insurance 3 Credits

Prerequisite: INSC 220 or Advisor Approval. Explores commercial coverage's and loss exposures including property, business income, marine, crime, boiler and machinery, general liability, auto, workers compensation, business owners, miscellaneous coverages, and surety bonding.

INSE 101 Introduction to Information Systems Security 3 Credits

Prerequisites: CINT 106 and CINT 121. Students will explore the field of information systems security focusing on the technical aspects of the discipline. Students will be introduced to the basic terms, concepts, and buzzwords of computer and network security and best practices, roles and responsibilities of management and security personnel. This course explains the fundamentals of communication, infrastructures, operational security, and methods for preventing attacks, areas of risk management, physical security, and cryptography.

INSE 201 Risk Management/Cyber Terrorism 3 Credits

Prerequisites: INSE 101, CINT 251, and CINT 253. Students will learn principles of incident response and disaster recovery. The student will learn to identify vulnerabilities and take appropriate countermeasures to prevent and mitigate risks to an organization. The student will learn planning, assessing the risks, incident response, contingency planning, and prioritizing systems for disaster recovery. The role of management and the relationships of various members of an organization will be discussed. Students will learn how to create a hardened network by developing and implementing policies and procedures, and how to restore a network in the event of a disaster. Topics of discussion will also include cyber terrorism and its prevention and countermeasures.

INSE 202 Advanced Routers/Firewalls 3 Credits

Prerequisites: INSE 101 and CINT 252. Provides an advanced understanding of the fundamental concepts involved in firewalls, routers, intrusion detection, intrusion prevention and VPNs and where they fit into a network security program. Students will learn advanced installation techniques, discuss how to make intelligent choices in firewall and/or router technology, and learn advanced troubleshooting. This course provides a comprehensive look at their use with other network security components and how they combine with DMZs, routers, and VPNs for optimal perimeter security. The student will study such topics as packet filtering, proxy servers, authentication, encryption, and securing host computers. Hands-on practical application will also be included.

INSE 210 Secure Coding Theory and Application 3 Credits

Prerequisite: CINS 221. Presents the steps for writing, testing, and deploying good, robust, and security-enhanced code. Subjects covered include: Thread modeling, secure code lifecycle, Buffer overflows, race conditions, and format string problems. Inputs and clients, file systems, Cryptography applications, UMLsec, Java security, Reverse engineering.

INSE 211 Cryptography 3 Credits

Prerequisite: INSE 101. Students will learn about cryptography as an indispensable resource for implementing strong security in real-

world applications. Students will learn why conventional crypto schemes, protocols, and systems are vulnerable. The course will cover the foundations of cryptography using simple mathematical proofs: probability, information theory, computational complexity, number theory, and algebraic techniques. The student will assess the strength of several standards and use formal methods to prove their security and efficiency. Students will discuss zero-knowledge protocols: their characteristics, development, arguments, and proofs, symmetrical and asymmetrical encryption, digital signatures, Kerberos, code signing, creation/deployment of strong keys and passwords, Virtual Private Networks, SET, and SSL.

INTD 101 Design Theory 3 Credits

Prerequisites: None. Introduces theory and color dynamics as applied to compositional design. Includes exploration and application of three-dimensional concepts, human factors and the psychology and social influences of space.

INTD 102 Drafting and Construction 3 Credits

Prerequisites: None. Provides an understanding of building structures, residential construction techniques, building materials and blueprint reading. Includes building codes and the preparation of plans, elevations, sections, and details as they relate to construction drawings.

INTD 103 Introduction to Interior Design 3 Credits

Prerequisites: None. An introductory course, which provides students with an overview of the field of interior design. Exercises include small scale space analysis and functional planning based on user needs, application of the principles of design, furniture arrangement and selection, interior finish considerations and presentation techniques.

INTD 104 Textiles for Interiors 3 Credits

Prerequisites: None. An intensive study of textiles from fiber identification and classification to finish. Also introduces the study of interior textile fabrications including window treatments, upholstery, carpet and wall coverings.

INTD 105 Design Presentations 3 Credits

Prerequisites: INTD 102. Presents the elements of two- and three-dimensional representational drawings and design concepts. Studies include basic drawing, drafting and perspective techniques; color rendering, material board preparation and client presentation.

INTD 108 Interior Design II 3 Credits

Prerequisites: INTD 102 and INTD 103 and INTD 105. Presents concept development, programming and space planning of the interior environment. Exercises reinforce creativity and problem solving skills. Emphasizes the relationship between individuals and their surroundings, including studies in human scale, proxemics and design considerations for special populations.

INTD 109 History of Interiors I 3 Credits

Prerequisites: Demonstrated competency through appropriate assessment or earning a grade of "C" or better in ENGL 025 and ENGL 032. Survey of the development of the interrelationship of architecture, interiors, furniture, and decorative arts from antiquity through the ages.

INTD 110 History of Interiors and Furniture 3 Credits

Prerequisites: Demonstrated competency through appropriate assessment or earning a grade of "C" or better in ENGL 025 and ENGL 032. Survey of the development of the interrelationship of architecture, interiors, furniture, and decorative arts from antiquity through the ages.

INTD 115 Basic CAD for Interior Designers 3 Credits

Prerequisite: INTD 102, demonstrated competency through appropriate assessment or earning a grade of "C" or better in MATH 050 or MATH 070. Introduces fundamentals of Computer-Aided Drafting (CAD) for environmental designers. Includes overview of CAD systems, use of software, and printer/plotter applications.

INTD 200 Lighting and Building Systems 3 Credits

Prerequisites: INTD 102 and INTD 216. Presents the integration of commercial and institutional interior design and architectural detailing. Includes the impact of mechanical and electrical systems, acoustics and codes. Special emphasis will be placed on lighting technology and application.

INTD 201 Interior Materials 3 Credits

Prerequisites: Demonstrated competency through appropriate assessment or earning a grade of "C" or better in MATH 044. Examines the physical properties and characteristics of various furniture and decorative materials, finishes, and architectural detailing including floor and wall treatments. Addresses environmental issues and problems in specifying, estimating, and installing these materials.

INTD 202 Contract Design 3 Credits

Prerequisites: INTD 216 and INTD 108. Studies include commercial technological and base building requirements, barrier-free, building and life safety codes, analysis of existing conditions, client interview, and square footage and space planning standards. Emphasis is on task analysis and workstation design, systems and equipment manufacturers and finish selections within the office.

INTD 203 Professional Practice 3 Credits

Prerequisites: INTD 103 or GRDN 114. Introduction to business principles and practices as they relate to the environmental design profession. Includes business formation and management, professional ethics and organizations, certification and licensing, design liability and project management. Special topics involving consumer behavior, sales techniques and fee structuring will also be addressed.

INTD 204 Interior Design III 3 Credits

Prerequisites: Program Advisor Approval. Students will research and develop creative project solutions for commercial interiors in visual merchandising, hospitality, adaptive reuse and special population projects. Students will define, research, and develop a program for an advanced design problem including concept development, space planning, all necessary working drawings and specifications and appropriate presentation materials.

INTD 209 Portfolio Preparation/Internship 3 Credits

Prerequisites: Program Advisor Approval. Efforts are directed toward achieving a career in environmental design. Includes a comprehensive program assessment exam, the development of a quality portfolio and resume, and necessary field experience.

INTD 211 Kitchen and Bath Design 3 Credits

Prerequisites: INTD 102 and INTD 201. Involves the requirements and space planning for kitchens and baths, utilizing both standard and custom cabinetry and fixtures. Topics also include casework for media and conference centers.

INTD 212 Historic Preservation 3 Credits

Prerequisites: INTD 102 and INTD 109. Introduces the process of establishing historic properties. Preservation, restoration and adaptive reuse will be differentiated as applied to both public and private properties. Includes appropriate exterior and interior color and finish selections, and architectural detailing.

INTD 215 Advanced CAD and Digital Rendering 3 Credits

Prerequisite: INTD 115, INTD 216. Reviews the fundamentals of Computer-Aided Drafting (CAD) for environmental designers. Includes overview of advanced architectural CAD systems and use of 3-D and rendering software.

INTD 216 CAD for Environmental Designers 3 Credits

Prerequisites: INTD 102. Introduces fundamentals of CAD (Computer-Aided Drafting) for environmental graphics. Includes overview of CAD and systems use of software and plotter applications. Each student will complete an individual project by the end of the semester.

INTD 217 Visual Merchandising 3 Credits

Prerequisites: None. Presents students with a survey of the many elements of visual merchandising and display currently used in retail design and decorative accessorization to attract customers. Students are introduced to the principles of retail space planning, fixture arrangement and the display equipment required in visual merchandising including fixtures, mannequins, signage, lighting and props. Includes research in marketing, color psych, and lighting. Field trips and hands-on projects are an integral part of the course.

INTD 223 History of Interiors II 3 Credits

Prerequisites: INTD 109 or ARTH 101. An in-depth exploration of the movements in architecture and interior design from the late 19th century to the present.

INTD 224 Travel Study

3 Credits
Prerequisites: Program Advisor Approval. Offers the student an opportunity to study the culture and history of another region, with an emphasis on art, architecture, interior and garden design. Includes pre-trip meetings and lectures, trip journals and summary papers.

INTD 233 Sustainable Design

3 Credits
Prerequisite: GRDN 114 or INTD 103. Introduces the fundamental principles in the ecological planning and development of the natural and built home and work environment. Presents the concepts of human impact on the environment through studies involving site selection and analysis, soil and climate conditions, efficient space planning and building design, renewable and environmentally responsible construction methods, material selections and sustainable practices.

INTD 241 Faux Finishing: Basic Glazing Techniques

1 credit
Prerequisites: None. Presents the basics in glazing techniques and wall finishes including traditional and contemporary single and multi-colored wall glazing. Pigment selection, surface preparation, and handling of materials will be discussed and demonstrated.

INTD 242 Faux Finishing: Italian Plasters

1 credit
Prerequisites: None. Introduces the traditional Italian plaster finishes. Learn how to replicate and incorporate the beautiful textures of the Old World into the modern setting. The history of lime-based plasters and the interior decorative arts will be discussed.

INTD 243 Faux Finishing: Patterns and Stenciling

1 credit
Prerequisites: None. Introduces the use of stencils and hand painted patterns that will repeat and match perfectly. Learn techniques to cut patterns and to paint them on the wall or furniture pieces.

INTD 244 Faux Finishing: Advanced Glazing Techniques

1 credit
Prerequisites: INTD 241. Presents the latest trends in advanced glazing techniques and wall finishes. Students will explore in-depth an advanced level of faux and decorative finishing while building proficiency in both techniques and product knowledge.

INTD 245 Faux Finishing: Painted Furniture and Decorative Accessories

1 credit
Prerequisites: INTD 241. Covers the techniques of creating unique, one-of-a-kind painted furniture and decorative accessories pieces. Students will learn how to create a variety of professional finishes including multi-layered painted and wood-toned finishes that are suitable over raw wood, pre-existing finishes and painted base coats.

INTD 246 Faux Finishing: Floors and Floor Coverings

1 credit
Prerequisites: INTD 243. Building on the skills acquired in the INTD

243 course, students will learn the processes and materials required to create faux floor finishes and floor coverings. Instruction will be given in color, design, painting and finishing techniques. Each student will make one 5'x 8' floor cloth.

INTD 247 Faux Finishing: Frescoes and Murals

1 credit
Prerequisites: ARTS 120 or INTD 105. Applies basic drawing and perspective skills to create frescoes, murals and trompe l'oeil on the wall palette.

INTD 280 Co-op/Internship

1-6 Credits
Prerequisites: Program Advisor Approval. Students work at job sites that are specifically related to career objectives. Provides on-the-job experience while earning course credit.

IVYT 070 College and Life Success

3 Credits
Prerequisites: None. Enhances success in college by assisting students in obtaining skills necessary to reach their educational, career, and life objectives. Topics include time management, memory techniques, textbook usage, note taking, test taking, problem solving and decision making, group interaction, communication skills, and resource and technology utilization.

IVYT 071 Study Skills Survey

1 Credit
Prerequisites: None. Enhances success in college by assisting students in obtaining skills necessary to reach their educational, career, and life objectives. Topics include memory, reading, note-taking, test-taking techniques, strategies for scheduling time to study, and dealing with test anxiety.

IVYT 072 Research Strategies

1 Credit
Prerequisites: None. Enhances success in college by assisting students in obtaining skills necessary to reach their educational, career, and life objectives, specifically in the area of information literacy. Students will learn how to use an email account and a variety of online resource information databases. Students will learn how to gather required information for source citation when summarizing, paraphrasing, and quoting resources. The course also addresses basic issues concerning informational integrity.

IVYT 073 Styles of Learning

1 Credit
Prerequisites: None. Enhances success in college by assisting students in obtaining skills necessary to reach their educational, career, and life objectives. Students will learn a holistic, integrated, principle-centered approach for solving academic challenges. This course represents a step-by-step learning process which provides effective tools that help students adapt to change.

IVYT 101 First Year Seminar

1 Credit
Prerequisites: None. Provides students with specific skills and strategies necessary to reach their educational, career, and life objectives. Topics include time management, study skills, learning styles, campus and community resources, critical thinking, utilization of tech-

nology, career skills, and diversity in society.

IVYT 102 Information Studies and Research Skills

1 Credit
Prerequisites: None. Introduces students to a variety of information skills; understanding how information and knowledge is produced and organized; creating a strategy for finding information; using and identifying print and electronic resources; locating and evaluating information found; citing and documenting information appropriately; and understanding issues relating to intellectual freedom and copyright laws.

IVYT 103 Health and Wellness

1 Credit
Prerequisites: None. Educates students about the importance of fitness/ wellness in their everyday lives. Students will have the opportunity to customize their own behavioral plans for fitness/wellness.

IVYT 104 Critical Thinking

1 Credit
Prerequisites: None. Assists students in developing critical thinking strategies with academic and workplace applications.

IVYT 105 Managing Personal Finances

1 Credit
Prerequisites: None. An overview of how to manage personal finances. The course includes information in the areas of personal finances, loans, credit and investing.

IVYT 106 Career Exploration

1 Credit
Prerequisites: None. Enhances success in college by assisting students in obtaining the skills necessary to identify their life, educational, and career goals, specifically in the area of academic and programmatic offerings that support possible career choices.

IVYT 107 Professional Presence

1 Credit
Prerequisites: None. Provides students with the opportunity to develop a professional presence in business and social settings. Topics include professional communication, proper etiquette and job attainment skills.

IVYT 108 Academic Portfolio and Project Development and Management

1 Credit
Prerequisites: None. A study of the basic project and portfolio process and provides students with the opportunity to plan and develop a project or portfolio for academic or professional presentation.

IVYT 109 Online Learning Technologies

1 Credit
Prerequisites: None. Prepares students to succeed in an online learning environment. The course provides an opportunity to demonstrate intellectual, social, and technical skills through the use of online technologies. This course also prepares students for online learning and training opportunities in the workplace.

IVYT 110 Transfer Success

1 Credit
Prerequisites: None. Examines the essential skills and information needed for transfer to a four-year institution. Emphasizes developing

an individual transfer plan.

IYVT 120 New Student Seminar 3 Credit

Prerequisites: Minimum entry assessment. Enhances success in college by assisting students in obtaining skills necessary to their educational, career, and life objectives. Students will create and apply critical thinking strategies in areas of time management, media literacy, learning styles, study skills, career planning, money management, and resource utilization.

LAND 101 Landscape Trees 3 Credits

Prerequisites: None. Identification of shade, ornamental, and evergreen trees. Including evaluating species quality, growth habits, site adaptability; covers 125 species important to landscaping tree care.

LAND 102 Shrubs and Other Plants 3 Credits

Prerequisites: None. The identification of 125 shrubs, vines, ground covers, and herbaceous plants important to landscaping including evaluation of growth habits, species quality, and site adaptability.

LAND 103 Landscape Management I 3 Credits

Prerequisites: None. Methods in the practice of landscaping, tree care, and turf management are briefly introduced through lectures, slides, videos, and field trips. Weed problems and their control are studied. A large segment of the course is devoted to the study of non-pathogenic problems of landscape plants and turf as well as their pathogenic diseases, and management of these problems.

LAND 104 Turf Management 3 Credits

Prerequisites: None. A study of the particular growth characteristics of the grass species used in lawn areas in the Midwest and Great Lakes area. Also covers the competitive influences and how to control these problems and promote good turf.

LAND 105 Landscape Botany 3 Credits

Prerequisites: Program Chair Approval. The study of the life of a plant; cell structure; the structure and function of roots, stems, leaves, flowers, and seeds; the assimilation of water and nutrients in the plants growth and the stages of development as well as the place and importance of soils. This class is important to one seeking qualification as a licensed pesticide applicator.

LAND 106 Landscape Design I 3 Credits

Prerequisites: LAND 101 and LAND 102. Landscape drafting techniques and basic landscape planning for residential and small business settings utilizing the proper selection of ornamental plants consistent with design and environmental requirements. Included are lectures, slide and film presentations, and lab work with drafting tools and equipment.

LAND 201 Landscape Management II 3 Credits

Prerequisites: LAND 103. Takes advantage of growing season experiences to reinforce what is taught in the prerequisite course by text-

book and lecture. Actual on-site observation, as well as hands on experience is planned. Actual practice in the monitoring of pest problems is given.

LAND 202 Landscape Design II 3 Credits

Prerequisites: LAND 106. A follow up to Landscape Design I to show and give practice in somewhat more sophisticated techniques such as enhancement of drawing by color-use. Also, guidance and practice in making elevation drawings is given. Some introduction to the use of computer-aided drawings is given to the student.

LAND 203 Insect Pests of Ornamentals 3 Credits

Prerequisites: Program Chair Approval. Covers insect identification, structure, and life history; pest management of insects important to landscaping and tree care.

LAND 204 Herbaceous Ornamentals and Grasses 3 Credits

Prerequisites: Program Chair Approval. The identification of 125 annuals, perennials, and grasses that is important to landscape management. Slides and videos are used to introduce a list of non-woody plants which students may encounter in operating a landscape business. Bed principles for effective landscape displays will be covered. Cultural practices propagation technique, foliage, and flower descriptions, watering, disease and insects are discussed.

LAND 205 Tree Care Practices 3 Credits

Prerequisites: LAND 101. Covers the basic knowledge and techniques used by one employed as an arborist in the care of larger mature trees. Includes climbing, pruning, take-downs, removals, soil relationships and fertilization, tools and equipment, and safety procedures.

LAND 206 Fundamentals of Horticulture 3 Credits

Prerequisites: Program Chair Approval. Studies the basic horticulture of plant structure, growth, function, and development, including propagation, maintenance, and selection. Studies will include use of fertilization and pesticides for the control of diseases and pests.

LAND 207 Soils 3 Credits

Prerequisites: None. Studies the growth habits and culture of plants not particularly ornamental or frequently used in the landscape. However, knowledge of these plants will be useful to one employed in a garden center or service organization where this person is frequently expected to know answers to questions pertaining to gardening and horticulture.

LIBA Liberal Arts Capstone Course 1 Credit

Prerequisites: Successful completion of 40 program hours and Program Advisor approval. Provides a culminating experience designed to demonstrate the student's mastery of information literacy; ethical and responsible behavior; political, social and environmental responsibility; and diversity awareness, both in general and in the student's area of concentration. May require a research proj-

ect, presentation, and/or portfolio. Requires students to complete two sections of a college-approved standardized assessment of proficiency in math, writing, scientific inquiry, and/or critical thinking.

LIBR 101 Introduction to Libraries and Library Services 3 Credits

Prerequisites: Demonstrated competency through appropriate assessment or earning a grade of "C" or better in ENGL 025 and ENGL 032. Surveys the history, organization, services, and functions of libraries. Provides Library Technical Assistant students with an introduction to and overview of the Library field and the different types of libraries.

LIBR 102 Introduction to Reference Sources and Services 3 Credits

Prerequisites: Demonstrated competency through appropriate assessment or earning a grade of "C" or better in ENGL 025 and ENGL 032. This course gives an overview of the reference function with emphasis on the role of the LTA. Emphasis is placed on developing a working knowledge of basic reference tools and sources, both print and online. An awareness of the reference interview techniques and process is also gained.

LIBR 103 Introduction to Libraries Public Services 3 Credits

Prerequisites: Demonstrated competency through appropriate assessment or earning a grade of "C" or better in ENGL 025 and ENGL 032. Overview of the role of the Library Technical Assistant (LTA) in library public service areas such as reference, circulation, interlibrary loan, bibliographic instruction, children and young adult services, and public relations and promotions, with in depth coverage of circulation and interlibrary loan. The course will also focus on the development of customer service and effective communication skills.

LIBR 104 Introduction to Technical Services 3 Credits

Prerequisites: Demonstrated competency through appropriate assessment or earning a grade of "C" or better in ENGL 025 and ENGL 032. This course is designed to prepare Library Technical Assistants with the skills necessary to assist in acquisitions and processing, serials control, resource preservation and maintenance. Emphasis will be placed on processes necessary for seamless incorporation of technical services into library services delivered to patrons.

LIBR 201 Cataloging and Classification 3 Credits

Prerequisites: Demonstrated competency through appropriate assessment or earning a grade of "C" or better in ENGL 025 and ENGL 032. Introduces students to the basic concepts of classification and cataloging within a library setting. Emphasis is placed on the development of a working knowledge of both descriptive and subject cataloging resources, Library of Congress and Dewey Decimal classification systems, copy cataloging, and MARC format.

LIBR 202 Electronic Resources and**Online Searching****3 Credits**

Prerequisites: Demonstrated competency through appropriate assessment or earning a grade of "C" or better in ENGL 025 and ENGL 032. This course introduces students to essential electronic information sources (library catalogs, digital libraries, academic or gated databases, government resources, and the Internet) used in a variety of library environments, along with the online searching skills needed to effectively use them. The course emphasizes hands-on training with resources available in Indiana (through INSPIRE and Ivy Tech's Virtual Library), Boolean logic and other search strategies, copyright issues regarding digital information, retrieving, evaluating and citing information.

LIBR 203 Library Services for Children**3 Credits**

Prerequisites: Demonstrated competency through appropriate assessment or earning a grade of "C" or better in ENGL 025 and ENGL 032. An overview of the materials and services for children and young adults in a public library with emphasis on the role of the LTA. Emphasis is placed on developing a working knowledge of programming for youth ages 0-18. This course will also provide an overview of children's literature, both classic and contemporary, and reference resources that will assist the LTA in providing reader's advisory to youth.

LIBR 204 Library Media Center Operations and Services**3 Credits**

Prerequisites: Demonstrated competency through appropriate assessment or earning a grade of "C" or better in ENGL 025 and ENGL 032. An overview of the role of the Library Technical Assistant (LTA) in a School Library Media Center by offering an introduction to the purposes, functions, services, and organizational structure of school library media centers. Basic materials, policies, procedures, philosophies, terminology, and services that make up today's media center services will be covered. A variety of activities will be included, such as field trips, online and written presentations, and group discussions and projects.

LIBR 205 Library and Media Materials and Equipment**3 Credits**

Prerequisites: Instructor Approval. Covers the fundamentals of library/media center technology, including instructional technology, educational media, computers, and related technologies. The course covers basic library/media center technology concepts, media utilization, and the use of computers in support of teaching and learning.

LIBR 206 Library Assistant Practicum**3 Credits**

Prerequisites: Regional Library Technical Assistant Advisor Approval. Students will gain new and varied support staff experiences compatible with their career plans, completed coursework and past

work history. Special emphasis will be put on workplace survival skills and job seeking skills.

LOGM 101 Introduction to Materials Management**3 Credits**

Prerequisites: Demonstrated competency through appropriate assessment or earning a grade of "C" or better in ENGL 025, ENGL 032. Studies factors influencing the flow of materials in a manufacturing enterprise. Covers basics of production planning and control, purchasing, forecasting, inventory and distribution issues. Concludes with an overview of just-in-time theory and practices.

LOGM 202 Physical Distribution**3 Credits**

Prerequisites: Demonstrated competency through appropriate assessment or earning a grade of "C" or better in ENGL 025 and ENGL 032. Focuses on the major concepts and rationale for utilizing warehouse inventories to lower costs of transportation, improve customer service, avoid stockouts, and improve purchasing economics and seasonal variability.

MATH 040 Basic Mathematics Skills**3 Credits**

Prerequisites: Demonstrated competency through appropriate assessment. Concentrates on basic operations with whole numbers, fractions, decimals and their applications. Introduces a variety of math learning strategies. Includes United States Customary Measurement System.

MATH 044 Mathematics**3 Credits**

Prerequisites: Demonstrated competency through appropriate assessment or earning a grade of "C" or better in MATH 040. Reviews basic operations with fractions, decimals and their applications. Concentrates on ratio, proportion, percents, measurement, geometric concepts, signed numbers, interpreting and constructing graphs, basic linear equations, and applications. A developmental mathematics course.

MATH 050 Basic Algebra**3 Credits**

Prerequisites: Demonstrated competency through appropriate assessment or earning a grade of "C" or better in MATH 044. Reviews signed numbers and basic linear equations. Concentrates on integer exponents, scientific notation, linear equations and inequalities, literal equations, polynomial operations, polynomial factoring, graphing linear equations, and applications. A developmental algebra course.

MATH 070 Elements of Algebra and Geometry**3 Credits**

Prerequisites: Demonstrated competency through appropriate assessment or a grade of "C" or better in MATH 044. Blends basic algebraic skills and relationships with geometric applications. Although the disciplines of algebra and geometry are often perceived as separate in the study of mathematics, this course utilizes

algebraic skills in simplifying expressions, manipulating variables, solving equations, and graphing linear relationships to solve real-world geometric applications of area, volume, polygons, polyhedra, and right triangles. Designed to prepare students for MATH 117.

MATH 080 Mathematics Principles with Algebra**3 Credits**

Prerequisites: Demonstrated competency through appropriate assessment or earning a grade of "C" or better in MATH 044. Reviews signed numbers and basic linear equations. Concentrates on percents, proportions, measurement, exponents, square roots, linear equations and inequalities, literal equations, graphing linear equations, and applications. Designed to prepare for success in MATH 118.

MATH 111 Intermediate Algebra**3 Credits**

Prerequisites: Demonstrated competency through appropriate assessment or a grade of "C" or better in MATH 050. Reviews basic operations of polynomials, scientific notation, linear equations and inequalities, graphing linear equations, and factoring algebraic expressions. Concentrates on properties of integer and rational exponents, rational expressions and equations, systems of linear equations, radicals, radical equations, quadratic equations, functions and their graphs, and applications. A standard college level intermediate algebra course.

MATH 117 The Art of Geometry**3 Credits**

Prerequisites: Demonstrated competency through appropriate assessment or a grade of "C" or better in MATH 050 or MATH 070. This course emphasizes visualization and appreciation of the beauty of mathematics through geometry; translates between visual and symbolic representations of objects used in art and design; applies mappings, symmetry, similarity, vectors, and geometric constructions of shapes to working with 2D and 3D figures; uses geometry software, hands-on techniques and models.

MATH 118 Concepts in Mathematics Transferin**3 Credits**

Prerequisites: Demonstrated competency through appropriate assessment or a grade of "C" or better in MATH 050 or MATH 080. Through real world approaches, presents mathematical concepts of measurement, proportion, interest, equations and inequalities, probability and statistics. Brief survey of college mathematics.

MATH 121 Geometry-Trigonometry**3 Credits**

Prerequisites: Successful completion of MATH 111 or demonstrated competency through appropriate assessment. Includes polygons, similar figures, geometric solids, properties of circles, constructions, right triangles, angle measurements in radians and degrees, trigonometric functions and their application to right triangles, Pythagorean Theorem, laws of sine and cosine, graphing of trigonometric functions, trigonometric identities, vectors and polar coordinates. Introductory study of geometry and trigonometry.

MATH 127 Mathematics for Elementary**Education I****3 Credits**

Prerequisites: MATH 111 or MATH 118. The course gives a theoretical treatment of common topics underlying an elementary mathematics curriculum. This course covers topics in elementary number theory. Students will be encouraged to explore, make and debate conjectures, build connections among concepts, and solve problems from their explorations. The selection of topics presented in this course is based upon standards and recommendations for the mathematical content knowledge essential for prospective teachers made by the National Council of Teachers of Mathematics.

MATH 128 Mathematics for Elementary**Education II****3 Credits**

Prerequisites: MATH 111 or MATH 118. This course gives a theoretical treatment of common topics underlying an elementary mathematics curriculum. This course covers algebraic equations, probability, and statistics. Students will be encouraged to explore, make and debate conjectures, build connections among concepts, and solve problems from their explorations. The selection of topics presented in this course is based upon standards and recommendations for the mathematical content knowledge essential for prospective teachers made by the National Council of Teachers of Mathematics.

MATH 129 Mathematics for Elementary**Education III****3 Credits**

Prerequisites: MATH 111 or MATH 118. The course gives a theoretical treatment of common topics underlying an elementary mathematics curriculum. This course covers plane and solid geometry, and measurement. Students will be encouraged to explore, make and debate conjectures, build connections among concepts, and solve problems from their explorations. The selection of topics presented in this course is based upon standards and recommendations for the mathematical content knowledge essential for prospective teachers made by the National Council of Teachers of Mathematics.

MATH 131 Algebra/Trigonometry I**3 Credits**

Prerequisites: Successful completion of MATH 111 or demonstrated competency through appropriate assessment. Presents an in-depth study of functions, quadratic, polynomial, radical, and rational equations, radicals, complex numbers, right triangle trigonometry, oblique triangles, vectors, and graphs of sine and cosine functions. First in a series of two courses of College Algebra/Trigonometry.

MATH 132 Algebra/Trigonometry II**3 Credits**

Prerequisites: MATH 131. Continues study of algebra and trigonometry including systems of equations, matrices, graphing of trigonometric functions, trigonometric equations and identities, rectangular and polar coordinates, complex numbers, exponential and logarithmic functions and conics. Second in a series of two courses of College Algebra/Trigonometry.

MATH 133 College Algebra with**Analytic Geometry****4 Credits**

Prerequisites: Successful completion of MATH 111 or demonstrated competency through appropriate assessment. Presents an in-depth study of functions, quadratic, polynomial, radical, and rational equations, radicals, complex numbers, systems of equations, matrices, exponential and logarithmic functions, and conics. A standard College Algebra course.

MATH 134 Trigonometry**2 Credits**

Prerequisites: Successful completion of MATH 111 or demonstrated competency through appropriate assessment. Presents an in-depth study of right triangle trigonometry, oblique triangles, vectors, graphs of trigonometric functions, trigonometric identities and equations and complex numbers in rectangular and polar/trigonometric forms, rectangular and polar coordinates. A standard college trigonometry course.

MATH 135 Finite Math**Transfer IN 3 Credits**

Prerequisites: Successful completion of MATH 111 or demonstrated competency through appropriate assessment. Surveys solving and graphing linear equations and inequalities, elementary set theory, matrices and their applications, linear programming, and elementary probability. A standard finite mathematics course.

MATH 136 College Algebra**Transfer IN 3 Credits**

Prerequisites: Successful completion of MATH 111 or demonstrated competency through appropriate assessment. Presents an in-depth study of functions, quadratic, polynomial, radical, and rational equations, radicals, complex numbers, systems of equations, matrices, rational functions and exponential and logarithmic functions. MATH 136 and MATH 137 together comprise a standard two-semester college algebra and trigonometry course.

**MATH 137 Trigonometry with Analytic
Geometry****Transfer IN 3 Credits**

Prerequisites: Successful completion of MATH 131, MATH 133 or MATH 136 or demonstrated competency through appropriate assessment. Presents an in-depth study of right triangle trigonometry, oblique triangles, vectors, graphs of trigonometric functions, trigonometric identities and equations and complex numbers in rectangular and polar/trigonometric forms, rectangular and polar coordinates and conics.

**MATH 141 Mathematics for Elementary
Teachers****4 Credits**

Prerequisites: Demonstrated competency through appropriate assessment or MATH 111 or MATH 112. An in-depth treatment of common topics underlying an elementary mathematics curriculum. Students in the course will gain an appreciation for mathematics and will add to their pedagogical expertise by gaining conceptual understanding of

elementary mathematics through the use of selected modes, materials, and problem solving situations. The course is designed to connect knowledge of the real number system to other subjects. The selection of topics presented in this course is based upon standards and recommendations for the mathematical content knowledge essential for prospective teachers made by the National Council of Teachers of Mathematics, the Mathematical Association of America, and the Indiana Professional Standards Board.

MATH 200 Statistics**3 Credits**

Prerequisites: MATH 131 or MATH 133 or MATH 135 or MATH 136. Provides study in the collection, interpretation and presentation of descriptive and inferential statistics, including measures of central tendency, probability, binomial and normal distributions, hypothesis testing of one- and two-sample populations, confidence intervals, chi-square testing, correlation, data description and graphical representations. An introductory statistics course.

MATH 201 Brief Calculus I**Transfer IN 3 Credits**

Prerequisites: MATH 131, MATH 133 or MATH 136. An introductory course in calculus. Fundamental concepts and operations of calculus including algebraic, exponential and logarithmic functions; limits; continuity, derivatives, points-of-inflection, first-derivative test, concavity, second-derivative test, optimization, antiderivatives, integration by substitution, and elementary applications of the derivative and of the definite integral.

MATH 202 Brief Calculus II**Transfer IN 3 Credits**

Prerequisites: MATH 201. Covers topics in elementary differential equations, calculus of functions of several variables and infinite series.

MATH 211 Calculus I**Transfer IN 4 Credits**

Prerequisites: Demonstrated competency through appropriate assessment or MATH 131 and MATH 132 or MATH 133 and MATH 134 or MATH 136 and MATH 137. Reviews the concepts of exponential, logarithmic and inverse functions. Studies in depth the fundamental concepts and operations of calculus including limits, continuity, differentiation including implicit and logarithmic differentiation. Applies differential calculus to solve problems in the natural and social sciences, to solve estimation problems and to solve optimization problems. Applies differential calculus to sketch curves and to identify local and global extrema, inflection points, increasing/decreasing behavior, concavity, behavior at infinity, horizontal and vertical tangents and asymptotes, and slant asymptotes. Applies the concept of Riemann sums and antiderivatives to find Riemann integrals. Applies the fundamental theorem of calculus to solve initial value problems, and to find areas and volumes and the average values of a function.

MATH 212 Calculus II**Transfer IN 4 Credits**

Prerequisites: MATH 211. Studies the techniques of substitution, integration by parts, trigonometric integrals, partial fractions and

trigonometric substitution to evaluate integrals. Applies Simpson's rule and other elementary numerical quadrature methods to approximate integrals. Applies the integral calculus to find arc lengths, areas of surfaces of revolution and to solve force and work problems. Applies the direction field technique to find graphical solutions of differential equations. Applies Euler's technique to approximate the solution of initial value problems. Studies techniques of solving separable differential equations. Studies techniques to determine convergence of sequences and series. Studies techniques to determine the power series representation of functions.

MATH 218 Calculus with Analytic Geometry I 5 Credits

Prerequisites: Demonstrated competency through appropriate assessment or MATH 131 and MATH 132 or MATH 133 and MATH 134 or MATH 136 and MATH 137. Topics from analytic geometry, concept and properties of limits, concept of mathematical continuity definition and procedures for differentiation, and definition and procedures for anti-differentiation.

MATH 219 Calculus with Analytic Geometry II 5 Credits

Prerequisites: MATH 218. Topics from Calculus and Analytic Geometry I, calculus to hyperbolic and inverse trigonometric functions, first and second order differential equations, integration by parts and partial fractions, convergence, Taylor and Maclaurin series expansions, and L'Hôpital's rule.

MATH 221 Calculus for Technology I 3 Credits

Prerequisites: Demonstrated competency through appropriate assessment, or MATH 131 and MATH 132 or MATH 133 and MATH 134 or MATH 136 and MATH 137. First course in a two-semester sequence in the techniques of calculus, with an emphasis on how they are applied to technology. Topics include limits, continuity, first and second derivatives, definite and indefinite integrals, and applications of these concepts.

MATH 222 Calculus for Technology II 3 Credits

Prerequisites: MATH 221. Second course in a two-semester sequence in the techniques of calculus, with an emphasis on how they are applied to technology. Topics include the calculus of transcendental functions, techniques of integration, differential equations, infinite series, and applications of these concepts.

MATH 235 Discrete Mathematics 3 Credits

Prerequisites: MATH 135. Introduction to the suite of mathematical and logical tools used in information sciences including automata and computability theory, elementary probability and statistics, and basics of classical information theory.

MATH 261 Multivariate Calculus 4 Credits

Prerequisites: MATH 212 or MATH 219. Solid analytic geometry, par-

tial differentiation, multiple integrals.

MATH 264 Differential Equations 3 Credits

Prerequisites: MATH 261. A first course in ordinary differential equations. The course will develop topics from a dynamical systems perspective and use technology to treat these topics graphically, numerically, and analytically. In addition to the skills of logical analysis and creative problem solving, this course will enhance the student's ability to analyze problems orally and in writing, in addition to mastering the mathematical skills used in this analysis.

MATH 265 Linear Algebra 3 Credits

Prerequisites: MATH 212. An introduction to linear algebra. Systems of linear equations, matrix algebra, vector spaces, determinants, eigenvalues, eigenvectors, diagonalization of matrices, applications.

MEAS 102 First Aid and CPR 2 Credits

Prerequisites: None. Provides students with information to recognize emergency situations, know proper course of action with different types of emergencies, and apply appropriate first aid including CPR.

MEAS 107 Administrative I 3 Credits

Prerequisites: Demonstrated competency through appropriate assessment or earning a grade of "C" or better in ENGL 025 and ENGL 032. Provides a basic understanding of the administrative duties and responsibilities pertinent to medical offices. Includes instruction in medical correspondence and records, case histories of patients, filing, telephone procedures, appointment scheduling, receptionist duties, and processing mail. Includes simulated data entry for patient's record, and appointment scheduling. Written, verbal and nonverbal communication according to patient needs are covered as well as documentation and associated legal and ethical boundaries. Medical law, ethics, state and federal laws are covered.

MEAS 108 Administrative II 3 Credits

Prerequisites: Demonstrated competency through appropriate assessment or earning a grade of "C" or better in MATH 044, ENGL 025 and ENGL 032. Provides instruction in medical office financial administration, bookkeeping, materials management, daily financial transactions with patients and outside sources, banking procedures, billing and collection. General office policies, patient instruction according to needs and regarding health issues. Inventory management of supplies and equipment is covered. Community resources available to patients are also explored.

MEAS 135 Medical Word Processing and Transcription 3 Credits

Prerequisites: HLHS 101 and OFAD 019. Develops skills and knowledge of medical dictation, machine transcription, and word processing software. Includes typing and transcription of medical correspondence and a variety of medical reports.

MEAS 137 Medical Insurance and Basic Coding with Computer Applications 3 Credits

Prerequisites: HLHS 101. Provides an overview of medical insurance programs and the skills needed in handling insurance forms, CPT and ICD 9-CM coding and insurance reports as applied to the medical office. Includes simulated computer data entry for patient records, procedure and diagnostic codes, insurance processing and electronic transmission of claims.

MEAS 151 Pharmacy Technician I 3 Credits

Prerequisites: HLHS 101 and demonstrated competency through appropriate assessment or earning a grade of "C" or better in MATH 050. **Corequisites:** MEAS 152. Introduces basic skills and information needed for a career as a Pharmacy Technician in the state of Indiana.

MEAS 152 Pharmacy Technician II 3 Credits

Prerequisites: None. **Corequisites:** MEAS 151. Theory is applied through performance of competency levels of the technical pharmacy task including: properly preparing, documenting and processing prescriptions according to pharmacy policy and regulations; preparation of intravenous and special solutions; proper preparation and maintenance of records appropriate to the pharmacy, including quality control records, controlled substances (narcotic drug distribution), prescription data and records; application of basic principles of microbiology; aseptic techniques; and the operation and maintenance of the laminar hood. The student will utilize proper communication skills (both written and verbal). Identification and adherence to check points will be emphasized. Current national and Indiana Law and administrative rules as they relate to the practice of the pharmacy technician will be presented. The importance of adherence to universal precautions will be discussed.

MEAS 205 Introduction to Electrocardiography 3 Credits

Prerequisites: HLHS 101. Presents the rationale for obtaining an electrocardiogram as well as related theory including anatomy and physiology, procedural technique and equipment utilized. Students will be introduced to basic rhythm analysis including recognizing standard electrical waves and accurately measuring each normal sinus rhythm and basic arrhythmias.

MEAS 206 Advanced Electrocardiography Technique 3 Credits

Prerequisites: MEAS 205. Discusses related anatomy and physiology of the cardiovascular system, identification of cardiac arrhythmias, their rhythm strip appearance and common treatment modalities. Also includes event and Holter monitoring.

MEAS 207 Integrated Medical Office Procedures 3 Credits

Prerequisites: MEAS 107 and MEAS 108. Provides instruction in med-

ical office procedures using integrated computer programs that manage appointments, insurance documents, file maintenance and creation, management of medical correspondence, licensing and software update processes and data back-up files.

MEAS 208 Respiratory Therapy in

Ambulatory Care

3 Credits

Prerequisites: APHY 102, HLHS 101 and program chair approval. Prepares students who are planning to work in ambulatory care as medical assistants to aid patients with respiratory disease. The course will provide learning and instruction in the use of oxygen and humidity therapies; hyperinflation and positive expiratory pressure therapies; aerosolized medication therapy; respiratory system assessment; respiratory diseases; asthma education for patients, and prepare the student to coordinate care with home care providers for patients with respiratory disease.

MEAS 212 Phlebotomy

3 Credits

Prerequisites: HLHS 101 and MEAS Program Chair Approval. Presents the principles and practices of laboratory specimen collection and processing. Also covers medical terminology, infection control, patient identification, anatomy and physiology, anticoagulants, blood collection, specimen processing and interpersonal skills.

MEAS 213 Advanced Insurance Coding

3 Credits

Prerequisites: MEAS 137. Comprehensive coding skills and guidelines for both ICD-9 and HCPCS Levels I and II coding systems necessary to ensure accurate coding and maximize reimbursement for medical claim processing.

MEAS 215 Advanced Medical Terminology

3 Credits

Prerequisites: HLHS 101. A more detailed and advanced study of the derivatives of medical terms, symbols and signs. It presents an in-depth study of the correlation between medical vocabulary and the application of those terms in the anatomy and physiology of the body, related diseases, conditions and treatment.

MEAS 218 Pharmacology

3 Credits

Prerequisites: APHY 101, HLHS 101 and demonstrated competency through appropriate assessment or earning a grade of "C" or better in MATH 050. Discusses the most common medications in current use with emphasis on classifications, uses, routes of administration, dosages, interactions, incompatibilities, and side effects. Emphasizes the current 50 most commonly prescribed drugs. Addresses special precautions, legal aspects, and patient education and preparation and administration of medications.

MEAS 219 Medical Assisting Laboratory Techniques

3 Credits

Prerequisites: HLHS 101, APHY 101, and MEAS Program Chair Approval. Prepares students to understand and perform entry-level

basic laboratory procedures. This includes fundamental principles of medical lab practice, disposal of biohazard materials, specimen collection, use of methods of quality control, urinalysis testing, chemistry testing, hematology testing, immunology testing, microbiology testing, and discussion of follow-up testing results.

MEAS 220 Advanced Insurance Claims Processing

3 Credits

Prerequisites: MEAS 137. Introduces additional instruction in medical record extraction and various aspects of insurance processing and follow-up. Provides discussion and additional information in the various insurance programs and in related insurance coding competencies.

MEAS 221 Seminar I

1 Credit

Prerequisites: None. Discusses topics of current interest in the medical assisting profession. Focuses on special interest project for students in the Medical Assisting Program. Uses field trips, guest speakers, audiovisual activities and seminars.

MEAS 227 Medical Office Management

3 Credits

Prerequisites: MEAS 107, MEAS 108 and MEAS 137. An in-depth study of various influences on office functions providing a background for organization and management of a physician's office. Includes government and professional sources for consultation.

MEAS 235 Advanced Transcription

3 Credits

Prerequisites: MEAS 135. Improves accuracy and speed of the medical transcriptionist utilizing various formats for medical transcription.

MEAS 238 Clinical I

3 Credits

Prerequisites: HLHS 101 and MEAS Program Chair Approval. Presents theory and lab related to clinical aspects of the medical office. Provides students with information necessary to recognize emergency situations, know the proper course of action with different types of emergencies, and apply appropriate first aid. Allows students to become familiar with clinical duties and to gain the skills needed to perform them. Includes vital signs, asepsis, sterilization, nutrition, and treatment room procedures.

MEAS 239 Clinical II

3 Credits

Prerequisites: MEAS 238. Presents a continuation of clinical skills and theory, and allows the student to become familiar with the following clinical duties: Medications, EKG's, X-ray, physical therapy, respiratory testing and other technical skills needed to assist the physician.

MEAS 240 Advanced Clinical Procedures

3 Credits

Prerequisites: MEAS 239. Advances the knowledge and skills enabling the student to assist in clinical management in the medical and surgical specialties. Addresses health services in the community which are directed toward prevention of disease and maintenance and restoration of health.

MEAS 242 Disease Conditions

3 Credits

Prerequisites: APHY 102 and HLHS 101. Presents the basic concepts of diseases, their courses and functional disturbances as they relate to body systems. Includes the precipitating risk factors and appropriate methods of patient education regarding various disease processes.

MEAS 254 Pharmacy Externship

3 Credits

Prerequisites: MEAS 152, Professional CPR/AED certification and MEAS Program Chair Approval. Provides the opportunity to discuss and perform clinical procedures under supervision, with learning experiences obtained in selected retail pharmacies and/or hospitals.

MEAS 255 Pharmacy Technician Experiential Seminar

3 Credits

Prerequisites: Program Advisor Approval. Provides the opportunity to observe, discuss and perform basic pharmacy related procedures under supervision, with learning experiences obtained in selected retail pharmacies and/or hospitals. Prepares student for national certification examination.

MEAS 256 Insurance Coding Externship

3 Credits

Prerequisites: MEAS 213, MEAS 220, Professional CPR/AED certification and MEAS Program Chair Approval. Provides opportunities to observe, perform and discuss various insurance related competencies under supervision in selected physician offices, clinics or hospitals.

MEAS 257 Phlebotomy Externship

3 Credits

Prerequisites: MEAS 212, Professional CPR/AED certification and MEAS Program Chair Approval. Provides the opportunity to discuss and perform phlebotomy procedures under supervision with learning experiences obtained in selected laboratories, physician offices, clinics, or hospitals.

MEAS 258 Medical Assisting Clinical Externship

3 Credits

Prerequisites: MEAS 218, MEAS 219, MEAS 239, APHY 102, Professional CPR/AED certification, and MEAS Program Chair Approval. Provides opportunities to observe, perform, and discuss various clinical competencies under supervision, with learning experiences obtained in selected physician offices, clinics or hospitals. Course will also review the following basic principles of psychology as they apply to the medical assistant: developmental stages of the life cycle, hereditary, cultural and environmental influences on behavior, mental health and applied psychology.

MEAS 259 Medical Assisting Administrative Externship

3 Credits

Prerequisites: MEAS 137, Professional CPR/AED certification and MEAS Program Chair Approval. Provides opportunities to observe, perform, and discuss various administrative competencies under supervision, with learning experiences obtained in selected physician offices, clinics or hospitals.

MEAS 271 CMA Comprehensive Review 3 Credits
Prerequisite: MEAS Program Chair Approval. This course is designed to review the entire medical assisting program in preparation for the CMA national examination. Administrative, clinical and general information is covered. Testing procedures are addresses. Emphasis will be placed on job readiness and placement. The course will give continuing education units for the graduate CMA in order to fulfill their certification renewal requirements.

MEAS 272 Spanish for Healthcare Providers 3 Credits
Prerequisite: None. Provides instruction in understanding and communicating, basic medical office procedures, basic medical procedures, insurance filing procedures, and basic procedures in regards to medical treatment, taking medications and the basic principles of mental health and applied psychology with patients whose primary language is Spanish.

MEAS 273 Transcription Practicum 3 Credits
Prerequisites: Program Advisor Approval. Demonstrate competency of keyboarding (50 wpm corrected) or successful completion of course work. Provides the opportunity to discuss and perform transcription in a medical facility setting under supervision. Allows student the opportunity to see and perform various medical reports and the various functions of medical transcriptions.

MEAS 299 CMA Comprehensive Review 3 Credits
Prerequisites: MEAS Program Chair Approval. Designed to review the entire medical assisting program in preparation for the CMA national examination. Administrative, clinical and general information is covered. Testing procedures are addresses. Emphasis will be placed on job readiness and placement. The course will give continuing education units for the graduate CMA in order to fulfill their certification renewal requirements.

MEDL 101 Fundamentals of Laboratory Techniques 3 Credits
Prerequisites: Demonstrated competency through appropriate assessment or earning a grade of "C" or better in ENGL 025, ENGL 032 and MATH 050 and program chair approval. Introduces the elementary skills required in the medical laboratory. Subjects covered include: Laboratory math, quality control, pipetting skills, venipuncture techniques, microscopic skills, and infection control.

MEDL 102 Routine Analysis Techniques 3 Credits
Prerequisites: Demonstrated competency through appropriate assessment or earning a grade of "C" or better in ENGL 025, ENGL 032, MATH 050 and Program Advisor Approval. This course deals with the principles, practices and clinical laboratory techniques associated with the routine analysis of urine.

MEDL 196 Introduction to Patient Care and Phlebotomy 3 Credits
Prerequisites: Demonstrated competency through appropriate assessment or earning a grade of "C" or better in ENGL 025 and ENGL 032 and program advisor approval. Introduces the student to the health care delivery system, instruction in specimen collection techniques, infection control and safety and applications of communication concepts and stress management.

MEDL 197 Clinical Phlebotomy Experience 3 Credits
Prerequisites: MEDL 196. Covers the practice and demonstration of clinical applications of phlebotomy in the clinical setting.

MEDL 198 Clinical Phlebotomy Discussion 1 Credit
Prerequisites: Student must be in good standing and currently enrolled in MEDL Program. Designed for students to develop the professional socialization process that is necessary for functioning in a health care setting as well as review routine and special phlebotomy procedure in light of phlebotomist-patient interaction.

MEDL 201 Immunology Techniques 3 Credits
Prerequisites: Program Advisor Approval. Provides the student with a basic understanding of the principles of the human immunologic system as well as an understanding of and experience in, routine testing.

MEDL 202 Immunoematology Techniques 3 Credits
Prerequisites: MEDL 201 and Program Advisor Approval. Provides instruction on the principles, practice, and procedures used for blood banking in the clinical laboratory.

MEDL 205 Hematology Techniques I 3 Credits
Prerequisites: MEDL 101, MEDL 102 and Program Advisor Approval. This course presents the theory of blood formation and function and routine hematology procedures, with emphasis upon differentiation of normal and commonly encountered abnormal blood cells. Also presents clinic pathologic correlations.

MEDL 206 Hematology Techniques II 3 Credits
Prerequisites: MEDL 205 and Program Advisor Approval. This course continues the study of principles and procedures in hematology. It introduces procedures which lie outside those routinely performed. Continues cell differentiation, with emphasis upon early and less commonly encountered abnormal cells, with associated special stains. Includes clinic pathologic correlations.

MEDL 207 Chemistry Techniques I 3 Credits
Prerequisites: CHEM 101 or CHEM 111 and Program Advisor Approval. Presents principles, procedures and clinicopathologic correlations in routine chemical analysis of the blood and other body fluids. Provides laboratory experiences in basic methods, selected to develop routine analytical abilities and to promote the ability to recognize sources of error.

MEDL 209 Routine Analysis Applications 1 Credit
Prerequisites: MEDL 102. Provides the student with study of the clinical applications of routine analysis in the hospital laboratory including physical, chemical, and microscopic examination of urine.

MEDL 210 Hematology Applications 3 Credits
Prerequisites: MEDL 206 and Program Advisor Approval. Knowledge and skill development pertaining to the principles and techniques of hematology in the hospital laboratory.

MEDL 212 Immunology Applications 1 Credit
Prerequisites: MEDL 201 and Program Advisor Approval. Studies and practices the clinical application of serology in the hospital laboratory.

MEDL 213 Immunohematology Applications 3 Credits
Prerequisites: MEDL 202 and Program Advisor Approval. Applications of principles and procedures used in blood banking in the hospital laboratory are taught in the clinical laboratory setting.

MEDL 215 Parasitology and Mycology 1 Credit
Prerequisites: MEDL 222. Examines the isolation, identification, life cycles and disease processes of pathogenic and opportunistic fungi and parasites.

MEDL 218 Clinical Pathology 3 Credits
Prerequisites: Program Advisor Approval. The course is a review course in preparation for the National Registry Examination and will include current testing procedures, disease conditions, diagnosis, etiologies, clinical symptoms and related laboratory findings.

MEDL 221 Clinical Microbiology Applications 3 Credits
Prerequisites: MEDL 222. Provides the student with the study of applications and clinical practices of microbiology found in a clinical laboratory.

MEDL 222 Microbiology Techniques 3 Credits
Prerequisites: Program Advisor Approval. This course will instruct the student in the principles of bacteriology including gram-negative and gram-positive bacilli and cocci, fastidious organisms and an overview of anaerobic organisms and acid-fast bacteria. Instruction in basic laboratory techniques in clinical bacteriology will also be included.

MEDL 224 Chemistry Applications 3 Credits
Prerequisites: MEDL 227. Corequisites: MEDL 208. Study and practice of the analytical aspects of clinical chemistry in the hospital laboratory.

MEDL 227 Chemistry Techniques II 2 Credits
Prerequisites: Program Advisor Approval. Continues the study of principles, procedures and clinicopathologic correlations in the chemical analysis of blood and other body fluids. Introduces procedures which lie outside those routinely performed in the clinical chemistry laboratory, including clinicopathologic correlations.

MEDL 280 Co-op/Internship 1-5 Credits

Prerequisite: Program Advisor Approval. Provides clinical laboratory experience in an affiliated laboratory. Gives students the opportunity to practice and employ fundamental lab skills and learn advanced techniques in a supervised setting. Provides on-the-job experience while earning credit toward the associate degree. Also provides a mechanism for a skills refresher course for credentialed individuals who have been out of the field for a period of time.

METC 105 Introduction to Engineering Technology 3 Credits

Prerequisites: None. Provides the beginning engineering technology student with the basic tools necessary for success in their chosen field. Topics include: survey of engineering technology careers, problem solving, introduction to engineering mathematical and statistical concepts, technical laboratories, data presentation and report writing, use of scientific calculators, engineering calculations, metrology, use of spreadsheets for data analysis and presentation, and engineering ethics and responsibilities.

METC 220 CAD for Mechanical Design 3 Credits

Prerequisites: DESN 102, DESN 103, METC105. An introduction and exploration of solid modeling using AutoCAD Inventor® software. Emphasis is placed on learning the basic concepts of creating parts using software-specific modeling and modification commands. The concepts of parent-child relationships as well as parametric relations are introduced. Assemblies of components are created based upon student-created parts, and the generation of engineering drawings will be required.

MKTG 101 Principles of Marketing 3 Credits

Prerequisites: Demonstrated competency through appropriate assessment or earning a grade of "C" or better in ENGL 025, ENGL 032 and MATH 044. Introduces the marketing role in society and how it affects the marketing strategy. Emphasizes the marketing mix, product planning, and the effects of the demographic dimension on the consumer market.

MKTG 102 Principles of Selling 3 Credits

Prerequisites: Demonstrated competency through appropriate assessment or earning a grade of "C" or better in ENGL 025, ENGL 032 and MATH 044. Provides an overview of the selling process. Includes the psychology of selling and develops skills through a series of selling situations.

MKTG 104 Promotion Management 3 Credits

Prerequisites: Demonstrated competency through appropriate assessment or earning a grade of "C" or better in ENGL 025, ENGL 032 and MATH 044. Presents management planning and oversight techniques for effectively communicating the results of the marketing strategy to customers. Provides a comprehensive overview of promotion methods as they interact in the marketing mix, which includes price, channel of distribution, and product.

MKTG 110 Consumer Behavior 3 Credits

Prerequisites: MKTG 101. Study of the basic principles of consumer behavior which offers insight into the buyer-seller relationship. Application of theories from psychology, social psychology and economics are examined. Course examines concepts that have implications for marketing management decisions.

MKTG 201 Introduction to Market Research 3 Credits

Prerequisites: MKTG 101 and MATH 111. Presents basic research methods entailing procedures, questionnaire design, data analysis, and effectively communicating research results.

MKTG 204 Marketing Management 3 Credits

Prerequisites: ACT 101, BUSN 105 and MKTG 101. Focuses on the analysis, implementation and control of marketing strategy. Emphasizes the major decisions management faces in its effort to harmonize the objectives and resources of the organization with the needs and opportunities of the marketplace.

MKTG 205 Principles of Insurance 3 Credits

Prerequisites: Demonstrated competency through appropriate assessment or earning a grade of "C" or better in ENGL 025, ENGL 032 and MATH 050. Introduces the risks faced by business firms including property, liability and personal losses, and how they are handled. Presents insurance contracts and their uses. Includes an overview of life insurance, health and pension insurance, public policy, government regulations and social insurance.

MKTG 213 Marketing in Non-profit Organizations 3 Credits

Prerequisites: MKTG 101. Introduces the use of marketing management to persons working in the non-profit environment, with emphasis on the marketing mix and the marketing concept and their specific application to the non-profit sector. This class is also designed for marketing majors to understand the growing world of non-profit marketing.

MKTG 220 Principles of Retailing 3 Credits

Prerequisites: MKTG 101 and MATH 050. Studies retailing concepts and practices, including retail merchandise planning, buying, pricing, promotion, and control in established retail operations. Attention is given to managerial and operational skills.

MKTG 221 Real Estate Broker 3 Credits

Prerequisites: One-year experience as an active licensed Indiana Real Estate Salesperson associated with a licensed Indiana Real Estate Broker. Mathematical competency as stipulated in Indiana Administrative Code (876 IAC 2-11 through 876 IAC 2-14). To prepare the student for taking the State of Indiana real estate broker licensing examination.

MKTG 222 Real Estate Sales 3 Credits

Prerequisites: Program Advisor Approval. To prepare students for taking the State of Indiana Real Estate Salesperson licensing exam.

MKTG 223 Residential Appraising I 5 Credits

Prerequisites: Program Advisor Approval. To substantially prepare the student for taking the State of Indiana licensed trainee residential appraiser examination. After taking this 75-hour classroom course the student must take an additional 15 classroom hours in Uniform Standards (USPAP) before being eligible to sit for the State Trainee examination.

MKTG 224 Uniform Standards of Professional Appraisal Practice (USPAP) 1 Credit

Prerequisites: Program Advisor Approval. It is not a requirement to hold a real estate license of any kind. A real estate broker without an appraiser's license must comply with Rule 6 - Standards of Practice to do appraising. Preparation for taking the State of Indiana licensed residential appraiser trainee examination. This supplements MKTG 223, in meeting the 90-classroom hour prerequisite for being eligible to sit for the trainee examination.

MKTG 225 Residential Appraising II 4 Credits

Prerequisites: Program Advisor Approval. To substantially prepare and enhance appraisal students' basic knowledge of real estate appraisal principals and practices. This course builds upon the basic appraisal coursework for in-depth discipline study and to prepare students for license upgrades.

MKTG 240 Internet Marketing 3 Credits

Prerequisites: CINS 101 and MKTG 101. Provides an introduction to the Internet as a marketing strategy including product, pricing, communications, and distribution considerations. Profiles Internet users and market segments and reviews the Internet as a primary and secondary marketing research tool as well as a relationship-marketing tool.

MORT 100 Orientation to Funeral Service 3 Credits

Prerequisites: Demonstrated competency through appropriate assessment or earning a grade of "C" or better in ENGL 025 and ENGL 032. An introduction to funeral service, ancient history, historical development, present funeral practices, values of funeral service, personal qualifications, and ethics. Field trips to investigate current problem areas in funeral service are required.

MORT 101 Grief Psychology for Funeral Service 3 Credits

Prerequisites: Demonstrated competency through appropriate assessment or earning a grade of "C" or better in ENGL 025 and ENGL 032. An examination of theory and management of grief, the process of mourning, and the value of the funeral service in bereavement. Grief reactions according to age and special types of

loss will be examined. In addition, the course will cover the funeral director's professional responsibilities to the families served.

MORT 102 Mortuary Law 3 Credits

Prerequisites: Students must be accepted into and enrolled in the Mortuary Science Program. Principles of mortuary law; duties, rights and liabilities for final disposition. Business law; public and personal liability; business organization; licensing and zoning regulations. Probate proceedings, social security, and life insurance benefits, and ethical standards relating to funeral service.

MORT 103 Embalming Chemistry 3 Credits

Prerequisites: Students must be accepted into and enrolled in the Mortuary Science Program. Fundamentals of inorganic, organic, and biochemistry. Also chemistry of the human body, chemistry changes following death, toxicology, disinfection, and embalming chemicals. Basic principles of chemistry related to funeral service.

MORT 105 Embalming Theory I 3 Credits

Prerequisite: Accepted into the Mortuary Science Program. An introduction of basic vocabulary utilized by the professional embalmer. The purposes of embalming, as well as responsibilities, conduct and qualities of the professional embalmer are discussed. An inventory of typical preparation room instruments and supplies is examined. Basic embalming case analysis is investigated. Techniques for embalming non-complicated cases are also investigated.

MORT 205 Embalming Theory II 3 Credits

Prerequisite: MORT 105. This course is a continuation of MORT 105 Embalming Theory I. This course investigates advanced embalming case analysis. Strategies and techniques for embalming complicated and/or complex cases are discussed. Techniques for preparing a deceased human body for transportation and/or long term storage are presented. Embalming theories/ techniques for handling specialized diseases, body conditions and other complications are discussed.

MORT 207 Embalming Practicum I 3 Credits

Prerequisites: None. Corequisites: MORT 206 and MORT 209. One laboratory session per week for one semester in an appropriate mortuary setting. Practical experience in all phases of funeral service including embalming, funeral directing, and funeral home operation. Students are placed in local funeral homes to work under the direct supervision of a qualified licensed embalmer to gain knowledge of procedures used in embalming human remains for funeral services. MORT 206 will work in conjunction with the practical experience.

MORT 208 Pathology for Funeral Service 3 Credits

Prerequisites: APHY 102, MORT 103 and BIOL 211. Divisions and importance of pathology, nature and causes of disease, to include inflammation, repair and recuperation of tissue, tumors, disease of the heart, respiratory and digestive systems are covered as well as

microscopic examination of autopsy and surgical specimens, with particular emphasis on those conditions which relate to or affect the embalming or restorative art process.

MORT 209 Restorative Art 3 Credits

Prerequisites: None. Corequisites: MORT 206 and MORT 207. The study of facial anatomy, color relationships, and restorations. Development of skills in anatomical modeling and cosmetics.

MORT 212 Funeral Service Management 4 Credits

Prerequisite: Accepted into the Mortuary Science Program. Designed to give the student a working knowledge of equipment items, manufacturing and use of such items. Presents a thorough study of caskets and vaults. Uses field trips and guest lecturers as learning tools. The curriculum is divided into two sections. The first covers construction and features of caskets, outer burial containers, and other funeral related products. The second section of the curriculum examines current practices and procedures, funeral direction, psychological and sociological aspects of funeral service, funeral home operation, professional overview and image, professional regulations and effective personnel management.

MORT 217 Embalming Practicum II 3 Credits

Prerequisites: MORT 103, MORT 206, MORT 207, MORT 209, APHY 102 and BIOL 211. Students work in a local approved funeral home under the direct supervision of a licensed embalmer. Develops practical embalming skills, combining work experience in funeral home. The student will work (8-10 hours) per week in the funeral home.

MORT 220 National Board Exam Review 2 Credits

Prerequisite: Accepted into the Mortuary Science Program. This course is designed to prepare the student for the National Board Examination. This examination is a graduation requirement and students must successfully complete the examination in order to become licensed funeral directors/ embalmers in most states. MORT 220 reviews the major learning objectives of other MORT courses as they relate to the National Board Examination. The course also examines various testing methodologies and test taking strategies.

MRTC 107 Motorcycle Engine Principles and Design 3 Credits

Prerequisites: None. Introduces engine dynamics, theory of engine operation and characteristics of engine design. Studies R & R, visual inspection, precision measuring, gaskets, lubricants, sealants, - coolants of modern engines, and engine service.

MRTC 127 Motorcycle Engine Service and Repair 3 Credits

Prerequisites: None. Studies precision tools, equipment, and procedures needed to repair today's modern engine. Repair, proper assemble, and installation techniques applicable to the modern engine are included.

MRTC 173 Motorcycle Transmission/Drive Service and Repair 3 Credits

Prerequisites: None. Studies theory and operation, diagnosis, testing and repair of motorcycle transmissions and drivelines.

MRTC 174 Motorcycle Frame and Electrical System 3 Credits

Prerequisites: None. Introduces the fundamentals and principles of motorcycle electronics and diagnosis. Extensive use of digital multi-meters and circuit troubleshooting is covered. Emphasis is placed on reading and understanding wiring diagrams and symbols. Diagnosing, starting, and charging systems are also covered.

MRTC 270 Motorcycle High Performance 3 Credits

Prerequisites: None. Covers the fundamentals, construction, components and design of high performance motorcycles for various racing venues. The course will also cover related systems; cooling, lubrication, suspension and braking. Students will study the theory, design and requirements of high performance engines/systems. Emphasis in this course is placed on performance modifications.

MTTC 101 Introduction to Machining 3 Credits

Prerequisites: None. Instructs the student in shop safety, industrial terminology, tools and machine tooling, measurement and layout. Includes laboratory exercises to begin project completion of turning, milling, and grinding applications.

MTTC 102 Turning Processes I 3 Credits

Prerequisites: None. Instructs students in shop safety, industrial terminology, and provide laboratory experience toward project completion on the conventional lathe.

MTTC 103 Milling Processes I 3 Credits

Prerequisites: None. Instructs students in shop safety and industrial terminology and provides laboratory experience toward project completion on the vertical and/or horizontal milling machine.

MTTC 104 Machinery Handbook 3 Credits

Prerequisites: Demonstrated competency through appropriate assessment or earning a "C" or better in MATH 044. Explores the intent and use of the machinery handbook. Applies principles and concepts in the machinery handbook to projects in the industry.

MTTC 105 Abrasive Processes I 3 Credits

Prerequisites: None. Provides shop safety, industrial terminology, and laboratory experiences on abrasive processing machines. Includes super abrasives technology processes.

MTTC 106 Print Interpretation 3 Credits

Prerequisites: None. Applies mathematics in solving engineering and design related problems in the areas of die design, fabrication, assembly, special machinery, die casting and molds. Emphasizes GDT tolerancing.

MTTC 110 Turning and Milling Processes 3 Credits

Prerequisites: None. Provides shop safety, industrial terminology and laboratory experiences on conventional lathe and milling machines.

MTTC 202 Advanced Turning Processes II 3 Credits

Prerequisites: MTTC 102 or MTTC 110. Advanced training in shop safety and industrial terminology utilizing the conventional engine lathe.

MTTC 203 Milling Processes II 3 Credits

Prerequisites: MTTC 103 or MTTC 110. Covers shop safety, industrial terminology, and provide advanced laboratory experience towards project completion on the vertical and/or horizontal milling machine.

MTTC 205 Abrasive Processes II 3 Credits

Prerequisites: MTTC 105. Continuing emphasis on shop safety, industrial terminology, and advanced laboratory experience towards project completion on a variety of abrasive processing machines.

MTTC 206 Tooling Design I 3 Credits

Prerequisites: MTTC 110 and MTTC 105 or MTTC 102 and MTTC 103 and MTTC 105. Introduces concepts of tooling design, assembly, and standards of fabrication. Emphasizes jig and fixture design/components, application and operational characteristics.

MTTC 207 Tooling Design II 3 Credits

Prerequisites: MTTC 105 and MTTC 110. Covers concepts of complex tooling design. Emphasizes forming, blanking, piercing and progressive type die design. Includes die applications, components, manufacture and assembly techniques.

MTTC 208 CNC Programming I 3 Credits

Prerequisites: Program Advisor Approval. Introduces two and three axis CNC machining. Develops the theory of programming in the classroom with applications of the program accomplished on industry-type machines. Studies terminology of coordinates, cutter paths, angle cutting, and linear and circular interpolation.

MTTC 209 CNC Programming II 3 Credits

Prerequisites: MTTC 208. Provides further study in computer-aided numerical control programming. Focuses on canned cycles, loops, macros, thread cycles, drilling, and pocket milling cycles.

MTTC 210 Interactive CNC 3 Credits

Prerequisites: MTTC 208. Introduces advanced applications of computer assisted part programming and simulation, language codes setup and operation, troubleshooting, and problem solving in a CNC turning center and CNC machining center. Includes related mathematical skills.

MTTC 211 Advanced Programming Techniques 3 Credits

Prerequisites: MTTC 210. Includes the application of advanced CNC

programming techniques to industrial machining. Using down loading and up loading techniques utilized through advanced projects.

MTTC 220 CAD/CAM I 3 Credits

Prerequisites: MTTC 208. Covers the development of various machine routines. Introduces computer-assisted machining as it relates to automated milling and machining centers. Emphasizes proper programming techniques, control familiarity, file data and machining functions.

MTTC 221 CAD/CAM II 3 Credits

Prerequisites: MTTC 220. Covers the development of 3-D shapes and the codes necessary to produce parts. Requires student to design a new product or modify an existing design. Includes creating surface curves. Focuses on creating tool paths for complex 3-D surfaces.

MTTC 225 Introduction to Mold Making 3 Credits

Prerequisites: MTTC 110. Introduces the student to the basic fundamentals or mold design and construction. The processes and basic construction of plastic molds, molds for die-castings and rubber molds are discussed. Each student in the class will design, build and inject their mold(s).

MTTC 240 Machine Operations I 3 Credits

Prerequisites: MTTC 102 and MTTC 103. Students will gain additional classroom experience concerning band saws, engine lathes, vertical mills, surface grinders, Harig® Grinding Fixture, and jig grinder. Measurement and layout will be performed at an advanced level. Classroom activities will concentrate on heat-treatment of tool steels, classes of ANSI fits and tolerances, electrical discharge machining, carbide tooling and basic metal stamping die theory. Experience will also be gained in the calculation of labor and material costs. In addition, students will also be introduced to metal stamping die construction and conversational programming on CNC vertical mills. Students will also be required to create a comprehensive notebook due at the end of the semester.

MTTC 241 Machine Operations II 3 Credits

Prerequisites: MTTC 240. Emphasizes basic tool construction and close tolerance machining. Using the various types of equipment found in the laboratory, students rough machine, heat treat and precision grind detail parts to tolerance within 0.0005 consistently. Classroom activities concentrate on precision setup, inspection work and basic tool construction. Experience is gained in basic conversational CNC programming.

MTTC 242 CNC Machining 3 Credits

Prerequisites: MTTC 208. Introduces and instructs the student in all aspects of Computer Numeric Control (CNC) machining. The student will program, set up and operate CNC mills and lathes utilizing CAD/CAM for fixture and part design and verification. Students continually improve programming, set up and cycle time efficien-

cy. Students inspect and document the quality of production parts and compare their performance with an industry benchmark for each project.

MTTC 243 Tool and Die Making I 3 Credits

Prerequisites: MTTC 101 and MTTC 110 and MTTC 208 or MTTC 101 and MTTC 102 and MTTC 103 and MTTC 208. Focuses on construction of a two-stage progressive die that incorporates interchangeable details. Each student manufactures a die that incorporates the parting principle and performs the following operations: Forming, Piercing, and Parting. In addition lecture material covers computations on blank lengths, and diameters, blanking and piercing operations, drawing, progression, and timing. Experience is gained in CNC machining and progressive die troubleshooting.

NGAS 101 Fundamentals of Natural Gas 3 Credits

Prerequisites: None. Introduces the characteristics and hazards of natural gas, prevention of accidental ignition, recognizing emergency conditions, inside and outside leak investigation methods and detection, instrumentation, carbon monoxide, and basic external corrosion prevention.

NGAS 102 Natural Gas Pipe Joining 3 Credits

Prerequisites: NGAS 101. Introduces the types of natural gas pipeline materials, joining techniques, coating maintenance, blowing gas scenarios, repair methods, and safety precautions.

NGAS 203 Natural Gas Regulatory and Compliance Issues 3 Credits

Prerequisites: None. The course covers the Department of Transportation regulations related to natural gas companies, including leak survey and patrol requirements.

NGAS 204 Natural Gas Construction Techniques 3 Credits

Prerequisites: NGAS 101. Introduces the methods used to locate and install natural gas lines, basic design theory, backfilling, purging, valve inspection and maintenance, pressure testing, customer regulations and relief design, explanation of hoop stress, shutting down the flow of gas, basic tapping and stopping techniques, construction equipment and current methods and common materials.

NRSF 100 Fundamentals of Nursing 3 Credits

Prerequisites: Admission to a Nursing Program. Corequisites: NRSF 101. Examines roles of the licensed practical nurse and registered nurse as members of the health care team. Provides an overview of the five components of the nursing process. Explores the nurse's role in providing for basic physiological, psychosocial, cultural, intellectual, and spiritual needs of patients. Introduces fundamental principles of therapeutic communication and teaching/learning.

NRSG 103 Medical-Surgical Nursing I Lab 2 Credits

Prerequisites: NRSG 100 and NRSG 101. Corequisites: NRSG 102 and NSG 105. Simulated patient care provides an opportunity to develop progressively complex nursing skills. Emphasis is placed on sterile technique, airway maintenance, nutritional and fluid support, elimination devices, specimen collection, medication administration, and drug dosage calculations.

NRSG 105 Medical-Surgical Nursing I Clinical 2 Credits

Prerequisites: NRSG 100 and NRSG 101. Corequisites: NRSG 102 and NRSG 103. Provides the opportunity to apply nursing skills in diverse patient care situations. Emphasizes assessment skills in determining patient health status. Applies knowledge of etiology, pathophysiology, diagnostic tests, and assessment findings to identify patient needs.

NRSG 106 Pharmacology for Nursing 3 Credits

Prerequisites: Admission to a Nursing Program or Program Chair Approval. Introduces principles of pharmacotherapeutics, pharmacodynamics, and pharmacokinetics in relation to the major drug classifications. Utilizes the nursing process to explore pharmacologic aspects of patient care.

NRSG 108 Transition for the Paramedic to the Associate of Science in Nursing 5 Credits

Prerequisites: Admission to the Associate of Science of Nursing Program. Corequisites: NRSG 109. Examines the transition to the role of the registered nurse. Identifies components of the nursing program philosophy. Provides an overview of the five components of the nursing process, emphasizes the assessment component. Introduces data analysis and nursing diagnoses. Reviews etiology, pathophysiology, clinical manifestations, and the diagnostic testing of common alterations in health within the context of all body systems. Introduces mental health concepts and therapeutic communications / milieu management.

NRSG 109 Transition for the Paramedic to the Associate Science in Nursing Lab/Clinical 3 Credits

Prerequisites: Admission to a Nursing Program. Corequisites: NRSG 108. Provides the paramedic the opportunity to transition into the role of the associate degree nurse. Allows the opportunity to apply theoretical knowledge to provide ethical, culturally competent, and holistic care for adults experiencing non-complex alterations in health. Emphasis is placed on the prevention of illness and the maintenance, promotion and restoration of health, as well as the support of death with dignity and implementation of the ordered treatment plan. The nursing process provides the framework for problem solving and critical thinking in providing nursing care. Laboratory and clinical experiences are provided to assist the student in identifying appropriate nursing interventions for health needs.

NRSG 110 Medical Surgical Nursing II 3 Credits

Prerequisites: NRSG 102, NRSG 103, NRSG 105, and NRSG 106. Corequisites: NRSG 111. Provides an understanding of the health care needs of adults experiencing non-complex alterations in health within the context of all body systems. Examines the roles of the licensed practical nurse and the registered nurse in applying the nursing process and implementing the ordered plan of treatment.

NRSG 111 Medical Surgical Nursing II Clinical 2 Credits

Prerequisites: NRSG 102, NRSG 103, NRSG 105, and NRSG 106. Corequisites: NRSG 110. Allows the opportunity to apply theoretical knowledge to provide ethical, culturally competent, and holistic care for adults experiencing non-complex alterations in health. Emphasis is placed on the prevention of illness and the maintenance, promotion and restoration of health, as well as the support of death with dignity and implementation of the ordered treatment plan. The nursing process provides the framework for problem solving and critical thinking in providing nursing care.

NRSG 112 Maternal-Child Nursing 3 Credits

Prerequisites: NRSG 102, NRSG 103, NRSG 105, and NRSG 106. Corequisites: NRSG 113. Applies knowledge of etiology and pathophysiology to provide an understanding of the health care needs of children and childbearing families. Examines the roles of the licensed practical nurse and the registered nurse in applying the nursing process and implementing the ordered plan of treatment for childbearing and childrearing families. Introduces growth and development components and how they impact therapeutic communication, therapeutic interventions, and teaching-learning techniques when providing nursing care to children and child-rearing families.

NRSG 113 Maternal-Child Nursing Clinical 2 Credits

Prerequisites: NRSG 102, NRSG 103, NRSG 105, and NRSG 106. Corequisites: NRSG 112. Allows the opportunity to apply theoretical knowledge to provide ethical, culturally competent, and holistic care for children and childbearing families. Emphasis is placed on the prevention of illness and the maintenance, promotion, and restoration of health as well as the support of death with dignity and implementation of the ordered plan of treatment. Knowledge of principles of growth and development are utilized to adapt therapeutic communication, therapeutic intervention, and teaching-learning techniques to provide nursing care to children and childrearing families. The nursing process provides the framework for problem solving and critical thinking in providing nursing care.

NRSG 114 Health Care Concepts in Nursing 1 credit

Prerequisites: NRSG 102, NRSG 103, and NRSG 105. Explores strategies utilized to promote lifelong personal and professional development. Analyzes the roles of the licensed practical nurse and the registered nurses within the context of the larger healthcare environ-

ment. Examines internal and external influences on nursing practice. Explores basic concepts of nursing leadership and management. Analyzes legal and ethical issues in healthcare.

NRSG 116 Geriatric/Complex Medical Surgical Nursing III for the Practical Nurse 4 Credits

Prerequisites: Admission to the Practical Nursing Program. NRSG 110, and NRSG 111. Corequisites: NRSG 117. Applies previous knowledge of etiology and pathophysiology to provide an understanding of the health care needs of adults experiencing complex alterations in health within the context of all body systems. Examines the role of the practical nurse in the acute care and long-term care setting. Relates principles of growth and development to the needs of geriatric patients. Examines leadership skills in the geriatric setting.

NRSG 117 Geriatric/Complex Medical Surgical Nursing III for the Practical Nurse Clinical 2 Credits

Prerequisites: Admission to the Practical Nursing Program. NRSG 110 and NRSG 111. Corequisites: NRSG 116. Allows the opportunity to apply theoretical knowledge to provide ethical, culturally competent, and holistic care for adults within the context of all body systems. Emphasis is placed on the prevention of illness and the maintenance, promotion and restoration of health, as well as the support of death with dignity and implementation of the ordered plan of treatment. The nursing process provides the framework for problem solving and critical thinking in providing nursing care. Leadership activities for practical nurses in the long term care setting are explored.

NRSG 120 Transition to Associate of Science Nursing for the LPN 5 Credits

Prerequisites: Admission to the ASN Program. Corequisite: NRSG 106. Examines the role of the registered nurse. Identifies components of the nursing program philosophy. Reviews etiology, pathophysiology, clinical manifestations, and the diagnostic testing of common alterations in health within the context of all body systems. The nursing process will guide the student in analyzing the care of the adult and maternal child patients with noncomplex health disorders. Emphasis will be placed on assessment skills. Laboratory experience is provided to perform basic nursing skills and assist the student in identifying appropriate nursing responses to health needs.

NRSG 200 Complex Medical-Surgical Nursing for the ASN 3 Credits

Prerequisites: Admission to the ASN Program. NRSG 110, NRSG 111, NRSG 112, and NRSG 113 or Admission to the ASN Program, NRSG 108, NRSG 109, NRSG 112, NRSG 113 and NRSG 106 or Admission to the ASN Program, NRSG 120 and NRSG 106. Corequisite: NRSG 201. Applies previous knowledge of the etiology and pathophysiology of complex alterations in health in understanding the patient's health care needs within the context of all body systems. Examines the role

of the registered nurse in applying the nursing process and implementing the ordered plan of treatment in acute care settings. Examines leadership skills in a variety of healthcare settings.

NRSG 201 Complex Medical Surgical Nursing for the ASN Clinical 4 Credits

Prerequisites: Admission to the ASN Program, NRSG 110, NRSG 111, NRSG 112, and NRSG 113 or Admission to the ASN Program, NRSG 108, NRSG 109, NRSG 112, NRSG 113 and NRSG 106 or Admission to the ASN Program, NRSG 120 and NRSG 106. Corequisite: NRSG 200. Allows the opportunity to apply theoretical knowledge to provide ethical, culturally competent, and holistic care for adults experiencing complex alterations in health within the context of all body systems. Emphasis is placed on the prevention of illness and the maintenance, promotion and restoration of health, as well as the support of death with dignity and implementation of the ordered plan of treatment. The nursing process provides the framework for problem solving and critical thinking in providing nursing care. Leadership concepts utilized in the management of direct patient care are explored.

NRSG 202 Nursing Care of the Complex Family 3 Credits

Prerequisites: Admission to the ASN Program, NRSG 110, NRSG 111, NRSG 112, and NRSG 113 or Admission to the ASN Program, NRSG 108, NRSG 109, NRSG 112, NRSG 113 and NRSG 106 or Admission to the ASN Program, NRSG 120 and NRSG 106. Corequisite: NRSG 203. Explores the theoretical concepts of growth and development, family nursing, and health promotion across the lifespan. Examines the role of the registered nurse in applying the nursing process and in implementing the ordered plan of treatment for families experiencing complex health problems. Identifies community health resources. Discusses the issues of obstetrical and high-risk neonatal emergencies, family violence, acute life threatening illnesses, and chronic debilitating illnesses. Analyzes the needs of the geriatric patient.

NRSG 203 Nursing Care of the Complex Family Clinical 2 Credits

Prerequisites: Admission to the ASN Program, NRSG 110, NRSG 111, NRSG 112 and NRSG 113 or Admission to the ASN Program, NRSG 108, NRSG 109, NRSG 112, NRSG 113 and NRSG 106 or Admission to the ASN Program, NRSG 120 and NRSG 106. Corequisite: NRSG 202. Allows the opportunity to apply theoretical knowledge to provide ethical, culturally competent, and holistic care with the focus on family coping and adaptation across the lifespan. Emphasis is placed on the prevention of illness and the maintenance, promotion, and restoration of health as well as the support of death with dignity, and implementation of the ordered plan of treatment for families experiencing complex health problems. The nursing process provides the framework for problem solving and critical thinking in providing nursing care.

NRSG 204 Psychiatric Nursing 2 Credits

Prerequisites: Admission to the ASN Program, NRSG 110, NRSG 111, NRSG 112, and NRSG 113 or Admission to the ASN Program, NRSG 108, NRSG 109, NRSG 112, NRSG 113 and NRSG 106 Pharmacology for Nursing or Admission to the ASN Program, NRSG 120 and NRSG 106. Corequisite: NRSG 205. Builds upon previous knowledge of mental health concepts to provide an understanding of psychiatric and behavioral disorders. Examines the role of the registered nurse in applying the nursing process to the care of individuals in the psychiatric setting. Explores the ordered plan of treatment for psychiatric and behavioral disorders. Identifies the registered nurse's accountability for the legal and ethical issues inherent in psychiatric nursing.

NRSG 205 Psychiatric Nursing Clinical 1 Credit

Prerequisites: Admission to the ASN Program, NRSG 110, NRSG 111, NRSG 112, and NRSG 113 or Admission to the ASN Program, NRSG 108, NRSG 109, NRSG 112, NRSG 113 and NRSG 106 or Admission to the ASN Program, NRSG 120 and NRSG 106. Corequisite: NRSG 204. Allows the opportunity to apply theoretical knowledge to provide ethical, culturally competent, and holistic care for individuals experiencing psychiatric and behavioral disorders. The nursing process provides the framework for problem solving and critical thinking in nursing care.

OFAD 009 Introduction to Keyboarding 3 Credits

Prerequisites: None. Introduces the use of the keyboard. Touch-typing skills, manual dexterity, and speed development are cultivated using computers.

OFAD 019 Keyboarding 3 Credits

Prerequisites: None. Provides students with the fundamentals of keyboarding using the touch method. Emphasizes mastery of the keyboard, development of formatting skills, and development of speed and accuracy on a personal computer using an up-to-date software package.

OFAD 029 Speed and Accuracy Development 1 Credit

Prerequisites: OFAD 019. Designed to diagnose individual keyboarding speed and accuracy skills and bring those skills to an employable level.

OFAD 103 Introduction to Computers with Word Processing 3 Credits

Prerequisites: Demonstrated competency through appropriate assessment or earning a grade "C" or better in ENGL 032. Offers hands-on experience in the operation of a specific word processing software package.

OFAD 108 Shorthand/Notetaking I 3 Credits

Prerequisites: None. Introduces basic principles of a note-taking system. Emphasis is placed on note-taking techniques, legibility, and mastery of the basic vocabulary. Dictation and transcription of material is included.

OFAD 110 Presentation Graphics 3 Credits

Prerequisites: None. Provides hands-on experience and familiarizes students with specific advanced design and layout techniques and practical applications of business presentations.

OFAD 113 Medical Coding 3 Credits

Prerequisites: HLHS 101. Addresses basic CPT coding concept guidelines including learning to use documented information and basic ICD-9 coding guidelines including how to extract information from medical charts. (For campuses that do not have an MEAS program.)

OFAD 114 Desktop Publishing 3 Credits

Prerequisites: CINS 101 or OFAD 103. Emphasizes the production of publication quality documents. Attention is given to design and layout principles and production techniques. Fonts, graphics, and page composition are integrated into camera-ready documents using computer software and hardware.

OFAD 115 Computer Concepts for the Medical Office 3 Credits

Prerequisites: Program Advisor Approval. Familiarizes the student with computer applications in the health care setting. Designed to provide the student with basic operations and applications of computer usage within the health care provider office. Applies the use of a computerized account management software.

OFAD 116 Essentials of Business Correspondence 3 Credits

Prerequisites: Demonstrated competency through appropriate assessment or earning a grade of "C" or better in ENGL 024 and ENGL 031. An intensive, competency-based business correspondence course that involves grammar, word usage, pronunciation, punctuation, proofreading, spelling, vocabulary building, and other language skills that are essential to good workplace communication.

OFAD 119 Document Processing 3 Credits

Prerequisites: Entry-level proficiency of 35 gross words per minute on a three-minute timed writing with three or fewer errors or OFAD 019. Emphasis is placed on increasing speed, improving accuracy, developing and applying formatting skills, applying communication and language arts skills, and developing document production techniques on a personal computer using an up-to-date word processing software package.

OFAD 121 Office Procedures and Team Dynamics 3 Credits

Prerequisites: OFAD 019 or OFAD 119. Prepares the student to understand and carry out responsibilities assigned in a business office. Topics include telephone techniques, office equipment, travel and conference arrangements, professional development, research techniques, time and stress management, and business ethics.

OFAD 130 Quality and Customer Service 3 Credits

Prerequisites: Demonstrated competency through appropriate assessment or earning a grade of "C" or better in ENGL 025 and ENGL 032. Examines and addresses issues of quality and customer service faced by organizations. Explores evolving philosophies, definition, development and application. Includes examination of current applications in administration.

OFAD 171 Topics in Presentation Graphics 3 Credits

Prerequisites: None. Provides hands on experience and familiarizes students with specific advanced design and layout techniques and practical applications of business presentations

OFAD 204 Microsoft Outlook 3 Credits

Prerequisites: None. Provides students with the ability to utilize email components. Topics include managing schedules, managing folders and contacts, organizing work using tasks and notes, and customizing and using advanced email features.

OFAD 207 Integrated Applications 3 Credits

Prerequisites: Demonstrates competency through appropriate assessment or successful completion of CINS 101. Explore the advanced features of an integrated office software package using word processing, spreadsheets, database, and presentation graphics.

OFAD 208 Shorthand/Notetaking II 3 Credits

Prerequisites: OFAD 108. Develop dictation, notetaking and transcription skills through drills and tests. Emphasizes speed, accuracy and use of correct English. Reinforces and builds on principles and skills learned in Shorthand/Notetaking I.

OFAD 211 Medical Transcription I 3 Credits

Prerequisites: HLHS 101 and OFAD 119 with an entry level speed of 40 GWAM on a 5-minute timed writing with a 5 error limit. Develop skills and knowledge of medical transcription, utilizing medical reports, terminology, and correspondence.

OFAD 212 Medical Transcription II 3 Credits

Prerequisites: MEAS 135 or OFAD 211. Develops transcription skills using medical documents such as office chart notes, letters, initial office evaluations, history and physicals, consultations, emergency room reports, and discharge summaries for various medical specialties.

OFAD 213 Professional Medical Coding 3 Credits

Prerequisites: OFAD 113. Addresses advanced CPT coding concept guidelines including learning to use documented information and advanced ICD-9 coding guidelines including how to extract information from medical charts. Emphasis is given to surgical coding in the course.

OFAD 214 Multimedia Design 3 Credits

Prerequisites: CINS 101 or OFAD 103. Create multimedia presenta-

tions for primary delivery via the Internet. Attention is given to design and layout principles and production techniques. Color and editing graphics and photographs will be introduced. Students will also apply their design skills to preparing documents for electronic publishing on the World Wide Web.

OFAD 215 Legal Transcription 3 Credits

Prerequisites: OFAD 119, with an entry-level speed of 40 gross words a minute on a 5-minute timed writing with a five-error limit. Provides hands-on training in formatting legal correspondence and court documents in the basic areas of law. Students will learn specialized rules of punctuation, terminology, and standards for legal documents. In a laboratory setting, students will learn how to use a transcribing machine to produce legal documents from tape dictation.

OFAD 216 Business Communications 3 Credits

Prerequisites: ENGL 111. Emphasizes analysis of business communication environments-cultural, organizational, technological, international, and interpersonal-and the use of communications standards to direct the choice of oral and written communication methods and techniques. It includes practice in writing a variety of messages used to communicate in business and industry with an emphasis on the potential impact of the message on the receiver as a basis for planning and delivering effective business communications.

OFAD 217 Problem Solving for Computer Users 3 Credits

Prerequisites: Advisor Approval. Introduces the organization, structure, and functions necessary for managing and maintaining information systems within a business organization. Presents the student with basic computer system concepts such as file and resource management, device drivers, file structures, hard disk organization, software installation, upgrading and maintenance, and fundamental data security techniques. These concepts will be incorporated into practical applications.

OFAD 218 Spreadsheets 3 Credits

Prerequisites: Demonstrated competency through appropriate assessment or earning a grade of "C" or better in MATH 044. Provides an in-depth understanding of worksheet design, charting, what-if analysis, worksheet database creation and manipulation, and OLE. Knowledge and use of a spreadsheet will be applied to various business applications. Integration of spreadsheets in other applications will be addressed.

OFAD 219 Advanced Document Processing 3 Credits

Prerequisites: OFAD 119 or equivalent. Emphasis on high degree of competency in office-like environment processing documents on a personal computer using an up-to-date word processing software package.

OFAD 220 Records and Database Management 3 Credits

Prerequisites: Demonstrated competency through appropriate assessment or earning a grade of "C" or better in ENGL 025 and ENGL 032. Focuses on the management and control of documents from creation to disposition using manual, automated, and electronic media. Examines filing procedures, records management personnel, and equipment. Uses database software to create, modify, query, and report information from a database.

OFAD 221 Organizational Leadership 3 Credits

Prerequisites: OFAD 216 and Advisor Approval. Emphasizes management of office functions. Key topics include personnel, team building, ergonomics, project management, and leadership styles. Case studies and role-playing projects are included. Students will also complete the program and College outcomes assessment tools.

OFAD 222 Database Applications 3 Credits

Prerequisites: Demonstrated competency through appropriate assessment or earning a grade of "C" or better in ENGL 025 and ENGL 032. Provides "hands-on" experience and familiarizes students with the creation and management of a database.

OFAD 226 Advanced Electronic Spreadsheets 3 Credits

Prerequisites: OFAD 218. Continues the study of electronic spreadsheets in business. Emphasizes the advanced application of electronic spreadsheets.

OFAD 271 Adobe Illustrator® 3 Credits

Prerequisite/Corequisite: Advisor's Approval. Provides beginning/intermediate instruction in illustration techniques using computer software designed for creating illustrations, technical drawings, logos, and packaging. Emphasis is on preparing effective, creative illustrations for various media applications in an efficient, productive manner.

OFAD 272 Introduction to Photoshop® 3 Credits

Prerequisite/Corequisite: Advisor's Approval. The course provides an introductory to intermediate look at Adobe Photoshop. The features and commands of this software will be discussed and explored in the context of preparing and manipulating graphics.

OFAD 280 Co-op/Internship/Externship 3 Credits

Prerequisites: Program Advisor Approval. Provides students with the opportunity to work for an organization specifically related to career objectives. Provides on-the-job experience while earning credit.

OPMT 102 Techniques of Supervision 3 Credits

Prerequisites: None. Demonstrated competency through appropriate assessment or earning a grade of "C" or better in ENGL 025 and ENGL 032. Introduces basic employee development with emphasis on the responsibilities of a newly-appointed supervisor. Emphasizes organizational structure, motivation, delegation of authority, interviews,

orientation and induction of new employees, employee performance evaluations and dealing with employee conflict.

OPMT 205 Techniques of Leadership 3 Credits

Prerequisites: OPMT 102. Identifies approaches to effective leadership and discovers an appropriate personal leadership style. Explores specific qualities and skills needed for conference leadership (organizing, facilitating, controlling, summarizing, speaking, and problem defining and solving).

OPMT 211 Labor Relations 3 Credits

Prerequisites: BUSN 101 and BUSN 202. This is a second-year elective course in labor-management relations. Examines labor history, major labor legislation, collective bargaining, grievance procedure/arbitration, wage issues and economic supplements e.g. "fringe benefits." Students will obtain the knowledge and skills necessary for functioning effectively in an organized – particularly an industrial – environment.

OPMT 224 Operations Management 3 Credits

Prerequisites: MATH 111 or higher. A study of the efficient production of goods and services that will satisfy the wants and needs of identified customer groups. The course begins with a more detailed description of what Operations Management is, then moves to an examination of the customer and methods for determining customer demand.

ORTH 101 Introduction to Orthotics and Prosthetics 3 Credits

Prerequisites: None. Focuses on the development of knowledge necessary to understand the rehabilitation process as it relates to the delivery of orthotic/prosthetic care. The prosthetic and orthotics professions are presented in terms of the integration of the biological, medical, and engineering sciences as well as the clinical and technical components of the disciplines. Students will develop a solid foundation of the principles and practice of orthotics and prosthetics and the materials and technology associated with the manufacture of custom devices.

PARA 101 Introduction to Paralegal Studies 3 Credits

Prerequisites: Demonstrated competency through appropriate assessment or earning a grade of "C" or better in ENGL 025 and ENGL 032. A survey of the American legal system, the substantive and procedural law of Indiana, and the role of the paralegal in the legal profession. Topics include professional ethics, trial and appellate courts, civil and criminal procedure, constitutional law, and basic legal analysis. This entry-level course is a prerequisite for all other paralegal courses in the program.

PARA 102 Legal Research 3 Credits

Prerequisites: PARA 101. Introduces the student to legal research resources including cases reporters and digest indexes, statutory

codes, constitutions, administrative codes and registers, legal encyclopedias, treatises, legal periodicals, and practice manuals and form books. Instruction is also delivered on proper legal citation form, citation services, and research strategy. Projects include a series of law library research projects that teaches the student the descriptive word method of research, basic legal analysis, and the structure of a legal research memorandum of law. 20 hours of law library attendance required in this course.

PARA 103 Civil Procedure 3 Credits

Prerequisites: PARA 101. The first of two semesters devoted to the study of the Indiana Trial rules, small claims, court rules, and local rules. (The second course is PARA 202) Topics include filing requirements, the rules regarding service of process, and calculation of deadlines. Projects include drafting summonses, complaints, answers, and various motions.

PARA 106 Tort Law 3 Credits

Prerequisites: PARA 101. Concerns the law of non-criminal injuries to persons or property. Topics include negligence, strict liability, product liability, intentional torts, affirmative defenses, basic evidence law, and pre-trial investigation techniques and resources.

PARA 107 Contracts and Commercial Law 3 Credits

Prerequisites: PARA 101. Examines the nature of contracts and commercial law under both the common law and the Commercial Code of Indiana. Topics include contracts for sales of goods (UCC Article 2), the Statute of Frauds, performance, remedies, warranties, assignment law, negotiable instruments law (UCC Article 3), and secured transactions law (UCC Article 9).

PARA 108 Property Law 3 Credits

Prerequisites: PARA 101. A survey of the law of real and personal property in Indiana. Property law concepts are analyzed. Topics include the different types of property generally, estates in land, concurrent ownership, legal descriptions and deeds, easements, encumbrances on title, title searches and title insurance, real estate purchase agreements, closings, mortgages and UCC Article 9 security interests, foreclosures, landlord-tenant law, and personal property law topics such as bailments, lost property, and intellectual property. This is an introductory course in real and personal property law for paralegal majors.

PARA 200 Legal Ethics 3 Credits

Prerequisites: PARA 101. Examines rules of professional conduct that apply to all legal professions including: the American Bar Association Model Rules of Professional Conduct, the Indiana Rules of Professional Conduct, the American Bar Association Guidelines for the Utilization of Legal Assistants, and various other sets of rules of conduct created by paralegal associations.

PARA 202 Litigation 3 Credits

Prerequisites: PARA 101 and PARA 103. The study of Indiana trial rules pertaining to actual trial. Topics include the discovery process and discovery tools, litigation support—including organization and retrieval of trial documents—techniques in preparing witnesses for trial, and preparing jury instructions. The main project is compiling a trial notebook.

PARA 203 Law Office Technology 3 Credits

Prerequisites: PARA 101. A hands-on survey of software support available to the law practitioner, including word processing, electronic spreadsheets, database management, presentation software, docket control, litigation support, timekeeping, and billing. Also included is information on computer-assisted legal research services, web based research, and electronic filing.

PARA 204 Legal Writing 3 Credits

Prerequisites: PARA 102 and PARA 103. Further develop the legal writing skills the students touched upon in Legal Research. The student will be exposed to various legal writing techniques that are used in drafting a wide variety of legal documents. Throughout the semester, a strong emphasis is placed on proper writing methodology and formatting. Projects include drafting research, correspondence, litigation and transactional documents.

PARA 205 Business Associations 3 Credits

Prerequisites: PARA 101. Introduces the student to the various forms of business entities, including sole proprietorships, general and limited partnerships, limited liability companies (LLCs), and business corporations. Topics include key concepts of law (the relationship between principals and agents), the scope of employment doctrine, and respondent superior, the distinguishing characteristics of common business entities, the formal requirements for establishing and doing business in various types of business organizations in Indiana, respective advantages and disadvantages of each type, and relevant tax issues. Students will review sample business formation documents and will draft a general partnership agreement.

PARA 206 Advanced Tort Law 3 Credits

Prerequisites: PARA 106. A continuation of the principles and issues discussed in Tort Law class, including res ipsa loquitur, attractive nuisance, premises liability and wrongful death. Litigation support and strategy will also be discussed.

PARA 209 Family Law 3 Credits

Prerequisites: PARA 103. An introduction to the Indiana law of marriage, dissolution, custody (including UCCJA), visitation, support (including URESA), adoption, and guardianship of minors. Students will review many pleadings and intake forms and will draft a divorce petition, a financial statement, a summary decree with child support worksheet.

PARA 210 Wills, Trusts, and Estates**3 Credits**

Prerequisites: PARA 101. Concerns the law of wills and trusts, the administration of estates, and guardianships according to Indiana common law and the provisions of Titles 29, 30 and Title 6 (claim taxes) of the Indiana Code. Students study the intestate succession, the elements of a valid will, of a valid trust, and laws of will construction.

PARA 212 Bankruptcy Law**3 Credits**

Prerequisites: PARA 101. A survey of the Federal Bankruptcy Act, including the various bankruptcy proceedings. There under emphasizes how to accumulate the debtor's financial information, compile initial schedules, prepare the list of creditors, collect and organize data for the first meeting of creditors, complete proofs of claim, and pursue creditors' rights. Including preparation of a Chapter 13 bankruptcy case.

PARA 271 Medical Malpractice**3 Credits**

Prerequisite: PARA 101. The student shall receive instruction in the elements of medical malpractice and how this differs from intentional tort and negligence claims. The course also concentrates on instruction on ethical and criminal violations that sometimes occur in the medical field. The student shall also receive instruction on the intricacies of Indiana law, including an analysis of the Indiana Medical Malpractice Act. The course will also cover the defenses available to defendants of medical malpractice claims.

PARA 280 Internship**3 Credits**

Prerequisites: Program Advisor Approval. An opportunity for intermediate paralegal student to acquire valuable field experience by working under attorney supervision. The student keeps a journal and prepares a report of his or her experience at the end of the semester.

PARM 102 Emergency Medical Technician - Basic Training**7.5 Credits**

Prerequisites: Completion of the ASSET or COMPASS, 18 years of age prior to course completion, copy of high school diploma or GED must be supplied by course completion, completion of the College Health Examination Form and required immunizations and tests, regionally determined, current Health Care Provider CPR card. Based on the training program developed by the Department of Transportation and the Emergency Medical Services Commission of Indiana. Covers theories, techniques and operational aspects of pre-hospital emergency care within the scope and responsibility of the basic emergency medical technician (EMT-B). Requires laboratory practice and clinical observation in a hospital emergency room and ambulance. Successful completion of the course meets Indiana requirements to test for certification as an EMT-B.

PARM 111 Preparation**3 Credits**

Prerequisites: APHY 101, certification, or pending, as an EMT - B, course application and physical exam on file, completion of the College Health Examination Form and regionally required immunizations and tests, successful completion of entrance requirements as determined by regional affiliates. The legal, moral and ethical responsibilities of the health care professional are introduced. An overview of the Emergency Medical Services System and its components and their relationships is presented. The essential principles of the standard of care, medical liability, areas of potential medical liability and medical liability protection are introduced. An overview of stress, reactions to stress, anxiety, paramedic job stress and dealing with death and dying is discussed. The essentials of pathophysiology and how the understanding of disease processes will improve upon the level of care provided by the paramedic are explained.

PARM 112 Prehospital Pharmacology**3 Credits**

Prerequisites: PARM 111. The introduction of drug information, action of drugs, weights and measures and the administration and techniques of administering drugs. The essentials of venous access, therapeutic communications and lifespan development are also included.

PARM 115 Airway, Patient Assessment**3.5 Credits**

Prerequisites: PARM 112. The fundamentals of airway management including airway anatomy and physiology, assessment, management, ventilation, and suction are emphasized. General patient assessment, initial management including scene survey, initial assessment, resuscitation, focused/detailed exam, history, definitive field management, and re-evaluation are also introduced.

PARM 116 Clinical Application I**1.5 Credits**

Prerequisites: PARM 112. Provides experiences in a hospital environment or other medical setting under supervision. Provides the opportunity to practice and perform patient assessment, endotracheal intubation, intravenous access techniques, and therapeutic communication techniques in the emergency department, surgery, and other appropriate clinical areas.

PARM 200 Trauma**3 Credits**

Prerequisites: PARM 115. An overview of kinematics, primary survey, resuscitation, secondary survey and management, monitoring and transporting trauma victims. The pathophysiology of shock, care of shock and victim oxygenation are covered. It defines parameters and discusses anatomy and physiology as related to burn injury, presents pathophysiology related to a specific source of burn injury and presents patient-related detail assessment and specific management of burns. Basic Trauma Life Support (BTL) certification must be earned during this course.

PARM 210 Medical I**6 Credits**

Prerequisites: PARM 200. Pulmonology, respiratory management

and pharmacological interventions are covered in detail. *Cardiology and dysrhythmia certification relative to pre-hospital intervention are emphasized. Advanced Cardiac Life Support (ACLS) certification must be earned during this course.*

PARM 213 Medical II**5 Credits**

Prerequisites: PARM 210 and APHY 102. Etiology and treatment of medical emergencies associated with the nervous, endocrine and reproductive systems are reviewed. The course includes presentation of allergies and anaphylaxis, gastroenterology, toxicology, infectious and communicable diseases, environmental conditions and behavioral and psychiatric disorder.

PARM 215 Special Considerations**3.5 Credits**

Prerequisites: PARM 213. Pediatrics, geriatrics and interventions for the chronic care patient and assessment based management are covered. Neonatal Resuscitation Provider (NRP) certification and Pediatrics Advanced Life Support (PALS) certification must be earned during this class.

PARM 216 Clinical Applications II**1.5 Credits**

Prerequisites: PARM 116. Provides experiences in a hospital environment or other medical setting under supervision. Provides the opportunity to practice and perform patient assessment, endotracheal intubation, suctioning of upper and lower airway, delivery of aerosolized medications, administration of medications via various enteral and parenteral routes, intravenous access techniques, interpretation of electrocardiogram tracings, and therapeutic communication techniques in the emergency department, critical care units, behavioral units, and other appropriate clinical areas.

PARM 219 Clinical Applications III**1.5 Credits**

Prerequisites: PARM 216. Provides experiences in a hospital environment or other medical setting under supervision. The emphasis is on gaining experience in the management of neonatal, pediatric, and obstetric patients. Provides opportunities to practice assessment, communication and management with patients ranging from neonate to young adult and opportunities to observe live births and perform assessment of obstetric patients are also available. Assessing the critically ill patient and assisting with care in specialty intensive care units and the burn unit is included.

PARM 220 Operations**2.5 Credits**

Prerequisites: PARM 213. An awareness of the concepts of rescue and the preparation for a response to a scene/incident is provided. The essentials of crime scene awareness, medical incident command and hazardous materials operations are presented. This is the capstone course of the paramedic curriculum.

PARM 221 Ambulance Internship**6 Credits**

Prerequisites: PARM 219. Students will participate in a field intern-

ship that provides on the job experience in all phases of prehospital advanced life support. All skills tested by the National Registry Exam will be formally reviewed and practiced. A general review of the total paramedic curriculum will be presented. Student's practical skills experienced through Clinical I, Clinical II, Clinical III, and this course must demonstrate competency in the objectives listed as required by the National Standard Curriculum, DOT, 1998.

PHIL 101 Introduction to Philosophy

Transfer IN 3 Credits

Prerequisites: Demonstrated competency through appropriate assessment or earning a grade of "C" or better in ENGL 025 and ENGL 032. Introduces the student to recurring ideas and thought systems represented in the literature and lives of great thinkers and examines philosophical principles such as foundations of morality, skepticism, the nature of knowledge, the nature of mind, free will and determinism, and the existence of God. Emphasizes the evaluation of arguments and analysis of concepts.

PHIL 102 Introduction to Ethics

Transfer IN 3 Credits

Prerequisites: Demonstrated competency through appropriate assessment or earning a grade of "C" or better in ENGL 025 and ENGL 032. Introduces the student to the ethical domain as a field of philosophy by examining major concepts such as happiness, virtues and rules and applies them to practical moral problems.

PHIL 213 Logic

3 Credits

Prerequisites: ENGL 111. Introduces the student to logic as a field of philosophy by examining the structure of argument and applying critical thinking skills.

PHIL 220 Philosophy of Religion

Transfer IN 3 Credits

Prerequisites: ENGL 111. Analyzes issues basic to understanding religion, including the problem of evil, free will and divine foreknowledge, arguments for the existence of God, relationship of faith and reason, and arguments for personal immortality.

PHOT 100 Photography for Non-Majors

3 Credits

Prerequisites: None. Covers basic black and white photographic theory and technique. Includes basic black and white darkroom processes and physics of light and filters. Studies camera and lenses, characteristics of films and papers and the chemistry of emulsions, exposure, and development.

PHOT 104 Basic Photography

3 Credits

Prerequisites: None. Covers basic black and white photographic theory and technique. Includes basic black and white darkroom processes and physics of light and filters. Study of camera and lenses, characteristics of films and papers and the chemistry of emulsions, exposure, and development.

PHOT 106 Studio Photography

3 Credits

Prerequisites: PHOT 104. Introduction to studio work in black and white photography using continuous light sources. Basic setup techniques and lighting methods for a variety of subject matter. Practice with photoflood lamps and quartz lamps, both floods and spots, and a variety of equipment used to modify light.

PHOT 107 Intermediate Photography

3 Credits

Prerequisites: PHOT 104. Further develops advanced camera skills and black and white photographic vision. Special attention is placed on the practice and theory of the zone system. The course introduces special darkroom techniques and processes and refines black and white printing and processing skills. It will also emphasize good composition and the use of photography as a communications tool.

PHOT 109 Studio Lighting Techniques

3 Credits

Prerequisites: PHOT 106 and VISC 115. Further explores multiple lighting set-ups, studio electronic flash, location lighting, and special effects. Emphasis will be put on conceptualizing the photograph from start to finish.

PHOT 122 Digital Photography

3 Credits

Prerequisites: None. Introduces students to digital imaging techniques in photography. Digital imaging software will be used as a tool to manipulate photographs and scanned imagery. Provides experience with digital studio setting. Provides experience with the digital darkroom environment including editing processes, manipulation of images and working with various output devices.

PHOT 201 Principles of Color Photography

3 Credits

Prerequisites: PHOT 104 and VISC 102. Develops camera and laboratory skills needed for color negative and color positive processes through work with state-of-the-art equipment and techniques. Encompasses color psychology and aesthetics as well as the physics of light in color photography. Color photographic theory will be emphasized.

PHOT 203 Professional Portraiture

3 Credits

Prerequisites: PHOT 109, PHOT 201 and VISC 101. Explores approaches and methods in traditional and alternative portraiture in studio and on-location photography. Emphasizes creative approaches to commercial portraiture as well as lighting and posing for corrective portraiture.

PHOT 204 Commercial Photography Techniques

3 Credits

Prerequisites: PHOT 109. Introduces more advanced studio and lab techniques used in advertising and industrial photography. Emphasizes creative problem solving applications toward advanced commercial photographic assignments.

PHOT 208 Independent Study I

3 Credits

Prerequisites: PHOT 104 and PHOT 106. Provides advanced students with opportunities to research and design projects for specified areas of interest. Requires the project plan to be approved by the instructor. Restricts work to student program area and requires it to be portfolio quality.

PHOT 214 Journalistic and Editorial Photography

3 Credits

Prerequisites: PHOT 104. Gives students the opportunity to photograph events and human interest features to gain experience in contributions to various publications. Emphasizes establishing visual relationships in the photo essay.

PHOT 216 Advanced Processes and Production Techniques

3 Credits

Prerequisites: PHOT 107, PHOT 201, VISC 101 and VISC 201. Introduces specialized lab/alternative process techniques in traditional and digital formats. Works with contemporary experimental darkroom and digital techniques. Covers issues in prepress production as they relate to the photographer.

PHOT 218 Fine Art Photography

3 Credits

Prerequisites: PHOT 104. Examines current issues in non-commercial photography. Explores attitudes of photographers and critics on a wide range of topics through directed reading, class discussion, and gallery visits.

PHYS 100 Technical Physics

4 Credits

Prerequisites: MATH 111. Corequisites: MATH 121 or MATH 131 or MATH 134 or MATH 137. Introduces the concepts and applications of physics. Leads students to develop an integrated understanding of the theory and applications of measuring (or unit) systems, scalars, vectors, force, work, rates, energy, momentum, power, force transformers (simple machines), vibrations and waves, and time constants. Emphasizes understanding concepts, factual knowledge, computation, and application.

PHYS 101 Physics I

Transfer IN 4 Credits

Prerequisites: MATH 121 or MATH 131, or MATH 134 or MATH 137. Introduces the basic concepts of mechanics, including force and torque, linear and rotational motion, work, energy and power, fluids, and the physics of heat. Includes lab.

PHYS 102 Physics II

Transfer IN 4 Credits

Prerequisites: PHYS 101. Introduces the physics of light, periodic and wave motion, electricity and magnetism, and concepts of modern and current physics. Includes lab.

PHYS 220 Mechanics

Transfer IN 3 Credits

Prerequisites: MATH 211. Corequisites: MATH 212. A calculus based

physics course that provides a detailed analysis of uniform and accelerated motion; Newton's laws; gravitational and planetary motion; energy; momentum; conservation principles; circular motion; angular momentum; dynamics of rotation; statics; hydrostatics and hydrodynamics; simple harmonic motion and wave motion. Includes lab.

PHYS 221 Heat, Electricity and Optics

Transfer IN 3 Credits

Prerequisites: PHYS 220 and MATH 212.A calculus based physics course that provides a detailed analysis of heat and energy; kinetic theory; elementary thermodynamics; heat transfer; electrostatics; electric current; AC and DC circuit analysis; electromagnetism; magnetic properties of matter; geometrical and physical optics. Includes lab.

PLAS 101 Introduction to Plastics 3 Credits

Prerequisites: None. Introduction to the main plastic processing industries, techniques, and commonly used polymers.

PLAS 106 Plastic Materials and Testing 3 Credits

Prerequisites: PLAS 101. Introduces structure, properties, and processing characteristics of plastic polymers and additives.

PLAS 107 Injection Molding 3 Credits

Prerequisites: PLAS 101. Expands the student's knowledge of injection molding process, components, and industry.

PLAS 108 Extrusion Process 3 Credits

Prerequisites: PLAS 101. Introduces the extrusion processes, equipment and industrial applications.

PLAS 201 Advanced Injection Molding 3 Credits

Prerequisites: PLAS 107. Covers the procedures and techniques necessary to fully utilize the capabilities of modern injection molding equipment to properly process thermoplastic materials.

PLAS 202 Advanced Extrusion 3 Credits

Prerequisites: PLAS 108. Expands the student's knowledge of extrusion processes, equipment and industrial application.

PLAS 208 Computer Applications in Plastics 3 Credits

Prerequisites: PLAS 107 and PLAS 108. Introduces the computer products and services available to aid in the design and manufacturing of plastic products.

PLAS 209 Manufacturing of Plastics Products 3 Credits

Prerequisites: PLAS 107 and PLAS 108. Covers the economic, organizational, and quality control strategies employed by production technicians to maximize efficiency in plastics manufacturing operations.

POLS 101 Introduction to American Government and Politics Transfer IN 3 Credits

Prerequisites: Demonstrated competency through appropriate assessment or earning a grade of "C" or better in ENGL 025 and ENGL 032. Studies federalism, theories of the origins and purposes of gov-

ernment and other aspects of the American government including interest groups, political parties, and the electoral process. Emphasis is placed on constitutional backgrounds and the organization and functions of the executive, legislative, and judicial segments of the national government, civil liberties and civil rights, public opinion, media, bureaucracies, and domestic and foreign policy.

POLS 112 State and Local Government 3 Credits

Prerequisites: Demonstrated competency through appropriate assessment or earning a grade of "C" or better in ENGL 025 and ENGL 032. Covers the basic organization and operation of state and local governments. Topics include federalism, state constitutions, courts, governors, legislatures, elections, campaign finance, interest groups, local governments, budgets and taxes, education and law enforcement.

POLS 201 Introduction to Political Science Transfer IN 3 Credits

Prerequisites: Demonstrated competency through appropriate assessment or earning a grade of "C" or better in ENGL 025 and ENGL 032. Introduces students to the basic principles of political science, government and its institutions, international relations, political philosophy, and political theory. Emphasis on the impact of economy, culture, history, and environment on political behavior/events.

POLS 210 Personal Law 3 Credits

Prerequisites: Demonstrated competency through appropriate assessment or earning a grade of "C" or better in ENGL 025 and ENGL 032. Examines the basis and principles of our legal system, how legal decisions are made and how they affect citizens' lives. Topics to be covered include federal and state jurisdictions, criminal and civil law and procedures, freedom of speech, press and religion, privacy rights, workplace rights, property rights, the role of juries in our legal system and the death penalty.

POLS 211 Introduction to World Politics Transfer IN 3 Credits

Prerequisites: Demonstrated competency through appropriate assessment or earning a grade of "C" or better in ENGL 025, ENGL 032 and MATH 044. Investigates the interaction of modern international political institutions, leaders, and events. Further discussion includes comparative analysis from a global perspective and the impact of international relations on individual lives.

POLS 220 Public Administration 3 Credits

Prerequisites: Demonstrated competency through appropriate assessment or earning a grade of "C" or better in ENGL 025 and ENGL 032. Focuses on bureaucracy in the federal government and its relation to local and state agencies.

PPTC 101 Power Plant Fundamentals 3 Credits

Prerequisites: None. An introduction to power plant systems. It

emphasizes the use of schematics and diagrams in discussing power plant systems and identifying major components including boilers, turbines, generators, condensers, pumps, and auxiliary equipment. Also includes the study of pre-heaters, feed water, superheat, and reheat systems. Plant safety training and workplace procedures will also be emphasized.

PPTC 102 Power Plant Mechanical Equipment 3 Credits

Prerequisites: None. Introduces the various pieces of mechanical equipment found in power plants including compressors, pumps, fans, blowers, valves, heat exchangers, power transmission equipment and turbines. Mechanical concepts of work, force, and torque will be used to describe equipment operation and performance. Studies basic types of bearings, seals, and lubrication used in power plant equipment. Mechanical assembly drawings and diagrams will be utilized to understand equipment operation and function.

PPTC 103 Power Plant Electrical Equipment 3 Credits

Prerequisite: INDT 113. Introduces the study of electrical equipment and systems used in power plants. Topics include three phase power, generators, motors, transformers, and switching gear. NEC and NESC Code requirements, automatic and manual motor controls, variable speed drives, and circuit protection will also be studied.

PPTC 121 Power Plant Steam Systems 3 Credits

Prerequisite: PPTC 101 and demonstrated competency through appropriate assessment or a grade of "C" or better in MATH 044. Studies the use of steam as a means of transferring energy and doing work. It will include principles of boiler operation to produce steam and the use of thermodynamics to understand the behavior and properties of a steam system. Major components will be studied along with how they play a role in the steam generation process. The class will include steam safety with principles of maintenance for use in troubleshooting and maintaining

PPTC 201 Power Plant Instrumentation and Control 3 Credits

Prerequisites: INDT 113 and PPTC 101. Introduces the basic principles of process instrumentation and control systems. It includes measurement parameters such as flow, pressure, level, temperature, and pH. Studies the use of programmable logic controllers, process controllers, and distributed control systems that are interfaced with sensors and actuators to maintain process stability.

PPTC 210 Gas Turbines 3 Credits

Prerequisites: PPTC 101. Introduces the student to combined-cycle gas and steam turbine power plants. It includes information on system layout, controls, operation, and maintenance.

PPTC 221 Advanced Power Plant Systems 3 Credits

Prerequisites: PPTC 101 and PPTC 201. Examines online boiler control

concepts, including combustion, feed water, header pressure, oxygen content, power demand, and other processes as applied to industrial power generation and process heat supply. Studies power plant cycles, thermodynamic properties of water, and steam. Also examines pollution control systems, gas turbine, and diesel generators.

PSAF 115 Hazmat Awareness and Operations 3 Credits

Prerequisite: None. Introduces hazardous materials for 1st responders. Topics include: hazardous materials definitions, regulations, statistics, properties and hazards; hazardous materials identification; incident management priorities; strategic goals and tactical objectives; personal protective equipment; contamination and decontamination; incident-specific strategies and tactics; terrorists and other criminal activities.

PSAF 117 Hazardous Materials Technician 4 Credits

Prerequisites: Demonstrated competency through appropriate assessment or earning a grade of "C" or better in ENGL 032 and MATH 040. Introduces hazardous material, managing the hazardous material incident, explosive and gas emergencies, shipping containers, cylinder safety devices, responding to flammable and combustible liquids, oxidizer, poison, and corrosive and radioactive emergencies. This course emphasizes chemical identification, marking, storage, shipping and handling of hazardous substances; and uses basic monitoring instruments for hazardous areas to protect workers and first responders. Covers protective clothing and equipment. Emphasizes safety procedures and practices. Detailed labs are included. On completion of this course the student is eligible to take the national test certification for Hazardous Materials Technician.

PSAF 120 First Responder 3 Credits

Prerequisites: None. Provides students with information necessary to recognize emergency situations; know the proper course of action with different types of emergencies and apply appropriate first aid. Addresses handling of victims of hazardous materials accidents. Covers CPR (Red Cross Professional with AED or American Heart Association Health Care Provider), including one and two rescuer, and adult, infant and child resuscitation.

PSAF 121 Risk Management 3 Credits

Prerequisites: Demonstrated competency through appropriate assessment or earning a grade of "C" or better in ENGL 032 and MATH 040. This course will provide the student with an introduction to industrial safety, OSHA, various OSHA standards, workplace inspections, citations and penalties. Employee and employer responsibilities, right-to-know laws and safety awareness programs are examined. Safety motivation and knowledge, creating a healthy work environment and health hazards and issues are also studied. Areas such as the role of the supervisor, employee assistance programs, management of stress helps students understand the role

employers play in creating a healthy workforce. In addition, the contributions of safety committees and other governmental agencies responsible for safety are examined.

PSAF 220 Incident Management System 3 Credits

Prerequisites: Program advisor approval. This class will emphasize command and control of major department operations at an advanced level, linking operations and safety. Areas of study include: National Incident Management System (NIMS), Pre-Incident, Size-up, command systems, Division and Group Functions, Staging, Safety Officer, Command Post, Communications, News Media, Computer Aided Resources.

PSAF 222 Computer Applications in Public Safety 3 Credits

Prerequisite: PSY 104. Focuses on the needs and uses of the computer in public safety. Includes computer-aided dispatch, computer-aided design of equipment, computer generation of incident reports fire and EMS, application of computers for administrative process, resource management, maintenance, test records for vehicles and equipment and future uses of computers in public safety.

PSAF 271 Field Studies in Fire Science and Environmental Impact 2 Credits

Prerequisite: Advisor Approval. This is an applied field studies course related to fire disasters, environmental impact and public administration and may include environmental health and safety and hazardous materials issues. Content will vary according to the current field study opportunity, and student must seek regional advisor approval to use as credits toward program completion. Student will travel to federally protected wilderness post-burn areas to study environmental impact, to utilize knowledge of federal, state, and local law as applied to wild land protected areas, residential and local municipalities (before and after fires), study the application of NIMS, utilize field appropriate equipment and technology in research and photography, and perform water and soil analysis. Students are required to attend two training days of wilderness information and skills training (relating to camping, portaging, canoeing, and hiking) prior to the trip. Service learning projects may be included during the field studies.

PSAF 279 Public Safety Capstone Course 1 Credit

Prerequisite: Program Advisor Approval. Prepare the student for entry into Public Safety careers related to academic concentrations of public administration, hazardous materials, environmental health and safety management or fire science. Reviews procedures for interviewing, team participation, and ethical and productive job performance. Provides for taking program outcomes assessments and portfolio development.

PSYC 101 Introduction to Psychology Transfer IN 3 Credits

Prerequisites: Demonstrated competency through appropriate assessment or earning a grade of "C" or better in ENGL 025, ENGL 032, and MATH 044. Surveys behavior and cognitive processes as they affect the individual. The course focuses on biological foundations, learning processes, research methodologies, personality, human development and abnormal and social psychology.

PSYC 102 Advanced Introduction to Psychology 3 Credits

Prerequisites: PSYC 101. Continuation of PSYC 101. Addresses advanced topics regarding the methods, data, and theoretical interpretations in the areas of learning, sensory psychology, and psychophysics. Presents specific theoretical issues, research methods, and findings in the areas of developmental, social, personality, and abnormal psychology.

PSYC 201 Lifespan Development Transfer IN 3 Credits

Prerequisites: PSYC 101 and ENGL 111. Examines human growth and development through the prenatal, child, adolescent, and adult stages of life. Physical, emotional, psychosocial, and cognitive influences from conception to death will be addressed.

PSYC 205 Abnormal Psychology Transfer IN 3 Credits

Prerequisites: PSYC 101 and ENGL 111. Examines theories and research related to abnormal behavior with primary emphasis on symptoms, etiology, and treatment of psychological disorders.

PSYC 210 Drugs and Human Behavior 3 Credits

Prerequisites: PSYC 101 and ENGL 111. Examines theories and research related to human drug use and abuse. Drug pharmacology; physiological effects of drugs on the nervous system; social and psychological issues affecting drug abuse; the treatment, effects, prevention of substance abuse; and therapeutic uses of drugs in mental illness will be addressed.

PSYC 211 Research Methods in Psychology 3 Credits

Prerequisites: PSYC 101 and MATH 050. The course will familiarize students with the basic concepts, techniques, and problems associated with conducting research in psychology. Students will be provided with the analytical and critical thinking skills required to design, conduct, and interpret empirical research. Problems specific to research in psychology will be explored.

PSYC 240 Human Sexuality Transfer IN 3 Credits

Prerequisites: PSYC 101. Considers sexuality from an historic, scientific, evolutionary and psychosocial perspective including sex research and methods, the biological bases of sexuality, sexual behavior, sexuality and the life cycle, sexual problems, and social issues.

PSYC 242 Educational and Psychology 3 Credits

Prerequisites: ENGL 111 and PSYC 101. Designed for students interested in the educational process at all levels. Included will be topics related to student motivation, assessment and achievement. Successful students will understand the importance of the application of knowledge, as well as the acquisition of knowledge. The course provides a basic understanding of the psychology of teaching and education. Problem solving in the educational setting will be stressed.

PSYC 253 Introduction to Social Psychology Transfer IN 3 Credits

Prerequisites: PSYC 101 and SOCI 111. The study of social psychology as a science, and how social psychologists study the interactions within and between individuals, social groups and institutions. This course crosslists with SOCI 253.

PSYC 260 Health Psychology 3 Credits

Prerequisites: PSYC 101. An introduction to health and emphasizing mind-body issues, the biopsychosocial model and cognitive behavioral theory. The course will emphasize research methods and current practice related to stress and pain, as well as health related behaviors. Within the course, treatment approaches, behavioral risk factors and public health issues will be addressed.

PTAS 101 Introduction to Physical Therapist Assisting 3 Credits

Prerequisites: Demonstrated competency through appropriate assessment or earning a grade of "C" or better in ENGL 025, ENGL 032 and MATH 044. Explores the history and concepts of physical therapy, physical therapist assisting and rehabilitative medicine. Introduces fundamentals of patient care including universal precautions; body substance isolation; OSHA guidelines, patient assessment including vital signs; body mechanics; and patient handling with applications of physics principles. Includes preparation of patients, treatment areas and equipment.

PTAS 102 Diseases, Trauma and Terminology 3 Credits

Prerequisites: PTAS 107. Explores diseases and trauma which necessitate physical therapy for the client. Medical terminology, anatomy, physiology, psychology, disabilities and physics related to these conditions are discussed along with instrumentation, implants and fixation devices. Provides students with the opportunity to explore their own reactions to illness and disability and to discuss how to recognize patients' and families' reactions to illness and disability.

PTAS 103 Administrative Aspects of Physical Therapist Assisting 3 Credits

Prerequisites: PTAS 107. Addresses the legal and ethical aspects of physical therapist assisting and patient care along with charting, documentation, report writing, patient history procurement, record keeping, charges, insurance information including diagnostic and proce-

dures coding, third party reimbursement, Medicare, Medicaid, electronic claims and patient rights including American Disabilities Act policy and architectural barriers identification. Discusses current issues in health care provision. Explores patient, family, and professional communication techniques, body language and electronic communication as well as techniques in patient teaching. Includes performing within limitations of scope of skills, basic principles of levels of authority and responsibility, planning, time management, supervisory process, performance evaluations, policies and procedures.

PTAS 106 PTA Treatment Modalities I 5 Credits

Prerequisites: PTAS 101 and APHY 101. Continues concentration on the fundamentals of patient care including universal precautions, assessment of vital signs, body mechanics and patient positioning. Includes lectures, demonstrations and simulated patient problems in the laboratory portion of the course. Studies new techniques in depth, such as gait training, gait device selection, goniometry range of motion exercises and measuring. Introduces various modalities including hydrotherapy, thermo-therapy, massage, traction and intermittent compression techniques. Safety factors are emphasized in both the lectures and the laboratories. The laboratory provides the setting for the practice and implementation of theories and techniques of PTAS 106. Students practice assessments and treatment methods on themselves and one another under the guidance and supervision of the laboratory instructor.

PTAS 107 Kinesiology 5 Credits

Prerequisites: PTAS 101 and APHY 101. Introduces the physical therapist assistant student to the science of kinesiology. By definition, kinesiology is the study of movement. Studies human movement and brings together the fields of anatomy, physiology, physics and geometry. Prerequisite knowledge of skeletal and muscular anatomy and physiology is necessary. Class will consist of equal parts of lectures, demonstration and student participation in locating, observing and palpating various bony prominences and musculatures. Much of kinesiology requires independent study to memorize origin, insertion, action and innervation of all muscles. The knowledge gained in this course is an integral part of the students' background preparation for the practice of physical therapy.

PTAS 115 Clinical I 2.5 Credits

Prerequisites: PTAS 102, PTAS 103 and PTAS 106. Requires the student to perform in a clinical environment with patients, using applications of theory and techniques of PTAS 106, under the guidance of a registered physical therapist.

PTAS 205 Clinical II 6 Credits

Prerequisites: PTAS 115, PTAS 207 and PTAS 217. Requires the student to perform in a clinical environment with patients using applications of theories and techniques of PTAS 207 under the guidance of a registered physical therapist.

PTAS 207 Treatment Modalities II 5 Credits

Prerequisites: PTAS 106 and PTAS 107. Reviews joint structure, muscle origins, insertions, innervations, actions and physiology. Covers normal and abnormal gait, orthotics and prostheses, arthritis and joint replacement and postural correcting exercise along with treatment principles and therapeutic exercises for the neck, back, and peripheral joints. Discusses general exercise principles and progression of the orthopedic patient through an exercise program. Addresses appropriate applications of principles of physics and kinesiology.

PTAS 215 Clinical III 6 Credits

Prerequisites: PTAS 205. Requires the student to perform in a clinical environment with patients using applications of theory and techniques of PTAS 217 under guidance of a registered physical therapist.

PTAS 217 Treatment Modalities III 5 Credits

Prerequisites: PTAS 106. Provides an in-depth approach to therapeutic exercise as performed by the physical therapy assistant. Covers basic anatomy and physiology of the central and peripheral nervous systems and activities of daily living. Includes exercise physiology and neuro physiology and advanced principles and procedures of therapeutic exercise appropriate for cardiopulmonary, cardiovascular, orthopedic and neurologic conditions, stroke, spinal cord and peripheral nerve injuries. Discusses prevention measures, specialized techniques and the utilization of specialized therapeutic equipment and correlates them to exercise applications. Addresses appropriate applications of kinesiology and principles of physics. Provides practice and implementation of theories and techniques of PTAS 106 and PTAS 207 in the lab setting.

PTAS 224 Current Issues and Review 1 Credit

Prerequisites: PTAS 215. Teaches the sources of physical therapy research and discusses the recognition of the roles and responsibilities of physical therapy assistants. Requires completion and presentation of an independent project. Includes a comprehensive review of the course to prepare the student for licensure exam.

QUAL 101 Quality Control Concepts and Techniques I 3 Credits

Prerequisites: Demonstrated competency through appropriate assessment or earning a grade of "C" or better in MATH 050. Covers current quality control concepts and techniques in industry with emphasis on modern manufacturing requirements. Studies the fundamental tools of statistical process control which are used in industry to reduce costs and increase productivity at a predictable quality level. Emphasizes principles and techniques of SPC to ensure prevention instead of detection of problems is practiced. Includes basic statistical and probability theory, sampling techniques, process control charts, the nature of variation, histograms, attributes and variable charts.

QUAL 102 Statistical Process Control 3 Credits
Prerequisites: None. Studies the fundamental tools of statistical process control which are used in industry to reduce costs and increase productivity at a predictable quality level. Emphasizes principles and techniques of statistical process control to ensure that prevention instead of detection of problems is practiced. Includes basic statistical and probability theory, sampling techniques, process control charts, the nature of variation, histograms, and attribute and variable charts.

QUAL 105 Non-Destructive Testing Application 3 Credits
Prerequisites: None. Presents an overview of the relationship of non-destructive testing to the total quality function. Includes advantages and limitations of various test methods including liquid penetrate, magnetic particle, ultrasound, and eddy current.

QUAL 201 Advanced Statistical Process Control 3 Credits
Prerequisites: QUAL 101. Builds on the basic principles of QUAL 101 with advanced techniques by industry to ensure economic production of goods based on defect prevention rather than defect detection. Covers the various decisions to modify, change or adjust the process based on statistical evidence. Stresses interpretation of statistical data and distinguishing between common and special causes of problems. Emphasizes appropriate use of control charts, trend analysis, assessing process and machine capability, evaluating the measurement process, using computers, and implementation techniques.

QUAL 202 Quality Control Concepts and Techniques II 3 Credits
Prerequisites: QUAL 101. Acquaints students with quality control systems. Emphasizes the systems approach to quality, establishing the quality system and applying total quality control in the company.

QUAL 204 Total Quality Management 3 Credits
Prerequisites: None. Teaches the philosophy of total quality management. Focuses on improving processes and reducing variation in systems. Covers management's role in improving aspects of manufacturing and service organization to achieve quality improvement.

QUAL 206 ISO/QS International Standards 3 Credits
Prerequisites: None. Teaches the basic principles of ISO 9000 standards, QS 9000 standard, ISO 14000 standard. Includes instruction on internal auditing with emphasis on the role of the internal auditor in regard to the maintenance of the quality systems.

QUAL 210 Quality Management Principles 3 Credits
Prerequisites: None. Stresses the management concept relating to employee attitudes, motivation and job satisfaction, as well as philosophies, styles of leadership, and team building as they relate to quality objectives.

RADT 111 Orientation and Patient Care 4 Credits
Prerequisites: Acceptance into the program through appropriate assessment. Introduces the profession of radiology and the practitioner's role in the health care system. It also provides students with the basic concepts of patient care dealing with the emotional and physical needs of the patients including infection control and standard precautions.

RADT 112 Image Production and Evaluation I 3 Credits
Prerequisites: Acceptance into the program through appropriate assessment. Content is designed to establish a knowledge base in factors that govern and influence the production and recording of radiologic images. Film and electronic imaging with related accessories will be emphasized. The mathematical calculations of x-ray technique will be taught along with the operations of darkrooms and developing equipment commonly used in the field.

RADT 113 Radiographic Positioning I 3 Credits
Prerequisites: Acceptance into the program through appropriate assessment. An introduction to and familiarize the student with the basic routines of radiographic positioning, shielding techniques, and related terminology. Actual radiographs are included for analysis of proper positioning and overall image quality.

RADT 114 Radiographic Clinical Education I 3 Credits
Prerequisites: Acceptance into the program through appropriate assessment. Content and clinical practice experiences shall be designed for sequential development, application, critical analysis, integration, synthesis and evaluation of concepts and theories in the performance of radiologic procedures. Through structured sequential, competency-based assignments in clinical setting, concepts of team practice, patient-centered clinical practice and professional development shall be discussed, examined and evaluated. Clinical practice experiences shall be designed to provide patient care and assessment, competent performance of Radiologic imaging and total quality management. Levels of competency and outcomes measurement shall ensure the well being of the patient preparatory to, during, and following the radiologic procedure.

RADT 115 Radiographic Positioning II and Lab 3 Credits
Prerequisites: RADT 113. Content is designed to provide a knowledge base necessary to perform standard radiographic procedures along with the application to special studies. Consideration will be given to the production of images of optimal diagnostic quality. Laboratory experience should be used to complement the didactic portion.

RADT 116 Radiographic Clinical Education II 4 Credits
Prerequisites: RADT 114. Content and clinical practice experiences shall be designed for sequential development, application, critical analysis, integration, synthesis and evaluation of concepts and theo-

ries in the performance of radiologic procedures. Through structured sequential, competency-based assignments in clinical setting, concepts of team practice, patient-centered clinical practice and professional development shall be discussed, examined and evaluated. Clinical practice experiences shall be designed to provide patient care and assessment, competent performance of Radiologic imaging and total quality management. Levels of competency and outcomes measurement shall ensure the well being of the patient preparatory to, during, and following the radiologic procedure.

RADT 117 Radiation Physics and Equipment Operation 3 Credits
Prerequisites: Admission to the program through appropriate assessment. Designed to establish a basic knowledge of atomic structure and terminology. Also presented are the nature and characteristics of radiation, x-ray production and the fundamentals of photon interactions with matter.

RADT 201 Radiographic Positioning III and Lab 3 Credits
Prerequisites: RADT 115. Content is designed to provide a knowledge base necessary to perform standard radiographic procedures along with the application to special studies. Consideration will be given to the production of images of optimal diagnostic quality. Laboratory experience should be used to complement the didactic portion.

RADT 202 Radiographic Clinical Education III 4 Credits
Prerequisites: RADT 116. Content and clinical practice experiences shall be designed for sequential development, application, critical analysis, integration, synthesis and evaluation of concepts and theories in the performance of radiologic procedures. Through structured sequential, competency-based assignments in clinical setting, concepts of team practice, patient-centered clinical practice and professional development shall be discussed, examined and evaluated. Clinical practice experiences shall be designed to provide patient care and assessment, competent performance of Radiologic imaging and total quality management. Levels of competency and outcomes measurement shall ensure the well being of the patient preparatory to, during and following the radiologic procedure.

RADT 203 Radiographic Clinical Education IV 4 Credits
Prerequisites: RADT 202. Content and clinical practice experiences shall be designed for sequential development, application, critical analysis, integration, synthesis and evaluation of concepts and theories in the performance of radiologic procedures. Through structured sequential, competency-based assignments in clinical setting, concepts of team practice, patient-centered clinical practice and professional development shall be discussed, examined and evaluated. Clinical practice experiences shall be designed to provide patient care and assessment, competent performance of Radiologic imaging

and total quality management. Levels of competency and outcomes measurement shall ensure the well being of the patient preparatory to, during and following the radiologic procedure.

RADT 204 Radiographic Clinical Education V 4 Credits

Prerequisites: RADT 203. Content and clinical practice experiences shall be designed for sequential development, application, critical analysis, integration, synthesis and evaluation of concepts and theories in the performance of radiologic procedures. Through structured sequential, competency-based assignments in clinical setting, concepts of team practice, patient-centered clinical practice and professional development shall be discussed, examined and evaluated. Clinical practice experiences shall be designed to provide patient care and assessment, competent performance of Radiologic imaging and total quality management. Levels of competency and outcomes measurement shall ensure the well being of the patient preparatory to, during and following the radiologic procedure.

RADT 206 Radiobiology and Radiation Protection 3 Credits

Prerequisites: RADT 111 and RADT 117. Covers theories and principles of the effects of ionizing radiation upon living tissues. Includes dosages, measurements, DNA structures and functions, cellular radiosensitivity. Overview of principles of radiation protection covered

RADT 209 Radiographic Positioning IV 3 Credits

Prerequisites: RADT 201. Content is designed to provide a knowledge base necessary to perform standard radiographic procedures along with the application to special studies. Consideration will be given to the production of images of optimal diagnostic quality. Laboratory experience should be used to complement the didactic portion.

RADT 218 Image Production and Evaluation II 3 Credits

Prerequisites: RADT 112. Explains phototiming and its relationship to manual techniques. Associates kVp and mAs with the quality and quantity of radiation. Covers standard darkroom procedure, automatic processing, fluoroscopy and quality assurance.

RADT 221 Pharmacology and Advanced Procedures 3 Credits

Prerequisites: RADT 201. Covers theories and principles of current imaging modalities. Content is also designed to cover contrast media along with the theory and basic technique of venipuncture. The role of the radiographer during medical emergencies is also addressed.

RADT 299 General Exam Review 3 Credits

Prerequisites: Program Advisor Approval. Reviews content of program, emphasizing anatomy, physics, exposure principles, positioning and radiation safety. Simulated registry exams prepare the student for the American Registry of Radiologic Technologist Examination.

RDTH 100 Introduction to Radiation Therapy 2 credits

Prerequisites: Admission to the Radiation Therapy program. Content is designed to provide the student with an overview of the foundations in radiation therapy and the practitioner's role in the health care delivery system. This course will provide students with a historical overview of radiation therapy and its role in medicine. An introduction to radiation therapy treatment techniques, equipment, terminology, and professional responsibilities will be included.

RDTH 145 Clinical Externship I 1 credit

Prerequisites: Admission to the Radiation Therapy program. **Corequisite:** RDTH 100. Introduces the student to procedures performed in Radiation Therapy, and provides the student with greater opportunities to gain practical experience. During this first semester of clinical education, the student is expected to develop the competency to perform simple clinical procedures with progressively less assistance. Emphasis continues to be given to the development of professional responsibility and the practice of total patient care and radiation safety practices.

RDTH 150 Patient Care in Radiation Oncology 3 credits

Prerequisites: None. **Corequisite:** RDTH 100. Provides the student with basic concepts of patient care specific to radiation therapy including consideration of physical and psychological conditions. Handling of patients, patient examinations, asepsis, local and systemic reactions, nutrition and medications are discussed. Factors influencing patient health during and following a course of radiation will be identified.

RDTH 155 Clinical Externship II 3 credits

Prerequisites: RDTH 145. Introduces the student to procedures performed in Radiation Therapy, and provides the student with greater opportunities to gain practical experience. During this second semester of clinical education, the student is expected to develop the competency to perform simple to intermediate clinical procedures with progressively less assistance. Emphasis continues to be given to the development of professional responsibility and the practice of total patient care and radiation safety practices.

RDTH 220 Techniques and Applications in Radiation Therapy 3 credits

Prerequisites: RDTH 100. Content is designed to provide the student with the basic concepts of dosimetry and treatment planning. Various external beam techniques and applications, depth dose data, and summation of isodose curves are discussed. Modalities of treatment, patient setup, dose measurement, dose calculation and verification are also included.

RDTH 223 Radiobiology and Safety 2 credits

Prerequisites: RDTH 100. Introduces the student to the fundamentals

of radiobiology and the effects of radiation on living tissue. This course evaluates the effects of radiation from the cellular level, to the epidemiological effects on communities and potential offspring. Specific topics in radiobiology include: basic radiation interactions, cellular biology review, short and long-term effects of radiation, case studies, risk factors, containment and handling of live sources, reduction of patient dose, radiation monitoring and applicable state and federal regulations.

RDTH 225 Clinical Externship III 4 credits

Prerequisites: RDTH 155. Introduces the student to procedures performed in Radiation Therapy, and provides the student with greater opportunities to gain practical experience. During this third semester of clinical education, the student is expected to develop the competency to perform simple to intermediate clinical procedures with progressively less assistance. Emphasis continues to be given to the development of professional responsibility and the practice of total patient care and radiation safety practices.

RDTH 230 Pathology and Treatment Principles I 2 credits

Prerequisites: RDTH 220. Provides the student with the fundamentals of each disease process. Malignant conditions, etiology and epidemiology, patient workup and methods of treatment are discussed. Attention is given to patient prognosis, treatment results and the effects of combined therapies.

RDTH 232 Radiation Therapy Physics 3 credits

Prerequisites: RDTH 220. Establishes a basic knowledge of physics pertinent to developing an understanding of radiations used in the clinical setting. Fundamental physical units, measurements, principles, atomic structure and types of radiation are emphasized. Also presented are the fundamentals of x-ray generating equipment, x-ray production and its interaction with matter.

RDTH 233 Research Methodology in Radiation Oncology 1 credit

Prerequisites: RDTH 100. Introduces the student to the logic, method, variation and precision of thought required in the practice and/or consumption of research.

RDTH 235 Clinical Externship IV 5 credits

Prerequisites: RDTH 225. Introduces the student to procedures performed in Radiation Therapy, and provides the student with greater opportunities to gain practical experience. During this fourth semester of clinical education, the student is expected to develop the competency to perform simple to intermediate clinical procedures with progressively less assistance. Emphasis continues to be given to the development of professional responsibility and the practice of total patient care and radiation safety practices.

RDTH 240 Pathology and Treatment Principles II**2 credits**

Prerequisites: RDTH 220. Provides the student with the fundamentals of several more disease processes. Malignant conditions, etiology and epidemiology, patient workup and methods of treatment are discussed. Attention is given to patient prognosis, treatment results and the effects of combined therapies.

RDTH 241 Treatment Planning**3 credits**

Prerequisites: RDTH 220. Provides the student with the concepts of dosimetry and treatment planning. Various external beam techniques and applications, depth dose data, and summation of isodose curves are discussed. Modalities of treatment, patient setup, dose measurement, dose calculation and verification are also included.

RDTH 242 Quality Management in Radiation Oncology**2 credits**

Prerequisites: RDTH 232. Focuses on the evolution of quality management (QM) programs and continuing quality improvements in radiation oncology. Topics will include the need for quality assurance (QA) checks; QA of the clinical aspects and chart checks; film checks; the various types of evaluations and tests performed on simulators, megavoltage therapy equipment and therapy planning units; the role of radiation therapists in quality management programs; legal and regulatory implications for maintaining appropriate QM guidelines as well as the role computers and information systems serve within the radiation oncology department.

RDTH 243 Radiation Therapy Capstone Course**2 credits**

Prerequisites: RDTH 223, RDTH 232, and RDTH 240. Integrates the various professional courses into a single perspective as it relates to radiation oncology. Professional concerns will be addressed and attention will be given to issues related to the workplace, continued professional development, and the need for lifelong learning. Extensive review of programmatic material will be the focus of this course. Extensive review of physics, protection and radiation therapy procedures is covered.

RDTH 245 Clinical Externship V**3 credits**

Prerequisites: RDTH 235. Allows the student to become proficient in all radiation therapy clinical procedures. During this fifth semester of clinical education, the students are further introduced to dosimetry procedures and are expected to have attained competency to perform all clinical procedures independently, under the direct supervision of a qualified professional or radiation therapist. Emphasis continues to be given to the development of professional responsibility and the practice of total patient care and radiation safety practices.

RDTH 260 Principles and Practice of Proton Therapy**8 Credits**

Prerequisite: Acceptance into the program. Content is designed to

provide the student with the knowledge and concepts used in proton therapy. Topics covered include practical applications of using protons and dosimetric concepts involved in treating patients. Immobilization techniques and accessory fabrication are also discussed. This course will address quality management, physics, radiobiology and regulatory procedures as they pertain to the field. Emphasis continues to be given on the professional and social intricacies of cancer care.

RDTH 261 Proton Therapy Lab Practicum**5 Credits**

Corequisite: RDTH 260 Principles and Practice of Proton Therapy. Extensive integration of proton therapy concepts and treatment procedures is the primary emphasis of this course. The student will be introduced to common treatment procedures performed in a proton therapy department. During this lab course the student will gain practical experience and develop the competency necessary perform a variety of procedures in a controlled environment on phantom patients. Emphasis continues to be given to the development of professional responsibility and the practice of total patient care.

RDTH 265 Proton Therapy Clinical Experience**3 Credits**

Corequisites: RDTH 260 and RDTH 261. Purpose of course is to further introduce the student to procedures performed in proton therapy and to provide the student with the opportunity to gain practical experience. During this period of clinical experience the student is expected to develop the competency to perform treatment and mold room procedures. Specific clinical objectives and competency procedures noted on the Clinical Experience Requirement Form.

RESP 121 Introduction to Respiratory Care**6 Credits**

Prerequisites: Program Chair Approval. Presents an introduction into respiratory care including a brief history of the profession; equipment cleaning and sterilization techniques; patient assessment techniques to include assessing pain levels, evaluating levels of dyspnea, advanced directives and isolation techniques. Also includes medical records documentation, gas analyzers, introduction and application of therapeutic modalities including oxygen therapy, aerosol and humidity therapy, environmental therapy, lung expansion therapy, airway management to include tube placement, tracheostomy care and tracheobronchial aspiration. An overview of ethical practice and patient safety are included.

RESP 122 Therapeutic Modalities**3 Credits**

Prerequisite: RESP 121. Presents medicinal aerosol therapy and respiratory pharmacology and applying it to the nervous system and its receptors. In addition, bronchial hygiene therapies, basic bedside pulmonary function testing, tracheostomy tube changes and 12-Lead EKGs will be discussed and demonstrated.

RESP 123 Cardiopulmonary Physiology**3 Credits**

Prerequisites: APHY 102. Presents the cardiopulmonary system

including ventilation, perfusion, and gas exchange; introduces interpretation and application of arterial blood gases, acid-base regulation, and physiologic monitoring. Reviews the basic principles of physics as it relates to the respiratory system.

RESP 125 Critical Care I**3 Credits**

Prerequisites: RESP 121. Presents an introduction to the respiratory care of the critically ill patient. This includes arterial blood gas collection; analysis and interpretation; and basic medical laboratory data. Introduces concepts and techniques of critical respiratory care of adults, to include establishment and maintenance of artificial airways. Includes application of adult mechanical ventilators and related cardio-pulmonary monitoring equipment.

RESP 126 Clinical Medicine I**3 Credits**

Prerequisites: RESP 123. This particular course introduces etiology, symptomatology, diagnosis, therapeutics, and prognosis of selected pulmonary diseases.

RESP 129 Respiratory Care Pharmacology**3 Credits**

Prerequisites: Program Chair Approval. The most common pharmacological agents currently being administered are discussed according to all body systems and in relation to the nervous system and its receptors. Emphasis is placed on classifications, indications, side effects, dosages, and routes of administration. Medication discussion to include, but not limited to emergency drugs, antibacterial medication and anti-fungal medications.

RESP 134 Clinical Applications I**2 Credits**

Prerequisites: Current CPR AHA Course C or equivalent and RESP 121. Introduces the student to the hospital environment. The student will be exposed to various hospitals and respiratory care departments, patient charts, patient identification and communication within the hospital. Provides supervised experience in oxygen therapy, lung expansion therapy, humidity/aerosol therapy, inspiratory muscle training/cough techniques, and charting. Utilizes standard precautions and infectious disease protocols during patient care and handles biohazardous materials appropriately.

RESP 137 Clinical Applications II**2 Credits**

Prerequisite: RESP 134. Provides supervised experience in selected therapeutic modalities. Students will perform lung expansion techniques. Additionally students will be exposed to various bronchial therapies and cough techniques. Administration of pharmacological agents using various aerosol devices will be included. Students will participate in the development of respiratory care plans, intra hospital patient transports, and rapid response teams to improve patient care. Students may have observation rotations in critical care areas. Continuing certification in CPR is required.

RESP 138 Clinical Applications in Adult Critical Care**5 Credits**

Prerequisites: RESP 125 and RESP 137. Provides supervised experience in selected therapeutic modalities. Also includes advanced patient assessment, arterial blood gas analysis, and airway care. Provides supervised experience in adult critical care with mechanical ventilation. Allows students to participate in intra-hospital transfers along with land/air transports. Students will participate in the development of respiratory care plans to improve patient outcomes within the critical care setting. An introduction to pulmonary function testing is included. Continued certification in CPR is required.

RESP 221 Cardiopulmonary Diagnostics**4 Credits**

Prerequisites: RESP 126. Presents in depth approaches to advanced diagnostic procedures. Special emphasis is placed on techniques of patient evaluation, selection of equipment, performing procedures, cardiopulmonary monitoring during the procedure, interpreting test results and suggesting management of the patient. Also included are advanced techniques of patient assessment through pulmonary function testing and other selected assessment techniques.

RESP 222 Critical Care II**3 Credits**

Prerequisites: RESP 125. Presents advanced techniques of mechanical ventilation of neonatal, pediatric and adult patients; includes fetal development and assessment; neonatal and pediatric assessment, equipment, procedures and therapeutic techniques, introduces related aspects of the neonatal intensive care unit environment. Selected neonatal and pediatric diseases will be discussed.

RESP 224 Clinical Medicine II**3 Credits**

Prerequisite: RESP 221. Studies etiology, symptomatology, diagnosis, therapeutics, and prognosis of disease conditions related to respiratory care; focuses on the interrelation of all physiologic systems. Emphasis on treatment protocols; includes preparation for the national board credentialing examinations such as the CRT, RRT and clinical simulation.

RESP 226 Continuing Care**2 Credits**

Prerequisite: RESP 125. Provides an overview of respiratory care roles in home care, alternative care sites and pulmonary rehabilitation programs. Understand the purpose and function of various respiratory equipment used in home and alternative care settings. Emphasis is placed on the importance of assessing patients' learning needs and how to effectively educate a patient and/or family member concerning smoking cessation and health management. Presents an overview of emergency preparedness in relation to disaster management to include vaccination protocols. Provide overview of mass casualty incident response.

RESP 229 Emergency Management**1 Credit**

Prerequisites: Current CPR/AHA Course C or equivalent. Application of various techniques in advanced cardiopulmonary support during life threatening events. At the end of the course, students will be expected to successfully apply knowledge in a mock adult patient care setting.

RESP 237 Clinical Applications of Advanced Critical Care and Specialty Rotations**3 Credits**

Prerequisites: RESP 138. Provides additional supervised experience in selected therapeutic modalities. Also includes advanced cardiopulmonary diagnostic techniques, application of invasive and non-invasive monitoring of the cardiopulmonary system, and experience in respiratory care and quality assurance roles. Also includes advanced clinical experience in adult, pediatric and neonatal intensive care units. Exposure to home care settings, alternative care sites and pulmonary rehabilitation programs is expected. Students are expected to complete patient care plans, written case studies and all clinical exams. Continuing certification in CPR is required.

RESP 250 Beginning Polysomnography**2 Credits**

Prerequisites: Program Advisor Approval. An overview of the field of Polysomnography including history, job responsibilities, credentialing, medical ethics and patient confidentiality. Normal and abnormal sleep disorders, integrating the physiologic functions of the nervous, respiratory and cardiovascular systems. Emphasis on basic sleep sciences, physiology, monitoring, electrical safety, diagnosis and treatment of sleep disorders.

RESP 251 Intermediate Polysomnography**3 Credits**

Prerequisites: APHY 102 and RESP 250 or Program Advisor Approval. Basic discussions of recording sleep apnea montage. Emphasis on equipment, principles of operation, associated activity related to normal and abnormal states of sleep, placement and calibration of the following: electroencephalography (EEG), electrocardiography (ECG), electrocardiography (ECG), electrocardiography (ECG), pulse oximetry (SpO₂), inductive plethysmography and airflow thermocouple.

RESP 252 Polysomnography Directed Practice I**3 Credits**

Prerequisites: APHY 102 and RESP 250 or Program Advisor Approval. Directed practice in clinical setting in sleep laboratory or a sleep center. Departmental orientation, policies and procedures, individual body mechanics and patient transfer techniques. Emphasis in overseeing periodic cessation of respiratory activity based on the placement and monitoring of the following: electroencephalography (EEG), electrocardiography (ECG), electrocardiography (ECG), electrocardiography (ECG), pulse oximetry (SpO₂), inductive plethysmography and airflow thermocouple.

RESP 253 Neurophysiology of Sleep**2 Credits**

Prerequisites: RESP 251 and RESP 252 or Program Advisor Approval. Presentation and discussion of the chemical and neural control of

the onset of sleep and wakefulness; normal function and pathophysiology; current theory and research applications.

RESP 254 Intermediate Polysomnography II**3 Credits**

Prerequisites: RESP 251 and RESP 252 or Program Advisor Approval. Presentation and discussion of the psychomotor practices related to interpretation of the polysomnogram for adult and pediatric patients. Emphasis on continuous positive airway pressure (CPAP) and bi-level positive airway pressures (BiPAP) equipment; artifact recognition and troubleshooting of sleep montage results. Includes digital data acquisition and parasomnias.

RESP 255 Polysomnography Directed Practice II**3 Credits**

Prerequisites: RESP 252 or Program Advisor Approval. Directed practice in the clinical setting in sleep laboratory or a sleep center. Departmental orientation, policies and procedures; assist adult and pediatric patient set-up and discontinuance in monitoring of the following: electroencephalography (EEG), electrocardiography (ECG), electrocardiography (ECG), electrocardiography (ECG), pulse oximetry (SpO₂), inductive plethysmography and airflow thermocouple. Emphasis on scoring a sleep montage related to respiratory

SCIN 100 Earth Science**TransferIN 4 Credits**

Prerequisites: Demonstrated competency through appropriate assessment or earning a grade of "C" or better in ENGL 025, ENGL 032 and MATH 050. Introduces physical concepts and theories pertaining to current applications and trends in earth science. Basic concepts in geology, meteorology, oceanography, and astronomy will be illustrated.

SCIN 101 Science of Traditional and Alternative Energy**4 Credits**

Prerequisites: MATH 111 or MATH 118 and demonstrated competency through appropriate assessment or earning a grade of "C" or better in ENGL 025 and ENGL 032. Introduces the basic physical concepts in understanding the science of different forms of energy—mechanical, kinetic, heat, electrical, light. Selected aspects of common sources of sustainable energy, including solar, wind, water, geothermal, and biomass will also be illustrated. Consideration of the science of transportation or storage of energy using new methods that reduce environmental impact will be discussed.

SCIN 111 Physical Science**TransferIN 3 Credits**

Prerequisites: Demonstrated competency through appropriate assessment or earning a grade of "C" or better in ENGL 025, ENGL 032 and MATH 050. Introduces physical concepts and theories pertaining to current applications and trends in physics. Basic concepts in chemistry, earth science and astronomy will also be illustrated. Emphasizes concepts and applications.

SOCI 111 Introduction to Sociology TransferIN 3 Credits

Prerequisites: Demonstrated competency through appropriate assessment or earning a grade of "C" or better in ENGL 025, ENGL 032 and MATH 044. Introduces students to the major theoretical paradigms of the science of human society, including fundamental concepts, descriptions, and analyses of society, culture, socialization processes, social institutions, social change, social stratification and the application of this understanding to everyday living.

SOCI 164 Multicultural Studies 3 Credits

Prerequisites: Demonstrated competency through appropriate assessment or earning a grade of "C" or better in ENGL 025 and ENGL 032. Introduces students to the historical experiences, values, cultures, and beliefs of the major racial and ethnic groups that make up the population of the United States. Examines central questions in the theoretical and empirical study of race and ethnicity. This course will help prepare students to understand, appreciate, and work effectively with people who are different from themselves.

SOCI 245 Cultural Diversity 3 Credits

Prerequisites: SOCI 111 and ENGL 111. Surveys multiple dimensions of diversity and social stratification in the United States, including race, ethnicity, age, class, physical ability, religion, gender, and sexuality. The social impact of the cultural integration of these groups will be introduced.

SOCI 252 Social Problems TransferIN 3 Credits

Prerequisites: SOCI 111. Explores various problems in contemporary American society. Examines structural and cultural aspects of social problems with specific reference to their origin, development, and suggested solutions. Course utilizes a sociological framework which encompasses a variety of theoretical perspectives.

SOCI 253 Introduction to Social Psychology 3 Credits

Prerequisites: PSYC 101 and SOCI 111. The study of social psychology as a science, and how social psychologists study the interactions within and between individuals, social groups and institutions. This course crosslists with PSYC 253.

SOCI 261 Sociology of Relationships and the Family 3 Credits

Prerequisites: Demonstrated competency through appropriate assessment or earning a grade of "C" or better in ENGL 025 and ENGL 032. Examines the sociological and psychological dynamics of dating, relationships, marriage, family life and parenting. Introduces students to the major theoretical paradigms as they relate to relationships. Emphasis will be placed on how our contemporary society and culture is affecting these institutions and customs. The course will also explore the impact of divorce and stepfamilies on today's lifestyles.

SPAN 101 Spanish Level I TransferIN 4 Credits

Prerequisites: Demonstrated competency through appropriate

assessment or earning a grade of "C" or better in ENGL 025 and ENGL 032. An introductory course in Spanish. Focuses on developing students' capacity to use the language and to appreciate Spanish-speaking cultures. Emphasis is placed on skills of listening, speaking, reading, writing, and grammar acquisition.

SPAN 102 Spanish Level II TransferIN 4 Credits

Prerequisites: SPAN 101 or demonstrated competency in Spanish through appropriate assessment; demonstrated competency in reading and writing through appropriate assessment or earning a grade of "C" or better in ENGL 025 and ENGL 032. Continues the study of Spanish for students who have had the equivalent of one semester of college-level Spanish. Introduces additional grammatical structures and vocabulary to further develop speaking, reading, writing and listening skills as well as an appreciation of the cultures of the Spanish-speaking world.

SPAN 201 Spanish Level III TransferIN 4 Credits

Prerequisites: SPAN 102 or demonstrated competency in Spanish through appropriate assessment; demonstrated competency in reading and writing through appropriate assessment or earning a grade of "C" or better in ENGL 025 and ENGL 032. In Spanish 201, Spanish is the primary medium of instruction, as well as the subject. The goal of the course is to continue development of and reinforcement of the basic skills of the target language: listening, speaking, reading, and writing. The course continues the study of grammar/syntax and vocabulary building and introduces Spanish and Latin American civilization through conversation coordinated with reading of cultural text as well as written and oral reports.

SPAN 202 Spanish Level IV TransferIN 4 Credits

Prerequisites: SPAN 201 or demonstrated competency in Spanish through appropriate assessment; demonstrated competency in reading and writing through appropriate assessment or earning a grade of "C" or better in ENGL 025 and ENGL 032. Spanish is the primary medium of instruction. The goal of the course is to continue the development and reinforcement of the skills of the target language: listening, speaking, reading and writing at an advanced intermediate level. The course continues the study of grammar/syntax and vocabulary building and continues the study of Spanish and Latin American civilizations through readings, both journalistic and literary, and reinforced through discussions as well as written and oral reports.

SPAN 240 Introduction to the Literature of the Spanish-Speaking World 3 Credits

Prerequisites: SPAN 202 or demonstrated competency in Spanish through appropriate assessment; demonstrated competency in reading and writing through appropriate assessment or earning a grade of "C" or better in ENGL 025 Introduction to College Writing II

and ENGL 032 Reading Strategies for College II. An introduction to the literary analysis of Hispanic literature. Provides a general overview of representative works of Hispanic literature from the Middle Ages through the Twentieth Century. Students will read and analyze works of poetry, prose, and theatre within the texts' cultural and historical contexts using the fundamental concepts of literary analysis to guide the interpretation

SPMT 101 Introduction to Sport Management 3 Credits

Prerequisites: Demonstrated competency through appropriate assessment or earning a grade of "C" or better in ENGL 025, ENGL 032 and MATH 044. Focuses on the nature and scope of sport management. Students will examine the breadth of sport related careers as well as engage in critical thinking about current sport management issues and trends.

SPMT 201 Sport in Society 3 Credits

Prerequisites: Demonstrated competency through appropriate assessment or earning a grade of "C" or better in ENGL 025, ENGL 032 and MATH 044. Introduces the socio-cultural dimensions of sport. Sport is sometimes trivialized as a playground off to the side of the real world. This course will describe to the student that sport is a microcosm of society as well as a site for changing society. Finally, the course will show that sport has a profound influence on the social life of large numbers of people of all ages.

SPMT 202 Management and Leadership in Sport 3 Credits

Prerequisites: SPMT 101. A survey course designed to introduce the student to the management related to sport. The course will assist students in understanding what the role of a manager is in the various sport industries.

SPMT 203 Venue and Event Management 3 Credits

Prerequisites: SPMT 202. A survey course designed to introduce the student to the management related to venues and events in sport. The course will assist students in understanding the role of a venue or event manager.

SPMT 280 Sport Management Internship 3 Credits

Prerequisites: Program Chair Approval. Full-time work experience in the sport industry (40 hours/week). The experience is work in a sport management setting in which management practices are applied.

SURG 111 Fundamentals of Surgical Technology 4 Credits

Prerequisites: Admission to clinical phase of Surgical Program, APHY 101, MATH 111 or higher, ENGL 111 and HLHS 101. Introduces principles of sterile techniques and the operative care of the surgical patient. Includes the roles of scrubbing and circulating duties.

SURG 112 Application of Surgical Fundamentals**2 Credits**

Prerequisites: Admission to clinical phase of Surgical Program, APHY 101, MATH 111 or higher, ENGL 111 and HLHS 101. Corequisites: SURG 111. Demonstrates the application of surgical fundamentals. Correlates theory to practice by requiring students to participate as members of a surgical team in laboratory simulations.

SURG 113 Surgical Procedures I**3 Credits**

Prerequisites: SURG 111, SURG 112, APHY 102, BIOL 2XX General Microbiology, Pharmacology, HLHS 105 and Program Advisor Approval. Corequisites: SURG 114. Introduces general surgical procedures with review of perioperative patient care including diagnostic testing, preoperative care, and immediate post-operative care.

SURG 114 Clinical Applications I**3 Credits**

Prerequisites: SURG 111, SURG 112, APHY 102, BIOL 2XX General Microbiology, Pharmacology, HLHS 105 and Program Advisor Approval. Corequisites: SURG 113. Correlates the principles and theories of basic surgical procedures to clinical performance in affiliating hospitals. Includes knowledge, skills and attitudes necessary for successful implementation of safe patient care in an operating room.

SURG 201 Pharmacology**3 Credits**

Prerequisites: APHY 101 and LHHS 101 demonstrated competency through appropriate assessment or earning a grade of "C" or better in MATH 050. Introduces the basic concepts of pharmacology. Emphasis is given to classification, indications, interactions and adverse reactions of commonly used medications. Dosage calculation, weights and measures, terminology and abbreviations associated with drug use are presented. Medication use in the perioperative patient is addressed.

SURG 211 Surgical Procedures II**6 Credits**

Prerequisites: SURG 113 and SURG 114 and COMM 101 or COMM 102 and PSYC 101 or SOCI 111. Corequisites: SURG 212. Studies advanced surgical procedures in relation to the physiological aspects of surgical intervention including those procedures related to the special senses, genitourinary, reproductive, musculoskeletal and nervous systems. Includes knowledge of the involved anatomy, existing pathology, surgical hazards encountered, the surgical procedure, and a review of perioperative patient care.

SURG 212 Clinical Applications II**9 Credits**

Prerequisites: SURG 113 and SURG 114 and COMM 101 or COMM 102 and PSYC 101 or SOCI 111. Corequisites: SURG 211. Correlates the basic principles and theories of advanced surgical procedures to clinical performance in affiliating hospitals. Includes knowledge, skills and attitudes necessary for successful implementation of safe patient care in an operating room.

SURG 213 Surgical Procedures III**3 Credits**

Prerequisites: SURG 211 and SURG 212. Corequisites: SURG 214. Studies specialized surgical procedures including those related to aesthetic and reconstructive surgery, the cardiothoracic and vascular systems. Includes knowledge of the involved anatomy, existing pathology, surgical hazards encountered, the surgical procedure, and a review of perioperative patient care.

SURG 214 Clinical Applications III**7 Credits**

Prerequisites: SURG 211 and SURG 212. Corequisites: SURG 213. Correlates principles and theories of specialized surgical procedures to the clinical performance in affiliating hospitals. Includes the knowledge, skills and attitudes necessary for successful implementation of safe patient care in an operating room.

TECH 101 Processes and Materials**3 Credits**

Prerequisites: Demonstrated competency through appropriate assessment or earning a grade of "C" or better in ENGL 024 and ENGL 031. An introduction to the characteristics, fundamentals and properties of material used in industry. Also introduced are the fundamentals of traditional and non-traditional processes, tools and machines used in industry.

TECH 103 Collaborative Team Skills**1 Credit**

Prerequisites: Demonstrated competency through appropriate assessment or earning a grade of "C" or better in ENGL 024 and ENGL 031. Introduces students to effective communication skills, conflict resolution, team collaboration and decision-making.

TECH 104 Computer Fundamentals for Technology**3 Credits**

Prerequisite: None. Designed to integrate computer technology, decision-making and problem-solving skills by using multimedia technology and peripherals. Students will explore technology and the various forms it takes in the industrial world. Software and computer programs will be studied along with their computer applications. Students will also learn basic Windows operating system concepts, word processing, Excel spreadsheets, and research/communication tools within the college.

TMAS 101 Holistic Approach to Massage Therapy**3 Credits**

Prerequisites: None. Considers the holistic approach to wellness with discussion including the connection of disease, the autonomic nervous system, and the emotions. Explores the importance of the mind-body connection.

TMAS 102 Legal Massage Applications**3 Credits**

Prerequisites: None. Presents ethics of medicine and medical practice, as well as legal requirements and implications for allied health professions. Specific emphasis will be placed on the applications of

ethics for massage practice situations. Forms, retorts, and documentation considerations will be addressed. Forms appropriate for use in a massage practice will be generated.

TMAS 103 Human Energies**2 Credits**

Prerequisites: None. This course helps the student develop an understanding of the human energy system and how this system impacts and reflects the physical, emotional, mental, and spiritual aspects of health. The techniques of several energy therapists will be taught, as well as professional practitioner/client interactions and the importance of self-care. These techniques are useful to aid relaxation, reduce pain, lessen anxiety, and accelerate wound healing, both for oneself and others.

TMAS 104 Hand and Foot Reflexes**2 Credits**

Prerequisites: None. Teaches the different aspects and points on the foot and hand relating to other areas of the body. Can be integrated into massage practice or can be an independent approach. An introduction to the musculoskeletal, cardiovascular, and nervous systems and their relationship to the zones on the feet are included. Systems disorders, including the sensory and endocrine, are also identified and discussed. The relationships of the five zones of the foot are identified as are the areas of the spine with spinal nerve innervation and intervention.

TMAS 120 Massage Technician Training I**3 Credits**

Prerequisites: APHY 101. This course will explore in detail the history of massage, professional and legal issues of massage, sanitation, professional touch, and massage equipment and products. Coursework will include the anatomy, physiology and psychology of the body by systems, and the effects of massage on each. Disease conditions will be discussed in terms of indications and contraindications for massage. Medical terminology will be introduced and used to prepare SOAP note documentation of massages performed. Students will perform circulatory massage techniques, body mechanics, and draping skills for full body relaxation massage.

TMAS 122 Massage Financial Management**3 Credits**

Prerequisites: None. Provides instruction in massage office financial administration, bookkeeping, materials management and computer applications. Addresses product sales and inventory and bookkeeping for tax preparation. Client tracking methods will be discussed. Retirement planning and self-employment, employment issues will be explored.

TMAS 125 Acupressure Theory and Methods**3 Credits**

Prerequisites: APHY 101. Introduces the student to information and treatments designed around the approach of Asian medicine including energy systems, meridians, and the five elements theory. The basics of Shiatsu are included.

TMAS 126 Jin Shin Do Bodymind Acupuncture 2 Credits
Prerequisites: None. This class presents theories and techniques necessary for effective practice of Jin Shin Do Acupuncture. Approximately half the time will be in lecture and half in practical hands-on skill. Students will be introduced to the basic theories of Traditional Chinese Medicine which is the basis of all Asian Bodywork Therapy. Students will learn 57 points in relation to surrounding anatomy. After this class, students will be able to utilize simple acupuncture techniques alone or combined with massage sessions. With successful completion of this class, students are eligible to take the Intermediate Jin Shin Do class.

TMAS 140 Massage Technician Training II 3 Credits
Prerequisites: APHY 101 and TMAS 120. Client consultations, conditions, and treatment plans are discussed. Emotional transference and psychological effects of massage will be addressed. Additional techniques and modalities addressed include deep friction, trigger point release, unwinding, PNF techniques, positional release, and intro to therapeutic exercise. Corporate (chair) massage is introduced. Guidelines for setting up a practice, including compliance with local state regulations, are discussed. Together these courses provide training for entry-level technicians into massage therapy.

TMAS 141 Massage Through the Lifespan 3 Credits
Prerequisites: APHY 101 and TMAS 120. This advanced course teaches the therapist to work with pregnant mothers to help ease the discomforts and stress that accompany pregnancy. Techniques to help with delivery are also addressed. It also addresses massage of infants and children to enhance bonding, relaxation, and comfort of the infant and child. Massage aspects of geriatric and disabled clients are addressed.

TMAS 142 Aromatherapy 3 Credits
Prerequisites: APHY 101 and TMAS 120. This advanced course teaches the therapist the integration of essential oils and aromatherapy into massage techniques.

TMAS 171 Personal Fitness Training 3 Credits
Prerequisite: None. The Personal Fitness Training course presents the concepts behind personal fitness, health and well-being. The course includes basic principles of human anatomy, physiology and exercise. Professional and legal practices are presented. Implementation of client's goals in an exercise program is discussed. Course includes both lecture and lab components. This program is designed to adequately prepare the student for the accredited NPPT-CPT Personal Trainer Board Certification Exam. The final exam for this course meets strict criteria and requirements imposed by the National Commission for Certifying Agencies (NCCA) accreditation standards. Successful board exam completion qualifies the student as a certi-

fied personal fitness trainer. Certification test fee will be in addition to tuition fees.

TMAS 201 Sports Massage, Injuries and Hydrotherapies 3 Credits
Prerequisites: TMAS 120 and TMAS 140. Presents a specific application of massage therapy designed to train the therapist in the treatment of athletes. Includes pre-event and post-event techniques, general maintenance massage, and therapeutic exercises. First aid for sports injuries and the use of hydrotherapies will be explored.

TMAS 202 Deep Tissue/Muscle Release 3 Credits
Prerequisites: TMAS 120 and TMAS 140. Helps practitioners apply deeper techniques in the body therapy releasing chronically held tissue from past trauma, illness, or recent injury. Discusses the use of various treatment modalities. Deep tissue techniques include compression and compression with stroke.

TMAS 203 Herbs, Drugs and Massage 3 Credits
Prerequisites: APHY 102, HLHS 101 and TMAS 120. Covers common medical conditions, the most common medications and the herbal remedies used to supplement healthcare. The most common medications and herbal remedies will be discussed according to body systems with emphasis on classifications, uses, routes of administration, calculations, dosages, interactions, incompatibilities, and side effects. The student will learn how to research medical conditions, medications, and herbal remedies. Also addressed are special precautions, legal aspects, and patient education.

TMAS 204 Herbal Remedies 3 Credits
Prerequisites: APHY 102 and HLHS 101. Covers the common medical conditions, and the herbal remedies that are used to supplement healthcare. The most common herbal remedies will be discussed, as well as the traditional indications, dose ranges, side effects, and contraindications. The student will gain a more in depth knowledge of herbal remedies being utilized in healthcare today and know how to research more knowledge on medical conditions and herbal remedies.

TMAS 205 Pathology and Massage 3 Credits
Prerequisites: APHY 101, APHY 102 and TMAS 120. Presents the basic concepts of diseases, their courses and functional disturbances as they relate to body systems. Includes the precipitating factors and appropriate methods of patient education regarding various disease processes and specifications for massage treatment.

TMAS 206 Palpation Skills 2 Credits
Prerequisites: APHY 102 and TMAS 140. Develops the student's palpation skills in order to enhance the practitioner's ability to evaluate the human body and energy systems. The course teaches a deeper understanding of muscular anatomy which includes craniocervical and fascial material. A substantial portion of this course will consist

of exercises to refine palpation skills.

TMAS 210 Biomechanics 3 Credits
Prerequisites: APHY 102 and TMAS 140. Provides a basic understanding of joint movement and body motion. Addresses muscle action, origin and insertion, muscle synergists, antagonists, and evaluations of forces on each body region. Entry-level biomechanical principles with the structure, function and kinesiology of each body region will be explored.

TMAS 220 Advanced Techniques and Hygiene 3 Credits
Prerequisites: TMAS 120, TMAS 125, TMAS 140, TMAS 141, and TMAS 201 or TMAS 202. Advanced training focusing on more techniques, body mechanics, and client management. It also addresses hygiene factors for both the therapist and the client. This course includes thorough client assessment techniques and is designed to expand the therapist into the medical field. The relationship of various illnesses and conditions to massage is discussed.

TMAS 221 Business Development 3 Credits
Prerequisites: TMAS 102, TMAS 122 and TMAS 140. Provides a basic understanding of the administrative responsibilities pertinent to massage therapy. Addresses computer usage, marketing, and office skills that will allow students to create, promote, and maintain their own business. Students prepare a business plan and define their goals for massage therapy.

TMAS 240 Advanced Sports Massage 3 Credits
Prerequisites: TMAS 201. Prepares the sports massage therapist to be a higher qualified, specific therapist with an understanding of professional ethics and a team concept of (physician, trainer, coach, physical therapist, and massage therapist) as one team unit.

TRCK 100 Diesel Preventive Maintenance 3 Credits
Prerequisites: None. Introduces the maintenance requirements and procedures of modern diesel engines and medium and heavy duty trucks. Proper procedures and requirements for the Federal Highway Safety Inspection (DOT) will be discussed and practiced.

TRCK 101 Steering and Suspension Systems 3 Credits
Prerequisites: None. Studies steering and suspension systems commonly used on modern tractors and trailers. Study will include steering and suspension components, power steering units, alignment theory and procedures, tire repair and service, and wheel balancing. Diagnosis, repair, and servicing of components including modern air suspension systems will be emphasized.

TRCK 105 Drive Train 3 Credits
Prerequisites: None. Covers the chassis systems of trucks and includes clutch operation removal and adjustment, driveshaft removal and service, frame mounted accessories, truck bodies, and fifth wheel plates.

TRCK 121 Brakes

3 Credits
Prerequisites: None. Theory, service, and repair of medium and heavy truck brake systems and their components. Emphasis is given to air brakes and their theory of operation, repair, and service of system components. Spring brakes and anti-lock systems will be studied on tractors and trailers.

**TRCK 125 HT Manual Transmission/
Differential**

3 Credits
Prerequisites: None. Theory, diagnosis, and overhaul procedures related to manual transmissions and differentials. Course includes service of twin counter-shaft, under-drive, overdrive, power-dividers, and air shift systems.

TRCK 127 Engine Repair

3 Credits
Prerequisites: None. Studies precision tools, equipment, and procedures needed to repair modern diesel engines. Repair, proper assembly, and component identification are studied along with service of removable cylinder liners.

TRCK 219 Diesel Engine Performance

3 Credits
Prerequisites: TRCK 224. Covers advanced concepts in diesel operation and computerized systems. New and future Federal emission standards will be covered along with the sub-systems required to meet these standards. Emphasis will be placed on the diagnosis and repair of computerized system controls, engine brakes, injection systems, emission components, and buss communication systems.

TRCK 224 HT Electrical Systems

3 Credits
Prerequisites: AUTC 123. Tractor and trailer wiring systems will be discussed along with proper diagnosis and repair procedures. Lighting and warning systems along with computerized engine controls will be examined. Dash switches, controls, and gauges will be studied along with factory wiring diagrams. This is the capstone course for the Medium/ Heavy Duty Truck specialty.

VIDT 106 Video Producing and Planning

3 Credits
Prerequisites: VISC 105. An introduction to producing and planning techniques. Focuses on knowledge and skills necessary to plan for video and audio productions. Develops visual flow and continuity, and applies principles of visual design to video storyboards.

VIDT 110 Production Editing I

3 Credits
Prerequisites: VISC 105. An introduction to non-linear, computer-based editing techniques and post-production skills. Focuses on knowledge and skills necessary to edit video and audio productions. Develops visual flow and continuity, and applies principles of visual design to video editing.

VIDT 111 Studio and Field Production I

3 Credits
Prerequisites: VISC 105. Hands-on training in basic technical skills. Students will be provided with an overview of the video production process, and help the student learn the terms and concepts used in the industry. This understanding will serve as the foundation for subsequent courses in video technology.

VIDT 113 Introduction to Film Appreciation

3 Credits
Prerequisites: Demonstrated competency through appropriate assessment or earning a grade of "C" or better in ENGL 025 and ENGL 032. An introduction to understanding and appreciating movie and film. Students will analyze movies for narrative and story telling properties, cinematography, acting, editing and sound design.

VIDT 202 Studio and Field Production II

3 Credits
Prerequisites: VIDT 110 and VIDT 111. Focuses on knowledge and skills necessary to create and execute good video and audio productions. This course is designed to provide the student with a more complete view of the process of videography techniques and the video production process. Student will use the terminology and concepts used in the industry.

VIDT 203 Studio and Field Production III

3 Credits
Prerequisites: COMM 101 or COMM 102, ENGL 111 and VIDT 202. Advanced studio and field production skills. Focuses on writing, producing and shooting projects both in the studio and on-location. Projects include remote video "shoot" planning, location scouting and site preparation, and hands-on studio practicing. Focuses on knowledge and skills necessary to create and execute good video and audio productions.

VIDT 204 Studio and Field Production IV

3 Credits
Prerequisites: VIDT 203. Masters studio and field production skills with a focus on production, programming and project management both in the studio and on-location.

VIDT 211 Production Editing II

3 Credits
Prerequisites: VIDT 110 and VISC 105. An advanced look at non-linear, computer-based editing techniques and post-production skills. Focuses on knowledge and skills necessary to edit video and audio productions for a variety of media outlets. Continues development of visual flow and continuity while applying advanced principles of visual design to video editing.

VISC 101 Fundamentals of Design

3 Credits
Prerequisites: None. Introduces students to fundamental design theory. Investigations into design theory and color dynamics will provide experiences in applying design theory, ideas and creative problem solving. Provides design experiences in applying design theories and concepts, and creative problem solving.

VISC 102 Fundamentals of Imaging

3 Credits
Prerequisites: None. Introduces students to a full range of image input technology and manipulation including conventional photography, digital imaging, and computer scanners. Students will learn to communicate concepts and ideas through various imaging devices. Explores composition and fosters creativity.

VISC 103 Interactive Media I

3 Credits
Prerequisites: VISC 101, VISC 102 and VISC 115. Explores various software programs involved in creating multi-media presentations, digital movies, digital animation, introductory scripting through a series of short projects. Explores the role of interactive in contemporary marketing and design.

VISC 105 Video and Sound

3 Credits
Prerequisites: None. An introduction to the field of video technology. Students will learn the basics of planning, shooting, editing and postproducing video and sound. Projects include exercises in technical and creative skills application, equipment usage and production techniques.

VISC 110 Web Design I

3 Credits
Prerequisites: VISC 101 and VISC 115. An introductory level course, which focuses on the tools, strategies, and techniques for web site design, architecture, navigation, language and production. Explores the methods for creating successful web sites from concept to implementation. Examines the process of integrating text, graphics, audio, and video for effective communication of information.

VISC 111 Drawing for Visualization

3 Credits
Prerequisites: None. Introduces students to the tools and methods of drawing. Presents drawing as a catalyst to seeing and a way of recording ideas. Gives students the necessary drawing preparation for the study of design.

VISC 112 Electronic Layout

3 Credits
Prerequisites: VISC 113 and VISC 115. Provides intermediate instruction in practical and creative page layout. Uses an industry standard desktop publishing package designed for single and multi-page documents as a tool for executing layouts. Produces samples for student portfolios, which may include stationery, charts, forms, brochures, and calendars.

VISC 113 Typography

3 Credits
Prerequisites: None. An introductory course which addresses the issues pertinent to the proper and creative use of type and the enhancement of communication. Covers the history of type, typographic terminology, design, attention to aesthetics, common sense, and how we read. Projects emphasize an appreciation of and the practical use of type.

VISC 114 Graphic Design I 3 Credits
Prerequisites: VISC 101 and VISC 115. Provides introductory instruction in design for communication primarily for print media. Teaches the steps in design development with meaningful message and concept. Produces samples for student portfolios, which may include elements or comprehensive projects in logo, stationery, newspaper, magazine, billboard, and interface design, etc.

VISC 115 Introduction to Computer Graphics 3 Credits
Prerequisites: None. A fundamental course which introduces students to the computer's use in visual communication. The beginning focus of the course is on basic computer terminology and use, mastering fundamental skills, and developing efficient working styles. These skills are then developed by creating work with imaging, drawing, interactive, and page layout software.

VISC 116 Electronic Illustration 3 Credits
Prerequisites: VISC 115. Provides intermediate instruction in illustration techniques using computer software designed for creating illustrations, technical, drawing, logos, packaging, maps, charts, and graphs. Emphasis is on preparing effective, creative illustrations for various media applications in an efficient, productive manner. Produces samples for student portfolios.

VISC 200 2-D Animation 3 Credits
Prerequisites: VISC 115. Provides students with a solid introduction to digital 2D Animation. Primary emphasis will be placed on the various tools and techniques needed to create 2D movies. Strong emphasis will also be placed on effective information delivery as well as cutting edge design, both for the web and other media.

VISC 201 Electronic Imaging 3 Credits
Prerequisites: VISC 101 and VISC 102. Examines the area of raster image editing and current electronic darkroom software packages. Experience with the digital imaging environment includes calibrating scanning processes, digital camera input, manipulating images in black and white and color, working with retouching for advertising, illustrating text, and working with various output devices. Digital color spaces as they relate to various output devices will be covered. Calibration for 4-color separations and prepress procedures will be discussed as well as preparing images properly for the web.

VISC 202 Special Projects I 3 Credits
Prerequisites: VISC 114. Provides advanced instruction in specific areas of student interest or in areas where there is a need to strengthen skills. Requires performance and completed work to be portfolio quality and reflect applicability to the main areas of the program. Suggested projects may include annual reports, catalogs, newsletters, menus, direct mail and/or other multi-piece or multi-

page communications. Also may include actual community or non-profit projects.

VISC 203 Independent Study 3 Credits
Prerequisites: VISC 114. Provides advanced students with opportunities to design projects for specified areas of interest. Requires the project plan to be approved by the instructor. Restricts work to student program area and requires it to be portfolio quality.

VISC 205 Business Practices for Visual Artists 3 Credits
Prerequisites: VISC 101 and VISC 115. Examines legal and business issues affecting the professional visual artist.

VISC 206 Interdisciplinary Studies 3 Credits
Prerequisites: VISC 210 or VISC 217 or PHOT 109. Offers students the opportunity to complete selected projects while working in a team environment with students of other disciplines. Simulates situations found in industry.

VISC 207 Portfolio Preparation 3 Credits
Prerequisites: Program Advisor Approval. Provides advanced facilitation focusing on the students' final preparation for the workforce. Requires an evaluation and portfolio development plan to be approved by the instructor. Finalizes project work demonstrating acquired knowledge and skills, along with resume and cover letter, for presentation to prospective employers. Also provides students with the opportunity to use one credit for field of study.

VISC 209 3D Rendering and Animation I 3 Credits
Prerequisites: VISC 201. Examines the virtual world of 3D and how it can be applied as an illustration and animation element in multimedia. Students will explore navigation, modeling, rendering, animation, and camera and lighting techniques.

VISC 210 Web Design II 3 Credits
Prerequisites: VISC 102 and VISC 110. Further focuses on the tools, strategies, and techniques for web site design, architecture, navigation, language and production. Explores more in depth the methods for creating successful web sites from concept to implementation. Examines the process of integrating text, graphics, audio, and video for effective communication of information.

VISC 211 Interactive Media II 3 Credits
Prerequisites: VISC 103 and VISC 201. Further explores various software programs involved in creating, multi-media presentations, digital movies, digital animation and scripting.

VISC 212 3-D Rendering and Animation II 3 Credits
Prerequisites: VISC 209. Further examines the virtual world of 3D and how it can be applied as an illustration and animation element

in multimedia. Students will expand on navigation, modeling, rendering, animation, and camera and lighting techniques.

VISC 213 Advanced Electronic Imaging 3 Credits
Prerequisites: VISC 201. The creation of the electronic image from digital imaging and scanning devices is further investigated. Advanced Adobe Photoshop illustration techniques are taught. Other software such as Adobe Dimensions and Fractal Painter are introduced. Students will work with both raster and vector software to create final output. An emphasis in final output is given to portfolio projects that are in the print, web, and film media.

VISC 217 Graphic Design II 3 Credits
Prerequisites: VISC 102, VISC 114 and VISC 116. Provides intermediate instruction in design for communication primarily for print media. Further explores design theory by applying concepts to achieve meaningful marketing and advertising results. Produces samples for student portfolios, which may include elements or comprehensive projects appropriate to trade/industrial advertising, brochures, flyers, pamphlets, posters, direct mail and/or consumer magazine advertising/branding, etc.

VISC 218 Digital Production 3 Credits
Prerequisites: VISC 114. Addresses the issues of electronic prepress (preparing electronic files for digital production). Topics covered include the tasks of prepress, paper knowledge, the entire printing production process (complete with requirements of the process) and electronic file management. A strong emphasis is placed on prepress terminology and jargon.

VISC 219 Graphic Design III 3 Credits
Prerequisites: VISC 201 and VISC 217. Provides advanced instruction and experience with design projects/branding identity, which communicate a common theme or campaign through several different media – magazine, billboard, radio, television, direct mail, brochures, point of purchase, sales promotions and/or package design, etc. Produces samples for student portfolios.

WELD 100 Welding Processes 3 Credits
Prerequisites: None. Provides general study of oxy-fuel, shielded metal arc, gas tungsten arc, gas metal arc, submerged arc, plasma arc, resistance, flash and upset, friction, electron beam, and laser welding processes. Covers equipment, techniques, electrodes, fuel gases and/or shielding gases, weld joint design, advantages and limitations, process applications, process variables and operational costs.

WELD 101 Gas Welding I 3 Credits

Prerequisites: None. Introduces basic oxy-fuel brazing, soldering and braze welding. Involves detailed study of the techniques of making a strong braze or solder joint. Demonstrates proper technique for making a good braze weld joint on mild steel and cast iron. Provides additional background essential to performing maintenance and repair welds in industry.

WELD 103 ARC Welding I 3 Credits

Prerequisites: None. Covers the welding of ferrous metals and alloys utilizing metallic manual arc welding methods. Includes procedures in joint design using "T" joint, lap joint, and butt joint designs. Covers single pass and multi-pass techniques. Emphasizes safety hazards and safe practices in arc welding.

WELD 105 Welding Equipment and Electrical Maintenance 3 Credits

Prerequisites: None. Focuses on the design of oxy-fuel welding and cutting equipment and electric arc welding and cutting equipment. Enables students to perform troubleshooting on the equipment and apply proper maintenance. Examines relationships of voltage, current, and resistance on electrical circuits with emphasis on the production of heat from the flow of electric current through resistance.

WELD 107 Welding Troubleshooting 3 Credits

Prerequisites: WELD 101 or WELD 109. Covers evaluation of weldments, welding procedures and tolerances, joint design and alignment. Also covers weld defects caused by improper equipment settings, equipment failure, base metal, improper filler metal, and improper shielding of welds. Emphasis will be placed on weldability of metals.

WELD 108 Shielded Metal Arc Welding I 3 Credits

Prerequisites: None. Provides students with knowledge of shielded metal arc welding operations and equipment. Provides extensive practice time to produce the skills to make satisfactory welds with this process. Emphasizes safety hazards and safety practices in arc welding.

WELD 109 Oxy-Fuel Gas Welding and Cutting 3 Credits

Prerequisites: None. Offers basic instruction in oxy-fuel welding with emphasis on shielding techniques in flat, horizontal, vertical, and overhead positions. Includes brazing, soldering and flame cutting. Focuses on safety hazards and safe practices in oxy-fuel welding and cutting.

WELD 115 Shop Practices I 1 Credit

Prerequisites: None. Provides use of a shop to obtain basic welding skills using various types of welding processes.

WELD 116 Shop Practices II 1 Credit

Prerequisites: WELD 115. Continues open use of shop to practice various types of welding to improve operator skills to a higher level.

WELD 117 Shop Practices III 1 Credit

Prerequisites: WELD 116. Continues open use of shop to practice various types of welding to improve operator skills to an advanced level.

WELD 201 Special Welding Processes 3 Credits

Prerequisites: Advisor Approval. This is an advanced welding course that involves theory and hands-on practice with various welding processes such as FCAW, PAW, SAW, GTA and other welding processes. Presents welding processes with emphasis on use and orientation of the equipment.

WELD 202 ARC Welding II 3 Credits

Prerequisites: WELD 103, WELD 108, and WELD 109. Covers the welding of ferrous metals and alloys utilizing electric welding methods and techniques. Safety hazards and safe practices in arc welding are covered. Extensive practice in the vee groove butt welds in all positions, using a back-up strip, and low hydrogen electrodes in all positions are covered.

WELD 203 Pipe Welding I 3 Credits

Prerequisites: WELD 206. This course provides extensive practice in the preparation and welding of pipe in the 2G and 5G position, and information of preparation, methods of welding, and electrode and filler wires used.

WELD 204 Pipe Welding II 3 Credits

Prerequisites: WELD 108, WELD 206, WELD 207 and WELD 208. Provides extensive training in the preparation and welding of pipe in the 5G and 6G position. Includes information on preparation, method of welding, and electrodes and filler rods used.

WELD 205 Welding Codes, Specifications and Estimating 3 Credits

Prerequisites: Advisor Approval. Provides students with different types of welding codes and testing operations. Covers procedures, specifications and information about filler materials, positions, post-heat and preheat treatment, backing strips, preparations of parent metals, cleaning and defects. Introduces students to various welding processes used in the welding industry. Prepares students with a background in which will assist them in taking the American Welding Society Certified Welding Inspector exam. The AWS, ASME and other codes are discussed.

WELD 206 Shielded Metal Arc Welding II 3 Credits

Prerequisites: WELD 108. Covers SMAW welding equipment and products used to produce groove type butt and fillet welds. Provides

extensive practice to develop the skills to achieve satisfactory welds of this type. Safety hazards and safe practices in arc welding are emphasized.

WELD 207 Gas Metal Arc (MIG) Welding 3 Credits

Prerequisites: None. Considers various gas metal welding (GMAW) processes including microwire, flux-core, inner shield, and submerged arc with emphasis on metal inert gas welding. Techniques of welding in all positions on various thicknesses metal.

WELD 208 Gas Tungsten Arc (TIG) Welding 3 Credits

Prerequisites: None. Provides students with thorough knowledge of the gas tungsten arc welding process. Includes detailed study of the techniques of making welds in all positions using the GTAW applications. Lectures and discussion provide additional background information essential to a qualified GTAW welder.

WELD 209 Welding Certification 3 Credits

Prerequisites: Advisor Approval. Prepares the student for certification in shielded metal arc, GTAW (Gas Tungsten Arc Welding), GMAW (Gas Metal Arc Welding) and other welding processes through study of the welding procedures and standards established by agencies such as the American Welding Society and the American Society of Mechanical Engineers.

WELD 210 Welding Fabrication I 3 Credits

Prerequisites: WELD 108, WELD 207 and INDT 102. Provides for continued practice in hands-on fabrication of welded products. Includes basic equipment used in fabrication.

WELD 211 Welding Fabrication II 3 Credits

Prerequisites: WELD 108, WELD 207 and INDT 102. Provides opportunities for practice in hands-on fabrication of welded products. Includes basic equipment used in fabrication.

WELD 271 Blueprint Reading for Welders 3 Credits

Prerequisite: None. Provides the basic concept of reading a fabrication blueprint and covers the different parts of the print. It also provides an understanding of welding symbols used in blueprint reading. Computations of basic measurements including fraction and metrics along with conversion from one to the other are also covered. This course is designed for beginning welders and fabricators, and anyone needing to understand basic fabrication and assembly blueprints.

WELD 272 Gas Metal (MIG) Welding II 3 Credits

Prerequisite: None. This course is an extension of the processes learned in WELD 207 consisting of various gas metal welding (GMAW) processes including microwire, flux-core, inner shield, and

submerged arc with emphasis on metal inert gas welding. Techniques of welding in all positions on various thicknesses of metal.

WELD 273 Gas Tungsten Arc Welding II 3 Credits

Prerequisite: None. Provides advanced skills and knowledge in Gas Tungsten Arc Welding. This course is designed for intermediate welders, auto service and body technicians, and individuals in the HVAC industry. Emphasizes safe practices in advanced Gas Tungsten Arc Welding.

WELD 274 Flux Core Arc Welding 3 Credits

Prerequisite: None. Covers Flux Core Arc Welding (FCAW) equipment and products used to produce groove and fillet welds. Provides extensive practice to develop the skills to achieve satisfactory welds in all positions, using self shielding and gas shielded wires. Provides the opportunity to achieve AWS qualification or certification. Safety hazards and safe practices in FCAW are emphasized.

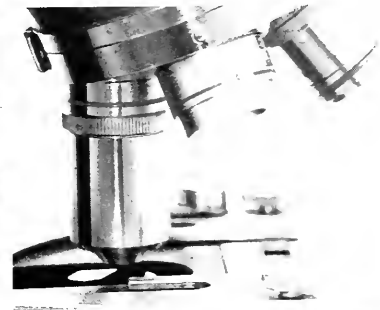

PROGRAM AVAILABILITY



ANDERSON CAMPUS

Associate of Applied Science

Accounting
Accounting (via distance)
Business Administration
Business Administration (via distance)
Computer Information Systems
Computer Information Systems (via distance)
Computer Information Technology
Criminal Justice
Criminal Justice (via distance)
Design Technology
Design Technology (via distance)
Early Childhood Education (via distance)
Electronics and Computer Technology
Human Services
Human Services (via distance)
Industrial Technology
Medical Assisting
Office Administration
Office Administration (via distance)
Paralegal Studies (via distance)

Technical Certificate

Accounting
Business Administration
Computer Information Systems
Computer Information Technology
Dental Assisting
Early Childhood Education (via distance)
Human Services
Industrial Technology
Medical Assisting
Office Administration
Practical Nursing

Certificate

Accounting
Business Administration
Computer Information Systems

Computer Information Technology
Industrial Technology
Office Administration

Associate of Science

Business Administration
Computer Information Systems
Criminal Justice
Design Technology
Electronics and Computer Technology
General Studies
Human Services
Human Services (via distance)
Liberal Arts
Library Technical Assistant (via distance)
Nursing
Paralegal Studies (via distance)
Visual Communications

Associate of Arts

Liberal Arts

BATESVILLE CAMPUS

Associate of Science

Business Administration

BLOOMINGTON CAMPUS

Associate of Applied Science

Accounting
Accounting (via distance)
Advanced Manufacturing
Biotechnology
Business Administration
Business Administration (via distance)
Computer Information Systems
Computer Information Systems (via Distance)
Computer Information Technology
Criminal Justice
Design Technology

Design Technology (via distance)
Early Childhood Education
Early Childhood Education (via distance)
Electronics and Computer Technology
Hospitality Administration
Human Services
Human Services (via distance)
Industrial Technology
Office Administration
Office Administration (via distance)
Paralegal Studies
Paralegal Studies (via distance)
Public Service

Technical Certificate

Accounting
Business Administration
Early Childhood Education
Early Childhood Education (via distance)
Hospitality Administration
Human Services
Industrial Technology
Office Administration
Practical Nursing

Certificate

Accounting
Computer Information Systems
Computer Information Technology

Associate of Science

Biotechnology
Business Administration
Criminal Justice
Criminal Justice (via distance)
Design Technology
Education
Electronics and Computer Technology
General Studies
Health Information Technology
Hospitality Administration

Human Services
Human Services (via distance)
Kinesiology
Liberal Arts
Library Technical Assistant (via distance)
Nursing
Paralegal Studies
Paralegal Studies (via distance)
Paramedic Science
Radiation Therapy
Respiratory Care

Associate of Arts

Liberal Arts

COLUMBUS CAMPUS

Associate of Applied Science

Accounting
Accounting (via distance)
Advanced Manufacturing
Business Administration
Business Administration (via distance)
Computer Information Systems
Computer Information Systems (via distance)
Computer Information Technology
Criminal Justice
Design Technology
Design Technology (via distance)
Early Childhood Education
Early Childhood Education (via distance)
Human Services
Human Services (via distance)
Interior Design
Industrial Technology
Medical Assisting
Office Administration
Office Administration (via distance)
Paralegal Studies (via distance)
Paramedic Science
Surgical Technology

Visual Communications
Technical Certificate
Accounting
Central Services Technician
Dental Assisting
Design Technology
Early Childhood Education
Early Childhood Education (via distance)
Human Services
Industrial Technology
Medical Assisting
Office Administration
Practical Nursing

Certificate

Business Administration
Computer Information Systems
Computer Information Technology
Industrial Technology
Information Security

Associate of Science

Accounting
Agriculture
Business Administration
Computer Information Systems
Criminal Justice
Criminal Justice (via distance)
Design Technology
Early Childhood Education
Education
General Studies
Human Services
Human Services (via distance)
Liberal Arts
Mechanical Engineering Technology
Library Technical Assistant (via distance)
Nursing
Paralegal Studies (via distance)
Paramedic Science
Visual Communications

Associate of Arts

Liberal Arts

CONNERSVILLE CAMPUS

Associate of Applied Science

Advanced Manufacturing
Industrial Technology

Certificate

Advanced Manufacturing
Industrial Technology

Associate of Science

Industrial Technology

EAST CHICAGO CAMPUS

Associate of Applied Science

Accounting
Accounting (via distance)
Automotive Technology
Building Construction Management
Business Administration
Business Administration (via distance)
Computer Information Systems (via distance)
Construction Technology
Design Technology
Design Technology (via distance)
Early Childhood Education (via distance)
Hospitality Administration
Human Services (via distance)
Industrial Technology
Mortuary Science
Office Administration
Office Administration (via distance)
Paralegal Studies (via distance)

Technical Certificate

Accounting
Automotive Technology

Business Administration
Computer Information Systems
Computer Information Technology
Construction Technology
Design Technology
Early Childhood Education (via distance)
Hospitality Administration
Industrial Technology
Office Administration

Certificate

Accounting
Automotive Technology
Business Administration
Computer Information Systems
Computer Information Technology
Construction Technology
Industrial Technology
Office Administration

Associate of Science

Building Construction Management
Business Administration
Computer Information Systems
Criminal Justice (via distance)
Design Technology
General Studies
Human Services (via distance)
Liberal Arts
Library Technical Assistant (via distance)
Paralegal Studies (via distance)

Associate of Arts

Liberal Arts

ELKHART CAMPUS

Associate of Applied Science

Accounting
Accounting (via distance)
Business Administration

Business Administration (via distance)
Computer Information Systems
Computer Information Systems (via distance)
Computer Information Technology
Design Technology
Design Technology (via distance)
Early Childhood Education (via distance)
Electronics and Computer Technology
Human Services (via distance)
Medical Assisting
Office Administration (via distance)
*Paralegal Studies (via distance)
Recreational Vehicle Service Technology

Technical Certificate

Business Administration
Computer Information Systems
Computer Information Technology
Early Childhood Education
Early Childhood Education (via distance)
Medical Assisting
Practical Nursing
Recreational Vehicle Service Technology

Certificate

Accounting
Automotive Technology
Business Administration
Computer Information Systems
Computer Information Technology
Industrial Technology
Office Administration

Associate of Science

Accounting
Business Administration
Computer Information Systems
Computer Information Systems (via distance)
Criminal Justice (via distance)
Design Technology
Electronics and Computer Technology

General Studies
Human Services
Human Services (via distance)
Liberal Arts
Library Technical Assistant (via distance)
Paralegal Studies (via distance)

Associate of Arts

Liberal Arts

EVANSVILLE CAMPUS

Associate of Applied Science

Accounting
Accounting (via distance)
Advanced Manufacturing
Automotive Technology
Building Construction Management
Business Administration
Business Administration (via distance)
Computer Information Systems
Computer Information Systems (via distance)
Computer Information Technology
Construction Technology
Criminal Justice
Design Technology
Design Technology (via distance)
Early Childhood Education
Early Childhood Education (via distance)
Electronics and Computer Technology
Hospitality Administration
Human Services
Human Services (via distance)
Interior Design
Industrial Technology
Medical Assisting
Office Administration
Office Administration (via distance)
Paralegal Studies (via distance)
Paramedic Science
Public Safety

Surgical Technology
Visual Communications

Technical Certificate

Accounting
Automotive Technology
Business Administration
Early Childhood Education
Early Childhood Education (via distance)
Hospitality Administration
Manufacturing & Industrial Technology
Medical Assisting
Office Administration
Practical Nursing
Public Safety

Certificate

Accounting
Automotive Technology
Business Administration
Computer Information Systems
Computer Information Technology
Construction Technology
Industrial Technology
Office Administration

Associate of Science

Biotechnology
Building Construction Management
Business Administration
Computer Information Systems
Criminal Justice
Criminal Justice (via distance)
Design Technology
Early Childhood Education
Education
Electronics and Computer Technology
General Studies (via distance)
Human Services
Human Services (via distance)
Liberal Arts

Library Technical Assistant (via distance)
Nursing
Paralegal Studies (via distance)
Pre-Engineering
Visual Communications

Associate of Arts

Liberal Arts

FORT WAYNE CAMPUS

Associate of Applied Science

Accounting
Accounting (via distance)
Advanced Manufacturing
Automotive Technology
Aviation Technology
Building Construction Management
Business Administration
Business Administration (via distance)
Computer Information Systems
Computer Information Systems (via distance)
Computer Information Technology
Construction Technology
Criminal Justice
Design Technology
Design Technology (via distance)
Early Childhood Education
Early Childhood Education (via distance)
Hospitality Administration
Human Services (via distance)
Industrial Technology
Medical Assisting
Office Administration
Office Administration (via distance)
Paralegal Studies (via distance)
Public Safety
Therapeutic Massage

Technical Certificate

Accounting
Automotive Technology

Computer Information Systems
Computer Information Technology
Construction Technology
Design Technology
Early Childhood Education
Early Childhood Education (via distance)
Hospitality Administration
Industrial Technology
Medical Assisting
Office Administration
Practical Nursing
Public Safety
Therapeutic Massage

Certificate

Accounting
Automotive Technology
Business Administration
Computer Information Systems
Computer Information Technology
Construction Technology
Industrial Technology
Office Administration

Associate of Science

Building Construction Management
Business Administration
Computer Information Systems
Criminal Justice
Criminal Justice (via distance)
Design Technology
Early Childhood Education
Education
General Studies
Human Services
Human Services (via distance)
Liberal Arts
Library Technical Assistant (via distance)
Nursing
Office Administration
Paralegal Studies

Paralegal Studies (via distance)
Paramedic Science
Respiratory Care

Associate of Arts
Liberal Arts

GARY CAMPUS

Associate of Applied Science

Accounting
Accounting (via distance)
Business Administration
Business Administration (via distance)
Computer Information Systems
Computer Information Systems (via distance)
Computer Information Technology
Design Technology (via distance)
Early Childhood Education
Early Childhood Education (via distance)
Electronics and Computer Technology
Hospitality Administration
Human Services (via distance)
Industrial Technology
Office Administration (via distance)
Paralegal Studies (via distance)
Public Safety

Technical Certificate

Accounting
Business Administration
Computer Information Systems
Computer Information Technology
Early Childhood Education
Early Childhood Education (via distance)
Hospitality Administration
Industrial Technology
Office Administration
Practical Nursing

Certificate

Accounting
Automotive Technology
Business Administration
Computer Information Systems
Computer Information Technology
Construction Technology
Industrial Technology
Office Administration

Associate of Science

Business Administration
Computer Information Systems
Criminal Justice (via distance)
Early Childhood Education
General Studies
Human Services (via distance)
Liberal Arts
Library Technical Assistant (via distance)
Nursing
Paralegal Studies (via distance)
Paramedic Science
Physical Therapist Assistant
Respiratory Care

Associate of Arts

Liberal Arts

GREENCASTLE CAMPUS

Associate of Applied Science

Business Administration
Electronics and Computer Technology

Technical Certificate

Practical Nursing

Associate of Science

Business Administration
Electronics and Computer Technology
Nursing

INDIANAPOLIS CAMPUS

Associate of Applied Science

Accounting
Accounting (via distance)
Advanced Manufacturing
Automotive Technology
Biotechnology
Business Administration
Business Administration (via distance)
Computer Information Systems
Computer Information Systems (via distance)
Computer Information Technology
Criminal Justice
Design Technology
Design Technology (via distance)
Early Childhood Education (via distance)
Electronics & Computer Technology
Hospitality Administration
Human Services (via distance)
Machine Tool Technology
Industrial Technology
Medical Assisting
Mortuary Science
Office Administration
Office Administration (via distance)
Paralegal Studies
Paralegal Studies (via distance)
Public Safety
Surgical Technology
Visual Communications

Technical Certificate

Accounting
Automotive Technology
Business Administration
Computer Information Systems
Computer Information Technology
Design Technology
Early Childhood Education
Early Childhood Education (via distance)
Industrial Technology

Medical Assisting
Office Administration
Practical Nursing

Certificate

Accounting
Automotive Technology
Computer Information Systems
Computer Information Technology

Associate of Fine Arts

Fine Arts
Visual Communications

Associate of Science

Accounting
Automotive Technology
Biotechnology
Business Administration
Community Emergency Preparedness & Management
Computer Information Systems
Criminal Justice
Criminal Justice (via distance)
Design Technology
Early Childhood Education
Education
Electrical Engineering Technology
Electronics and Computer Technology
General Studies
Health Information Technology
Human Services
Human Services (via distance)
Industrial Technology
Liberal Arts
Library Technical Assistant (via distance)
Nursing
Office Administration
Paralegal Studies (via distance)
Paramedic Science
Radiologic Technology
Respiratory Care

Surgical Technology
Transportation, Distribution and Logistics
Visual Communications

Associate of Arts

Liberal Arts

KOKOMO CAMPUS

Associate of Applied Science

Accounting
Accounting (via distance)
Advanced Manufacturing
Agriculture
Automotive Technology
Business Administration
Business Administration (via distance)
Computer Information Systems
Computer Information Systems (via distance)
Computer Information Technology
Construction Technology
Criminal Justice
Design Technology
Design Technology (via distance)
Early Childhood Education
Early Childhood Education (via distance)
Human Services
Human Services (via distance)
Industrial Technology
Medical Assisting
Office Administration
Office Administration (via distance)
Paralegal Studies
Paralegal Studies (via distance)
Public Safety
Visual Communications

Technical Certificate

Accounting
Automotive Technology
Business Administration

Computer Information Systems
Computer Information Technology
Construction Technology
Dental Assisting
Design Technology
Early Childhood Education
Early Childhood Education (via distance)
Industrial Technology
Medical Assisting
Office Administration
Practical Nursing
Public Safety

Certificate

Accounting
Automotive Technology
Business Administration
Computer Information Systems
Computer Information Technology
Construction Technology
Industrial Technology
Office Administration

Associate of Science

Accounting
Agriculture
Business Administration
Computer Information Systems
Criminal Justice
Criminal Justice (via distance)
Design Technology
Early Childhood Education
Education
General Studies
Human Services
Human Services (via distance)
Liberal Arts
Library Technical Assistant (via distance)
Nursing
Paralegal Studies
Paralegal Studies (via distance)

Paramedic Science
Professional Communication
Surgical Technology
Visual Communications

Associate of Arts

Liberal Arts

LAWRENCEBURG CAMPUS

Associate of Applied Science

Accounting
Accounting (via distance)
Business Administration
Business Administration (via distance)
Computer Information Systems
Computer Information Systems (via distance)
Computer Information Technology
Design Technology
Design Technology (via distance)
Early Childhood Education (via distance)
Human Services (via distance)
Medical Assisting
Office Administration (via distance)
Paralegal Studies (via distance)

Technical Certificate

Accounting
Business Administration
Early Childhood Education (via distance)
Medical Assisting

Certificate

Accounting
Automotive Technology
Business Administration
Computer Information Systems
Computer Information Technology
Industrial Technology

Associate of Science

Business Administration
Computer Information Systems
Criminal Justice (via distance)
Design Technology
Education
General Studies
Human Services (via distance)
Liberal Arts
Library Technical Assistant (via distance)
Nursing
Paralegal Studies (via distance)

Associate of Arts

Liberal Arts

LAFAYETTE CAMPUS

Associate of Applied Science

Accounting
Accounting (via distance)
Advanced Manufacturing
Agriculture
Automotive Technology
Biotechnology
Business Administration
Business Administration (via distance)
Chemical Technology
Computer Information Systems
Computer Information Systems (via distance)
Computer Information Technology
Criminal Justice
Design Technology
Early Childhood Education
Early Childhood Education (via distance)
Human Services
Human Services (via distance)
Industrial Technology
Medical Assisting
Office Administration
Office Administration (via distance)
Paralegal Studies

Paralegal Studies (via distance)
Surgical Technology

Technical Certificate

Accounting
Automotive Technology
Business Administration
Computer Information Systems
Computer Information Technology
Dental Assisting
Design Technology
Early Childhood Education
Early Childhood Education (via distance)
Human Services
Industrial Technology
Medical Assisting
Office Administration
Practical Nursing

Certificate

Accounting
Automotive Technology
Business Administration
Computer Information Systems
Computer Information Technology
Industrial Technology
Office Administration

Associate of Science

Accounting
Agriculture
Automotive Technology
Biotechnology
Business Administration
Computer Information Systems
Criminal Justice
Criminal Justice (via distance)
Design Technology
Early Childhood Education
Education
General Studies
Health Information Technology

Human Services
Human Services (via distance)
Liberal Arts
Library Technical Assistant (via distance)
Mechanical Engineering Technology
Nursing
Paralegal Studies
Paralegal Studies (via distance)
Respiratory Care
Visual Communications

Associate of Arts

Liberal Arts

LOGANSPOUR CAMPUS

Associate of Applied Science

Accounting (via distance)
Business Administration
Business Administration (via distance)
Computer Information Systems
Computer Information Systems (via distance)
Criminal Justice
Design Technology (via distance)
Early Childhood Education
Early Childhood Education (via distance)
Human Services (via distance)
Industrial Technology
Medical Assisting
Office Administration
Office Administration (via distance)
Paralegal Studies (via distance)

Technical Certificate

Business Administration
Computer Information Systems
Early Childhood Education
Early Childhood Education (via distance)
Industrial Technology
Medical Assisting
Office Administration
Practical Nursing

Certificate

Accounting
Business Administration
Computer Information Systems
Industrial Technology
Office Administration

Associate of Science

Business Administration
Computer Information Systems
Criminal Justice
Criminal Justice (via distance)
Early Childhood Education
General Studies
Human Services (via distance)
Liberal Arts
Library Technical Assistant (via distance)
Nursing
Office Administration
Paralegal Studies (via distance)

Associate of Arts

Liberal Arts

MADISON CAMPUS

Associate of Applied Science

Accounting
Accounting (via distance)
Business Administration
Business Administration (via distance)
Computer Information Systems
Computer Information Systems (via distance)
Computer Information Technology
Design Technology (via distance)
Early Childhood Education (via distance)
Human Services (via distance)
Industrial Technology
Medical Assisting
Office Administration (via distance)
Paralegal Studies (via distance)

Technical Certificate

Accounting
Business Administration
Computer Information Systems
Computer Information Technology
Early Childhood Education (via distance)
Human Services
Industrial Technology
Medical Assisting
Practical Nursing

Certificate

Accounting
Business Administration
Computer Information Technology
Industrial Technology

Associate of Science

Business Administration
Criminal Justice (via distance)
General Studies
Human Services (via distance)
Liberal Arts
Library Technical Assistant (via distance)
Nursing
Paralegal Studies (via distance)

Associate of Arts

Liberal Arts

MARION CAMPUS

Associate of Applied Science

Accounting
Accounting (via distance)
Business Administration
Business Administration (via distance)
Computer Information Systems
Computer Information Systems (via distance)
Computer Information Technology
Criminal Justice
Design Technology

Design Technology (via distance)
Early Childhood Education (via distance)
Human Services
Human Services (via distance)
Industrial Technology
Medical Assisting
Office Administration
Office Administration (via distance)
Paralegal Studies (via distance)

Technical Certificate

Accounting
Business Administration
Computer Information Systems
Computer Information Technology
Early Childhood Education (via distance)
Human Services
Industrial Technology
Medical Assisting
Office Administration

Certificate

Accounting
Business Administration
Computer Information Systems
Computer Information Technology
Industrial Technology
Office Administration

Associate of Science

Business Administration
Computer Information Systems
Criminal Justice
Criminal Justice (via distance)
Design Technology
General Studies
Human Services
Human Services (via distance)
Liberal Arts
Library Technical Assistant (via distance)
Nursing
Paralegal Studies (via distance)

Radiologic Technology
Visual Communications

Associate of Arts

Liberal Arts

MICHIGAN CITY CAMPUS

Associate of Applied Science

Accounting (via distance)
Business Administration
Business Administration (via distance)
Computer Information Systems (via distance)
Design Technology
Design Technology (via distance)
Early Childhood Education (via distance)
Hospitality Administration
Human Services (via distance)
Medical Assisting
Office Administration (via distance)
Paralegal Studies (via distance)

Technical Certificate

Accounting
Business Administration
Design Technology
Early Childhood Education (via distance)
Hospitality Administration
Industrial Technology
Medical Assisting

Certificate

Accounting
Automotive Technology
Business Administration
Construction Technology
Industrial Technology
Office Administration

Associate of Science

Business Administration

Criminal Justice (via distance)
Education
General Studies
Human Services (via distance)
Liberal Arts
Library Technical Assistant (via distance)
Paralegal Studies (via distance)
Paramedic Science

Associate of Arts

Liberal Arts

MUNCIE CAMPUS

Associate of Applied Science

Accounting
Accounting (via distance)
Automotive Technology
Business Administration
Business Administration (via distance)
Computer Information Systems
Computer Information Systems (via distance)
Computer Information Technology
Construction Technology
Criminal Justice
Design Technology
Design Technology (via distance)
Early Childhood Education
Early Childhood Education (via distance)
Electronics & Computer Technology
Hospitality Administration
Human Services
Human Services (via distance)
Industrial Technology
Medical Assisting
Office Administration
Office Administration (via distance)
Paralegal Studies
Paralegal Studies (via distance)
Public Safety
Surgical Technology

Technical Certificate

Accounting
 Automotive Technology
 Business Administration
 Computer Information Systems
 Computer Information Technology
 Construction Technology
 Early Childhood Education
 Early Childhood Education (via distance)
 Hospitality Administration
 Human Services
 Industrial Technology
 Medical Assisting
 Office Administration
 Practical Nursing
 Public Safety

Certificate

Accounting
 Automotive Technology
 Business Administration
 Computer Information Systems
 Computer Information Technology
 Construction Technology
 Industrial Technology
 Office Administration

Associate of Science

Agriculture
 Business Administration
 Computer Information Systems
 Criminal Justice
 Criminal Justice (via distance)
 Design Technology
 Early Childhood Education
 Education
 Electronics and Computer Technology
 General Studies
 Hospitality Administration
 Human Services
 Human Services (via distance)
 Liberal Arts

Library Technical Assistant (via distance)
 Nursing
 Paralegal Studies
 Paralegal Studies (via distance)
 Physical Therapist Assistant
 Visual Communications

Associate of Arts

Liberal Arts

NEW CASTLE CAMPUS**Associate of Science**

Nursing

RICHMOND CAMPUS**Associate of Applied Science**

Accounting
 Accounting (via distance)
 Advanced Manufacturing
 Agriculture
 Automotive Technology
 Business Administration
 Business Administration (via distance)
 Computer Information Systems
 Computer Information Systems (via distance)
 Computer Information Technology
 Construction Technology
 Design Technology (via distance)
 Early Childhood Education
 Early Childhood Education (via distance)
 Early Childhood Education (via distance)
 Human Services (via distance)
 Industrial Technology
 Medical Assisting
 Office Administration
 Office Administration (via distance)
 Paralegal Studies (via distance)

Technical Certificate

Accounting
 Automotive Technology

Computer Information Systems
 Computer Information Technology
 Construction Technology
 Early Childhood Education
 Medical Assisting
 Office Administration
 Practical Nursing

Certificate

Accounting
 Automotive Technology
 Business Administration
 Computer Information Systems
 Computer Information Technology
 Construction Technology
 Industrial Technology
 Office Administration

Associate of Science

Agriculture
 Business Administration
 Computer Information Systems
 Criminal Justice (via distance)
 Early Childhood Education
 Education
 General Studies
 Human Services (via distance)
 Liberal Arts
 Library Technical Assistant (via distance)
 Industrial Technology
 Nursing
 Paralegal Studies (via distance)
 Radiologic Technology

Associate of Arts

Liberal Arts

SELLERSBURG CAMPUS**Associate of Applied Science**

Accounting
 Accounting (via distance)

Advanced Manufacturing
Business Administration
Business Administration (via distance)
Computer Information Systems
Computer Information Systems (via distance)
Computer Information Technology
Criminal Justice
Design Technology
Design Technology (via distance)
Early Childhood Education
Early Childhood Education (via distance)
General Studies
Human Services
Human Services (via distance)
Industrial Technology
Medical Assisting
Medical Laboratory Technology
Office Administration
Office Administration (via distance)
Paralegal Studies (via distance)
Visual Communications

Technical Certificate

Accounting
Business Administration
Computer Information Technology
Design Technology
Early Childhood Education
Early Childhood Education (via distance)
Human Services
Industrial Technology
Medical Assisting
Office Administration
Practical Nursing

Certificate

Accounting
Business Administration
Computer Information Technology
Industrial Technology
Office Administration

Associate of Science
Business Administration
Computer Information Systems
Criminal Justice (via distance)
Design Technology
Early Childhood Education
Education
General Studies
Human Services
Human Services (via distance)
Liberal Arts
Library Technical Assistant (via distance)
Nursing
Paralegal Studies (via distance)
Respiratory Care
Visual Communications

SOUTH BEND CAMPUS

Associate of Applied Science

Accounting
Accounting (via distance)
Automotive Technology
Business Administration
Business Administration (via distance)
Computer Information Systems
Computer Information Systems (via distance)
Computer Information Technology
Design Technology
Design Technology (via distance)
Early Childhood Education
Early Childhood Education (distance)
Electronics and Computer Technology
Hospitality Administration
Human Services
Human Services (via distance)
Interior Design
Industrial Technology
Medical Assisting
Medical Laboratory Technology

Office Administration
Office Administration (via distance)
Paralegal Studies
Paralegal Studies (via distance)
Public Safety
Visual Communications
Technical Certificate
Accounting
Automotive Technology
Business Administration
Computer Information Systems
Computer Information Technology
Early Childhood Education
Early Childhood Education (via distance)
Human Services
Industrial Technology
Medical Assisting
Office Administration
Practical Nursing
Public Safety

Certificate

Accounting
Automotive Technology
Business Administration
Computer Information Systems
Computer Information Technology
Industrial Technology
Office Administration

Associate of Fine Arts

Visual Communications

Associate of Science

Biotechnology
Business Administration
Computer Information Systems
Computer Information Systems (via distance)
Criminal Justice
Criminal Justice (via distance)
Dental Hygiene
Design Technology
Early Childhood Education
Education

Electrical Engineering Technology
Electronics and Computer Technology
General Studies
Human Services
Human Services (via distance)
Industrial Technology
Interior Design
Liberal Arts
Library Technical Assistant (via distance)
Nursing
Office Administration
Paralegal Studies
Paralegal Studies (via distance)
Paramedic Science
Respiratory Care
Visual Communications

Associate of Arts

Liberal Arts

TELL CITY CAMPUS

Associate of Applied Science

Office Administration

Technical Certificate

Industrial Technology
Office Administration

TERRE HAUTE CAMPUS

Associate of Applied Science

Accounting
Accounting (via distance)
Advanced Manufacturing
Agriculture
Automotive Technology
Biotechnology
Business Administration
Business Administration (via distance)
Computer Information Systems
Computer Information Systems (via distance)

Computer Information Technology
Design Technology
Design Technology (via distance)
Early Childhood Education
Early Childhood Education (via distance)
Electronics and Computer Technology
Human Services (via distance)
Industrial Technology
Medical Assisting
Medical Laboratory Technology
Office Administration
Office Administration (via distance)
Paralegal Studies (via distance)
Paramedic Science
Surgical Technology
Visual Communications

Technical Certificate

Accounting
Automotive Technology
Early Childhood Education
Early Childhood Education (via distance)
Industrial Technology
Medical Assisting
Office Administration
Practical Nursing

Certificate

Accounting
Advanced Manufacturing
Automotive Technology
Business Administration
Computer Information Systems
Computer Information Technology
Construction Technology
Industrial Technology
Office Administration

Associate of Science

Agriculture
Automotive Technology
Biotechnology

Business Administration
Business Administration (via distance)
Computer Information Systems
Criminal Justice
Criminal Justice (via distance)
Design Technology
Early Childhood Education
Education
Electronics and Computer Technology
General Studies
Human Services
Human Services (via distance)
Liberal Arts
Library Technical Assistant (via distance)
Nursing
Paralegal Studies (via distance)
Radiologic Technology
Respiratory Care
Visual Communications

Associate of Arts

Liberal Arts

VALPARAISO CAMPUS

Associate of Applied Science

Accounting
Accounting (via distance)
Advanced Manufacturing
Business Administration
Business Administration (via distance)
Computer Information Systems
Computer Information Systems (via distance)
Computer Information Technology
Criminal Justice
Design Technology
Design Technology (via distance)
Early Childhood Education (via distance)
Human Services (via distance)
Industrial Technology
Office Administration (via distance)
Paralegal Studies

Paralegal Studies (via distance)
Surgical Technology

Technical Certificate

Accounting
Business Administration
Computer Information Systems
Computer Information Technology
Design Technology
Early Childhood Education (via distance)
Human Services
Industrial Technology
Office Administration
Practical Nursing

Certificate

Accounting
Business Administration
Computer Information Systems
Computer Information Technology
Industrial Technology
Office Administration

Associate of Science

Business Administration
Computer Information Systems
Computer Information Systems (via distance)
Criminal Justice
Criminal Justice (via distance)
Design Technology
General Studies
Human Services (via distance)
Liberal Arts
Library Technical Assistant (via distance)
Nursing
Paralegal Studies
Paralegal Studies (via distance)
Pre-Engineering

Associate of Arts

Liberal Arts

WABASH CAMPUS

Associate of Applied Science

Business Administration
Computer Information Technology
Industrial Technology

Technical Certificate

Business Administration
Computer Information Technology
Practical Nursing

Associated of Science

Business Administration
Industrial Technology

WARSAW CAMPUS

Associate of Applied Science

Accounting (via distance)
Agriculture
Business Administration
Business Administration (via distance)
Computer Information Systems
Computer Information Systems (via distance)
Computer Information Technology
Design Technology (via distance)
Early Childhood Education (via distance)
Human Services (via distance)
Medical Assisting
Office Administration (via distance)
Paralegal Studies (via distance)

Technical Certificate

Accounting
Business Administration
Computer Information Systems
Computer Information Technology
Early Childhood Education
Early Childhood Education (via distance)
Medical Assisting

Certificate

Accounting
Automotive Technology
Business Administration
Computer Information Systems
Computer Information Technology
Industrial Technology
Office Administration
Associate of Science
Agriculture
Business Administration
Computer Information Systems
Computer Information Systems (via distance)
Criminal Justice (via distance)
General Studies
Human Services
Human Services (via distance)
Liberal Arts
Library Technical Assistant (distance)
Paralegal Studies (via distance)

Associate of Arts

Liberal Arts



FACULTY AND STAFF



NORTHWEST REGION

VALTIERRA, JOSE GUADALUPE, Chancellor; BA, Purdue University; MS, JD, Indiana University
THOSTENSEN, DAWN, Executive Director of Finance; BS, MS, College of New Jersey
GONZALEZ, R. LOUIE, Vice Chancellor/Dean, East Chicago; BS, Calumet College of Saint Joseph; MPA, Indiana University
HAKLIN, DELORES, Vice Chancellor/Dean, Valparaiso; BA, Simpson College; MS, St. Francis College; PhD, Indiana State University
HUDDLESTON, JERRY L., Vice Chancellor/Dean, Michigan City; BS, MA, Ball State University
HALIK, DEBORAH A., Vice Chancellor of Academic Affairs; BS, Calumet College of Saint Joseph; MS, Purdue University; PhD, Indiana State University
HOWARD, R. KEITH, Vice Chancellor of Student Affairs; BA, DePauw University; MPA, ABD, Indiana University
POLLARD, LDUWISE F., Assistant Vice-Chancellor of Academic Affairs and ASA Division Chair, Gary; BS, Wayne State University; MRC, Arkansas State University
ROSENBLUM, KENNETH, Assistant Vice-Chancellor of Academic Affairs—Valparaiso; BS, University of Wisconsin; JD, DePaul University
WORDSZ, MICHAEL, Assistant Vice-Chancellor of Academic Affairs; MS, Indiana State University

FACULTY

ABEYTA, ELIDA, Instructor in Hospitality, Assistant Program Chair, East Chicago; AAS, Ivy Tech State College
ADAMSKI, JOHN, Assistant Professor in General Education, Gary; BS, Indiana State; MS, Purdue University
ALSPAUGH, DEBORAH M., Associate Professor in Academic Skills Advancement, Program Chair, Gary; BS, MPA, Indiana University
APPLEHANS, MICHAEL, Instructor in Mathematics and Sciences, Gary; BSCE, MSCE, Purdue University West Lafayette
BANKS, MARY A., Associate Professor in Office Administration, East Chicago; BS, Alcorn A & M; MS, Indiana University
BANCSI, DAWN, Assistant Professor in Physical Therapy Assistant, Program Chair, Gary; BS, University of Illinois, M.P.T., Governors State University
BERG, CYNTHIA, Instructor in Nursing, Valparaiso; BSN, Indiana Wesleyan
BOX, TOM, Instructor in Industrial Technology, Program Chair, Gary; BA, St. Leo University
BREEN, BARBARA, Instructor in Liberal Arts and Sciences, Michigan City; BA, Indiana University, MS, University of Georgia
BREEN, JANET, Associate Professor in Accounting, Program Chair, Valparaiso; MS, DePaul University
BUTTERFIELD, BRYON, Instructor in Industrial Technology, Assistant Program Chair, East Chicago; AAS, Ivy Tech Community College
CATSADIMAS, NICHOLAS C., Instructor in Paralegal Studies, Program Chair, Valparaiso; BS, Valparaiso University; JD, Valparaiso University School of Law
CLARK, HEATHER, Assistant Professor in English, East Chicago; BA & MA, Purdue University
COPE, CHARLES T., Instructor in Construction Technology, East Chicago; AAS, Ivy Tech State College; Certified in Steel Framing, American Iron and Steel Institute
CORNELIUS-ELLIS, SHARON, Instructor in Nursing, Gary; AA, San Joaquin Delta College, BS, Southern Illinois University
COURTNEY, MATTHEW N.; Instructor in Biological Sciences; Assistant Program Chair Valparaiso Campus, BA,

Southern Illinois University, MS, Purdue University
DAVIES, SUSAN, Associate Professor in Early Childhood Education, Program Chair, Gary; BA & MS, Purdue University
DELBY, RICHARD, Instructor in Hospitality, Assistant Program Chair, Gary; BS, Governors State University
DENEAL PATRICIA D., Associate Professor in Practical Nursing, Gary; Diploma, St. Mary Mercy; BS, St. Francis; MS, University of Notre Dame
DEVANEY, CATHERINE, Instructor in Nursing, Valparaiso; BSN, Valparaiso University
DOWNS, DALE C., Associate Professor in Mathematics and Science, Dean of Liberal Arts & Sciences and Education, Michigan City; BS, Loyola University Chicago; MS, PhD, The University of Illinois at Chicago
DUNBAR, KAREN KAREIVA, Assistant Professor of Biology, Assistant Program Chair of Science, Valparaiso; BS Biology, University of Kentucky; MS Molecular Biology, Purdue University Calumet
DULIN, DARLENE, Instructor in Nursing, Valparaiso; BS, Goshen College
ERIKS, MARSHA, Instructor in Surgical Technology, Valparaiso; AAS, Ivy Tech State College
FABIAN, ALFRED E., Professor in Business Administration, Program Chair, Gary; BA, University of Georgia; MBA, Roosevelt University
FICKEN, JOANN, Education Program Chair, Assistant Professor, Education, Michigan City; BS, MS, Valparaiso University, Post-Graduate, Indiana Wesleyan
FORSYTHE, SYBIL, Associate Professor in Practical Nursing, Valparaiso; ASN, Purdue University; BS, MSN, MPA, Indiana University; EdD, Nova Southern University
GROSS, LEE, Instructor in Practical Nursing, Valparaiso; MSN, Valparaiso University
GUADIANA, JUAN P., Assistant Professor in Automotive Technology, Program Chair, East Chicago; ASE; AAS, Vincennes University; BS, Indiana State University
GUFFEY, SCOTT C.; Instructor in English, School of Liberal Arts and Sciences; Valparaiso Campus, BA, MA, Purdue University Calumet
GUTIERREZ, LARRY, Instructor in Construction Technology, Program Chair, East Chicago
HARDER, DIANE, Assistant Professor in Practical Nursing, Valparaiso; MS, Indiana University; EdD, Nova Southern University
HARRIS, DANITA S., Associate Professor in Respiratory Care, Gary; BS, Cabrini College; MPA, Indiana University
HARVEY, ETHEL, Associate Professor in Computer Information Systems, Computer Information Technology, Gary; BS, Purdue University; PBC, MBA, Indiana University
HENDERSON, CREOLA, Instructor in Practical Nursing, Gary; BSN, MPA, Indiana University
HERNANDEZ, CARLOS, Assistant Professor in Science, Assistant Program Chair, Liberal Arts and Sciences, East Chicago; MD, Industrial University of Santander
HORNE, SAUNDRA S., Professor in Practical Nursing, Program Chair, Gary; AAS, Purdue University; BS, MS, College of St. Francis
HORTON, RAMONA, Instructor in Nursing, Gary; AS, BS, Indiana University
HOWARD, KAREN, Instructor in Liberal Arts and Sciences, East Chicago; BS, MS, DePauw University
HOWE, AMY, Instructor in Nursing, Gary; BSN, Ball State University
IDDUWU, TOLULUPE, Assistant Professor Liberal Arts and ASA, Assistant Program Chair; Valparaiso; MA, University of Ibadan; M.A.L.S. Valparaiso University
IGBOGWUA, EIJE, Professor in Design Technology, East Chicago, Assistant Program Chair; BS, MS, Eastern Illinois University; PhD, University of Illinois
JAKICH-DRITZ, JERRI, Instructor in Nursing, Valparaiso; BSN, Purdue University
JEFTICH, DANNY P., Professor in Academic Skills Advancement and General Education, Valparaiso; BA, MS, College of St. Francis

JENKINS, STEPHEN, Instructor in Criminal Justice, Program Chair, Valparaiso; MA, Valparaiso University

JOHNSON, SHEILA, Associate Professor, Gary; BA, Central Michigan University; Med, Indiana Wesleyan University

JONIC, JOSEPH, Assistant Professor in Accounting, Program Chair - Business; BA, Med, Loyola University, MBA, ABD, Liberty University

JOSEKI, TONI, Assistant Professor in Mathematics, Valparaiso; AAS Ivy Tech Community College, BSEE, MSEE, Purdue University Calumet

JORDAN, PARNELL, Instructor in Industrial Technology, Assistant Program Chair, East Chicago; ASME, AWS Welding Certification

KANOLIS, CHRIS F., Associate Professor in Business Administration, Valparaiso; BA, MBA, Indiana University

LAYHEW, SUSAN J., Associate Professor in Respiratory Therapy, Program Chair, Gary; BS, Calumet College of St. Joseph; MA, National-Louis University

LOVE, NANCY L., Assistant Professor in Practical Nursing, Gary; AAS, Indiana University; BS, MSN, Purdue University

LYNCH-JACKSON, TRINA, Assistant Professor in Business, Gary; BS, Saint Joseph College; MPA, Indiana University

MACKOVYAK, ROBERT, Instructor in Construction Technology, Gary

MARINARO-KROUSH, RANDEE, Instructor in Nursing, Valparaiso; BS, Purdue University

MAS, JOSE, Instructor of Anatomy & Physiology, and Advanced Human Physiology, Gary; DVM, (Doctor of Veterinary Medicine), UNNE, (National University of the Northeast, Corrientes, Argentina)

MATAVULJ, OLGA, Assistant Program Chair-Language Arts, Valparaiso; BA-English Language and Literature, Indiana University; BA-Modern English Language and Literature, Belgrade, University, Serbia, MALS, English Language and Literature, Valparaiso University

MCDONALD, DEANNA, Assistant Professor of Sociology, BA Purdue University, MSW Loyola University, Chicago.

MCKIDDY, JAMES, Instructor in Industrial Technology, Assistant Program Chair, Valparaiso; Apprenticeship Certified, American School

MERRILL, DAVID, Associate Professor in General Education, Assistant Program Chair in Science, Michigan City; BS, Ramapo College of New Jersey; DC, Palmer College of Chiropractic

MEYER, SCOTT, Fellow in Industrial Technology, Assistant Program Chair, Valparaiso

MOEL, APRIL, Instructor in Industrial Technology, Assistant Program Chair; East Chicago; AAS, Ivy Tech Community College

MOORE, SANDRA, Associate Professor in Business Administration, Valparaiso; BA, Calumet College of St. Joseph; MA, Purdue University

MULLINS, LANNETTE G., Assistant Professor in Humanities, History, Art History, Political Science; Chair of Humanities, Valparaiso Campus; BA, Valparaiso University, MALS, Valparaiso University.

MURRELL, JIMMIE L., Associate Professor in Automotive Technology, East Chicago; BA, Chicago State University; Certified - The National Institute of Automotive Service Excellence

NEWCOMB, SHARON, Instructor in Nursing, Valparaiso; BSN, Valparaiso University

NICHOLSON, DOROTHY, Instructor in Surgical Technology; AAS, Ivy Tech Community College

NICKLA, MICHELLE, Assistant Professor in Accounting, Gary; MBA, Indiana University

NIEMAN, AMY, Instructor in Human Services, Assistant Program Chair, East Chicago; BLS Purdue University; MSW, Indiana University

OBJAJULUWA, VICTOR A., Professor in Physical Therapist Assistant, Gary; BA, MED, PhD, University of Ibadan

O'DROBINAK, REGINA, Assistant Professor in Nursing, Gary; MSN, Indiana University

OLSON, KATHY G., Associate Professor in Computer Information Systems, Computer Information Technology, Valparaiso; BA, Tri-State College, MS Educational Computing, Purdue University

OSBORNE, MICHAEL, Instructor in Public Safety and Fire Science, Program Chair, Gary; BA, Southern Illinois University, AAS, Ivy Tech Community College

PAVLAKOVIC, VIKI, Instructor in Medical Assisting, Program Chair, Michigan City; AAS, Ivy Tech Community College, BS, Calumet College of St. Joseph; Certified Medical Assistant

PEREZ, NORMA, Instructor in Practical Nursing, Valparaiso; BS, Indiana Wesleyan University

PERRY, SUZAN, Assistant Professor in Design Technology, Program Chair, Valparaiso

PETRESKA, VALENTINA, Instructor in Advanced Manufacturing, Program Chair, Valparaiso;

PLANK, LORA Y., Assistant Professor in Surgical Technology, Dean School of Health Sciences, Valparaiso; AAS, Purdue University; BS, Indiana University

PRIMUM, SALLY, Instructor in Human Services, Program Chair, Valparaiso; BS, Ramapo College of New Jersey; MSW, Indiana University

RIDDELL, DARRELL, Assistant Professor, Assistant Program Chair, Computer Information Technology, Computer Information Systems, Gary; BS, Indiana State University, MBAS, Keller Graduate School of Business

RIDDLE, JARED M., Associate Professor in English & Communications, Regional Chair of English & Communications and Assistant Program Chair of Academic Skills Advancement, East Chicago; BA, Indiana University, MA Purdue University

RIECKEN, NANCY, Instructor in English, Assistant Program Chair Gary; BA, University of Wisconsin, MA, Purdue University

ROSILLO, LAURA, Associate Professor in Science, Regional Program Chair of Science, East Chicago; BA, Indiana University; MD, IU School of Medicine, Indianapolis

RUE, GINA M., Dean, School of Business, Associate Professor in Computer Information Systems, Regional Program Chair, Computer Information Systems, Computer Information Technology, Valparaiso; AAS, Ivy Tech State College; BS, Calumet College of St. Joseph, MS, Purdue University

SAARY, ALLYSON, Instructor in Nursing, Valparaiso; BSN, Florida State University

SCHOENFELDER, JOHN H., Professor in Business Administration, Michigan City; AAS, Moraine Valley College; BA, MA, Governors State University

SCOTT, SHARON T., Instructor in Medical Assisting, Michigan City; Certified Laboratory Assistant (ASCP), Indiana University

SIEWERT, JOHN A., Assistant Professor in Automotive Technology, East Chicago; Dupont Certified

SIKOSKI, ACO, Professor in Design Technology, Professor in Pre-Engineering; Dean - Technology; Dean - School of Applied Science and Engineering; BS, "Kiril i Metodij" Skopje Macedonia; MS, Purdue University

SMITH-ESTES, GAIL, Professor in Nursing, Program Chair, Gary; BS, MS, Purdue University

SORIA, RICHARD, Assistant Professor in Mortuary Science, Dean - Public & Social Services; Diploma, Worsham College of Mortuary Science; BS, Calumet College of St. Joseph; JD, Valparaiso University School of Law

STALEVSKA, LJILJANA, Associate Professor in Mathematics, Regional Chair LA Mathematics, Valparaiso; BSEE, University "Kiril and Metodij"; Macedonia; MS, Purdue University

STIPP-EVANS, DEBORAH L.; Associate Professor of Psychology, Regional Program Chair of Social Sciences; Gary Campus, BA Purdue University; MAABS Valparaiso University

TANASKOSKI, VESNA, Liberal Arts and English, ASA Co-Chair and English Instructor, Michigan City; BA, MA, Purdue University

WHEELER-ANDREWS, SHARI L., Assistant Professor in Early Childhood Education, Gary; BS, Theater, minors in Psychology and Radio TV Film, MS, Family and Consumer Sciences, Child Development and Family Life specialization, Indiana State University
WILLIAMS, GOMER, Assistant Professor in Industrial Technology, Program Chair, Valparaiso; AAS, Ivy Tech State College; BS California Coast University
WILSON, FRENCEY, Instructor in Practical Nursing, Gary; AS, BS, Indiana University
WORDEN_MCGUINESS, MARY, Assistant Professor of Psychology, Assistant Program Chair, Social Sciences; East Chicago Campus; BASW, Ball State University, PsyD, Chicago School of Professional Psychology.
ZYCH, TERRENCE, Instructor in Hospitality, Regional Program Chair, Michigan City; AS, Ivy Tech Community College

NORTH CENTRAL REGION

CALVIN, VIRGINIA, Chancellor; BS, Alcorn State University; MA, New Mexico Highlands University; EdD, Texas Woman's University
SHAFFER, TERESA, Vice Chancellor/Dean, Elkhart; BS, Indiana University; MEd, Kent State University
MAXSON, RANDY, Vice Chancellor/Dean, Warsaw; BS, Grace College; MEd, Millersville University
PHILIP, CHUCK, Vice Chancellor of Academic Affairs; EdD, Vanderbilt University; MS, George Peabody College; BS, California State University
BRANHAM, KEITH, Vice Chancellor of Student Affairs; EdD, University of Central Florida, MDiv, Nazarene Theological Seminary, BS, Mid-America Nazarene University

FACULTY

ADAMCZYK, RICHARD, Assistant Professor in Manufacturing & Industrial Technology, Program Chair, South Bend; BS, University of Krakow; Technical Mechanic and Teacher Degree, Pedagogical Technical School, Kielce (Poland)
ANDRZEJEVICH, MILAN, Associate Professor in Liberal Arts, South Bend; BA, Indiana University; MA, University of Chicago
BELL, ANDREW, Instructor in Visual Communications, South Bend; BGS, Ball State University
BOEMBEKE, ANGELA, Associate Professor in Visual Communications, Program Chair, South Bend; BA, Anderson University; MBA, Indiana Wesleyan University
BRINKRUFF, DAVID, Associate Professor in Electronics & Computer Technology, Dean, School of Technology, South Bend; BS, Purdue University, MS, Purdue University
BRITT, IRENE, Assistant Professor in Criminal Justice, Program Chair, South Bend; AS, Ivy Tech Community College; BS, Martin University; MPA, Indiana University
BROWN, NANCY, Assistant Professor in Business Administration, Warsaw; BA, Purdue University; MBA, St. Francis College
BURTCH, GALE R., Assistant Professor in Academic Skills Advancement, Elkhart; BA, Indiana University-Bloomington; MS, Indiana University-South Bend
BUTLER, CARRIE, Instructor in Computer Information Systems, Elkhart; BS, University of Tennessee/Argosy University, MBA, Argosy University
CAMPBELL, MELDODY, Associate Professor in Associate Degree Nursing; BSN, Bethel College; MSN, Ball State University
COMEAU, JOHN, Professor in Liberal Arts, South Bend; BA, University of Notre Dame; MS, Indiana University
CORY, KATRINA, Instructor in Nursing, Elkhart; ADN, Indiana University-Purdue University; BSN, Indiana

Wesleyan University; MSN, Ball State University
COTY, MARY, Assistant Professor in Nursing, South Bend; BSN, Ball State University; MSN, Valparaiso University
CURRY, DEBORAH, Assistant Professor in Nursing, South Bend; BSN, Pittsburg State University; MSN, Ball State University
DENBY, CATHY, Assistant Professor in Liberal Arts, South Bend; BA, St. Mary's College; MA, University of Notre Dame
DOLPH, JOSEPH, Assistant Professor in Technology, Elkhart; BS, University of Notre Dame
EGGLESTON, MARGARET, Assistant Professor in Visual Communications, South Bend; BS, Indiana University, Bloomington
ELLINGHOUSE, COLETTE, Assistant Professor in Liberal Arts, Warsaw; BA, Goshen College; MA, Ball State University
FIORELLA-TEVES, SHARON, Instructor in Nursing, South Bend; BSN, Marycrest College; MS, University of Louisville
FREYGANG, JIM, Assistant Professor in Design Technology, Program Chair, South Bend; AAS, Ivy Tech State College; BFA, St. Francis College
GERBASICH, KAREN, Associate Professor in Nursing, South Bend; BSN, St. Mary's College; MSN, Ball State University
GERDES, EDITH, Associate Professor in Nursing, South Bend; ADN, Purdue University; BHCA, St. Joseph's College; MSN, Ball State University
GICK, DESMOND, Associate Professor in Computer Information Systems, South Bend; BS, Purdue University
GRAY, DAVID, Associate Professor in Math and Sciences, Program Chair, South Bend; AB, Indiana University; MD, Indiana University
GRUBER, ELLEN, Associate Professor in Academic Skills Advancement, South Bend; BS, Eastern Illinois University; MS, Northern Illinois University
GUTHRIE, LOUISE, Assistant Professor in Business, Elkhart; BS, Indiana University; MBA, University of Nebraska
HACKEMANN, SANDRA, Assistant Professor in Liberal Arts, Elkhart; BA, Millsaps College; MA, George Peabody College
HALL, CHARLES, Assistant Professor in Math and Sciences, South Bend; BS, MS, PhD, University of Notre Dame
HAMMONDS, BONNIE, Instructor in Nursing, South Bend; BSN, Indiana University
HARPER, NORA, Instructor in Nursing, South Bend; LPN, Utah Technical College; ADN, Weber State College; BSN, Weber State College
HAWKINS, VIOLET, Instructor in Paralegal, Dean, School of Public and Social Services, South Bend; BA, Howard University; JD, Howard University
HEETER, CAROL, Assistant Professor in Business Administration, Elkhart; BS, MBA, Indiana University
HELLYER, TIM, Instructor in Paramedic, Program Chair, South Bend; BA, National-Lewis University; MA, Aurora University
HIERS, JUDY, Associate Professor in Office Administration, Program Chair, South Bend; AAS, Delta College; BS, Western Michigan University; MS, Indiana State University
HOCHSCHILD, ROBERT, Assistant Instructor in Accounting, Program Chair, South Bend; AAS, Ivy Tech Community College; BS, Bethel College; MS, Indiana University South Bend
HORNER, MARY ANN, Instructor in Nursing, South Bend; BSW, St. Mary of the Woods College; BSN, Bethel College

HOUCK, SHARON, Assistant Instructor in Academic Skills Advancement, South Bend; BA, Bethel College; BA, Indiana University at South Bend

HUDERWITZ, PATRICIA, Instructor in Nursing, South Bend; BSN and MSN, Seton Hall University

HUETTL, ROBERT, Assistant Professor in Automotive Technology, Program Chair, South Bend; AS, University of Wisconsin-Barron County Campus; BS, University of Wisconsin-Stout

JOJD, JAMILLE, Assistant Instructor in Math and Sciences, South Bend; BA, Indiana University South Bend; MS, University of Notre Dame; Doctor of Optometry, Indiana University

JOHNS, TERRY, Assistant Professor in Math and Sciences, Elkhart; BS, MA, Indiana University

KENT, KATHERINE, Professor in Interior Design, Dean, School of Fine Arts & Design, South Bend; BS, Andrews University; MA, Western Michigan University

KEUSCH, DONNA, Assistant Professor in Nursing, Assistant Program Chair, South Bend; Diploma, Memorial Hospital School of Nursing; BSN, Indiana University; MSN, Valparaiso University

KING, CHERYL, Assistant Professor in Environmental Design, Program Chair, South Bend; BS, Western Michigan University

KIRKNER, CAROL, Professor in Medical Laboratory Technician, Dean, School of Health Sciences, South Bend; BS, Kent State University; MS, University of Notre Dame; EDD, California Coast University

KOSANOVICH, RENEE, Assistant Professor in Dental Hygiene, South Bend; BS, Indiana University-Purdue University Ft. Wayne

LAGADDN, P. BEN, Assistant Professor in Manufacturing and Industrial Technology, Program Chair, South Bend; BA, Indiana University

LANKSTON, THOMAS, Assistant Professor in Academic Skills Advancement, South Bend; BS, Purdue University; MS, Michigan State University

LEDSOME, DANIEL, Assistant Professor in Math and Sciences, Program Chair, South Bend; BA, Muskingum College; MA, Miami University

LUTZ, MARK, Assistant Professor in Liberal Arts, South Bend; BA, University of Southern California; MA, University of Notre Dame

MACMILLAN, BARBARA, Assistant Professor, Dental Hygiene, Program Chair, South Bend; BS, Loyola University; MS, Columbia University

MARSH, ROBERT, Instructor in Industrial Technology, Warsaw; Journeyman - Machine Repairman, US Department of Labor

MEASELL, NANCY, Assistant Professor in Medical Assisting, South Bend; AAS, J. Sargent Reynolds Community College; BA, Winthrop College

NEGAHBAN, RAHIM, Associate Professor in Electronics and Computer Technology, Program Chair, South Bend; AS, J. C. Calhoun State Community College; BS, University of Alabama; MSEE, Tuskegee Institute

NICHOLSON, DEBRA, Instructor in Respiratory Care, Director of Clinical Education, South Bend; AS, California College for Health Sciences; BS, Indiana University

NESEULA, MICHAEL, Instructor in Computer Information Systems, Program Chair, South Bend; BA, Indiana University

OSIRO, MESHACK, Assistant Professor in Computer Information Systems, South Bend; BA, Bluffton College; MA, Ohio University

PARMLEY, CRAIG, Associate Professor in Liberal Arts, Program Chair, South Bend; BS, Indiana State University; MBA, Indiana Wesleyan

PAUL, DEBRA, Assistant Professor in Medical Assisting, Warsaw; TC, AAS, Ivy Tech State College; BA, Tri State University

PAVEL, CYNTHIA, Assistant Professor in Medical Assistant, Program Chair, South Bend; AAS, Davenport

University; BS, Central Washington University; BA, Eastern Washington University; MPA, Indiana University South Bend

PEARSON, SUSAN, Assistant Professor in Respiratory Care, Program Chair, South Bend; AS, Indiana University; BA, DePaul University; PA, Indiana University

PENROSE, DEBRA, Assistant Professor in Medical Assisting, Elkhart; BS, University of Texas Pan American

PHILLIPS, JOANNE, Instructor in Human Services, Program Chair, South Bend; AA, Lake Michigan College; BA, Siena Heights University; MS and MSW, Indiana University South Bend

PDWELL, JAMES, Professor in Math and Sciences, Dean, School of Liberal Arts and Sciences, South Bend; BS, Rose-Hulman Polytechnic Institute; PhD, Indiana University of Notre Dame

PRIMROSE, PAMELA, Associate Professor in Medical Laboratory Technician, Program Chair, South Bend; BS, Indiana University; MS, University of Maryland

RIVERA, MICHAEL, Assistant Professor in Computer Information Systems, Dean, School of Business, South Bend; BS, MBA, Taylor University; RDE, LDRI, Assistant Professor in Communication, Elkhart; BA, Morehead State University, MA, Morehead State University

RUFUKU, CHARLES, Assistant Professor in Math and Sciences, Elkhart; BA, College Du Saint Esprit; MD, Moscow Medical

SATTLER, LAURAN, Assistant Professor in Computer Information Systems, Warsaw; AAS, Ivy Tech State College; BS, Goshen College, MA, George Washington University

SHEAKS, CRAIG, Instructor in Visual Communications, South Bend; BFA, Indiana University

SMYERS, HARRY, Instructor in Automotive Services, South Bend; TC, Ivy Tech State College; BS, Indiana State University

SPRING, BRENT, Assistant Professor in Hospitality, Program Chair, South Bend; BA, Indiana University Bloomington

STRATTON, SANDRA, Assistant Professor in Paralegal, Program Chair, South Bend; BA, Albion College; JD and MBA, Washington University

SYERS, PHYLLIS, Assistant Professor in Nursing, Department Chair, South Bend; BSN, Prairie View A & M University; MSN, Texas Woman's University

TAYLOR, LINDA, Assistant Professor in Early Childhood Education/Education, Program Chair, South Bend; BS, Taylor University Fort Wayne; MS Andrews University

TIMM, MONTY, Instructor in Industrial Technology, Program Chair, South Bend; TC, Ivy Tech Community College

TORMA, JAN, Instructor in Nursing, South Bend; BSN, Ball State University

TWADDLE, GEORGE, Assistant Professor in Biotechnology, Program Chair, South Bend; BS, Purdue University; MS, Indiana University

VOLHEIM, LDRI, Assistant Professor in Communications, South Bend; BA, Indiana University South Bend; MA Ball State University

WALTZ-FREEL, KATHRYN, Professor in Academic Skills Advancement, Department Chair, South Bend; BA, Montana State University; MS, Indiana University

WOLFSON, COLETTE, Associate Professor in Business Administration, Program Chair, South Bend; BS, Indiana University; MS, Indiana University

WYMAN, PATSY, Assistant Professor in Hospitality, South Bend; BS, University of Michigan; MA, University of North Carolina

YOUNG, RDGER, Assistant Professor in Computer Information Systems, South Bend; BA, Columbia College; MS, Ferris State University

NORTHEAST REGION

KEEN, MARK A., Chancellor, Fort Wayne; AAS, BS, ITT Technical Institute, MS, Indiana Wesleyan University; PhD, Indiana State University
BAKER, RUSSELL D., Vice Chancellor of Academic Affairs, Fort Wayne; BA, Huntington University; MA, Kent State University; EdD, Ball State University
LEWTON, J. CHARLES, Vice Chancellor of Student Affairs, Fort Wayne; BS, Indiana State University; MS, Purdue University

FACULTY

BARLOW, CHRISTINE E., Assistant Professor in Liberal Arts & Sciences, Fort Wayne; BS, MS, Purdue University
BARNES, BRIAN, Assistant Instructor in Industrial Technology, Fort Wayne; CWE, CWI, American Welding Society
BARNETT-JOHNSON, KIM R., Assistant Professor, Dean, School of Liberal Arts & Sciences, Fort Wayne; BS, Taylor University; MLS, Indiana University
BERINGER, LISA, Instructor in Liberal Arts & Sciences, Program Chair, Fort Wayne, BA, St. Norbert College, MA, Penn State University
BICKNASE, BERNICE L., Assistant Professor in Therapeutic Massage, Program Chair, Fort Wayne; AAS, Ivy Tech State College; BS, Indiana Institute of Technology
BISHOP REBECCA, Instructor in Liberal Arts & Science, Department Chair, Fort Wayne, BA, Manchester College, MA, Indiana University
BISSELL, THERESA, Assistant Professor in Liberal Arts and Sciences, Department Chair, Fort Wayne; BA, DePauw University; MS, Purdue University
BONEFFE, ROSE L., Assistant Professor in Respiratory Care, Director of Clinical Education, Fort Wayne; RRT-NPS, AS, BS, Indiana University
BRADSHAW, MARY ANNA, Assistant Professor in Human Services, Fort Wayne; AB, Indiana University; MS, St. Francis College; EdD, Indiana Wesleyan University
BRINK, JENNIFER K., Assistant Professor in Respiratory Care, Department Chair, Fort Wayne; RRT-NPS, AS, Butler University; BS, University of St. Francis
BUNTING, JEFF G., Assistant Instructor in Hospitality Administration, Program Chair, Fort Wayne; AAS, Ivy Tech Community College
CAROTHERS, REBECCA S., Assistant Professor in Early Childhood Education, Program Chair, Fort Wayne; BS, MAE, Ball State University
CHRISTMAN, JOHN, Assistant Instructor in Industrial Technology, Fort Wayne; TC, Indiana Vocational Technical College; CWE, CWI, American Welding Society
CIESLIK, CHRISTINA L., Instructor in Nursing, Fort Wayne; ASH, Lansing Community College; BSN, Michigan State University
DANTZGER, BRANDY, Assistant Instructor in Nursing, Fort Wayne; BSN, MSN, Indiana Wesleyan University
DILLER, JEWEL K., Professor in Nursing, Fort Wayne; RN, BS, Fort Wayne Bible College; MEd, Indiana University; MSN, Concordia University
DITTON, DONNA S., Assistant Professor in Liberal Arts, Fort Wayne; BA, Purdue University; MA, Ball State University
DUNLAVY, SHERI A., Assistant Professor in Liberal Arts and Sciences, Fort Wayne; AAS, BA, Purdue University; MSED, Indiana University

FAGAS, DEBORAH L., Assistant Professor in Academic Skills Advancement; BA, Indiana University; MA, Ball State University
FALK, JOHN E., Assistant Professor in Construction Technology, Department Chair, Fort Wayne; Licensed Journeyman Plumber; Licensed Plumbing Contractor; BAM, Tri State University
FIELDHOUSE, NANCY J., Assistant Professor in Nursing, Fort Wayne; RN, BSN, Goshen College; MSN, Purdue University
GRANNAN, JOHN A., Instructor in Criminal Justice, Program Chair, Fort Wayne; AB, Indiana University; MS, Indiana Wesleyan University
GRIESER, GAIL, Instructor in Liberal Arts & Sciences, Fort Wayne, BA, Ithaca College, MEd, Indiana University-Purdue University, Fort Wayne
HAGEN-SHORT, MICHELLE L., Assistant Professor in Office Administration, Fort Wayne; BS, Purdue University
HALL, DANIEL, Assistant Professor in Liberal Arts and Sciences, Fort Wayne; BS, Ball State University; MS, Indiana University
HART, SHERRI, Assistant Instructor in Nursing, Fort Wayne; ASN, Valencia Community College, BSN, Indiana Wesleyan University
HAZAIMEH, ABDALLA, Associate Professor of Liberal Arts and Sciences, Program Chair, Fort Wayne; BS, Yarmouk University; MS, Wichita State University; Ph.D., North Dakota State University
HEISE, JOAN M., Associate Professor in Computer Information Systems and Computer Information Technology, Department Chair, Fort Wayne; BS, MBA, Indiana Wesleyan University
HENRY, STEVEN L., Assistant Instructor in Aviation Technology, Fort Wayne; TC, Columbus Technical Institute
HESS, JOHN W., Associate Professor in Construction Technology, Fort Wayne; BA, Tri-State University
HESS, MICHAEL P., Instructor in Criminal Justice, Fort Wayne, BA, Indiana University-Purdue University - Fort Wayne, J.D. Indiana University School of Law, Indianapolis
HINES, MARIA, Assistant Instructor in Nursing, Fort Wayne; BSN, Fairfield University
HITZEMANN, CHERYL A., Assistant Instructor in Culinary Arts, Fort Wayne, Certified Executive Pastry Chef, American Culinary Federation
HUFFMAN, ROBERT, Assistant Instructor in Automotive Technology, Fort Wayne; ASA Certification
INGALLS, JAMES G., Assistant Professor in Academic Skills Advancement, Fort Wayne; BS, Austin Peay State University
JOHNSON, LAURIE, Instructor in Elementary Education, Program Chair, Fort Wayne; BS, Purdue University; MEd, University of Wisconsin LaCrosse
JONES, KAREN E., Assistant Professor in Liberal Arts and Sciences, Fort Wayne; BA, Indiana University; MS, Purdue University
KASHNER, CASEY, Instructor in Liberal Arts and Sciences, Fort Wayne, BS, Eastern Michigan University, MS, University of Cincinnati
KAUFFMAN, KENT D., Associate Professor in Paralegal Studies, Program Chair, Fort Wayne; BA, Temple University; JD, The Dickinson School of Law
KEATHLEY, MICHAEL W., Associate Professor in Liberal Arts and Sciences, Program Chair, Fort Wayne; BA, Michigan State University; MA, Wayne State University
KELDER, MICHAEL O., Assistant Professor in Automotive Technology, Fort Wayne; AAS, ITT Technical Institute; BA, Tri-State University
KELSEY, RALPH L., Assistant Professor in Automotive Technology, Department Chair, Fort Wayne; AAS, Purdue University; AAS, Purdue University; BS, Indiana State University
KELTY, ROBERT, Assistant Professor in Hospitality Administration, Dean, School of Public Services and School of Education, Fort Wayne; BA, St. Francis College; MS, Indiana University

KEMERER, PATRICIA, Assistant Professor in Liberal Arts and Sciences, Fort Wayne; BA, Youngstown State University; MS, University of Saint Francis

KHOULI, VICKI L., Assistant Professor in Nursing, Program Chair, Fort Wayne; RN-C; BSN, MA, Ball State University

KNEUBUHLER, DENISE, Assistant Professor in Nursing, Fort Wayne; RN, BSN, MSN, FNP, Indiana Wesleyan University

KNIGHT, JOHN H., Assistant Professor in Computer Information Systems, Fort Wayne; AAS, Ivy Tech State College; BS, Ball State University

KNOX, DEEANN K., Assistant Professor in Medical Assisting, Fort Wayne; RN, BSN, Ball State University

KUMFER, CYNTHIA J., Assistant Professor in Early Childhood Education, Fort Wayne; BA, MS, Indiana University

LANGE, M. PAMELA, Assistant Instructor in Nursing, Fort Wayne; BSN, College of St. Teresa; NNP, University of Colorado

LEIGH, RONALD W., Associate Professor in Design Technology, Fort Wayne; AB, MA, Wheaton College; PhD, New York University

LENGERICH, DONALD D., Associate Professor in Accounting, Fort Wayne; BS, Indiana University; MSE, MBA, St. Francis College, CPA

LONG, JOSHUA, Assistant Professor in Liberal Arts and Sciences, Fort Wayne; BA, Wadhams Hall Seminary College; MA, Walsh College; PhD, Capella University

LYNCH, JOHN D., Assistant Professor in Accounting, Program Chair, Fort Wayne; BS, Purdue University; MS, Indiana University

MANTOCK, CHARLENE M., Associate Professor in Health Aide, Program Chair, Fort Wayne; BSN, Olivet Nazarene University; MA, Ball State University

MASON, JOHN, Assistant Instructor in Industrial Technology, Fort Wayne; AAS, Kentucky College of Technology; AAS, Ivy Tech Community College

MCCORMICK, PATRICK, Associate Professor Business Administration, Fort Wayne; AAS, Indiana University Purdue University Fort Wayne; BS, Purdue University; MBA, Indiana Tech

MEYER, BRENDA, Assistant Professor in Nursing, Fort Wayne; BSN, Indiana University Purdue University Fort Wayne; MSN, Indiana University Purdue University Indianapolis

MILLER, DODIE, Instructor in Liberal Arts and Sciences, Fort Wayne; BA, Indiana-Purdue University Fort Wayne; MFA, Minnesota State

MORGAN, PHIL, Assistant Instructor in Automotive Services, Fort Wayne; TC, Minnesota State University; TC, Ivy Tech Community College

MOSCHEL-FOSTER, ANGEL, Assistant Professor in Liberal Arts and Sciences, Fort Wayne; BA, MA, Purdue University

MOUGHLER, TONI, Assistant Instructor in Nursing, Fort Wayne, ASN, Lutheran College of Health Professions, BSN, Indiana Wesleyan University

MUSSON, MARY, Assistant Instructor in Early Childhood Education, Fort Wayne; BA, University of Denver; MA, Pacific Lutheran University; MS, Troy State University

MYERS, MARSHA, Instructor in Therapeutic Massage, Fort Wayne, AAS, Ivy Tech Community College, BS, Indiana State University

NAGEL, DIANE E., Assistant Professor in Academic Skills Advancement, Program Chair, Fort Wayne; BA, Saint Francis College

NEWMAN, LINDA, Instructor in Nursing, Fort Wayne; RN, BSN, Purdue University; MSN, Ball State University; FNP, Indiana Wesleyan University

PARRA, MICHELLE, Assistant Instructor in Nursing, Fort Wayne; ASN, BSN, Purdue University

PITZER, DEBORAH K., Instructor in Manufacturing Technology, Department Chair, Fort Wayne; BS, Purdue University; MBA, Indiana Wesleyan University

POWERS, JEAN E., Associate Professor in Business Administration, Fort Wayne; AAS, Ivy Tech State College; BS, Tri-State University; MS, University of Saint Francis

PRICE, DEANNA, Instructor, Academic Skills Advancement, Writing, Fort Wayne, BFA, Millikin University

PULLING, RICHARD, Instructor in Liberal Arts and Sciences, Fort Wayne; BA, Tufts University; MDiv, Chicago Theological Seminary; DMin, Bangor Theological Seminary

QUICKEL, CARLA, Instructor, Business Administration, Fort Wayne, BA, Millersville University, MBA, Benedictine University

REEVE, REBECCA, Associate Professor Liberal Arts and Sciences, Fort Wayne; BS, Ball State University; MA, Regent University

REILLY, KAREN L., Dean, Academic Skills Advancement, Fort Wayne; BA, MPA, Indiana University

RICHARD, SAJEH, Instructor in Academic Skills Advancement, Fort Wayne; BS, MBA, Indiana Institute of Technology

ROBERTS, KRISTIN, Assistant Professor in Academic Skills Advancement, Department Chair, Fort Wayne; BS, Indiana University

ROBINSON HINSEY, ANDREA, Assistant Professor in Office Administration; Department Chair, Fort Wayne: AAS, BS, Purdue University; MBA, Indiana Institute of Technology

ROMINES, LINDA, Associate Professor in Medical Assisting, Fort Wayne; AAS, CMA, RN, BSN, Purdue University; MSN, Concordia University

ROTHGEB, MARCIA, Assistant Professor in Nursing, Fort Wayne; RN, AAS, Purdue University; BA, College of Saint Francis; MSN, University of Saint Francis

ROYSE, BRIAN L., Assistant Professor in Liberal Arts and Sciences, Fort Wayne; BA, MA, Indiana University

RUYLE, REBECCA, Instructor in Health Aide, Fort Wayne; AS, Purdue University; BS, Baptist Bible College; MS, Indiana University Purdue University Fort Wayne; MSN, University of Saint Francis

RYBOLT, RUSSELL H., Assistant Professor in Paralegal, Fort Wayne; BA, Indiana University; JD, Valparaiso University

SCHLAEDENHAUFFEN, CANDACE S., Assistant Professor in Respiratory Care, Dean, Health Sciences, Fort Wayne; RRT-NPS, RPFT, BS, Indiana University; MS, Purdue University

SCHROEDER, BETTY, Assistant Instructor in Paramedic Science, AAS, BS, Indiana Business College

SHADY, MATT, Instructor in Paramedic Science, Program Chair, Fort Wayne; BA, Goshen College

SHEARER, JAMES C., Assistant Professor in Construction Technology, Fort Wayne; BA, Tri-State University

SHERMAN, DENNIS R., Assistant Professor in Industrial Technology, Fort Wayne; TC, GE, Tool & Die

SIMMONS, JEFFREY L., Assistant Professor in Academic Skills Advancement, Department Chair, Mathematics; Fort Wayne; BA, Taylor University; BS, Ball State University; MDiv, Anderson School of Theology

SLATER, JAMES M., Assistant Professor in General Education, Fort Wayne; BS, Purdue University; MS, Eastern Michigan University; DD, Kirkville College of Medicine and Surgery

SMITH, STEPHEN D., Assistant Instructor in Building Construction Management Technology, Program Chair, Fort Wayne; BA, Purdue University

SPRADLIN, CHRISTOPHER D., Assistant Professor in Academic Skills Advancement, Department Chair, Fort Wayne; BA, Cedarville University; MA, Concordia Theological Seminary

STEELE, LAURA, Assistant Professor in Liberal Arts and Sciences, Fort Wayne; BS, MS, Purdue University

STONEBRAKER, BEN A., Assistant Professor in Computer Information Systems, Fort Wayne; AAS, Indiana Vocational Technical College; BS, Purdue University

STROUP, DONALD L., Assistant Professor in Computer Information Systems, Fort Wayne; BS, Purdue University; MBA, Michigan State University

SUDDITH, ROBERTA, Assistant Professor in Health Aide, Fort Wayne; BA, St. Francis College; MS, Walden University

SULLEN, BARRY J., Assistant Professor in Computer Information Systems, Fort Wayne; AA, Anderson College; BS, Lander University; MEd, Capella University

TERHUNE, WILLIAM R., Instructor in Aviation Technology, Program Chair, Fort Wayne; AAS, Spartan School of Aeronautics; BS, Indiana Wesleyan University

THIERER, NINA L., Associate Professor in Medical Assisting, Fort Wayne; AAS, Indiana Vocational Technical College; BS, Indiana Institute of Technology, CMA

TOLBERT, JAMES, Instructor in Business Administration, Program Chair; BS, Central Bible College, MBA, Taylor University

TOWNSEND, ROBERT, Instructor in Design Technology, Program Chair, Fort Wayne; BS, Northeastern University

TREFF, CONRAD C., Assistant Professor in Manufacturing and Industrial Technology, Fort Wayne; BS, Fairleigh Dickinson University

TRUMBULL, HEIDI, Instructor, ASA Math, Fort Wayne, BS, Indiana University

TSAKOVA, MARIA, Assistant Professor in Academic Skills Advancement, Fort Wayne; BA, Saints Cyril and Methodius University; MLS, Indiana University

VARGA, ANDREW, Assistant Instructor in Industrial Technology, Fort Wayne; BS, Indiana Wesleyan University; MS, Capella University

VAZQUEZ, TERESA, Instructor in Liberal Arts and Sciences, Program Chair, Fort Wayne; BA, Oberlin College; MFA, The School of the Art Institute of Chicago

VICK, JAN S., Assistant Professor in Human Services, Program Chair, Fort Wayne; BS, Ball State University, MS, Saint Francis College

WALSH, JOHN D., Assistant Professor in Liberal Arts and Sciences, Fort Wayne; BS, University of Notre Dame; MS, Wesleyan University

WALTER, JOHN L., Associate Professor in Industrial Technology, Dean, Schools of Business, Technology and Applied Science and Engineering Technology, Fort Wayne; AAS, Indiana Vocational Technical College; BS, Indiana Wesleyan University; MA, Ball State University

WEISS, ANNA C., Assistant Professor in Accounting, Fort Wayne; BA, Middlebury University; MSED, Indiana University, CPA

WIEGAND-GREEN, TOVA, Assistant Professor in Medical Assisting, Department Chair, Fort Wayne; BS, Purdue University, CMA

WYNYKEN, MESHELE G., Assistant Professor in Hospitality Administration, Fort Wayne; RD, Saint Francis Medical Center; AA, Ivy Tech State College; BS, Illinois State University

LAFAYETTE REGION

BATHE, DAVID, Chancellor; AS, Vincennes University; BS, Greenville College; MS, PhD, Illinois State University

OSTRYE, MARY E., Vice Chancellor of Academic Affairs and Professor; BS, MS, West Virginia University; PhD, Indiana State University

ROSWARSKI, TODD E., Assistant Vice Chancellor of Academic Affairs and Assistant Professor; BA, MS, PhD, Purdue University

LAWS, JOHN, Vice Chancellor of Student Affairs, Lafayette; BS, MS, Southern Illinois University; EdD, Indiana University

FACULTY

ABEL, CINDY A., Assistant Professor in Medical Assisting, Lafayette; AAS, Ivy Tech State College; BS, Indiana Wesleyan University

ADDISON, PAUL, Associate Professor in Computer Information Systems, Computer Information Systems and Computer Information Technology Program Chair, Lafayette; BA, Indiana University; MS, Purdue University

ALEXANDER, STANLEY W., Associate Professor in Psychology, Lafayette; BA, Cornell University; MEd, Boston College; PhD, University of Michigan

BALACHANDER, MALATHIS, Associate Professor in Chemistry, Department Chair, Math and Sciences, Lafayette; BS, MS, PhD, University of Delhi, Delhi, India

BAUTE, AARON, Instructor in Business Administration, Program Chair, Lafayette; BS, Indiana Wesleyan University; MBA, Purdue University

BAWA, SATISH, Associate Professor in Business Administration, Lafayette; BA, Delhi University; M.BA, Xavier University

BERRY, DAVID C., Associate Professor in History, Dean, School of Liberal Arts and Sciences, Lafayette; BS, Mercer University; MA, Georgia State University

BLACK, AMY L., Assistant Professor in Academic Skills Advancement, Lafayette; BS, St. Joseph College; MA, University of Phoenix

BOLLINGER, CINDY A., Assistant Instructor in Medical Assisting, Lafayette; AAS, Ivy Tech Community College

BREWER, JOSHUA A., English Faculty Fellow, Lafayette; BA, Lipscomb University; MA, University of Miami, Coral Gables

BRODSKY, JANET J., Assistant Professor in Life Sciences, Program Chair, Lafayette; BA, Clark University; MS, Purdue University

BUNNING, ALAN R., Assistant Professor in Computer Information Technology, Lafayette; BS, Purdue University

BUTLER, KELLEY M., Instructor in Accounting, Lafayette; BS Oral Roberts University; MS Indiana University

COGHILL, WILLIAM M., Schools of Education and Public and Social Services, Dean and Assistant Professor, Lafayette; BA, MS, Purdue University

COMBS, JONATHAN D., Assistant Professor in Design Technology, Lafayette; BS, Purdue University

COOPER, REED J., Instructor in Automotive Technology, Lafayette; BS, Indiana Wesleyan University

CREE, CHAD V., Assistant Professor in Computer Information Technology, Lafayette; BS, MS, MA, Ball State University

DEADMAN, ROBERT, Assistant Professor in Business, Dean, Lafayette; AAS, BS, Purdue University; MSM-IT, Colorado Technical University

DELAPLANE, BRUCE L., Instructor in Elementary Education, Program Chair, Lafayette; BS, Ball State University; MS, Purdue University

DOLK, KAREN L., Professor in Nursing, Department Chair, Lafayette; BSN, University of Pittsburgh; MSN, Case Western Reserve University

DYE, DEBORAH K., Assistant Instructor in Nursing, Lafayette; AS, Ivy Tech State College; BSN, Indiana Wesleyan University

EATON, BRUCE, Assistant Instructor in Welding, Lafayette; AS, Ivy Tech Community College

ELY, SUSAN, Instructor in Advanced Manufacturing, Program Chair, Lafayette; BS, Rutgers University

ERKIN, ERIC L., Associate Professor in Automotive Technology, Program Chair, Lafayette; AAS, Montcalm Community College; BS, Ferris State University; MA, Northern Michigan University

FAUST, JUDITH I., Associate Professor in Nursing, Lafayette; BSN, MSN, Ball State University
 FREEMAN, NDAH D., Assistant Professor in Agriculture, Program Chair, Lafayette; BS, MS, University of Illinois
 GIORGINI, MASSIMILIANO, Spanish Faculty Fellow, Lafayette; BA, MA, Purdue University
 GORDON, JAMES A., Instructor in Business Administration, Program Chair, Lafayette; BS, Purdue University;
 MBA, Finance University of Houston
 GUERRETTAZ, SARAH E., Associate Professor in English, Lafayette; BS, Indiana State University; MEd, Bowling
 Green State University
 GUSTUS, LISA A., Assistant Instructor in Nursing, Lafayette; TC and AS, Ivy Tech Community College; BNS,
 Indiana Wesleyan University
 GUTHRIE, AMANDA J., Instructor in Surgical Technology, Lafayette; AAS, Ivy Tech State College; BA, Purdue
 University
 HAMMER, WENDY K., Assistant Professor in English, Lafayette; BA, University of Wisconsin; MA, Ball State
 University
 HEARN, DAVID H., Assistant Professor in Academic Skills Advancement, Lafayette; BS, MS, University of
 Delaware; PhD, Purdue University
 HERRON-JOHNSON, HEIDI L., Assistant Professor in Spanish, Program Chair, Lafayette; BA, Drew University;
 MA and PhD, Purdue University
 INGRAM, MIKE A., Assistant Instructor in HVAC, Program Chair, Lafayette; AAS, Ivy Tech Community College
 ISAACS, JACOB P., Associate Professor in Communication, Lafayette; BA, Wabash University; MA, Ball State
 University; MS, Indiana University
 JAMES, PEGGY S., Professor in Respiratory Care, Program Chair, Lafayette; AAS, Lansing Community College;
 BS, MBA, Indiana Wesleyan University
 JONES, ELIZABETH A., Associate Professor in Nursing, Lafayette; AAS, BSN, MS, Purdue University; MSN,
 Indiana University
 LINDBERG, AMANDA BARCHÉ, Assistant Professor in Early Childhood Education, Program Chair, Lafayette;
 BA, North Central College; MA, Eastern Illinois University
 LITTLE, STACEY E., Instructor in Business Administration, Lafayette; AS, Ivy Tech Community College; BA, St.
 Mary of the Woods; MA, Indiana University
 LOGAN, LYNDA S., Assistant Instructor in Practical Nursing, Lafayette; TC, AS Ivy Tech Community College; BS,
 Indiana Wesleyan University
 LUCAS, DONALD A., Assistant Professor in Design Technology, Program Chair, Lafayette; BS, MS, Purdue
 University
 MANIAN, VIYU V., Assistant Professor in Mathematics, Lafayette; BS, MS, University of Bombay; MS,
 University of Pittsburgh; MS, Columbia University
 MARION, WESLEY S., Instructor in Paralegal Studies, Program Chair, Lafayette; BA, Purdue University; JD,
 Indiana University
 MCCLANNEN, DOROTHY S., Professor in Surgical Technology, Program Chair, Lafayette; AAS, Purdue
 University; BSN, Graceland College; MSN, Purdue University
 MCDANEL, RODNEY A., Assistant Professor in Sociology, Program Chair, Lafayette; BS, Northern State
 University; MA, University of Houston; PhD, University of North Texas
 MERCIER, WILLIAM C., Assistant Professor in Mathematics, Program Chair, Lafayette; BA, University of
 Colorado; MS, University of Cincinnati
 MICON, JOYCE L., Assistant Professor in Human Services, Program Chair, Lafayette; BA, Doane College; MS,
 Case Western Reserve University
 MILLER, JOLENE K., Professor, Dean, School of Health Sciences, Lafayette; AS, University of Southern Indiana;

College of St. Francis; MEd, Purdue University
 MINK, JULIA A., Assistant Instructor in Nursing, Lafayette; AS, Ivy Tech Community College; BSN, Indiana
 Wesleyan University
 MISHLER, JOHN E., Instructor in Criminal Justice, Lafayette BS, Indiana State University
 MOORE, TERESA G., Associate Professor in English, Program Chair, Lafayette; BA, MA, Western Kentucky
 University
 MUELLER, KEN S., Associate Professor in History, Program Chair, Lafayette; BA, MA, Southern Illinois
 University; PhD, Saint Louis University
 MUGHMAW, KATHY D., Assistant Instructor in Nursing, Lafayette; ASN, BSN, Indiana University - Kokomo
 NAGLE, AMY M., Instructor in Nursing, Lafayette; BSN, MSN, Ball State University
 NEES, WICKI L., Professor in Nursing, Lafayette; AAS, Purdue University; BSN, Purdue University; MSN, Purdue
 University
 NIELSON, KAREN E., Assistant Professor in Criminal Justice, Program Chair, Lafayette; BA, Eastern Nazarene
 College; MS, JD, University of Connecticut
 PETERSON, SHELLEY S., Instructor of Health Information Technology, Lafayette; BS, Purdue University; BS,
 Indiana University
 PHILLIPS, GEORGE J., Instructor of Respiratory Care, Lafayette, AAS, Kalamazoo Valley Community College;
 BHS Medical University of South Carolina; MSA, Central Michigan University
 PLEASANTS, STACIA L., Instructor in Early Childhood Education, Lafayette; BA, MS, Purdue University
 PRATER, BARBARA G., Special Projects to the Office of the Chancellor, and Associate Professor in Chemistry,
 Lafayette; BA, University of Kansas; PhD, University of Texas at Austin
 PRIEST, ROGER D., Assistant Professor in Communication, Program Chair, Lafayette; BA, MA, Purdue
 University
 RAZEKOWSKI, MCKENZIE, JANICE, Instructor in Biotechnology, Program Chair, Lafayette; BS, Montana
 University, PhD, Purdue University
 RATCLIFF, JOY D., Instructor in Dental Assisting, Lafayette; TC, Ivy Tech Community College; BS, Indiana
 Wesleyan University
 RATCLIFFE, DON, Assistant Professor in Microbiology, Lafayette; BA, Greenville College; MS, PhD, Purdue
 University
 RAYMAN, JEANA M., Mathematics Faculty Fellow, Lafayette; BS, Purdue University
 RISK, KATHLEEN M., Instructor in Academic Skills Advancement, Program Chair, Lafayette; BA, MA, Purdue
 University
 ROBERSON, GLEN D., Associate Professor, Dean, Schools of Applied Science, Engineering and Technology,
 Lafayette; BS, MS, Purdue University
 ROBINSON, L. DIANN, Professor in Academic Skills Advancement, Department Chair, Program Chair,
 Lafayette; BA, MS, Purdue University
 SCHAUER, DOUGLAS J., Instructor in Chemical Technology, Program Chair, Lafayette; BS, Drexel University;
 PhD, University of Notre Dame
 SCHUSTER STAIR, DIANNA R., Professor in Office Administration, Program Chair, Lafayette; BS, MS, Purdue
 University
 SLAVEN, ISAAC, Instructor in Sustainable Energy, Program Chair, Lafayette; BS, MS, Purdue University
 SMOCK, WARREN W., Associate Professor in Accounting, Program Chair, Lafayette; BS, University of
 Indianapolis; MBA, Indiana Wesleyan University
 SNYDERS, SHARON M., Professor in Academic Skills Advancement, Program Chair, Lafayette; BS, Purdue
 University; MS, Indiana Wesleyan; PhD, Purdue University

TRANA, GREG, Instructor in Business Administration; BS, BC, University of Ottawa; MBA, University of Saskatchewan

TICEN, MELISSA K., Assistant Instructor in Dental Assisting, Program Chair, Lafayette; TC, Ivy Tech Community College

TREES, SUSAN A., Instructor in Academic Skills Advancement, Lafayette; BA, Butler University; MS, Indiana University

ULMER, MICHAEL, Instructor in Industrial Technology, Program Chair, Lafayette; AS, Vincennes University, BS Purdue University

UMBECK, J. RYAN, Instructor in Economics, Lafayette; BS, MS, Purdue University

URAZAEV, ALBERT K., Assistant Professor in Life Sciences, Lafayette; M.D., PhD, Sci.D. Kazan Medical Institute, Russia.

WEALING, JOAN, Assistant Professor in Computer Information Systems, Lafayette; BS, Taylor University; MSM-IT, Colorado Technical University

WENDALL, ROBERT K., Assistant Professor in Mathematics, Lafayette; BS, MS, Purdue University

WILLIAM, COLIN T., Associate Professor in Psychology, Program Chair, Lafayette; BA, Berry College; MA, PhD, Emory University

WOODY, ROBERT T., Associate Professor in Industrial Technology, Lafayette; AS, Vincennes University, BS, Indiana State University

WULF, REBECCA K., Instructor in Academic Skills Advancement, Lafayette; AS, Vincennes University; BS, MS, Purdue University

YETMAN, CHRISTINA, Assistant Instructor in Medical Assisting, Lafayette; AAS, Ivy Tech Community College

KOKOMO REGION

DAILY, STEPHEN J., Chancellor; BS, MS Indiana University-Kokomo

LEWIS, PAMELA J., Vice Chancellor of Academic Affairs; BS, Indiana University; MA, Ball State University; PhD, Indiana State University

GUTHRIE, PAM, Vice Chancellor of Student Affairs; BA, University of Massachusetts; MS, Purdue University

WILSON, JANE, Assistant Dean of Academic Affairs; BS, MA, Ball State University

THURMOND, BRADLEY H., Executive Director of Instructional Sites; BA, MS, Purdue University

HOCKNEY, DANIEL, Vice Chancellor, Logansport; BS, MA, Ball State University

FACULTY

ANDERSON, DONALD, Assistant Professor in Physics, Kokomo; BS, Wisconsin State College; BS, PhD, Purdue University

BETZNER, DAVID, Instructor in Public Safety Technology, Program Chair, Kokomo; BS, MA, Columbia Pacific University

BUNKER, KATHY, Instructor in Medical Assisting, Logansport; AAS, Harper College

BYRD, JULIE, Assistant Professor in Computer Information Systems, Program Chair, Logansport; BS, Indiana Wesleyan University; MS, Ball State University

CALDWELL, KIM, Assistant Professor in Mathematics, Kokomo; BS, Purdue University; MS, Indiana University

CARDEN, DORIS M., Instructor in Nursing, Kokomo; ASN, BSN, Indiana University

CHALFIN, JOHN, Assistant Professor in Paramedic Science, Program Chair, Kokomo; BS, Indiana University

DAHLHAUSER, JOYCE, Instructor in Mathematics, Wabash; BS, DeVry University

EHLER, KATHY M., Instructor in Nursing, Wabash; ASN, BSN, Indiana University

ELDRIDGE, GWENN A., Instructor in English, Kokomo; BA, Indiana University; MA, Butler University

ERNY, MICHAEL, Instructor in Automotive Technology, Program Chair, Kokomo; AAS, Ivy Tech Community College

FERRIES, KENNETH, Assistant Professor in Political Science, Program Chair, Kokomo; BA, JD, Indiana University

FITZGERALD, JAMES, Assistant Professor in Business Administration, Program Chair, Kokomo; BA, McKendree College; MA, Xavier University

GARDNER, RANDALL, Associate Professor in HVAC, Program Chair, Kokomo; AAS, Ivy Tech State College; AS, BS, Indiana State University; MSM, Ball State University

GHERING, THOMAS, Assistant Professor in English, Program Chair, Kokomo AS, San Diego Mesa College; BA, San Diego State University; MA, Purdue University

GORDON, DENNIS, Assistant Professor in Computer Information Technology, Program Chair, Kokomo; AS, Phillips Junior College; BS, Southern Illinois University; MS, Touro University International

GROVES, RHONDA K., Professor in Office Administration, Dean of the School of Technology and the School of Applied Science and Engineering, Kokomo; BS, MA, Ball State University

GROVES, STEVE, Assistant Professor in Accounting and Business Administration, Program Chair, Kokomo; BS, Indiana State University; MBA, Indiana Wesleyan University

HALL, JAY, Assistant Professor in Mathematics, Department Chair, Kokomo; BS, Rose Hulman Institute; MS, Indiana University

HARDIMON-EDDINGTON, JIA S., Instructor in Surgical Technology, Program Chair, Kokomo; AS, Ivy Tech Community College

HARDIN, FRANCES B., Instructor in Biology, Anatomy and Physiology, Kokomo; BA, Marian College; MA, Ball State University

HARRIS, PHYLLISS, Associate Professor in Office Administration, Program Chair, Kokomo; BS, Ball State University

HARTZOG, RICHARD, Instructor in Practical Nursing, Kokomo; BSN, Indiana Wesleyan University

HENRY, MARIAN, Instructor in Nursing, Logansport; BS, Indiana University

HILDENBRAND, JANE, Associate Professor in Early Childhood Education, Program Chair, Kokomo; AS, Vincennes University; BS, MS, Indiana State University

HOLSAPPLE, MICHAEL, Assistant Professor in Criminal Justice, Program Chair, Logansport; BA, Indiana University; MS, Indiana State University

HORNER, JANE, Assistant Professor in Early Childhood Education, Logansport; BS, Purdue University; MS, Indiana University

JOHNSON, CHRISTOPHER L., Assistant Professor in Criminal Justice, Kokomo; BS, Cedarville College; JD, University of San Diego

JORDAN, GRETCHEEN, Assistant Professor in Mathematics, Logansport; BS, MS, Purdue University

KING, KIM, Associate Professor in Communication, Dean of the School of Liberal Arts and Sciences and the School of Fine Arts and Design, Kokomo; BS, University of Indianapolis; MA, Ball State University

KOCH, JEAN, Professor in Computer Information Systems, Dean of the School of Business, Kokomo; AAS, Ivy Tech State College; BS, MS Ball State University

KOZIENSKI, RUTH, Assistant Professor in Human Services, Program Chair, Kokomo; BA, MS, Purdue University

KUNKLE, ALAN, Assistant Professor in Mathematics, Program Chair, Kokomo; BS, MS, Purdue University

LAUDERBAUGH, LINDA, Associate Professor in Nursing, Kokomo; BS, Indiana University; MSN, University of Southern Indiana

LEDBETTER, TAMERA L., Instructor in Nursing, Kokomo; BSN, Indiana University; MSN, Indiana Wesleyan University

LONG, LAURA, Instructor in Nursing, Logansport; BSN, Valparaiso University; MSN, University of Phoenix

MAPLE, CHERYL, Instructor in Nursing, Kokomo; BSM, Indiana University

MARCUM, HEATHER, Instructor in Nursing, Kokomo; BS, Indiana University
 MCCLAIN, NATHAN, Assistant Professor in Advanced Manufacturing, Program Chair, Kokomo; BS, Purdue University
 MCCAULEY, AMY, Assistant Professor in English, Kokomo; BA, Butler University; MA, Ball State University
 MCFARLAND, BARBARA, Assistant Professor in Office Administration, Logansport; BS, Ball State University; MS, Indiana Wesleyan University
 MCNALLY, DALENE S., Instructor in Nursing, Logansport; ASN, BSN, Indiana University
 MILLER, JERRY, Instructor in Education, Program Chair, Kokomo; BS, MS, Ball State University
 MOORMAN, THOMAS, Assistant Professor in Business Administration, Wabash; BA, Wabash College; MBA, University of Phoenix
 MORGAN, CONNIE, Professor in Medical Assisting, Dean of the School of Public and Social Services and the School of Education, Kokomo; BS, MEd, Indiana Wesleyan University
 MYERS, ROBERT, Instructor in Advanced Manufacturing, Kokomo; BS, General Motors Institute; MS, Purdue University
 PERKINS, JERRY, Assistant Professor in Computer Information Technology, Wabash; BS, Indiana University; MS, Webster University; MBA Troy State University
 PETERS, LAURIE F., Professor in Nursing, Dean of the School of Health Sciences, Kokomo; BSN, Indiana University-Kokomo; MSN, Ball State University
 PETERSON, DANIEL, Assistant Professor in Nursing, Kokomo; AS, BS, MSN, Indiana University
 PIERCE, TONYA, Assistant Professor in Computer Information Systems, Kokomo; BS, MS, Ball State University
 PRICE, LISA, Instructor in Nursing, Kokomo; BSN, Indiana University; MSN, Indiana University – Purdue University
 PRITCHETT, JOHN E., Assistant Professor in Construction Technology, Program Chair, Kokomo; AS, Lynn Technical College; BS, Indiana State University
 RIDDICK, KRISTY, Instructor in Dental Assisting, Program Chair, Kokomo; BA, Graceland University
 ROCKEY, JOSHUA, Assistant Professor in Communication, Program Chair, Kokomo; BA, MA, Ball State University
 SIEMENS, ELIZABETH, Assistant Professor in English, Logansport; BS, Indiana State University; MS, Purdue University
 SLUSHER, PATRICIA, Assistant Professor in Medical Assisting, Program Chair, Kokomo; BS, Indiana University
 SPENCE, GREGORY D., Instructor in Advanced Manufacturing, Logansport; AAS, Ivy Tech Community College; BA, Indiana University
 SROTZYR, EDITH, Instructor in Medical Assisting, Kokomo; AAS, Ivy Tech Community College
 STEELE, KENNETH, Assistant Professor in Business Administration, Logansport; Kokomo; BS, MBA, Fontbonne University
 THIBOS, RONALD, Assistant Professor in Industrial and Manufacturing Technology, Program Chair, Kokomo; BS, MS, Indiana State University
 VYAIN, SALLY, Assistant Professor in Psychology, Program Chair, Kokomo; BS, MA, Ball State University
 VANDEBURG, JENNIFER M., Instructor in Agriculture, Program Chair, Kokomo; BS, University of Illinois; MS, Purdue University
 WARD, DAN, Assistant Professor in Design Technology, Program Chair, Kokomo; BS, Purdue University
 WARD, LUKE, Assistant Professor in Visual Communications, Kokomo; BS, Purdue University
 WILEY, KYLE, Assistant Professor in Visual Communications, Program Chair, Kokomo; BS, Purdue University
 WILSON, MARIANNE, Instructor in Paralegal Studies, Program Chair, Kokomo; BA, University of Rochester; JD, Indiana University
 WILLIAMS, KELLY, Associate Professor in Nursing, Department Chair, Kokomo; MSN, Indiana Wesleyan University

EAST CENTRAL REGION

CHESTERFIELD, GAIL, Chancellor; BS, Indiana University, MA, Ball State University, ABD, Indiana University
 LIGHTLE, JOHN, Vice Chancellor/Dean, Marion; BS, MA, EdD, Ball State University
 SLOAN, RONALD, Vice Chancellor of Academic Affairs; DMA, University of Arizona
 STOOFS, SHARON, Associate Dean of Academic Affairs, Muncie; BS, MAE, Ball State University, ABD, Indiana State University
 LEWELLEN, MARY, Vice Chancellor of Student Affairs, Muncie; BS, MA, Ball State University University
 WILLEY, JAMES, Vice Chancellor/Dean; BS, Marian College; MEA, EdS, EdD, Ball State University

FACULTY

ADAMS, SHARON, Instructor in Nursing, Muncie; ASN, Floyd College; BSN Indiana Wesleyan University
 ANTHONY, NEIL, Associate Professor in Liberal Arts and Sciences, Dean of Liberal Arts and Sciences; BS, MA, Ball State University
 AVERETTE, DARLISHA, Assistant Professor in Respiratory Care, Program Chair, New Castle, MBA Anderson University
 BISHOP, DANNA, Associate Professor in Office Administration, Program Chair, Marion; BS, Indiana State University; MAE, Indiana Wesleyan University
 BRICE, JON, Assistant Professor in Liberal Arts and Sciences, Assistant Chair for Mathematics and Physical Sciences, Marion
 BROOKBANK, KATHLEEN, Instructor in Nursing, New Castle; BSN, MSN, Ball State University
 CAIN, ROBERT, Instructor in Surgical Technology, Program Chair, Muncie; AAS, Ivy Tech Community College; BA, Indiana University
 CONWELL, TAMRE, Assistant Professor in Early Childhood Education, Muncie; BA, MA, Ball State University
 CULP, SID, Assistant Professor in Design Technology, Anderson/Marion; BS, Ball State University
 DANA, KRISTEN, Assistant Professor in Academic Skills, English, Muncie; BS, MA, Ball State University
 DIETZEN, KARRIE, Assistant Professor in Nursing, Muncie; AD, Anderson University; BS, Indiana Wesleyan University; MSN, University of Phoenix
 DILLMAN, DEBRA, Assistant Professor in Radiologic Technology, Program Chair, Marion; BS, Indiana Wesleyan University; MS, Midwestern State University
 EVERETT, ARNOLD, Assistant Professor in Academic Skills, Academic Skills Mathematics Chair, Marion; BS, MAE, Ball State University
 FRY, J. OWEN, Assistant Professor in Academic Skills, Dean of the Department of Academic Skills, Muncie; BS, MAE, Ball State University
 GILBERT, LARRY, Associate Professor in Liberal Arts and Sciences, Assistant Chair for English, Communication and Languages, Anderson; AB, Anderson University; MA, Ball State University
 GOODMAN, STEPHANIE, Assistant Professor in Medical Assisting, Program Chair, Marion; BS, Ball State University; MSN, CMA (AAMA)
 GOSSERT, KRIS, Assistant Professor in Business Administration, Muncie; BS, Otterbein College; MBA, Morehead State University
 GOULD, SUZANNE, Associate Professor in Liberal Arts and Sciences; Chair for Biological and Chemical Sciences, Anderson; BFA, University of Illinois-Urbana; MAMS, University of Chicago-Illinois
 GOURLEY, DEBBIE, Assistant Professor in Hospitality Administration, Program Chair, Muncie; BS, MA, Ball State University

GRAY, ROBERT, Instructor in Academic Skills/Mathematics, Anderson; BS, MAE, Ball State University
GREENAN, MARY, Associate Professor in Academic Skills, Anderson; BS, University of Maine; MS, Butler University
GRIFFIN, OBRIN, Assistant Professor in Electronics, Program Chair, Anderson; BS, University of Sierra Leone; MSEE, University of Evansville
GROGG, ELKE, Assistant Professor in the School of Liberal Arts and Sciences; Co-Chair for Social Sciences/Humanities, Muncie; BS, MA, Ball State University
GROSE, LESA, Nursing Instructor, Muncie, BSN, Indiana Wesleyan University.
HANSON, GREG, Assistant Professor in Computer Information Systems/Technology, Anderson; AAS, Ivy Tech State College; BS, Free Will Baptist College; MS, Ball State University
HARDMAN, TERESA, Assistant Professor in Nursing, Muncie; BSN, MSN, Ball State University
HAWES, MAUREEN, Instructor in Nursing, Anderson; BSN, Ball State University
HAYES, DAVID, Assistant Professor in Computer Information Systems/Technology, Program Chair, Muncie; BS, MS, Ball State University
HELLER, MONICA, Assistant Professor in Liberal Arts and Sciences, Assistant Chair for Social Sciences/Humanities, Marion.
HICKS, MICHELLE, Assistant Professor in Nursing, Muncie; BSN, MSN, Ball State University
HIDAY, MARY, Associate Professor in Nursing, Program Chair, Muncie; AD, Anderson College; BSN, Anderson University; MA, Ball State University
HOBBS, LORI, Assistant Professor in Physical Therapist Assistant, Academic Coordinator of Clinical Education, Muncie; AS, Oklahoma City Community College; BS, Indiana University; MA, Ball State University
HODFFMAN, NANCY J., Professor in Early Childhood Education, Program Chair, Muncie; BS, Penn State University; MA, Ed.D, Ball State University; PhD, Ball State University
HORRELL, LATISHIA, Assistant Professor in Liberal Arts and Sciences, Assistant Chair for Social Sciences/Humanities and Physical Sciences, Anderson; BA, Anderson University; MS, Ball State University
HOUSHOLDER, DONALD, Assistant Professor in Liberal Arts and Sciences, Chair for Mathematics and Physical Sciences, Anderson; BA, Anderson University; MA, Ball State University
HUDSON, JOYCE, Assistant Professor, Dental Hygiene Program Chair, RDH, Medical University of South Carolina, MS, University of Missouri-Kansas City
HUFF, NEIL, Instructor in Public Safety, Program Chair, Muncie; AS, Indiana University; BSA, Purdue University; MPA, Indiana University
HUNT, JILL, Instructor in Nursing, New Castle; BSN, Indiana University Northwest
HYATT, ANDREA, Assistant Professor in Academic Skills, Marion; BS, MA, Ball State University
JEFFS, JOHN ROBERT, Associate Professor in Academic Skills, Muncie; BA, Olivet Nazarene University; MA, Ball State University; PhD, Indiana State University.
JOHNSON, ROSE, Assistant Professor in Nursing, Program Chair, Marion; BS, Indiana Wesleyan; MS, Ball State University
JOHNSON, TONIA, Assistant Professor in Nursing, Anderson; ASN, BSN, Indiana University East
JONES, PATRICK, Professor in Manufacturing and Industrial Technology, Program Chair, Muncie; AAS, Ivy Tech State College; BS, Taylor University; MS, Ball State University; PhD, Cappel University
KELLER, TERESA G., Associate Professor in Office Administration, Anderson; BS, MAE, Ball State University
KERR, MARILYN K., Associate Professor in Business Administration, Program Chair, Anderson; BS, MBA, Ball State University
KLEEBERG, MICHAEL, Assistant Professor in Liberal Arts and Sciences, Assistant Chair for English, Communications and Languages, Muncie; BA, Kean College of New Jersey; MA, Ball State University
LANG, KAREN, Associate Professor in Liberal Arts and Sciences, Co-Chair for Social Sciences/Humanities,

Muncie; BA, JD, University of Cincinnati; M.D, Garrett-Evangelical Theological Seminary
MACAULEY, TERESA, Assistant Professor in Dental Assisting, Program Chair, Anderson; CDA, BS, Indiana University; EFD; MS, Indiana University
MASTERS, AMY, Nursing Instructor, Muncie, BSN, Ball State University
MAYS, MARK, Assistant Professor in Academic Skills, Muncie; BA, Ball State University
MCDANIEL, KATHLEEN, Assistant Professor in Medical Assisting, Anderson; BA, Loyola University; MA, Ball State University; CMA (AAMA), AHIMA
MELHAM, LYNNEA, Instructor in Medical Assisting, Muncie; AS, BS, MS, Ball State University; CD, RD
MDORE, MICHELLE, Assistant Professor in Liberal Arts and Sciences, Assistant Chair for Biological and Chemical Sciences, Anderson; BS, MS, Indiana University
MODRHEAD, PHIL, Associate Professor in Computer Information Systems/Technology, Marion; BS, Bowling Green University; MS, University of Dayton
MUNSELL, SUSANNA, Instructor in Medical Assisting, Marion; BA, Indiana Wesleyan University; MT (ASCP)
NELSON, SUSAN, Assistant Professor in Nursing, Department Chair, Anderson; BSN, Anderson University; MSN, Ball State University
DUTLAND, DAN K., Assistant Professor in Business Administration, Marion; BBA, Memphis State University; MBA, Ball State University
PRUITT, LINDA, Associate Professor in Medical Assisting, Program Chair, Muncie; BS, MBA, Indiana Wesleyan University; CMA (AAMA)
REEDER, EMILY, Assistant Professor in Human Services, Program Chair, Muncie; BA, Anderson University; MSW, Indiana University
REEST, LORRAINE, Assistant Professor in Liberal Arts and Sciences, Biological and Chemical Sciences, Muncie; BS, MA, Ball State University
RICHARDS, DIANE, Assistant Professor in Nursing, Marion, BSN, Indiana Wesleyan University, MSN, Ball State University
RICHWINE, LISA, Assistant Professor in Nursing, Program Chair, New Castle; BSN, MSN, NP, Ball State University, CLNC, Vikki Milazzo Institute
ROBBINS, MARK, Instructor in Liberal Arts and Sciences, Assistant Chair for Biological and Chemical Sciences, Marion; BS, MA, Ball State University
ROBERTS, BARBARA, Assistant Professor in Medical Assisting, Muncie; BA, Anderson University; MS, St. Francis College; CMA (AAMA)
ROSALES, KAREN, Assistant Professor in Early Childhood Education, Anderson/Marion; BS, University of North Texas; ME, Texas Tech University
SANDERS, SUSAN, Associate Professor in Nursing, Anderson, RN, MSN, Ball State University.
SAXON, HERBERT, Instructor in Liberal Arts and Sciences, Assistant Chair for Biological and Chemical Sciences, Anderson; BS, MS, EdD, Ball State University
SCHULZ, NEILSEN, Associate Professor in Medical Assisting, Program Chair, Anderson; BS, MA, Ball State University; CMA (AAMA), RRT
SCOTT, JEFFREY, Assistant Professor in Public and Social Services, Acting Chair of the School of Public and Social Services and School of Education, Muncie; BS, Ball State University; MSW, Indiana University
SEXTON, STEVE, Assistant Professor in Automotive Technology, Program Chair, Muncie; BS, Indiana University
SHEPHERD, TAMARA, Assistant Professor in Radiologic Technology, Marion; AAS, BS, Ball State University; MS, Midwestern State University
SHONK, CORA, Assistant Professor in Nursing, Muncie; BSN, MSN, Indiana Wesleyan, MA, Ball State University

SKINNER, SUZANNE, Instructor in Human Services, Anderson/Marion; BSW, MS, Ball State University
SMEDINGHOFF, JOHN, Assistant Professor in Academic Skills, Mathematics, Muncie; BEE, University of Dayton; MS, Illinois Institute of Technology, Armour College of Engineering
SMITH, SEAN C., Assistant Professor in Liberal Arts and Sciences, Chair for English, Communications and Languages, Muncie; BA, MA, Ball State University
STRYFFELER, RYAN, Instructor in Liberal Arts and Sciences, Assistant Chair for English, Communications and Languages, English, Marion; BA, Hillsdale College; MA, Northern Arizona University
SYVERSON, JULIA, Associate Professor in Nursing, Program Chair, Anderson; AD, Anderson University; BSN Indiana Wesleyan University; MSN, University of Phoenix
SZAKALY, MICHAEL, Associate Professor in School of Business, Chair, Muncie; BS, MA, EdD, Ball State University
THORNBURG, NANCY, Instructor in Surgical Technology, Muncie; Diploma, BMH School of Surgical Technology; AAS, Ivy Tech State College
VEMESKEY, KEVIN, Instructor in Accounting, Program Chair, Muncie; BA, Anderson University; MPA, Indiana University
VESPERRY, PAUL, Assistant Professor in Manufacturing Technology, Program Chair, Muncie; AA, Clark State University; BS, Ohio State University; MAE, Ball State University
WECHSLER, LEA ANNA, Instructor in Nursing, Muncie; ASN, Palm Beach Community College, BSN, MSN, Indiana Wesleyan University
WEDGEWORTH, MICHAEL, Assistant Professor in Liberal Arts and Sciences, Assistant Chair for Mathematics and Physical Sciences, Muncie; BS, MA, Ball State University
WILLY, BONNIE, Assistant Professor in Computer Information Systems/Technology, Muncie; BS, MAE, Ball State University, Master of Science in Education, Northern Illinois University
WILKERSON, JOYCE, Associate Professor in Technology, Chair of the School of Technology and School of Applied Sciences, Muncie; BS, Martin University; AS, Ivy Tech Community College; MS, Indiana State University; PhD, Tennessee State University
WISE, MARK, Assistant Professor in Physical Therapy Assistant, Program Chair, Muncie; BS, Bowling Green University; MA, Ball State University
WOLFE, QUANE, Instructor in Liberal Arts and Sciences, Assistant Chair for Mathematics and Physical Sciences, Anderson
WOODWARD, CATHERINE, Associate Professor in Health Sciences, Chair, Muncie; BSN, Ball State University, MSN, Indiana Wesleyan University

WABASH VALLEY REGION

PITTMAN, JEFF, Chancellor; BS, Western Kentucky University; BS, Indiana University; MS, Indiana State University; PhD, Indiana University
KING, DEANNA L., Vice Chancellor of Academic Affairs; BS, Indiana University; MBA, PhD, Indiana State University
ALLMAN, LEAH, Vice Chancellor of Student Affairs, Terre Haute; BS, MS, Indiana State University

FACULTY

ABBITT, JERRY, Associate Professor in Computer Information Systems, Terre Haute; BS, MS, Indiana University
ALSMAN, CATHY, Associate Professor in Human Services, Program Chair, Terre Haute; BS, MS, Indiana State University

ARCHER, JAMES, Assistant Professor in Criminal Justice, Terre Haute; BS, MS, Indiana State University
ARNEY, DON, Professor, Dean, School of Technology, Co-Dean, School of Applied Science and Engineering Technology, Terre Haute; BS, MS, Indiana State University
BAUGHMAN, TERRA, Instructor in Nursing, Greencastle; AS, BS, Indiana State University; MS, Indiana Wesleyan University
BEAR, LORI, Faculty Fellow in Medical Assisting, Terre Haute; CMA, CPHI, Professional Careers Institute
BERRISFORD, RICK, Assistant Professor in Welding, Terre Haute; BS, Indiana State University
BLANC, TRACY, Assistant Instructor in Nursing, Terre Haute; AS, BS, Indiana State University
BOESSEN, MELANIE, Associate Professor in Office Administration, Program Chair, Terre Haute; AAS, Ivy Tech State College; BS, MS, Indiana State University
BOLINGER, BONNIE, Professor in Business Administration, Program Chair, Terre Haute; BS, MBA, Indiana State University; PhD, Indiana State University
BOYER, BRENDA, Instructor in Nursing, Terre Haute; AS, BS, Indiana State University
BRINSON, JAMES, Assistant Professor in Science, Terre Haute; BA, MS, Indiana State University
BROUGHTON, BARBARA, Assistant Professor in Mathematics, Terre Haute; BS, MS, Queens University
BROWNING, AMY, Assistant Professor in Accounting, Program Chair, Terre Haute; BS, Indiana State University; MBA, Ball State University
BURKE, ROBIN, Instructor in General Education, Terre Haute; BA Indiana State University; MA, Ball State University
CANNON, EMILY, Instructor in Nursing, Terre Haute; AS, Vincennes University; BS, MS, Indiana Wesleyan University
CHANEY, MARY, Associate Professor in Visual Communications, Program Chair, Terre Haute; BA, St. Mary-of-the-Woods College; MS, Indiana State University
COFFEY, LYNETTE, Instructor in Nursing, Terre Haute; ASN, Vincennes University; BS, Indiana Wesleyan University
COLE, CATHY, Assistant Professor in Elementary Education, Terre Haute; BA, Muskingum College; MS, Marygrove College
COOPER, KIM, Assistant Professor in Practical and Associate of Nursing, Department Chair, Terre Haute; BS, AS, Indiana State University; MS, Indiana State University
COX, PHYLLIS, Assistant Professor in Liberal Arts and English, Terre Haute; BS, MA, Indiana State University
CREED, SHERRA, Instructor in Surgical Technology, Terre Haute; AS, BS, Indiana State University
DAHLIN, BROCK, Assistant Professor in Business Administration, Internship Coordinator, Terre Haute; BS, Eastern Illinois University; MPA, Indiana State University
DAVIS, MICHAEL, Instructor in Automotive Services, Program Chair, Terre Haute; AAS, Ivy Tech State College
DIEL, MARY, Assistant Instructor in Radiology, Terre Haute; AS, Ivy Tech Community College
DINKEL, KYNON, Assistant Instructor in Automotive Technology, Terre Haute; AAS Vincennes University
EICHHORST, BARBARA, Assistant Professor in Medical Laboratory Technology, Terre Haute; BS, MS, Indiana State University
FIELDS, VICTOR, Assistant Professor, Site Manager, Terre Haute; BS, Indiana State University; MS, Indiana University
GAMBILL, JANE, Associate Professor in Medical Laboratory Technology, Program Chair, Terre Haute; BS, MS, Indiana State University
GOOD, ANSON, Assistant Professor in Automotive Technology, Terre Haute; BS, MS, Indiana State University
GODDE, RENA, Associate Professor in Medical Laboratory Technology, Terre Haute; BA, Greenville College; MS, Indiana State University
GOSNELL, KELLY, Associate Professor in Practical and Associate of Nursing, Terre Haute; AS, BSN, Indiana

State University; MS, University of Southern Indiana
GRAHAM, JEANNE ANN, Professor in Liberal Arts, Program Chair, Terre Haute; BS, Indiana University; MA, Indiana State University
GRASFEDER, JENNAFER, Assistant Instructor in Radiology, Terre Haute; RT, RDMS, RVT, Western Kentucky Community and Technical College
GREENWELL, WILLIAM, Assistant Professor in Human Services, Terre Haute; BA, MA, University of Mississippi
HARMLESS, MALCOLM, Assistant Professor in Electronics, Program Chair, Terre Haute; AAS, Ivy Tech State College; BS, MS, Indiana State University
HART, MYRA, Instructor in Nursing, Terre Haute; BS, Indiana Wesleyan University
HELDERMAN, MICHELLE, Instructor in Practical Nursing, Terre Haute; BS, University of Evansville; MS, Indiana Wesleyan University
HENSON, JOSEPH, Assistant Professor in Mathematics, AS, Lake Land College; AAS, Ivy Tech State College; BS, Purdue University
HOFMANN, BEULAH, Associate Professor in Practical and Associate of Nursing, Department Chair, Greencastle; BSN, MS, Indiana State University
JONES, CHARLES, Assistant Professor in Manufacturing and Industrial Technology, Terre Haute; AAS, Ivy Tech State College; BS, Indiana State University
JONES, CHERYL, Assistant Professor in Early Childhood Education, Program Chair, Terre Haute; AAS, BS, MS, Indiana State University
KIRBY, BRYAN, Assistant Professor in General Education, Terre Haute; BA, Olivet Nazarene University; MS, Indiana State University
LAWSON, JAMES, Assistant Professor in Manufacturing and Industrial Technology, Terre Haute; BS, Indiana State University
LIECHTY, SARAH, Assistant Professor in Science, Terre Haute; BS, MS, Indiana State University
LIGGET, LUCINDA, Assistant Professor in Liberal Arts and English, Terre Haute; AS, Vincennes University; BS, MA, Indiana State University
LONG, JOE, Assistant Instructor in HVAC, Terre Haute; TC, AAS, Ivy Tech State College
MAHER, ELIZABETH, Assistant Professor in Life Sciences, Terre Haute; BS, St. Mary-of-the-Woods College; MS, Indiana State University
MASSA, LILA, Instructor in Mathematics, Terre Haute; BS, MS, Indiana State University
MCCAMMON, CARRIE, Associate Professor in Mathematics, Program Chair, Terre Haute; BS, MS, Indiana State University
MCCODY, MELYSSA, Assistant Instructor in Practical and Associate of Nursing, Terre Haute; ASN, BSN, Indiana State University
MCNEIL, TRACI, Instructor in Practical Nursing, Terre Haute; BS, Southern Illinois University Edwardsville; MSN, Barnes-Jewish College of Nursing and Allied Health
MOORE, JEFFREY, Instructor in Electronics and Computer Technology, Terre Haute; BS, Indiana University Purdue University Indianapolis; MS, Indiana Central University; MS, Indiana State University
MUMMA, SCOTT, Assistant Instructor in Automotive, Terre Haute; AAS, Ivy Tech State College
MURRAY, ROBERT, Associate Professor in Computer Information Systems and Computer Information Technology, Program Chair, Terre Haute; BA, MS, Butler University
NICOSON, BARRY, Instructor in Paramedic Science, Program Chair, Terre Haute; AAS, Ivy Tech State College; BSBA, Colorado Technical University
OPELL, TOMMIE, Instructor in Nursing, Greencastle; AS, Vincennes University; BS, Indiana Wesleyan University; MSN, Regis University

OSTER, SYLVIA, Instructor in Science, Greencastle; BA, University of Kansas; PhD, Northwestern University
PAGE, KAREN, Associate Professor in Visual Communications, Terre Haute; BS, Hardin-Simmons University; MS, MA, MFA, Indiana State University
PASSEN, PAM, Instructor in Office Administration, Terre Haute; AAS, Ivy Tech State College; BS, Franklin University
PEEBLES, CHARLES, Assistant Instructor in Electronics and Computer Information Systems, and Medical Assisting (Massage Therapy), Terre Haute; AAS, Ivy Tech State College; BS, Capella University
PERDUE, SHERRY, Instructor in Nursing, Greencastle; BS, Indiana State University
PURDUE, JENNIFER, Associate Professor in Respiratory Care, Program Chair, Terre Haute; ART, BS, Indiana University; ASN, Excelsior College; MA, Ball State University
RASLEY, JAMES, Assistant Professor in Computer Information Systems, Terre Haute; AAS, Ivy Tech State College; BS, Pacific Western University
RONG, JIANREN, Associate Professor in Design, Program Chair, Terre Haute; BSAE, Tianjin Institute of Technology; MS, Rose-Hulman Institute of Technology; MBA, Lancaster University
ROSENE, JOHN, Instructor in Agriculture, Program Chair, Terre Haute; BS, Indiana State University; BS, MS, University of Kentucky
SCHONBERGER, BECKY, Assistant Professor in Medical Assisting, Program Chair, Terre Haute; BS, Indiana State University; BS, University of Evansville
SCHROEDER, KENNETH, Assistant Professor in Computer Information Technology, Terre Haute; BS, Indiana State University; MBA, Indiana Wesleyan University
SCHWENK, TERRI, Instructor in Practical and Associate of Nursing, Terre Haute; AS, Vincennes University; BSN, MSN, Indiana Wesleyan University
SCOTT, STACEY, Instructor in Medical Assisting, Terre Haute; ASN, BSN, Indiana State University
SHEPLER, SARAH, Faculty Fellow in Business Administration, Terre Haute; BS, Indiana State University; MS, Indiana Wesleyan University
SHOTWELL, R. ALLEN, Professor in Liberal Arts and Sciences, Dean, School of Public and Social Services, Co-Dean School of Applied Science and Engineering Technology, Terre Haute; BS, Rose-Hulman Institute of Technology; MS, Indiana State University; MA, Indiana University
SISCO, DONOVAN, Assistant Professor in Welding and Machine Trades, Terre Haute; AAS, Ivy Tech State College; BS, Indiana State University
STULTZ, LESLIE, Professor in Liberal Arts and Sciences, Dean, School of Education and School of Liberal Arts and Sciences, Terre Haute; BS, MS, PhD, Indiana State University
SUTTON, MARY, Instructor in Radiology Technology and Clinical Coordinator, Terre Haute; AAS, Ivy Tech State College; BS, Florida Hospital College of Health Sciences
TAYLOR, JERILYNN, Instructor in Nursing, Terre Haute; BS, Indiana State University
THOMAS, PATRICIA, Assistant Professor in Math, Terre Haute; BS Eastern Illinois University; MLS, MS, Indiana State University
TROUT-SWALLS, JANET, Associate Professor in Business Administration, Dean, School of Business and School of Fine Arts and Design, Terre Haute; BS, Indiana State University; MBA, Indiana Wesleyan University
TRUXAL, BROOKE, Instructor in Respiratory Care, Director of Clinical Education in Respiratory Care, Terre Haute; BS, Indiana University
VOGEL, LOIS ANN, Instructor in Nursing, Terre Haute; BS, Indiana Wesleyan University; MS, Indiana State University
WEBSTER, JANICE, Professor in Science, Department Chair, Terre Haute; BS, MA, Indiana State University
WILL, JULIE, Assistant Professor in Nursing, Dean, School of Health Sciences, Terre Haute; BS, MS, Indiana State University

WILLEY, RICHARD, Instructor in Advanced Manufacturing and Industrial Technology, Program Chair, Terre Haute; BS, Purdue University; MA, Ball State University
WILSON, DEBRA, Assistant Professor in Surgical Technology, Program Chair, Terre Haute; BSN, MSN, Indiana Wesleyan University
WISBEY, LOUISE, Assistant Professor in Radiology, Program Chair, Terre Haute; AS, University of Evansville; BS, Indiana University Purdue University Indianapolis School of Medicine; MS, Indiana State University

CENTRAL INDIANA REGION

DUNN, HANK, Chancellor; AA, Indiana River Community College; BA, University of Florida; MEd, Florida Atlantic University; EdD, University of Florida
LEE, KATHELEN, Vice Chancellor of Academic Affairs, Indianapolis; AS, MS, Indiana University; BS, Muskingum College; EdD, Ball State University

FACULTY

ADRIAN, AMY, Instructor in Spanish, Indianapolis; AA, Monterey Peninsula College; BA, MAT, Indiana University
ALHAND, ELAINE, Instructor in Mathematics, Indianapolis; BA Marian College; MS, Butler University
ALTMAN, SUSAN, Assistant Professor in Paralegal Studies, Program Chair, Indianapolis; BA, MA, Eastern Kentucky University; JD, University of Louisville A
ANDERSON, LANA, Assistant Professor in Medical Assisting, Indianapolis; BA, University of Massachusetts; MA Ball State University
ANDREWS, LORI, Associate Professor in Medical Assisting, Program Chair, Indianapolis; AS, BS, MS, Indiana University
APPLE, PEGGY, Associate Professor in Education, Program Chair, Indianapolis; BS, Ball State University; MS, Bank Street College of Education; PhD, Indiana University
ARNETT, MARILYN B., Assistant Professor in Human Services, Indianapolis; MSW, LCSW
ATKINS, MARK, Assistant Professor in Electronic and Computer Technology, Indianapolis; BS, MS, Purdue University
AULL, ANN G., Associate Professor in Early Childhood Education, Program Chair, Indianapolis; BS, Indiana University; M Ed, Indiana State University
BALSLEY, DEWY, Assistant Professor in Social Sciences, Program Chair, Indianapolis; BGS, Indiana University; MA, Ball State University
BANNOURAH, HAYA, Instructor in Radiologic Technology, Indianapolis; AAS, Ivy Tech Community College
BARNES, JOHN BRADEN, Assistant Professor in Design Technology, Indianapolis; MS, Purdue University
BAUMER, MARGARET A., Assistant Professor in Office Administration, Indianapolis; AS, Miami Jacobs College of Business; BS, University of Cincinnati; MS, Indiana University
BECKER, LANA, Assistant Professor in Communication, Indianapolis; BA, West Chester University; MA, Regent University
BILBREY, REBECCA, Assistant Professor in Visual Communications, Indianapolis; BFA, Herron School of Art
BIZUNEH, MOGES, Indianapolis; BS, Haile Sallassie University; MS, Cornell University; PhD, Indiana University
BONE, SHARON, Assistant Professor in Academic Advancement, Division Chair, Indianapolis; BS, Ball State University; MS, Butler University
BORST, BETH, Assistant Professor in Liberal Arts and Sciences, General Studies Program Chair, Indianapolis;

BA, Indiana University; MA, Ball State University
BOWLING, CHARITY, Instructor in Respiratory Care, Indianapolis; BS, Indiana Wesleyan University
BRICKER, JEFF, Assistant Professor in Hospitality Administration, Program Chair, Indianapolis; AAS, Ivy Tech State College; BS, Indiana Wesleyan University; MA, Ball State University; Certified Executive Chef
BROOKS, JOHN, Assistant Professor, Indianapolis; BA, Morgan State University; MSM, Indiana Wesleyan University; JD, Indiana University
BROWN, MARY, Associate Professor in Nursing, Program Chair, Indianapolis; BSN, MSED, Indiana State University
BUZASH, VICTORIA A., Associate Professor in Academic Advancement English, Indianapolis; BS, Ball State University; MA, Ball State University
CAMPBELL, BRENDA R., Associate Professor in Academic Advancement English, Indianapolis; BA, University of North Florida; MA, Georgetown College
CARTER, JOE, Instructor in Criminal Justice, Indianapolis; BSE, Delta State University; MPA, Jacksonville State University
CARVER, STEVE, Instructor in Computer Information Systems, Indianapolis; AS, Purdue University; BA, Indiana University; MS, Indiana University Purdue University Indianapolis
CHATTERJEE, SHIKA, Assistant Professor in Practical Nursing, Indianapolis; BSN, MSN, Delhi University
CINKOSKE, BERNADETTE, Assistant Professor in Computer Information Systems, Indianapolis; BA, Indiana University
CLARKSON, CHERYL, Assistant Professor in Nursing, Indianapolis; BSN, Indiana University; MSN, Ball State University
COLEMAN, BRY, Instructor in Surgical Technology, Program Chair, Indianapolis; TC, Community College of the Air Force; AAS, AS, Ivy Tech Community College
COMSTOCK, ERIC, Assistant Professor in Human Services, Program Chair, Indianapolis; BA, Michigan State University; MA, John F. Kennedy University
COONEY, JOHN J., Humanities Program Chair, Indianapolis; BA, Siena College; MA, University of Wisconsin; MBA, Indiana University
DAUGHERTY, MARVIN L., Associate Professor in Computer Information Systems, Program Chair, Indianapolis; AAS, Ivy Tech State College; BS, Martin University; MS, Indiana State University
DAVIS, LORIE A., Regional Adjunct Faculty Coordinator, Indianapolis; BS, MS, Mississippi State University
DICKMANN, PATRICIA, Associate Professor in Early Childhood Education, Indianapolis; BS, Purdue University; MS, Nova University
DOCKERY, JOHN, Instructor in Automotive, Indianapolis; AAS, State University of New York at Farmingdale; BS, Buffalo State University
DUNCAN, BARBARA, Assistant Professor in Nursing, Indianapolis; BSN, Seton Hall University; MSN, Old Dominion University
DUNCAN, JAMES, C., Professor in Communications, Program Chair, Indianapolis; BS, Oakland City College; MDiv, Drew University; AM, DePauw University; EdD, Nova Southeastern University
DUNKLE, BOB, Assistant Professor in Social Sciences, Indianapolis; BA, Parson College; MS, Purdue University; PhD, Purdue University
EDWARDS, ALLEN, Instructor in Hospitality Administration, Indianapolis; AOS Culinary Institute of America
ENGLAND, THOMAS, Instructor in Hospitality Administration, Indianapolis; BA, University of Evansville. AOS Culinary Institute of America
EPPEL, ELISHA, Assistant Professor in Nursing, Indianapolis; MSN, St Joseph College
EVANS, JAMES, Assistant Professor in Anatomy and Physiology, Indianapolis; BS, MS, Indiana State University

FAULK, TIMOTHY E., Program Chair in Public Safety, Community & Emergency Preparedness Management, Indianapolis; AS, Indiana University; BS, University of New York

FINNEY, RONALD DEAN, Assistant Professor in Automotive Technology, Program Chair, Indianapolis; AAS, Ivy Tech State College; BS, Indiana University

FLANIGAN, WILLIAM T., Associate Professor in Manufacturing and Industrial Technology, Program Chair, Indianapolis; BS, Tri-State University; MS, Indiana Wesleyan University

FLICK, DANIEL, Instructor in Machine Tool Technology, Indianapolis; BA, Indiana University

FLUHARTY, LINDA KAY, Associate Professor in Nursing, Indianapolis; BSN, University of Evansville; MSN, IUUPI

FORMATO, MICHAEL, Program Chair, Design Technology, Machine Tool Technology, Indianapolis; AAS, Broome Community College; BSIT, SUNY Binghamton; MBA, Indiana Wesleyan University

FOWLER, LUSTER, Associate Professor in Health Sciences, Division Chair, Indianapolis; BS, Indiana Wesleyan University; MBA, Indiana Wesleyan University

FOX, MELINDA, Full Professor in General Education, Indianapolis; BS, MS, Indiana State University

GASSNER, CONNIE, Associate Professor in Early Childhood Education, Indianapolis; BS, University of Maine; MS, Indiana University

GIANG, CHI, Professor in Mathematics, Indianapolis; AA, Monterey Peninsula College; BA, University of California, Berkeley; MA, San Francisco State University

GORSLINE, MICHAEL D., Professor in Mathematics, Indianapolis; BA, Indiana University; MA, Ball State University

DEBOURBON, MICHAEL W., Associate Professor in Design Technology, Division Chair, Indianapolis; BS, Southern Illinois University; MS, Indiana University

GRAY, HARRY E., Assistant Professor in Accounting, Program Chair, Indianapolis; BS, Butler University; CPA

GRIFFIN, LAURENE, Assistant Professor in Hospitality Administration, Indianapolis; AAS, Ivy Tech State College; BS, Indiana Wesleyan University; Certified Executive Chef

HACKER, LORIE, Assistant Professor in Nursing, Indianapolis; BSN, University of Indianapolis; MSN, Indiana Wesleyan

HALL, MICHAEL C., Associate Professor in Computer Information Systems, Indianapolis; ABD, Indiana State University; BS, MS, Purdue University

HARDING, DERRICK W., Assistant Professor in Academic Skills Advancement English, Indianapolis; BA, College of Wooster; MA, Indiana University

HAYES, AMY, Associate Professor in Nursing, Indianapolis; BSN, Indiana University; MSN, University of Phoenix

HEINY, ANN C., Instructor in Academic Advancement Life Skills, Indianapolis; BS, Manchester College; MS, Indiana State University

HICKS, CARMEN WEAVER, Assistant Professor in Social Sciences, Indianapolis; BA, University of Cincinnati; MA, Clark-Atlanta University; PhD, University of Maryland

HILTON, KIMBERLY A., Assistant Professor in Academic Advancement, Indianapolis; BA, University of Indianapolis; MS, Indiana University

HOKE, LISA, Medical Assisting Faculty, Indianapolis; BS, Indiana University

HOLLENBERG-CUSSEN, KRISTA, Assistant Professor in Paralegal Studies, Indianapolis; BA, Manchester College; MA, JD, Indiana University

HOLLOWELL, RONALD L., Professor in Academic Advancement English, Indianapolis; BS, University of Indianapolis; MA, Ed.D, Indiana University

HOLZINGER, BRENDA, Assistant Professor in Health Information Systems, Program Chair, Indianapolis; BHA, Indiana University; MSM, Indiana Wesleyan

HUETTEL, KEITH, Assistant Professor in Automotive Technology, Indianapolis; AAS, Ivy Tech State College; BS, Ferris State University

IRWIN, JAMES W., Assistant Professor in Manufacturing and Industrial Technology, Indianapolis; AAS, Ivy Tech State College; BS, Martin University; MS, Oakland University

JABLONSKI-POLK, TERESA, Associate Professor, Dean of Public & Social Services, School of Education, Indianapolis; BA, University of Kentucky; MSW, Washington University

JONES, KENNETH, Instructor in Business Education, Indianapolis; MBA, Indiana University

KECK, ROBERT JOE, Professor in Human Biology, Indianapolis; BS, University of Southern Indiana; MS, Indiana State University; MS, College of St. Francis

KNAUS, MARY ANN, Instructor in Nursing, Indianapolis; BSN, Indiana University; MS, Regis University

KOLLER, ANGELA M., Associate Professor in Nursing, Program Chair, Indianapolis; BSN, Purdue University; MSN, University of Phoenix

LAFOUREST, JUDITH, Assistant Professor in English, Indianapolis; MBA, University of Detroit

LEIGH, GREGORY, Assistant Professor in Computer Information Systems, Indianapolis; BS, MS, Indiana University

LESURE, JENNIFER, Associate Professor in Accounting, Indianapolis; MBA, Indiana Wesleyan University

LEVERETTE, DEBRA, Assistant Professor in Office Administration, Indianapolis; BS, Ball State University; MS, Indiana University

LEWIS, WILLIAM ALAN, Associate Professor in Visual Communication, Indiana; BS, MS, Indiana University

LUX, ANDREA, Assistant Professor in Nursing, Indianapolis; BSN, University of Indianapolis

MAGNANT, PETER T., Associate Professor in Health Sciences and Public Services, Indianapolis; AA, BS, Indiana University; BA, St. Mary's College; MS, EdD, Indiana University

MANNAN, SUSAN, Program Chair, Library Technical Assistant, Statewide Distance Education Program; BA Heidelberg College; MA Library, Indiana University; PhD Indiana State University

MEADOWS, CHRIS, Instructor in Automotive Technology, Indianapolis; AS, BA, Indiana University

MEYER, LESLIE, Assistant Professor in Academic Advancement Mathematics, Indianapolis; BS, MS, Purdue University

MILLER, BRIAN, Program Chair, Mortuary Science, Indianapolis; AAS, BS, Cincinnati College of Mortuary Science; MS, Ball State University; Licensed Funeral Director

MILLER, DAVID E., Associate Professor in Electronics and Computer Technology, Program Chair, Indianapolis; AAS, Ivy Tech State College; BS, Purdue University; MS, Indiana State University

MILLINER, SEAN, Instructor in Computer Information Systems, Indianapolis; BA, Glenville State College; MS Cappella University

MILLS, TRACEY B., Assistant Professor in Biotechnology, Indianapolis; BS, MS, Tennessee Tech University

MOAMAN, FRANKIE L., Associate Professor in Business Administration, Division Chair, Indianapolis; BS, Murray State University; MS, Oakland City University; PhD, Indiana State University

MUNDT, JAMES D., Instructor in Academic Advancement Mathematics, Indianapolis; AB, Hanover College; JD, Indiana University

MURPHY, TODD, Associate Professor in Biotechnology, Program Chair, Indianapolis; BS, MS, University of Kentucky

NERING, DOUGLAS, Associate Professor in Mathematics, Indianapolis; BS, Purdue University; MBA, University of Indianapolis

NETTERVILLE, ELVIS E., Assistant Professor in Academic Advancement Mathematics, Indianapolis; BS, Indiana University Purdue University at Indianapolis; BA, Indiana University; MPA, Indiana University Purdue University at Indianapolis

NOE, J. STEPHEN, Instructor in Anatomy and Physiology, Indianapolis; BS, University of Notre Dame; MS, Illinois State University

OBERTHUR, JOANNA, Assistant Professor in Academic Advancement Math, Indianapolis; BS, University of Florida; MS, Indiana University
 OROZCO, DEBORAH, A, Instructor Nursing, Indianapolis; BSN, Valparaiso University.
 PAPROSKI, SUSAN, Assistant Professor in Radiology, Indianapolis; BS, Indiana University; MA, Ball State University
 PEREZ, JOHN, Assistant Professor in Visual Communications, Indianapolis; BS, Ball State University; MS, Indiana University
 PHELPS, LINDA L., Instructor in Nursing, Indianapolis; BSN, Anderson University
 PIERCE, DEBRA, Associate Professor in Early Childhood Education, Indianapolis; BA, North Park University; M.S. Nova University
 PIERCEALL, REESE, Assistant Professor in Communication, Indianapolis; BA, Eastern Illinois University; MA, Ball State University
 POHLMAN, RICHARD, Instructor in Public Safety, Indianapolis; AS Indiana University; BS Indiana University
 PREEER, JAMES C., Professor in Science, Indianapolis; BA, Swarthmore College; BS, Columbia University; PhD, California Institute of Technology
 RAMSEY, SUSAN B., Associate Professor in Academic Advancement, English, Indianapolis; BS, MS, Indiana University
 REKLAU, MARY ANN A., Associate Professor in Nursing, Indianapolis; ASN, Staten Island Community College; BSN, MSN, CNP, Indiana University
 RIEGER, JEANNE, Instructor in Surgical Technology, Indianapolis
 RICE, MARY KATHLEEN, Associate Professor in Academic Advancement English, Indianapolis; BA, MS, Indiana University Purdue University at Indianapolis
 RIFKIND, LORENE, Assistant Professor in Nursing, Indianapolis; BSN, University of North Carolina, MSN, Ball State University
 RISHBY, LAURA, Assistant Professor in Nursing, Indianapolis; BSN, Indiana University; MSN, Anderson University
 ROBETSON, STEPHANIE, Program Chair, Fine Arts and Visual Communications, Indianapolis; BFA, Miami University; MFA, University of Georgia
 RUBENSTEIN, ALBERT, Assistant Professor in Science, Indianapolis; BS, MS, Memphis State University; PhD, University of Tennessee
 RULE, S. RENEE, Assistant Professor in English, Indianapolis; BA, Indiana University; MFA, Goddard College
 RUSSELL, LARRY, Assistant Professor in English, Indianapolis; BS, MS, Indiana State University
 RUSU, LUCIA, Professor in Science, Program Chair, Indianapolis; BS, Babes-Bolyai University; MS, Purdue University
 SCAVUZZO, CHRISTY, Instructor in Academic Advancement English, Indianapolis; BA, University of Southern Indiana; MA, Indiana State University
 SCHOWE, EDWIN, Assistant Professor in Chemistry, Indianapolis; BA, MS, Purdue University; MA, Ball State University
 SCHUCK, CAROL, Assistant Professor in English, Program Chair, Indianapolis; BS, Ball State University; MA, Butler University
 SEDAM, STACEY, Assistant Professor in Nursing, Indianapolis; BSN, St. Francis College
 SENSENBRENNER, OWEN L., Assistant Professor in Manufacturing and Industrial Technology, Indianapolis; BS, MS, Indiana State University
 SHARON, STEPHEN, Assistant Professor in Manufacturing and Industrial Technology, Indianapolis; BS, Purdue University; MS, Iowa State University
 SHIRZADI, SIMIN, Assistant Professor in Social Sciences, Indianapolis; BA, MA, EdS, Western Michigan University; EdD, Nova Southeastern University
 SIMON, CHRISTINE, Instructor in Nursing, Indianapolis; AS, Parkland College; BSN, University of Phoenix
 SMITH, ALLEN N., Assistant Professor in History, Indianapolis; BA, Hope College; MA, University of Michigan; JD, Indiana University
 SMITH, DIANE, Associate Professor in Early Childhood Education, Indianapolis; BS, Ohio State University; MS, Georgetown College
 SODTS, DAVID L., Assistant Professor in English, Indianapolis; BA, Marian College; MsEd, Indiana University
 SPARKS, MICHAEL, Assistant Professor in Political Science, Indianapolis; BA, Eastern Illinois University; MA, Eastern Illinois University
 SPENCER, BRENDA, Assistant Professor in English, Indianapolis; BA, Purdue University; MA, New York University
 STOWE, MARCUS D., Associate Professor in Respiratory Care, Program Chair, Indianapolis; AS, Indiana University; BS, St. Francis University; MS, Indiana University
 SUMMERS, DEBORAH, Assistant Professor in Nursing, Indianapolis; BSN, Indiana University
 TAYLOR, RONDA, Assistant Professor in Business Administration, Indianapolis; BS, Purdue, MBA, University of Phoenix
 TARRICONE, BONNIE, Assistant Professor in Anatomy and Physiology, Indianapolis; BA, Wheaton College; MA, The William Paterson College of New Jersey; PhD, Indiana University
 TEEGARDEN, JANET, Professor in Mathematics, Indianapolis; BA, DePauw University; MS, Indiana State University; MEd, National-Louis University
 THOMAS, MARGARET S., Associate Professor in Mathematics, Indianapolis; BS, Winthrop University; MS, Indiana State University
 UPDIKE, BARTON, Assistant Professor in Social Science, Indianapolis; AB, Hanover College; MDiv, Yale University
 VIDA, PAUL, Instructor in Hospitality Administration, Indianapolis; AA, Dramatic-Arts, San Diego; AOS, Culinary Institute of American
 WACEK, VICTORIA, Associate Professor in Mathematics, Program Chair; BS, Mapua Institute of Technology; MS, University of New Hampshire; EdD, University of Missouri-Columbia
 WARD, JUDY, Instructor in Medical Assisting, Indianapolis; BS, Ball State University
 WARNER, LAURA, Associate Professor in Nursing, Indianapolis; BSN, Oakland University, MSN, University of Phoenix
 WHITFIELD, WILLIE, Associate Professor in Criminal Justice, Program Chair, Indianapolis; BA, MS, Alabama A & M University
 WILCOX, ANN, Associate Professor in Radiologic Technology, Program Chair, Indianapolis; BS, Marian College-Fond du Lac, Wisconsin; MS, Indiana University
 WILSON, MICHAEL, Assistant Professor in English, Indianapolis; BS, California University of Pennsylvania; MA, Ball State University
 WILSON, ROSE, Assistant Professor in Early Childhood Education, Indianapolis; BS, MEd, California University of Pennsylvania
 WURTZ, ROBERT L., Assistant Professor in Design Technology, Indianapolis; AS, BS, Purdue University; MS, Indiana State University
 YANCEY, MERRILL, Associate Professor in Business Administration, Indianapolis; BS, MA, Oakland City University

RICHMOND REGION

STECK, JAMES, Chancellor; BS, MS, Ohio State University
TINCHER, STEVEN, Vice Chancellor of Academic Affairs; BS, MA, Ball State University; PhD, Regent University
PENNINGTON, SABRINA, Vice Chancellor of Student Affairs; BA, University of Indianapolis; MS, Ball State University

FACULTY

ANDERSON, JILLENE K., Professor in Health Sciences, Dean; BS, Indiana Wesleyan University; MS, Ball State University; RN
AYTON, EUGENE G., Assistant Professor in Business Administration, Program Chair; BS, Morgan State University; MA, Ball State University
BECHTEL, BARBARA E., Associate Professor in Nursing; BSN, Indiana University; MSN, University of Southern Indiana; RN
BLAKELY, CURTIS, Assistant Professor in Computer Information Systems and Computer Information Technology, Department Chair; AS, BS, Indiana University; MBA, Jones International University
CAMPBELL, KATHY, Assistant Professor in Early Childhood Education, Department Chair; AS, Ivy Tech State College; BS, Saint Mary of the Woods; MS, University of Dayton
CLINE, GLENDA, Assistant Professor in Nursing; BSN, Indiana University; MSN, University of Southern Indiana; RN
COOK RAMONA, Assistant Professor in Construction Technology, Program Chair; AAS, Ivy Tech State College; AA, BGS, Indiana University; MS, Indiana Wesleyan University
COREY, JUDY W., Instructor in Nursing; BSN, Indiana University Southeast; MPH, Indiana University; RN
FERGUSON, JEANNE, Assistant Professor in Life Sciences; BS, Marian College; MA, Ball State University
FORT, NANCY, Instructor in Education; BS, MA, Ball State University
FRANZT, ROBERT M., Assistant Professor in Automotive Technology, Program Chair; AAS, Ivy Tech State College; BS, Indiana Wesleyan University; ASE Master Mechanic; ASE Master Machinist
GABBARD, BILLIE JO, Assistant Professor in Nursing, Department Chair; TC, ASN, Ivy Tech State College; BSN, Indiana University; MSN, University of Phoenix; RN
GABBARD, KENNEY, Faculty Fellow in Advanced Manufacturing and Industrial Technology; AAS, Indiana Vocational Technical College; BS, Indiana Wesleyan University
GIDNEY, CHARLES, Associate Professor in Communications, Program Chair; BA, Grambling State University; MA, Governors State University
GRAESSER, WILLIAM M., Professor in Mathematics, Dean; BA, Otterbein College; MAT, Webster University
GUARD, KIMBERLY, Instructor in Nursing; BSN, Indiana Wesleyan University; MSN, Walden University; RN
HUMPHRIES, MARY C., Instructor in Advanced Manufacturing and Industrial Technology; BS, Purdue University; MST, Washington University
JOHNSON, JASON, Assistant Professor, Computer Information Systems and Computer Information Technology, Program Chair; BS, MS, Indiana Wesleyan University
KLEIN, BETTY J., Assistant Professor in Medical Assisting; TC, Indiana Vocational Technical College; BS, College of Mt. St. Joseph; MS, University of St. Francis
LARSON, JERRY, Instructor; AAS, Ivy Tech Community College
MENNETT, MICHAEL, Assistant Professor in Mathematics; BS, Ohio State University; MS, Cleveland State University
DAKES, JULIA, Instructor in Academic Skills Advancement; AAS, Ivy Tech Community College; BA, Indiana

University East

OLER, RONALD, Associate Professor in Office Administration, Department Chair for Office Admin. and Paralegal Studies; AAS, Ivy Tech State College; BS, MS, Indiana Wesleyan University
OLSON, BRIAN, Assistant Professor in Anatomy & Physiology and Life Sciences; BS, University of Dayton; BS, Doctor of Chiropractic, National College of Chiropractic
PHARES, VANESSA, Assistant Professor in Nursing; ASN, Indiana University; BSN, Indiana Wesleyan University; RN; MSN, University of Phoenix; RN
PLANKENHORN, KATHERYN, Assistant Professor in Medical Assisting, Program Chair; TC, Ivy Tech State College; ASN, Regents College; BSN, Indiana Wesleyan University; RN
RAMEY, MARY, Instructor in English; BA, Earlham College; MA, Indiana State University
ST. JOHN, TERRY, Instructor in Life Sciences; BS, Tri-State College; MS, Southern Illinois University at Carbondale
STOKES, JAMES, Assistant Professor in Advanced Manufacturing and Industrial Technology, Department Chair; BA, MA, Ball State University
SWIHART, ANNA, Assistant Professor in Health Sciences; BS, Ohio University; MS, Ball State University
TERRELL, PEGGY J., Professor in Office Administration, Dean; BS, Indiana State University; MA, Ball State University
THALLS, TAMMY, Instructor in Nursing; BSN, Indiana University; RN
THURSTON, SHERYL L., Associate Professor in Nursing; BSN, MA, Ball State University; MSN, University of Phoenix; RN
TOWER, KAREN, Assistant Professor in Accounting; BS, Indiana Wesleyan University; MBA, University of Phoenix
TULLY, THOMAS, Instructor in Agriculture; BS, Purdue University; MS, Ohio State University
WARD, BARBARA, Assistant Professor in Nursing; ASN, BSN, Indiana University; MSN, University of Southern Indiana; RN
WILSON, MARC L., Associate Professor in General Education; BA, MA, Ball State University

COLUMBUS REGION

HOGAN, JOHN, Chancellor, Columbus; BS, MA, Western Kentucky University; PhD, Indiana State University
HINE, ROSALIE J., Vice Chancellor for Academic Affairs, Columbus; BS, MS, EdD, Ball State University
BINGHAM, ROGER, Vice Chancellor for Student Affairs, Columbus; BA, MA, University of Dayton

FACULTY

ANDERSON, MARI BETH, Professor in Education, Columbus; BA, Indiana University; MA, Butler University; EdD, Nova Southeastern University
BAKER, GENEVA, Professor in Health Sciences, Dean, School of Health Sciences, Columbus; AAS, BSN, MSN, Indiana University
BARDONNER, STEVEN, Associate Professor in Design, Program Chair; AS, Ivy Tech Community College; BS, Ball State University; MS, Indiana University
BENSON, CARA, Instructor in Nursing, Columbus; BSN, Indiana University
BREEDING, JUDY, Instructor in Nursing, Columbus; BSN, Indiana University
BRIGGS, JOYCE, Instructor in Nursing, Columbus; BSN, Elmhurst College; MSN, Xavier University
BURTON, JANET, Instructor in Nursing, Columbus; BSN, Bob Jones University; MSN, University of Alabama

CAIN, WENDY, Assistant Professor in Anatomy and Physiology and Microbiology, Columbus; BS, Olivet Nazarene University; MS, Indiana University

CANINE, JILL, Professor in Computer Information Technology, Program Chair, Columbus; BA, Hanover College; MA, Ball State University

CARTER, PAULA, Instructor in Nursing, Columbus; BSN, Indiana University; MSN, University of Phoenix

DEPAUL, LOUIS, Associate Professor in Business and Accounting, Columbus; BS, Youngstown State University; MBA, Indiana University

DOUGHERTY, RONALD, Professor in Business Administration and Accounting, Assistant Dean, School of Business, Columbus; BS, Indiana University; MS, Indiana Wesleyan University

ERICK, DEBORA, Assistant Professor in Nursing, Columbus; BSN, Loma Linda University

GAUJON, ANTHONY, Professor in Biology, Program Chair, Columbus; BS, MS, PhD, University of Southern California

GILES, CAROLYN, Professor in Mathematics, Columbus; BS, MS, Indiana University

GRAUE, GREGORY, Associate Professor in Mathematics, Columbus; BS, MAT, Indiana University; MA, Ball State University

HALLAWELL, JO ANN, Assistant Professor in English, Program Chair; BS, Ball State University; MS, Indiana University

HAMMERSLEY, PHIL, Assistant Professor in Mathematics, Columbus; BA, Olivet Nazarene College; MS, Indiana University

HARDEN, TERESA, Associate Professor in Nursing, Columbus; BSN, Indiana University; MSN, Indiana Wesleyan University

HAWKINS, KATHY, Instructor in Medical Assisting, Program Chair, Columbus; AAS, Ivy Tech State College; BS, MS, Indiana State University

HAZA, KIM, Instructor in Industrial Technology, Columbus; AA, AAS, Ivy Tech State College; BS, Indiana State University

HERMANSON, JAMES, Assistant Professor in Chemistry, Columbus; BA, MS, University of Colorado; PhD, University of Cincinnati

HUNTINGTON, SANDY, Instructor in Nursing, Columbus; BSN, MSN, Indiana University; MBA, Indiana Wesleyan University

JACKSON, ROBERT, Assistant Professor in Accounting, Columbus; BS, MA, Bowling Green State University

JOHN, MATTHEW, Instructor in Agriculture, Program Chair, Columbus; BS, Purdue University; MS, Western Kentucky University

KELCEGLU, BEKIR, Instructor in Interior Design, Program Chair, Columbus; BA, Anadolu University; MFA, Ohio State University

LAWRENCE, JEFFREY, Assistant Professor in Communications, Columbus; BA, MA, University of Nevada-Las Vegas

LEWIS, ELOISE, Professor in Nursing, Columbus; BA, MA, Adelphi University; MSN, University of Southern Indiana

LISOWSKI, NINA, Instructor in Visual Communications, Program Chair, Columbus; BS, Illinois Institute of Technology

MCPHERSON, KAREN, Assistant Professor in Criminal Justice, Department Chair, Columbus; BA, College of the Ozarks; MA, Lincoln University; ABD, Ohio State University

MEEK, MARY, Associate Professor in Nursing, Columbus; AS, Ivy Tech Community College; BSN, MSN, Ball State University

NOITING, BONNIE, Professor in Office Administration, Program Chair, Columbus; BS, MS, Indiana University

NORRELL, MARY PATRICIA, Professor in Nursing, Program Chair, Columbus; BSN, Ball State University; MS, Indiana University

RAGLE, BRENDA, Associate Professor in Early Childhood Education, Department Chair, Columbus; BA, Indiana University; MBA, Indiana Wesleyan University; PhD, Ball State University

ROBERTS, JOHN WM., Assistant Professor in English, Dean, School of Liberal Arts and Sciences, Columbus; BA, Morehead State University; MS, University of Louisville; MA, National University

SCHMELZ, PAMELA, Instructor in Information Security, Program Chair, Columbus; BS, Purdue University; MBA, Indiana Wesleyan

SHEETS, SUSAN, Assistant Professor in Surgical Technology, Department Chair, Columbus; AAS, Ivy Tech State College; AS, BS, Purdue University

SIMS, CHARLES, Instructor in Paramedic Science, Program Chair, Columbus; AAS, Purdue University; BA, Indiana University

SOBAT, THOMAS, Assistant Professor in Biology, Columbus; BS, Grand Canyon University; MS, Ball State University

SWITZER, SUSAN, Instructor in Nursing, Columbus; BSN, Indiana Wesleyan

TODD, JANET, Instructor in Nursing, Columbus; BA, Indiana Wesleyan University

UPDIKE, FAWN, Instructor in Nursing, Columbus; BS, Purdue University

VINCENT, PAMELA, Instructor in Psychology, Program Chair, Columbus; BA, Tennessee Temple University; MS, University of Tennessee

WALTZ, SUSAN, Professor in Nursing, Department Chair Columbus; BSN, Indiana University; MSN, Ball State University; PhD, Rush University

WILSON, JONATHAN, Professor in Visual Communications, Dean, School of Fine Arts and Design, Applied Science and Technology, and Education Technology, Columbus; BFA, San Francisco Art Institute; MFA, Indiana University

WONNING, JUDY, Associate Professor in Nursing, Columbus; BSN, Indiana University; MSN, Ball State University

SOUTHEAST REGION

HELMS, JAMES, Chancellor; BS, Hanover College; MS, EdS, Xavier University

HEIDERMAN, DON, Campus Dean/Dean of Student Affairs, Madison; BA, Indiana State University

GRAVER, MARK, Campus Dean/Associate Dean of Academic Affairs; BS, Indiana University; MS, Central Michigan University

MOORE, L. JOE, Vice Chancellor of Academic Affairs; AB, PhD, Indiana University

FACTORY

ADAMS, CORA, Assistant Professor in Practical Nursing, Madison; BSN, Indiana University; MSN, Indiana Wesleyan University

BATTA, GEORGE, Assistant Professor in Industrial Technology, Lawrenceburg; BS, Rose-Hulman Institute of Technology; MS, PhD, Purdue University

BETS, ANGEL, Assistant Professor in English and Communications; BS, Ball State University; MA, University of Illinois

CAROLLUS, CATHY, Assistant Professor in English and Communication, Program Chair, Lawrenceburg; BA, Connecticut College; MA, Xavier University

CARTWRIGHT, SUSAN, Assistant Professor, Computer Information Systems, Madison; BS, Indiana Wesleyan University; MS, Indiana State University

DADOSKY, PAUL, Associate Professor in Computer Information Systems, Lawrenceburg; BS University of Kentucky; MS, Xavier University

DISCH, THERESA, Assistant Professor in Medical Assisting Program Chair, Lawrenceburg; AS, Vincennes University; BS, Indiana Wesleyan

DORSEY, LAURIE E., Associate Professor in Associate of Nursing Program, Madison; BS, Ball State University; MSN, Indiana University

ERICKSON, JOHN L., Professor, General Education and Support Services, Madison; BA, Indiana State University; MS University of Kentucky

GARNER, ANNABET, Program Chair, Medical Assisting, Madison; AS, Ivy Tech State College; BS, University of Southern Indiana

GGLEIN, RICHARD E., Department Chair, Accounting and Business Administration, Madison; BA, Hanover College; MBA, Indiana Wesleyan

GONZALEZ, NICOLE, Assistant Professor in Liberal Arts, Program Chair, Lawrenceburg; BA, Siena Heights University; MA, Xavier University

GOODIN, JENNIFER, Assistant Professor, General Education and Support Services, Madison; BA, Transylvania University; MA, University of Louisville

GREER, RUTH A., Program Chair in General Education and Support Services, Madison; BA, University of Florida; MS, Indiana State University

HALL, TAMARA L., Assistant Professor in Associate of Nursing Program, Madison; BSN, University of Evansville; MSN, Indiana University

HELMAS, REBECCA, Associate Professor of Business and Accounting, Madison; BS, University of Evansville; MS, Indiana State University

HENDERSON, KARLA, Assistant Professor in Education, Program Chair, Lawrenceburg; BA, Marian College; MEd, Xavier University; PhD, Miami University

KING, DEBBIE, Instructor, Lawrenceburg; BSN, Indiana Wesleyan University

KOUDSIA, SAMER, Assistant Professor in Business Administration, Batesville; BS, Indiana University; MBA, Indiana Wesleyan

KRISTOFF, STEVEN, Associate Professor in Life and Physical Science and Math, Program Chair, Lawrenceburg; BS, MS, PhD, Indiana University

LAUBER, CYNTHIA, Assistant Professor in Nursing, Lawrenceburg; BSN, Marian College; MSN, Indiana Wesleyan University

LYNN, CAROL, Instructor in Associate of Nursing; BSN, Ball State University

MARPLE, DONNA, Assistant Professor in General Education, Program Chair, Lawrenceburg; BA, Marian College

MCKAY, SUZANNE, Assistant Professor in Nursing, Lawrenceburg; BSN, MSN, Indiana Wesleyan University

MCILVAIN, BETH, Assistant Professor in English and Communication, Program Chair, Madison; BA, Miami University

MEDYNSKI, THOMAS, Assistant Professor, General Education and Support Services, Madison; BA, University of Chicago; MS, Northwestern University; MA, PhD, Indiana University

MILLER, SHYRA, Associate Professor, General Education and Support Services, Madison; BS, Purdue University; PhD, University of North Carolina-Chapel Hill

MORTON, JENNIFER, Professor in Accounting and Business, Lawrenceburg; BS, Miami University; MBA, Xavier University

PROBST, MATTHEW, Associate Professor in Accounting and Business, Department Chair, Lawrenceburg; BS, Indiana University; MBA, Xavier University

RAHSCHULTE, SCOTT M., Assistant Professor in Health Sciences and Liberal Arts and Sciences, Lawrenceburg;

BS, DC, National College of Chiropractic

SANCHEZ, ELIZABETH, Professor in General Education and Support Services, Madison; BS, DePauw University; MA, Central Michigan University

SHAPINSKY, GENE A., Department Chair, Nursing, Madison; BSN, University of the State of New York; MSN, Bellarmine College; PhD, Indiana State University

SHARP, KABEN, Associate Professor in General Education, Lawrenceburg; AA, Concordia Lutheran College; AAB, BS, MEd, Miami University of Ohio

SIMMONS, GEORGIA, Instructor in Practical Nursing, Madison; BSN, Eastern Kentucky University; MSN, University of Southern Indiana

TACKETT, GEORGE, Program Chair, Electronics and Computer Technology, Madison; AAS, Ivy Tech State College; BS, Rose-Hulman Institute of Technology

WILLIAMS, JANE, BSN, University of Cincinnati

YOWLER, HOLLACE, Associate Professor in Practical Nursing, Madison; BSN, University of Kentucky; MSN, University of Southern Indiana

SOUTHWEST REGION

SCHENK, DAN, Chancellor; BS, University of Southern Indiana; MBA, University of Evansville; PhD, Indiana State University

AHERN, JR, JAMES J., Vice Chancellor for Academic Affairs; BA, Roanoke College, MA, PhD, The Ohio State University

ANDERSON, DEBORAH, Vice Chancellor of Student Affairs, Evansville; BS, BA, MS, University of Kansas

FACULTY

AMSLER, JEANNE, Associate Professor in Liberal Arts, Evansville; BA, MS, MFA, Indiana State University

ARROWSMITH, HEATHER, Assistant Professor in Education, Program Chair, Evansville; BA, Marshall University; MS, University of Kentucky

AULICH, SUMMER, Associate Professor in Medical Assisting, Evansville; AAS, Ivy Tech State College; BS, MS, University of Southern Indiana

BAILEY, SANDRA C., Associate Professor in Business Administration, Program Chair, Evansville; BS, University of Southern Indiana; MBA, University of Evansville

BARNETT, TAMARA, Assistant Professor in Biotechnology, Program Chair, Evansville; BS, MS, Auburn University

BASS, PAMELA, Instructor in Nursing, Evansville; AS, BA, University of Evansville; MS, University of Southern Indiana

BUNNER, LANA L., Professor in Office Administration, Program Chair, Evansville; BS, MS, University of Southern Indiana

CARTER, ASHLEY, Assistant Instructor in Nursing, Evansville; BS, University of Evansville

CHAPMAN, CAROLE, Assistant Professor of English, Evansville; BA, MA, University of Evansville

CLIFTON, LONNIE, Assistant Professor in Computer Information Systems and Computer Information Technology, Evansville; AS, BS, MS, Southern Illinois University; MS, University of Evansville

COMBS, STEVEN B., Professor in Advanced Manufacturing, Program Chair, Evansville; BS, MS, Murray State University

COUGHLAN, S. DANETTE, Assistant Professor in Computer Information Systems and Computer Information

- Technology, Department Chair, Evansville; BS, University of Southern Mississippi; MS, Southwest Missouri State University
- COZART, KELLY, Assistant Professor in Interior Design, Program Chair, Evansville; BS, University of Illinois; MA, Indiana State University
- DENTINO, MARY, Professor in Business, School Dean, Evansville; BS, MS, University of Southern Indiana; PhD, Indiana State University
- DICKMAN, DAN, Assistant Professor in Psychology, Evansville; BS, Northern Arizona University; MA, Adams State College
- DIEMER, JEANIE L., Associate Professor in Business Administration, Evansville; BS, Eastern Illinois University; MBA, University of Southern Indiana
- DILLMAN, MATTHEW A., Professor in General Education, Evansville; BS, University of Southern Indiana; MS, Murray State University; MENG, University of Louisville
- DURBIN, JOHN, Assistant Professor in Welding, Evansville; AAS, Ivy Tech State College; BS, Franklin University
- DYE, SUSAN E., Professor in Nursing, Department Chair, Evansville; BS, MS, University of Evansville
- EHLEN, MARGARET K., Professor in English, Evansville; BA, University of Illinois-Urbana; MA, Northeastern Illinois University
- ESTEP, INNA, Instructor in Microbiology, Evansville; M.D., Voroshilovgrad Medical Institute
- FRITZ, VANESSA, Assistant Instructor in Life/Physical Sciences, Evansville; BS, MS, University of Southern Indiana
- GARRATT, RANDALL, Faculty Fellow in Early Childhood Education, Evansville; BA, Indiana University, MA, PhD, Indiana State University
- GENTRY, KEVIN, Instructor in Computer Information Systems, Evansville; BS, Purdue University
- GORE, KAREN W., Professor in Business Administration, Evansville; BA, MBA, University of Evansville
- GRAMMER, NANCY, Associate Professor in English, Program Chair; BA, MA, University of Evansville
- GREESON, CYNTHIA B., Professor in Accounting, Program Chair, Evansville; BS, Central Michigan University; MBA, University of Southern Indiana
- HAAG, BOB, Assistant Professor in Building Construction Management/Construction Technology, Department Chair; BS, Youngstown State University
- HARPER, DAVID, Instructor in Visual Communications, Evansville; AS, Ivy Tech Community College, BA, University of Southern Indiana
- HELLER, BILL C., Associate Professor in Mathematics, Evansville; BA, Defiance College; MS, St. Francis College
- HESS, MARY, Associate Professor in Human Services, Program Chair, Evansville; BS, University of Southern Indiana; MA, Western Kentucky University
- HINKLE, JULIA, Professor in Surgical Technology, Program Chair, Evansville; BS, Indiana Wesleyan University; MS, University of Evansville
- HOSTETLER, JOE, Associate Professor in Visual Communications, Program Chair, Evansville; BA, Purdue University; MS, Indiana University
- HOUCHEIN, JAMIE, Instructor in Nursing, Evansville; AS, Vincennes University, BS, University of Southern Indiana, MS, University of Southern Indiana
- HOWARD, MICHAEL A., Associate Professor in Physics, Evansville; BS, Murray State University; MEP, University of Virginia
- JINDRICH, SUSAN, Associate Professor in Early Childhood Education, Program Chair, Evansville; AS, University of Southern Indiana; BS, Auburn University; MS, Indiana State University
- JOBE, NANCY, Associate Professor in Office Administration, Evansville; BS, Wayne State University, MBE, Eastern Michigan University
- KATOWITZ, CAROL, Associate Professor in Early Childhood Education, School Dean, Evansville; BS, Purdue University; BS, University of Southern Indiana; MA, University of Evansville
- KIEFER, CHRISTOPHER, Assistant Professor in Criminal Justice, Department Chair, Evansville; BS, MS, Indiana State University
- KINCHELOE, DONNA, Instructor in Nursing, Evansville; BSN, University of Evansville
- KIRKWOOD, BARBARA H., Associate Professor in Academic Skills Advancement, Evansville; BA, University of Evansville; MS, University of Southern Indiana
- KIRKWOOD, LESLIE, Instructor in Nursing, Evansville; AS, BS, University of Southern Indiana, MS, University of Evansville
- LAMMERS, MARK P., Professor in Automotive Technology, Program Chair, Evansville; AAS, Ivy Tech State College; BS, Eastern Illinois University; MS, Indiana State University
- LINDSAY, GAIL, Instructor in Nursing, Evansville; AS, Southeastern Illinois College; BS, Southern Illinois University at Edwardsville
- MCCUTCCHAN, JUDITH A., Professor in Nursing, School Dean, Evansville; AS, BS, MS, University of Evansville
- MCNEELY, BRIAN, Instructor in Mathematics, Evansville; AS, Vincennes University, BS, MS, Indiana State University
- MERLE, DON, Assistant Professor in Industrial Technology, Program Chair, Evansville; BS, Purdue University; MS, University of Southern Indiana
- MEIBALANE, PAMELA, Assistant Professor in Nursing, Evansville; BS, MS, University of Evansville
- MILLS, ANN E., Professor in Office Administration, Evansville; AS, Wabash Valley College; BS, MS, Southern Illinois University
- MOORE, CYNTHIA, Instructor in Medical Assisting, Program Chair, Evansville; BS, MS, University of Southern Indiana
- MOTYCKA, ANN, Professor in Nursing, Evansville; AS, Sinclair Community College; BS, MS, University of Evansville
- NIEHAUS, MICHAEL A., Assistant Professor in Electronics and Computer Technology, Program Chair, Evansville; BS, University of Southern Indiana
- O'DANIEL, SCOTT, Associate Professor in Speech and Interpersonal Communication, Evansville; BS, University of Cincinnati; BS, University of Southern Indiana; MA, Ball State University
- ODNEY, PAUL, Instructor in English, Evansville; BA, Concordia College, MA, Southern Illinois University, PhD, Southern Illinois University
- OFFERMAN, J. STEPHEN, Associate Professor in Business Administration, Evansville; BS, MBA, University of Evansville
- PERRY, BILL, Assistant Professor in Pre-Engineering, Program Chair, Evansville; BSME, University of Alabama; MA, Bastyr University
- PETTY, MICHAEL E., Professor in General Education, School Dean, Evansville; BA, Indiana State University; MA, University of Evansville; PhD, Indiana State University
- PHELPS, WATEZ, Instructor in Hospitality Administration, Program Chair, Evansville; AS, Culinary Institute of America, BA, MA, University of Evansville
- REED, RICHARD, Instructor in Criminal Justice, Evansville; BS, Indiana State University; MS, University of Evansville
- RENDELMAN, BARBARA, Associate Professor in Biology, Evansville; BS, University of Illinois; MS, University of Wisconsin-Milwaukee
- RIES, ANTONINA, Associate Professor in Chemistry, Program Chair, Evansville; BS, MS, St. Petersburg University
- ROBB, TRACY, Assistant Professor in Visual Communications, Evansville; BS, University of Southern Indiana; MFA, Savannah College of Arts and Design

SATTERFIELD, MICHAEL A., Assistant Professor in Design Technology, Program Chair, Evansville; BS, Ball State University

SCHENK, LINDA, Assistant Professor in Early Childhood Education, Evansville; BS, Indiana University; MA, University of Evansville

SHULL, DONALD, Associate Professor in Psychology, Program Chair, Evansville; MS, University of Evansville; EdD, Indiana University

SILLIMAN, JEANNE C., Professor in Academic Skills Advancement, Evansville; BA, Saint Benedict College, MA, University of Evansville

SIMPSON, MICHELE, Instructor in Nursing, Evansville; BS, MS, Western Kentucky

STARINES-KIELY, KATHRYN, Instructor in Medical Assisting, Evansville; BS, MS, University of Evansville

SWAIN-LeDOUX, CAMILLA, Assistant Professor in Academic Skills Advancement, Program Chair, Evansville; BA, Certificate in Youth Ministry, Taylor University; MA, University of Southern Indiana

TICHENOR, JANE, Professor in Academic Skills Advancement; Evansville; BS, Oakland City University; MS, Indiana University

UHDE, KARLA G., Associate Professor in Nursing, Evansville; BS, Indiana University; MS, University of Pennsylvania

VOGLER, TIFFANY, Assistant Instructor, Life and Physical Sciences, Evansville; BS, Cumberland College

VOLLMER, TIMOTHY, Instructor in Paramedic Science, Program Chair, Evansville; BA, MA, Southern Illinois University

WARREN, GREGORY A., Assistant Professor in Automotive Technology, Evansville; AA, Parkland College, BA, Southern Illinois University; MS, Southern Illinois University

WEISS, JAN, Associate Professor in Mathematics, Program Chair, Evansville; BS, MS, University of Southern Indiana

WEST, BRIAN, Associate Professor in Technology, School Dean, Evansville; BS, MS, Rose-Hulman Institute of Technology

WHIPPLE, REBECCA L., Professor in Nursing, Evansville; BS, MS, University of Evansville

WHITE, VICTORIA R., Assistant Professor in Accounting, Evansville; BS, MBA, University of Southern Indiana

WILLIAMS, BRUCE, Assistant Instructor in Nursing, Evansville; AS, Vincennes University; BS, MS, Oakland City University

WILTSIE, LISA, Assistant Professor in Academic Skills Advancement, Evansville; MS, Oakland City University

ZIMMERMAN, DONNA, Instructor in Industrial Technology, Evansville; AS, Jamestown Community College, BS, Pennsylvania State University; MS, Litchburg College

SOUTHERN INDIANA REGION

SHOURDS, RITA H., Chancellor, Sellersburg; BA, Indiana University; MS, University of Louisville; EdD, Spalding University

NOLOT, TERRY, Dean of Enrollment Services, Sellersburg; AS, Vincennes University; BS, MS, Indiana State University

FAULKENBURG, MARILYN, Vice Chancellor of Academic Affairs, Sellersburg; BS, Purdue University; MA, Webster University; EdD, Spalding University

FACULTY

BENNETT, DAVID R., Associate Professor in Economics, Sellersburg; BS, MS, Indiana State University; MA, University of Delaware; EdD, University of South Carolina

BOLEY, AMANDA, Instructor in Psychology, Sellersburg; BA, Indiana University Southeast; MA, Ball State University

BONDEN, EMILY, Instructor in English, Sellersburg; BA, Central Wesleyan University; MFA, Spaulding University

BROUGHTON, TONYA, Assistant Professor in Associate of Science in Nursing, Sellersburg; LPN, ASN, Ivy Tech State College; BSN, Indiana University Southeast; RN, MSN, Bellarmine University

BURTON, PAMELA, Instructor in Medical Assisting, Program Chair, Sellersburg; CMA, Jefferson State Vocational School, CPT, LRT

CLARK, BONNIE L., Instructor in Associate of Science in Nursing, Sellersburg; ASN, Ivy Tech State College; BSN, Indiana University Southeast

CLIFTON, DAVID L., Associate Professor in Business, Division Chair, Sellersburg; BSC, University of Louisville; MBA, University of Kentucky; EdD, Spalding University

CULBERTSON, MELANIE, Assistant Professor in English, Sellersburg; BA, Morehead State University; MA, University of Louisville; MFA, Indiana University

EDWARD, DAVID, Instructor in Design Technology, Sellersburg; BS, West Virginia University; MBA, University of Louisville

FEITELSON, GREGORY, Instructor in Sciences, Sellersburg; BA, Centre College; MA, University of Louisville; MS, University of Louisville

FITZNER, BEVERLY, Associate Professor in Office Administration, Sellersburg; BS, Indiana University; MS, State University of New York

FLATT, TODD, Instructor in Fine Arts & Design, Sellersburg; BA Eckerd College

FREEMAN, BARBARA, Associate Professor in Practical Nursing, Sellersburg; BSN, Midwestern State University; MS, Indiana State University

GARDENOUR, LEONARD, Instructor in Criminal Justice, Sellersburg; BA, Indiana University; MS, Michigan State University

GIBSON, KELLY, Instructor in Medical Assisting, Sellersburg; AAS, Ivy Tech Community College

GOWER, NATHAN, Instructor in English, Sellersburg; BA Campbellsville University; MA, Spalding University

GRAY, JAN, Instructor in Respiratory Care, Sellersburg; AAS, University of Kentucky; BA, Rochville University

GREAVER, BETTY, Instructor in Massage Therapy, Sellersburg; BSN, Spalding University

GREGORY, MICHAEL, Associate Professor in Anatomy and Physiology, Sellersburg; BS, MS, Eastern Kentucky University; MS, University of Louisville

HARRIS, JOHN, Instructor in Industrial and Advanced Manufacturing, Sellersburg; AAS, Purdue; AAS, Ivy Tech Community College

HEATH, DANA, Instructor in Practical Nursing, Sellersburg; ASN, Ivy Tech Community College; BSN, Indiana University Southeast

HORNUNG, BRIAN, Assistant Professor in HVAC, Sellersburg; AAS, Community College of the Air Force; BS, Wayland Baptist; MS, Indiana State University

HOSMER, KRISTEN, Instructor in Practical Nursing, Sellersburg; BSN, Indiana University

JEWELL, SUSAN C., Associate Professor in Practical Nursing, Program Chair, Sellersburg; LPN, New Albany Community of Nursing; BSN Spalding University; MS, Indiana University

KAY, BRIDGET, Instructor in Practical Nursing, Sellersburg; BSN, Indiana University Southeast

KINKLE, MARK ROBERT, Assistant Professor in Respiratory Care, Sellersburg; AHS, University of Louisville; BA, Clemson University

LEWELLEN, LONNIE R., Professor in Design Technology, Division Chair, Sellersburg; AAS, Louisville Technical Institute; BA, Louisville Bible College; MA, Cincinnati Bible College; MS, Indiana State University

LEWIS, KRISTY, Instructor in Medical Assisting, Sellersburg; TC, Ivy Tech State College; CPC and CCP, PHIA

LYNCH, REBEKAH, Assistant Professor in Business, Sellersburg; BA, Tabor College; MSA, Central Michigan University

MAYDEN, SUSAN, Instructor in Respiratory Care, Sellersburg; BS, University of Louisville; MS, Indiana Wesleyan University

MCCORMICK, MAURICE D., Associate Professor in Human Services, Program Chair, Sellersburg; BS, University of Louisville; MEd, Spalding University; CPC EDD, Heed University; LMHC

MCKAY, TERESA, Assistant Professor in Early Childhood Education, Program Chair, Sellersburg; BS, Indiana University; MA, Concordia University

MORGANTI, SUSAN, Instructor in School of Arts and Design, Sellersburg; BA, University of Louisville

NEWBY, PATSY K., Assistant Professor in Communication, Sellersburg; BA, Lindsey Wilson College; MA, Western Kentucky University

NOE, KEITH, Professor in Electronics and Computer Technology, Program Chair, Sellersburg; AS, Cincinnati Technical College; BS, University of Cincinnati; MS, Indiana University Southeast

PATUS, JIM W., Assistant Professor in Biology, Sellersburg; BA, Indiana University

PHULPAGAR, STANLEY, Instructor in General Education, Sellersburg; BS, Bhayan's College; MS, Central Michigan University

PICKERILL, KEN, Instructor in Automotive Technology, Sellersburg; BS, MS, Indiana State University

QUINLAN, TERRANCE, Professor in Manufacturing and Industrial Technology, Department Chair, Sellersburg; AAS, Kentucky College of Technology; BA, Morehead State University; MS, Indiana State University

RANDELI, GOOL, Professor in General Education, Program Chair, Sellersburg; BA, MA, University of Bombay; MLS, Indiana University; MS, Indiana University Southeast

RAWLES, DEBORAH, Associate Professor in Medical Assisting, Sellersburg; AS, Mount Ida Junior College; BA, Purdue University; PA, University of Kentucky

ROBERTS, A. JACK, Associate Professor in Mathematics, Program Chair, Sellersburg; BS, Austin Peay University; MS, Indiana University Southeast

ROBINSON, APRIL, Assistant Professor in Mathematics, Sellersburg; BS, Eastern Kentucky University; MS, Indiana University

ROEDERER, LINDA, Assistant Professor in Mathematics, Sellersburg; BS, MS, Indiana University

ROYALTY, BRANDY, Instructor in Practical Nursing, Sellersburg; ASN, Ivy Tech Community College; BSN, Indiana University Purdue University Columbus

SCOTT, JERRY, Assistant Professor in Accounting, Sellersburg; BS, Indiana University Southeast; MA, Webster University

SCOTT, OPHELIA, Assistant Professor in Education, Sellersburg; BS, MEd, University of Louisville

SPARKMAN, ANGELA, Instructor in Medical Laboratory Technician, Sellersburg; BS, University of Louisville; Technical Certificate, University of Louisville

SPECK, MELISSA, Assistant Professor in Business, Sellersburg; BS, MBA, Indiana University

SPETH, KIMBERLY, Instructor in Associate of Science in Nursing, Sellersburg; BSN, RN, Indiana University

STOCKDELL, ELIZABETH, Assistant Professor in Associate of Science in Nursing, Sellersburg; BSN, MA, Spalding University

SUER, JUSTIN, Instructor in Business, Dean of Business, Sellersburg; BS, Indiana University Bloomington; MBA, Indiana University Southeast

TACKETT, BILLIE JUNE, Assistant Professor in AS Nursing, Sellersburg LPN, Spencerian; AS, Ivy Tech State College; BSN, Indiana University Southeast; RN MSN, Bellarmine University

TALBERT, MICHAEL, Associate Professor in Academic Skills Advancement, Division Chair, Sellersburg; BA, Central Bible College; MDiv, Southern Baptist Theological Seminary

WHITEHILL, KRISTI, Instructor in Communications, Sellersburg; BS, MA, Wayne State University

VOGEN-RIFFLE, MARY, Instructor in Practical Nursing, Sellersburg; BSN, UAB

WRIGHT, DIAN, Assistant Professor in Associate of Science Nursing, Sellersburg; AS, Hiwassee College; BS, US Army School of Allied Health; MBA, Indiana Wesleyan University

YORK, ROBERT L., Associate Professor in English, Sellersburg; BS, MA, Southern Illinois University

YOST, PAUL, Assistant Professor in Computer Information Systems and Computer Information Technology, Sellersburg; BS, Thomas A. Edison State University; BS, Indiana University; MS, Webster University; PhD, California Coast University

BLOOMINGTON REGION

WHIKEHART, JOHN, Chancellor; BS, Indiana University; MA, Ball State University

FROST, NANCY, Assistant Dean of Academic Affairs; BS, MS, MBA, Indiana University

HANDY, LORI, Interim Vice Chancellor for Enrollment Services; BS, MS, Indiana University, Doctoral Candidate in PhD ISU

SMITH, JAMES O., Vice Chancellor for Academic Affairs; BS, Ball State University; MBA, University of Illinois; PhD, Indiana State University

VAUGHAN, JENNIE, Executive Director for Administration; BS, University of San Francisco

FACTU

ALEXANDER, BLAIR, Assistant Professor in Liberal Arts, Bloomington; MS, Indiana University

ALSHIP, DAVID, Assistant Professor in Design Technology, Bloomington; MS, Murray State University

ARNOLD, STEVE, Associate Professor in Biotechnology, Bloomington; BA, Indiana State University; MS, Purdue University; EdD, The George Washington University

BARE, BRUCE, Assistant Professor in Paramedic Science, Public Safety and Paramedic Science Program Chair, Bloomington; BA, Purdue University

BARNES, KIRK, Professor in Design Technology, School of Technology Chair, Bloomington; BS, MA, Ball State University

BOBO, EMILY, Assistant Professor in Liberal Arts, Bloomington; MFA, Wichita State University; PhD, University of Kansas

CANTU, KENNETH, Instructor in Hospitality Administration, Bloomington; BA, City College of New York, French Culinary Institute

COTE, SARAH, Assistant Professor in Biotechnology, Bloomington; MS, Virginia Tech University

CRAIG, KATHLEEN, Assistant Professor in Health Information Technology, Program Chair, Bloomington; BS, Indiana University

DAWSON, RONALD A., Professor in Liberal Arts, Bloomington; BS, University of Illinois; MA, Eastern Illinois University

DIX, JEANETTE, Assistant Professor in Computer Information Systems, Computer Information Technology, Office Administration, Bloomington; BS, Indiana University

ELKES, ROY, Associate Professor in Accounting, Bloomington; BA, MA, Indiana University

ELLARD, CECIL, Assistant Professor in Academic Skills Advancement, Math/Science Program Chair, Bloomington; PhD, Kansas State University

ENGLERT, STEVEN A., Instructor in Accounting, Program Chair, Bloomington; BS, Indiana University

ESCH-WILLIAMS, MARK, Instructor in Industrial Technology, Program Chair, Bloomington; BS, Indiana State University

FENTON, WILLIAM, Assistant Professor in Industrial Technology, Bloomington; BS, Indiana State University

- GOODWIN, SHEILIA, Associate Professor in Associate of Science in Nursing, Bloomington; BS, BSN, Purdue University; MS, ABD, PhD, Indiana University
- GRAY, ANNIE M., Associate Professor in Liberal Arts, English, Program Chair, Bloomington; BA, Goshen College; MA, Indiana University
- GRIFFITH, CHRISTINE, Assistant Professor in Design Technology, Bloomington; BS, University of Illinois, MA, Indiana University
- GUSSE, WICKI, Instructor in Elementary Education, Bloomington; MS, University of Wisconsin; MS, Radford University
- HALL, DONN, Associate Professor in Liberal Arts, History, Art History, Economics, Music, Political Science, Geography, Art, Anthropology, Program Chair, Bloomington; BA, MA, Indiana University
- HAMRIC, MICHELLE, Assistant Instructor in Associate of Science in Nursing, Bloomington; BSN, University of Phoenix
- HASLER, GLORIA, Assistant Professor in Academic Skills Advancement, Bloomington; BS, Indiana University; MS, Butler University
- HEINZEN, JIM, Associate Professor in Business Administration, Department Chair Business Administration/Hospitality Administration, Bloomington; BS, University of Illinois; MS, Indiana University
- HESSERT, PAUL A., Associate Professor in Liberal Arts, Bloomington; BS, MA, Indiana University
- HOLTSLAW, DIANNA, Assistant Professor in Practical Nursing, Bloomington; MSN, University of Southern Indiana
- JAMES, MICHAEL R., Assistant Professor in Liberal Arts, Bloomington; BA, Mercer University; MA, Murray State University; Licensed Mental Health Counselor (Indiana)
- JLOUT-ELICK, KAREN, Associate Professor in Associate of Science in Nursing, Bloomington; MSN, University of Southern Indiana
- KATTERMANN, SANDRA, Assistant Professor in Biotechnology, Bloomington; BS, St. John's University; MSJ, Seton Hall School of Law
- KLEIN, KEITH, Instructor in Liberal Arts, Communications Program Chair, Bloomington; BS, Indiana University
- KORNYA, PETER S., Associate Professor in Liberal Arts, Bloomington; PhD, University of Oregon
- LARSON, ROBERT, Instructor in Liberal Arts, Bloomington; MA, University of Missouri-Kansas City
- LEACH, CELINDA K., Professor in Practical Nursing, School of Health Sciences Chair, Bloomington; BS, MPH, Indiana University; Nursing Diploma, University of Tennessee
- LEE, SENGYONG, Associate Professor in Biotechnology, Program Chair, Bloomington; PhD, Miami University
- MAITLAND, ANGELA, Assistant Professor in Criminal Justice and Paralegal Studies, Department Chair, Bloomington; MS, Ed.S., Central Missouri State University, ABD, Indiana University
- MARKHAM, BENJAMIN, Associate Professor in Liberal Arts, Math/Science Program Chair, Bloomington; BS, Western Kentucky University; MS, Indiana University
- MCCLAIN, LIZABETH S., Assistant Professor in Practical Nursing, Bloomington, MSN, Indiana Wesleyan University
- MCKINNEY, SASHA, Assistant Professor in Respiratory Care, Bloomington; BS, Indiana University Purdue University Indianapolis
- MELTON, NONA L., Associate Professor in Practical Nursing, Bloomington; BSN, University of Evansville; MSN, University of Southern Indiana, MSN-Family Nurse Practitioner, University of Southern Indiana; Family Nurse Practitioner Certification from the American Academy of Nurse Practitioners
- MILLEN, THOMAS, Assistant Professor in Electronics and Computer Technology, Bloomington; BSEE, University of Arkansas
- MOORE, CAROLYN, Instructor in Respiratory Care, Program Chair, Bloomington; BS, Indiana University-Purdue University Indianapolis
- NELSON, PEGGY L., Professor in Academic Skills Advancement, Division Chair, Bloomington; BS, MS, Indiana University
- OAKLEY, KATHRYN, Assistant Professor in Certified Nursing Assistant Training, Bloomington; BSN, Indiana University Southeast
- OVERTON, BONITA S., Assistant Professor in Liberal Arts, Bloomington; BS, University of Southern Indiana
- PAINTER, BRENDA, Assistant Professor in Practical Nursing, Bloomington; RN, ASN, BSN, MSN, WHNP-BC Indiana University
- PIERRO, LOU, Associate Professor in Computer Information Systems, Computer Information Technology, Program Chair, Bloomington; BS, MA, California State University; EdD, Indiana University
- QUIMBY, DEBRA, Assistant Instructor in Associate of Science in Nursing, Bloomington; RN, BSN, Indiana University
- READING, THOMAS C., Associate Professor in Business Administration, Bloomington; BS, Indiana University; MBA, Harvard University
- REINHARDT, MONTRA, Assistant Instructor in Practical Nursing, Bloomington; BSN, University of Evansville
- RICHARDS, JENNIFER, Assistant Professor in Associate of Science Nursing, Bloomington; BSN, Indiana University; MSN/MHA, University of Phoenix
- RISEN, MARJIE B., Associate Professor in Early Childhood Education, Program Chair, Bloomington; BS, MS, Indiana University
- RODRIGUEZ, OSCAR, Associate Professor in Electronics and Computer Technology, Bloomington; BSE, Trinity College & University; BSECT Indiana State University, MSECT Indiana State University
- RUCKER, JOHN, Assistant Professor in Criminal Justice and Paralegal Studies, Bloomington; BA, University of North Carolina at Chapel Hill, JD, Louisiana State University
- SIMMONS, CAROL A., Associate Professor in Academic Skills Advancement, English, Program Chair, Bloomington; BA, James Madison University; MA, Indiana University
- SOTO, ROBERT, Associate Professor in Liberal Arts, Sociology, Philosophy, Spanish, Human Services Program Chair, Bloomington; BS, MA, Texas Tech University
- STARR, ELIZABETH, Associate Professor in Liberal Arts, Bloomington; BA, MA, University of Minnesota; MA, Indiana University
- STRAIN, LARRY G., Associate Professor in Computer Information Systems, Computer Information Technology, Bloomington; BS, Indiana University
- SWAFFORD, LARRY G., Professor in Radiation Therapy, Program Chair, Bloomington; BS, University of Oklahoma; MEd, PhD, Virginia Commonwealth University
- THOMPSON, PAM, Associate Professor in Associate of Science in Nursing, Program Chair Bloomington; BSN, Morningside College; MSN, University of Southern Indiana
- WOLFRER, MARTIN, Associate Professor in Liberal Arts, Psychology, Program Chair, Bloomington; MS, Karl-Franzens University, MA, Ball State University
- WORDEN, WILLIAM P., Assistant Professor in Computer Information Technology, Bloomington; BS, MS, Ball State University
- WYATT, KARLEE, Instructor in Radiation Therapy, Bloomington, BA Indiana University/Purdue University at Indianapolis, Licensed Radiologist and Therapist for US Registry in Indiana
- YOUNG, DONNA K., Associate Professor in Office Administration, Bloomington; BS, MS, Indiana University



ACCREDITATIONS AND MEMBERSHIPS



Ivy Tech Community College is accredited by The Higher Learning Commission and is a member of The North Central Association. Other accrediting agencies and affiliates are listed below by regions. The College is a member of the American Association of Collegiate Registrars and Admissions Officers, the American Association of Community Colleges, the Association of Community College Trustees, CAUSE, the National Association of College and University Business Officers, the National Association of Colleges and Employers, the National Association of Financial Aid Administrators, the National Council for Research and Planning, the National Council on Student Development, and the Society for College and University Planning.

NORTHWEST (GARY, EAST CHICAGO, MICHIGAN CITY, VALPARAISO)

AGENCY	PROGRAM AREA
American Culinary Federation Foundation	Hospitality Administration
American Board of Funeral Services Education Accrediting Commission	Mortuary Science
Commission on Accreditation of Allied Health Education Programs:	
American Association of Medical Assistants' Endowment	Medical Assisting
Commission on Accreditation of Educational Programs for the Emergency Medical Services Professional	Paramedic Science
Committee on Accreditation for Respiratory Care	Respiratory Care
Accreditation Review Committee on Education in Surgical Technology	Surgical Technology
Council for Standards in Human Services Education	Human Services
National League for Nursing Accrediting Commission	Practical Nursing Associate of Science in Nursing
Indiana State Board of Nursing	Associate of Science in Nursing Practical Nursing
Commission on Accreditation in Physical Therapy Education	Physical Therapist Assistant
American Physical Therapy Association	Physical Therapist Assistant
Association of Collegiate Business Schools and Programs	Accounting Business Administration Computer Information Systems Office Administration

NORTH CENTRAL (SOUTH BEND, ELKHART, WARSAW)

AGENCY	PROGRAM AREA
Commission on Accreditation of Allied Health Education Programs:	
American Association of Medical Assistants' Endowment	Medical Assisting
Committee on Accreditation for Respiratory Care	Respiratory Care
National Accrediting Agency for Clinical Laboratory Sciences	Medical Laboratory Technology Phlebotomy

Indiana State Board of Health	Nurse Aide Qualified Medication Aide
Indiana State Board of Nursing	Associate of Science in Nursing Practical Nursing
Association of Collegiate Business Schools and Programs	Accounting Business Administration Computer Information Systems Office Administration
National Associate of Schools of Art and Design	Interior Design Visual Communication
National Association of Industrial Technology	Automotive Technology Design Technology Electronics and Computer Technology Industrial Technology
American Culinary Accrediting Commission	Hospitality Administration
HVAC Excellence	Manufacturing and Industrial Technology
National League for Nursing Accrediting Commission	Associate of Science in Nursing Practical Nursing
Indiana Department of Homeland Security	Emergency Medical Technician Ambulance
National Institute for Automotive Service Excellence/ National Automotive Technicians' Education Foundation, Master Certification	Automotive Technology
American Dental Association	Dental Hygiene
American Welding Society	Industrial Technology, Welding Concentration

NORTHEAST (FORT WAYNE)

AGENCY	PROGRAM AREA
American Association for Medical Transcription	Medical Assisting
American Association for Paralegal Education	Paralegal Studies
Commission on Accreditation of Allied Health Education Programs:	
American Association of Medical Assistants' Endowment	Medical Assisting
Committee on Accreditation for Respiratory Care	Respiratory Care
Commission on Accreditation of Educational Programs for the Emergency Medical Services Professional	Paramedic Science
American Welding Society	Welding Specialty
Association of Collegiate Business Schools and Programs	Accounting Business Administration Computer Information Systems Office Administration

Dietary Managers Association	Dietary Manager
Indiana State Board of Nursing	Practical Nursing Associate of Science in Nursing
National League for Nursing Accreditation Commission	Practical Nursing Associate of Science in Nursing
National Institute for Automotive Service Excellence/ National Automotive Technicians' Education Foundation	Automotive Technology
National Association of Industrial Technology	Construction Technology Design Technology Automotive Technology Industrial Technology
Federal Aviation Administration, Airmen Certification Branch	Aviation Technology
Commission for Hotel, Restaurant and Institutional Education	Hospitality Administration
American Culinary Federation Foundation	Hospitality Administration
Council for Standards in Human Services Education	Human Services
Commission on Massage Therapy Accreditation	Therapeutic Massager
Indiana State Board of Health	Certified Nursing Assistant Qualified Medication Aide
National Organization for Human Services Education	Human Services

LAFAYETTE (LAFAYETTE)

AGENCY	PROGRAM AREA
Indiana State Board of Nursing	Associate of Science in Nursing Practical Nursing
Indiana State Board of Health	Qualified Medication Aide
National League for Nursing Accrediting Commission	Associate of Science in Nursing Practical Nursing
American Dental Association, Commission on Dental Accreditation	Dental Assisting
Commission on Accreditation of Allied Health Education Programs:	
American Association of Medical Assistants' Endowment	Medical Assisting
Accreditation Review Committee on Education in Surgical Technology	Surgical Technology
Committee on Accreditation for Respiratory Care	Respiratory Care
Association for Collegiate Business Schools and Programs	Accounting Business Administration Computer Information Systems Office Administration
National Institute for Automotive Service Excellence/ National Automotive Technicians' Education Foundation	Automotive Technology
National Association of Industrial Technology	Automotive Technology Design Technology Industrial Technology

American Association for Paralegal Education	Paralegal Studies
National Association for the Education of Young Children	Early Childhood Education

KOKOMO (KOKOMO, LOGANSPORT)

AGENCY	PROGRAM AREA
American Association for Paralegal Education	Paralegal Studies
American Dental Association, Committee on Dental Accreditation	Dental Assisting
Association for Collegiate Business Schools and Programs	Accounting Business Administration Computer Information Systems Office Administration
Commission on Accreditation of Allied Health Education Programs	
Accreditation Review Committee on Education in Surgical Technology	Surgical Technology
American Association of Medical Assistants' Endowment	Medical Assisting
Committee on Accreditation of Educational Programs for the Emergency Medical Services Professional	Paramedic Science
Council for Standards in Human Services Education	Human Services
HVAC Excellence	Construction Technology - HVAC Specialty
Indiana State Department of Health	Certified Nursing Assistant
Indiana State Board of Nursing	Practical Nursing Associate of Science in Nursing
Indiana Department of Homeland Security	Paramedic Science
National League for Nursing Accrediting Committee	Associate of Science in Nursing Practical Nursing
National Association of Industrial Technology	Technology Division Programs
National Institute for Automotive Service Excellence/ National Automotive Technicians' Education Foundation	Automotive Technology

EAST CENTRAL (ANDERSON, MARION, MUNCIE)

AGENCY	PROGRAM AREA
Association for Collegiate Business Schools and Programs	Accounting Business Administration Computer Information Systems Office Administration
Association for Gerontology in Higher Education	Human Services
National Association of Industrial Technology	Technology Programs
Council for Standards in Human Services Education	Human Services
American Physical Therapy Association	Physical Therapy Assistant
Joint Review Committee on Education in Radiologic Technology	Radiologic Technology

Indiana Department of Homeland Security	Emergency Medical Technician Ambulance/Advance
Indiana State Department of Health	Certified Nursing Assistant Qualified Medication Aide
American Culinary Accrediting Commission	Hospitality Administration
Indiana State Board of Nursing	Practical Nursing Associate of Science in Nursing
Commission on Accreditation of Allied Health Education Programs:	
American Association of Medical Assistants' Endowment	Medical Assisting
Accreditation Review Committee on Education in Surgical Technology	Surgical Technology
Commission on Accreditation in Physical Therapy Education	Physical Therapist Assistant
National Institute for Automotive Service Excellence/ National Automotive Technicians' Education Foundation	Automotive Technology
National Organization for Human Services	Human Services
National Association for the Education of Young Children	Early Childhood Education
National League for Nursing Accrediting Committee	Associate of Science in Nursing Practical Nursing
American Dental Association, Committee on Dental Accreditation	Dental Assisting

WABASH VALLEY (TERRE HAUTE)

AGENCY	PROGRAM AREA
Association for Collegiate Business Schools and Programs	Accounting Business Administration Computer Information Systems Office Administration
Indiana State Board of Health	Nurse Aide Social Services/Long-Term Care Activity Director/Long-Term Care Qualified Medication Aide
Indiana Department of Homeland Security	Emergency Medical Technician
Indiana State Board of Nursing	Practical Nursing Nursing
National League for Nursing Accrediting Commission	Associate of Science in Nursing Practical Nursing
Council for Standards in Human Services Education	Human Services
National Association of Alcohol and Drug Abuse Counselors	Human Services
Commission on Accreditation of Allied Health Education Programs:	
American Association of Medical Assistants' Endowment	Medical Assisting
Accreditation Review Committee on Education in Surgical Technology	Surgical Technology
Committee on Accreditation for Respiratory Care	Respiratory Care
Committee on Accreditation of Educational Programs for the Emergency Medical Professional	Paramedic Science

National Accrediting Agency for Clinical Laboratory Sciences	Medical Laboratory Technician
Joint Review Committee on Education in Radiologic Technology	Radiologic Technology
National Association of Industrial Technology	Automotive Technology Industrial Technology Design Technology Electronics and Computer Technology
National Institute for Automotive Service Excellence/ National Automotive Technicians' Education Foundation	Automotive Technology
Joint Review Committee for Respiratory Therapy Education	Respiratory Care

CENTRAL INDIANA (INDIANAPOLIS)

AGENCY	PROGRAM AREA
American Board of Funeral Services Education	Mortuary Science
The American Culinary Federation Foundation	Hospitality Administration, Culinary Arts
International Association of Administrative Professionals	Office Administration
Commission on Accreditation of Allied Health Education Programs:	
American Association of Medical Assistants' Endowment	Medical Assisting
Accreditation Review Committee on Education in Surgical Technology	Surgical Technology
Committee on Accreditation for Respiratory Care	Respiratory Care
Joint Review Committee on Education in Radiologic Technology	Radiologic Technology
Association for Collegiate Business Schools and Programs	Accounting Business Administration Computer Information Systems Office Administration
Council for Standards in Human Services Education	Human Services
National Association of Industrial Technology	Industrial Technology Design Technology Electronics and Computer Technology Machine Tool Technology
National Institute for Automotive Service Excellence/ National Automotive Technicians' Education Foundation	Automotive Technology
National League for Nursing Accrediting Commission	Associate of Science in Nursing Practical Nursing
Indiana State Board of Nursing	Associate of Science in Nursing Practical Nursing
Indiana State Board of Health	Certified Nursing Assistant Qualified Medication Aide
International Council on Hotel/Restaurant and Institutional Education	Hospitality Administration
Commission on Accreditation of Hospitality Management	Hospitality Administration

Commission on Accreditation for Health Informatics and Information Management Education	Health Information Technology
American Association for Paralegal Education	Paralegal Studies

RICHMOND (RICHMOND)

AGENCY	PROGRAM AREA
Indiana State Board of Nursing	Associate of Science in Nursing Practical Nursing
National League for Nursing Accrediting Commission	Associate of Science in Nursing Practical Nursing
Indiana State Board of Health	Nurse Aide
Commission on Accreditation of Allied Health Education Programs:	
American Association of Medical Assistants' Endowment	Medical Assisting
Indiana Department of Homeland Security	Basic Emergency Medical Technician Advanced EMT
Association for Collegiate Business Schools and Programs	Accounting Business Administration Computer Information Systems Office Administration
National Association of Industrial Technology	Automotive Technology Construction Technology Industrial Technology
National Association for the Education of Young Children	Early Childhood Education
National Institute for Automotive Service Excellence/ National Automotive Technicians Education Foundation	Automotive Technology

COLUMBUS (COLUMBUS)

AGENCY	PROGRAM AREA
Indiana State Board of Nursing	Practical Nursing Associate of Science in Nursing
Association for Collegiate Business Schools and Programs	Accounting Business Administration Computer Information Systems Office Administration
Commission on Accreditation of Allied Health Education Programs:	
American Association of Medical Assistants' Endowment	Medical Assisting
Committee on Accreditation of Education Programs for the Emergency Medical Services Professional	Paramedic Science
Association of Surgical Technologists	Surgical Technology
Indiana State Board of Health	Certified Nursing Assistant

Association for Continuing Education and Training	Corporate and Continuing Education Services
National League of Nursing Accrediting Commission	Associate of Science in Nursing Practical Nursing
American Dental Association, Commission on Dental Accreditation	Dental Assisting
National Association of Industrial Technology	Design Technology Industrial Technology
National Association of Schools of Art and Design	Interior Design Visual Communications

SOUTHEAST (LAWRENCEBURG, MADISON)

AGENCY	PROGRAM AREA
Indiana State Board of Nursing	Associate of Science in Nursing Practical Nursing
National League of Nursing Accrediting Commission	Practical Nursing Associate of Science in Nursing
Commission on Accreditation of Allied Health Education Programs:	
American Association of Medical Assistants' Endowment	Medical Assisting
Indiana Department of Homeland Security	Emergency Medical Technician, Basic and Advanced
Association of Collegiate Business Schools and Programs	Accounting Business Administration Computer Information Systems Office Administration

SOUTHWEST (EVANSVILLE)

AGENCY	PROGRAM AREA
Commission on Accreditation of Allied Health Education Programs:	
American Association of Medical Assistants' Endowment	Medical Assisting
Committee on Accreditation of Education Programs for the EMS Professional	Paramedic Science
Accreditation Review Committee on Education in Surgical Technology	Surgical Technology
Association for Collegiate Business Schools and Programs	Accounting Business Administration Computer Information Systems Office Administration
National Institute for Automotive Service Excellence/ National Automotive Technicians' Education Foundation	Automotive Technology
National Association of Industrial Technology	Electronics Technology Design Technology Manufacturing Technology

Indiana State Board of Nursing	Associate of Science in Nursing Practical Nursing
National League for Nursing Accrediting Commission	Associate of Science in Nursing Practical Nursing
National Association for the Education of Young Children	Early Childhood Education

SOUTHERN INDIANA (SELLERSBURG)

AGENCY	PROGRAM AREA
Council for Standards in Human Services Education	Human Services
Indiana State Board of Nursing	Associate of Science in Nursing Practical Nursing
Indiana State Board of Health	Nurse Aide Qualified Medication Aide
National League of Nursing Accrediting Commission	Associate of Science in Nursing Practical Nursing
Indiana Department of Homeland Security	Emergency Medical Technician, Ambulance
National Institute for Automotive Service Excellence/ National Automotive Technicians' Education Foundation	Automotive Technology
Commission on Accreditation of Allied Health Education Programs:	
American Association of Medical Assistants' Endowment	Medical Assisting
Committee on Accreditation for Respiratory Care	Respiratory Care
Association for Collegiate Business Schools and Programs	Accounting Business Administration Computer Information Systems Office Administration
National Association of Industrial Technology	Automotive Technology Design Technology Electronics and Computer Technology Industrial Technology

BLOOMINGTON (BLOOMINGTON)

AGENCY	PROGRAM AREA
Indiana State Board of Nursing	Associate of Science in Nursing Practical Nursing
National League for Nursing Accrediting Commission	Practical Nursing Associate of Science in Nursing
Indiana State Department of Health	Nurse Aide
Indiana Department of Homeland Security	Emergency Medical Technician, Basic Paramedic

Association for Collegiate Business Schools and Programs	Accounting Business Administration Computer Information Systems Office Administration
National Association of Industrial Technology	Design Technology Electronics and Computer Technology Industrial Technology
Commission on Accreditation of Allied Health Education Programs:	
Committee on Accreditation of Educational Programs for the Emergency Medical Services Professional	Paramedic Science
Joint Review Committee on Education in Radiologic Technology	Radiation Therapy
Commission on Accreditation for Health Informatics and Informational Management Education	Health Information Technology



Contact Information for Accrediting Organizations

Accreditation Review Committee on Education in Surgical Technology

6 W. Dry Creek Circle, Suite 210
Littleton, CO 80120 (303) 694-9262 F:(303) 741-3655

American Association of Medical Assistants' Endowment

20 North Wacker Drive, Suite 1575
Chicago, IL 60606 (312) 899-1500

American Association for Medical Transcription

4230 Kierman Avenue, Suite 130
Modesto, CA 95356 (800) 982-2182 F:(209) 527-9633

American Association for Paralegal Education

19 Mantua Road
Mt. Royal, NJ 08061 (856) 423-2829 F:(856) 423-3420

American Board of Funeral Service Education

3432 Asland Ave., Suite U
St. Joseph, MO, 64506 (816) 233-3747 F:(816) 233-3793

American Culinary Federation Foundation

180 Center Place Way
Saint Augustine, FL 32095 (800) 624-9458
F:(904) 825-4758

American Dental Association, Commission on Dental Accreditation

211 East Chicago Avenue, Suite 1900
Chicago IL 60611-2678 (312) 440-4653

American Welding Society

550 N.W. LeJeune Road
Miami, FL 33126 (800) 443-9353

Association of Collegiate Business Schools and Programs

7007 College Boulevard, Suite 420
Overland Park, KS 66211 (913) 339-9356
F:(913) 339-6226

Association for Gerontology in Higher Education

1200 L St., NW, Suite 901
Washington, DC 20005 (202) 289-9806 F:(202) 289-9824

Association of Surgical Technologists

6 W. Dry Creek Circle #200
Littleton, CO 80120 (303) 694-9130 F:(303) 694-9169

Commission on Accreditation in Physical Therapy Education

1111 N. Fairfax Street
Alexandria, VA 22314-1488 (703) 684-2782
F:(703) 684-7343

Commission on Accreditation of Allied Health Education Programs

1361 Park Street
Clearwater, FL 33756 (727) 210-2350 F:(727)210-2354

Commission on Accreditation of Hospitality Management

P.O. Box 400
Oxford, MD 21654 (410) 226-5527 F:(410) 226-0177

Commission on Massage Therapy Accreditation

5335 Wisconsin Ave. NW, Suite 440
Washington, DC 20015 (202) 895-1518 F:(202) 895-1519

Committee on Accreditation of Education Programs for the EMS Professional

4101 W. Green Oaks Blvd., Suite 305-599
Arlington, TX 76016 (817) 330-0080 F:(817) 330-0089

Committee on Accreditation for Respiratory Care

1248 Harwood Road
Bedford, TX 76021-4244 (817) 283-2835 F:(817) 354-8519

Council for Standards in Human Services Education

Attn: John Heapes; PMB 297
1935 S. Plum Grove Road
Palatine, IL 60067

Dietary Managers Association

406 Surrey Woods Drive
St. Charles, IL 60174 (800) 323-1908 F:(630) 587-6308

Federal Aviation Administration, Airman Certification Branch

P.O. Box 25082
Oklahoma City, OK 73125-0082 (866) 878-2498
F:(312) 263-7462

Higher Learning Commission of the North Central Association

30 North La Salle Street, Suite 2400
Chicago, IL 60602-2504 (800) 621-7440 F:(312) 263-7462

HVAC Excellence

P.O. Box 491
Mount Prospect, IL 60056-0521 (800) 394-5268
F:(800) 546-3726

Indiana State Department of Health

Two North Meridian Street
Indianapolis, IN 46204 (317) 233-1325

Indiana State Board of Nursing, Health Professions Bureau

402 West Washington Street, Room W 041
Indianapolis, IN 46204 (317) 232-2960 F:(317) 233-4236

Indiana Department of Homeland Security

302 West Washington Street
Indianapolis, IN 46204 (317) 232-3980

International Association for Continuing Education and Training

1760 Old Meadow Road, Suite 500
McLean, VA 22102 (703) 506-3275 F:(703) 506-3266

International Association of Administrative Professionals

10502 NW Ambassador Drive; P.O. Box 20404
Kansas City, MO 64195-0404 (816) 891-6600
F:(816) 891-9118

International Council on Hotel, Restaurant & Institutional Education

2810 N. Parham Road, Suite 230
Richmond, VA 23294 (804) 346-4800 F:(804) 346-5009

Joint Review Committee for Educational Programs for EMT-Paramedic

7108-C South Alton Way, Suite 150
Englewood, CO 80112-2106 (303) 694-6191

Joint Review Committee on Education in Radiologic Technology

20 N. Wacker Drive, Suite 2850
Chicago, IL 60606-3182 (312) 704-5300 F:(312) 704-5304

National Accrediting Agency for Clinical Laboratory Sciences

5600 N. River Road, Suite 720
Rosemont, IL 60018-5119 (773) 714-8880
F:(773) 714-8886

National Association for Education of Young Children

1313 L St. NW, Suite 500
Washington, D.C. 20005 (800) 424-2460

National Association of Alcohol and Drug Abuse Counselors

1001 N. Fairfax St., Suite 201
Alexandria, VA 22314 (800) 548-0497 F:(800) 377-1136

National Association of Industrial Technology

3300 Washtenaw Avenue, Suite 220
Ann Arbor, MI 48104 (734) 677-0720 F:(734) 677-0046

National Association of Schools of Art and Design

11250 Roger Bacon Dr., Suite 21
Reston, VA 20190-5248 (703) 437-0700 F:(703) 437-6312

National League for Nursing Accrediting Commission

61 Broadway, 33rd Floor
New York, NY 10006 (800) 669-1656, Ext. 153
F:(212) 812-0390

**National Institute for Automotive Service Excellence/
National Automotive Technicians' Education
Foundation**

101 Blue Seal Drive SE, Suite 101
Leesburg, VA 20175 (703) 669-6600

National Organization for Human Services

6240 Old Highway 5, Suite B-5, #214
Woodstock, GA 30188 (770) 924-8899 F:(678) 494-5076



IVY TECH
COMMUNITY
COLLEGE



COLLEGE SERVICES



Entering the College

ADMISSIONS FOR NON-DEGREE ENROLLMENT

Ivy Tech offers courses in many areas. Admission as a non-degree student can be achieved simply by submitting a completed application for admission to the Office of Admissions or online at www.ivytech.edu. High school students (age sixteen or greater) may take Ivy Tech courses with the written approval of the appropriate high school official. Non-degree students enrolling in general education courses or in courses with English or mathematics pre-requisites must take the ASSET or COMPASS course placement assessment. Non-degree students taking other courses may also be required to take the assessment. Non-degree students are not eligible to receive federal or state financial aid.

ADMISSIONS FOR DEGREE ENROLLMENT

Ivy Tech is an open admissions college, accessible to all Indiana citizens past high school age. Some degree-granting programs have limited availability and have additional requirements prior to acceptance to those programs.

The College admits to certificate, technical certificate and degree programs the following:

- high school graduates, or
- recipients of the General Educational Development (GED) credential, or
- individuals 18 years of age or older who are able to benefit from Ivy Tech Community College's instructional programs.

Prospective students who are college graduates with an associate degree or higher from a regionally accredited institution may submit their college transcripts in lieu of the high school diploma. Prospective students who have some college credit may submit their college transcript if the college transcript shows the high school graduation date. The Office of Student Affairs will assist the student on request in obtaining a high school or college transcript or GED scores. Transcripts brought in need to be sealed from the high school or other postsecondary institution.

COURSE PLACEMENT ASSESSMENT

All degree-seeking students must participate in the ASSET/COMPASS assessment. The purpose of these assessments is to measure the student's achievement in mathematics, reading, and writing, and to assist the student in the selection of appropriate courses. If the assessments reveal skill deficiencies, the student will be advised to complete appropriate developmental courses. Students may be eligible for financial aid during this period. When an assessment indicates that a student would be better served in an alternative educational setting, that individual may be referred to an appropriate community resource offering the needed assistance. The applicant may re-enter the admissions process at a later date, following completion of skills upgrading. Granting substitution of the ASSET/COMPASS assessment is the responsibility of the academic officer or designee. Substitutions will be granted to students who meet one or more of the following conditions:

- Possess an associate degree or higher from a regionally accredited college with math skills at the MAT 050 level or higher and writing skills at the ENG 025 level or higher. The number of years since an associate or higher degree was earned is not relevant.
- Have completed comparable academic skills advancement or general education courses in

writing or math with a grade of "C" or better from a regionally accredited college within the last ten years. For purpose of substituting the reading portion, the prospective student must have completed a basic skills reading course or college-level general education course.

- Have comparable assessment scores (earned within the last two years) from a regionally accredited institution that are deemed acceptable by an Ivy Tech campus for appropriate course placement.
- Have SAT/ACT scores earned within the last four years that are deemed acceptable by Ivy Tech for appropriate course placement into college-level courses.

The College reserves the right to guide the enrollment of students in particular programs or courses on the basis of past academic records, academic counseling and assessment. Students seeking admission to certain health occupation programs may be requested to take part in specific pre-enrollment assessments and/or interviews to fulfill college or external agency requirements. Prerequisites may be required before enrolling in certain programs.

READMISSION FOLLOWING ENROLLMENT ABSENCE

Should a course of study at the College be interrupted more than two years, students must request readmission by contacting the Admissions Office. Information on eligibility for financial aid will be available to returning students.

LIMITED ADMISSIONS ENROLLMENT

Occasionally, the number of students admitted and enrolled in programs and/or courses may be limited by College resources or facilities—including available lab equipment and related support, or the number of available clinical work stations. The Office of Student Affairs should be contacted regarding programs which have limited access.

ADMISSION PROCEDURES AND SUPPORT DOCUMENTS—DEGREE OBJECTIVE

All prospective students pursuing an Associate of Arts, Associate of Fine Arts, Associate of Science, Associate of Applied Science, a Technical Certificate or a Certificate are required to:

1. submit an Application for Admission
2. provide one of the following:
 - A. For high school graduates:

- (1) if they are high school graduates from public schools, home schools, private schools or high school correspondence schools, provide an official high school transcript consisting of courses and grades received, graduation date, and official signature and/or seal. If the prospective student cannot provide an official transcript because the high school no longer exists and/or records are no longer available, the prospective student must provide written documentation to that effect. An Indiana certificate of completion is not the same as a high school diploma. If students have a certificate of completion, they are considered non high school graduates for purposes of admission requirements, or
- (2) if they possess an associate degree or higher, they may provide an official college transcript from a regionally accredited college indicating date of college graduation, or
- (3) if they are less than associate degree college graduates or college transfers, they may provide an official college transcript from a regionally accredited college indicating the high school from which the student graduated (transcripts from non-accredited

colleges are unacceptable).

B. For non high school graduates:

- (1) they may submit an official GED report of passing test scores from the American Council on Education (ACE) or from a recognized state education body. If the prospective student cannot provide an official score report because records are no longer available, the prospective student must provide written documentation to that effect. High school equivalency exams provided by other organizations are not acceptable, or
- (2) they may demonstrate the Ability to Benefit from postsecondary education by obtaining a passing grade on a test recognized for this purpose by the U. S. Department of Education. Students admitted to Ivy Tech under Ability to Benefit guidelines must provide an official GED report of passing test scores or a high school diploma within one calendar year of their initial date of declaration as a degree-seeking student. Students admitted under this provision who do not meet these requirements will be switched to courses-only status after a calendar year and are no longer eligible for federal, state, or institutional financial aid. A student can not graduate from Ivy Tech (technical certificate or associate degree) without proof of high school graduation or passing GED scores. Students who do not meet B(1) or B(2) should be referred to the appropriate College or community services (Adult Basic Education).

A new provision allows students without a high school diploma or its equivalent to become eligible to receive Title IV funding upon satisfactory completion of six credit hours or the equivalent coursework that are applicable toward a degree or certificate offered by the institution. Students are ineligible to receive Title IV aid while earning the six credits.

As part of the matriculation process, students may also be required to:

1. submit financial aid forms
2. comply with international student requirements
3. submit other necessary program-specific data
4. participate in initial course placement evaluation (ASSET/COMPASS)

Applicants desiring admission to some programs may be required to meet special enrollment requirements including, but not limited to, satisfactory high school grades, evidence of potential for success in the field, and/or an enrollment interview. Once a program selection is made, certain prerequisites, including, but not limited to, health examinations, drug testing, and criminal background checks, may have to be met prior to enrollment in the particular program or course

SECONDARY INITIATIVES

Dual Credit

Ivy Tech Community College of Indiana offers opportunities for high school juniors and seniors to enroll in dual credit programs that allow them to receive high school credit and advanced standing college credit at the same time. Each Ivy Tech campus has secured agreements with area high schools to offer dual credit in a variety of courses. Students should contact their school administration to learn what dual credit courses exist at their own high schools. Requirements to participate include admissions, readiness requirements for the course and course prerequisites.

TRANSFERRING CREDIT TO THE COLLEGE

The College encourages students who have previously attended other regionally accredited colleges and universities or adult education programs to forward transcripts to Ivy Tech prior to enrollment or re-enrollment for consideration of transfer of credit and/or advanced placement. Only courses with grades of C- or higher are eligible for review for credit transfer. Students are responsible for providing pertinent course descriptions and/or copies of the college catalog(s) if further documentation is needed to facilitate the review. The College will assist individuals with evaluation of prior educational experiences.

ADMISSION PROCEDURES AND SUPPORT DOCUMENTS - INTERNATIONAL STUDENTS

International students must meet College admission standards and certain other requirements. International students should apply for admission to Ivy Tech at least 90 days prior to the beginning of the term they wish to attend. International students must provide a foreign transcript equivalency evaluation from an approved evaluator indicating that the student has attained the equivalent of a US high school graduation. The following are approved College evaluation agencies: World Education Services, Educational Credential Evaluators, Inc., and AACRAO – Foreign Educational Credential Service. The type of evaluation report required by Ivy Tech is the general report. Students whose first language is not English must also demonstrate English language proficiency. The Test of English as a Foreign Language (TOEFL) with a minimum score of 550 for the written exam or 213 for the computerized version is required and results must be sent directly from Educational Testing Services (ETS) to the College. Scores will be considered if they are less than two years old. A language proficiency test may be waived if an applicant is from an English-speaking country, has completed secondary school in the US with passing grades in non-ESOL English courses, or is a college transfer student who has completed standard freshman English, with a grade of C- or higher, from a regionally accredited institution.

International students must provide proof of adequate financial support for College fees and living expenses for each year while attending Ivy Tech. International students should submit a letter from an appropriate sponsor, government official or bank official stating that sufficient funds are available to cover the cost of the student's education and that these funds will be available to the student while attending college in the United States. International students must purchase the College's insurance coverage for medical, accident and repatriation expenses, unless they obtain a waiver. Degree-seeking students must also participate in initial course placement evaluation.

STUDENT ORIENTATION

All new degree students are encouraged to participate in a student success seminar/orientation program prior to or during the first week of classes. Orientation is designed to assist students in making the transition to a college environment. Topics include registration procedures, career and employment services, financial aid, business office services, instructional programs, tutoring services, college activities, and policies and procedures.

ADVANCED PLACEMENT CREDIT AND CREDIT FOR PRIOR LEARNING

Credit by the College is granted for acceptable test results under the following programs:

College-Level Examination Program (CLEP), Advanced Placement (AP), DANTES, and tests given by Ivy Tech instructors as specific subject test-outs. Transfer credit is awarded for appropriate grades from courses taken at other regionally accredited institutions of higher learning.

Advanced standing is given to students who have met the requirements for regionally determined dual and articulated secondary and post-secondary courses.

Credit is also awarded for properly documented prior learning experiences and workforce certifications. Ivy Tech acknowledges the prior learning experiences of students by awarding credit for appropriate prior learning. Such prior experience could include but is not limited to the following: workplace learning, military experiences and training, nationally recognized testing, certifications, and community service. The awarding of credit for prior learning experiences is limited to technical coursework. General education competencies must be validated through nationally recognized testing. If program accreditation or licensure issues in certain programs preclude the awarding of PLA credit, the College will not award PLA credit for coursework in that program. If you believe you have prior learning experiences that might help you earn credit in your degree program, please contact the PLA Coordinator at the campus in which you are enrolled.

The following time limits exist for the application of credit to Ivy Tech:

CLEP and DANTEs – five years after date of test

AP – one year after high school graduation

Transfer credit – ten years after course was taken

Registration

REGISTERING FOR COURSES

The registration process includes financial aid and program advising, selection of courses and payment of fees. Newly admitted students will be notified when to register for their first classes. Specific days are set aside for registration before the beginning of each semester. Students should seek assistance in course selection from faculty advisors or advisors in the Office of Student Affairs before registering for classes. The Office of Student Affairs can supply information concerning registration.

Note: Students are registered when fees have been paid or payment arrangements have been made.

OPEN/LATE REGISTRATION

Open registration is held before the beginning of the term. Registration after the first day of classes each term is considered late. After the first week of classes a student may register only with the permission of the instructor (only for a 16-week semester). For further information contact the Office of Student Affairs.

COURSE DROP AND ADD

Students may drop a course with no record on the transcript, or may add a course in the first week of the regular (16-week) semester. Courses are not officially dropped until the necessary forms have been completed and returned to the Office of Student Affairs. After the first week of the regular semester, students must receive the permission of the instructor to add a course. All students who are not in a paid or arranged to pay status will be dropped from classes according to a set schedule. Once dropped, students may not attend class or be graded. If a student has not paid or is not current with the payment schedule by the last date for withdrawal, the student shall be withdrawn from the class, and the tuition balance is still due and payable.

STUDENT WITHDRAWAL

From the end of the second week to the end of the week marking the completion of 75 percent of

the course, a student may withdraw from a course by filing a change of enrollment form at the Registrar's Office. Records of students withdrawing from courses indicate a "W" status rather than a grade when the withdrawal process is completed. Withdrawal is complete when the necessary forms have been submitted to the Office of the Registrar. A student who ceases to attend class after the last day to withdraw will receive a grade commensurate with course requirements.

Note: Withdrawing from class may affect or cancel financial assistance. Students receiving financial assistance should check with the Financial Aid office before withdrawal from a course or courses.

College Fees

The College seeks to provide quality education at the lowest possible cost. General fees are based on the number of credit hours for which the student has registered. Out-of-state students pay an additional fee per credit hour. Students or their families may be eligible for federal tuition tax credits in accordance with the Taxpayer Relief Act of 1997.

TUITION AND FEES

Tuition and fees are determined prior to the start of the term.

Transcripts and other official College documents will not be issued if there is an account balance.

Fees are established by the State Board of Trustees and are subject to change.

Fees may be assessed for such items as consumable instructional supplies for certain classes.

Additionally, students may incur costs for textbooks, tools, uniforms, other equipment, deferral/payment plans, and special examinations.

ADDITIONAL EXPENSES

The following additional expenses may apply, depending upon the program of study:

Books: All students are expected to purchase the textbooks for their respective programs. The cost of books varies by class.

Tools: The College furnishes major equipment items for instruction. However, in many programs or courses, students must furnish additional hand tools and equipment.

Uniforms and other special equipment: Several programs require students to furnish uniforms and special safety clothing.

Charges for consumable instructional materials: In some courses an additional charge for instructional materials may be required.

PAYMENT OF FEES

All enrolled students must make arrangements at the time of registration to pay all applicable fees. A student is officially registered and allowed to attend classes when all fees have been satisfied or arrangements for payment have been made.

REFUND POLICY

Students choosing to drop a course or courses must notify the College in writing using the change of enrollment form. Students choosing to withdraw from all courses may begin the withdrawal process in writing. The fee refund for voluntary withdrawal from a class, when applicable, will be processed only after the student files a change of enrollment form with the Registrar's

Office. The Student Information System processes student refunds using the percentages noted below. Refunds are calculated on business days regardless of holidays. Technology fees, consumable fees, and tuition are refunded at the same rate noted below. With regard to the technology fee, if the student withdraws from all of his/her classes during the 100 percent refund period, the technology fee will be refunded. If the student is enrolled in any classes beyond the 100 percent refund period, the technology fee will not be refunded. For purposes of the refund period, the "first day" is calculated differently for terms of 12 weeks or more and for terms of less than 12 weeks. For terms of 12 weeks or more, the refund period would begin on Monday of the first week of classes that a particular course meets. For terms of less than 12 weeks, the refund period would begin on the first day the course meets. For terms of less than 12 weeks, if a class begins on a Saturday or Sunday, the refund period would begin on the following Monday.

Term Length	Refund Schedule
16 week	1st-10th day 100%
12-15 week	1st-8th day 100%
10-11 week	1st-6th day 100%
8-9 week	1st-5th day 100%
4-7 week	1st-2nd day 100%
Less than	4 weeks 1st day 100%

Financial Aid

Ivy Tech participates in various types of federal and state financial aid programs that provide assistance to many students. Ivy Tech also provides financial assistance to students from its own resources. Students are encouraged to carefully explore all financial aid options at their campus. Students must complete the Free Application for Federal Student Aid (FAFSA) to be considered for any form of financial aid. This form is available online at <http://www.fafsa.ed.gov>. Financial aid is available for both full- and part-time students regardless of age, race or sex. To qualify for financial aid all applicable requirements must be met. For federal and state financial aid programs students must:

- Be a regular student enrolled or accepted for enrollment in an eligible program;
- Not be enrolled in secondary school;
- Be a U.S. citizen or national or permanent resident;
- Maintain satisfactory academic progress in a course of study;
- Not owe a refund to a federal grant or loan program.

Students who have completed the FAFSA and submitted all required documentation will receive an email notification to their college email address asking them to check Campus Connect self-service for details on their award.

Information on all financial aid programs, commonly asked questions, Title IV school codes, financial aid forms, financial aid contacts, and awarding and disbursement policies are available online at www.ivytech.edu/financialaid

The following are financial aid programs:

- Federal Pell Grants
- Academic Competitiveness Grant
- Federal Supplemental Education Opportunity Grants

- Federal Work Study
- Federal Stafford Loans
- Federal Parent Loan for Undergraduate Students
- Frank O'Bannon Awards
- Part-time Grant
- Child of Disabled Veteran Awards
- Veteran's Benefits
- Indiana National Guard Supplemental Grants
- 21st Century Scholar Awards
- Ivy Tech Foundation Scholarships

For priority consideration for state assistance (SSACI), the FAFSA must be received by the federal processor after January 1 but on or before March 10 preceding enrollment for the following fall semester. Otherwise, students may apply at anytime during the school year. However, students are encouraged to apply at least 4 weeks prior to the enrollment for the term they wish to attend.

Application Procedures for Financial Aid

Students may apply on-line at www.fafsa.ed.gov. Because application procedures, deadlines, eligibility regulations and refund policies vary with different types of student aid programs, interested students are encouraged to contact the Financial Aid Office at their earliest opportunity. Applying on-line is faster and easier than using a paper FAFSA. Students should allow two weeks for electronic applications or six to eight weeks for processing paper financial aid. In lieu of filing the FAFSA online or mailing in a paper FAFSA, students and parents can call the Federal Student Aid Information Center (FASIC) and file by phone 800-4-FED-AID.

Student Records

Ivy Tech maintains an educational record for each student who is or has been enrolled at Ivy Tech. In accordance with the Family Educational Rights and Privacy Act of 1974, as amended, the following student rights are covered by the act and afforded to all students at Ivy Tech:

1. The right to inspect and review information contained in the student's educational records.
2. The right to challenge the contents of the student's educational records.
3. The right to a hearing if the outcome of the challenge is unsatisfactory.
4. The right to submit an explanatory statement for inclusion in the educational record if the outcome of the hearing is unsatisfactory.
5. The right to prevent disclosure, with certain exceptions, of personally identifiable information.
6. The right to secure a copy of the institutional policy.
7. The right to file complaints with the Department of Education concerning alleged failures by Ivy Tech to comply with the provisions of the act. The name and address of the office that administers FERPA is: 1 Family Policy Compliance Office, U.S. Department of Education, 400 Maryland Avenue, SW, Washington, DC 20202-4605.

Each of these rights, with any limitations or exceptions, is explained in the Student Affairs Policy and Procedures Manual, a copy of which may be obtained in the Office of Student Affairs or the library.

At the College's discretion directory information may be provided in accordance with the provisions of the act without the written consent of the student unless the student requests in writing that such information not be disclosed (see below). The items listed below are designated as directory information and may be released for any purpose at the discretion of Ivy Tech unless a request for non-disclosure is on file.

1. Name, address, e-mail address, telephone number, dates of attendance, enrollment status
2. Previous institution(s) attended, major field of study, awards, honors, degree conferred.
3. Past and present participation in officially recognized activities, date and place of birth.

Students may request the withholding of directory information by notifying the Registrar's Office in writing, specifying the categories to be withheld, within ten (10) calendar days from the first scheduled day of the term. Ivy Tech will honor the request for one term only. Therefore the student must file the request on a term basis. The student should carefully consider the consequences of any decision to withhold any category of directory information. Regardless of the effect upon the student Ivy Tech assumes no liability for honoring a student's request that such information be withheld. Failure on the part of a student to request the withholding of specific categories of directory information indicates the student's approval of disclosure.

In addition, student records are held in security by the College. Transcripts on file with the College from high schools and other institutions of higher education cannot be released by Ivy Tech. A student needing a transcript from high school or another college should request it directly from that institution. The Registrar's Office will assist students wishing to see and review their academic records and student files. Any questions concerning the student's rights and responsibilities under the Family Educational Rights and Privacy Act should be referred to the Office of the Registrar.

DEPENDENCY PROVISION

Ivy Tech reserves the right, as allowed under the Federal Educational Rights and Privacy Act of 1974, to disclose educational records or components thereof without written consent to parents of dependent students as defined according to the Internal Revenue Code of 1954, Section 152 (as amended). A certified copy of the parent's most recent federal income tax form establishing the student's dependency status shall be required before any educational records or components thereof will be released to the parent of any student.

Academic Grading

The academic grading system has both grades and status codes, both of which are explained in greater detail later in this section. Grades reflect the quality of performance and level of competency achieved by students who complete a course. Formal grades are assigned at the end of each enrollment period. Instructors determine and assign grades and status based on objective appraisal and evaluation of the student's performance. Semester grade reports are available on the web and by phone.

In all courses the quality of the student's work determines the grade earned. For some courses quantity of work, speed of work, or both also are considered in determining the grade. Class par-

ticipation also may be considered by instructors in awarding grades. In certain instances a status code appears on the student's record in place of a grade. Status represents a condition to which no letter grade can be assigned.

GRADES

The quality of student performance or competency level, as determined by the instructor at the completion of a course, is indicated by a letter grade of A, B, C, D or F. Ivy Tech does not use pluses and minuses as a part of its grading system. Each designation has a numerical value per credit hour, referred to as "quality points." The meaning and quality point value per credit hour of each letter grade are shown in the table below:

STATUS	QUALITY POINTS/CREDIT HOUR
A Excellent	4
B Good	3
C Average	2
D Below Average	1
F Failure	0

Academic skills advancement courses are assigned grading designations, but no quality points or quality hours are earned. Grades for academic skills advancement courses are preceded by the letter "S."

STATUS CODES

Status codes describe the state or condition of a course on the student's record for which a grade has not been awarded. Status code indications carry no quality points. The types of status codes and the symbols used to indicate them are shown below:

Status

I	Incomplete
AU	Audit
S	Satisfactory
U	Unsatisfactory
V	Verified Competency
W	Withdrawal

These status codes are used for the following reasons:

I—Incomplete

"I" designations are received by students who have actively pursued a course and are doing passing work at the end of the course but who have not completed the final examination and/or other specific course assignments.

To remove an "I" designation, a student must meet with the instructor and make arrangements to complete course requirements in a specified period not to exceed 30 days beyond the start of the following term. The instructor must submit the grade within 31 calendar days of the beginning of the following term in which the student received the "I" designation.

AU—Audit

"AU" status indicates enrollment in a course for which no grade or credit is awarded. The fees for audited courses are the same as those for courses taken for credit. Audit status must be declared

no later than the end of the first week of classes with approval of the instructor or program chairperson.

W—Withdrawal

A "W" status code will be used for student and academic withdrawals. Student withdrawal (W) is a status referring to voluntary student withdrawal beginning at the start of the third week of the course for a 16-week semester up to the end of the week marking the completion of 75 percent of the course. To be considered officially withdrawn from a course the student must file change of enrollment form with the Office of the Registrar. After 75 percent of the term has elapsed a student may withdraw (with the same result as indicated above) only if documented extenuating circumstances are submitted to and approved by the Chief Academic Officer or his/her designee.

S—Satisfactory

The "S" indicates satisfactory completion of course work in situations where either a status of satisfactory or unsatisfactory (pass/fail) has been arranged by prior agreement. Requests for this type of grading must be declared at time of registration. Courses graded with an "S" do not count toward graduation requirements.

U—Unsatisfactory

The "U" indicates unsatisfactory completion of course work in situations where either a status of satisfactory or unsatisfactory (pass/fail) has been arranged by prior agreement. Requests for this type of grading must be declared at time of registration. The "U" differs from an "F" in that quality points are not computed.

V—Verified Competency

The "V" indicates satisfactory completion of course work in situations such as test-out, credit for prior learning experience or training, College Level Examination Program (CLEP), etc. Credit gained through this method may be used to satisfy degree requirements. This status is approved by the Chief Academic Officer upon recommendation of a faculty advisor following completion of necessary verification and documentation of competency.

CREDIT HOURS

Credit is described in semester hours (the number of credits taken per semester). The number of credits is determined by the demands of the course, course work and by the number of contact hours - the hours actually spent in the classroom or laboratory.

CREDIT HOURS/LOAD

A credit hour represents one hour of lecture, two hours of laboratory, three hours of clinical/practicum/studio, or five hours of internship instruction per week for the semester. A three-credit-hour lecture course, for example, meets 48 hours during a 16-week semester (3 hours/week x 16 weeks). An average full-time semester class load in most Ivy Tech programs consists of 12-15 credit hours. A class load of more than 18 credit hours requires approval of the Chief Academic Officer or designee.

ENROLLMENT STATUS

Enrollment status for the fall and spring semesters is determined by registered total semester credits:

Full-time student	12 or more credits per semester
3/4 time	9-11 credits per semester
1/2 time	6-8 credits per semester

Less than 1/2 time 1-5 credits per semester

A first-year student, by definition, is one who has completed 30 or fewer semester credit hours.

A second-year student is one who has completed 31 or more semester credit hours.

For the summer period, enrollment status for Title IV financial aid and for all other purposes is as follows:

FINANCIAL AID	ALL OTHER PURPOSES	
Full-time	12 credits	6 credits
3/4 time	9-11 credits	4-5 credits
1/2 time	6-8 credits	3 credits
Less than 1/2 time	1-5 credits	1-2 credits

QUALITY POINTS

Quality points are numerical values indicating the quality of student performance in credit courses: A=4; B=3; C=2; D=1; F=0. The quality points earned for a course equal the quality point value times the number of credits. A student who earns an "A" in a four credit course earns 16 quality points: the quality point value (4) x the number of credits (4) = the total quality points (16).

GRADE POINT AVERAGES

The grade point average (GPA) is a numerical indication of the student's performance in all courses in which quality points can be earned. The GPA is calculated by dividing the number of quality points earned by the number of credits earned. The term and cumulative GPA, calculated to three decimal places, will appear on the online grade report as well as on the transcript.

Under extenuating circumstances a student may petition the Chief Academic Officer to exclude coursework from the cumulative GPA calculation. Courses excluded from the cumulative GPA calculation as a result of a petition will not be counted as earned and cannot be used to satisfy program requirements for degree-seeking students. Grades for excluded courses will remain in the student's term GPA, and the courses will continue to appear on the transcript, however the cumulative GPA will reflect the exclusion of the coursework. Contact the Office of Student Affairs for additional information.

IMPROVING A GRADE

Students may attempt to improve grades by repeating courses (allowable once per course). Financial aid recipients, however, should review their situations carefully since payment for repeated courses can be disallowed. Student transcripts will contain a complete record of all activity. The student's grade point average will reflect the highest grade earned.

DEAN'S LIST

The Dean's List, prepared and published each term, gives recognition to degree-seeking students who achieve a minimum 3.50 grade point average in non-academic skills advancement courses with no Ds or Fs while earning six or more Ivy Tech credits during the semester and have earned at least a total of 12 non-academic skills advancement credits during their course of study.

GRADE REPORTS

Grade reports are available on the web via Campus Connect and by phone via STARS. A student may also request a copy of the academic transcript from the Office of the Registrar, which lists all

coursework attempted at Ivy Tech.

PRIOR COURSEWORK

Credits taken more than ten years prior must be reviewed by the Vice Chancellor for Academic Affairs to be applied to a degree or certificate objective. This policy applies to credits accepted in transfer from another institution and to credits taken at Ivy Tech prior to declaring the new degree or certificate objective to which the credits may apply.

ATTENDANCE

Regular attendance is expected at scheduled class meetings or other activities assigned as part of a course of instruction. Attendance records are kept by instructors. When personal circumstances make it impossible to attend scheduled classes and activities, the College expects students to confer with instructors in advance. Instructors can offer students the option of making up the material missed.

Absences may be considered by instructors in awarding grades and considering involuntary withdrawal. Students who must interrupt their Ivy Tech education to fulfill Reserve and National Guard annual tour requirements should present official military orders to their instructors prior to departure for duty. Students are not excused from completion of the course work and should make arrangements with their instructors to complete all work.

Standards of Progress

A student who has declared a degree or certificate objective and has 15 or more cumulative quality hours must maintain a 2.00 minimum cumulative GPA to be considered in satisfactory academic standing.

Academic Monitoring - A student who has a GPA under 2.00 after attempting six or more quality credit hours is selected for Academic Monitoring for the following term.

Academic Probation - If the student does not achieve a 2.00 cumulative GPA by the time he/she completes fifteen (15) quality credit hours, he/she will be placed on Academic Probation.

A student who does not achieve the minimum cumulative GPA of 2.00 for 15 or more semester quality hours earned at the end of each term will be placed on Academic Probation for the following term. The student will be able to enroll for the first term on Academic Probation with the understanding that he/she must raise the minimum cumulative GPA by the end of that term.

If a student has not maintained a minimum of 2.00 cumulative GPA but has earned a minimum of 2.00 for the term, the student will remain on continued Academic Probation.

Academic Suspension - A student on Academic Probation who does not meet Standards of Progress and does not improve by the end of the first term on Academic Probation will not be allowed to register as a degree-seeking student for the following two terms unless satisfactory academic progress is restored. (No improvement means that the student has not achieved the applicable minimum cumulative GPA required in accordance with the Academic Standards Policy or has not successfully attained a minimum 2.00 GPA for the probationary term.)

After two terms on academic suspension, a student may reenroll as a degree-seeking student on a probationary status. A student on academic suspension from a limited enrollment program must reapply for admission to that program.

Academic Termination - After reenrollment on probationary status, a student who does not maintain standards of progress for the term is terminated for three years as a degree-seeking student.

Termination from one campus constitutes termination from the College. Petitions for readmission can be initiated at the campus where the student intends to enroll. Satisfactory academic progress is restored when a student successfully re-establishes a 2.00 cumulative grade point average.

A student determined not to be making academic satisfactory progress in accordance with guidelines may appeal to the Regional Academic Officer or designee/Student Status Committee.

The College may elect to address individual mitigating circumstances administratively, with appropriate documentation to justify continuation of academic eligibility. The student may always exercise his/her right of due process.

Students receiving financial aid must demonstrate satisfactory progress toward completion of a program within a specified time frame based on their enrollment status. Students also must successfully complete the minimum number of credit hours required for that status each semester. All students are expected to maintain a minimum of a 2.00 cumulative GPA to be eligible for graduation. Questions about standards of progress and academic standing should be addressed to the Office of Student Affairs.

For more information on meeting satisfactory academic progress for students receiving financial aid, please visit www.ivytech.edu/financialaid/awards-and-policies.html.

SPECIAL PROBLEMS

The Office of Student Affairs is available to help with special problems, exceptional circumstances, and filing grievances (see Student Grievances). Special problems, exceptional circumstances, and grievances are ultimately the responsibility of the Chief Administrative Officer of the region, designated staff and committees.

Assessment

Assessment is a tool that supports the College mission to prepare Indiana residents to learn, live, and work in a diverse and globally competitive environment. A college-wide assessment plan has been developed to measure students' academic success. The plan reflects the College's commitment to enhanced student learning from initial evaluation for course placement through outcomes assessment and subsequent institutional improvement that occurs as a result of these activities.

Initial Placement

Students take ASSET or COMPASS assessments to determine placement into appropriate courses.

Technical Outcomes

Technical learning is assessed at or near the end of their programs to determine how well they demonstrate knowledge and skills required to be successful in their chosen fields. The methods used to assess technical skills vary by program. Some are assessed with established industry-recognized instruments, college-developed instruments, portfolios and other means appropriate to

General Education Outcomes

The College has identified eight general education outcomes designed to provide students with the tools to be productive, responsible citizens and lifelong learners. The general education outcomes are:

- 1) Demonstrate critical and creative thinking.
- 2) Recognize and understand cultural and individual differences, in terms of both contemporary and historical perspectives.
- 3) Recognize and understand social, political, civic, and environmental responsibilities relative to our society.
- 4) Apply basic scientific concepts in a variety of settings.
- 5) Communicate effectively in written, oral and symbolic forms.
- 6) Exhibit quantitative literacy.
- 7) Apply ethical reasoning.
- 8) Demonstrate the acquisition and use of information.

General education outcomes are assessed at or near the end of the student's program in the capstone course. Students' level of performance is compared with community college students nationally. Students who score above the national average receive a certificate for use in their professional portfolios. Individual assessment results are also compared with student's initial assessment to determine whether the students' learning improved during their time at the College.

Assessment results are reviewed and analyzed by College faculty, staff and administrators. The results are used to inform changes or improvements in curriculum, academic support services, College procedures, etc. Ongoing assessment and evaluation enable the College to ensure high quality teaching and learning and effective academic and student support systems.

Graduation

The Associate of Arts, Associate of Fine Arts, Associate of Science, Associate of Applied Science degrees, Technical Certificates and Certificates are awarded by the College to students who meet graduation requirements. Graduating students may be charged a fee to cover the cost of the ceremonial cap and gown. A student is considered eligible for graduation when requirements for graduation have been fulfilled. Each student entering the final semester prior to graduation who wishes to participate in the ceremony must complete an application for graduation. The application will be certified by the student's program advisor and forwarded to the Registrar's Office where the appropriate diploma will be prepared. Graduating students will participate in outcomes assessments. To graduate with an Associate of Arts degree, an Associate of Fine Arts degree, an Associate of Science degree, an Associate of Applied Science degree, a Technical Certificate, or a Certificate, the student must:

1. Attain a minimum grade point average of 2.00 in the required technical and general education courses;
2. Completion of at least 15 degree credits in the curriculum as a regular student of Ivy Tech, and not through test-out or other means of advanced placement;
3. Successfully complete the required number of credits;

5. Satisfy all financial obligations due the College; and
5. Satisfy program accreditation standards that may have additional requirements.

Transferring to Another Institution

Ivy Tech has articulation agreements under which students may transfer individual courses or entire programs of study to a number of public and private institutions. A student, depending on his or her goals, may choose to transfer to another college or university and pursue a bachelor's degree after completion of a series of courses or completion of a two-year degree program at Ivy Tech. Some of these agreements are collegewide and some pertain to specific campuses of Ivy Tech.

The selection of an institution for transfer should be an individual decision based upon the extent to which credits will transfer, compatibility of degree programs, location, availability of programming, philosophy, and cost of attending the transfer school. Opportunities are available to Ivy Tech students to transfer and complete a baccalaureate program as a resident or commuting student.

Opportunities are available to pursue a bachelor's degree using distance technologies which will allow a student to complete a degree program within the ir community, even at an Ivy Tech campus.

Students are encouraged to review transfer options with their advisors, to consult the current catalog of the institution to which they wish to transfer, and to contact the institution to which they wish to transfer. Information about statewide program transfer is included with many programs in this catalog. Additional opportunities for course and program transfer with both public and independent colleges and universities are available. Students should contact the transfer office of their local Ivy Tech for further information.

TransferIN

Courses marked with "TransferIN" after the title are part of the Indiana Core Transfer Library. Indiana is working to help you transfer college credits more easily. To enable students to connect college credits, Indiana has developed the Core Transfer Library (CTL) — a list of courses that will transfer among all Indiana public college and university campuses, assuming adequate grades. Core Transfer Library courses will meet the general or free elective requirements of undergraduate degree programs and most CTL courses will also count towards degree program requirements, if an equivalent course is taught at your new campus. For more information about the Core Transfer Library, and for the most up-to-date course list, go to www.transferIN.net.

Student Support Services

ACADEMIC SKILLS ADVANCEMENT PROGRAM SERVICES

To ensure that every student has the opportunity to be successful, Ivy Tech offers an Academic Skills Advancement program. This developmental program is designed for students enrolled in programs or courses at the College who are encountering academic difficulty or who have been identified as having encountered academic difficulty in the past. Services provided through the Academic Skills Advancement program include diagnostic testing and assessment, course placement services and instruction.

The need for these services may be identified at the time of admission. However, a student may use any or all services upon encountering academic difficulty during a course of study. Academic skills advancement instructors and laboratory technicians provide developmental instruction in

the areas of math, communications, sciences, writing and study skills. Some campuses offer GED preparation and English to speakers of other languages (ESOL). Delivery of instruction may be in the form of an academic skills advancement course in a classroom setting, one-on-one tutorial assistance, computer-based instruction or a self-paced study in the academic skills center. For further information about the College's Academic Skills Advancement program contact the Office of Student Affairs or the academic skills center.

ACADEMIC ADVISING

Academic Advisors are committed to engaging students in intentional, collaborative, supportive, and meaningful partnerships. Grounded in teaching and learning, Academic Advisors will assist students in achieving their personal, educational, cultural, and career goals while becoming self directed, life-long learners. Academic advising begins with orientation and continues through a series of meetings each semester during the student's first year. Students are assigned to an academic advisor depending on the student's area of interest and the advisor's area of expertise. Academic advising means that students must meet with their academic advisor or faculty advisor before registering for classes.

Academic advising will help students to:

1. Successfully access and navigate higher education.
2. Clarify life and career goals.
3. Develop goal-oriented educational plans.
4. Interpret academic requirements and select appropriate courses.
5. Access available internal and external resources that enhance their education.
6. Identify other experiences that will enhance their life, educational, and cultural goals.
7. Develop critical thinking, decision-making, and independent learning skills.
8. Evaluate their progress toward career and life goals, degree completion, and transfer.

CAREER SERVICES

Career Services provides many types of services to all students, graduates, and alumni, including: career exploration, resume writing preparation, career fair information and assistance in finding employment while in school and upon graduation. Students, graduates, and alumni interested in assistance with job search strategies may register with their local Career Services office. Upon registration, Career Services staff will:

1. Advise candidates of the College's career services.
2. Provide occupational information including employment trends and local and state occupational outlook data.
3. Assist the registered candidate in preparing a packet of credentials for use in finding a job. This packet may include:
 - a. A resume of the candidate's education and employment experience, and
 - b. Personal letters of recommendation verifying the student's employability.
4. Create and maintain folders containing original copies of the candidate's credentials for all registered candidates.
5. Prepare copies of credentials used by the candidates for referral to prospective employers.

Alumni may update their credentials whenever they wish to use the Career Services Office. Students or alumni registered with the Career Services Office will be informed of employment opportunities know to the Career Services Office. These opportunities are also posted on campus job boards and online. JobZone (<http://www.ivytech.edu>) is the Ivy Tech online resume referral system. Employers can post positions and students can post resumes at no cost. Local job postings as well as statewide listings can be accessed through JobZone. Employers who register with the Career Services Office are granted access to JobZone and are provided with the names of all qualified candidates without regard to gender, race, age, national origin or disability. Registered students or alumni are eligible for interviews with appropriate prospective employers. See the Career Services office for additional information or visit www.ivytech.edu.

COLLEGE BOOKSTORE

Each campus maintains a bookstore where students may buy textbooks and supplies.

LIBRARY

Libraries at each campus provide access to materials, information and services that support students' educational needs. In addition libraries have career exploration materials, interlibrary loan services, general and technical periodicals, recreational reading, and audio-visual materials and equipment. In addition to print materials the College provides a variety of online databases, many of which are full-text, that are available to students at all campuses.

DISABILITY SUPPORT SERVICES

Reasonable accommodations for persons with disabilities will be made to ensure access to academic programs, services, and employment in accordance with section 504 of the Rehabilitation Act of 1973 and the Americans with Disabilities Act of 1990. College programs and facilities are designed to be accessible to students with disabilities. Each campus has designated parking and special restroom facilities for persons with disabilities. Disability Support Services also will aid students with disabilities with career planning, financial aid and placement. The College staff works with the Department of Vocational Rehabilitation and other service agencies to assist students with disabilities through available local community resources.

It is the student's responsibility to contact the campus Disability Services representative to request accommodations; any information shared will be kept confidential unless the student authorizes release and exchange of specified information. Requests for accommodations and documentation of disability must be received one month prior to enrollment for the next academic term. Additional time may be required for some requests. Every effort will be made to provide reasonable accommodations in a timely manner.

Student Life

ORGANIZATIONS AND ACTIVITIES

The College recognizes the educational, recreational and social values of student organizations and extracurricular activities. Students are encouraged to participate in any or all phases of the student activities program as long as participation does not interfere with studies. All student organizations operate under the policies and guidelines set for the College by the State Board of Trustees. Approval by the Student Government and the administration is required of all student organizations seeking to make use of College facilities. All approved organizations must be open

for membership to all eligible candidates and must make available to the Student Government records of officers, membership and financial transactions.

STUDENT GOVERNMENT ASSOCIATION (SGA)

Students in each region are provided opportunities to participate in student organizations through the Student Government Association (SGA). SGA is the representative governing body of the students. SGA representatives are elected or selected according to the by-laws of each regional SGA constitution and serve as stated in those bylaws. The student body membership may consist of representatives of each program area and an advisor as established in the by-laws.

SGA was established by students to encourage participation in SGA and to promote College spirit and recognition. SGA exercises the authority, unless otherwise delegated, to legislate on student matters subject to the approval of appropriate College administrative offices. The constitutions of all student organizations must be approved by a quorum of the SGA, consisting of a simple majority of the total membership and one staff advisor, or as otherwise stated in the by-laws.

The functions of SGA include:

1. Communication of bona fide concerns of the student body to appropriate College officials with suggestions for improvement.
2. Approval of student organizations beneficial to student life and worthy of being part of the College.
3. Assurance that copies of the constitution, by-laws and statement of purpose and objectives of each recognized student organization are on file in the Office of Student Affairs.
4. Referral of student grievances to the appropriate College officials.
5. Planning and conducting appropriate and socially responsible extracurricular student activities.
6. Submission of student activity budgets for review and approval by the regional administration.

PHI THETA KAPPA

Phi Theta Kappa is a national honor fraternity for two-year colleges. Its purpose is to recognize and promote academic excellence. This is done by providing leadership development opportunities for service in chapter activities on campus and in regional Phi Theta Kappa activities. Membership in Phi Theta Kappa is by invitation only and is based on a minimum grade point average as well as completion of a specified number of semester hours. Contact the Office of Student Affairs for further information.

INTRAMURAL SPORTS

College sports activities consist of intramural sports sponsored by the Student Government Association (SGA). Leagues can be formed when student interest justifies their organization. All College sports activities must be approved and sponsored by SGA and the administration.

CLUBS

Students wishing to organize hobby, social or special interest clubs should submit proposals to the Student Government Association (SGA), which will determine whether sufficient interest exists. SGA is authorized to charter clubs upon approval by the administration. Each club must have a president and vice-president, a full-time employee or regional administrative approved

part-time position acting as advisor, and a constitution and by-laws.

SOCIAL ACTIVITIES

All group activities of the College must be approved and sponsored by the Student Government Association (SGA) and the administration. Classes, clubs and other groups should plan and conduct social activities for their members. SGA organizes and conducts social activities and gatherings in which all students are encouraged to participate, and to which many will be open to guests.

PROFESSIONAL ORGANIZATIONS

Student chapters of various professional organizations are formed in the same manner as other student organizations and are subject to the same requirements.

LEADERSHIP DEVELOPMENT

The College sponsors a Student Leadership Academy, a seven-month-long experience to help students better understand the roles of leaders and the leadership potential that exists in everyone. Students must apply to join the Leadership Academy. Contact the Office of Student Affairs for further information.

COMMUNITY SERVICE

Community service is an important aspect of becoming a well-rounded citizen. Community service occurs through classroom activities, student government, student clubs and organizations, and partnerships with community agencies. Please check with the student government office for volunteer opportunities.

IVY TECH ALUMNI ASSOCIATION

Many of the regions have established chapters of the Ivy Tech Alumni Association. Membership in the association is open to current and former students. Contact the Office of Student Affairs for further information.

E-MAIL

Each student has an Ivy Tech e-mail address via the Campus Connect college portal. Since departments and instructors will be communicating with you via your college e-mail account, it is important that you can access the account without difficulty. Students who do not use their Ivy Tech e-mail accounts may miss information from the College that is vital to their success. Official College notices and helpful information will be provided to you through your Ivy Tech e-mail. Ivy Tech will use your Ivy Tech e-mail account to notify you of changes in your accounts, in your courses, and in college policies and procedures. You are responsible for the information and notices that are sent to you via your assigned e-mail account. It is suggested that you set your web browser to Campus Connect and check your account every day. The Student Computing Practices are included on the site.

CAMPUS CONNECT: THE COLLEGE PORTAL WEBSITE

Campus Connect is available at <http://cc.ivytech.edu>. All Ivy Tech students are given an account to this intranet which provides information, communication tools, and access to online College services. Students may register for and drop/add courses as well as view grades, holds, transcripts, financial aid, and other information. Along with targeted campus announcements, students access their web-based, e-mail accounts via the portal. On the Courses tab, users can access course materials, including Internet courses, by clicking the eLearning logo.

Group web pages within Campus Connect are available for any sanctioned group on campus. Group web pages are either public (open to anyone) or private (selective admission) and are maintained by a group leader. Group Leaders may delegate portions of the site's maintenance responsibilities to other group members. For more information, visit the Campus Connect website.

Housing

Ivy Tech is a commuter college and does not operate residence halls. However, the Office of Student Affairs may be able to respond to questions concerning housing in the community. Ivy Tech accepts no responsibility for locating, approving or supervising local student housing.

Student Parking

As part of registration, some campuses require students to register their motor vehicles and obtain a parking sticker. A special permit is required to park in spaces for persons with disabilities. Stickers are to be displayed in the vehicle while parked on campus, and students may park only in designated student parking areas. Vehicles improperly parked in areas reserved for the disabled, visitors or others may be towed at the expense of their owners.

Student Accident Insurance

For students registered in credit courses, the College provides accident insurance in a designated amount for injuries sustained while participating in College-sponsored activities. The activity must take place on College premises or on any premises designated by the College. Students are also covered while traveling to and from College-sponsored activities as a member of a group under College supervision. It is the student's responsibility to report injuries promptly to the instructor or to the Office of Student Affairs. The insurance is for a specified minimum amount of coverage. It is not intended to replace insurance coverage students may already have. Students should review their own coverage. The master insurance policy issued to Ivy Tech is on file at the central administrative office. The description of the hazards insured, benefits and exclusions is controlled by the master policy. Students with questions may contact the regional Office of Student Affairs.

Student Health Insurance

The College has made arrangements for Ivy Tech students to obtain health insurance. Insurance coverage is purchased directly from the insurance company by the student. Application forms and brochures explaining coverage and rates are available through the Office of Student Affairs during registration periods. Coverages and rates are subject to change.

Accidents and Illnesses

If a student has an accident on College property the student should report the accident to campus security or the Office of Student Affairs. If a student suffers an accident or illness while attending classes the student should notify the instructor. The College will take the necessary steps to inter-

vene in a medical emergency while the student is on campus. If paramedic services or hospitalization is required the student is financially responsible. If a student is suffering from an illness that makes it impossible to attend classes the student should contact his/her instructors.

The College does not provide a health services center. The College supports the Drug Free Schools and Communities Act of 1989. Many community agencies are available to assist students seeking counseling or treatment. Please contact the Office of Student Affairs for a listing of community resources. The College conducts a biennial review of the effectiveness of its drug and alcohol abuse prevention programs. This review is available in the Office of Student Affairs.

Voter Registration

Students are strongly encouraged to exercise their right to vote. In order to vote in national, state or local elections one must be a registered voter at the person's current address. Students who need a voter registration form due to either not having previously registered or having moved can pick up a voter registration form at the Office of Student Affairs. Forms can also be downloaded from the Indiana Secretary of State's office at www.in.gov/sos/forms/index.html. Under the "Elections" section, select form VRG-7i. A Spanish-language version is also available.

Emergency Closings of Campuses

Severe weather conditions or other emergencies occasionally make it necessary to close a campus. Each campus has designated local radio stations to announce information on closings.

Student Rights and Responsibilities

STUDENT CONDUCT

The College is committed to academic integrity in all its practices. The faculty value intellectual integrity and a high standard of academic conduct. Activities that violate academic integrity undermine the quality and diminish the value of educational achievement.

The reputation of the College and the community depends in large part upon the behavior of its students. Students enrolled at the College are expected to conduct themselves in a mature, dignified and honorable manner. Students are entitled to a learning atmosphere free from discrimination, harassment, sexual harassment and intimidation. This applies to the conduct between faculty and staff to students, student to student, and students to faculty and staff.

Students are subject to College jurisdiction while enrolled at the College. The College reserves the right to take disciplinary action against any student whose conduct, in the opinion of College representatives, is not in the best interests of the student, other students, or the College. Students who are disciplined should expect to find their sanctions enforced at other Ivy Tech campuses. All students are expected to abide by the following College rules of conduct. "Student" as used refers to a student, a group of students, a prospective student or a group of prospective students.

COLLEGE RULES

1. Academic Integrity

Faculty are responsible for maintaining the academic integrity of the institution. Academic integrity is expected of all students and faculty.

Ivy Tech recognizes academic integrity as a fundamental principle of collegial life. The credibility of the College's educational programs rests upon the foundation of student learning and integrity. Students who misrepresent their academic work violate the rights of their fellow students and undermine the faculty's authority and their ability to assess learning. The College therefore views any act of academic dishonesty as a serious offense requiring disciplinary measures, including failure for the exam or specific course work, course failure, suspension, and expulsion from the College. In addition, an act of academic dishonesty may have unforeseen effects and lead to formal processes outside the College.

Definitions: Violations of academic integrity include, but are not limited to, the following acts:

Cheating: Unauthorized use of notes or study aids, or acquiring information from another student's papers, on an examination; or obtaining a copy of an examination or questions from an exam prior to taking the exam; or altering graded work with the intent to deceive by resubmitting it for re-evaluation; or altering or destroying grade records; or allowing another person to do one's work and then submitting as one's own name; or allowing another to take an examination in one's name; or submitting identical or similar papers for credit in more than one course without obtaining prior permission from the instructors of all the courses involved.

Aiding Cheating or Other Acts of Academic Dishonesty: Providing material or information to another student with the knowledge that this material or information will be used to deceive faculty in an effort to acquire higher grades.

Plagiarism: Presenting within one's own work the ideas, representations, or words of another person without customary and proper acknowledgment of that person's authorship is considered plagiarism. Students who are unsure of what constitutes plagiarism should consult with their instructors. Claims of ignorance will not necessarily excuse the offense.

Data Misrepresentation: Fabricating data; deliberately presenting in an assignment data that were not gathered in accordance with assigned guidelines or are deliberately fabricated; or providing an inaccurate account of the method by which the data were gathered or generated.

Falsification of Academic Records or Documents: Falsification of academic records or documents includes but is not limited to altering any documents affecting academic records; forging signatures; or falsifying information of an official academic document such as a grade report, ID card, library card, or any other official College letter or communication will constitute academic dishonesty.

Unauthorized Access to Computerized Academic or Administrative Records or Systems: Unauthorized access to computerized academic or administrative records or systems means viewing or altering the College's computer records without authorization; copying or modifying the College's computer programs or systems without authorization; releasing or dispensing information gained through unauthorized access; or interfering with the use or availability of computer systems or information. Also, when college-sponsored activities are held at locations owned or managed by other institutions or organizations, the unauthorized use, viewing, copying, or altering of those institutions' computer

records, systems, or program would similarly constitute a violation of academic integrity.

- Assembly:** College policy states that assembly in a manner that obstructs the free movement of others about the campus, inhibits the free and normal use of the College buildings and facilities, or prevents or obstructs the normal operation of the College is not permitted. Obstruction of the free flow of pedestrian or vehicular traffic on College premises or at College-sponsored or supervised activities is included in the definition of obstruction.
- Children on Campus:** Due to insurance and security purposes, children are not allowed to be on Ivy Tech property without direct supervision by parent or guardian, with the exception of childcare centers. Children are not allowed in classrooms unless through the expressed consent of the instructor.
- Commitment of College Funding:** Committing College funding, including student clubs or organizations, without written approval and paperwork will result in the student being responsible for the money owed, the student being removed from the club or organization, and disciplinary action being evoked. No student shall enter into a contract with an outside agency using the name of the College. Contracts entered into in violation of this rule shall be the personal responsibility of the student.
- Compliance and Identification:** Students who fail to comply with direction of College officials or law enforcement officers in the performance of their duties and/or fail to identify themselves to these persons when requested to do so are subject to disciplinary sanctions.
- Discrimination Activities:** Any student involved in discrimination activities towards students or staff will face disciplinary action.
- Disruptive Behavior:** Behaviors or actions that disrupt the College's processes (academic and/or non-academic) are in violation of College rules. No student shall behave in a manner that is unacceptable in a learning environment or that endangers or infringes on the rights and/or safety of himself or herself or other students, visitors, staff, patients in a clinical situation, and/or children in childcare centers at Ivy Tech. If misconduct warrants an immediate suspension from the institutional setting for the remainder of the instructional period the instructor may do so without a prior hearing. If the student does not voluntarily leave the institutional setting campus official(s) and/or campus security officers may remove the student from that setting upon oral request by the instructor.
- Electronic Equipment or Programs:** Use of electronic equipment or programs in a manner that is disruptive to other students, staff, or College processes is prohibited. This includes electronic equipment being played loudly. Students introducing computer viruses will be subject to disciplinary action, including dismissal.
- Financial Responsibility:** Students are expected to pay all fees, fines, or loans in a timely manner. Official transcripts and copies of records will not be given to the student and degrees will not be awarded until debts to the College are paid. Students will be allowed to inspect and view transcripts and records. Students will not be allowed to register in an "owe fees" status.
- Fundraising or Solicitation:** College policy requires that individuals or organizations seeking the use of campus facilities or scheduling activities to solicit funds must first obtain written approval from the appropriate College official. College rules and regulations govern fundraising activities, the money collected, and the use of the money collected by the

fundraising activities. Misrepresentation or misuse will result in the student's being responsible for the money owed to an institution or individual, the student's being removed from the club or organization, and the student's facing disciplinary action. The student is also accountable to state and federal laws and regulations.

11. **Furnishing False Information With Intent to Deceive:** Providing false information is against College rules and state laws.
12. **Harassment/Sexual Harassment/Stalking and/or Intimidation:** This is defined as conduct causing alarm or creating a risk by threatening to commit crimes against persons or their property or making unwelcome sexual advances or requests for sexual favors. This also covers harassment or intimidation of persons involved in a disciplinary hearing and of persons in authority who are in the process of discharging their responsibilities. Harassment, stalking, and/or intimidation are not permitted. Perpetrators are also subject to Indiana state law. Please see the policy regarding harassment at the end of this section.
13. **Hazing:** Hazing, an initiation process usually into a club or organization which often involves humiliating or otherwise harmful tasks, performances, or behaviors is not permitted.
14. **Inappropriate Use of College Computer Resources:** Theft or other abuse of computer time is against College rules, which include but are not limited to:
 - a) unauthorized entry into a file, to use, read, or change the contents of or for another purpose.
 - b) unauthorized transfer of a file, unauthorized use of another user's identification and password or use of computing facilities to interfere with the work of another student, faculty member or college official.
 - c) use of computing facilities to send, receive, or view obscene or abusive messages.
 - d) use of computing facilities to interfere with normal operation of the College computing system.
 - e) use of computing facilities for students' personal benefit.
 - f) use of College-owned computer resources to prepare or print work for commercial purposes.
 - g) Inappropriate use of printers:
 1. Printers are intended for class-related activities. Printing Internet web pages or other information not directly related to an authorized use is prohibited.
 2. Excessive printing is prohibited. Students must follow lab guidelines limiting the number of copies or pages that may be printed.
 3. Using non-approved paper in a college-owned printer is prohibited.
15. **Motor Vehicles:** Students are expected to comply with parking regulations. Parking spaces for persons with disabilities and visitors' areas are reserved for those purposes, and vehicles improperly parked in those areas may be ticketed or towed at the owner's expense.
16. **Safety:** No student shall engage in behavior that violates the safety rules of any institutional setting or other College premises, and/or College sponsored events whether such procedures are written or oral rules or directions. This shall include, but not be limited to, the wearing of any required personal protective equipment and the prescribed methods and

procedures for handling and disposing of certain materials that may be hazardous, unstable, infectious, etc.

17. **Signs or Surveys:** Students may erect signs, conduct surveys, or display signs or posters on designated bulletin boards.
18. **Use of College Name:** The College name and logo are registered trademarks. The use of the College name or logo must be authorized by the officials in charge of College trademarks. Use without authorization is against College rules.
19. **Use of College Facilities:** Students are permitted on campus during normal published Ivy Tech hours and at other times established in the College calendar. Students wishing to utilize College facilities at other times must request permission from the appropriate College official. Unauthorized possession, duplication, or use of keys or electronic locking devices to any College premise, or unauthorized entry to or use of College premises is against College rules.
20. **Compliance with Indiana State Laws:** Violation of these laws is also against College rules and violators may also be prosecuted according to Indiana law.
 - **Alcoholic beverages:** Consuming, being under the influence of or possessing intoxicating beverages on College property is not permitted.
 - **Arms/deadly weapons/explosives/chemicals:** Possession of firearms (except those possessed by police or campus security officers) and other weapons, dangerous chemicals, or any explosive or explosive device is prohibited on College property or at any College sponsored activity held elsewhere. No student shall use or threaten to use firearms, other weapons, dangerous chemicals, or any explosive or explosive device on College property or at any College-sponsored activity held elsewhere. A harmless instrument designed to look like a firearm, explosive, or weapon that is used by a person to cause fear in or assault of another person is included within the meaning of a firearm, explosive or weapon.
 - **Assault and battery, abusive actions, physical and/or verbal altercations and/or threatening language:** Assault and battery, abusive actions, physical and/or verbal altercations, and/or threatening language are prohibited under College rules. Perpetrators are also subject to Indiana State law. No student shall threaten or commit a physical or sexual attack on faculty, staff or another student. No student shall force or threaten to force another student, faculty or staff member to have sexual contact against that person's will. Any student charged with an assault on Ivy Tech property or at any College sponsored activity is subject to prosecution and will be disciplined under the campus code of student conduct.
 - **Counterfeiting and altering:** Copying or altering in any manner any record, document, or identification form used or maintained by the College is not permitted.
 - **Dumping and littering:** No student shall deposit, dump, litter or otherwise dispose of any refuse on college property except in duly designated refuse depositories.
 - **Gambling:** Gambling is not allowed except where permitted by state law or within a sanctioned program or class.
 - **Illegal use of drugs:** Being under the influence of, use of, possession of, or distributing illegal drugs is not permitted.

- **Smoking:** All Ivy Tech buildings are classified as “non-smoking” facilities. Smoking is permitted only in designated areas.
- **Theft of property:** Theft of personal property, College property, or property located on College property is a violation of College rules.
- **Vandalism:** The destruction or mutilation of Ivy Tech books, magazines, equipment, resources or buildings is a violation of College rules.

REPEATED OFFENSES OF A LESS SERIOUS NATURE

Repeated offenses of a less serious nature are considered disruptive and will be handled under the College’s disciplinary process.

Policy and Complaint Procedure Against Harassment

The College will not tolerate harassment based on gender (with or without sexual conduct), sexual orientation, race, color, religion, national origin, age, disability, and/or opposition to prohibited discrimination or participation in this or any other complaint procedure. This prohibition covers harassment against any student at an Ivy Tech campus by anyone, including other students, employees or non-employees during any College activity or program. The policy prohibiting harassment includes adverse treatment of students because they report harassment or provide information related to such complaints.

Sexual harassment is simply one form of harassment covered by this policy. Sexual harassment encompasses unwelcome sexual advances, requests for sexual favors, and other verbal or physical conduct of a sexual nature where:

Submission to the conduct is an explicit or implicit term of student status (which includes academic and non-academic decisions).

Submission or rejection of the conduct is the basis for any decision affecting that individual’s student status; or such conduct has the purpose or effect of unreasonably interfering with an individual’s academic performance or creates an intimidating, hostile or offensive academic environment.

Sexual harassment would include, but not be limited to, actions such as:

- (1) sex-oriented oral or written “kidding” or abuse,
- (2) photographs, drawings or graffiti of a sexual nature,
- (3) subtle pressure for sexual activity,
- (4) physical conduct such as patting, pinching, or constant brushing against another’s body, and
- (5) explicit demands for sexual favors, whether or not accompanied by implied or overt promises of preferential treatment or threats concerning an individual’s student status.

REPORTING AND COMPLAINT PROCEDURE

Students are encouraged to report harassment before it becomes severe or pervasive. A student who thinks that he or she has been a victim of harassment and who desires to file a complaint to that effect should report a complaint as follows:

If the complaint is regarding harassment by another student it may be filed with or reported to the Vice Chancellor for Student Affairs or an academic chairperson with the expectation that the harassing behavior will be a violation of the College’s Code of Student Conduct, either on its own terms or as a violation of another College policy.

If the complaint is regarding harassment by a College employee or non-employee it may be filed with or reported to the Vice Chancellor for Student Affairs, any of the employee’s supervisors, or with the Director of Human Resources or anyone else in a managerial role. All supervisors and members of management to whom a complaint of harassment is brought or who independently observe behavior prohibited by the harassment policy are to report the complaint of harassment or information about harassment promptly to the highest ranking official at the respective facility who is not the alleged harasser, to the Vice Chancellor for Student Affairs or to the Director of Human Resources.

INVESTIGATION

Students filing complaints of harassment are assured that information about the allegation of harassment will be shared only with those who need to know about it. Records relating to harassment complaints will be kept confidential on the same basis. Complete confidentiality cannot be guaranteed since conducting an effective investigation would not be possible without revealing certain information to the alleged harasser and potential witnesses. Under no circumstances will the individual who conducts the investigation or who has any direct or indirect control over the investigation be subject to the supervisory authority of the alleged harasser.

DETERMINATION

After all of the evidence is in, interviews are final, and any credibility issues are resolved, a determination as to whether harassment occurred will be made and the parties informed of the determination. If no determination can be made because the evidence is inconclusive the parties will be informed of this result.

CORRECTIVE ACTION

After the determination is made the College will undertake prompt and appropriate corrective action including discipline up to and including termination of employment of an employee harasser or dismissal of a student harasser, whenever it determines that harassment has occurred in violation of this policy. Such corrective action will be reported to the student making the complaint.

VIOLATIONS

The College strives to provide an educational and professional environment that allows individuals to engage in their daily activities in a safe, healthy and secure manner. Local, state or federal law enforcement officials will be notified of anyone violating local, state or federal laws. Violators shall be subject to prosecution by the appropriate law enforcement officials. Anyone found in violation of College regulations shall be subject to disciplinary action by the College through due process procedures for student conduct violations. The regulations and procedures will be placed for reading and review in the library. Copies will also be available through the Office of Admissions or Student Affairs.

DISCIPLINARY ACTION

Cases of student misconduct and/or lack of academic integrity are to be referred to the chief aca-

democratic officer or chief student affairs officer. A student who violates the rules and regulations of the College may be subject to disciplinary actions, which may include, but not be limited to, the following:

1. Verbal reprimand;
2. Restitution for damages;
3. Restriction of privileges such as access to lab facilities, library facilities, testing center, etc.;
4. Failure of the exam, quiz, project, etc.
5. Failure of the assignment or course;
6. Withdrawal from a course, program or the College for the remainder of the semester or term;
7. Suspension from the College (one calendar year);
8. Dismissal from the College (five years; student may appeal for reinstatement).

In addition, the College representative will be responsible to review all initial disciplinary procedures and may suspend a student for a period of time until the Student Status Committee can meet.

Students are provided an opportunity to appeal any disciplinary decision and are required to sign a waiver if they choose to waive the right to appeal. The basic process in discipline cases is as follows: notice of charges, notice of possible penalty, and opportunity to explain a defense to some authority.

1. An appropriate College official shall notify the student that he or she is accused of violating a regulation.
2. The student shall be notified in writing that he or she may elect one of three courses of action:
 - A. The student may admit the alleged violation and agree with the recommended disciplinary action. A signed waiver which waives the right to appeal is required.
 - B. The student may admit the alleged violation and request a hearing before the Student Status Committee.
 - C. The student may deny the alleged violation, in which case the administrative officer shall refer him/her to the Student Status Committee.

The Student Status Committee hears all appeals relating to disciplinary actions.

STUDENT GRIEVANCE POLICY

The student grievance process provides the College an appropriate mechanism to deal with violations of student rules of conduct and conversely allows a student with a disagreement to grieve against a College employee's decision affecting that student. The College encourages students to resolve their complaints informally. The informal grievance procedures are designed to accomplish a quick resolution that is most expeditious and effective.

Whenever the informal process does not result in a satisfactory resolution, the College formal grievance procedure is also available.

INFORMAL GRIEVANCE PROCEDURE

The student shall initiate the informal process with the student working one-on-one with appro-

appropriate faculty or staff and must be started within 30 calendar days of the incident. Students must bring to the attention of their instructor (in cases involving academic coursework) or relevant supervisory staff member legitimate complaints perceived by them. The student should first bring the complaint to the attention of his/her instructor or the person with whom the student has a complaint. A conference with the student will be scheduled as soon as possible and within five working days (Monday - Friday) of notice of the student complaint, at the latest. The intent of these conferences is to ensure an early discussion of the issue, that the issue has been raised in a timely fashion and that if possible a mutually acceptable resolution can be reached.

A student who feels that the conference would be futile because of that person's involvement or the situation/concern cannot be resolved with the instructor or staff with whom the student has the complaint, he or she should bring the grievance in writing to the supervisor of that area or department. The conference will be held as soon as possible and at least within five working days of notice of the complaint. Such conferences are to be conducted in proper sequence of supervisors. If the grievance is not resolved with an instructor the student may elect to request a conference with a department head, division chair or the chief academic officer, as deemed appropriate. Non-instructional areas follow the same step process. Through Student Affairs, for example, the process would be advisors/counselors, then manager, and finally the chief student affairs officer. Grievances may cover matters such as the application of College policies and practices to the grievant but the existence or content of the policies may not be grieved.

FORMAL GRIEVANCE PROCEDURE

If a student is not satisfied with the results of the informal process the student may proceed with the formal grievance as described below.

FORMAT OF THE WRITTEN GRIEVANCE

If the complaint is not resolved to the student's satisfaction through the informal procedure the student shall put the grievance to writing. The formal complaint must:

1. Clearly state the facts giving rise to the grievance.
2. Describe the efforts to informally resolve the complaint.
3. State the remedy sought by the grievant.
4. Be signed and dated.

TIMELY FILING OF A FORMAL GRIEVANCE

Students must file complaints within a reasonable period of time, not to exceed 30 calendar days, after the informal grievance process has been exhausted. Students must file a grievance within 30 days of the end of the term in which the incident occurred

FILING THE FORMAL GRIEVANCE

Original copies of the formal written grievance document shall be filed with both the regional office of Student Affairs and the College's Vice Provost for Student Affairs (50 W. Fall Creek Parkway N. Dr., Indianapolis, Indiana 46208). The Vice Provost shall assign a College Grievance Coordinator who shall coordinate the handling of the grievance within the region.

MEDIATION

Reasonable efforts should be made by the Grievance Coordinator to mediate a mutually agreeable resolution of the matter with the parties. A signed document should be generated by the

Grievance Coordinator stating the results of the mediation.

STUDENT STATUS COMMITTEE

The Student Status Committee is a committee whose purpose is to review all formal grievances referred to it and recommend a resolution to the chief administrative officer. It will be composed of six members, including two full-time instructional staff members and two administrative staff persons appointed by the chief administrative officer of the region. The additional two members will be students designated by the Student Government Association or the chief student affairs officer. The Committee's review of a formal appeal will begin no later than 30 days after fact-finding and mediation terminates. The Grievance Coordinator shall keep the grievance body informed of efforts related to fact-finding and mediation. Office of the Provost support, as needed, will be available to the Grievance Coordinator.

Disposition of Formal Grievance by the Student Status Committee

If mediation does not resolve the grievance the Student Status Committee shall, in all cases, conduct a hearing. Unless there is a mutual resolution of the grievance the grievance shall not be dismissed prior to the hearing. Written notice of the procedures, actions and meetings at all stages of the formal complaint procedure, including the role of advisors to each party, will be provided to both the student (grievant) and respondent.

The Student Status Committee will ensure the student due process. The student has the following rights:

1. Reasonable advance written notification of the time and place of the hearing;
2. Notification in writing of the charges with sufficient particularity to enable the student to repair a defense;
3. Notification in writing of the names of the witness(es) directly responsible for reporting the alleged violation or, if there are no such witness(es), written notification of how the alleged violation was reported;
4. Notice of actions and meetings at all stages of this appeal procedure;
5. An opportunity to be heard;
6. An opportunity to question witnesses at hearings;
7. An opportunity to have a representative present when presenting facts, being questioned, or asking questions;
8. An expeditious hearing of the case;
9. An explanation of the decision rendered in the case.

The student shall not be required to testify against him or herself.

Once the formal grievance has been initiated and attempts by the Grievance Coordinator to mediate a settlement have been exhausted a hearing shall be held pursuant to the hearing guidelines entitled "Student Grievance Hearing Procedural Guidelines." These guidelines, which are occasionally updated, describe how the actual hearing will be conducted. The Grievance Coordinator will

provide a copy to both the student (grievant) and respondent at the beginning of the formal process. Persons who desire to view the guidelines should contact the chief student affairs officer for a copy.

The Student Status Committee will issue a recommendation(s) to the chief administrative officer following its deliberation. Recommendations of the Student Status Committee if approved by the chief administrative officer are final, unless appealed to the Office of the President (see Appeal to the Office of the President). The student will be informed in writing of the chief administrative officer's decision. A copy of the letter with the chief administrative officer's decision will be filed in the student's permanent record.

APPEAL TO THE OFFICE OF THE PRESIDENT

If the student does not accept the decision of the Student Status Committee the student may appeal, in writing, within 30 calendar days from the written notification by sending a written notice to the General Counsel, Collegewide Appeals Grievance Body, at 50 W. Fall Creek Parkway N. Dr., Indianapolis, IN 46208.

An appeal of the decision of the Student Status Committee to the Collegewide Appeals Grievance Body is limited to procedural errors. The Collegewide Appeals Grievance Body does not review or re-hear the merits of the original grievance. The Collegewide Appeals Grievance Body can recommend to the President that the decision should stand or to remand it back to the campus chief administrative officer for reconsideration. The decision of the President is final.

REINSTATEMENT TO THE COLLEGE

If a student is dismissed from any campus/region of Ivy Tech, that individual is dismissed from the College. The year starts at the time/date of official notification to the student by the Chancellor/Executive Dean. After one calendar year the individual under suspension may apply for reinstatement. If the student is dismissed the student may appeal for reinstatement after five years. The individual must begin the reinstatement appeal process by informing the Vice Chancellor for Student Affairs at the campus where the dismissal took place of his/her intentions. The appeal for reinstatement may be applied for at any campus/region of Ivy Tech where the individual hopes to attend. The appeal will be reviewed by the Vice Chancellor for Academic Affairs and the Vice Chancellor for Student Affairs. If there is reinstatement that is agreed to by the student, no further action is necessary. If the student is not satisfied with the reinstatement decision, the formal due process procedure is implemented. The campus/region Student Status Committee will act on the appeal within 30 days of its receipt. The recommendation of the Student Status Committee will be forwarded to the Chancellor/Executive Dean of the campus/region. That individual will render a judgment on the appeal. That judgment will be final.

STUDENT APPEAL OF A GRADE

When a student believes the final grade he or she received in a course is inaccurate, he or she should make an appointment with the instructor who issued the grade or status and explain the reasons for this belief. This process must be initiated within 30 calendar days of receiving the grade. The instructor and the student should make every effort to resolve the issue. It is expected that most if not all misunderstandings will be resolved at this level.

If the grade or status issue is not resolved the student can appeal in writing to the instructor's supervisor. This individual may be the department chairperson or program chairperson. Once the student has appealed the grade or status with the chairperson, if the issue is not resolved to the

student's satisfaction the student may appeal to the department chairperson, next higher chairperson, or whomever is next in line.

The student's next recourse is to appeal to the regional chief academic officer. The student must notify the dean of academic affairs in writing of his or her intent to appeal the grade. An appeals committee will be formed by the academic dean, consisting of a faculty member from the program or from the division in which the program is housed, a faculty member from another division, the regional student affairs dean or designee, the regional academic affairs dean, and an optional fifth regional person, possibly staff. The appeals committee's decision will be forwarded to the student. Students not satisfied with the committee's decision may make a final appeal to the regional chancellor.

STUDENT RIGHT TO KNOW

The 1990 federal Student Right to Know Act requires colleges and universities to report to prospective and current students the persistence and graduation rates of full-time technical certificate and degree-seeking students. The graduation rate is based upon program completion within 150 percent of time usually required for a full-time student. For technical certificate students, this is the number of full-time students graduating in three semesters. For associate degree students, this is the number of students graduating in six semesters. Contact the Office of Student Affairs for further information.

Campus Security Information

JEANNE CLERY ACT (CAMPUS CRIME STATISTICS) INFORMATION

The Crime Awareness and Campus Security Act of 1990 (also known as the Jeanne Clery Act) requires colleges and universities to disclose an annual report highlighting crime statistics for the previous three years, safety awareness programming, student conduct information, and other information on campus crime and incidents. Ivy Tech Community College of Indiana is committed to provide safe and secure environment for the campus community. Please contact the Office of Student Affairs for a copy of the annual report.

CAMPUS SEX CRIME PREVENTION ACT

The federal Campus Sex Crimes Prevention Act requires state procedures to ensure that offender registration information is made available in a timely manner to law enforcement agencies with jurisdiction where institutions of higher education are located, and that it is entered into appropriate state records and data systems. Law enforcement agency information provided by the State concerning registered sex offenders may be found at the Indiana Criminal Justice Institute website located at <http://www.in.gov/cji/> or the Indiana Sheriff's Association website located at www.indianasheriffs.org/default.asp.

Instructional Programs

The College's degree programs are offered in eight schools:

- School of Applied Science and Engineering Technology
- School of Business
- School of Education
- School of Fine Arts and Design
- School of Health Sciences
- School of Liberal Arts and Sciences
- School of Public and Social Services
- School of Technology

The College offers the following degrees and certificates:

ASSOCIATE OF ARTS (AA) DEGREE PROGRAMS

The associate of arts degree program prepares students for transfer to four-year institutions. General education and liberal arts courses make up all or almost all of the curriculum, and students are required to take a minimum of eight credit hours in a foreign language. Concentrations are available in six areas. The coursework provides students with a foundation for transfer to a related baccalaureate program at a four-year institution.

Students interested in the Associate of Arts program should contact their local Ivy Tech campus and institution to which they want to transfer for further information.

ASSOCIATE OF SCIENCE (AS) DEGREE PROGRAMS

The College offers two types of AS programs: AS programs in technical and professional areas and AS programs in the liberal arts.

AS degree programs in technical and professional areas prepare students for transfer to cooperating four-year institutions and for careers. Technical/professional AS programs typically contain 40 percent or more general education, with the balance in technical and profession courses. The coursework provides students with a foundation for transfer to a related baccalaureate program at a four-year institution, and equips students with skills for the job market. AS curricula in technical/professional areas are tailored to meet specific institutional transfer objectives.

The AS degree program in the liberal arts prepares students for transfer to four-year institutions. General education and liberal arts courses make up all or almost all of the curriculum.

Concentrations are available in four areas. The coursework provides students with a foundation for transfer to a related baccalaureate program at a four-year institution.

Students interested in Associate of Science programs should contact their local Ivy Tech campus and institution to which they want to transfer for further information.

ASSOCIATE OF APPLIED SCIENCE (AAS) DEGREE PROGRAMS

Associate of applied science degree programs are two-year programs that prepare students for careers, career changes and career advancement. AAS programs may also prepare students for transfer to four-year institutions. These programs offer education in recognized technical areas and specialties with emphasis on analysis, synthesis and evaluation. The program content, which is approximately 30 percent general education, provides depth and breadth in conceptual and professional/technical skills. The general education courses equip students with the problem

solving, communications, scientific and mathematical skills to compete successfully in the job market. Professional/technical courses equip students with the skills to obtain employment and to advance in the workforce.

ASSOCIATE OF FINE ARTS (AFA) DEGREE PROGRAMS

The associate of fine arts degree program prepares students for transfer to cooperating four-year institutions and for becoming professionals in the field of art. General education coursework makes up approximately 40 percent of the curriculum, including six hours of art history. The balance of the curriculum includes arts foundation, studio art, graphic and design work, and elective coursework. The coursework provides students with a foundation for transfer to a related baccalaureate arts program at a four-year institution. Students interested in the Associate of Fine Art degree should contact their local Ivy Tech campus for availability of programs and for further information.

TECHNICAL CERTIFICATE (TC) PROGRAMS

Technical Certificate programs provide education in conceptual and technical skills for specific occupations. Each program contains a sequence of required courses in a recognized concentration within one of the programs at the College. The program content is designed to develop competency in the comprehension of general and technical skills. Certificate programs require mastery of basic reading, writing, mathematical and algebraic skills.

CERTIFICATE PROGRAMS

Certificates are sequences of technical and professional courses. They provide access to targeted, short-term workforce training, and completers may sit for specific certification exams. Courses in certificate programs also apply toward technical certificates and associate degree programs in the subject area. Certificates have between 16 and 27 credit hours, with a consistent statewide curriculum, and are currently offered in business and technology fields.

DISTANCE LEARNING

Distance Education

At Ivy Tech, you can complete several degree programs online. Our online programs and courses make it even easier for you to take classes that fit your schedule, while still enjoying interaction with your classmates and learning from the same qualified instructors who teach class on campus. For more information about the College's online offerings, visit www.ivytech.edu/distance.

In addition, the Indiana Partnership for Statewide Education (IPSE) is a collaboration of Indiana's colleges and universities committed to delivering higher education courses via distance education to learners all over Indiana. Most IPSE courses are online, though some are delivered via two-way video or some other medium. Most courses offered through IPSE are transferable among all seven of Indiana's public colleges and universities as well as several of the private institutions.

Contact your local campus for availability of courses or visit the Indiana College Network website at www.icn.org.

Apprenticeship Programs

Ivy Tech is a partner with Industrial and Building Trades Apprenticeship programs in Indiana to provide certificates and associate degree programs to Indiana companies and employees. The College and the local joint apprenticeship training committees (JATC) come together and offer

educational programs. Individuals who have been selected by the JATC become Ivy Tech students and have an opportunity to earn college credit while advancing through a registered apprenticeship program. Because Ivy Tech has adopted the national standards of the Industrial and Building Trades apprenticeship programs, the apprentice has an opportunity to earn a Technical Certificate (TC), Associate of Applied Science (AAS), or Associate of Science (AS) degree. Students should contact the Apprenticeship Manager at the local Ivy Tech campus for more information.

Those apprentices or journeypersons who wish to explore transfer opportunities after earning an AAS or AS degree can contact Indiana State University, Indiana University-Labor Studies, the National Labor College, or Sullivan University. Interested apprentices and journeypersons should consult the current catalog of the institution in which they are interested, and should review their options with an academic advisor. Additional course and transfer prospects may be available.

Senior Scholars

In the spring of 2001, Ivy Tech launched the Senior Scholars program. Indiana citizens 60 years of age and older can take credit courses at Ivy Tech tuition-free. Students are responsible for books and any associated fees. In order to qualify for this program a person must meet the following requirements:

- Be an Indiana resident;
- Be 60 years of age or older at the start of a semester;
- Possess a high school diploma or GED;
- Be retired from their primary vocation (does not apply to homemakers); and
- Not be employed on a full-time basis.

Non-credit courses are not included in the Senior Scholars program. Please contact the Office of Admissions for further information.

College for Working Adults

When you're balancing a job, family and other commitments, a college degree might seem out of reach. As a working adult, you need a solution that fits your schedule, your career goals, and your budget. What you need is more than just a college – you need a college designed especially for you. Ivy Tech's College for Working Adults combines innovations in scheduling and instruction to ensure that you earn your associate degree in just two years while you continue to work. The program offers: a defined program plan, 8-week sessions, two classes per session, a set schedule, career-relevant courses, and the support you need along the way. Visit www.ivytech.edu for more information.

IVY TECH COMMUNITY COLLEGE GENERAL EDUCATION

COURSES BY CATEGORY

COMMUNICATION

COMM 101 Fundamentals of Public Speaking
COMM 102 Intro to Interpersonal Communication

ENGL 111 English Composition
ENGL 112 Exposition and Persuasion
ENGL 211 Technical Writing

MATHEMATICS

MATH 111 Intermediate Algebra (TC, AAS only)
MATH 115 Statistics
MATH 117 The Art of Geometry
MATH 118 Concepts in Mathematics
MATH 121 Geometry-Trigonometry
MATH 128 Mathematics for Elementary Education II
MATH 131 Algebra/Trigonometry I
MATH 132 Algebra/Trigonometry II

MATH 133 College Algebra with Analytic Geometry
MATH 134 Trigonometry
MATH 135 Finite Math
MATH 136 College Algebra
MATH 137 Trig with Analytic Geometry
MATH 201 Brief Calculus I
MATH 202 Brief Calculus II
MATH 211 Calculus I
MATH 212 Calculus II

LIFE/PHYSICAL SCIENCES

APHY 101 Anatomy & Physiology I
APHY 102 Anatomy & Physiology II
APHY 201 Advanced Human Physiology
APHY 203 Human Anatomy & Physiology I
APHY 204 Human Anatomy & Physiology II
ASTR 101 Solar System Astronomy
BIOL 100 Human Biology
BIOL 101 Introductory Biology
BIOL 105 Biology I
BIOL 107 Biology II
BIOL 121 General Biology
BIOL 201 General Microbiology
BIOL 211 General Microbiology I
BIOL 220 Environmental Science
Energy

CHEM 101 Introductory Chemistry I
CHEM 102 Introductory Chemistry II
CHEM 105 General Chemistry I
CHEM 106 General Chemistry II
CHEM 111 Chemistry I
CHEM 112 Chemistry II
CHEM 113 Intro to Organic & Biochemistry
CHEM 211 Organic Chemistry I
CHEM 212 Organic Chemistry II
PHYS 100 Technical Physics (TC, AAS only)
PHYS 101 Physics I
PHYS 102 Physics II
SCIN 100 Earth Science
SCIN 101 Science of Traditional and Alternative
SCIN 111 Physical Science

SOCIAL/BEHAVIORAL SCIENCES

ANTH 154 Cultural Anthropology
ECON 101 Economics Fundamentals
ECON 201 Principles of Macroeconomics
ECON 202 Principles of Microeconomics
GEOG 207 World Geography
POLS 101 Intro to American Government and Politics
POLS 112 State & Local Government
POLS 201 Intro to Political Science
POLS 211 Introduction to World Politics
PSYC 101 Introduction to Psychology
PSYC 102 Advanced Introduction to Psychology

PSYC 201 Lifespan Development
PSYC 205 Abnormal Psychology
PSYC 211 Research Methods in Psychology
PSYC 240 Human Sexuality
PSYC 260 Health Psychology
SOC 111 Introduction to Sociology
SOC 164 Intro to Multicultural Studies
SOC 245 Cultural Diversity
SOC 252 Social Problems
SOC 253 Introduction to Social Psychology
SOC 261 Sociology of Relationships & Families

HUMANITIES

ARTH 101 Survey of Art and Culture I
ARTH 102 Survey of Art and Culture II
ARTH 110 Art Appreciation
ENGL 202 Creative Writing
ENGL 206 Intro to Literature
ENGL 220 Intro to World Literature I
ENGL 221 Intro to World Literature II
ENGL 222 American Literature I
ENGL 223 American Literature II
ENGL 227 Intro to World Fiction
FREN 101 French I
FREN 102 French II
HIST 101 Survey of American History I

HIST 102 Survey of American History II
HIST 235 World Civilization I
HIST 236 World Civilization II
HUMA 100 Theatre Appreciation
HUMA 118 Music Appreciation
HUMA 201 Intro to Humanities I
HUMA 202 Intro to Humanities II
PHIL 101 Introduction to Philosophy
PHIL 102 Introduction to Ethics
PHIL 220 Philosophy of Religion
SPAN 101 Spanish Level I
SPAN 102 Spanish Level II

LIFE SKILLS

IVYT 101 First Year Seminar
IVYT 102 Information Studies and Research Skills
IVYT 103 Health and Wellness
IVYT 104 Critical Thinking
IVYT 105 Managing Personal Finances

IVYT 106 Career Exploration
IVYT 107 Professional Presence
IVYT 108 Academic Project and Portfolio Management
IVYT 109 Online Learning Technologies
IVYT 110 Transfer Success







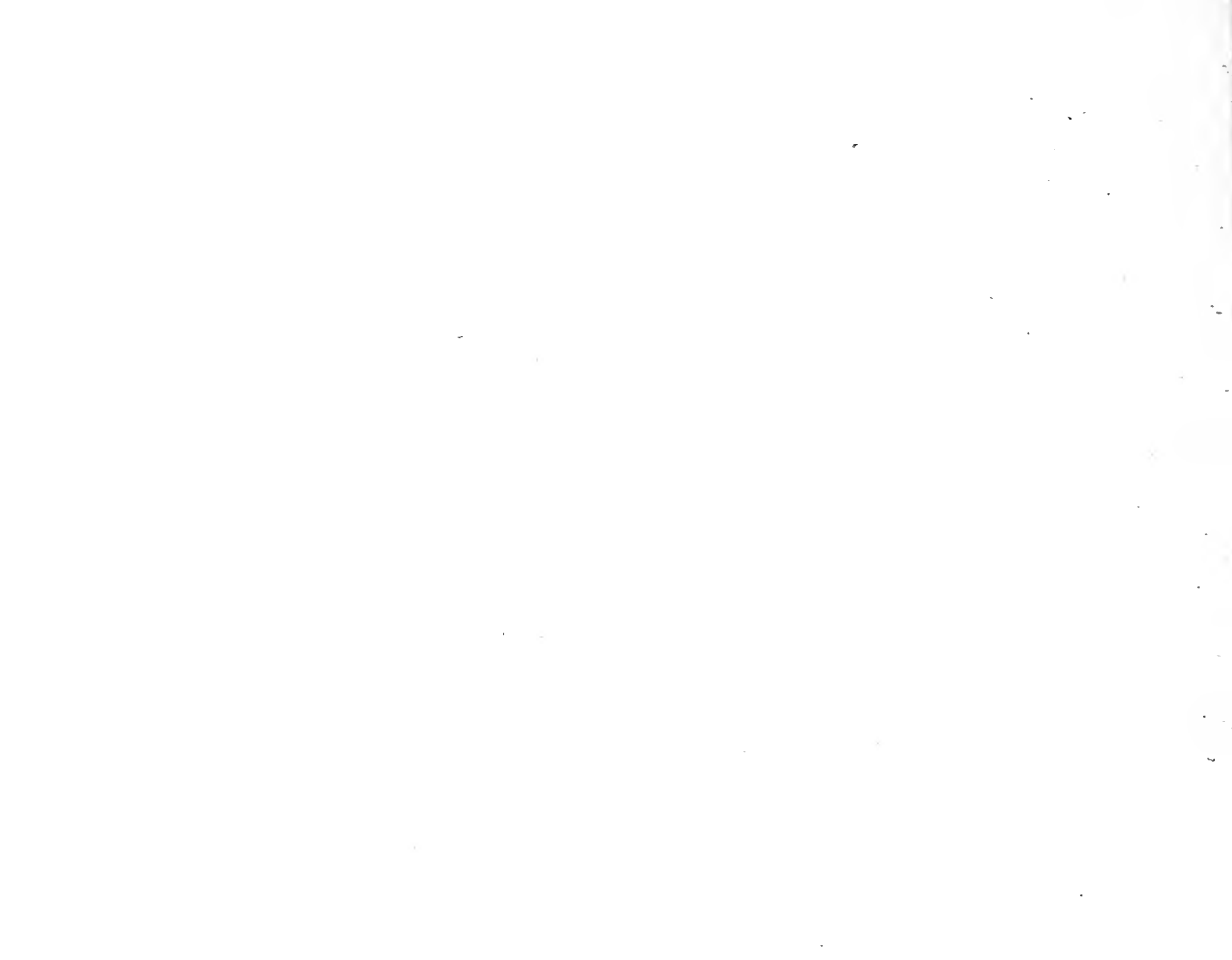



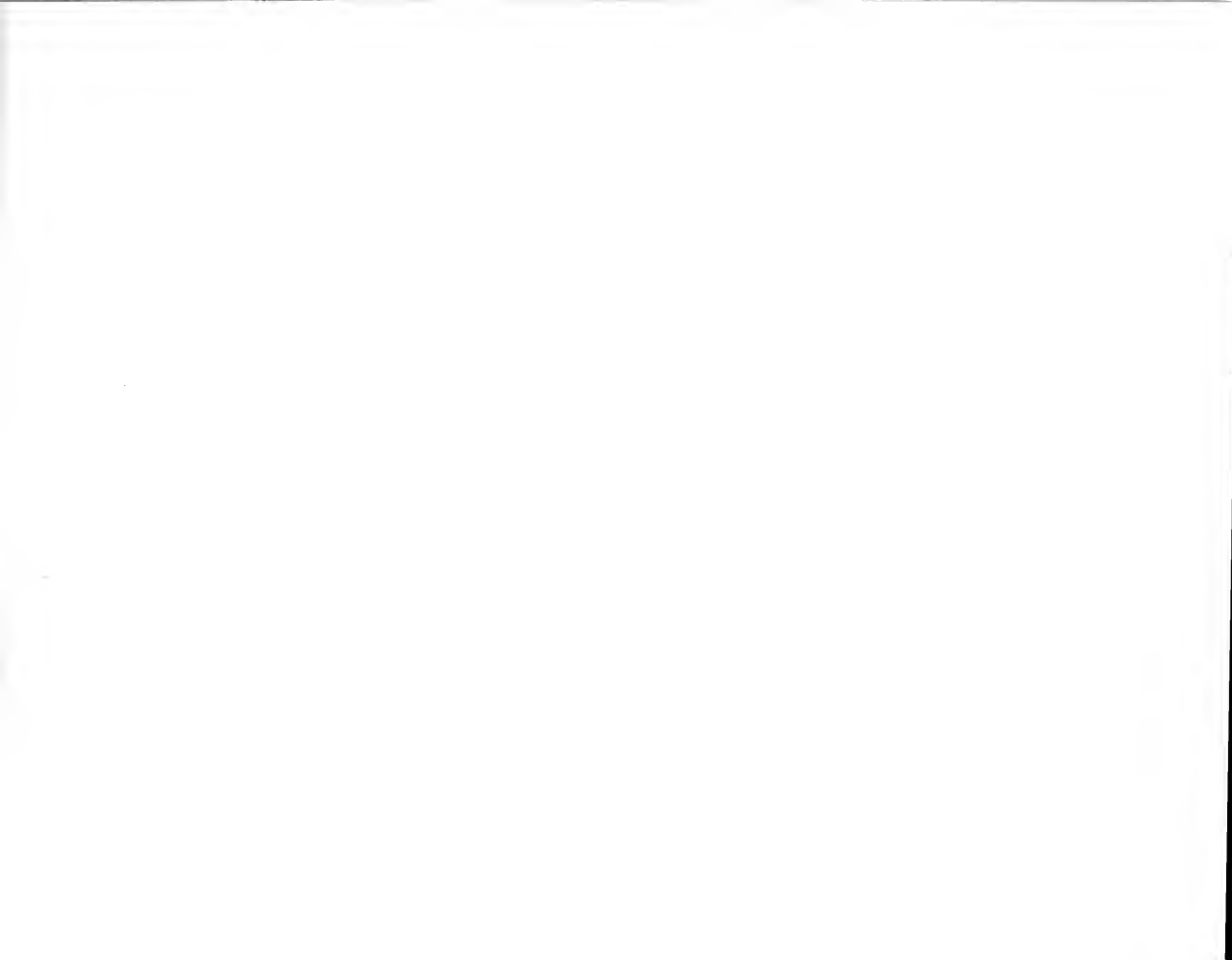



IVY TECH
COMMUNITY COLLEGE